

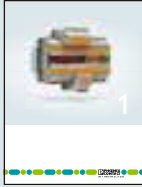

4

Surge protection, power supplies, and device circuit breakers

2019/2020



Terminal blocks

- Terminal blocks

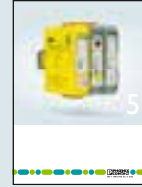

Interface technology and switching devices

- Electronic switching devices and motor control
- Measurement and control technology
- Monitoring
- Relay modules
- System cabling for controllers



Sensor/actuator cabling and connectors

- Sensor/actuator cabling
- Cables and lines
- Connectors

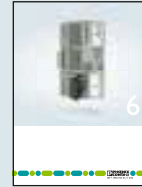

Automation

- PLCnext Technology
- Industrial cloud computing
- Software
- PLCs and I/O systems
- Functional safety
- Industrial communication technology
- HMIs and industrial PCs
- Lighting and signaling



Marking systems, tools, and mounting material

- Marking and labeling
- Tools
- Installation and mounting material

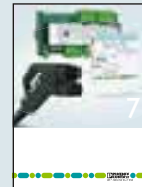

Charging technology for electromobility

- Charging technology for electromobility



Surge protection, power supplies, and device circuit breakers

- Surge protection and interference suppression filters
- Power supplies and UPS
- Protective devices



PCB terminal blocks and PCB connectors

Use our E-paper for quick product selection.

i Web code: #1517

Find out more with the web code

For detailed information, use the web codes provided in this brochure. Simply enter # and the four-digit number in the search field on our website.

i Web code: #1234 (example)

Or use the direct link:

phoenixcontact.net/webcode/#1234

You will find the latest information including all the new products directly in the product area of our website:

phoenixcontact.net/products

You can also use the Phoenix Contact catalog app interactively on your tablet.



Table of contents

Illustrated product range overview

4

Access the right product more quickly from here

COMPLETE line

6

The comprehensive solution for the control cabinet

Surge protection and interference suppression filters

8



Power supplies and UPS

224



Device circuit breakers

358



Technical information

402

Index

418

Illustrated product range overview

Access the right product more quickly from here

Surge protection for the power supply



Type 1+2 combined lightning current and surge arrester
FLASHTRAB SEC HYBRID ... Page 34
FLASHTRAB SEC PLUS ... Page 35



Type 1+2 combined lightning current and surge arrester
FLASHTRAB SEC T1+T2... Page 42
FLASHTRAB SEC ZP ... Page 45



Type 1+2 combined lightning current and surge arrester
VALVETRAB MS Page 46
VALVETRAB MB Page 51
POWERTRAB Page 52



Type 2 surge protective device
VALVETRAB SEC Page 54
VALVETRAB MS Page 60



Type 2 surge protective devices for PCB mounting
PRINTRAB Page 78



Type 3 device protection
PLUGTRAB SEC / PT Page 82
BLOCKTRAB Page 87
MAINTRAB Page 88



Surge protection for NEMA systems
VALVETRAB US Page 90



Isolating spark gap
FLASHTRAB ISG Page 102

Surge protection for measurement and control technology



DIN rail modules
TERMITRAB complete Page 116
PLUGTRAB Page 120
LINETRAB Page 124



Special systems
LSA-PLUS modules Page 125
Page 126



For networks Page 166
For interfaces Page 168



MAINTRAB Page 88
TERMITRAB complete Page 170
PLUGTRAB PT-Q Page 187

Surge protection for transceiver systems



For mobile phone networks Page 200
For video communication Page 201



For radio and television sets Page 204

EMC solutions



Mains interference filters with integrated surge protection Page 208
Interference suppression filters Page 211

Monitoring of SPDs



ImpulseCheck Page 212

Test devices



CHECKMASTER 2 Page 218

Power supplies



QUINT POWER with NFC Page 234
 QUINT POWER Page 242
 QUINT POWER, with protective coating Page 246
 QUINT POWER < 100 W Page 248



TRIO POWER Page 254
 TRIO CrossPowerSystem Page 262
 TRIO POWER IP67 Page 264



UNO POWER Page 266



MINI POWER Page 276



STEP POWER Page 278



QUINT DC/DC converters with NFC Page 288
 QUINT DC/DC converters Page 292
 QUINT DC/DC converters, with protective coating Page 296
 MINI DC/DC converters Page 298



Redundancy modules

QUINT ORING Page 302
 QUINT S-ORING Page 304
 QUINT DIODE Page 306
 TRIO DIODE Page 308
 UNO DIODE, STEP DIODE Page 309

UPS for the control cabinet



QUINT DC UPS Page 316
 QUINT UPS



QUINT/TRIO AC UPS Page 330
 QUINT UPS Page 332
 TRIO UPS



Energy storage for QUINT UPS Page 334



UPS with integrated energy storage Page 344
 QUINT UPS Page 345
 QUINT BUFFER Page 346
 QUINT CAP Page 348
 STEP UPS, UNO UPS

Device circuit breakers



UPS with integrated power supply Page 350
 MINI UPS Page 352
 TRIO UPS



Electronic circuit breakers Page 372
 CBM, CBMC Page 378
 PTCB Page 382
 CB, ECP, EC-E



Thermomagnetic circuit breakers Page 311
 CB-TM Page 394
 UT 6-TMC Page 395
 TMC



Thermal circuit breakers Page 400
 TCP
 Fuse terminal blocks, see Catalog 1

COMPLETE line

The comprehensive solution for the control cabinet

Easy planning, intuitive installation



COMPLETE line is a system comprising technologically leading and coordinated hardware and software products, consulting services, and system solutions that help you optimize your processes in control cabinet manufacturing. Engineering, purchasing, installation, and operation become significantly easier for you.

Your advantages at a glance:

- Intuitive handling, thanks to the uniform design, look, and function
- Time savings across the entire engineering process, thanks to consistent software support
- Reduced logistics costs with standardized accessories and reduced variety of parts
- Optimized processes in control cabinet manufacturing, thanks to custom services and innovative manufacturing solutions

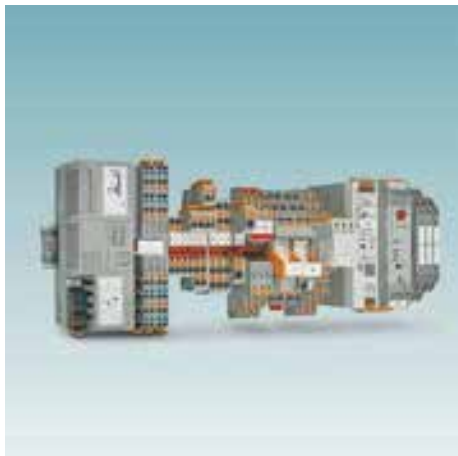

Comprehensive product portfolio

With COMPLETE line, we offer a complete product portfolio of technologically leading products. These include:

- Controllers and I/O modules
- Power supplies and device circuit breakers
- Terminal blocks and distribution blocks
- Relay modules and motor starters
- Signal conditioners
- Safety technology
- Surge protection
- Heavy-duty connectors

Intuitive handling

Thanks to the simple, intuitive handling of the coordinated hardware components you will save time during installation, startup, and maintenance. Push-in connection technology enables you to wire applications quickly – without using tools. The broad, technologically leading product portfolio will always provide you with the right product for standard or special applications.

Time savings across the entire engineering process

The PROJECT complete planning and marking software supports the entire control cabinet manufacturing process. The program features an intuitive user interface and enables the individual planning, automatic checking, and direct ordering of terminal strips.



Reduced logistics costs

Reduced variety of parts, thanks to standardized marking, bridging, and testing accessories. The COMPLETE line system coordinates products, design, and accessories in a way that you benefit from maximum reusability and thus reduce your logistics costs.

Optimized processes in control cabinet manufacturing

From engineering through to manufacturing, COMPLETE line supports you in making your control cabinet production as efficient as possible. Thus creating a customized concept for optimizing your processes in control cabinet manufacturing.

Our terminal strip production helps you to flexibly manage peak order times or to supply your control cabinet production with fully assembled DIN rails just-in-time.

Additional information

Find out more about COMPLETE line and your comprehensive solutions for the control cabinet. Visit our website:

phoenixcontact.com/completeline



Surge protection and interference suppression filters

Damage caused by surge voltages

The number of electrical devices damaged or destroyed by surge voltages is increasing year on year. This can prove expensive in terms of repairs and downtimes. In an industrial environment, the hazards are not just restricted to systems and devices. Building technology applications and even residential buildings may be affected.

Interference voltages

Switching operations triggered mechanically or electronically generate pulse-like and high-frequency interference voltages. These voltages spread in an unimpeded manner across the cable network. All the devices within this cable network are affected. Data errors, uncontrolled functions, and system crashes can result, with electronic and data processing devices at particular risk.

i Your web code: #0142

Basics	10
<hr/>	
Surge protection for the power supply	14
Selection guide	20
Applications	24
Type 1+2 combined lightning current and surge arrester	34
Type 1+2 combined lightning current and surge arrester special	42
Type 2 surge protective device	53
Type 3 device protection	82
Surge protection for NEMA systems	90
Isolating spark gap	102
<hr/>	
Surge protection for measurement and control technology	104
Selection guide	108
Applications	110
Protection for current loops	116
Protection for digital signals	128
Protection for resistance-dependent measurements	143
Single-stage protective devices	148
Protection for Ex applications	152
<hr/>	
Surge protection for information technology and telecommunications	160
Selection guides	162
Applications	164
Protection for data interfaces	166
Protection for fieldbus systems	170
Protection for telecommunications interfaces	186
<hr/>	
Surge protection for transceiver systems	194
Selection guide	196
Applications	198
Protection for antenna systems	200
Protection for TV and radio systems	204
<hr/>	
Interference suppression filters	206
<hr/>	
ImpulseCheck	212
<hr/>	
Lightning current measurement	214
<hr/>	
Test devices	218
<hr/>	
Accessories for surge protection	222

Surge voltage – What is it?



Lightning discharge

It is above all lightning strikes (lightning electromagnetic pulse, LEMP) that have the greatest potential for damage among all the causes of occurrence.

They cause transient overvoltages that can extend across great distances and are often associated with high-amplitude surge currents.

Even the indirect effects of a lightning strike can lead to a surge voltage of several kilovolts and result in a surge current of tens of thousands of amperes. In spite of the very brief duration, such an event can lead to total failure or even the destruction of the entire system.

Switching operations

Switching operations (switching electromagnetic pulse, SEMP) can generate induced surge voltages that spread to supply lines. In the case of large switch-on currents or short circuits, very high currents can flow within a few milliseconds. These short-term current changes can lead to transient overvoltages.

Electrostatic discharge

Electrostatic discharge (ESD) occurs if exposed conductive parts with different electrostatic potential approach each other and result in a charge exchange. A sudden charge exchange leads to a brief surge voltage. This presents a hazard, especially for sensitive electronic components.

Surge voltage – What are the effects?

Regardless of what causes a surge voltage, the consequences are the same:

- Device destruction
- System downtimes
- Total failure of controllers

Device failure or defects caused by surge voltages are more frequent than expected. For non-private systems the consequences of a failure are generally much more serious, such as downtimes or data loss. The failure of a device or a machine that is used in a professional environment often leads to costs that are many times higher than repairing the defective device.

Surge voltage – How can you provide correct protection?

Effective surge protection starts with assessing the potential risk and identifying all the devices within the item to be protected.

The resulting protection concept takes into account all the interfaces of the power supply unit as well as those for data and telecommunications. This is the only way to comprehensively and effectively protect all the end devices, for example, within a data network, production plant or building installation. Combining high-quality protective devices with innovative arrester technology, surge protective devices ensure a high degree of system availability and safety in all areas of electrical engineering.

i Your web code: #1133

The protective circle principle



A clear illustration of the lightning protection zone concept is the protective circle.

An imaginary circle is drawn around the object to be protected. A surge protective device should be installed at all points where cables intersect this circle.

The area within the protective circuit is therefore protected in such a way that conducted surge voltage couplings are prevented.

The protective circle must include all electrical and electronic transmission lines in the following areas:

- Power supply
- Measurement and control technology
- Information technology
- Transceiver systems



Surge protection for power supplies



Surge protection for MCR technology



Surge protection for information technology



Surge protection for transceiver systems



Surge protection for power supplies

Type 1+2 combined lightning current and surge arrester

Type 1+2 surge protective devices must satisfy the most stringent requirements in terms of amplitude and specific energy from surge currents, as they are supposed to protect against the effects of direct lightning strikes. In the typical installation environment of the main distribution, the demand placed on the short-circuit current rating is also often very high. In order to be able to meet these requirements, powerful technology is required, such as spark gap technology.

Type 2 surge protective device

Type 2 surge protective devices are generally installed in sub-distributions or machine control cabinets. These SPDs must be able to discharge induced surge voltages from indirect lightning strikes or switching operations but not handle direct lightning strikes. As such, the energy input is significantly reduced. In any case, induced surge voltages caused by switching operations are often very dynamic. Here, a technology with fast response behavior stands up to the test, e.g., varistor technology.

Type 3 device protection

Type 3 surge protective devices are generally installed immediately upstream of the end device to be protected. Due to differing installation environments, type 3 SPDs are available in a very wide range of designs.

- Devices for DIN rail mounting
- Devices for installation in sockets, cable ducts, and underfloor systems
- Attachment plug for sockets

Combined lightning current and surge arrester or combined lightning current and surge arrester special?

Lightning currents are simulated with surge currents in the 10/350 μ s pulse shape. Switching surge voltages and remote lightning strikes are simulated with surge currents in the 8/20 μ s pulse shape.

As per the requirements of product standard IEC 61643-11, a type 2 SPD must only be able to discharge 8/20 pulses. A type 1 SPD is designed for 8/20 μ s pulses as well as 10/350 μ s pulses. In this sense, every type 1 SPD is also a type 2 SPD. The fact that a type 1 SPD satisfies test classification II is a redundant piece of information and does not constitute an additional qualification. These types of SPDs are often referred to as combined lightning current and surge arresters (type 1+2 SPDs).

This is an arrester that satisfies both test classifications.

In the case of a combined lightning current and surge arrester special, such as the FLT-SEC-T1+T2, however, a voltage-switching spark gap (type 1+2 SPD) is coordinated directly with a voltage-limiting varistor (type 2 SPD) that is connected in parallel. Two autonomous protective devices ensure optimum response behavior, the best possible system protection, and a long service life for the components.



Surge protection for MCR technology

The range of different applications presents a particular challenge to surge protection for measurement and control technology. Different signal types, interfaces, and fieldbus systems require a tailor-made product and a wide product range. Various protective circuits are therefore available that are specially optimized for the application.

Primarily, a distinction is made between two signal types: independent closed loops and signals with a common reference conductor or a shared return conductor.

The independent closed loops are often designed so that they are isolated from the ground potential for immunity to interference.

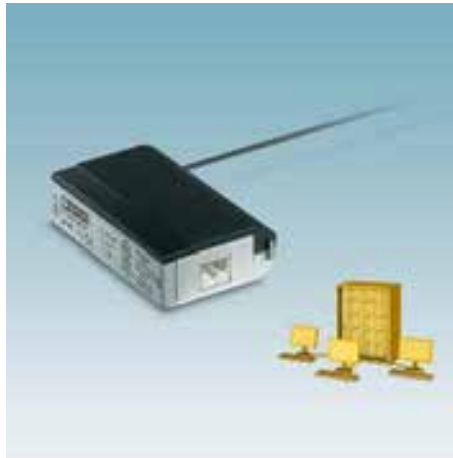

Surge protection for information technology

In the area of information technology, the various interfaces operate with low signal levels at high frequencies. This makes them particularly sensitive to surge voltages and can lead to the destruction of electronic components in IT systems. The surge protective devices must therefore also have high-quality signal transmission behavior; as otherwise, malfunctions can be expected in the data transmission.

Possible interfaces include the following:

- Ethernet
- Serial interfaces
- Telecommunications interfaces



Surge protection for transceiver systems

Typical areas of application in the field of transceiver systems are the antenna connections of television and radio receivers, video communication, and mobile phone systems. Antenna cables which extend beyond a building and are usually very long, plus the antennas themselves, are directly exposed to atmospheric discharge. Surge voltages can even reach the sensitive interfaces of transceiver systems via this cable path.



Clear insight into the system

ImpulseCheck is the world's first intelligent assistance system for surge protection in the field of mains protection. The module allows you to measure the state of health of every single protective device via cloud connection and provides new digital services.

Optimum protection for sensitive systems

In many cases, SPDs can limit surge voltages and discharge surge currents without your system sustaining any damage. Depending on the number, duration, and amplitude of the surge currents, SPDs may be pushed to their very limits and fail. Other faults in the electrical installation, such as short circuits or ground faults, can also contribute to the failure of SPDs. A failure is indicated by a status indicator on the SPD itself and additional remote signaling, if necessary.

The current, actual load on the SPDs can only be determined by performing an electrical test on the individual modules. However, this is laborious and only provides an insight into the state of the SPDs at the time of testing.

How does ImpulseCheck work?

ImpulseCheck enables the continuous monitoring of SPDs. Thanks to external sensor cables, the system can be easily installed or retrofitted in both new and existing systems. It takes just a few simple steps to attach up to 4 sensors to the connecting cables of the monitored SPD.

Surge currents with a very high time resolution are captured on each channel. Both high-frequency events and sustained currents are measured reliably. Electromagnetic interference is detected, allocated a time stamp, and transmitted to PROFICLOUD. Important parameters are evaluated and indicated from the signal curves for surge current events. In addition, the remote indication contact of the monitored SPD can be evaluated.

For Phoenix Contact SPDs, the actual load is determined at all times based on the recorded events. The determined status (green, yellow, red) is displayed in PROFICLOUD as well as on the device itself. This allows you to respond proactively before an SPD actually fails.

Benefit from digital added value

The cloud-based evaluation of measured data enables the direct use of new digital services. Status messages regarding surge protection can be displayed on any web-enabled device. For example, you can configure custom notifications for various events in PROFICLOUD or create standard-compliant status reports at the push of a button.

Thanks to the ongoing further development of new and existing devices for PROFICLOUD as well as the platform itself, it will be possible to network a wide range of applications and services in the future.

i Your web code: #2095



Keeping the pulse of your system

Benefit from predictive maintenance: thanks to real-time measurement of electromagnetic interference and surge currents, you can continuously monitor the condition of the system and the surge protection. This makes the remaining service life expectancy (state of health) of the protective devices transparent, so that maintenance services become more predictable.



Status reports at the push of a button

Depending on the system type, the IEC 62305-3 standard requires that surge protective devices are tested at specific intervals. Thanks to the real-time monitoring, you know the SPD's state and can generate status reports at any time at the push of a button – even between the predetermined test intervals. This provides you with all the necessary information, whenever you need it.



Benefit from digital added value and services

The cloud-based analysis of measured values enables completely new automated processes. Combine the values from surge voltage events in the cloud with local weather data or location information, for example. Use this information for your logistics or export the data for your own evaluation.



Safe Energy Control (SEC) range

The surge protective devices in the SEC product range represent an easy-to-install product range which combines maximum performance and superior durability. Electronic consumers are reliably protected and maintenance costs are reduced. The surge protective devices are characterized by their easy, cost-effective, and space-saving installation.

Uninterrupted protection for your system

Ensure uninterrupted system operation by using surge protective devices from the SEC range. By using technologically leading spark gaps and products with safe disconnect device, you can implement a consistent and safe protection concept. The type 1, 2, and 3 surge protective devices are all pluggable. Testing and maintenance work is therefore made much easier.

Protection for life

The high-quality products in the SEC range are particularly durable thanks to their high, laboratory-tested quality. This is demonstrated by international certificates. Even in the most lightning-prone location in the world, the surge protective devices in the SEC product range will provide protection for decades to come.

Efficiency in control cabinet manufacturing

Plan your control cabinets more efficiently and easily with the SEC range. Installation is cost-effective and space-saving, thanks to the uniform compact design of the surge protective devices, which do not need a backup fuse. The world's smallest type 2 protective device and the world's first type 3 surge protection with Push-in connection technology are emblematic of this.

i Your web code: **#0143**



New spark gaps

The newly developed spark gaps in the type 1 arresters are isolated and extremely powerful thanks to the use of technology with no line follow current. This increases the durability of the components in your system.



Type 1+2 combined lightning current and surge arrester with integrated arrester backup fuse

The FLT-SEC-HYBRID... combines surge protection and a backup fuse in a single connector. It is no longer necessary to install a separate arrester backup fuse. This saves space and reduces installation costs.



The power package

Maximum discharge capacity in an extremely compact design. And all for continuous voltages up to 440 V. The ideal type 1+2 combined lightning current and surge arrester for use in industry and wind turbine generators.



Lightning and surge protection

Reliable protection and minimal installation effort, thanks to the narrowest coordinated combination or true type 1 spark gaps and type 2 varistor arresters.



Ultra narrow

With an overall width of just 12.5 mm per channel, the type 2 surge protective devices provide outstanding protection in a minimum amount of space – they can be used up to 315 A in the branch without a backup fuse.



Powerful type 3 device protection

The world's first type 3 surge protective device with Push-in fast connection technology provides optimum protection for industrial power supply.



Type 1+2 combined lightning current and surge arrester for harsh industrial environments

With a rated voltage of 800 V AC, a discharge capacity of 35 kA per channel, and a robust housing design, POWERTRAB is ideal for harsh industrial environments and use in 690 V IT networks, such as in wind turbine generators.



Type 1+2 combined lightning current and surge arrester for lightning protection level III and IV

The VAL-MS T1/T2 ... varistor-based combination protective devices meet the requirements of lightning protection class III and IV and also provide the voltage protection level of a type 2 surge protective device.



Type 2 surge protection for higher nominal voltages

With VAL-MS..., corresponding arresters are available for power supplies with higher supply voltages, such as in wind turbine generators or when discharge currents > 30 kA per channel are required.



Type 3 device protection in an extremely compact design

Ideal for protecting end devices, type 3 device protection is used in deep installation boxes, cable ducts or underfloor systems.



Type 3 device protection as an attachment plug

The MAINTRAB device protection range is very easy to retrofit in existing installations. Versions are available as simple adapters for mains sockets or with additional signal interfaces.



Surge protection for LED lights

The surge protective devices for LED applications are specifically designed for street, tunnel or object lighting. Different versions are available for protection class I and II.



Surge protection with integrated arrester backup fuse

VAL-CP-MCB... are combinations of type 2 surge protection with integrated, surge-proof circuit breakers as arrester backup fuses.



Surge protection for 60 mm system technology

VAL-CP-MOSO... are type 2 surge protective devices with integrated, surge-proof arrester backup fuse for installation on 60 mm system technology.



Surge protection for photovoltaic systems

The product range comprises individual components for all types of photovoltaic systems, from 600 V DC up to 1500 V DC.



Type 3 surge protection for I/Os and controllers

TTC type 3 is based on the narrow 6 mm TERMITRAB complete range. It protects the 24 V power supply of end devices such as I/Os or controllers against surge voltages from the field.



Surge protection for DC current sources

VALVETRAB-SEC DC is the surge protection solution for power supplies with linear operating characteristics. Two different circuit versions for various nominal voltages provide protection for all common DC applications.

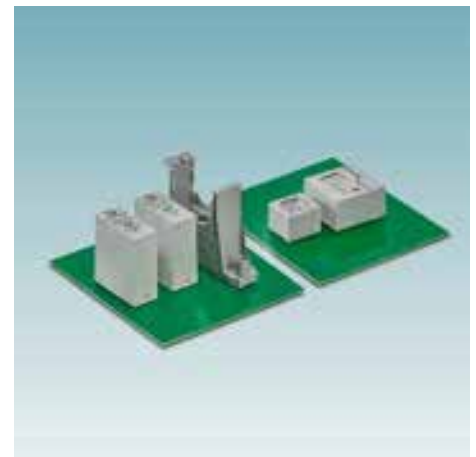

Surge protection for printed-circuit boards

The PRINTRAB series enables powerful type 2 surge protection in a confined space. Installed directly on the PCB, it provides protection for single-phase applications in very small devices. There are numerous areas of application, such as the future 5G communication system or inverters.

Surge protection and interference suppression filters

Surge protection for the power supply

Selection guide

The selection matrix indicates the corresponding surge protective device for commonly used network types.

Classification according to IEC test classification / EN type is simplified here. Detailed information can be found on the relevant product page.

Further application recommendations are available on request.

230/400 V systems Standard applications						
Network type			IEC test classification / EN type			
			I / T1	II / T2	III / T3	+ ⚡
3-phase	TN-S/TT 	230 / 400 V	✓	✓		
			✓	✓		✓
			✓	✓		
				✓		
				✓		
3-phase	TN-C 	230 / 400 V	✓	✓		
			✓	✓		✓
			✓	✓		
				✓		
				✓		
1-phase	TN-S/TT 	230 V	✓	✓		
			✓	✓		✓
			✓	✓		
				✓		
				✓		
1-phase	TN-C 	230 V	✓	✓		
			✓	✓		✓
			✓	✓		
				✓		
				✓		

230/400 V systems Special installation requirements						
Network type			IEC test classification / EN type			
			I / T1	II / T2	III / T3	+ ⚡
3-phase	TN-S/TT 	230 / 400 V	✓	✓		
				✓		
				✓		✓
				✓		✓
				✓		
3-phase	TN-C 	230 / 400 V	✓	✓		
				✓		✓
				✓		✓
				✓		✓
				✓		
1-phase	TN-S/TT 	230 V	✓	✓		
				✓		✓
				✓		
				✓		
				✓		
1-phase	TN-C 	230 V	✓	✓		
				✓		
				✓		
				✓		
				✓		



Note

Products bearing this stamp (plug elements) can be tested with CHECKMASTER 2.

Surge protective device (SPD)	Order No.	Page
FLT-SEC-P-T1-3S-350/25-FM	2905421	37
FLT-SEC-H-T1-3C-264/25-FM + FLT-SEC-P-T1-N/PE-350/100-FM	2905871 + 2905472	34
FLT-SEC-T1+T2-3S-350/25-FM	2905470	42
VAL-SEC-T2-3S-350-FM	2905340	54
PLT-SEC-T3-3S-230-FM	2905230	82
FLT-SEC-P-T1-3C-350/25-FM	2905419	37
FLT-SEC-H-T1-3C-264/25-FM	2905871	34
FLT-SEC-T1+T2-3C-350/25-FM	2905469	42
VAL-SEC-T2-3C-350-FM	2905339	54
FLT-SEC-P-T1-1S-350/25-FM	2905415	39
FLT-SEC-H-T1-1C-264/25-FM + FLT-SEC-P-T1-N/PE-350/100-FM	2801615 + 2905472	34
FLT-SEC-T1+T2-1S-350/25-FM	2905466	43
VAL-SEC-T2-1S-350-FM	2905333	55
PLT-SEC-T3-230-FM-PT	2907928	83
FLT-SEC-P-T1-1C-350/25-FM	2905414	39
FLT-SEC-H-T1-1C-264/25-FM	2801615	34
FLT-SEC-T1+T2-1C-350/25-FM	2905465	44

Surge protective device (SPD)	Order No.	Page	
FLT-SEC-P-T1-3S-264/50-FM	Where $I_{imp} = 50$ kA in L-N mode of protection	2909589	40
VAL-SEC-T2-3S-350/40-FM	Where $I_n = 40$ kA in N-PE mode of protection	2909635	54
VAL-SEC-T2-3S-350VF-FM	Free of leakage current	2909590	54
VAL-CP-MCB-3S-350/40/FM	Combination with MCB	2882750	74
VAL-CP-MOSO 60-3S-FM	Combination with MCB for 60 mm rail system	2804403	75
FLT-SEC-P-T1-3C-264/50-FM	Where $I_{imp} = 50$ kA in L-N mode of protection	2907390	40
VAL-SEC-T2-3C-350VF-FM	Free of leakage current	2909591	54
VAL-CP-MCB-3C-350/40/FM	Combination with MCB	2882776	74
VAL-CP-MOSO 60-3C-FM	Combination with MCB for 60 mm rail system	2804416	75
FLT-SEC-P-T1-1S-264/50-FM	Where $I_{imp} = 50$ kA in L-N mode of protection	2907388	41
VAL-SEC-T2-1S-350VF-FM	Free of leakage current	2909592	55
VAL-CP-MCB-1S-350/40/FM	Combination with MCB	2882763	74
BLT-T2-1S-320-UT	Universal mounting	2906101	76
MNT-1 D	Attachment plug	2882200	88
BLT-T3-230-A	Universal mounting (audible)	1038841	86
BLT-SKT-230-A	Universal mounting (audible)	1038842	86
FLT-SEC-P-T1-1C-264/50-FM	Where $I_{imp} = 50$ kA in L-N mode of protection	2907387	41

Surge protection and interference suppression filters





Surge protection for the power supply



Selection guide

The selection matrix indicates the corresponding surge protective device for commonly used network types.

Classification according to IEC test classification / EN type is simplified here. Detailed information can be found on the relevant product page.

Further application recommendations are available on request.

Other network types						
Network type		IEC test classification / EN type				
		I / T1	II / T2	III / T3	+ ⚡	
3-phase	TN-S/TT 	400 / 690 V	✓	✓		
			✓	✓		
	TN-C 	400 / 690 V	✓	✓		✓
			✓	✓		
	IT 	400 V	✓	✓		✓
			✓	✓		
		500 - 690 V	✓	✓		
1-phase	TN-S/TT 	120 V	✓	✓		
				✓		
				✓		

DC systems					
Network type		IEC test classification / EN type			
		I / T1	II / T2	III / T3	
Linear DC source 	24 V	✓	✓		
				✓	
				✓	
	48 V	✓			✓
				✓	
				✓	
	120 V			✓	
				✓	
	220 V			✓	
				✓	
	380 V			✓	
				✓	
Photovoltaic DC source 	0.6 kV	✓			
	1.0 kV	✓			
	1.5 kV	✓			
			✓		



Note

Products bearing this stamp (plug elements) can be tested with CHECKMASTER 2.

Surge protective device (SPD)	Order No.	Page
FLT-SEC-P-T1-3S-440/35-FM	2908264	35
FLT-SEC-H-T1-3C-440/25-FM + FLT-SEC-P-T1-N/PE-440/100-FM	2907260 + 2907262	34
VAL-SEC-T2-4+0-440-FM TN-S only	1076468	53
FLT-SEC-P-T1-3C-440/35-FM	2905988	35
FLT-SEC-H-T1-3C-440/25-FM	2907260	34
VAL-SEC-T2-3C-440-FM	2909968	53
PWT 100-800AC-FM	2800531	52
VAL-MS 750/30/3+0-FM	2920272	65
FLT-SEC-P-T1-3C-440/35-FM	2905988	35
FLT-SEC-H-T1-3C-440/25-FM	2907260	34
VAL-SEC-T2-3C-440-FM	2909968	53
PWT 100-800AC-FM	2800531	52
VAL-MS 750/30/3+0-FM	2920272	65
VAL-US-120/65/1+1-FM	2910356	93
VAL-SEC-T2-1S-175-FM	2905348	57
PLT-SEC-T3-120-FM-PT	2907927	83

Surge protective device (SPD)	Order No.	Page
VAL-MS-T1/T2 48/12.5/1+1V-FM	2801533	48
VAL-SEC-T2-2+0-48DC-FM	2907865	58
VAL-SEC-T2-2+F-48DC-FM Free of leakage current	1033786	59
PLT-SEC-T3-24-FM-PT	2907925	82
VAL-MS-T1/T2 48/12.5/1+1V-FM	2801533	48
VAL-SEC-T2-2+0-48DC-FM	2907865	58
VAL-SEC-T2-2+F-48DC-FM Free of leakage current	1033786	59
PLT-SEC-T3-60-FM-PT	2907926	83
VAL-SEC-T2-2+0-120DC-FM	2907874	58
VAL-SEC-T2-2+F-120DC-FM Free of leakage current	1033788	59
PLT-SEC-T3-120-FM-PT	2907927	83
VAL-SEC-T2-2+0-220DC-FM	2907875	58
VAL-SEC-T2-2+F-220DC-FM Free of leakage current	1033789	59
PLT-SEC-T3-230-FM-PT	2907928	83
VAL-SEC-T2-2+0-380DC-FM	2907876	58
VAL-SEC-T2-2+F-380DC-FM Free of leakage current	1033790	59
VAL-MS-T1/T2 600DC-PV/2+V-FM	2801164	50
VAL-MS 600DC-PV/2+V-FM	2800641	73
VAL-MS-T1/T2 1000DC-PV/2+V-FM	2801161	50
VAL-MS 1000DC-PV/2+V-FM	2800627	73
VAL-MB-T1/T2 1500DC-PV/2+V-FM	2905640	51
VAL-MS 1500DC-PV/2+V-FM	1033725	73

Surge protection and interference suppression filters

Surge protection for the power supply

Type 1 protection for the power supply with integrated arrester backup fuse

FLT-SEC-HYBRID

Branch wiring in the TN-C network

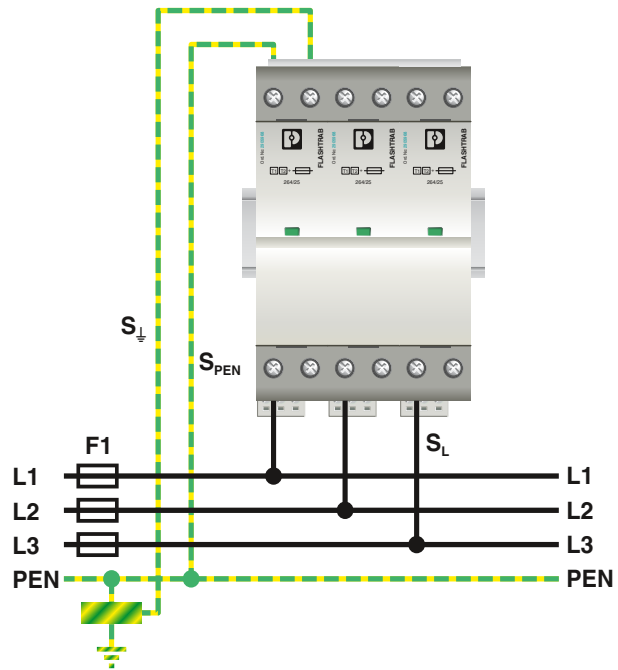

Technical characteristics	
Typical installation location	Upstream or downstream of the circuit breaker of low-voltage distribution boards with large load currents
Lightning protection level	I, II, III, IV
Lightning protection zone transition	LPZ 0 _A → LPZ 1
Coordination	Coordination with type 2 protective devices from the SEC range is guaranteed
Connecting cables	<ul style="list-style-type: none"> Refer to the adjacent tables for the required conductor cross sections. The connection to the main grounding rail (S_{\perp}) is mandatory (see figure). For S_{\perp}, use a cross section of at least 16 mm². If this connection (S_{\perp}) is to be equal to the connection to the protective conductor (S_{PEN}) in the application, use a cross section of at least 35 mm² for S_{PEN}. If the supply line cross section is greater than 35 mm², make sure that the surge protection connecting cables (S_L) are protected against ground faults and short circuits. Recommendation: use temperature-stable cables for S_L, e.g., XLPE/EPR-insulated cables. Lay the connecting cables as short as possible, without loops, and with the largest possible bending radii.
Backup fuses	<ul style="list-style-type: none"> Can be used without backup fuse in branch wiring The integrated overcurrent protection is selective in relation to upstream F1 fuses ≥ 400 A gG
Products in the catalog	Page 34

S_L mm ²	S_{PEN} mm ²
35	35

Table 1: Connecting cables

	U_{max}	I_{max}
AC	250 V	1 A
AC	125 V (UL)	1 A (UL)
DC	125 V	0.2 A
DC	30 V	1 A
0.14 mm ² ... 1.5 mm ²		

Table 2: Remote signaling data

Type 1 protection for the power supply

FLT-SEC-PLUS

Branch wiring in the TN-C network

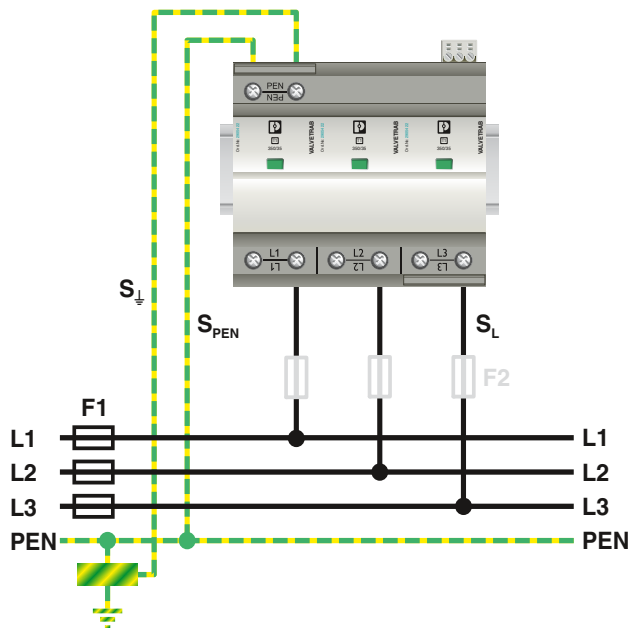

Technical characteristics	
Typical installation location	Where the cable enters the building or in the pre-meter or post-meter area
Lightning protection level	I, II, III, IV
Lightning protection zone transition	LPZ 0 _A → LPZ 1
Coordination	Coordination with type 2 protective devices from the SEC range is guaranteed
Connecting cables	<ul style="list-style-type: none"> Refer to the adjacent tables for the required conductor cross sections. The connection to the main grounding rail (S_d) is mandatory (see figure). For S_d, use a cross section of at least 16 mm². If this connection (S_d) is to be equal to the connection to the protective conductor (S_{PEN}) in the application, use a cross section of at least 16 mm² for S_{PEN}. Lay the connecting cables as short as possible, without loops, and with the largest possible bending radii.
Backup fuses	<ul style="list-style-type: none"> Can be used without backup fuse in branch wiring up to 315 A gG If the surge protection fuse needs to be selective in relation to the upstream installation, a separate F2 backup fuse is required. Once the F2 backup fuse has tripped, surge protection is no longer in place for the system. Can be used without backup fuse in through wiring up to 125 A gG
Products in the catalog	Page 35

F1 A gG	F2 A gG	$S_L = S_N$ mm ²	$S_{PE(N)}$ mm ²	S_d mm ²
40		6	6	16
50		6	6	16
63		6	6	16
80		10	10	16
100		10	10	16
125		16	16	16
160		16	16	16
200		25	25	16
250		35	35	16
315		35	35	16
400	≤ 250	Conductor cross sections according to selected F2 fuse, see above		
≥ 500	≤ 315			

Table 1: Branch wiring

F1 A gG	S_L mm ²	$S_{PE(N)}$ mm ²	S_d mm ²
40	6	6	16
50	10	10	16
63	10	10	16
80	16	16	16
100	25	16	16
125	35	16	16

Table 2: Through wiring

	U_{max}	I_{max}
AC	250 V	1 A
AC	125 V (UL)	1 A (UL)
DC	125 V	0.2 A
DC	30 V	1 A
0.14 mm ² ... 1.5 mm ²		

Table 3: Remote signaling data

Surge protection and interference suppression filters

Surge protection for the power supply

Type 1+2 protection for the power supply

FLT-SEC-T1+T2

Branch wiring in the TN-S network

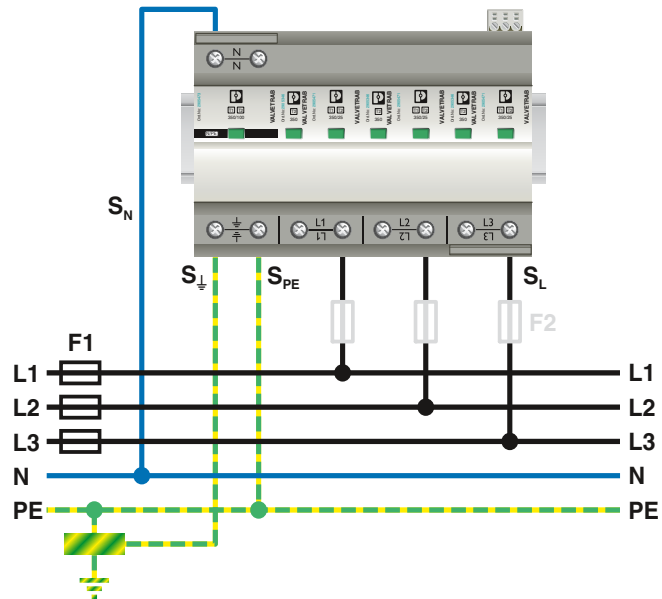

Technical characteristics	
Typical installation location	Where the cable enters the building in the post-meter area
Lightning protection level	I, II, III, IV
Lightning protection zone transition	LPZ 0 _A → LPZ 2
Coordination	Coordination with type 3 protective devices from the SEC range is guaranteed
Connecting cables	<ul style="list-style-type: none"> Refer to the adjacent tables for the required conductor cross sections. The connection to the main grounding rail (S_j) is mandatory (see figure). For S_j, use a cross section of at least 16 mm². If this connection (S_j) is to be equal to the connection to the protective conductor (S_{PE}) in the application, use a cross section of at least 16 mm² for S_{PE}. Lay the connecting cables as short as possible, without loops, and with the largest possible bending radii.
Backup fuses	<ul style="list-style-type: none"> Can be used without backup fuse in branch wiring up to 315 A gG If the surge protection fuse needs to be selective in relation to the upstream installation, a separate F2 backup fuse is required. Once the F2 backup fuse has tripped, surge protection is no longer in place for the system. Can be used without backup fuse in through wiring up to 125 A gG
Products in the catalog	Page 42

F1 A gG	F2 A gG	$S_L = S_N$ mm ²	$S_{PE(N)}$ mm ²	S_j mm ²
40		6	6	16
50		6	6	16
63		6	6	16
80		10	10	16
100		10	10	16
125		16	16	16
160		16	16	16
200		25	25	16
250		35	35	16
315		35	35	16
400	≤ 250	Conductor cross sections according to selected F2 fuse, see above		
≥ 500	≤ 315			

Table 1: Branch wiring

F1 A gG	S_L mm ²	$S_{PE(N)}$ mm ²	S_j mm ²
40	6	6	16
50	10	10	16
63	10	10	16
80	16	16	16
100	25	16	16
125	35	16	16

Table 2: Through wiring

	U_{max}	I_{max}
AC	250 V	1 A
AC	125 V (UL)	1 A (UL)
DC	125 V	0.2 A
DC	30 V	1 A
0.14 mm ² ... 1.5 mm ²		

Table 3: Remote signaling data

Type 2 protection for the power supply

VAL-SEC

Branch wiring in the TN-S network

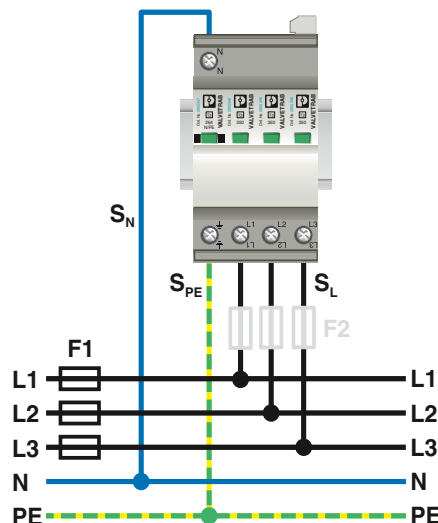

Technical characteristics	
Typical installation location	In sub-distributions or level distributions upstream of the RCD
Lightning protection zone transition	LPZ 0 _B → LPZ 1 LPZ 1 → LPZ 2
Coordination	Coordination with type 1 and type 3 protective devices from the SEC range is guaranteed
Connecting cables	<ul style="list-style-type: none"> Refer to the adjacent tables for the required conductor cross sections. For backup fuses > 200 A in relation to PVC-insulated copper cables, it is not possible to clamp a sufficient cross section for short circuits and ground faults. Special measures must therefore be implemented in this area to ensure that the connecting cables are protected against short circuits and ground faults. Use spacers to prevent the cables from touching each other or touching conductive components. Use cables with increased temperature stability (e.g., XLPE/EPR-insulated cables). Lay the connecting cables as short as possible, without loops, and with the largest possible bending radii.
Backup fuses	<ul style="list-style-type: none"> Can be used without backup fuse in branch wiring up to 315 A gG If the surge protection fuse needs to be selective in relation to the upstream installation, a separate F2 backup fuse is required. Once the F2 backup fuse has tripped, surge protection is no longer in place for the system. Can be used without backup fuse in through wiring up to 63 A gG
Products in the catalog	Page 54

F1 A gG	F2 A gG	S _L = S _N mm ²	S _{PE} mm ²
25		6	6
32		6	6
40		6	6
50		6	6
63		6	6
80		10	10
100		10	10
125		16	16
160		16	16
200		25	25
250		25	25
315		25	25
400	≤ 250	25	25
≥ 500	≤ 315	25	25

Table 1: Branch wiring

F1 A gG	S _L = S _N mm ²	S _{PE} mm ²
25	6	6
32	6	6
40	6	6
50	10	10
63	10	10

Table 2: Through wiring

	U _{max}	I _{max}
AC	250 V	1 A
AC	125 V (UL)	1 A (UL)
DC	125 V	0.2 A
DC	30 V	1 A
0.14 mm ² ... 1.5 mm ²		

Table 3: Remote signaling data

Surge protection and interference suppression filters

Surge protection for the power supply

Type 2 protection for the power supply

VAL-SEC DC

Branch wiring in isolated DC voltage systems

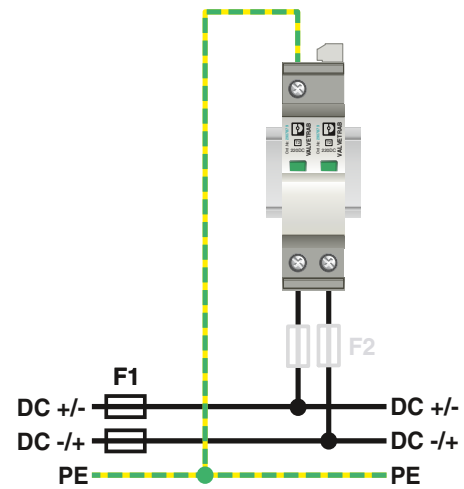

Technical characteristics	
Typical installation location	Main and sub-distribution
Lightning protection zone transition	LPZ 0 _B → LPZ 1 LPZ 1 → LPZ 2
Coordination	Coordination with type 3 SPDs from the SEC range is guaranteed.
Connecting cables	<ul style="list-style-type: none"> – For branch wiring, the connecting cables and conductor cross sections only have to be designed for short circuits and ground faults. – For through wiring, the operating and overload current must also be taken into consideration. – Lay the connecting cables as short as possible, without loops, and with the largest possible bending radii.
Backup fuses	– Refer to the adjacent tables for the required conductor cross sections.
Products in the catalog	Page 58

Prospective short-circuit current I_{SCCR}	S_L/mm^2	$S_{PE} = S_J/\text{mm}^2$	F2 backup fuse
> 200 A	4	6	20 A
≤ 200 A	4	6	-

Table 1: Backup fuses for $U_N \leq 220 \text{ V DC}$

Prospective short-circuit current I_{SCCR}	S_L/mm^2	$S_{PE} = S_J/\text{mm}^2$	F2 backup fuse
≤ 100 A	4	6	-
> 100 A	4	6	10 A
> 200 A	4	6	20 A

Table 2: Backup fuses for $U_N \leq 400 \text{ V DC}$

	U_{\max}	I_{\max}
AC	250 V	1 A
AC	125 V (UL)	1 A (UL)
DC	125 V	0.2 A
DC	30 V	1 A
0.14 mm ² ... 1.5 mm ²		

Table 3: Remote signaling data

Type 3 protection for the power supply

PLT-SEC

Through wiring and branch wiring
in the TN-S network

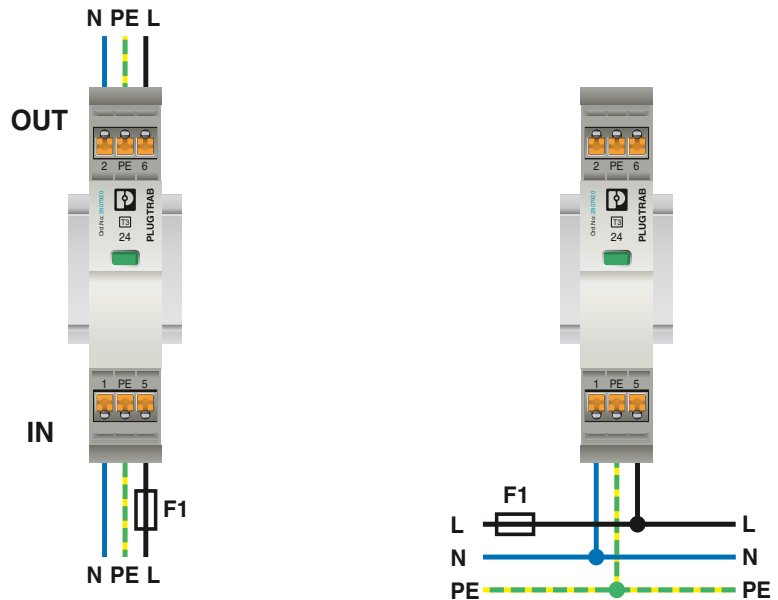

Technical characteristics	
Typical installation location	Upstream of the end device to be protected
Lightning protection zone transition	LPZ 1 → LPZ 2 LPZ 2 → LPZ 3
Coordination	Coordination with type 2 protective devices from the SEC range is guaranteed
Connection	<ul style="list-style-type: none"> – Max. conductor cross section 4 mm² rigid and 2.5 mm² flexible – The maximum load current I_L is 26 A for through wiring
Backup fuses	<ul style="list-style-type: none"> – AC: can be used without backup fuse in branch wiring up to 32 A gG – DC: can be used without backup fuse for prospective short-circuit currents up to 250 A DC
Products in the catalog	Page 82

	U_{max}	I_{max}
AC	250 V	0.5 A
DC	125 V	0.2 A
DC	75 V	0.5 A
0.2 mm ² ... 2.5 mm ²		

Table 1: Remote signaling data

Surge protection and interference suppression filters

Surge protection for the power supply

Type 2 protection for the power supply

VAL-CP-MCB

Branch wiring in the TN-S network

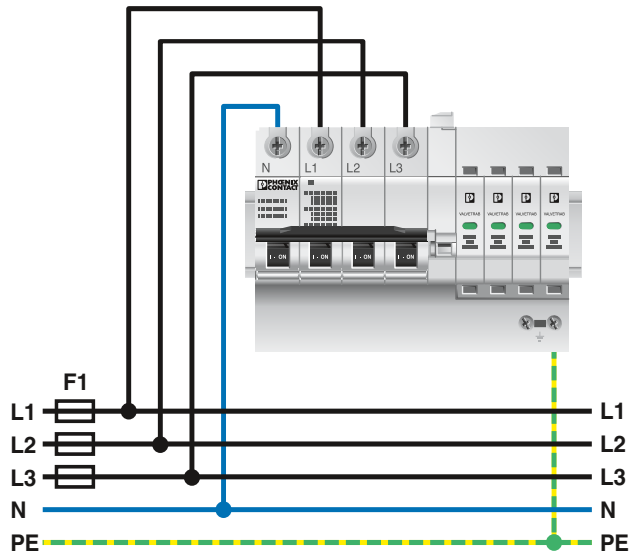

Technical characteristics	
Typical installation location	In sub-distributions or level distributions upstream of the RCD
Lightning protection zone transition	LPZ 0 _B → LPZ 1 LPZ 1 → LPZ 2
Coordination	Coordination with type 1 and type 3 protective devices from the SEC range is guaranteed
Connecting cables	<ul style="list-style-type: none"> Refer to the adjacent tables for the required conductor cross sections. For backup fuses > 250 A in relation to PVC-insulated copper cables, it is not possible to clamp a sufficient cross section for short circuits and ground faults. Special measures must therefore be implemented in this area to ensure that the connecting cables are protected against short circuits and ground faults. Prevent the cables from touching each other or touching conductive components, e.g., by using spacers, or use cables with increased temperature stability (e.g., XLPE/EPR-insulated cables). Lay the connecting cables as short as possible, without loops, and with the largest possible bending radii.
Backup fuses	<ul style="list-style-type: none"> Can be used without backup fuse in branch wiring The integrated overcurrent protection is selective in relation to upstream F1 fuses ≥ 63 A gG
Products in the catalog	Page 74

F1 A gG	S _L = S _N mm ²	S _{PE} mm ²
63	10	10
80	10	10
100	16	16
125	16	16
160	25	25
200	25	25
250	35	2 x 16
> 250	35	2 x 16

Table 1: Branch wiring

	U _{max}	I _{max}
AC	250 V	2 A
DC	250 V	0.05 A
0.14 mm ² ... 1.5 mm ²		

Table 2: Remote signaling data

Type 1 protection for the power supply

FLT-SEC-ZP

Installation in TN-S network



Technical characteristics	
Typical installation location	In the grid-side wiring space of meter cabinets with 40 mm busbar system
Lightning protection level	III, IV
Lightning protection zone transition	LPZ 0 _A → LPZ 1
Coordination	Coordination with type 2 protective devices from the SEC range is guaranteed
Connecting cables	<ul style="list-style-type: none"> – If an external lightning protection system is present, it is imperative that the separate connecting cable (S_p) is connected to the main grounding rail (see figure). – For S_p, use a cross section of at least 16 mm². – For busbar systems without PE/PEN rail, use one of the terminal points for the separate protective conductor connection. – Use a cross section of at least 16 mm².
Backup fuses	– Can be used without backup fuse up to 250 A gG
Products in the catalog	Page 45

Network type	Surge protective device (SPD)	Order No.
TN-S / TT	FLT-SEC-ZP-3S-255/12,5	1032207
TN-C	FLT-SEC-ZP-3C-255/12,5	1032204

Table 1: Products for lightning protection equipotential bonding in accordance with lightning protection levels III and IV

Network type	Surge protective device (SPD)	Order No.
TN-S / TT	FLT-SEC-ZP-3S-255/7,5	1074741
TN-C	FLT-SEC-ZP-3C-255/7,5	1074739

Table 2: Products for equipotential bonding for supply via overhead lines

Surge protection and interference suppression filters

Surge protection for the power supply

Protection for 24 V potential distribution

TTC type 3 surge protection and PTCB overcurrent protection

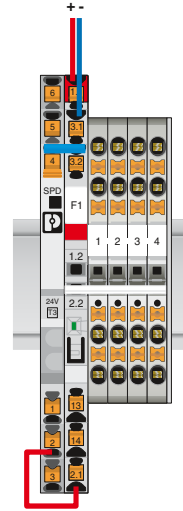

Technical characteristics	
Typical installation location	<ul style="list-style-type: none">- At the 24 V potential distribution- Branch wiring to PTCB device circuit breakers
Lightning protection zone transition	LPZ 1 → LPZ 2 LPZ 2 → LPZ 3
Connection	<ul style="list-style-type: none">- Max. conductor cross section 4 mm² rigid and 2.5 mm² flexible- Max. load current IL is 6 A for through wiring
Backup fuse in branch wiring	<ul style="list-style-type: none">- Without additional backup fuse (for short-circuit currents ≤ 60 A)- Max. 10 A, when combined with electronic circuit breakers (PTCB, CBM, CBMC)
Products in the catalog	Page 85

Surge protection and interference suppression filters

Surge protection for the power supply

Type 1+2 combined lightning current and surge arrester FLASHTRAB SEC HYBRID

- Integrated combination of spark gap without line follow current and surge-proof fuse
- Can be used without separate backup fuse, thanks to integrated overcurrent protection
- Free of leakage current, suitable for use in the pre-meter area
- 440 V versions satisfy TOV requirements for use in IT systems
- Can be inserted with innovative push-pull locking mechanism
- Low voltage protection level of 1.5 kV for 264 V and 2.5 kV for 440 V versions
- Optical, mechanical status indicator
- With floating remote indication contact
- Plugs can be tested with CHECKMASTER 2



4-conductor system; L1, L2, L3, PEN



2-conductor system; L, PEN

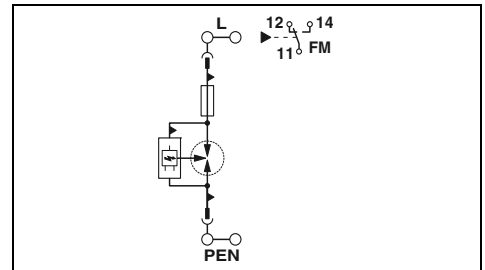
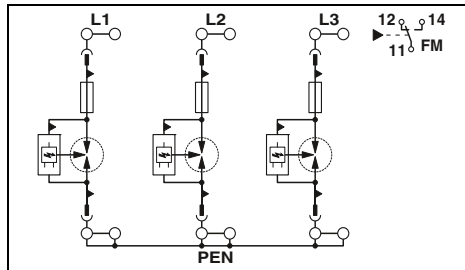

Notes:
If only one value is specified under mode of protection in the technical data, this value is valid for all modes of protection specified.

Electrical data	
IEC test classification	... 264 I / II, T1 / T2
Nominal voltage U_N	240/415 V AC (TN-C)
Mode of protection	
Maximum continuous operating voltage U_C	L-PEN 264 V AC
Impulse discharge current I_{imp} (10/350) μ s	25 kA
Nominal discharge current I_n (8/20) μ s	25 kA
Max. discharge current I_{max} (8/20) μ s	50 kA
Protection level U_p	≤ 1.5 kV
Follow current interrupt rating I_f	50 kA
Response time t_A	≤ 100 ns
Short-circuit current rating I_{SCCR}	50 kA
General data	
Dimensions W/H/D	106.8 mm / 167 mm / 74.5 mm
IEC connection data	Rigid / flexible / AWG 2.5 ... 35 mm ² / 2.5 ... 35 mm ² / 13 ... 2
Temperature range	-40°C ... 80°C
Test standards	IEC 61643-11 / EN 61643-11
Remote indication contact	PDT contact
IEC connection data	Rigid / flexible / AWG 0.14 ... 1.5 mm ² / 0.14 ... 1.5 mm ² / 28 ... 16
Max. operating voltage	250 V AC / 125 V DC (200 mA DC)
Max. operating current	1 A AC / 1 A DC (30 V DC)

Technical data		
... 264	... 440	
I / II, T1 / T2	I / II, T1 / T2	
240/415 V AC (TN-C)	400/690 V AC (TN-C) / 400 V AC (IT)	
L-PEN	L-PEN / L-PE	
264 V AC	440 V AC	
25 kA	25 kA	
25 kA	25 kA	
50 kA	50 kA	
≤ 1.5 kV	≤ 2.5 kV	
50 kA	50 kA	
≤ 100 ns	≤ 100 ns	
50 kA	50 kA	

Technical data		
... 264	... 440	
I / II, T1 / T2	I / II, T1 / T2	
240 V AC (TN-C)	400 V AC (TN) / 400 V AC (IT)	
L-PEN	L-N / L-PE / L-PEN / N-PE (4+0)	
264 V AC	440 V AC	
25 kA	25 kA	
25 kA	25 kA	
50 kA	50 kA	
≤ 1.5 kV	≤ 2.5 kV	
50 kA	50 kA	
≤ 100 ns	≤ 100 ns	
50 kA	50 kA	

Ordering data	
Description	U_C
FLASHTRAB	264 V AC 440 V AC

Type	Order No.	Pcs./Pkt.
FLT-SEC-H-T1-3C-264/25-FM	2905871	1
FLT-SEC-H-T1-3C-440/25-FM	2907260	1

Type	Order No.	Pcs./Pkt.
FLT-SEC-H-T1-1C-264/25-FM	2801615	1
FLT-SEC-H-T1-1C-440/25-FM	2907259	1

Accessories	
Replacement plug	L-PEN L-N/L-PE/L-PEN/N-PE (4+0)
Wiring bridge, 35 mm ² 6-pos.	MPB 18/1-6/35
8-pos.	MPB 18/1-8/35
Wiring bridge, 35 mm ² 8-pos.	FLT-SEC-H MPB-3+1

Type	Order No.	Pcs./Pkt.
FLT-SEC-H-T1-264/25-P	2905968	1
FLT-SEC-H-T1-440/25-P	2907261	1
MPB 18/1-6/35	2908705	10
MPB 18/1-8/35	2908704	10
FLT-SEC-H MPB-3+1	2910501	1

Type	Order No.	Pcs./Pkt.
FLT-SEC-H-T1-264/25-P	2905968	1
FLT-SEC-H-T1-440/25-P	2907261	1
MPB 18/1-6/35	2908705	10
MPB 18/1-8/35	2908704	10
FLT-SEC-H MPB-3+1	2910501	1

A 3+1 circuit can be implemented when the products are used in conjunction with the 8-pos. wiring bridge: FLT-SEC-H MPB-3+1 (2910501) and FLT-SEC-P-T1-N/PE-350/100-FM (2905472) or FLT-SEC-P-T1-N/PE-440/100-FM (2907262).

A 3+1 circuit can be implemented when the products are used in conjunction with the 8-pos. wiring bridge: FLT-SEC-H MPB-3+1 (2910501) and FLT-SEC-P-T1-N/PE-350/100-FM (2905472) or FLT-SEC-P-T1-N/PE-440/100-FM (2907262).

Type 1+2 combined lightning current and surge arrester FLASHTRAB SEC PLUS 440

- Spark gap has no line follow current
- Free of leakage current, suitable for use in the pre-meter area
- Satisfies TOV requirements for use in IT systems
- Pluggable
- Low voltage protection level of 2.5 kV
- Optical, mechanical status indicator
- With floating remote indication contact
- Plugs can be tested with CHECKMASTER 2

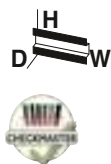

5-conductor system; L1, L2, L3, N, PE



4-conductor system, L1, L2, L3, PE(N)

Notes:

If only one value is specified under mode of protection in the technical data, this value is valid for all modes of protection specified.

ERC

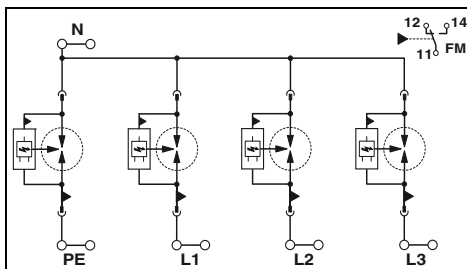

Technical data

I / II, T1 / T2
400/690 V AC (TN-S) /
400/690 V AC (TT)
L-N / L-PE / N-PE
440 V AC
35 kA / 35 kA / 100 kA
35 kA / 35 kA / 100 kA
50 kA / 50 kA / -
≤ 2.5 kV / ≤ 4.5 kV / ≤ 2.5 kV
50 kA / 50 kA / 100 A
≤ 100 ns
50 kA
400 A (gG)

ERC KEBA CB

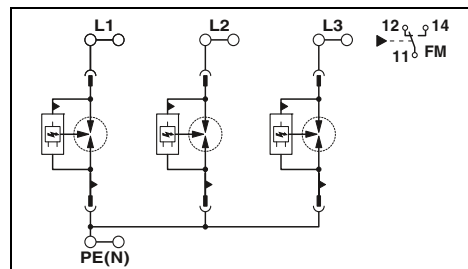

Technical data

I / II, T1 / T2
400/690 V AC (TN-C) /
400 V AC (IT)
L-PE / L-PEN
440 V AC
35 kA
35 kA
50 kA
≤ 2.5 kV
50 kA
≤ 100 ns
50 kA
400 A (gG)

Electrical data	
IEC test classification	
Nominal voltage U_N	
Mode of protection	
Maximum continuous operating voltage U_C	
Impulse discharge current I_{imp} (10/350) μ s	
Nominal discharge current I_n (8/20) μ s	
Max. discharge current I_{max} (8/20) μ s	
Protection level U_p	
Follow current interrupt rating I_{fi}	
Response time t_A	
Short-circuit current rating I_{SCCR}	
Maximum backup fuse for branch wiring	
General data	
Dimensions W/H/D	
IEC connection data	Rigid / flexible / AWG
Temperature range	
Test standards	
Remote indication contact	
IEC connection data	Rigid / flexible / AWG
Max. operating voltage	
Max. operating current	

Ordering data

Type	Order No.	Pcs./Pkt.
FLT-SEC-P-T1-3S-440/35-FM	2908264	1

Accessories

FLT-SEC-P-T1-440/35-P	2905989	1
FLT-SEC-P-T1-N/PE-440/100-P	2907263	1

Description	
FLASHTRAB	
Replacement plug	L-N/L-PE/L-PEN/N-PE (4+0) N-PE

Ordering data

Type	Order No.	Pcs./Pkt.
FLT-SEC-P-T1-3C-440/35-FM	2905988	1

Accessories

FLT-SEC-P-T1-440/35-P	2905989	1
-----------------------	---------	---

Surge protection and interference suppression filters

Surge protection for the power supply

Type 1+2 combined lightning current and surge arrester FLASHTRAB SEC PLUS 440

- Spark gap has no line follow current
- Free of leakage current, suitable for use in the pre-meter area
- Satisfies TOV requirements for use in IT systems
- Pluggable
- Low voltage protection level of 2.5 kV
- Optical, mechanical status indicator
- With floating remote indication contact
- Plugs can be tested with CHECKMASTER 2



2-conductor system, L, PE(N)



N-PE spark gap

Notes:
If only one value is specified under mode of protection in the technical data, this value is valid for all modes of protection specified.

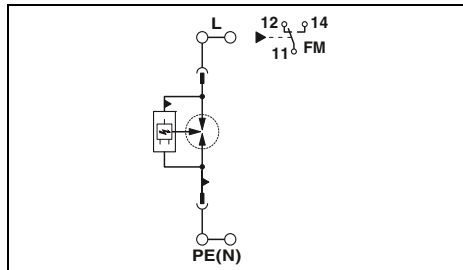

Technical data

I / II, T1 / T2
400 V AC (TN) / 400 V AC (IT)
L-N / L-PE / L-PEN / N-PE (4+0)
440 V AC
35 kA
35 kA
50 kA
≤ 2.5 kV
100 A
≤ 100 ns
50 kA
400 A (gG)

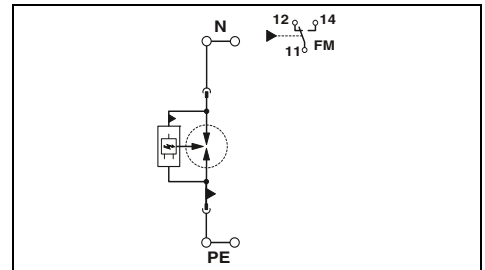

Technical data

I / II, T1 / T2
400 V AC (TN - only N-PE) / 400 V AC (TT - only N-PE)
N-PE
440 V AC
100 kA
100 kA
-
≤ 2.5 kV
100 A
≤ 100 ns
-
-

Electrical data	
IEC test classification	
Nominal voltage U_N	
Mode of protection	
Maximum continuous operating voltage U_C	
Impulse discharge current I_{imp} (10/350) μ s	
Nominal discharge current I_n (8/20) μ s	
Max. discharge current I_{max} (8/20) μ s	
Protection level U_p	
Follow current interrupt rating I_f	
Response time t_A	
Short-circuit current rating I_{SCCR}	
Maximum backup fuse for branch wiring	
General data	
Dimensions W/H/D	
IEC connection data	Rigid / flexible / AWG
Temperature range	
Test standards	
Remote indication contact	
IEC connection data	Rigid / flexible / AWG
Max. operating voltage	
Max. operating current	

35.6 mm / 95.2 mm / 74.5 mm	
2.5 ... 35 mm ² / 2.5 ... 35 mm ² / 13 ... 2	
-40°C ... 80°C	
IEC 61643-11 / EN 61643-11	
PDT contact	
0.14 ... 1.5 mm ² / 0.14 ... 1.5 mm ² / 28 ... 16	
250 V AC / 125 V DC (200 mA DC)	
1 A AC / 1 A DC (30 V DC)	

35.6 mm / 95.2 mm / 74.5 mm	
2.5 ... 35 mm ² / 2.5 ... 35 mm ² / 13 ... 2	
-40°C ... 80°C	
IEC 61643-11 / EN 61643-11	
PDT contact	
0.14 ... 1.5 mm ² / 0.14 ... 1.5 mm ² / 28 ... 16	
250 V AC / 125 V DC (200 mA DC)	
1 A AC / 1 A DC (30 V DC)	

Description	
FLASHTRAB	

Ordering data		
Type	Order No.	Pcs./Pkt.
FLT-SEC-P-T1-1C-440/35-FM	2905987	1

Ordering data		
Type	Order No.	Pcs./Pkt.
FLT-SEC-P-T1-N/PE-440/100-FM	2907262	1

Replacement plug	
L-N/L-PE/L-PEN/N-PE (4+0) N-PE	

Accessories		
FLT-SEC-P-T1-440/35-P	2905989	1

Accessories		
FLT-SEC-P-T1-N/PE-440/100-P	2907263	1

Type 1+2 combined lightning current and surge arrester FLASHTRAB SEC PLUS 350

- Spark gap has no line follow current
- Free of leakage current, suitable for use in the pre-meter area
- Pluggable
- High continuous voltage of 350 V AC for 230/400 V AC networks with high voltage fluctuations
- Low voltage protection level of 1.5 kV
- Optical, mechanical status indicator
- With floating remote indication contact
- Plugs can be tested with CHECKMASTER 2

Notes:

If only one value is specified under mode of protection in the technical data, this value is valid for all modes of protection specified.

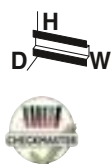

5-conductor system; L1, L2, L3, N, PE



4-conductor system; L1, L2, L3, PEN

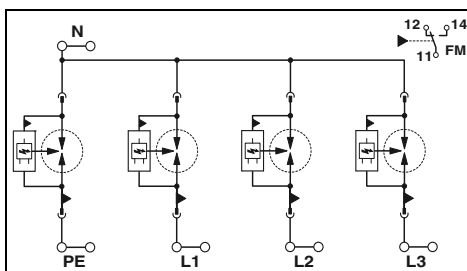

Technical data

I / II, T1 / T2
240/415 V AC (TN-S) /
240/415 V AC (TT)
L-N / L-PE / N-PE
350 V AC
25 kA / 25 kA / 100 kA
25 kA / 25 kA / 100 kA
50 kA / 50 kA / -
≤ 1.5 kV / ≤ 2.5 kV / ≤ 1.5 kV
50 kA / - / 100 A
≤ 100 ns
50 kA
315 A (gG)

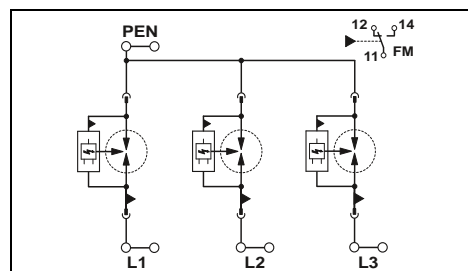

Technical data

I / II, T1 / T2
240/415 V AC (TN-C)
L-PEN
350 V AC
25 kA
25 kA
50 kA
≤ 1.5 kV
50 kA
≤ 100 ns
50 kA
315 A (gG)

Electrical data	
IEC test classification	
Nominal voltage U_N	
Mode of protection	
Maximum continuous operating voltage U_C	350 V AC
Impulse discharge current I_{imp} (10/350) μ s	25 kA / 25 kA / 100 kA
Nominal discharge current I_n (8/20) μ s	25 kA / 25 kA / 100 kA
Max. discharge current I_{max} (8/20) μ s	50 kA / 50 kA / -
Protection level U_p	≤ 1.5 kV / ≤ 2.5 kV / ≤ 1.5 kV
Follow current interrupt rating I_{fi}	50 kA / - / 100 A
Response time t_A	≤ 100 ns
Short-circuit current rating I_{SCCR}	50 kA
Maximum backup fuse for branch wiring	315 A (gG)
General data	
Dimensions W/H/D	142.4 mm / 95.2 mm / 74.5 mm
IEC connection data	Rigid / flexible / AWG 2.5 ... 35 mm ² / 2.5 ... 35 mm ² / 13 ... 2
UL connection data	AWG 3 ... 2
Temperature range	-40°C ... 80°C
Test standards	IEC 61643-11 / EN 61643-11
Remote indication contact	
IEC connection data	Rigid / flexible / AWG PDT contact 0.14 ... 1.5 mm ² / 0.14 ... 1.5 mm ² / 28 ... 16
UL connection data	AWG 30 ... 14
Max. operating voltage	250 V AC / 125 V DC (200 mA DC)
Max. operating current	1 A AC / 1 A DC (30 V DC)

General data	
Dimensions W/H/D	142.4 mm / 95.2 mm / 74.5 mm
IEC connection data	Rigid / flexible / AWG 2.5 ... 35 mm ² / 2.5 ... 35 mm ² / 13 ... 2
UL connection data	AWG 3 ... 2
Temperature range	-40°C ... 80°C
Test standards	IEC 61643-11 / EN 61643-11
Remote indication contact	
IEC connection data	Rigid / flexible / AWG PDT contact 0.14 ... 1.5 mm ² / 0.14 ... 1.5 mm ² / 28 ... 16
UL connection data	AWG 30 ... 14
Max. operating voltage	250 V AC / 125 V DC (200 mA DC)
Max. operating current	1 A AC / 1 A DC (30 V DC)

Description	
FLASHTRAB	
Replacement plug	
L-N/L-PEN	
N-PE	

Ordering data		
Type	Order No.	Pcs./Pkt.
FLT-SEC-P-T1-3S-350/25-FM	2905421	1
Accessories		
FLT-SEC-P-T1-350/25-P	2905422	1
FLT-SEC-P-T1-N/PE-350/100-P	2905473	1

Ordering data		
Type	Order No.	Pcs./Pkt.
FLT-SEC-P-T1-3C-350/25-FM	2905419	1
Accessories		
FLT-SEC-P-T1-350/25-P	2905422	1

Surge protection and interference suppression filters

Surge protection for the power supply

Type 1+2 combined lightning current and surge arrester FLASHTRAB SEC PLUS 350

- Spark gap has no line follow current
- Free of leakage current, suitable for use in the pre-meter area
- Pluggable
- High continuous voltage of 350 V AC for 230/400 V AC networks with high voltage fluctuations
- Low voltage protection level of 1.5 kV
- Optical, mechanical status indicator
- With floating remote indication contact
- Plugs can be tested with CHECKMASTER 2



4-conductor system; L1, L2, N, PE



3-conductor system; L1, L2, PEN

Notes:
If only one value is specified under mode of protection in the technical data, this value is valid for all modes of protection specified.

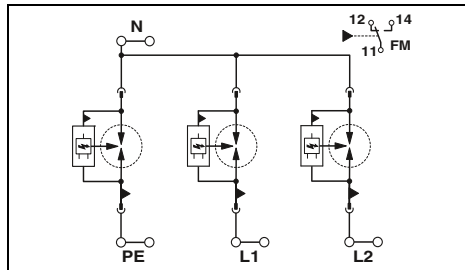

Technical data

I / II, T1 / T2
240/415 V AC (TN-S) /
240/415 V AC (TT)
L-N / L-PE / N-PE
350 V AC
25 kA / 25 kA / 100 kA
25 kA / 25 kA / 100 kA
50 kA / 50 kA / -
≤ 1.5 kV / ≤ 2.5 kV / ≤ 1.5 kV
50 kA / - / 100 A
≤ 100 ns
50 kA
315 A (gG)

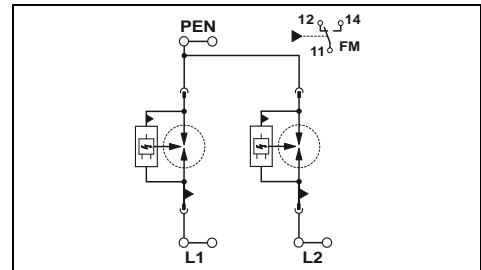

Technical data

I / II, T1 / T2
240/415 V AC (TN-C)
L-PEN
350 V AC
25 kA
25 kA
50 kA
≤ 1.5 kV
50 kA
≤ 100 ns
50 kA
315 A (gG)

Electrical data	
IEC test classification	
Nominal voltage U_N	
Mode of protection	
Maximum continuous operating voltage U_C	
Impulse discharge current I_{imp} (10/350) μ s	
Nominal discharge current I_n (8/20) μ s	
Max. discharge current I_{max} (8/20) μ s	
Protection level U_p	
Follow current interrupt rating I_{fi}	
Response time t_A	
Short-circuit current rating I_{SCCR}	
Maximum backup fuse for branch wiring	
General data	
Dimensions W/H/D	106.8 mm / 95.2 mm / 74.5 mm
IEC connection data	Rigid / flexible / AWG
UL connection data	AWG
Temperature range	3 ... 2
Test standards	-40°C ... 80°C
Remote indication contact	IEC 61643-11 / EN 61643-11
Remote indication contact	
IEC connection data	PDT contact
UL connection data	Rigid / flexible / AWG
Max. operating voltage	0.14 ... 1.5 mm ² / 0.14 ... 1.5 mm ² / 28 ... 16
Max. operating current	30 ... 14
	250 V AC / 125 V DC (200 mA DC)
	1 A AC / 1 A DC (30 V DC)

Ordering data		
Type	Order No.	Pcs./Pkt.
FLT-SEC-P-T1-2S-350/25-FM	2905418	1

Accessories		
FLT-SEC-P-T1-350/25-P	2905422	1
FLT-SEC-P-T1-N/PE-350/100-P	2905473	1

Ordering data		
Type	Order No.	Pcs./Pkt.
FLT-SEC-P-T1-2C-350/25-FM	2905416	1

Accessories		
FLT-SEC-P-T1-350/25-P	2905422	1

Description	
FLASHTRAB	
Replacement plug	
L-N/L-PEN	
N-PE	

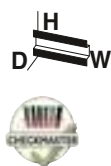

3-conductor system; L, N, PE

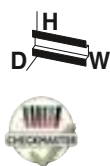

2-conductor system; L, PEN



N-PE spark gap

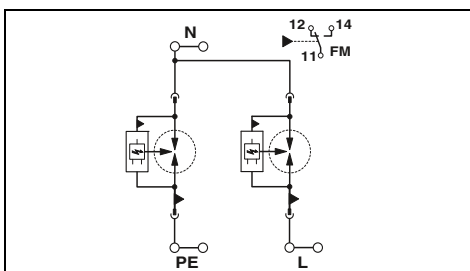

Technical data

I / II, T1 / T2
 240 V AC (TN-S) /
 240 V AC (TT)
 L-N / L-PE / N-PE
 350 V AC
 25 kA / 25 kA / 100 kA
 25 kA / 25 kA / 100 kA
 50 kA / 50 kA / -
 $\leq 1.5 \text{ kV} / \leq 2.5 \text{ kV} / \leq 1.5 \text{ kV}$
 50 kA / - / 100 A
 $\leq 100 \text{ ns}$
 50 kA
 315 A (gG)

71.2 mm / 95.2 mm / 74.5 mm
 2.5 ... 35 mm² / 2.5 ... 35 mm² / 13 ... 2
 3 ... 2
 -40°C ... 80°C
 IEC 61643-11 / EN 61643-11
 PDT contact
 0.14 ... 1.5 mm² / 0.14 ... 1.5 mm² / 28 ... 16
 30 ... 14
 250 V AC / 125 V DC (200 mA DC)
 1 A AC / 1 A DC (30 V DC)

Ordering data

Type	Order No.	Pcs./Pkt.
FLT-SEC-P-T1-1S-350/25-FM	2905415	1

Accessories

FLT-SEC-P-T1-350/25-P	2905422	1
FLT-SEC-P-T1-N/PE-350/100-P	2905473	1

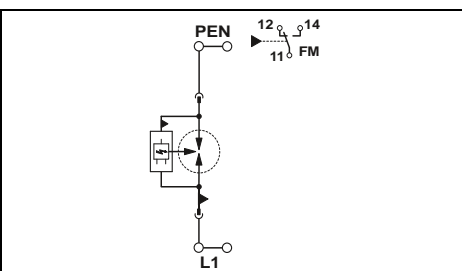

Technical data

I / II, T1 / T2
 240 V AC (TN-C) /
 240 V AC (TT)
 L-PEN
 350 V AC
 25 kA
 25 kA
 50 kA
 $\leq 1.5 \text{ kV}$
 50 kA
 $\leq 100 \text{ ns}$
 50 kA
 315 A (gG)

35.6 mm / 95.2 mm / 74.5 mm
 2.5 ... 35 mm² / 2.5 ... 35 mm² / 13 ... 2
 3 ... 2
 -40°C ... 80°C
 IEC 61643-11 / EN 61643-11
 PDT contact
 0.14 ... 1.5 mm² / 0.14 ... 1.5 mm² / 28 ... 16
 30 ... 14
 250 V AC / 125 V DC (200 mA DC)
 1 A AC / 1 A DC (30 V DC)

Ordering data

Type	Order No.	Pcs./Pkt.
FLT-SEC-P-T1-1C-350/25-FM	2905414	1

Accessories

FLT-SEC-P-T1-350/25-P	2905422	1
-----------------------	---------	---

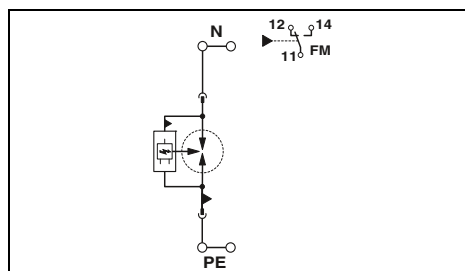

Technical data

I / II, T1 / T2
 240 V AC (TN - only N-PE) /
 240 V AC (TT - only N-PE)
 N-PE
 350 V AC
 100 kA
 100 kA
 -
 $\leq 1.5 \text{ kV}$
 100 A
 $\leq 100 \text{ ns}$
 -
 -

35.6 mm / 95.2 mm / 74.5 mm
 2.5 ... 35 mm² / 2.5 ... 35 mm² / 13 ... 2
 3 ... 2
 -40°C ... 80°C
 IEC 61643-11 / EN 61643-11
 PDT contact
 0.14 ... 1.5 mm² / 0.14 ... 1.5 mm² / 28 ... 16
 30 ... 14
 250 V AC / 125 V DC (200 mA DC)
 1 A AC / 1 A DC (30 V DC)

Ordering data

Type	Order No.	Pcs./Pkt.
FLT-SEC-P-T1-N/PE-350/100-FM	2905472	1

Accessories

FLT-SEC-P-T1-N/PE-350/100-P	2905473	1
-----------------------------	---------	---

Surge protection and interference suppression filters

Surge protection for the power supply

Type 1+2 combined lightning current and surge arrester FLASHTRAB SEC PLUS 264

- Spark gap has no line follow current
- Free of leakage current, suitable for use in the pre-meter area
- Pluggable
- High lightning impulse current of 50 kA per position
- Low voltage protection level of 2.5 kV
- Optical, mechanical status indicator
- With floating remote indication contact
- Plugs can be tested with CHECKMASTER 2



5-conductor system; L1, L2, L3, N, PE



4-conductor system; L1, L2, L3, PEN

Notes:
If only one value is specified under mode of protection in the technical data, this value is valid for all modes of protection specified.

ERC

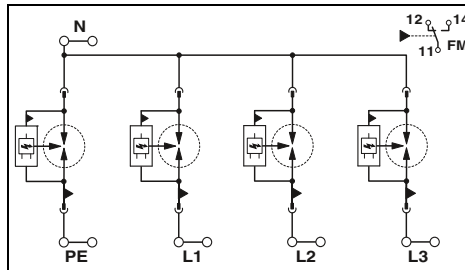

Technical data

I / II, T1 / T2
240/415 V AC (TN-S) /
240/415 V AC (TT)
L-N / L-PE / N-PE
264 V AC / 264 V AC / 350 V AC
50 kA / 50 kA / 100 kA
50 kA / 50 kA / 100 kA
100 kA
≤ 2.5 kV / ≤ 3 kV / ≤ 1.5 kV
50 kA / - / 100 A
≤ 100 ns
50 kA
500 A (gG)

ERC

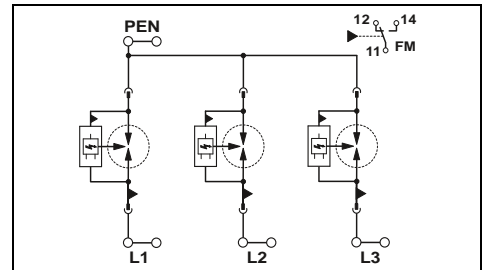

Technical data

I / II, T1 / T2
240/415 V AC (TN-C)
L-PEN
264 V AC
50 kA
50 kA
100 kA
≤ 2.5 kV
50 kA
≤ 100 ns
50 kA
500 A (gG)

Electrical data	
IEC test classification	
Nominal voltage U_N	
Mode of protection	
Maximum continuous operating voltage U_C	
Impulse discharge current I_{imp} (10/350) μ s	
Nominal discharge current I_n (8/20) μ s	
Max. discharge current I_{max} (8/20) μ s	
Protection level U_p	
Follow current interrupt rating I_f	
Response time t_A	
Short-circuit current rating I_{SCCR}	
Maximum backup fuse for branch wiring	
General data	
Dimensions W/H/D	142.4 mm / 95.2 mm / 74.5 mm
IEC connection data	Rigid / flexible / AWG 2.5 ... 35 mm ² / 2.5 ... 35 mm ² / 13 ... 2
UL connection data	AWG 3 ... 2
Temperature range	-40°C ... 80°C
Test standards	IEC 61643-11 / EN 61643-11
Remote indication contact	PDT contact
IEC connection data	Rigid / flexible / AWG 0.14 ... 1.5 mm ² / 0.14 ... 1.5 mm ² / 28 ... 16
UL connection data	AWG 30 ... 14
Max. operating voltage	250 V AC / 125 V DC (200 mA DC)
Max. operating current	1 A AC / 1 A DC (30 V DC)

Ordering data

Type	Order No.	Pcs./Pkt.
FLT-SEC-P-T1-3S-264/50-FM	2909589	1

Accessories

FLT-SEC-P-T1-264/50-P	2907391	5
FLT-SEC-P-T1-N/PE-350/100-P	2905473	1

Ordering data

Type	Order No.	Pcs./Pkt.
FLT-SEC-P-T1-3C-264/50-FM	2907390	1

Accessories

FLT-SEC-P-T1-264/50-P	2907391	5
-----------------------	---------	---

Description	
FLASHTRAB	
Replacement plug	
L-N/L-PEN	5
N-PE	1

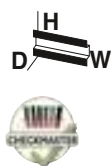

3-conductor system; L, N, PE

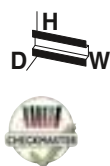

2-conductor system; L, PEN



N-PE spark gap

ERC

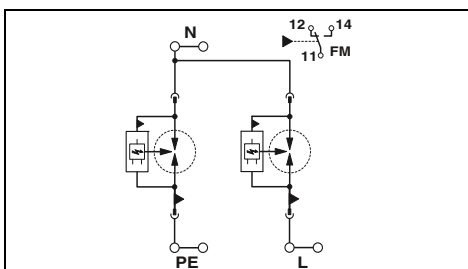

Technical data

I / II, T1 / T2
 240 V AC (TN-S) /
 240 V AC (TT)
 L-N / L-PE / N-PE
 264 V AC / 264 V AC / 350 V AC
 50 kA / 50 kA / 100 kA
 50 kA / 50 kA / 100 kA
 100 kA
 $\leq 2.5 \text{ kV} / \leq 3 \text{ kV} / \leq 1.5 \text{ kV}$
 50 kA / - / 100 A
 $\leq 100 \text{ ns}$
 50 kA
 500 A (gG)

71.2 mm / 95.2 mm / 74.5 mm
 2.5 ... 35 mm² / 2.5 ... 35 mm² / 13 ... 2
 3 ... 2
 -40°C ... 80°C
 IEC 61643-11 / EN 61643-11
 PDT contact
 0.14 ... 1.5 mm² / 0.14 ... 1.5 mm² / 28 ... 16
 30 ... 14
 250 V AC / 125 V DC (200 mA DC)
 1 A AC / 1 A DC (30 V DC)

Ordering data

Type	Order No.	Pcs./Pkt.
FLT-SEC-P-T1-1S-264/50-FM	2907388	1

Accessories

FLT-SEC-P-T1-264/50-P	2907391	5
FLT-SEC-P-T1-N/PE-350/100-P	2905473	1

ERC

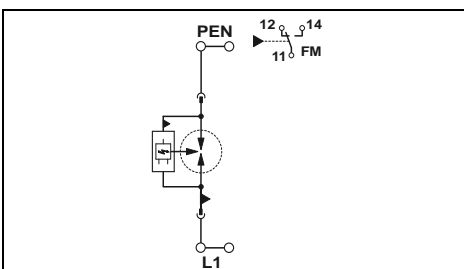

Technical data

I / II, T1 / T2
 240 V AC (TN-C) /
 240 V AC (TT)
 L-PEN
 264 V AC
 50 kA
 50 kA
 100 kA
 $\leq 2.5 \text{ kV}$
 50 kA
 $\leq 100 \text{ ns}$
 50 kA
 500 A (gG)

35.6 mm / 95.2 mm / 74.5 mm
 2.5 ... 35 mm² / 2.5 ... 35 mm² / 13 ... 2
 3 ... 2
 -40°C ... 80°C
 IEC 61643-11 / EN 61643-11
 PDT contact
 0.14 ... 1.5 mm² / 0.14 ... 1.5 mm² / 28 ... 16
 30 ... 14
 250 V AC / 125 V DC (200 mA DC)
 1 A AC / 1 A DC (30 V DC)

Ordering data

Type	Order No.	Pcs./Pkt.
FLT-SEC-P-T1-1C-264/50-FM	2907387	1

Accessories

FLT-SEC-P-T1-264/50-P	2907391	5
-----------------------	---------	---

ERC KEBA CB

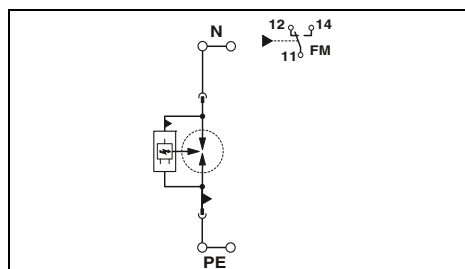

Technical data

I / II, T1 / T2
 240 V AC (TN - only N-PE) /
 240 V AC (TT - only N-PE)
 N-PE
 350 V AC
 100 kA
 100 kA
 -
 $\leq 1.5 \text{ kV}$
 100 A
 $\leq 100 \text{ ns}$
 -
 -

35.6 mm / 95.2 mm / 74.5 mm
 2.5 ... 35 mm² / 2.5 ... 35 mm² / 13 ... 2
 3 ... 2
 -40°C ... 80°C
 IEC 61643-11 / EN 61643-11
 PDT contact
 0.14 ... 1.5 mm² / 0.14 ... 1.5 mm² / 28 ... 16
 30 ... 14
 250 V AC / 125 V DC (200 mA DC)
 1 A AC / 1 A DC (30 V DC)

Ordering data

Type	Order No.	Pcs./Pkt.
FLT-SEC-P-T1-N/PE-350/100-FM	2905472	1

Accessories

FLT-SEC-P-T1-N/PE-350/100-P	2905473	1
-----------------------------	---------	---

Surge protection and interference suppression filters

Surge protection for the power supply

Type 1+2 combined lightning current and surge arrester special FLASHTRAB SEC T1+T2

- Directly coordinated combination of type 1 spark gap without line follow current and type 2 varistor arrester
- Particularly suitable for maximum protection of sensitive devices in harsh environments
- Pluggable
- High continuous voltage of 350 V AC for 230/400 V AC networks with high voltage fluctuations
- Low voltage protection level of 1.5 kV
- Optical, mechanical status indicator
- With floating remote indication contact
- Plugs can be tested with CHECKMASTER 2



5-conductor system; L1, L2, L3, N, PE



4-conductor system; L1, L2, L3, PEN

Notes:
If only one value is specified under mode of protection in the technical data, this value is valid for all modes of protection specified.

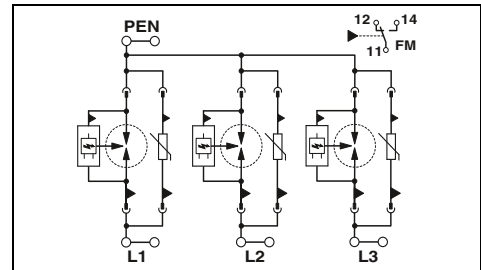
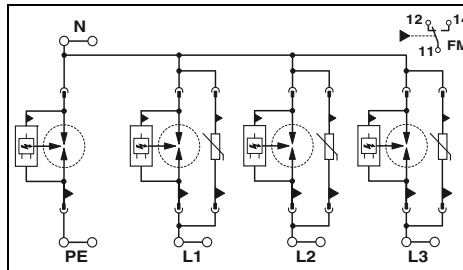

Electrical data

IEC test classification	
Nominal voltage U_N	
Mode of protection	
Maximum continuous operating voltage U_C	
Impulse discharge current I_{imp} (10/350) μ s	
Nominal discharge current I_n (8/20) μ s	
Protection level U_p	
Follow current interrupt rating I_{fi}	
Response time t_A	
Short-circuit current rating I_{SCCR}	
Maximum backup fuse for branch wiring	

Technical data

I + II, T1 + T2	
240/415 V AC (TN-S) /	
240/415 V AC (TT)	
L-N / L-PE / N-PE	
350 V AC	
25 kA / 25 kA / 100 kA	
25 kA / 25 kA / 100 kA	
≤ 1.5 kV / ≤ 2.2 kV / ≤ 1.5 kV	
25 kA (264 V AC) / - / 100 A (350 V AC)	
≤ 25 ns / ≤ 100 ns / ≤ 100 ns	
25 kA (264 V AC)	
315 A (gG)	

Technical data

I + II, T1 + T2	
240/415 V AC (TN-C)	
L-PEN	
350 V AC	
25 kA	
25 kA	
≤ 1.5 kV	
25 kA (264 V AC)	
≤ 25 ns	
25 kA (264 V AC)	
315 A (gG)	

General data

Dimensions W/H/D	
IEC connection data	Rigid / flexible / AWG
UL connection data	AWG
Temperature range	
Test standards	
Remote indication contact	
IEC connection data	Rigid / flexible / AWG
UL connection data	AWG
Max. operating voltage	
Max. operating current	

142.4 mm / 95.2 mm / 74.5 mm	
2.5 ... 35 mm ² / 2.5 ... 35 mm ² / 13 ... 2	
3 ... 2	
-40°C ... 80°C	
IEC 61643-11 / EN 61643-11	
PDT contact	
0.14 ... 1.5 mm ² / 0.14 ... 1.5 mm ² / 28 ... 16	
30 ... 14	
250 V AC / 125 V DC (200 mA DC)	
1 A AC / 1 A DC (30 V DC)	

106.8 mm / 95.2 mm / 74.5 mm	
2.5 ... 2.5 mm ² / 2.5 ... 35 mm ² / 13 ... 2	
3 ... 2	
-40°C ... 80°C	
IEC 61643-11 / EN 61643-11	
PDT contact	
0.14 ... 1.5 mm ² / 0.14 ... 1.5 mm ² / 28 ... 16	
30 ... 14	
250 V AC / 125 V DC (200 mA DC)	
1 A AC / 1 A DC (30 V DC)	

Description

Type	Order No.	Pcs./Pkt.
Type 1+2 combined lightning current and surge arrester special		
FLT-SEC-T1+T2-3S-350/25-FM	2905470	1

Ordering data

Type	Order No.	Pcs./Pkt.
FLT-SEC-T1+T2-3S-350/25-FM	2905470	1

Ordering data

Type	Order No.	Pcs./Pkt.
FLT-SEC-T1+T2-3C-350/25-FM	2905469	1

Replacement plug

L-N/L-PEN	FLT-SEC-T1-350/25-P	2905471	1
L-N/L-PEN	VAL-SEC-T2-350-P	2905346	1
N-PE	FLT-SEC-P-T1-N/PE-350/100-P	2905473	1

Accessories

L-N/L-PEN	FLT-SEC-T1-350/25-P	2905471	1
L-N/L-PEN	VAL-SEC-T2-350-P	2905346	1
N-PE	FLT-SEC-P-T1-N/PE-350/100-P	2905473	1

Accessories

L-N/L-PEN	FLT-SEC-T1-350/25-P	2905471	1
L-N/L-PEN	VAL-SEC-T2-350-P	2905346	1

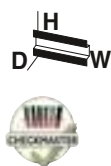

4-conductor system; L1, L2, N, PE

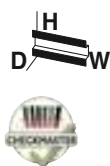

3-conductor system; L1, L2, PEN



3-conductor system; L, N, PE

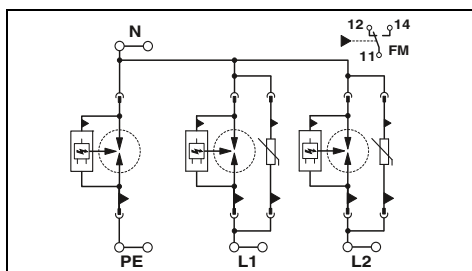

Technical data

I + II, T1 + T2
 240/415 V AC (TN-S) /
 240/415 V AC (TT)
 L-N / L-PE / N-PE
 350 V AC
 25 kA / 25 kA / 100 kA
 25 kA / 25 kA / 100 kA
 $\leq 1.5 \text{ kV} / \leq 2.2 \text{ kV} / \leq 1.5 \text{ kV}$
 25 kA (264 V AC) / - / 100 A (350 V AC)
 $\leq 25 \text{ ns} / - / \leq 100 \text{ ns}$
 25 kA (264 V AC)
 315 A (gG)

106.8 mm / 95.2 mm / 74.5 mm
 2.5 ... 35 mm² / 2.5 ... 35 mm² / 13 ... 2

3 ... 2
 -40°C ... 80°C
 IEC 61643-11 / EN 61643-11

PDT contact
 0.14 ... 1.5 mm² / 0.14 ... 1.5 mm² / 28 ... 16
 30 ... 14
 250 V AC / 125 V DC (200 mA DC)
 1 A AC / 1 A DC (30 V DC)

Ordering data

Type	Order No.	Pcs./Pkt.
FLT-SEC-T1+T2-2S-350/25-FM	2905468	1

Accessories

FLT-SEC-T1-350/25-P	2905471	1
VAL-SEC-T2-350-P	2905346	1
FLT-SEC-P-T1-N/PE-350/100-P	2905473	1

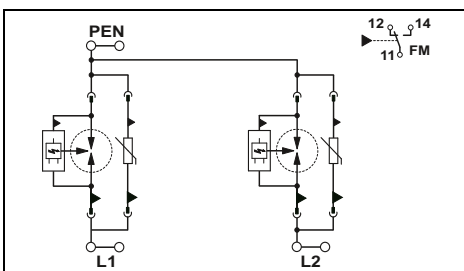

Technical data

I + II, T1 + T2
 240/415 V AC (TN-C)
 L-PEN
 350 V AC
 25 kA
 25 kA
 $\leq 1.5 \text{ kV}$
 25 kA (264 V AC)
 $\leq 25 \text{ ns}$
 25 kA (264 V AC)
 315 A (gG)

71.2 mm / 95.2 mm / 74.5 mm
 2.5 ... 35 mm² / 2.5 ... 35 mm² / 13 ... 2

3 ... 2
 -40°C ... 80°C
 IEC 61643-11 / EN 61643-11

PDT contact
 0.14 ... 1.5 mm² / 0.14 ... 1.5 mm² / 28 ... 16
 30 ... 14
 250 V AC / 125 V DC (200 mA DC)
 1 A AC / 1 A DC (30 V DC)

Ordering data

Type	Order No.	Pcs./Pkt.
FLT-SEC-T1+T2-2C-350/25-FM	2905467	1

Accessories

FLT-SEC-T1-350/25-P	2905471	1
VAL-SEC-T2-350-P	2905346	1

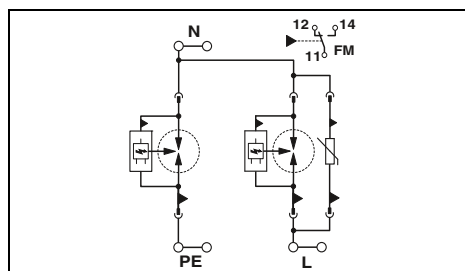

Technical data

I + II, T1 + T2
 240 V AC (TN-S) /
 240 V AC (TT)
 L-N / L-PE / N-PE
 350 V AC
 25 kA / 25 kA / 100 kA
 25 kA / 25 kA / 100 kA
 $\leq 1.5 \text{ kV} / \leq 2.2 \text{ kV} / \leq 1.5 \text{ kV}$
 25 kA (264 V AC) / - / 100 A (350 V AC)
 $\leq 25 \text{ ns} / - / \leq 100 \text{ ns}$
 25 kA (264 V AC)
 315 A (gG)

71.2 mm / 95.2 mm / 74.5 mm
 2.5 ... 35 mm² / 2.5 ... 35 mm² / 13 ... 2

3 ... 2
 -40°C ... 80°C
 IEC 61643-11 / EN 61643-11

PDT contact
 0.14 ... 1.5 mm² / 0.14 ... 1.5 mm² / 28 ... 16
 30 ... 14
 250 V AC / 125 V DC (200 mA DC)
 1 A AC / 1 A DC (30 V DC)

Ordering data

Type	Order No.	Pcs./Pkt.
FLT-SEC-T1+T2-1S-350/25-FM	2905466	1

Accessories

FLT-SEC-T1-350/25-P	2905471	1
VAL-SEC-T2-350-P	2905346	1
FLT-SEC-P-T1-N/PE-350/100-P	2905473	1

Surge protection and interference suppression filters

Surge protection for the power supply

Type 1+2 combined lightning current and surge arrester special FLASHTRAB SEC T1+T2

- Directly coordinated combination of type 1 spark gap without line follow current and type 2 varistor arrester
- Particularly suitable for maximum protection of sensitive devices in harsh environments
- Pluggable
- High continuous voltage of 350 V AC for 230/400 V AC networks with high voltage fluctuations
- Low voltage protection level of 1.5 kV
- Optical, mechanical status indicator
- With floating remote indication contact
- Plugs can be tested with CHECKMASTER 2



2-conductor system; L, PEN



N-PE spark gap



Notes:
If only one value is specified under mode of protection in the technical data, this value is valid for all modes of protection specified.

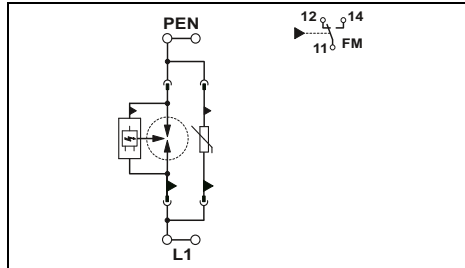

Technical data

I + II, T1 + T2
240 V AC (TN-C) /
240 V AC (TT)
L-PEN
350 V AC
25 kA
25 kA
≤ 1.5 kV
25 kA (264 V AC)
≤ 25 ns
25 kA (264 V AC)
315 A (gG)

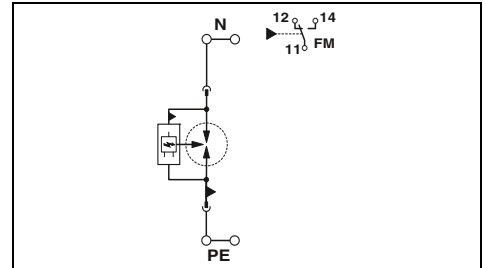

Technical data

I / II, T1 / T2
240 V AC (TN - only N-PE) /
240 V AC (TT - only N-PE)
N-PE
350 V AC
100 kA
100 kA
≤ 1.5 kV
100 A
≤ 100 ns
-
-

Electrical data	
IEC test classification	
Nominal voltage U_N	
Mode of protection	
Maximum continuous operating voltage U_C	
Impulse discharge current I_{imp} (10/350) μ s	
Nominal discharge current I_n (8/20) μ s	
Protection level U_p	
Follow current interrupt rating I_{fi}	
Response time t_A	
Short-circuit current rating I_{SCCR}	
Maximum backup fuse for branch wiring	
General data	
Dimensions W/H/D	
IEC connection data	Rigid / flexible / AWG
UL connection data	AWG
Temperature range	
Test standards	
Remote indication contact	
IEC connection data	Rigid / flexible / AWG
UL connection data	AWG
Max. operating voltage	
Max. operating current	

Technical data	
I + II, T1 + T2	
240 V AC (TN-C) / 240 V AC (TT)	
L-PEN	
350 V AC	
25 kA	
25 kA	
≤ 1.5 kV	
25 kA (264 V AC)	
≤ 25 ns	
25 kA (264 V AC)	
315 A (gG)	
General data	
Dimensions W/H/D	
2.5 ... 35 mm ² / 2.5 ... 35 mm ² / 13 ... 2	
3 ... 2	
-40°C ... 80°C	
IEC 61643-11 / EN 61643-11	
Remote indication contact	
PDT contact	
0.14 ... 1.5 mm ² / 0.14 ... 1.5 mm ² / 28 ... 16	
30 ... 14	
250 V AC / 125 V DC (200 mA DC)	
1 A AC / 1 A DC (30 V DC)	

Technical data	
I / II, T1 / T2	
240 V AC (TN - only N-PE) / 240 V AC (TT - only N-PE)	
N-PE	
350 V AC	
100 kA	
100 kA	
≤ 1.5 kV	
100 A	
≤ 100 ns	
-	
-	
General data	
Dimensions W/H/D	
2.5 ... 35 mm ² / 2.5 ... 35 mm ² / 13 ... 2	
3 ... 2	
-40°C ... 80°C	
IEC 61643-11 / EN 61643-11	
Remote indication contact	
PDT contact	
0.14 ... 1.5 mm ² / 0.14 ... 1.5 mm ² / 28 ... 16	
30 ... 14	
250 V AC / 125 V DC (200 mA DC)	
1 A AC / 1 A DC (30 V DC)	

Description	
Type 1+2 combined lightning current and surge arrester special	

Ordering data		
Type	Order No.	Pcs./Pkt.
FLT-SEC-T1+T2-1C-350/25-FM	2905465	1

Ordering data		
Type	Order No.	Pcs./Pkt.
FLT-SEC-P-T1-N/PE-350/100-FM	2905472	1

Replacement plug	
L-N/L-PEN	
L-N/L-PEN	
N-PE	

Accessories		
FLT-SEC-T1-350/25-P	2905471	1
VAL-SEC-T2-350-P	2905346	1

Accessories		
FLT-SEC-P-T1-N/PE-350/100-P	2905473	1

T1+T2 combined lightning current and surge arrester FLASHTRAB SEC ZP

- Complete module for direct mounting on 40 mm busbar systems
- Fits in every distribution board, thanks to extremely narrow overall width of just 47 mm
- Spark gap has no line follow current
- Free of leakage current, suitable for use in the pre-meter area
- Low voltage protection level of 1.5 kV L-N/N-PE and 2 kV L-PE
- Test button for electrical status indicator
- Tool-free and secure attachment to 5 and 10 mm thick rails, thanks to universal interlock
- Satisfies all requirements for the installation of surge protection in accordance with DIN VDE 0100-534

new

new



5-conductor system; L1, L2, L3, N, PE



4-conductor system; L1, L2, L3, PEN

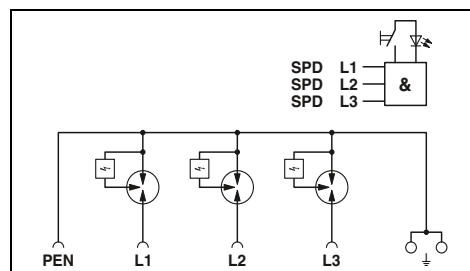
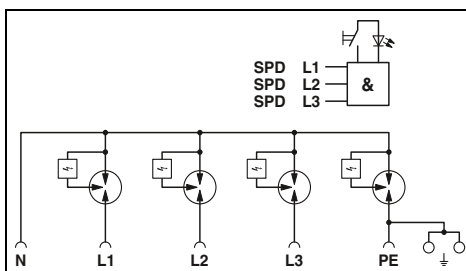

Technical data

... 3S...12,5	... 3S...7,5
I + II, T1 + T2	I + II, T1 + T2
230/400 V AC (TN-S) / 230/400 V AC (TT)	230/400 V AC (TN-S) / 230/400 V AC (TT)
L-N / L-PE / N-PE	L-N / L-PE / N-PE
255 V AC	255 V AC
12.5 kA / 12.5 kA / 50 kA	7.5 kA / 7.5 kA / 30 kA
20 kA / 20 kA / 80 kA	20 kA / 20 kA / 80 kA
≤ 1.5 kV / ≤ 2 kV / ≤ 1.5 kV	≤ 1.5 kV / ≤ 2 kV / ≤ 1.5 kV
25 kA / 25 kA / 100 A	25 kA / 25 kA / 100 A
≤ 100 ns	≤ 100 ns
25 kA	25 kA
250 A (gG)	250 A (gG)

Technical data

... 3C...12,5	... 3C...7,5
I + II, T1 + T2	I + II, T1 + T2
230/400 V AC (TN-C)	230/400 V AC (TN-C)
L-PEN	L-PEN
255 V AC	255 V AC
12.5 kA	7.5 kA
20 kA	20 kA
≤ 1.5 kV	≤ 1.5 kV
25 kA	25 kA
≤ 100 ns	≤ 100 ns
25 kA	25 kA
250 A (gG)	250 A (gG)

Electrical data	
IEC test classification	
Nominal voltage U_N	
Mode of protection	
Maximum continuous operating voltage U_C	
Impulse discharge current I_{imp} (10/350) μ s	
Nominal discharge current I_n (8/20) μ s	
Protection level U_p	
Follow current interrupt rating I_{fi}	
Response time t_A	
Short-circuit current rating I_{SCCR}	
Maximum backup fuse for branch wiring	

General data	
Dimensions W/H/D	47 mm / 223.2 mm / 110.7 mm
IEC connection data	2.5 ... 35 mm ² / 2.5 ... 35 mm ² / -
UL connection data	-
Temperature range	-40°C ... 80°C
Test standards	IEC 61643-11 / EN 61643-11

General data	
Dimensions W/H/D	47 mm / 223.2 mm / 110.7 mm
IEC connection data	2.5 ... 35 mm ² / 2.5 ... 35 mm ² / -
UL connection data	-
Temperature range	-40°C ... 80°C
Test standards	IEC 61643-11 / EN 61643-11

Ordering data

Type	Order No.	Pcs./Pkt.
FLASHTRAB		
$I_{imp} = 12.5$ kA		
$I_{imp} = 7.5$ kA		
FLT-SEC-ZP-3S-255/12,5	1032207	1
FLT-SEC-ZP-3S-255/7,5	1074741	1

Ordering data

Type	Order No.	Pcs./Pkt.
FLASHTRAB		
$I_{imp} = 12.5$ kA		
$I_{imp} = 7.5$ kA		
FLT-SEC-ZP-3C-255/12,5	1032204	1
FLT-SEC-ZP-3C-255/7,5	1074739	1

Surge protection and interference suppression filters

Surge protection for the power supply

Type 1+2 combined lightning current and surge arrester VALVETRAB MS

- Seamless pluggability (even for N/PE spark gap)
- Secure hold of plugs in the event of high lightning current loads and strong vibration, thanks to new latching
- Thermal disconnect device for each individual plug
- Optical, mechanical status indication for the individual arresters
- With or without floating remote indication contact
- Mechanical coding of all slots
- Plugs can be tested with CHECKMASTER 2



5-conductor system; L1, L2, L3, N, PE
(3+1 circuit)



5-conductor system; L1, L2, L3, N, PE
(4+0 circuit)

Notes:
If only one value is specified under mode of protection in the technical data, this value is valid for all modes of protection specified.

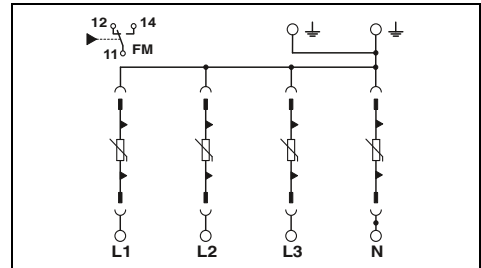
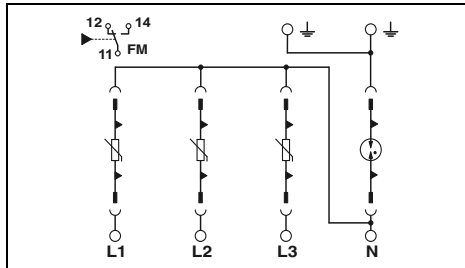

Electrical data	
IEC test classification	...335
Nominal voltage U_N	I / II, T1 / T2 240/415 V AC (TN-S) / 240/415 V AC (TT)
Mode of protection	
Maximum continuous operating voltage U_C	L-N / L-PE / N-PE 335 V AC / 335 V AC / 264 V AC
Impulse discharge current I_{imp} (10/350) μ s	12.5 kA / 12.5 kA / 50 kA
Nominal discharge current I_n (8/20) μ s	12.5 kA / 12.5 kA / 50 kA
Max. discharge current I_{max} (8/20) μ s	50 kA
Protection level U_p	≤ 1.2 kV / ≤ 2 kV / ≤ 1.7 kV
Response time t_A	≤ 25 ns / ≤ 100 ns / ≤ 100 ns
Short-circuit current rating I_{SCCR}	25 kA
Maximum backup fuse for branch wiring	160 A (gG)

Technical data

Technical data

General data	
Dimensions W/H/D	71.2 mm / 98.7 mm / 77.5 mm
IEC connection data	Rigid / flexible / AWG 1.5 ... 35 mm ² / 1.5 ... 25 mm ² / 15 ... 2
UL connection data	AWG 10 ... 2
Temperature range	-40°C ... 80°C
Test standards	IEC 61643-11 / EN 61643-11
Remote indication contact	
IEC connection data	Rigid / flexible / AWG 0.14 ... 1.5 mm ² / 0.14 ... 1.5 mm ² / 28 ... 16
UL connection data	AWG 30 ... 14
Max. operating voltage	250 V AC / 30 V DC
Max. operating current	1.5 A AC / 1 A DC

General data	
Dimensions W/H/D	71.2 mm / 98.7 mm / 77.5 mm
IEC connection data	Rigid / flexible / AWG 1.5 ... 35 mm ² / 1.5 ... 25 mm ² / 15 ... 2
UL connection data	AWG 10 ... 2
Temperature range	-40°C ... 80°C
Test standards	IEC 61643-11 / EN 61643-11
Remote indication contact	
IEC connection data	Rigid / flexible / AWG 0.14 ... 1.5 mm ² / 0.14 ... 1.5 mm ² / 28 ... 16
UL connection data	AWG 30 ... 14
Max. operating voltage	250 V AC / 30 V DC
Max. operating current	1.5 A AC / 1 A DC

Description		U_C
VALVETRAB-MS , varistor-based lightning current arrester		
with remote indication contact		335 V AC
without remote indication contact		335 V AC

Ordering data

Ordering data

Type	Order No.	Pcs./Pkt.
VAL-MS-T1/T2 335/12.5/3+1-FM	2800183	1
VAL-MS-T1/T2 335/12.5/3+1	2800184	1

Type	Order No.	Pcs./Pkt.
VAL-MS-T1/T2 335/12.5/4+0-FM	2800644	1
VAL-MS-T1/T2 335/12.5/4+0	2800645	1

Replacement plug	
335 V AC	L-N/L-PEN N-PE

Accessories

Accessories

Type	Order No.	Pcs./Pkt.
VAL-MS-T1/T2 335/12.5 ST	2800190	10
F-MS-T1/T2 50 ST	2800191	10

Type	Order No.	Pcs./Pkt.
VAL-MS-T1/T2 335/12.5 ST	2800190	10

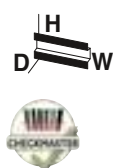

4-conductor system; L1, L2, L3, PEN



3-conductor system; L, N, PE



2-conductor system; L, N, PEN

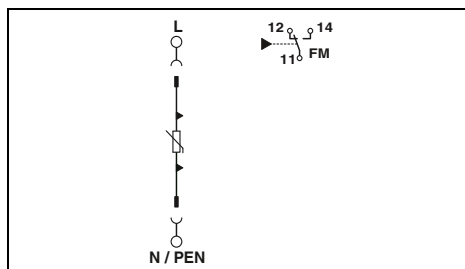
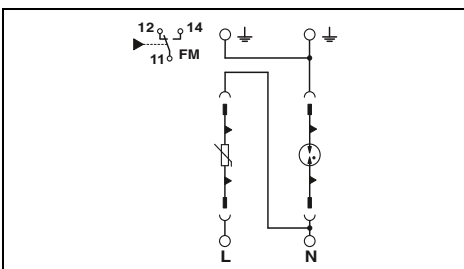
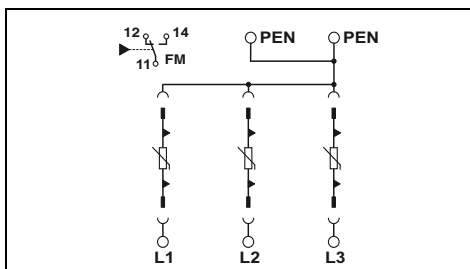

Technical data

Technical data

Technical data

...335
I / II, T1 / T2
240/415 V AC (TN-C)

L-PEN
335 V AC
12.5 kA
12.5 kA
50 kA
≤ 1.2 kV / ≤ 1.6 kV (30 kA - 8/20 μs)
≤ 25 ns
25 kA
160 A (gG)

...335
I / II, T1 / T2
240 V AC (TN-S) /
240 V AC (TT)
L-N / L-PE / N-PE
335 V AC / 335 V AC / 264 V AC
12.5 kA / 12.5 kA / 50 kA
12.5 kA / 12.5 kA / 50 kA
50 kA
≤ 1.2 kV / ≤ 2 kV / ≤ 1.7 kV
≤ 25 ns / ≤ 100 ns / ≤ 100 ns
25 kA
160 A (gG)

...335
I / II, T1 / T2
240 V AC (TN-C, TN-S) /
240 V AC (TT)
L-N / L-PEN
335 V AC
12.5 kA
12.5 kA
50 kA
≤ 1.2 kV / ≤ 1.6 kV (30 kA - 8/20 μs)
≤ 25 ns
25 kA
160 A (gG)

53.4 mm / 98.7 mm / 77.5 mm
1.5 ... 35 mm² / 1.5 ... 25 mm² / 15 ... 2

35.6 mm / 96.8 mm / 77.5 mm
1.5 ... 35 mm² / 1.5 ... 25 mm² / 15 ... 2

17.6 mm / 96.8 mm / 77.5 mm
1.5 ... 35 mm² / 1.5 ... 25 mm² / 15 ... 2

10 ... 2
-40°C ... 80°C
IEC 61643-11 / EN 61643-11

10 ... 2
-40°C ... 80°C
IEC 61643-11 / EN 61643-11

-
-40°C ... 80°C
IEC 61643-11 / EN 61643-11

PDT contact
0.14 ... 1.5 mm² / 0.14 ... 1.5 mm² / 28 ... 16
30 ... 14
250 V AC / 30 V DC
1.5 A AC / 1 A DC

PDT contact
0.14 ... 1.5 mm² / 0.14 ... 1.5 mm² / 28 ... 16
30 ... 14
250 V AC / 30 V DC
1.5 A AC / 1 A DC

PDT contact
0.14 ... 1.5 mm² / 0.14 ... 1.5 mm² / 28 ... 16
-
250 V AC / 30 V DC
1 A AC / 1 A DC

Ordering data

Ordering data

Ordering data

Type	Order No.	Pcs./Pkt.
VAL-MS-T1/T2 335/12.5/3+0-FM	2800188	1
VAL-MS-T1/T2 335/12.5/3+0	2800189	1

Type	Order No.	Pcs./Pkt.
VAL-MS-T1/T2 335/12.5/1+1-FM	2800186	1
VAL-MS-T1/T2 335/12.5/1+1	2800187	1

Type	Order No.	Pcs./Pkt.
VAL-MS-T1/T2 335/12.5/1+0-FM	2801042	1
VAL-MS-T1/T2 335/12.5/1+0	2801041	1

Accessories

Accessories

Accessories

VAL-MS-T1/T2 335/12.5 ST	2800190	10
--------------------------	---------	----

VAL-MS-T1/T2 335/12.5 ST	2800190	10
F-MS-T1/T2 50 ST	2800191	10

VAL-MS-T1/T2 335/12.5 ST	2800190	10
--------------------------	---------	----

Surge protection and interference suppression filters

Surge protection for the power supply

Type 1+2 combined lightning current and surge arrester VALVETRAB MS

- Universal pluggability
- Thermal disconnect device for each individual plug
- Optical, mechanical status indication for the individual arresters
- With or without floating remote indication contact
- Mechanical coding of all slots
- Plugs can be tested with CHECKMASTER 2



2-conductor system; L, PEN



3-conductor system; L, N, PE



Notes:
If only one value is specified under mode of protection in the technical data, this value is valid for all modes of protection specified.

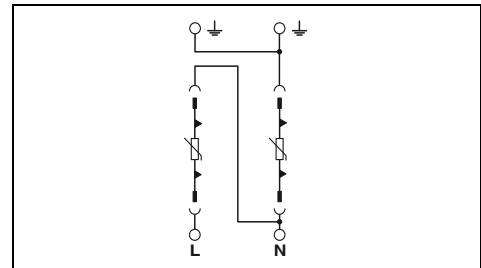
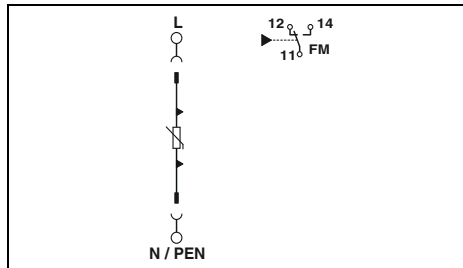

Technical data

Electrical data	
IEC test classification	I / II, T1 / T2
Nominal voltage U_N	60 V AC (TN)
Mode of protection	L-N / L-PEN / (L+) - (L-) / (L-) - PE / (L+) - PE
Maximum continuous operating voltage U_C	75 V AC / 100 V DC
Impulse discharge current I_{imp} (10/350) μ s	12.5 kA
Nominal discharge current I_n (8/20) μ s	12.5 kA
Max. discharge current I_{max} (8/20) μ s	30 kA
Protection level U_p	≤ 0.4 kV
Response time t_A	≤ 25 ns
Short-circuit current rating I_{SCCR}	25 kA
Maximum backup fuse for branch wiring	160 A (gG)
General data	
Dimensions W/H/D	17.6 mm / 96.8 mm / 77.5 mm
IEC connection data	Rigid / flexible / AWG 1.5 ... 35 mm ² / 1.5 ... 25 mm ² / 15 ... 2
UL connection data	AWG 10 ... 2
Temperature range	-40°C ... 80°C
Test standards	IEC 61643-11 / EN 61643-11
Remote indication contact	PDT contact
IEC connection data	Rigid / flexible / AWG 0.14 ... 1.5 mm ² / 0.14 ... 1.5 mm ² / 28 ... 16
UL connection data	AWG 30 ... 14
Max. operating voltage	250 V AC / 125 V DC (200 mA DC)
Max. operating current	1.5 A AC / 1 A DC (30 V DC)

Electrical data	
IEC test classification	I / II, T1 / T2
Nominal voltage U_N	60 V AC (TN-S)
Mode of protection	L-N / L-PE / N-PE / (L+) - (L-) / (L+) - PE / (L-) - PE
Maximum continuous operating voltage U_C	75 V AC / 100 V DC
Impulse discharge current I_{imp} (10/350) μ s	12.5 kA
Nominal discharge current I_n (8/20) μ s	12.5 kA
Max. discharge current I_{max} (8/20) μ s	30 kA
Protection level U_p	≤ 0.4 kV / ≤ 0.8 kV / ≤ 0.4 kV / ≤ 0.4 kV / ≤ 0.4 kV / ≤ 0.8 kV
Response time t_A	≤ 25 ns
Short-circuit current rating I_{SCCR}	25 kA
Maximum backup fuse for branch wiring	160 A (gG)
General data	
Dimensions W/H/D	35.6 mm / 96.8 mm / 77.5 mm
IEC connection data	Rigid / flexible / AWG 1.5 ... 35 mm ² / 1.5 ... 25 mm ² / 15 ... 2
UL connection data	AWG 10 ... 2
Temperature range	-40°C ... 80°C
Test standards	IEC 61643-11 / EN 61643-11
Remote indication contact	PDT contact
IEC connection data	Rigid / flexible / AWG 0.14 ... 1.5 mm ² / 0.14 ... 1.5 mm ² / 28 ... 16
UL connection data	AWG 30 ... 14
Max. operating voltage	250 V AC / 125 V DC (200 mA DC)
Max. operating current	1.5 A AC / 1 A DC (30 V DC)

Ordering data

Description	Type	Order No.	Pcs./Pkt.
VALVETRAB-MS , varistor-based lightning current arrester			
with remote indication contact	VAL-MS-T1/T2 48/12.5/1+0-FM	2801240	1
without remote indication contact	VAL-MS-T1/T2 48/12.5/1+0	2801241	1

Description	Type	Order No.	Pcs./Pkt.
VALVETRAB-MS , varistor-based lightning current arrester			
with remote indication contact	VAL-MS-T1/T2 48/12.5/1+1V-FM	2801533	1
without remote indication contact	VAL-MS-T1/T2 48/12.5/1+1V	2801532	1

Accessories

Replacement plug	Type	Order No.	Pcs./Pkt.
L-N/N-PE/(L+) - (L-)/(L+) - PE	VAL-MS-T1/T2 48/12.5 ST	2801242	10

Replacement plug	Type	Order No.	Pcs./Pkt.
L-N/N-PE/(L+) - (L-)/(L+) - PE	VAL-MS-T1/T2 48/12.5 ST	2801242	10

Type 1+2 combined lightning current and surge arrester VALVETRAB MS

- Universal pluggability
- Suitable for 19" applications with rackmount systems
- Thermal disconnect device for each individual plug
- Optical, mechanical status indication for the individual arresters
- With or without floating remote indication contact
- Mechanical coding of all slots
- Plugs can be tested with CHECKMASTER 2

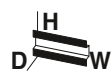

2-conductor system; L, PEN



3-conductor system; L, N, PE

Notes:

If only one value is specified under mode of protection in the technical data, this value is valid for all modes of protection specified.

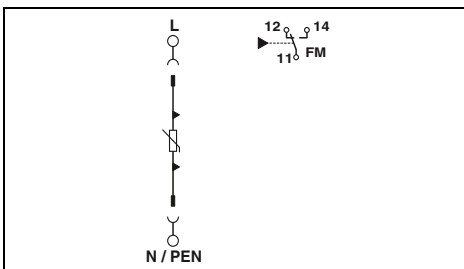

Technical data

Electrical data	
IEC test classification	I / II, T1 / T2
Nominal voltage U_N	- V AC / -48 V DC
Mode of protection	L-PEN / (L+) - (L-) / (L-) - PE / (L+) - PE
Maximum continuous operating voltage U_C	75 V AC / 100 V DC
Impulse discharge current I_{imp} (10/350) μ s	12.5 kA 12.5 kA
Nominal discharge current I_n (8/20) μ s	12.5 kA
Max. discharge current I_{max} (8/20) μ s	30 kA
Protection level U_p	≤ 0.4 kV
Response time t_A	≤ 25 ns
Short-circuit current rating I_{SCCR}	25 kA
Maximum backup fuse for branch wiring	160 A AC (gG)

General data	
Dimensions W/H/D	17.5 mm / 77.1 mm / 89.2 mm
IEC connection data	Rigid / flexible / AWG
UL connection data	1.5 ... 35 mm ² / 1.5 ... 25 mm ² / 15 ... 2
Temperature range	10 ... 2
Test standards	-40°C ... 80°C
Remote indication contact	EN 61643-11/A11
IEC connection data	PDT contact
UL connection data	0.14 ... 1.5 mm ² / 0.14 ... 1.5 mm ² / 28 ... 16
Max. operating voltage	-
Max. operating current	250 V AC / 125 V DC (200 mA DC)
	1.5 A / 1 A (30 V DC)

Ordering data

Description	Type	Order No.	Pcs./Pkt.
VALVETRAB MS			
with remote indication contact	VAL-MS-T1/T2 48/12.5/O-FM	2906282	12
without remote indication contact	VAL-MS-T1/T2 48/12.5/O	2906281	12

Accessories

Replacement plug	Type	Order No.	Pcs./Pkt.
L-N/N-PE/(L+) - (L-)/(L+) - PE	VAL-MS-T1/T2 48/12.5 ST	2801242	10
VALVETRAB, base element	VAL-MS-T1/T2 BE/O-FM	2905652	12
	VAL-MS-T1/T2 BE/O	2905650	12

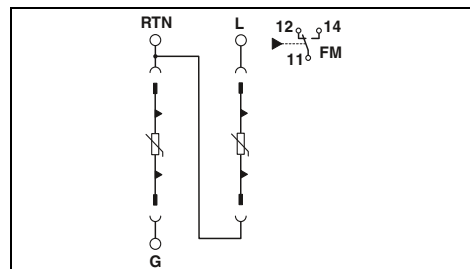

Technical data

Electrical data	
IEC test classification	I / II, T1 / T2
Nominal voltage U_N	60 V AC (TN-S) / -48 V DC
Mode of protection	L-N / N-PE
Maximum continuous operating voltage U_C	75 V AC / 100 V DC
Impulse discharge current I_{imp} (10/350) μ s	12.5 kA
Nominal discharge current I_n (8/20) μ s	12.5 kA
Max. discharge current I_{max} (8/20) μ s	30 kA
Protection level U_p	≤ 0.4 kV
Response time t_A	≤ 25 ns
Short-circuit current rating I_{SCCR}	25 kA
Maximum backup fuse for branch wiring	160 A AC (gG)

General data	
Dimensions W/H/D	70.6 mm / 40.6 mm / 98.1 mm
IEC connection data	- mm ² / - mm ² / 15 ... 2
UL connection data	10 ... 2
Temperature range	-40°C ... 80°C
Test standards	-
Remote indication contact	PDT contact
IEC connection data	- mm ² / - mm ² / 24 ... 20
UL connection data	30 ... 14
Max. operating voltage	250 V AC / 125 V DC (200 mA DC)
Max. operating current	1.5 A / 1 A (30 V DC)

Ordering data

Description	Type	Order No.	Pcs./Pkt.
VALVETRAB MS			
with remote indication contact	VAL-MS-T1/T2 48/12.5/1+1/1U/FM	2909629	6

Accessories

Replacement plug	Type	Order No.	Pcs./Pkt.
L-N/N-PE/(L+) - (L-)/(L+) - PE	VAL-MS-T1/T2 48/12.5 ST	2801242	10
VALVETRAB, base element	VAL-MS BE/1+1/1U/FM	2909628	1

Surge protection and interference suppression filters

Surge protection for the power supply

Type 1+2 combined lightning current and surge arrester VALVETRAB MS

- Double terminal block for safe and easy equipotential bonding connection
- Screw shafts with raised domes to ensure safe working
- Main connections with extended insertion funnels for increased resistance to creepage
- Optical, mechanical status indication for the individual arresters
- Visual display for checking the status directly on the device
- Pluggable signal connection for remote status signaling
- Compact design for space-saving installation



Pluggable lightning and surge protection for PV applications up to 1000 V DC



Pluggable lightning and surge protection for PV applications up to 1000 V DC

new

Notes:

If only one value is specified under mode of protection in the technical data, this value is valid for all modes of protection specified.

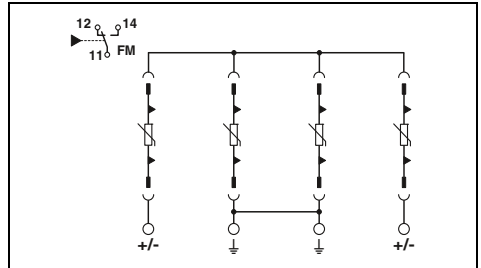
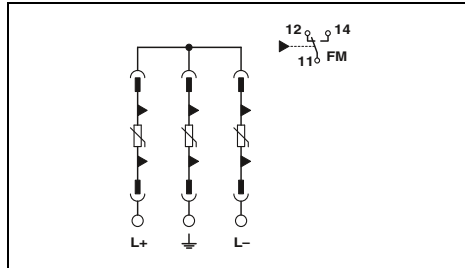

Technical data

Electrical data	... 600DC	... 1000DC
IEC test classification	PV I / II, T1 / T2	PV I / II, T1 / T2
Mode of protection	(L+) - (L-) / (L+) - PE / (L-) - PE	(DC+) - (DC-) / (DC+ / DC-) - PE
Maximum continuous operating voltage U_{CPV}	720 V DC	1050 V DC
Impulse discharge current I_{imp} (10/350) μ s	5 kA	5 kA
Nominal discharge current I_n (8/20) μ s	15 kA	15 kA
Max. discharge current I_{max} (8/20) μ s	40 kA	40 kA
Protection level U_p	≤ 2.6 kV	≤ 3.5 kV
Response time t_A	≤ 25 ns	≤ 25 ns
Short-circuit current I_{SCPV}	2000 A	2000 A
General data		
Dimensions W/H/D	53.4 mm / 98.7 mm / 65.7 mm	
IEC connection data	Rigid / flexible / AWG 1.5 ... 35 mm ² / 1.5 ... 25 mm ² / 15 ... 2	
Temperature range	-40°C ... 80°C	
Test standards	EN 50539-11	
Remote indication contact	PDT contact	
IEC connection data	Rigid / flexible / AWG 0.14 ... 1.5 mm ² / 0.14 ... 1.5 mm ² / 28 ... 16	
Max. operating voltage	250 V AC / 30 V DC	
Max. operating current	1.5 A AC / 1 A DC	

Technical data

Electrical data	... 600DC	... 1000DC
IEC test classification	PV I / II, T1 / T2	PV I / II, T1 / T2
Mode of protection	(DC+) - (DC-) / (DC+ / DC-) - PE	(DC+) - (DC-) / (DC+ / DC-) - PE
Maximum continuous operating voltage U_{CPV}	1170 V DC	1170 V DC
Impulse discharge current I_{imp} (10/350) μ s	5 kA	5 kA
Nominal discharge current I_n (8/20) μ s	15 kA	15 kA
Max. discharge current I_{max} (8/20) μ s	40 kA	40 kA
Protection level U_p	≤ 3.5 kV / ≤ 3.2 kV	≤ 3.5 kV / ≤ 3.2 kV
Response time t_A	≤ 25 ns	≤ 25 ns
Short-circuit current I_{SCPV}	2000 A	2000 A
General data		
Dimensions W/H/D	71.2 mm / 98.7 mm / 65.7 mm	
IEC connection data	Rigid / flexible / AWG 1.5 ... 35 mm ² / 1.5 ... 25 mm ² / 15 ... 2	
Temperature range	-40°C ... 85°C	
Test standards	EN 50539-11	
Remote indication contact	PDT contact	
IEC connection data	Rigid / flexible / AWG 0.14 ... 1.5 mm ² / 0.14 ... 1.5 mm ² / 28 ... 16	
Max. operating voltage	250 V AC / 30 V DC	
Max. operating current	1.5 A AC / 1 A DC	

Ordering data

Description	Type	Order No.	Pcs./Pkt.
VALVETRAB ...PV	VAL-MS-T1/T2 600DC-PV/2+V-FM	2801164	1
	VAL-MS-T1/T2 1000DC-PV/2+V-FM	2801161	1
VALVETRAB ...PV, without FM contact	VAL-MS-T1/T2 600DC-PV/2+V	2801163	1
	VAL-MS-T1/T2 1000DC-PV/2+V	2801160	1

Ordering data

Description	Type	Order No.	Pcs./Pkt.
VALVETRAB ...PV	VAL-MS-T1/T2 1000DC-PV/3+V-FM/32	1044182	32
VALVETRAB ...PV, without FM contact	VAL-MS-T1/T2 1000DC-PV/3+V/32	1044183	32

Accessories

Replacement plug			
600 V DC	(L+) - (L-)/(L+) - G/(L-) - G	2801165	1
1000 V DC	(L+) - (L-)/(L+) - G/(L-) - G	2801162	1

Accessories

Replacement plug			
1000 V DC	(L+) - (L-)/(L+) - G/(L-) - G	2801162	1

Type 1+2 combined lightning current and surge arrester VALVETRAB MB

- Double terminal block for safe and easy equipotential bonding connection
- Screw shafts with raised domes to ensure safe working
- Main connections with extended insertion funnels for increased resistance to creepage
- Optical, mechanical status indication for the individual arresters
- Visual display for checking the status directly on the device
- Pluggable signal connection for remote status signaling
- Compact design for space-saving installation

Notes:
If only one value is specified under mode of protection in the technical data, this value is valid for all modes of protection specified.



One-piece lightning and surge protection for PV applications up to 1000 V DC



One-piece lightning and surge protection for PV applications up to 1500 V DC

KEBA

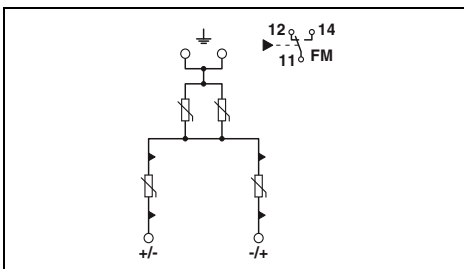

KEBA

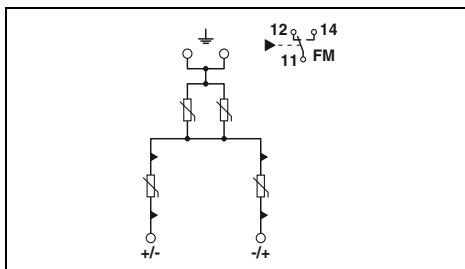

Electrical data	
IEC test classification	... 600DC
Mode of protection	PV I / II, T1 / T2
Maximum continuous operating voltage U_{CPV}	(L+) - (L-) / (L+) - PE / (L-) - PE
Impulse discharge current I_{imp} (10/350) μ s	800 V DC
Nominal discharge current I_n (8/20) μ s	6.25 kA
Max. discharge current I_{max} (8/20) μ s	20 kA
Protection level U_p	40 kA
Response time t_A	≤ 2.9 kV
Short-circuit current I_{SCPV}	≤ 25 ns
General data	
Dimensions W/H/D	2000 A
IEC connection data	71.2 mm / 120 mm / 65.5 mm
Temperature range	- mm ² / 2.5 ... 2
Test standards	-40°C ... 80°C
Remote indication contact	EN 50539-11
IEC connection data	PDT contact
Max. operating voltage	0.14 ... 1.5 mm ² / 0.14 ... 1.5 mm ² / 28 ... 16
Max. operating current	250 V AC / 5 V DC ... 30 V DC
	1.5 A AC / 5 mA DC ... 1 A DC

Technical data	
... 1000DC	... 1500DC
PV I / II, T1 / T2	PV I / II, T1 / T2
(L+) - (L-) / (L+) - PE / (L-) - PE	(L+) - (L-) / (L+) - PE / (L-) - PE
800 V DC	1000 V DC
6.25 kA	6.25 kA
20 kA	20 kA
40 kA	40 kA
≤ 2.9 kV	≤ 3.3 kV
≤ 25 ns	≤ 25 ns
2000 A	2000 A
General data	
Dimensions W/H/D	71.2 mm / 120 mm / 65.5 mm
IEC connection data	- mm ² / 2.5 ... 2
Temperature range	-40°C ... 80°C
Test standards	EN 50539-11
Remote indication contact	PDT contact
IEC connection data	0.14 ... 1.5 mm ² / 0.14 ... 1.5 mm ² / 28 ... 16
Max. operating voltage	250 V AC / 5 V DC ... 30 V DC
Max. operating current	1.5 A AC / 5 mA DC ... 1 A DC

Technical data	
... 1500DC	... 1500DC
PV I / II, T1 / T2	PV I / II, T1 / T2
(L+) - (L-) / (L+) - PE / (L-) - PE	(L+) - (L-) / (L+) - PE / (L-) - PE
1500 V DC	1500 V DC
6.25 kA	6.25 kA
20 kA	20 kA
40 kA	40 kA
≤ 4.5 kV	≤ 4.5 kV
≤ 25 ns	≤ 25 ns
2000 A	2000 A
General data	
Dimensions W/H/D	71.2 mm / 120 mm / 65.5 mm
IEC connection data	- mm ² / 2.5 ... 35 mm ² / 14 ... 2
Temperature range	-40°C ... 80°C
Test standards	EN 50539-11
Remote indication contact	PDT contact
IEC connection data	0.14 ... 1.5 mm ² / 0.14 ... 1.5 mm ² / 28 ... 16
Max. operating voltage	250 V AC / 5 V DC ... 30 V DC
Max. operating current	1.5 A AC / 5 mA DC ... 1 A DC

Ordering data	
Description	Type
VALVETRAB ...PV	VAL-MB-T1/T2 600DC-PV/2+V-FM
	VAL-MB-T1/T2 1000DC-PV/2+V-FM
VALVETRAB ...PV, without FM contact	VAL-MB-T1/T2 600DC-PV/2+V
	VAL-MB-T1/T2 1000DC-PV/2+V

Ordering data	
Type	Order No.
VAL-MB-T1/T2 600DC-PV/2+V-FM	2906292
VAL-MB-T1/T2 1000DC-PV/2+V-FM	2905638
VAL-MB-T1/T2 600DC-PV/2+V	2906293
VAL-MB-T1/T2 1000DC-PV/2+V	2905639

Ordering data	
Type	Order No.
VAL-MB-T1/T2 1500DC-PV/2+V-FM	2905640
VAL-MB-T1/T2 1500DC-PV/2+V	2905641

Accessories

Accessories

The product is also suitable for applications in PV systems with a max. short-circuit current $I_{SCPV} = 15$ kA (in accordance with EN 50539-11:2013).

Surge protection and interference suppression filters

Surge protection for the power supply

Type 1+2 combined lightning current and surge arrester POWERTRAB PWT

- Series connection from the high-capacity varistor and gas-filled surge arrester
- Free of leakage current, suitable for use in the pre-meter area
- High TOV resistance for use in IT systems and in the event of repetitive current peaks, e.g., triggered by frequency inverters
- Satisfies the installation requirements for use in wind turbine generators in accordance with CLC/TS 50539-22
- Encapsulated die-cast housing for direct assembly on mounting plates
- Suitable for use in harsh industrial environments
- High lightning impulse current of 35 kA per position
- Multi-stage status monitoring via remote indication contact
- Visual status indicator on the device

Notes:
If only one value is specified under mode of protection in the technical data, this value is valid for all modes of protection specified.



2-conductor system, L, PE/PEN



4-conductor system; L1, L2, L3, PE/PEN

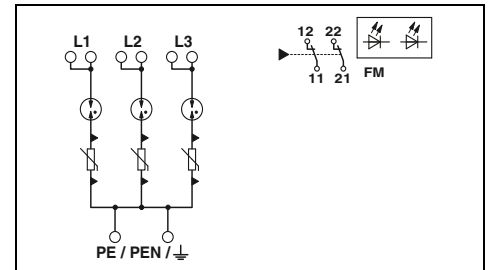
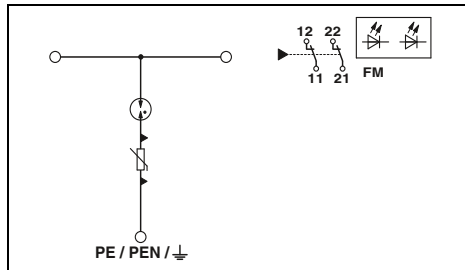

Technical data

Electrical data	
IEC test classification	
Nominal voltage U_N	
Mode of protection	
Maximum continuous operating voltage U_C	
Impulse discharge current I_{imp} (10/350) μ s	
Nominal discharge current I_n (8/20) μ s	
Max. discharge current I_{max} (8/20) μ s	
Residual voltage at 5 kA	
Protection level U_p	
Response time tA	
Short-circuit current rating I_{SCCR}	
Maximum backup fuse for branch wiring	
General data	
Dimensions W/H/D	
IEC connection data	Rigid / flexible / AWG
UL connection data	AWG
Temperature range	
Test standards	
Remote indication contact	
IEC connection data	Rigid / flexible / AWG
UL connection data	AWG
Max. operating voltage	
Max. operating current	

I / II, T1 / T2
690 V AC / 554/960 V AC (TN-C) / 690 V AC (IT)
L-PE
800 V AC
35 kA
35 kA
100 kA
≤ 2.2 kV
≤ 4.5 kV
≤ 100 ns
50 kA
400 A (gG at 2x 50 mm ²)

Technical data

I / II, T1 / T2
690 V AC / 554/960 V AC (TN-C) / 690 V AC (IT)
L-PE
800 V AC
35 kA
35 kA
100 kA
≤ 2.2 kV
≤ 4.5 kV
≤ 100 ns
50 kA
400 A (gG at 2x 50 mm ²)

Ordering data

Description	Type	Order No.	Pcs./Pkt.
POWERTRAB			
POWERTRAB, incl. mounting set			

Type	Order No.	Pcs./Pkt.
PWT 35-800AC-FM	2800419	1

Ordering data

Type	Order No.	Pcs./Pkt.
PWT 100-800AC-FM	2800531	1

Accessories

Mounting set for connecting three lightning current arresters of type PWT 35-800AC-FM		
Mounting set for connecting four lightning current arresters of type PWT 35-800AC-FM		

PWT CCT-SET	2800532	1
PWT CCT-SET 4	2905613	1

--	--	--

Type 2 surge protective device VALVETRAB SEC

- Varistor arrester with a low leakage current
- High-performance gas-filled surge arrester for N/PE protection
- Version with high nominal discharge current of 40 kA in the N-PE path
- For systems with more stringent safety requirements
- Extremely narrow design, just 12 mm per position, including for 400/690 V AC systems
- Pluggable
- Low voltage protection level of 1.5 kV for 230/400 V AC systems or 1.9 kV for 400/690 V AC systems
- Optical, mechanical status indicator
- With floating remote indication contact as an option
- Plugs can be tested with CHECKMASTER 2

new

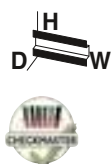

5-conductor system; L1, L2, L3, N, PE
(4+0 circuit)



4-conductor system, L1, L2, L3, PE(N)

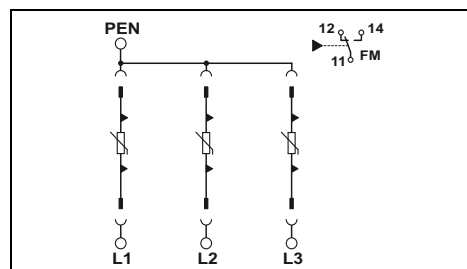
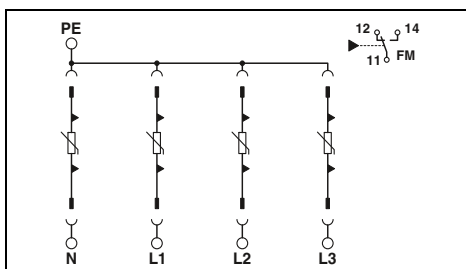

Technical data

Electrical data	
IEC test classification	II, T2
Nominal voltage U_N	400/690 V AC (TN-S) / 400 V AC (IT)
Mode of protection	
Maximum continuous operating voltage U_c	L-N / L-PE / N-PE 440 V AC
Nominal discharge current I_n (8/20) μ s	20 kA
Max. discharge current I_{max} (8/20) μ s	40 kA
Protection level U_p	≤ 4 kV / ≤ 1.9 kV / ≤ 1.9 kV
Response time t_A	≤ 25 ns
Short-circuit current rating I_{SCCR}	25 kA (in case of 315 A gG backup fuse) / 50 kA (in case of 200 A gG backup fuse)
Maximum backup fuse for branch wiring	315 A (gG)
General data	
Dimensions W/H/D	49.2 mm / 97.9 mm / 74.5 mm
IEC connection data	Rigid / flexible / AWG 2.5 ... 25 mm ² / 2.5 ... 16 mm ² / 12 ... 4
Temperature range	-40°C ... 80°C
Test standards	IEC 61643-11 / EN 61643-11
Remote indication contact	PDT contact
IEC connection data	Rigid / flexible / AWG 0.14 ... 1.5 mm ² / 0.14 ... 1.5 mm ² / 28 ... 16
Max. operating voltage	250 V AC / 125 V DC (200 mA DC)
Max. operating current	1 A AC / 1 A DC (30 V DC)

Technical data	
II, T2	
400/690 V AC (TN-C) / 400 V AC (IT)	
L-PEN	
440 V AC	
20 kA	
40 kA	
≤ 1.9 kV	
≤ 25 ns	
25 kA (in case of 315 A gG backup fuse) / 50 kA (in case of 200 A gG backup fuse)	
315 A (gG)	
General data	
37.3 mm / 97.9 mm / 74.5 mm	
2.5 ... 25 mm ² / 2.5 ... 16 mm ² / 12 ... 4	
-40°C ... 80°C	
IEC 61643-11 / EN 61643-11	
PDT contact	
0.14 ... 1.5 mm ² / 0.14 ... 1.5 mm ² / 28 ... 16	
250 V AC / 125 V DC (200 mA DC)	
1 A AC / 1 A DC (30 V DC)	

Ordering data

Description	Type	Order No.	Pcs./Pkt.
VALVETRAB SEC with remote indication contact	VAL-SEC-T2-4+0-440-FM	1076468	1

Ordering data		
Type	Order No.	Pcs./Pkt.
VAL-SEC-T2-3C-440-FM	2909968	1

Accessories

L-N/L-PEN	VAL-SEC-T2-440-P	2909969	1
-----------	------------------	---------	---

Accessories		
VAL-SEC-T2-440-P	2909969	1

Surge protection and interference suppression filters

Surge protection for the power supply

Type 2 surge protective device VALVETRAB SEC 350

- Varistor arrester with a low leakage current
- High-performance gas-filled surge arrester for N/PE protection
- Extremely narrow design, just 12 mm per position
- Pluggable
- High continuous voltage of 350 V AC for 230/400 V AC networks with high voltage fluctuations
- Low voltage protection level of 1.5 kV
- VF versions free of leakage current with series connection from the varistor and gas-filled surge arrester
- Version with high nominal discharge current of 40 kA in the N-PE path for use at the system feed point
- Optical, mechanical status indicator
- With floating remote indication contact as an option
- Plugs can be tested with CHECKMASTER 2

Notes:
If only one value is specified under mode of protection in the technical data, this value is valid for all modes of protection specified.



5-conductor system; L1, L2, L3, N, PE



4-conductor system; L1, L2, L3, PEN

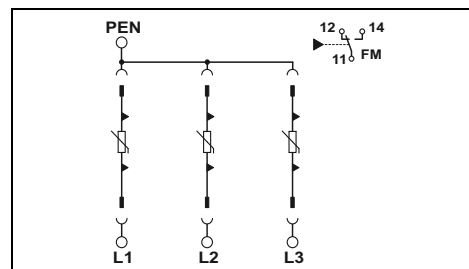
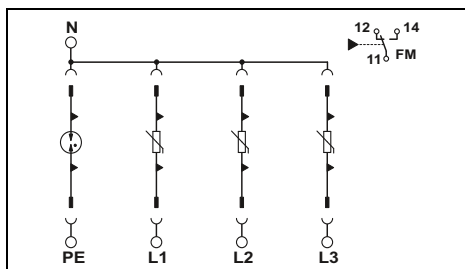

Technical data

Electrical data	... 350	... 350VF	... 350/40 ...
IEC test classification	II, T2	II, T2	II, T2
Nominal voltage U_N	240/415 V AC (TN-S) / 240/415 V AC (TT)	240/415 V AC (TN-S) / 240/415 V AC (TT)	240/415 V AC (TN-S) / 240/415 V AC (TT)
Mode of protection	L-N / L-PE / N-PE	L-N / L-PE / N-PE	L-N / L-PE / N-PE
Maximum continuous operating voltage U_C	350 V AC / 350 V AC / 264 V AC	350 V AC / 350 V AC / 264 V AC	350 V AC / 350 V AC / 264 V AC
Nominal discharge current I_n (8/20) μ s	20 kA	10 kA / 10 kA / 20 kA	20 kA / 20 kA / 40 kA
Max. discharge current I_{max} (8/20) μ s	40 kA	20 kA / 20 kA / 40 kA	40 kA / 40 kA / 80 kA
Protection level U_p	≤ 1.5 kV / ≤ 1.9 kV / ≤ 1.5 kV	≤ 1.5 kV / ≤ 2.3 kV / ≤ 1.5 kV	≤ 1.5 kV / ≤ 1.9 kV / ≤ 1.5 kV
Response time t_A	≤ 25 ns / ≤ 100 ns / ≤ 100 ns	≤ 100 ns	≤ 25 ns / ≤ 100 ns / ≤ 100 ns
Short-circuit current rating I_{SCCR}	25 kA (in case of 315 A gG backup fuse) / 50 kA (in case of 200 A gG backup fuse)	50 kA	25 kA (in case of 315 A gG backup fuse) / 50 kA (in case of 200 A gG backup fuse)
Maximum backup fuse for branch wiring	315 A (gG)	200 A (gG)	315 A (gG)
General data			
Dimensions W/H/D	49.2 mm / 97.9 mm / 74.5 mm		
IEC connection data	Rigid / flexible / AWG	2.5 ... 25 mm ² / 2.5 ... 16 mm ² / 12 ... 4	
UL connection data	AWG	14 ... 2 (rigid)	
Temperature range		-40°C ... 80°C	
Test standards		IEC 61643-11 / EN 61643-11	
Remote indication contact		PDT contact	
IEC connection data	Rigid / flexible / AWG	0.14 ... 1.5 mm ² / 0.14 ... 1.5 mm ² / 28 ... 16	
UL connection data	AWG	30 ... 14	
Max. operating voltage		250 V AC / 125 V DC (200 mA DC)	
Max. operating current		1 A AC / 1 A DC (30 V DC)	

Electrical data	... 350	... 350VF
IEC test classification	II, T2	II, T2
Nominal voltage U_N	240/415 V AC (TN-C)	240/415 V AC (TN-C)
Mode of protection	L-PEN	L-PEN
Maximum continuous operating voltage U_C	350 V AC	350 V AC
Nominal discharge current I_n (8/20) μ s	20 kA	10 kA
Max. discharge current I_{max} (8/20) μ s	40 kA	20 kA
Protection level U_p	≤ 1.5 kV	≤ 1.5 kV
Response time t_A	≤ 25 ns	≤ 100 ns
Short-circuit current rating I_{SCCR}	25 kA (in case of 315 A gG backup fuse) / 50 kA (in case of 200 A gG backup fuse)	50 kA
Maximum backup fuse for branch wiring	315 A (gG)	200 A (gG)
General data		
Dimensions W/H/D	37.3 mm / 97.9 mm / 74.5 mm	
IEC connection data	Rigid / flexible / AWG	2.5 ... 25 mm ² / 2.5 ... 16 mm ² / 12 ... 4
UL connection data	AWG	14 ... 2 (rigid)
Temperature range		-40°C ... 80°C
Test standards		IEC 61643-11 / EN 61643-11
Remote indication contact		PDT contact
IEC connection data	Rigid / flexible / AWG	0.14 ... 1.5 mm ² / 0.14 ... 1.5 mm ² / 28 ... 16
UL connection data	AWG	30 ... 14
Max. operating voltage		250 V AC / 125 V DC (200 mA DC)
Max. operating current		1 A AC / 1 A DC (30 V DC)

Ordering data

Description	Type	Order No.	Pcs./Pkt.
VALVETRAB SEC with remote indication contact	VAL-SEC-T2-3S-350-FM	2905340	1
without remote indication contact	VAL-SEC-T2-3S-350	2905345	1
VALVETRAB SEC...VF, free of leakage current with remote indication contact	VAL-SEC-T2-3S-350VF-FM	2909590	1
VALVETRAB SEC, 40 kA, N-PE with remote indication contact	VAL-SEC-T2-3S-350/40-FM	2909635	1
without remote indication contact	VAL-SEC-T2-3S-350/40	2909637	1

Ordering data

Description	Type	Order No.	Pcs./Pkt.
VAL-SEC-T2-3C-350-FM	VAL-SEC-T2-3C-350-FM	2905339	1
VAL-SEC-T2-3C-350	VAL-SEC-T2-3C-350	2905344	1
VAL-SEC-T2-3C-350VF-FM	VAL-SEC-T2-3C-350VF-FM	2909591	1

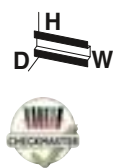

4-conductor system; L1, L2, N, PE

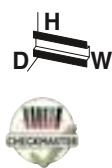

3-conductor system; L1, L2, PEN



3-conductor system; L, N, PE

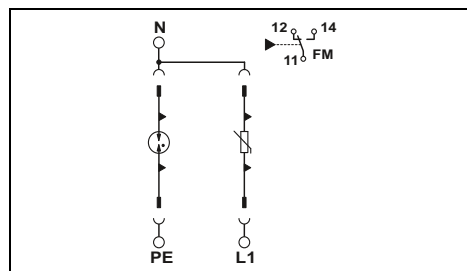
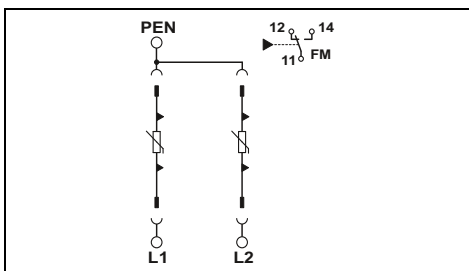
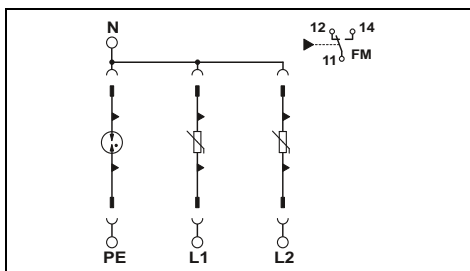

Technical data

... 350
II, T2
240/415 V AC (TN-S) / 240/415 V AC (TT)
L-N / L-PE / N-PE
350 V AC / 350 V AC / 264 V AC
20 kA
40 kA
≤ 1.5 kV / ≤ 1.9 kV / ≤ 1.5 kV
≤ 25 ns / ≤ 100 ns / ≤ 100 ns
25 kA (in case of 315 A gG backup fuse) / 50 kA (in case of 200 A gG backup fuse)
315 A (gG)

37.3 mm / 97.9 mm / 74.5 mm
2.5 ... 25 mm ² / 2.5 ... 16 mm ² / 12 ... 4
14 ... 2 (rigid)
-40°C ... 80°C
IEC 61643-11 / EN 61643-11
PDT contact
0.14 ... 1.5 mm ² / 0.14 ... 1.5 mm ² / 28 ... 16
30 ... 14
250 V AC / 125 V DC (200 mA DC)
1 A AC / 1 A DC (30 V DC)

Ordering data

Type	Order No.	Pcs./Pkt.
VAL-SEC-T2-2S-350-FM	2905338	1
VAL-SEC-T2-2S-350	2905343	1

Technical data

... 350
II, T2
240/415 V AC (TN-C)
L-PEN
350 V AC
20 kA
40 kA
≤ 1.5 kV
≤ 25 ns
25 kA (in case of 315 A gG backup fuse) / 50 kA (in case of 200 A gG backup fuse)
315 A (gG)

25.4 mm / 97.9 mm / 74.5 mm
2.5 ... 25 mm ² / 2.5 ... 16 mm ² / 12 ... 4
14 ... 2 (rigid)
-40°C ... 80°C
IEC 61643-11 / EN 61643-11
PDT contact
0.14 ... 1.5 mm ² / 0.14 ... 1.5 mm ² / 28 ... 16
30 ... 14
250 V AC / 125 V DC (200 mA DC)
1 A AC / 1 A DC (30 V DC)

Ordering data

Type	Order No.	Pcs./Pkt.
VAL-SEC-T2-2C-350-FM	2905337	1
VAL-SEC-T2-2C-350	2905342	1

Technical data

... 350	... 350VF
II, T2	II, T2
240 V AC (TN-S) / 240 V AC (TT)	240 V AC (TN-S) / 240 V AC (TT)
L-N / L-PE / N-PE	L-N / L-PE / N-PE
350 V AC / 350 V AC / 264 V AC	350 V AC / 350 V AC / 264 V AC
20 kA	10 kA / 10 kA / 20 kA
40 kA	20 kA / 20 kA / 40 kA
≤ 1.5 kV / ≤ 1.9 kV / ≤ 1.5 kV	≤ 1.5 kV / ≤ 2.3 kV / ≤ 1.5 kV
≤ 25 ns / ≤ 100 ns / ≤ 100 ns	≤ 100 ns
25 kA (in case of 315 A gG backup fuse) / 50 kA (in case of 200 A gG backup fuse)	50 kA
315 A (gG)	200 A (gG)

25.4 mm / 97.9 mm / 74.5 mm
2.5 ... 25 mm ² / 2.5 ... 16 mm ² / 12 ... 4
14 ... 2 (rigid)
-40°C ... 80°C
IEC 61643-11 / EN 61643-11
PDT contact
0.14 ... 1.5 mm ² / 0.14 ... 1.5 mm ² / 28 ... 16
30 ... 14
250 V AC / 125 V DC (200 mA DC)
1 A AC / 1 A DC (30 V DC)

Ordering data

Type	Order No.	Pcs./Pkt.
VAL-SEC-T2-1S-350-FM	2905333	1
VAL-SEC-T2-1S-350	2905341	1
VAL-SEC-T2-1S-350VF-FM	2909592	1

Surge protection and interference suppression filters

Surge protection for the power supply

Type 2 surge protective device VALVETRAB SEC 175

- Varistor arrester with a low leakage current
- High-performance gas-filled surge arrester for N/PE protection
- Extremely narrow design, just 12 mm per position
- Pluggable
- High continuous voltage of 175 V AC for 120/208 V AC networks with high voltage fluctuations
- Low voltage protection level of 0.85 kV for the L-N mode of protection and 0.95 kV for the N-PE mode of protection
- Optical, mechanical status indicator
- Plugs can be tested with CHECKMASTER 2

Notes:
If only one value is specified under mode of protection in the technical data, this value is valid for all modes of protection specified.



5-conductor system; L1, L2, L3, N, PE



4-conductor system; L1, L2, L3, PEN

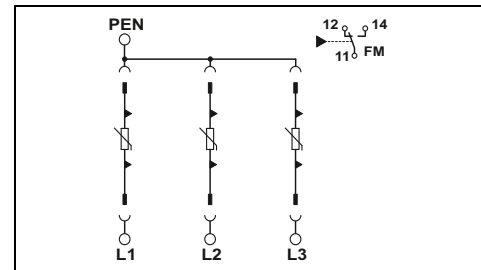
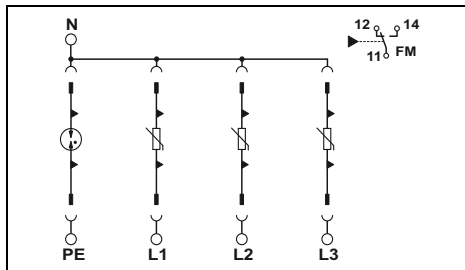

Technical data

Electrical data
IEC test classification
Nominal voltage U_N
Mode of protection
Maximum continuous operating voltage U_C
Nominal discharge current I_n (8/20) μ s
Max. discharge current I_{max} (8/20) μ s
Protection level U_p
Response time t_A
Short-circuit current rating I_{SCCR}
Maximum backup fuse for branch wiring

... 175
II, T2
120/208 V AC (TN-S) / 120/208 V AC (TT)
L-N / L-PE / N-PE
175 V AC / 175 V AC / 150 V AC
20 kA
40 kA
≤ 0.85 kV / ≤ 1.3 kV / ≤ 0.95 kV
≤ 25 ns / ≤ 100 ns / ≤ 100 ns
25 kA (in case of 315 A gG backup fuse) / 50 kA (in case of 200 A gG backup fuse)
315 A (gG)

Technical data

... 175
II, T2
120/208 V AC (TN-C)
L-PEN
175 V AC
20 kA
40 kA
≤ 0.85 kV
≤ 25 ns
25 kA (in case of 315 A gG backup fuse) / 50 kA (in case of 200 A gG backup fuse)
315 A (gG)

General data
Dimensions W/H/D
IEC connection data
UL connection data
Temperature range
Test standards
Remote indication contact
IEC connection data
UL connection data
Max. operating voltage
Max. operating current

49.2 mm / 97.9 mm / 74.5 mm
2.5 ... 25 mm ² / 2.5 ... 16 mm ² / 12 ... 4
14 ... 2 (rigid)
-40°C ... 80°C
IEC 61643-11 / EN 61643-11
PDT contact
0.14 ... 1.5 mm ² / 0.14 ... 1.5 mm ² / 28 ... 16
30 ... 14
250 V AC / 125 V DC (200 mA DC)
1 A AC / 1 A DC (30 V DC)

37.3 mm / 97.9 mm / 74.5 mm
2.5 ... 25 mm ² / 2.5 ... 16 mm ² / 12 ... 4
14 ... 2 (rigid)
-40°C ... 80°C
IEC 61643-11 / EN 61643-11
PDT contact
0.14 ... 1.5 mm ² / 0.14 ... 1.5 mm ² / 28 ... 16
30 ... 14
250 V AC / 125 V DC (200 mA DC)
1 A AC / 1 A DC (30 V DC)

Ordering data

Description
VALVETRAB SEC with remote indication contact

Type	Order No.	Pcs./Pkt.
VAL-SEC-T2-3S-175-FM	2905354	1

Ordering data

Type	Order No.	Pcs./Pkt.
VAL-SEC-T2-3C-175-FM	2905353	1

Accessories

Replacement plug
L-N/L-PEN N-PE

Type	Order No.	Pcs./Pkt.
VAL-SEC-T2-175-P	2905355	1
VAL-SEC-T2-N/PE-175-P	2905356	1

Accessories

Type	Order No.	Pcs./Pkt.
VAL-SEC-T2-175-P	2905355	1

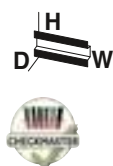

4-conductor system; L1, L2, N, PE

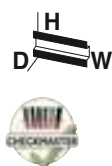

3-conductor system; L1, L2, PEN



3-conductor system; L, N, PE

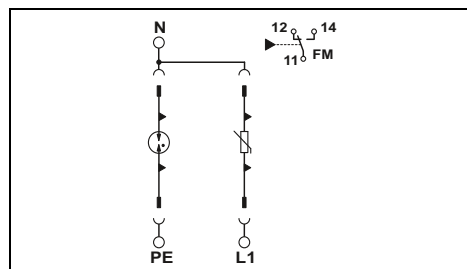
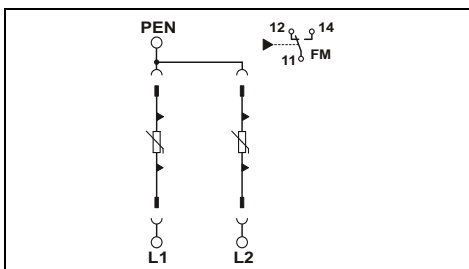
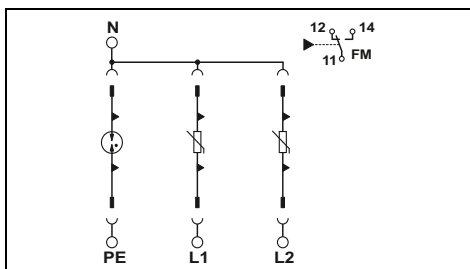

Technical data

... 175
II, T2
120/208 V AC (TN-S) /
120/208 V AC (TT)
L-N / L-PE / N-PE
175 V AC / 175 V AC / 150 V AC
20 kA
40 kA
≤ 0.85 kV / ≤ 1.3 kV / ≤ 0.95 kV
≤ 25 ns / ≤ 100 ns / ≤ 100 ns
25 kA (in case of 315 A gG backup fuse) /
50 kA (in case of 200 A gG backup fuse)
315 A (gG)

Technical data

... 175
II, T2
120/208 V AC (TN-C)
L-PEN
175 V AC
20 kA
40 kA
≤ 0.85 kV
≤ 25 ns
25 kA (in case of 315 A gG backup fuse) /
50 kA (in case of 200 A gG backup fuse)
315 A (gG)

Technical data

... 175
II, T2
120 V AC (TN-S) /
120 V AC (TT)
L-N / L-PE / N-PE
175 V AC / 175 V AC / 150 V AC
20 kA
40 kA
≤ 0.85 kV / ≤ 1.3 kV / ≤ 0.95 kV
≤ 25 ns / - / ≤ 100 ns
25 kA (in case of 315 A gG backup fuse) /
50 kA (in case of 200 A gG backup fuse)
315 A (gG)

37.3 mm / 97.9 mm / 74.5 mm
2.5 ... 25 mm² / 2.5 ... 16 mm² / 12 ... 4
14 ... 2 (rigid)
-40°C ... 80°C
IEC 61643-11 / EN 61643-11
PDT contact
0.14 ... 1.5 mm² / 0.14 ... 1.5 mm² / 28 ... 16
30 ... 14
250 V AC / 125 V DC (200 mA DC)
1 A AC / 1 A DC (30 V DC)

25.4 mm / 97.9 mm / 74.5 mm
2.5 ... 25 mm² / 2.5 ... 16 mm² / 12 ... 4
14 ... 2 (rigid)
-40°C ... 80°C
IEC 61643-11 / EN 61643-11
PDT contact
0.14 ... 1.5 mm² / 0.14 ... 1.5 mm² / 28 ... 16
30 ... 14
250 V AC / 125 V DC (200 mA DC)
1 A AC / 1 A DC (30 V DC)

25.4 mm / 97.9 mm / 74.5 mm
2.5 ... 25 mm² / 2.5 ... 16 mm² / 12 ... 4
14 ... 2 (rigid)
-40°C ... 80°C
IEC 61643-11 / EN 61643-11
PDT contact
0.14 ... 1.5 mm² / 0.14 ... 1.5 mm² / 28 ... 16
30 ... 14
250 V AC / 125 V DC (200 mA DC)
1 A AC / 1 A DC (30 V DC)

Ordering data

Type	Order No.	Pcs./Pkt.
VAL-SEC-T2-2S-175-FM	2905351	1

Ordering data

Type	Order No.	Pcs./Pkt.
VAL-SEC-T2-2C-175-FM	2905350	1

Ordering data

Type	Order No.	Pcs./Pkt.
VAL-SEC-T2-1S-175-FM	2905348	1

Accessories

VAL-SEC-T2-175-P	2905355	1
VAL-SEC-T2-N/PE-175-P	2905356	1

Accessories

VAL-SEC-T2-175-P	2905355	1
------------------	---------	---

Accessories

VAL-SEC-T2-175-P	2905355	1
VAL-SEC-T2-N/PE-175-P	2905356	1

Surge protection and interference suppression filters

Surge protection for the power supply

Type 2 surge protective device VALVETRAB SEC DC

- Varistor arrester with a low leakage current
- Extremely narrow design, just 12 mm per position
- High continuous voltage for linear DC current sources with voltage fluctuations
- Pluggable
- Low protection level
- Optical, mechanical status indicator
- With floating remote indication contact
- Plugs can be tested with CHECKMASTER 2



3-conductor system, DC+, DC-, PE
for 48 V DC and 120 V DC



3-conductor system, DC+, DC-, PE
for 220 V DC and 380 V DC

Notes:

If only one value is specified under mode of protection in the technical data, this value is valid for all modes of protection specified.

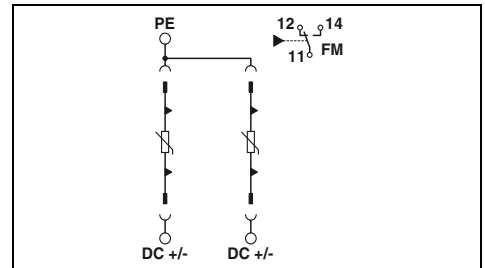
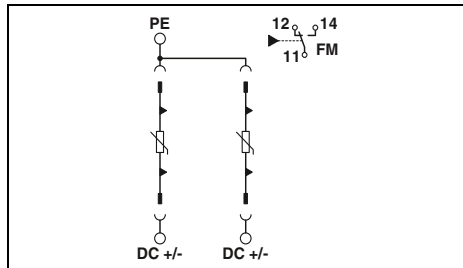

Technical data

Electrical data	...48 V...	...120 V...
IEC test classification	II, T2	II, T2
Nominal voltage U_N	48 V DC ... 60 V DC	100 V DC ... 120 V DC
Mode of protection	(DC+) - (DC-) / (DC+/DC-) - PE	(DC+) - (DC-) / (DC+/DC-) - PE
Maximum continuous operating voltage U_C	75 V DC	150 V DC
Nominal discharge current I_n (8/20) μ s	20 kA	20 kA
Max. discharge current I_{max} (8/20) μ s	40 kA	40 kA
Protection level U_p	≤ 0.9 kV / ≤ 0.5 kV	≤ 1.8 kV / ≤ 0.85 kV
Response time t_A	≤ 25 ns	≤ 25 ns
Short-circuit current rating I_{SCCR}	0.2 kA (without backup fuse) / 6 kA (for 20 A gG/B backup fuse)	0.2 kA (without backup fuse) / 6 kA (for 20 A gG/B backup fuse)

Maximum backup fuse for branch wiring

20 A (gG / B at $I_{SCCR} > 200$ A) 20 A (gG / B at $I_{SCCR} > 200$ A)

Additional technical data

Maximum continuous operating voltage U_C

- 135 V AC (for operation in safety lighting systems)

Technical data

Electrical data	...220 V...	...380 V...
IEC test classification	II, T2	II, T2
Nominal voltage U_N	200 V DC ... 220 V DC	350 V DC ... 400 V DC
Mode of protection	(DC+) - (DC-) / (DC+/DC-) - PE	(DC+) - (DC-) / (DC+/DC-) - PE
Maximum continuous operating voltage U_C	250 V DC	450 V DC
Nominal discharge current I_n (8/20) μ s	20 kA	20 kA
Max. discharge current I_{max} (8/20) μ s	40 kA	40 kA
Protection level U_p	≤ 3 kV / ≤ 1.5 kV	≤ 3 kV / ≤ 1.5 kV
Response time t_A	≤ 25 ns	≤ 25 ns
Short-circuit current rating I_{SCCR}	0.2 kA (without backup fuse) / 6 kA (for 20 A gG/B backup fuse)	0.1 kA (without backup fuse) / 6 kA (for 20 A gG/B backup fuse)

20 A (gG / B at $I_{SCCR} > 200$ A) 20 A (gG / B at $I_{SCCR} > 200$ A)

264 V AC (for operation in safety lighting systems) -

General data

Dimensions W/H/D		25.4 mm / 97.9 mm / 74.5 mm
IEC connection data	Rigid / flexible / AWG	2.5 ... 25 mm ² / 2.5 ... 16 mm ² / 12 ... 4
Temperature range		-40°C ... 80°C
Test standards		IEC 61643-11 / EN 61643-11
Remote indication contact		PDT contact
IEC connection data	Rigid / flexible / AWG	0.14 ... 1.5 mm ² / 0.14 ... 1.5 mm ² / 28 ... 16
Max. operating voltage		250 V AC / 125 V DC (200 mA DC)
Max. operating current		1 A AC / 1 A DC (30 V DC)

Ordering data

Description	Type	Order No.	Pcs./Pkt.
VALVETRAB SEC	VAL-SEC-T2-2+0-48DC-FM	2907865	1
	VAL-SEC-T2-2+0-120DC-FM	2907874	1

Accessories

Replacement plug	Type	Order No.	Pcs./Pkt.
(DC+) - (DC-)/(DC+/DC-) - PE	VAL-SEC-T2-48DC-P	2907877	1
(DC+) - (DC-)/(DC+/DC-) - PE	VAL-SEC-T2-120DC-P	2907878	1
(DC+/DC-) - PE	VAL-SEC-T2-GDT-400DC-P	1052632	1

Ordering data

Description	Type	Order No.	Pcs./Pkt.
VALVETRAB SEC	VAL-SEC-T2-2+0-220DC-FM	2907875	1
	VAL-SEC-T2-2+0-380DC-FM	2907876	1

Accessories

Replacement plug	Type	Order No.	Pcs./Pkt.
(DC+) - (DC-)/(DC+/DC-) - PE	VAL-SEC-T2-220DC-P	2907879	1
(DC+) - (DC-)/(DC+/DC-) - PE	VAL-SEC-T2-380DC-P	2907880	1
(DC+/DC-) - PE	VAL-SEC-T2-GDT-800DC-P	1052649	1

Type 2 surge protective device VALVETRAB SEC DC

- Free of leakage current to ground
- Extremely narrow design, just 12 mm per position
- High continuous voltage for linear DC current sources with voltage fluctuations
- Can be used in photovoltaic applications in accordance with EN 50539-11
- Pluggable
- Low protection level
- Optical, mechanical status indicator
- With floating remote indication contact
- Plugs can be tested with CHECKMASTER 2

Notes:
If only one value is specified under mode of protection in the technical data, this value is valid for all modes of protection specified.



3-conductor system, DC+, DC-, PE
for 48 V DC and 120 V DC,
free of leakage current



3-conductor system, DC+, DC-, PE
for 220 V DC and 380 V DC,
free of leakage current

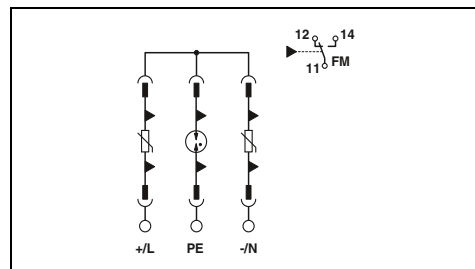
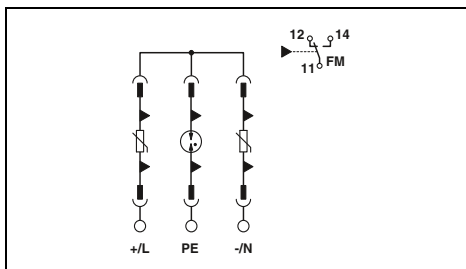

Electrical data	...48 V...	...120 V...
IEC test classification	II, T2	II, T2
Nominal voltage U_N	40 V DC ... 60 V DC	100 V DC ... 120 V DC
Mode of protection	(DC+) - (DC-) / (DC+/DC-) - PE	(DC+) - (DC-) / (DC+/DC-) - PE
Maximum continuous operating voltage U_C	75 V DC	150 V DC
Nominal discharge current I_n (8/20) μ s	20 kA	20 kA
Max. discharge current I_{max} (8/20) μ s	40 kA	40 kA
Protection level U_p	≤ 0.9 kV / ≤ 1 kV	≤ 1.8 kV / ≤ 1.3 kV
Response time t_A		
Short-circuit current rating I_{SCCR}	0.2 kA (without backup fuse) / 6 kA (for 20 A gG/B backup fuse)	0.2 kA (without backup fuse) / 6 kA (for 20 A gG/B backup fuse)
Maximum backup fuse for branch wiring	20 A (gG / B at $I_{SCCR} > 200$ A)	20 A (gG / B at $I_{SCCR} > 200$ A)
Additional technical data		
Maximum continuous operating voltage U_C	-	135 V AC (for operation in safety lighting systems)
General data		
Dimensions W/H/D	37.3 mm / 97.9 mm / 74.5 mm	
IEC connection data	Rigid / flexible / AWG 2.5 ... 25 mm ² / 2.5 ... 16 mm ² / 12 ... 4	
Temperature range	-40°C ... 80°C	
Test standards	IEC 61643-11 / EN 61643-11	
Remote indication contact	PDT contact	
IEC connection data	Rigid / flexible / AWG 0.14 ... 1.5 mm ² / 0.14 ... 1.5 mm ² / 28 ... 16	
Max. operating voltage	250 V AC / 125 V DC (200 mA DC)	
Max. operating current	1 A AC / 1 A DC (30 V DC)	

Technical data	...220 V...	...380 V...
IEC test classification	II, T2	II, T2
Nominal voltage U_N	200 V DC ... 220 V DC	350 V DC ... 400 V DC
Mode of protection	(DC+) - (DC-) / (DC+/DC-) - PE	(DC+) - (DC-) / (DC+/DC-) - PE
Maximum continuous operating voltage U_C	250 V DC	450 V DC
Nominal discharge current I_n (8/20) μ s	20 kA	20 kA
Max. discharge current I_{max} (8/20) μ s	40 kA	40 kA
Protection level U_p	≤ 3 kV / ≤ 1.9 kV	≤ 3 kV / ≤ 1.9 kV
Response time t_A		
Short-circuit current rating I_{SCCR}	0.2 kA (without backup fuse) / 6 kA (for 20 A gG/B backup fuse)	0.1 kA (without backup fuse) / 6 kA (for 20 A gG/B backup fuse)
Maximum backup fuse for branch wiring	20 A (gG / B at $I_{SCCR} > 200$ A)	10 A (gG / B at $I_{SCCR} > 100$ A)
Additional technical data		
Maximum continuous operating voltage U_C	264 V AC (for operation in safety lighting systems)	-

Ordering data	Accessories
Type	VAL-SEC-T2-48DC-P
Order No.	2907877
Pcs./Pkt.	1
Type	VAL-SEC-T2-120DC-P
Order No.	2907878
Pcs./Pkt.	1
Type	VAL-SEC-T2-GDT-400DC-P
Order No.	1052632
Pcs./Pkt.	1

Description	Type	Order No.	Pcs./Pkt.
VALVETRAB SEC	VAL-SEC-T2-2+F-48DC-FM	1033786	1
	VAL-SEC-T2-2+F-120DC-FM	1033788	1

Ordering data	Accessories
Type	VAL-SEC-T2-220DC-P
Order No.	2907879
Pcs./Pkt.	1
Type	VAL-SEC-T2-380DC-P
Order No.	2907880
Pcs./Pkt.	1
Type	VAL-SEC-T2-GDT-800DC-P
Order No.	1052649
Pcs./Pkt.	1

Ordering data	Accessories
Type	VAL-SEC-T2-48DC-P
Order No.	2907877
Pcs./Pkt.	1
Type	VAL-SEC-T2-120DC-P
Order No.	2907878
Pcs./Pkt.	1
Type	VAL-SEC-T2-GDT-400DC-P
Order No.	1052632
Pcs./Pkt.	1

Surge protection and interference suppression filters

Surge protection for the power supply

Type 2 surge protective device VALVETRAB MS 230 / 320

- Multi-channel type 2 protective device
- Type 2 surge protective device with consistent pluggable design
- Disconnect device on each individual plug
- Optical, mechanical status indication for the individual arresters
- With or without floating remote indication contact
- Mechanical coding of all slots
- Plugs can be tested with CHECKMASTER 2

Notes:
If only one value is specified under mode of protection in the technical data, this value is valid for all modes of protection specified.

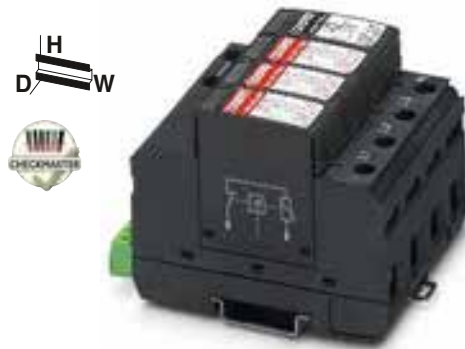

5-conductor system; L1, L2, L3, N, PE, supply line supply from below

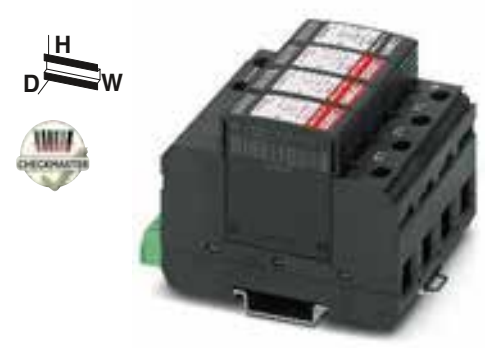
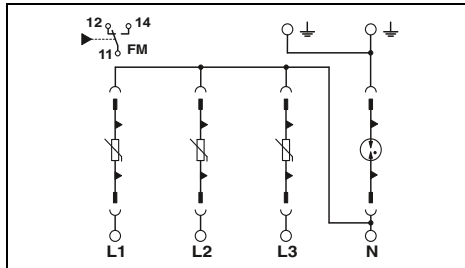

5-conductor system; L1, L2, L3, N, PE, supply line supply from above

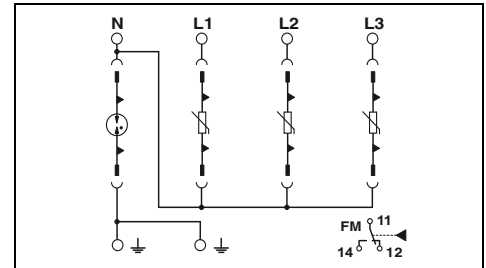

Electrical data	
IEC test classification	
Nominal voltage U_N	
Mode of protection	
Maximum continuous operating voltage U_C	
Nominal discharge current I_n (8/20) μ s	
Max. discharge current I_{max} (8/20) μ s	
Protection level U_p	
Follow current interrupt rating I_{fi}	
Response time t_A	
Short-circuit current rating I_{SCCR}	
Maximum backup fuse for branch wiring	

Technical data

VAL-MS 230	VAL-MS 320
II, T2	II, T2
240/415 V AC (TN-S) / 240/415 V AC (TT)	240/415 V AC (TN-S) / 240/415 V AC (TT)
L-N / L-PE / N-PE	L-N / L-PE / N-PE
275 V AC / 275 V AC / 260 V AC	335 V AC / 335 V AC / 260 V AC
20 kA	20 kA
40 kA	40 kA
≤ 1.35 kV / ≤ 1.6 kV / ≤ 1.5 kV	≤ 1.5 kV / ≤ 1.9 kV / ≤ 1.5 kV
- / - / 100 A	- / - / 100 A
≤ 25 ns / ≤ 100 ns / ≤ 100 ns	≤ 25 ns / ≤ 100 ns / ≤ 100 ns
25 kA	25 kA
125 A (gG)	125 A (gG)

Technical data

VAL-MS 320
II, T2
240/415 V AC (TN-S) / 240/415 V AC (TT)
L-N / L-PE / N-PE
335 V AC / 335 V AC / 260 V AC
20 kA
40 kA
≤ 1.6 kV / ≤ 1.9 kV / ≤ 1.5 kV
- / - / 100 A
≤ 25 ns / ≤ 100 ns / ≤ 100 ns
25 kA
125 A (gG)

General data	
Dimensions W/H/D	
IEC connection data	Rigid / flexible / AWG
UL connection data	AWG
Temperature range	
Test standards	
Remote indication contact	
IEC connection data	Rigid / flexible / AWG
UL connection data	AWG
Max. operating voltage	
Max. operating current	

71 mm / 98.7 mm / 65.7 mm
1.5 ... 35 mm ² / 1.5 ... 25 mm ² / 15 ... 2
10 ... 2
-40°C ... 80°C
IEC 61643-11 / EN 61643-11
PDT contact
0.14 ... 1.5 mm ² / 0.14 ... 1.5 mm ² / 28 ... 16
30 ... 14
250 V AC / 30 V DC
750 mA AC / 1 A DC

71 mm / 98.7 mm / 65.7 mm
1.5 ... 35 mm ² / 1.5 ... 25 mm ² / 15 ... 2
10 ... 2
-40°C ... 80°C
IEC 61643-11 / EN 61643-11
PDT contact
0.14 ... 1.5 mm ² / 0.14 ... 1.5 mm ² / 28 ... 16
30 ... 14
250 V AC / 30 V DC
750 mA AC / 1 A DC

Description	U_C
VALVETRAB , multi-position surge protective device	
without remote indication contact	275 V AC
with remote indication contact	275 V AC
without remote indication contact	335 V AC
with remote indication contact	335 V AC

Ordering data

Type	Order No.	Pcs./Pkt.
VAL-MS 230/3+1	2838209	1
VAL-MS 230/3+1 FM	2838199	1
VAL-MS 320/3+1	2859178	1
VAL-MS 320/3+1/FM	2859181	1

Ordering data

Type	Order No.	Pcs./Pkt.
VAL-MS 320/3+1/FM-UD	2856689	1

Replacement plug	
L-N/L-PEN	
L-N/L-PEN	
N-PE	

Accessories

Type	Order No.	Pcs./Pkt.
VAL-MS 230 ST	2798844	10
VAL-MS 320 ST	2838843	10
F-MS 12 ST	2817990	10

Accessories

Type	Order No.	Pcs./Pkt.
VAL-MS 320-UD ST	2858315	10
F-MS 12-UD ST	2858328	10



4-conductor system; L1, L2, L3, PEN



3-conductor system; L, N, PE

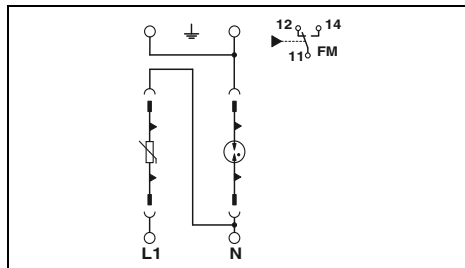
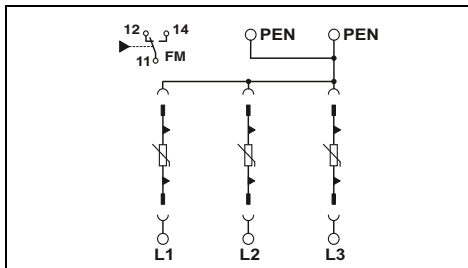

Technical data

VAL-MS 320
II, T2
240/415 V AC (TN-C)

L-PEN
335 V AC
20 kA
40 kA
≤ 1.5 kV
-
≤ 25 ns
25 kA
125 A (gG)

Technical data

VAL-MS 230	VAL-MS 320
II, T2	II, T2
240/415 V AC (TN-S) / 240/415 V AC (TT)	240/415 V AC (TN-S) / 240/415 V AC (TT)
L-N / L-PE / N-PE	L-N / L-PE / N-PE
275 V AC / 275 V AC / 260 V AC	335 V AC / 335 V AC / 260 V AC
20 kA	20 kA
40 kA	40 kA
≤ 1.35 kV / ≤ 1.6 kV / ≤ 1.5 kV	≤ 1.5 kV / ≤ 1.8 kV / ≤ 1.5 kV
- / - / 100 A	- / - / 100 A
≤ 25 ns / ≤ 100 ns / ≤ 100 ns	≤ 25 ns / ≤ 100 ns / ≤ 100 ns
25 kA	25 kA
125 A (gG)	125 A (gG)

53.4 mm / 98.7 mm / 65.7 mm
1.5 ... 35 mm² / 1.5 ... 25 mm² / 15 ... 2

10 ... 2
-40°C ... 80°C
IEC 61643-11 / EN 61643-11

PDT contact
0.14 ... 1.5 mm² / 0.14 ... 1.5 mm² / 28 ... 16
30 ... 14

250 V AC / 30 V DC
1.5 A AC / 1 A DC

35.6 mm / 96.8 mm / 65.7 mm
1.5 ... 35 mm² / 1.5 ... 25 mm² / 15 ... 2

10 ... 2
-40°C ... 80°C
IEC 61643-11 / EN 61643-11

PDT contact
0.14 ... 1.5 mm² / 0.14 ... 1.5 mm² / 28 ... 16
30 ... 14

250 V AC / 30 V DC
1.5 A AC / 1 A DC

Ordering data

Type	Order No.	Pcs./Pkt.
VAL-MS 320/3+0	2920230	1
VAL-MS 320/3+0-FM	2920243	1

Ordering data

Type	Order No.	Pcs./Pkt.
VAL-MS 230/1+1	2804429	1
VAL-MS 230/1+1-FM	2804432	1
VAL-MS 320/1+1	2804380	1
VAL-MS 320/1+1-FM	2804393	1

Accessories

VAL-MS 320 ST	2838843	10
---------------	---------	----

Accessories

VAL-MS 230 ST	2798844	10
VAL-MS 320 ST	2838843	10
F-MS 12 ST	2817990	10

Surge protection and interference suppression filters

Surge protection for the power supply

Type 2 surge protective device VALVETRAB MS

- DIN-rail-mountable protective devices
- Comprising base element and plug
- Free of leakage current
- Thermal disconnect device for each individual plug
- Optical, mechanical status indication for the individual arresters
- With or without floating remote indication contact
- Mechanical coding of all slots
- Plugs can be tested with CHECKMASTER 2



2-conductor system; L, N, PEN
free of leakage current

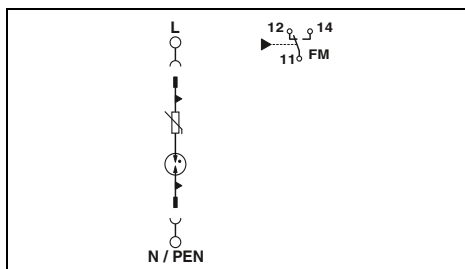

Technical data

Electrical data

IEC test classification
Nominal voltage U_N

II, T2
240/415 V AC (TN) /
240/415 V AC (TT) /
230 V AC (IT)

Mode of protection

Maximum continuous operating voltage U_C
Nominal discharge current I_n (8/20) μ s
Max. discharge current I_{max} (8/20) μ s
Protection level U_p
Response time t_A
Short-circuit current rating I_{SCCR}
Maximum backup fuse for branch wiring

L-N / L-PE / L-PEN
350 V AC
10 kA
20 kA
 ≤ 1.5 kV
 ≤ 100 ns
25 kA
125 A (gG)

General data

Dimensions W/H/D
IEC connection data Rigid / flexible / AWG
UL connection data AWG
Temperature range
Test standards

17.6 mm / 96.8 mm / 65.7 mm
1.5 ... 35 mm² / 1.5 ... 25 mm² / 15 ... 2
10 ... 2
-40°C ... 80°C
IEC 61643-11 / EN 61643-11

Remote indication contact

IEC connection data Rigid / flexible / AWG
UL connection data AWG
Max. operating voltage
Max. operating current

PDT contact
0.14 ... 1.5 mm² / 0.14 ... 1.5 mm² / 28 ... 16
30 ... 14
250 V AC / 30 V DC
1 A AC / 1 A DC

Ordering data

Description

VALVETRAB MS

with remote indication contact
without remote indication contact

Type	Order No.	Pcs./Pkt.
VAL-MS 350 VF/FM	2856579	1
VAL-MS 350VF	2856582	1

Accessories

Replacement plug

L-N/L-PE/L-PEN

VAL-MS 350 VF ST	2856595	10
------------------	---------	----

Type 2 surge protective device VALVETRAB MS

- Also suitable for industry solutions, e.g., railway
- Discharge of lightning currents (10/350) μ s
- Thermal disconnect device for each individual plug
- Optical, mechanical status indication for the individual arresters
- With or without floating remote indication contact
- Mechanical coding of all slots
- Plugs can be tested with CHECKMASTER 2



For 2-conductor systems, L, N, PE
capable of carrying lightning current,
free of leakage current



For 3-conductor systems, L1, L2, L3, PE(N)
capable of carrying lightning current,
free of leakage current

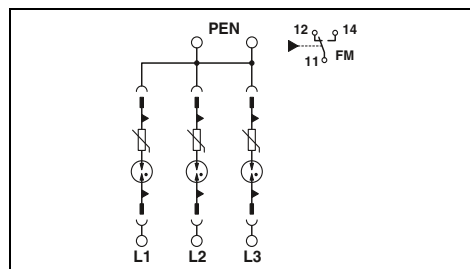
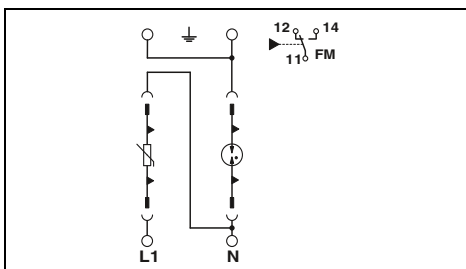

Technical data

Electrical data	
IEC test classification	II, T2
Nominal voltage U_N	240/415 V AC (TN-S) / 240/415 V AC (TT)
Mode of protection	
Maximum continuous operating voltage U_C	L-N / L-PE / N-PE 335 V AC / 335 V AC / 260 V AC
Impulse discharge current I_{imp} (10/350) μ s	7 kA / 2.5 kA / 2.5 kA
Nominal discharge current I_n (8/20) μ s	20 kA
Max. discharge current I_{max} (8/20) μ s	40 kA
Protection level U_p	≤ 1.5 kV / ≤ 1.8 kV / ≤ 1.5 kV
Follow current interrupt rating I_{fi}	- / - / 100 A
Response time t_A	≤ 25 ns / ≤ 100 ns / ≤ 100 ns
Short-circuit current rating I_{SCCR}	25 kA
Maximum backup fuse for branch wiring	125 A (gG)
General data	
Dimensions W/H/D	35,6 mm / 96,8 mm / 65,7 mm
IEC connection data	Rigid / flexible / AWG 1.5 ... 35 mm ² / 1.5 ... 25 mm ² / 15 ... 2
UL connection data	AWG
Temperature range	-40°C ... 80°C
Test standards	IEC 61643-11 / EN 61643-11
Remote indication contact	
IEC connection data	PDT contact
UL connection data	Rigid / flexible / AWG 0.14 ... 1.5 mm ² / 0.14 ... 1.5 mm ² / 28 ... 16
Max. operating voltage	-
Max. operating current	250 V AC / 30 V DC 1.5 A AC / 1 A DC

Technical data	
II, T2	
240/415 V AC (TN-C) / 230 V AC (IT)	
L-PE / L-PEN	
350 V AC	
2.5 kA	
10 kA	
20 kA	
≤ 1.5 kV	
- / -	
≤ 100 ns	
25 kA	
125 A (gG)	
General data	
53,4 mm / 98,7 mm / 65,7 mm	
1.5 ... 35 mm ² / 1.5 ... 25 mm ² / 15 ... 2	
-	
-40°C ... 80°C	
IEC 61643-11 / EN 61643-11	
PDT contact	
0.14 ... 1.5 mm ² / 0.14 ... 1.5 mm ² / 28 ... 16	
-	
250 V AC / 30 V DC	
1.5 A AC / 1 A DC	

Ordering data

Description	
VALVETRAB MS with remote indication contact	
Replacement plug	
L-N/L-PEN N-PE	

Type	Order No.	Pcs./Pkt.
VAL-MS 320 RW/1+1-FM/60	1050286	60
Accessories		
VAL-MS 320 RW ST	1050283	10
F-MS 12 ST	2817990	10

Ordering data

Type	Order No.	Pcs./Pkt.
VAL-MS 350 VF-RW/3+0-FM/40	1050284	40
Accessories		
VAL-MS 350 VF-RW ST	1050280	10

Surge protection and interference suppression filters

Surge protection for the power supply

Type 2 surge protective device VALVETRAB MS

- For systems with harmonics, e.g., PV inverters, frequency converters
- Universal pluggability
- Thermal disconnect device for each individual plug
- Optical, mechanical status indication for the individual arresters
- Mechanical coding of all slots
- Plugs can be tested with CHECKMASTER 2



3-conductor system, L1, L2, L3, PE
for supply systems with harmonics

ERC

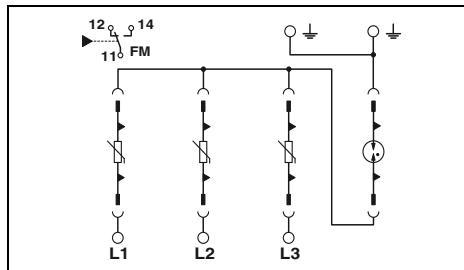

Technical data

Electrical data	
IEC test classification	II, T2
Nominal voltage U_N	400 V AC (IT)
Mode of protection	L-PE / L-L
Maximum continuous operating voltage U_C	440 V AC
Nominal discharge current I_n (8/20) μ s	20 kA
Max. discharge current I_{max} (8/20) μ s	40 kA
Protection level U_p	≤ 4 kV / ≤ 3.5 kV
Response time t_A	≤ 25 ns / ≤ 100 ns
Short-circuit current rating I_{SCCR}	25 kA
Maximum backup fuse for branch wiring	100 A (gG)
General data	
Dimensions W/H/D	71 mm / 98.7 mm / 65.7 mm
IEC connection data	Rigid / flexible / AWG
UL connection data	AWG
Temperature range	-40°C ... 80°C
Test standards	IEC 61643-11 / EN 61643-11
Remote indication contact	
IEC connection data	Rigid / flexible / AWG
UL connection data	AWG
Max. operating voltage	250 V AC / 30 V DC
Max. operating current	750 mA AC / 1 A DC

Ordering data

Description	Type	Order No.	Pcs./Pkt.
VALVETRAB MS with remote indication contact	VAL-MS 400/3+0/VF-FM	2910476	1
VALVETRAB MS with remote indication contact	VAL-MS 400/3+0/VF-FM/32	2909828	32

Accessories

Replacement plug	Type	Order No.	Pcs./Pkt.
L-N/L-PE/L-PEN	VAL-MS 400 ST	2816399	10
L-PE (for IT systems without N in series with a VAL-MS plug)	F-MS 1100 ST	2909844	1

Type 2 surge protective device VALVETRAB MS

- For power supplies with higher supply voltages, such as wind power
- Universal pluggability
- Thermal disconnect device for each individual plug
- Optical, mechanical status indication for the individual arresters
- With or without floating remote indication contact
- Mechanical coding of all slots
- Plugs can be tested with CHECKMASTER 2

Notes:
If only one value is specified under mode of protection in the technical data, this value is valid for all modes of protection specified.

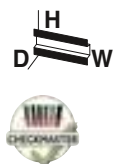

Free of leakage current, for nominal voltages up to 690 V AC, e.g., rotor protection for wind turbine generators

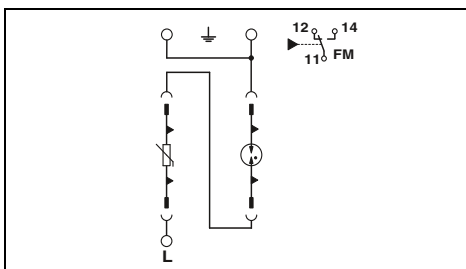
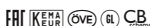

Technical data

Electrical data	
IEC test classification	II, T2
Nominal voltage U_N	400/690 V AC (TN-C) / 690 V AC (IT)
Mode of protection	
Maximum continuous operating voltage U_c	L-PE / L-PEN 800 V AC
Nominal discharge current I_n (8/20) μ s	15 kA
Max. discharge current I_{max} (8/20) μ s	30 kA
Protection level U_p	≤ 5 kV
Response time t_A	≤ 100 ns
Short-circuit current rating I_{SCCR}	25 kA
Maximum backup fuse for branch wiring	100 A (gG)
General data	
Dimensions W/H/D	35.6 mm / 96.8 mm / 65.7 mm
IEC connection data	Rigid / flexible / AWG 1.5 ... 35 mm ² / 1.5 ... 25 mm ² / 15 ... 2
UL connection data	- AWG
Temperature range	-40°C ... 80°C
Test standards	IEC 61643-11 / EN 61643-11
Remote indication contact	
PDT contact	
IEC connection data	Rigid / flexible / AWG 0.14 ... 1.5 mm ² / 0.14 ... 1.5 mm ² / 28 ... 16
UL connection data	- AWG
Max. operating voltage	250 V AC / 30 V DC
Max. operating current	1.5 A AC / 1 A DC

Ordering data

Description	Type	Order No.	Pcs./Pkt.
VALVETRAB MS, for mounting on NS 35 with remote indication contact	VAL-MS 800/30 VF/FM	2805402	1
without remote indication contact			

Accessories

Replacement plug	L-PE/L-PEN	VAL-MS 750/30-ST	2920256	10
	L-PE	F-MS 2200/30 ST	2805392	10



4-conductor system; L1, L2, L3, PEN (554/960 V TN-C system)

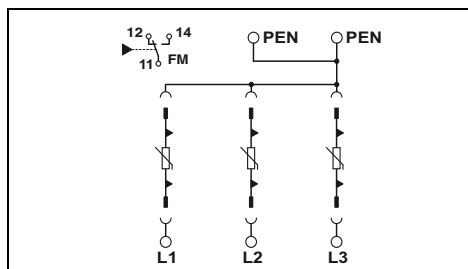

Technical data

Electrical data	
IEC test classification	II, T2
Nominal voltage U_N	554/960 V AC (TN-C) / 690 V AC (IT)
Mode of protection	
Maximum continuous operating voltage U_c	L-PE / L-PEN 760 V AC
Nominal discharge current I_n (8/20) μ s	15 kA
Max. discharge current I_{max} (8/20) μ s	30 kA
Protection level U_p	≤ 2.9 kV
Response time t_A	≤ 25 ns
Short-circuit current rating I_{SCCR}	25 kA
Maximum backup fuse for branch wiring	100 A (gG)
General data	
Dimensions W/H/D	53.4 mm / 98.7 mm / 65.7 mm
IEC connection data	1.5 ... 35 mm ² / 1.5 ... 25 mm ² / 15 ... 2
UL connection data	10 ... 2 AWG
Temperature range	-40°C ... 80°C
Test standards	IEC 61643-11 / EN 61643-11
Remote indication contact	
PDT contact	
IEC connection data	0.14 ... 1.5 mm ² / 0.14 ... 1.5 mm ² / 28 ... 16
UL connection data	30 ... 14 AWG
Max. operating voltage	250 V AC / 30 V DC
Max. operating current	1.5 A AC / 1 A DC

Ordering data

Description	Type	Order No.	Pcs./Pkt.
VALVETRAB MS 750/30/3+0-FM	VAL-MS 750/30/3+0-FM	2920272	1
VALVETRAB MS 750/30/3+0	VAL-MS 750/30/3+0	2920269	1

Accessories

Replacement plug	L-PE/L-PEN	VAL-MS 750/30-ST	2920256	10
-------------------------	------------	------------------	---------	----

Surge protection and interference suppression filters

Surge protection for the power supply

Type 2 surge protective device VALVETRAB MS

- Surge protection for individual assembly
- Optical, mechanical status indicator of the plug
- Disconnect device in the plug
- Base element coding the first time a plug is inserted
- Plugs can be tested with CHECKMASTER 2

Notes:
 Choose the plug based on technical data.
 Choose the base element corresponding to the required circuit and remote signaling function:
 - TN-C: X+0 - circuit
 - TN-S, TT: X+1 - circuit
 - IT: Y+0 - circuit
 - X = Number of phases
 - Y = Number of phases + if required, neutral conductor
 The number of plugs required corresponds to the number before the "+" in the circuit data, e.g., 3 plugs in a 3+1 circuit
 When using a "+1" circuit, the F-MS 12 plug must be used between N and PE. See page 71



For 24 and 48 V DC



For 120/208 V grounded wye and 120 V split-phase systems

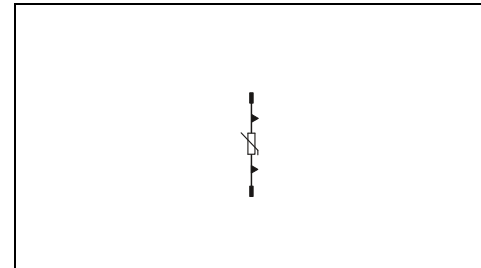
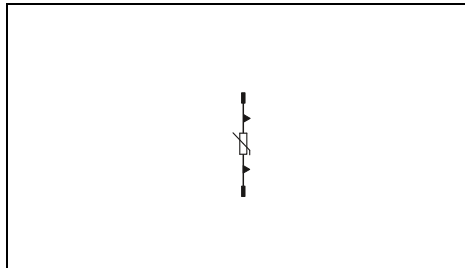

Technical data

Electrical data	
IEC test classification	II, T2
Nominal voltage U_N (IEC)	60 V AC (TN)
Nominal voltage U_N (UL)	60 V AC
Maximum continuous operating voltage U_C	75 V AC / 100 V DC
Nominal discharge current I_n (8/20) μ s	15 kA
Max. discharge current I_{max} (8/20) μ s	40 kA
Protection level U_p	≤ 0.55 kV
General data	
Dimensions W/H/D	17.5 mm / 52.4 mm / 55.3 mm
Temperature range	-40°C ... 80°C
Test standards	IEC 61643-11 / EN 61643-11

Electrical data	
IEC test classification	II, T2
Nominal voltage U_N (IEC)	120/208 V AC (TN)
Nominal voltage U_N (UL)	120 V AC
Maximum continuous operating voltage U_C	150 V AC
Nominal discharge current I_n (8/20) μ s	20 kA
Max. discharge current I_{max} (8/20) μ s	40 kA
Protection level U_p	≤ 0.9 kV
General data	
Dimensions W/H/D	17.5 mm / 52.4 mm / 55.3 mm
Temperature range	-40°C ... 80°C
Test standards	IEC 61643-11 / EN 61643-11

Ordering data

Description	Type	Order No.	Pcs./Pkt.
VALVETRAB surge protection plug	VAL-MS 60 ST	2807573	10

Description	Type	Order No.	Pcs./Pkt.
VALVETRAB surge protection plug	VAL-MS 120 ST	2807586	10

Accessories

Base element, with RI contact	1+0	VAL-MS BE/FM	2817738	10
	1+0	VAL-MS-T1/T2 BE/O-FM	2905652	12
	1+1			
	2+0	VAL-MS/2+0-BE/FM	2805321	1
	2+0	VAL-MS BE/2+0/1U/FM	2907037	1
Base element, without RI contact	1+0	VAL-MS BE	2817741	10
	1+0	VAL-MS-T1/T2 BE/O	2905650	12
	1+1			
	2+0	VAL-MS/2+0-BE	2804584	1
	3+0			

Base element, with RI contact	1+0	VAL-MS BE/FM	2817738	10
	1+0	VAL-MS-T1/T2 BE/O-FM	2905652	12
	1+1	VAL-MS/1+1-BE/FM	2920531	1
	2+0			
	2+0	VAL-MS/3+1-BE/FM	2838898	1
Base element, without RI contact	1+0	VAL-MS BE	2817741	10
	1+0	VAL-MS-T1/T2 BE/O	2905650	12
	1+1	VAL-MS/1+1-BE	2920528	1
	2+0			
	2+0	VAL-MS/3+1-BE	2838885	1



For 240/415 V TN and TT systems



For 240/415 V TN and TT systems,
marking rotated 180°



For 240/415 V TN and TT systems
with significantly higher voltage fluctuations

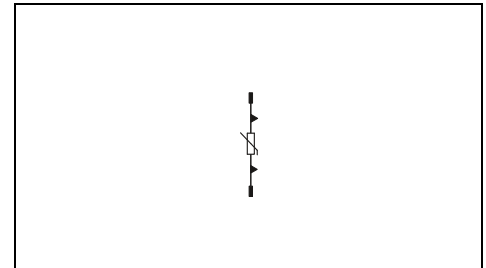
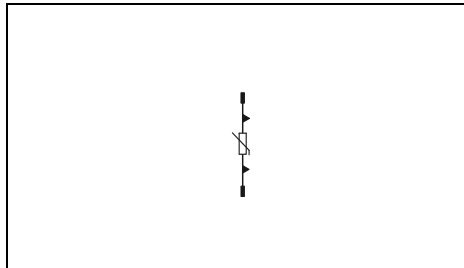
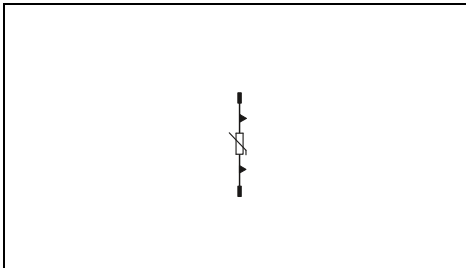

Technical data

II, T2
240/415 V AC (TN) /
240/415 V AC (TT)

230 V AC
275 V AC
20 kA
40 kA
≤ 1.35 kV

17.5 mm / 52.4 mm / 55.3 mm
-40°C ... 80°C
IEC 61643-11 / EN 61643-11

Technical data

II, T2
240/415 V AC (TN) /
240/415 V AC (TT)

230 V AC
275 V AC
20 kA
40 kA
≤ 1.35 kV

17.5 mm / 52.4 mm / 55.3 mm
-40°C ... 80°C
IEC 61643-11 / EN 61643-11

Technical data

II, T2
240/415 V AC (TN) /
240/415 V AC (TT) /
230 V AC (IT)

230 V AC
385 V AC
20 kA
40 kA
≤ 1.8 kV

17.5 mm / 52.4 mm / 55.3 mm
-40°C ... 80°C
IEC 61643-11 / EN 61643-11

Ordering data

Type	Order No.	Pcs./Pkt.
VAL-MS 230 ST	2798844	10

Accessories

VAL-MS BE/FM	2817738	10
VAL-MS-T1/T2 BE/O-FM	2905652	12
VAL-MS/1+1-BE/FM	2920531	1
VAL-MS/2+0-BE/FM	2805321	1
VAL-MS BE/2+0/1 U/FM	2907037	1
VAL-MS/3+0-BE/FM	2881803	1
VAL-MS/3+1-BE/FM	2838898	1
VAL-MS/4+0-BE/FM RN.	2906484	1
VAL-MS BE	2817741	10
VAL-MS-T1/T2 BE/O	2905650	12
VAL-MS/1+1-BE	2920528	1
VAL-MS/2+0-BE	2804584	1
VAL-MS/3+0-BE	2881816	1
VAL-MS/3+1-BE	2838885	1

Ordering data

Type	Order No.	Pcs./Pkt.
VAL-MS 230-UD-ST	2858962	1

Accessories

VAL-MS BE/FM	2817738	10
VAL-MS/3+1-BE/FM-UD	2858674	1
VAL-MS BE	2817741	10

Ordering data

Type	Order No.	Pcs./Pkt.
VAL-MS 230 IT ST	2807599	10

Accessories

VAL-MS BE/FM	2817738	10
VAL-MS-T1/T2 BE/O-FM	2905652	12
VAL-MS/1+1-BE/FM	2920531	1
VAL-MS/2+0-BE/FM	2805321	1
VAL-MS BE/2+0/1 U/FM	2907037	1
VAL-MS/3+0-BE/FM	2881803	1
VAL-MS/3+1-BE/FM	2838898	1
VAL-MS/4+0-BE/FM RN.	2906484	1
VAL-MS BE	2817741	10
VAL-MS-T1/T2 BE/O	2905650	12
VAL-MS/1+1-BE	2920528	1
VAL-MS/2+0-BE	2804584	1
VAL-MS/3+0-BE	2881816	1
VAL-MS/3+1-BE	2838885	1

Surge protection and interference suppression filters

Surge protection for the power supply

Type 2 surge protective device VALVETRAB MS

- Surge protection for individual assembly
- Optical, mechanical status indicator of the plug
- Disconnect device in the plug
- Base element coding the first time a plug is inserted
- Plugs can be tested with CHECKMASTER 2

Notes:

Choose the plug based on technical data.
Choose the base element corresponding to the required circuit and remote signaling function:
- TN-C: X+0 - circuit
- TN-S, TT: X+1 - circuit
- IT: Y+0 - circuit
- X = Number of phases
- Y = Number of phases + if required, neutral conductor
The number of plugs required corresponds to the number before the "+" in the circuit data, e.g., 3 plugs in a 3+1 circuit
When using a "+1" circuit, the F-MS 12 plug must be used between N and PE. See page 71



For IT systems with a voltage of 230 V phase-phase



For 240/415 V TN and TT systems with higher voltage fluctuations

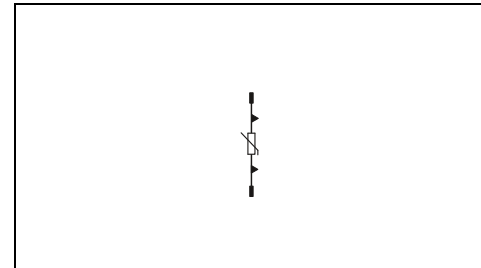
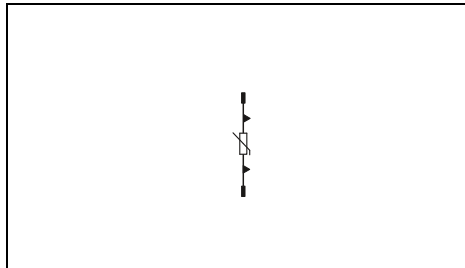

Technical data

Electrical data	
IEC test classification	II, T2
Nominal voltage U_N (IEC)	240/415 V AC (TN) / 240/415 V AC (TT) / 230 V AC (IT)
Nominal voltage U_N (UL)	230 V AC
Maximum continuous operating voltage U_C	385 V AC
Nominal discharge current I_n (8/20) μ s	20 kA
Max. discharge current I_{max} (8/20) μ s	40 kA
Protection level U_p	≤ 1.8 kV
General data	
Dimensions W/H/D	17.5 mm / 52.4 mm / 55.3 mm
Temperature range	-40°C ... 80°C
Test standards	IEC 61643-11 / EN 61643-11

Technical data

Electrical data	
IEC test classification	II, T2
Nominal voltage U_N (IEC)	240/415 V AC (TN) / 240/415 V AC (TT)
Nominal voltage U_N (UL)	320 V AC
Maximum continuous operating voltage U_C	335 V AC
Nominal discharge current I_n (8/20) μ s	20 kA
Max. discharge current I_{max} (8/20) μ s	40 kA
Protection level U_p	≤ 1.5 kV
General data	
Dimensions W/H/D	17.5 mm / 52.4 mm / 55.3 mm
Temperature range	-40°C ... 80°C
Test standards	IEC 61643-11 / EN 61643-11

Ordering data

Description	
VALVETRAB surge protection plug	

Type	Order No.	Pcs./Pkt.
VAL-MS 230 IT ST	2807599	10

Ordering data

Type	Order No.	Pcs./Pkt.
VAL-MS 320 ST	2838843	10

Accessories

Base element, with RI contact	
orthogonal	1+0
	1+0
	1+1
	2+0
orthogonal	2+0
	3+0
	3+1
	4+0
Base element, without RI contact	
orthogonal	1+0
	1+0
	1+1
	2+0
	3+0
	3+1

Type	Order No.	Pcs./Pkt.
VAL-MS BE/FM	2817738	10
VAL-MS-T1/T2 BE/O-FM	2905652	12
VAL-MS/2+0-BE/FM	2805321	1
VAL-MS BE/2+0/1U/FM	2907037	1
VAL-MS/3+0-BE/FM	2881803	1
VAL-MS/4+0-BE/FM RN.	2906484	1
VAL-MS BE	2817741	10
VAL-MS-T1/T2 BE/O	2905650	12
VAL-MS/2+0-BE	2804584	1
VAL-MS/3+0-BE	2881816	1

Accessories

Type	Order No.	Pcs./Pkt.
VAL-MS BE/FM	2817738	10
VAL-MS-T1/T2 BE/O-FM	2905652	12
VAL-MS/1+1-BE/FM	2920531	1
VAL-MS/2+0-BE/FM	2805321	1
VAL-MS BE/2+0/1U/FM	2907037	1
VAL-MS/3+0-BE/FM	2881803	1
VAL-MS/3+1-BE/FM	2838898	1
VAL-MS/4+0-BE/FM RN.	2906484	1
VAL-MS BE	2817741	10
VAL-MS-T1/T2 BE/O	2905650	12
VAL-MS/1+1-BE	2920528	1
VAL-MS/2+0-BE	2804584	1
VAL-MS/3+0-BE	2881816	1
VAL-MS/3+1-BE	2838885	1



For 240/415 V TN and TT systems with higher voltage fluctuations, marking rotated 180°



For 240/415 V TN and TT systems with significantly higher voltage fluctuations



For 400/690 V TN systems, 400 V IT systems, 500 V IT systems, with higher voltage fluctuations

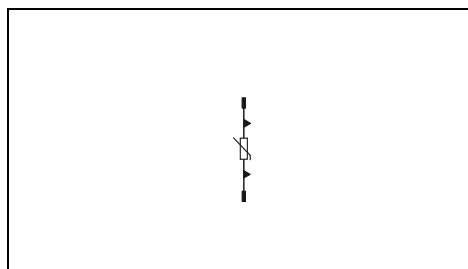
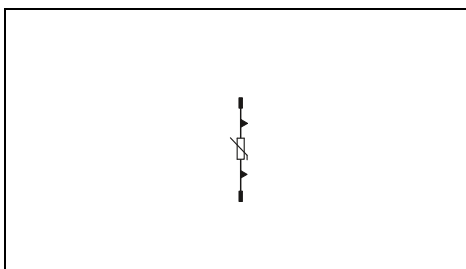
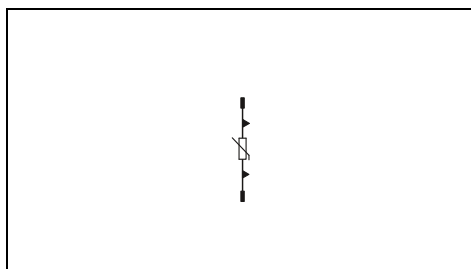

Technical data
II, T2
240/415 V AC (TN) / 240/415 V AC (TT)
320 V AC
335 V AC
20 kA
40 kA
≤ 1.5 kV
17.5 mm / 52.4 mm / 55.3 mm
-40°C ... 80°C
IEC 61643-11 / EN 61643-11

Technical data
II, T2
240/415 V AC (TN) / 240/415 V AC (TT) / 230 V AC (IT)
400 V AC
440 V AC
20 kA
40 kA
≤ 2.2 kV
17.5 mm / 52.4 mm / 55.3 mm
-40°C ... 80°C
IEC 61643-11 / EN 61643-11

Technical data
II, T2
400/690 V AC (TN) / 500 V AC (IT)
500 V AC
600 V AC
15 kA
30 kA
≤ 2.7 kV
17.5 mm / 52.4 mm / 55.3 mm
-40°C ... 80°C
IEC 61643-11 / EN 61643-11

Ordering data		
Type	Order No.	Pcs./Pkt.
VAL-MS 320-UD ST	2858315	10

Ordering data		
Type	Order No.	Pcs./Pkt.
VAL-MS 400 ST	2816399	10

Ordering data		
Type	Order No.	Pcs./Pkt.
VAL-MS 500 ST	2807609	10

Accessories		
Type	Order No.	Pcs./Pkt.
VAL-MS BE/FM	2817738	10
VAL-MS/3+1-BE/FM-UD	2858674	1
VAL-MS BE	2817741	10

Accessories		
Type	Order No.	Pcs./Pkt.
VAL-MS BE/FM	2817738	10
VAL-MS-T1/T2 BE/O-FM	2905652	12
VAL-MS/2+0-BE/FM	2805321	1
VAL-MS BE/2+0/1U/FM	2907037	1
VAL-MS/3+0-BE/FM	2881803	1
VAL-MS/4+0-BE/FM RN.	2906484	1
VAL-MS BE	2817741	10
VAL-MS-T1/T2 BE/O	2905650	12
VAL-MS/2+0-BE	2804584	1
VAL-MS/3+0-BE	2881816	1

Accessories		
Type	Order No.	Pcs./Pkt.
VAL-MS BE/FM	2817738	10
VAL-MS-T1/T2 BE/O-FM	2905652	12
VAL-MS/3+0-BE/FM	2881803	1
VAL-MS/4+0-BE/FM RN.	2906484	1
VAL-MS BE	2817741	10
VAL-MS-T1/T2 BE/O	2905650	12
VAL-MS/3+0-BE	2881816	1

Surge protection and interference suppression filters

Surge protection for the power supply

Type 2 surge protective device VALVETRAB MS

- Surge protection for individual assembly
- Optical, mechanical status indicator of the plug
- Disconnect device in the plug
- Base element coding the first time a plug is inserted
- Plugs can be tested with CHECKMASTER 2

Notes:
 Choose the plug based on technical data.
 Choose the base element corresponding to the required circuit and remote signaling function:
 - TN-C: X+0 - circuit
 - TN-S, TT: X+1 - circuit
 - IT: Y+0 - circuit
 - X = Number of phases
 - Y = Number of phases + if required, neutral conductor
 The number of plugs required corresponds to the number before the "+" in the circuit data, e.g., 3 plugs in a 3+1 circuit
 When using a "+1" circuit, the F-MS 12 plug must be used between N and PE. See page 71



For 400/690 V TN systems, 400 V IT systems, 500 V IT systems

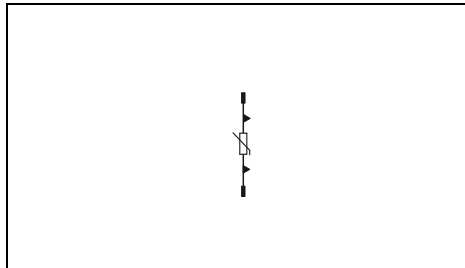

Technical data

Electrical data	
IEC test classification	II, T2
Nominal voltage U_N (IEC)	400/690 V AC (TN) / 500 V AC (IT)
Nominal voltage U_N (UL)	400 V AC
Maximum continuous operating voltage U_C	580 V AC
Nominal discharge current I_n (8/20) μ s	15 kA
Max. discharge current I_{max} (8/20) μ s	30 kA
Protection level U_p	≤ 2.5 kV
General data	
Dimensions W/H/D	17.5 mm / 52.4 mm / 55.3 mm
Temperature range	-40°C ... 80°C
Test standards	IEC 61643-11 / EN 61643-11



For 24 V DC, 48 V DC with isolation monitoring, free of leakage current

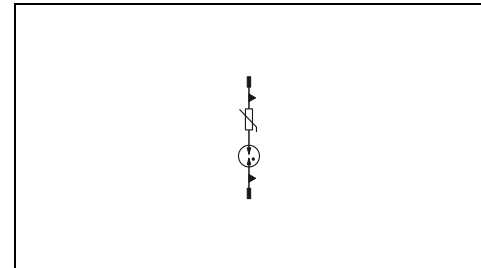

Technical data

Electrical data	
IEC test classification	II, T2
Nominal voltage U_N (IEC)	5 V AC ... 48 V AC
Nominal voltage U_N (UL)	48 V AC
Maximum continuous operating voltage U_C	75 V AC / 100 V DC
Nominal discharge current I_n (8/20) μ s	10 kA
Max. discharge current I_{max} (8/20) μ s	20 kA
Protection level U_p	≤ 1.4 kV
General data	
Dimensions W/H/D	17.5 mm / 52.4 mm / 55.3 mm
Temperature range	-40°C ... 80°C
Test standards	IEC 61643-11 / EN 61643-11

Ordering data

Description	
VALVETRAB surge protection plug	

Type	Order No.	Pcs./Pkt.
VAL-MS 580-ST	2920434	10

Ordering data

Type	Order No.	Pcs./Pkt.
VAL-MS 75 VF ST	2805318	10

Accessories

Base element, with RI contact			
orthogonal	1+0	VAL-MS BE/FM	2817738
	1+0	VAL-MS-T1/T2 BE/O-FM	2905652
	1+1		
	2+0		
orthogonal	2+0		
	3+0	VAL-MS/3+0-BE/FM	2881803
	3+1		
	4+0	VAL-MS/4+0-BE/FM RN.	2906484
Base element, without RI contact			
orthogonal	1+0	VAL-MS BE	2817741
	1+0	VAL-MS-T1/T2 BE/O	2905650
	1+1		
	2+0		
	3+0	VAL-MS/3+0-BE	2881816
	3+1		

Type	Order No.	Pcs./Pkt.
VAL-MS BE/FM	2817738	10
VAL-MS-T1/T2 BE/O-FM	2905652	12
VAL-MS/1+1-BE/FM	2920531	1
VAL-MS/2+0-BE/FM	2805321	1
VAL-MS BE/2+0/1U/FM	2907037	1
VAL-MS BE	2817741	10
VAL-MS-T1/T2 BE/O	2905650	12
VAL-MS/1+1-BE	2920528	1
VAL-MS/2+0-BE	2804584	1



For 240/415 V TN and TT systems with significantly higher voltage fluctuations, free of leakage current



For 240/415 V TN and TT systems on a spark gap basis, can only be used for N-PE



For 240/415 V TN and TT systems on a spark gap basis, can only be used for N-PE, marking rotated 180°

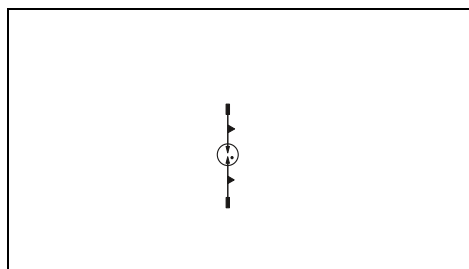
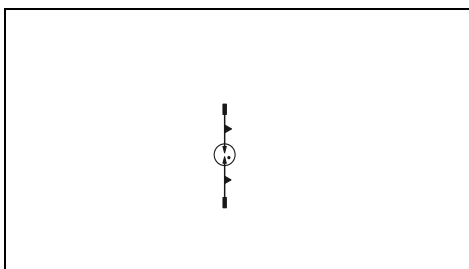
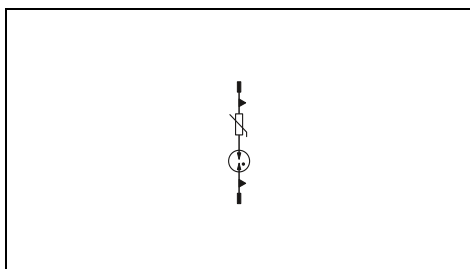

Technical data
II, T2
240/415 V AC (TN) / 240/415 V AC (TT) / 230 V AC (IT)
350 V AC
350 V AC
10 kA
20 kA
≤ 1.5 kV
17.5 mm / 52.4 mm / 55.3 mm
-40°C ... 80°C
IEC 61643-11 / EN 61643-11

Technical data
II, T2
240/415 V AC (TN - only N-PE) / 240/415 V AC (TT - only N-PE)
- V AC
260 V AC
20 kA
40 kA
≤ 1.5 kV
17.5 mm / 52.4 mm / 55.3 mm
-40°C ... 80°C
IEC 61643-11 / EN 61643-11

Technical data
II, T2
240/415 V AC (TN - only N-PE) / 240/415 V AC (TT - only N-PE)
- V AC
260 V AC
20 kA
40 kA
≤ 1.5 kV
17.5 mm / 52.4 mm / 55.3 mm
-40°C ... 80°C
IEC 61643-11 / EN 61643-11

Ordering data		
Type	Order No.	Pcs./Pkt.
VAL-MS 350 VF ST	2856595	10

Ordering data		
Type	Order No.	Pcs./Pkt.
F-MS 12 ST	2817990	10

Ordering data		
Type	Order No.	Pcs./Pkt.
F-MS 12-UD ST	2858328	10

Accessories		
Type	Order No.	Pcs./Pkt.
VAL-MS BE/FM	2817738	10
VAL-MS-T1/T2 BE/O-FM	2905652	12
VAL-MS/1+1-BE/FM	2920531	1
VAL-MS/2+0-BE/FM	2805321	1
VAL-MS BE/2+0/1U/FM	2907037	1
VAL-MS/3+0-BE/FM	2881803	1
VAL-MS/3+1-BE/FM	2838898	1
VAL-MS/4+0-BE/FM RN.	2906484	1
VAL-MS BE	2817741	10
VAL-MS-T1/T2 BE/O	2905650	12
VAL-MS/1+1-BE	2920528	1
VAL-MS/2+0-BE	2804584	1
VAL-MS/3+0-BE	2881816	1
VAL-MS/3+1-BE	2838885	1

Accessories		
Type	Order No.	Pcs./Pkt.
VAL-MS BE/FM	2817738	10
VAL-MS-T1/T2 BE/O-FM	2905652	12
VAL-MS/1+1-BE/FM	2920531	1
VAL-MS/3+1-BE/FM	2838898	1
VAL-MS BE	2817741	10
VAL-MS-T1/T2 BE/O	2905650	12
VAL-MS/1+1-BE	2920528	1
VAL-MS/3+1-BE	2838885	1

Accessories		
Type	Order No.	Pcs./Pkt.
VAL-MS BE/FM	2817738	10
VAL-MS/3+1-BE/FM-UD	2858674	1
VAL-MS BE	2817741	10

Surge protection and interference suppression filters

Surge protection for the power supply

Type 2 surge protective device VALVETRAB MB

- Double terminal block for safe and easy equipotential bonding connection
- Screw shafts with raised domes to ensure safe working
- Main connections with extended insertion funnels for increased resistance to creepage
- Optical, mechanical status indication for the individual arresters
- Visual display for checking the status directly on the device
- Pluggable signal connection for remote status signaling
- Compact design for space-saving installation



One-piece surge protection for PV applications up to 1500 V DC

KEBA

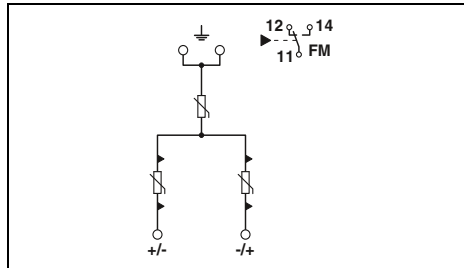

Technical data

Electrical data		
IEC test classification		PV II, T2
Mode of protection		(L+) - (L-) / (L+) - PE / (L-) - PE
Maximum continuous operating voltage U_{CPV}		1500 V DC
Nominal discharge current I_n (8/20) μ s		20 kA
Max. discharge current I_{max} (8/20) μ s		40 kA
Protection level U_p		≤ 4.5 kV
Response time t_A		≤ 25 ns
Short-circuit current I_{SCPV}		2000 A
General data		
Dimensions W/H/D		71.2 mm / 120 mm / 65.5 mm
IEC connection data	Rigid / flexible / AWG	- mm ² / 2.5 ... 35 mm ² / 14 ... 2
Temperature range		-40°C ... 80°C
Test standards		EN 50539-11
Remote indication contact		
IEC connection data	Rigid / flexible / AWG	PDT contact 0.14 ... 1.5 mm ² / 0.14 ... 1.5 mm ² / 28 ... 16
Max. operating voltage		250 V AC / 5 V DC ... 30 V DC
Max. operating current		1.5 A AC / 5 mA DC ... 1 A DC

Ordering data

Description	Type	Order No.	Pcs./Pkt.
VALVETRAB MB...PV			
with remote indication contact	VAL-MB-T2 1500DC-PV/2+V-FM	2905646	1
without remote indication contact	VAL-MB-T2 1500DC-PV/2+V	2905647	1

Accessories

The product is also suitable for applications in PV systems with a max. short-circuit current $I_{SCPV} = 15$ kA (in accordance with EN 50539-11:2013).

Type 2 surge protective device VALVETRAB MS

- Type 2 surge protective device with consistent pluggable design
- For insulated and single-sided grounded PV applications
- Reliable contact, thanks to integrated rotating latch
- Optical, mechanical status indication for the individual arresters
- With or without floating remote indication contact
- Mechanical coding of all slots
- Plugs can be tested with CHECKMASTER 2



Pluggable surge protection, for PV applications up to 1000 V DC, 1 MPP tracker



Pluggable surge protection, for PV applications up to 1000 V DC, 3 MPP trackers

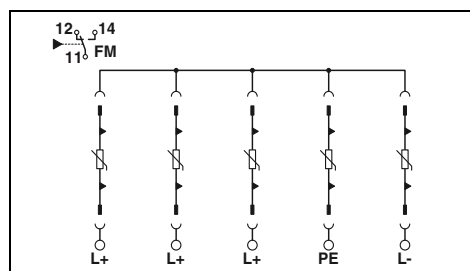
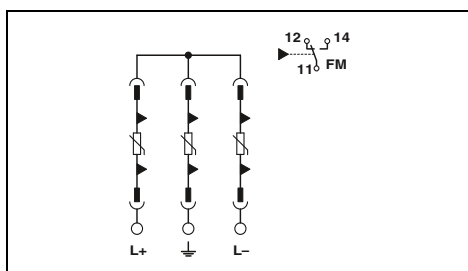

Electrical data	
IEC test classification	
Mode of protection	
Maximum continuous operating voltage U_{CPV}	
Max. discharge current I_{max} (8/20) μ s	
Protection level U_p	
Response time tA	
Short-circuit current I_{SCPV}	
General data	
Dimensions W/H/D	
IEC connection data	Rigid / flexible / AWG
UL connection data	AWG
Temperature range	
Test standards	
Remote indication contact	
IEC connection data	Rigid / flexible / AWG
UL connection data	AWG
Max. operating voltage	
Max. operating current	

Technical data		
... 1500DC	... 1000DC	... 600DC
PV II, T2	PV II, T2	PV II, T2
(L+) - (L-) / (L+)	(L+) - (L-) / (L+)	(L+) - (L-) / (L+)
- PE / (L-) - PE	- PE / (L-) - PE	- PE / (L-) - PE
1500 V DC	1170 V DC	800 V DC
30 kA	40 kA	40 kA
≤ 5 kV	≤ 3.7 kV	≤ 2.7 kV
≤ 25 ns	≤ 25 ns	≤ 25 ns
2000 A	2000 A	2000 A
General data		
53.4 mm / 98.7 mm / 65.7 mm		
1.5 ... 35 mm ² / 1.5 ... 25 mm ² / 15 ... 2		
10 ... 2		
-40°C ... 85°C		
EN 50539-11		
PDT contact		
0.14 ... 1.5 mm ² / 0.14 ... 1.5 mm ² / 28 ... 16		
30 ... 14		
- / 30 V DC		
1 A AC / 1 A DC		

Technical data	
... 1000DC	
PV II, T2	
(L+) - (L-) / (L+) - PE / (L-) - PE	
1170 V DC	
40 kA	
≤ 3.8 kV	
≤ 25 ns	
2000 A	
General data	
89 mm / 98.57 mm / 64.7 mm	
1.5 ... 35 mm ² / 1.5 ... 25 mm ² / 15 ... 2	
10 ... 2	
-40°C ... 85°C	
EN 50539-11	
PDT contact	
0.14 ... 1.5 mm ² / 0.14 ... 1.5 mm ² / 28 ... 16	
30 ... 14	
125 V AC / 30 V DC	
3 A AC / 3 A DC	

Description	
VALVETRAB MS...PV	
with remote indication contact	
without remote indication contact	
VALVETRAB MS...PV	
with remote indication contact	
without remote indication contact	
VALVETRAB MS...PV	
with remote indication contact	
without remote indication contact	

Ordering data			
Type	Order No.	Pcs./Pkt.	
VAL-MS 1500DC-PV/2+V-FM	1033725	1	
VAL-MS 1500DC-PV/2+V	1033708	1	
VAL-MS 1000DC-PV/2+V-FM	2800627	1	
VAL-MS 1000DC-PV/2+V	2800628	1	
VAL-MS 600DC-PV/2+V-FM	2800641	1	
VAL-MS 600DC-PV/2+V	2800642	1	

Ordering data			
Type	Order No.	Pcs./Pkt.	
VAL-MS-CN 1000DC-PV/4+V-FM	2907820	1	

Replacement plug	
1500 V DC	(DC+) - (DC-) / (DC+) - G / (DC-) - G
1000 V DC	(L+) - (L-) / (L+) - G / (L-) - G
600 V DC	(L+) - (L-) / (L+) - G / (L-) - G
Base element	

Accessories			
Type	Order No.	Pcs./Pkt.	
VAL-MS 1500DC-PV-ST	1033727	3	
VAL-MS 1000DC-PV-ST	2800624	1	
VAL-MS 600DC-PV-ST	2800623	1	

Accessories			
Type	Order No.	Pcs./Pkt.	
VAL-MS 4+V/BE/FM	2908725	1	

Surge protection and interference suppression filters

Surge protection for the power supply

Type 2 surge protective device VALVETRAB combi MCB

- Combinations of type 2 surge protective devices with integrated arrester backup fuse
- Overload of the surge protection results in all-position disconnection from the mains
- Signaling to monitoring systems via remote indication contact in the event of an error
- Surge-proof arrester backup fuse tailored to type 2 surge protective devices
- Type 2 surge protective device with consistent pluggable design
- Disconnect device on each individual plug
- Optical, mechanical status indication for all protective plugs
- Plugs can be tested with CHECKMASTER 2

Notes:
If only one value is specified under mode of protection in the technical data, this value is valid for all modes of protection specified.

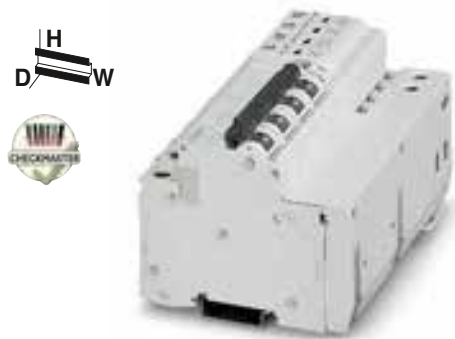

5-conductor system; L1, L2, L3, N, PE with integrated backup fuse

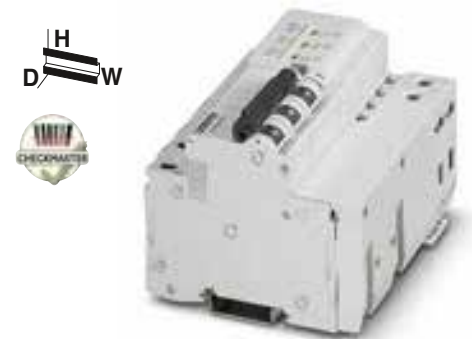

4-conductor system; L1, L2, L3, PEN with integrated backup fuse

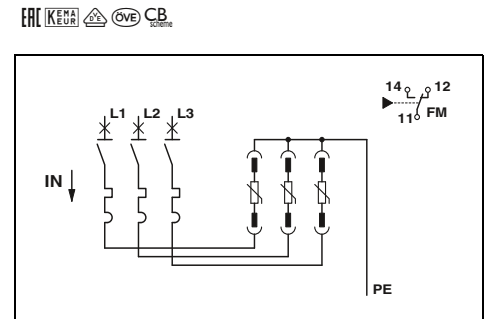
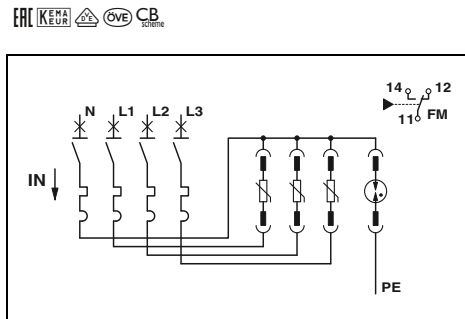

Technical data	
... 3S-350	... 1S-350
II, T2	II, T2
240/415 V AC (TN-S) / 240/415 V AC (TT)	240 V AC (TN-S) / 240 V AC (TT)
L-N / L-PE / N-PE	L-N / L-PE / N-PE
350 V AC / 350 V AC / 264 V AC	350 V AC / 350 V AC / 264 V AC
20 kA	20 kA
30 kA	30 kA
≤ 2.5 kV / - / ≤ 1.7 kV	≤ 2.5 kV / - / ≤ 1.7 kV
- / - / 100 A	- / - / 100 A
≤ 25 ns / ≤ 100 ns / ≤ 100 ns	≤ 25 ns / ≤ 100 ns / ≤ 100 ns
25 kA	25 kA
Dimensions W/H/D	131.5 mm / 101 mm / 76 mm
IEC connection data	4 ... 35 mm ² / 4 ... 25 mm ² / 18 ... 2
Temperature range	-25°C ... 60°C
Test standards	IEC 61643-11 / EN 61643-11 / IEC 60364-4-443 / PDT contact
Remote indication contact	PDT contact
IEC connection data	0.14 ... 1.5 mm ² / 0.14 ... 1.5 mm ² / 28 ... 16
Max. operating voltage	250 V AC / 250 V DC
Max. operating current	2 A AC / 1 mA DC ... 50 mA DC

Technical data	
... 3C-350	
II, T2	
240/415 V AC (TN-C)	
L-PEN	
350 V AC	
20 kA	
30 kA	
≤ 2.5 kV	
-	
≤ 25 ns	
25 kA	
Dimensions W/H/D	114 mm / 101 mm / 76 mm
IEC connection data	4 ... 35 mm ² / 4 ... 25 mm ² / 18 ... 2
Temperature range	-25°C ... 60°C
Test standards	IEC 61643-11 / EN 61643-11 / IEC 60364-4-443 / PDT contact
Remote indication contact	PDT contact
IEC connection data	0.14 ... 1.5 mm ² / 0.14 ... 1.5 mm ² / 28 ... 16
Max. operating voltage	250 V AC / 250 V DC
Max. operating current	2 A AC / 1 mA DC ... 50 mA DC

Ordering data		
Type	Order No.	Pcs./Pkt.
VAL-CP-MCB-3S-350/40/FM	2882750	1
VAL-CP-MCB-1S-350/40/FM	2882763	1

Ordering data		
Type	Order No.	Pcs./Pkt.
VAL-CP-MCB-3C-350/40/FM	2882776	1

Accessories		
Type	Order No.	Pcs./Pkt.
VAL-CP-350-ST-GY	2882718	10
VAL-CP-N/PE-350-ST-GY	2882734	10

Accessories		
Type	Order No.	Pcs./Pkt.
VAL-CP-350-ST-GY	2882718	10

Description	
VALVETRAB compact, with an arrester backup fuse	
3-phase	
1-phase	
Replacement plug	L-N/L-PEN N-PE

Type 2 surge protective device VALVETRAB combi MCB

- Combinations of type 2 surge protective devices with integrated arrester backup fuse
- For 60 mm system technology
- Tool-free mounting on 5 and 10 mm thick busbars
- Signaling to monitoring systems via remote indication contact in the event of an error
- Surge-proof arrester backup fuse tailored to type 2 surge protective devices
- Type 2 surge protective device with consistent pluggable design
- Disconnect device on each individual plug
- Optical, mechanical status indication for all protective plugs
- Plugs can be tested with CHECKMASTER 2

Notes:
If only one value is specified under mode of protection in the technical data, this value is valid for all modes of protection specified.

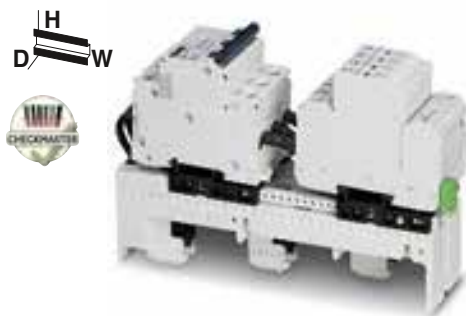

5-conductor system; L1, L2, L3, N, PE
for 60 mm system technology

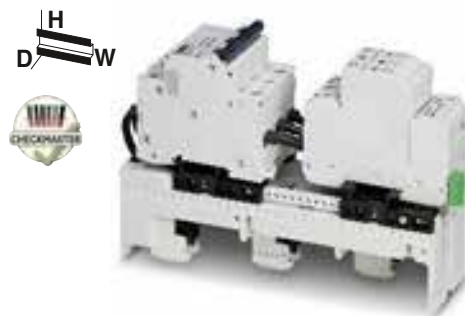

4-conductor system; L1, L2, L3, PEN
for 60 mm system technology

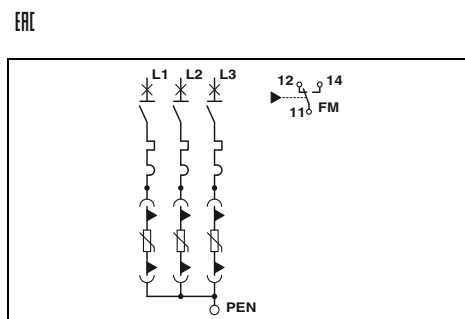
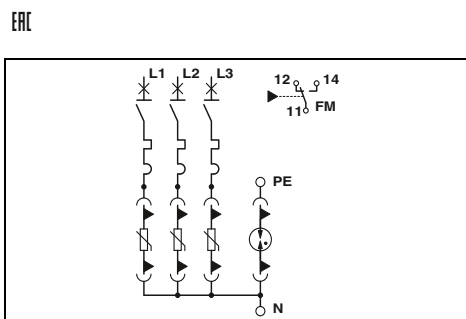

Electrical data	
IEC test classification	II, T2
Nominal voltage U_N	240/415 V AC (TN-S) / 240/415 V AC (TT)
Mode of protection	
Maximum continuous operating voltage U_c	L-N / L-PE / N-PE 350 V AC / 350 V AC / 264 V AC
Nominal discharge current I_n (8/20) μ s	20 kA
Max. discharge current I_{max} (8/20) μ s	25 kA / 25 kA / 40 kA
Protection level U_p	≤ 2.5 kV / - / ≤ 1.5 kV
Response time t_A	≤ 25 ns / ≤ 100 ns / ≤ 100 ns
Short-circuit current rating I_{SCCR}	25 kA
General data	
Dimensions W/H/D	54 mm / 220 mm / 134 mm
IEC connection data	Rigid / flexible / AWG 2.5 ... 25 mm ² / 2.5 ... 16 mm ² / 12 ... 4
Temperature range	-25°C ... 55°C
Test standards	IEC 61643-11 / EN 61643-11
Remote indication contact	PDT contact
IEC connection data	Rigid / flexible / AWG 0.14 ... 1.5 mm ² / 0.14 ... 1.5 mm ² / 28 ... 16
Max. operating voltage	250 V AC / 125 V DC (200 mA DC)
Max. operating current	1 A AC / 1 A DC (30 V DC)

Technical data

Ordering data		
Type	Order No.	Pcs./Pkt.
VAL-CP-MOSO 60-3S-FM	2804403	1
Accessories		
VAL-CP-350-ST-GY	2882718	10
VAL-CP-N/PE-350-ST-GY	2882734	10

Technical data

Ordering data		
Type	Order No.	Pcs./Pkt.
VAL-CP-MOSO 60-3C-FM	2804416	1
Accessories		
VAL-CP-350-ST-GY	2882718	10

Description	
VALVETRAB compact	
Replacement plug	
L-N/L-PEN N-PE	

Ordering data		
Type	Order No.	Pcs./Pkt.
VAL-CP-MOSO 60-3S-FM	2804403	1
Accessories		
VAL-CP-350-ST-GY	2882718	10
VAL-CP-N/PE-350-ST-GY	2882734	10

Ordering data		
Type	Order No.	Pcs./Pkt.
VAL-CP-MOSO 60-3C-FM	2804416	1
Accessories		
VAL-CP-350-ST-GY	2882718	10

Surge protection and interference suppression filters

Surge protection for the power supply

Type 2 surge protective device for LED applications

- Universal use for street, tunnel or object lighting
- Flexible installation
- Fixed via integrated elongated holes
- Compact design
- Optical, mechanical status indicator
- Connection in branch or through wiring
- Double or reinforced insulation

new



Nominal voltage up to 230 V



Nominal voltage up to 277 V

ERC KEBA CB

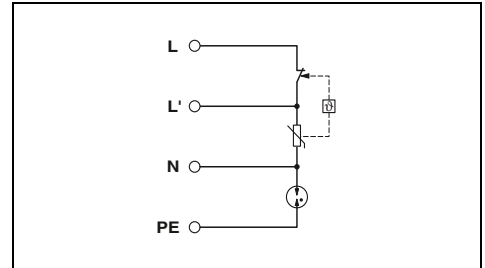
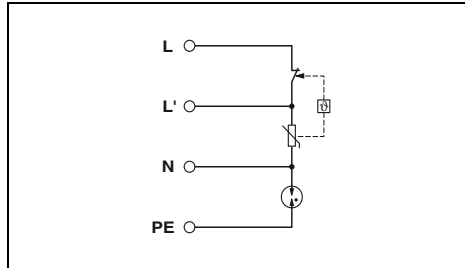

Technical data

Technical data

Electrical data	
IEC test classification	II / III, T2 / T3
Nominal voltage U_N	100 V AC ... 230 V AC (TN-S) / 100 V AC ... 230 V AC (TT)
Mode of protection	L-N / L-PE / N-PE
Maximum continuous operating voltage U_C	305 V AC / 255 V AC / 255 V AC
Combination wave U_{OC}	10 kV / 10 kV
Nominal discharge current I_n (8/20) μ s	5 kA / 5 kA / 10 kA
Max. discharge current I_{max} (8/20) μ s	10 kA / 10 kA / 20 kA
Protection level U_p	≤ 1.3 kV / ≤ 1.5 kV / ≤ 1.5 kV
Response time t_A	≤ 25 ns / ≤ 100 ns / ≤ 100 ns
Maximum backup fuse for branch wiring	16 A (MCB B/C)
General data	
Dimensions W/H/D	36.5 mm / 56 mm / 34 mm
IEC connection data	Rigid / flexible / AWG
Temperature range	0.2 ... 4 mm ² / 0.2 ... 2.5 mm ² / -40°C ... 80°C
Test standards	IEC 61643-11 / EN 61643-11

Technical data	
II / III, T2 / T3	
100 V AC ... 230 V AC (TN-S) / 100 V AC ... 230 V AC (TT)	
L-N / L-PE / N-PE	
305 V AC / 255 V AC / 255 V AC	
10 kV / 10 kV	
5 kA / 5 kA / 10 kA	
10 kA / 10 kA / 20 kA	
≤ 1.3 kV / ≤ 1.5 kV / ≤ 1.5 kV	
≤ 25 ns / ≤ 100 ns / ≤ 100 ns	
16 A (MCB B/C)	
General data	
36.5 mm / 56 mm / 34 mm	
Rigid / flexible / AWG	
0.2 ... 4 mm ² / 0.2 ... 2.5 mm ² / -40°C ... 80°C	
IEC 61643-11 / EN 61643-11	

Technical data	
II / III, T2 / T3	
100 V AC ... 277 V AC (TN-S) / 100 V AC ... 277 V AC (TT)	
L-N / L-PE / N-PE	
320 V AC / 305 V AC / 305 V AC	
10 kV	
5 kA / 5 kA / 10 kA	
10 kA / 10 kA / 20 kA	
≤ 1.3 kV / ≤ 1.5 kV / ≤ 1.4 kV	
≤ 25 ns / - / ≤ 100 ns	
16 A (MCB B/C)	
General data	
36.5 mm / 56 mm / 34 mm	
Rigid / flexible / AWG	
0.2 ... 4 mm ² / 0.2 ... 2.5 mm ² / -40°C ... 80°C	
IEC 61643-11 / EN 61643-11	

Ordering data

Ordering data

Description	BLOCKTRAB, for universal mounting	
-------------	-----------------------------------	--

Type	Order No.	Pcs./Pkt.
BLTF2-1S-305-UT	1078433	10

Type	Order No.	Pcs./Pkt.
BLT2-1S-320-UT	2906101	10



Nominal voltage up to 277 V

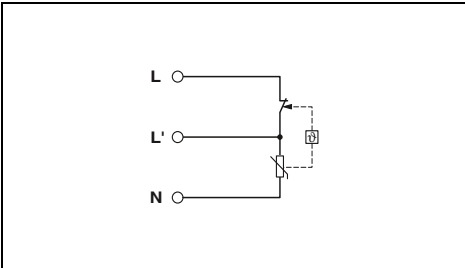

Technical data

II / III, T2 / T3
100 V AC ... 277 V AC

L-N
320 V AC
10 kV
5 kA
10 kA
≤ 1.3 kV
≤ 25 ns
16 A (MCB B/C)

36.5 mm / 56 mm / 34 mm
0.2 ... 4 mm² / 0.2 ... 2.5 mm² / -
-40°C ... 80°C
IEC 61643-11 / EN 61643-11

Ordering data

Type	Order No.	Pcs./Pkt.
BLT-T2-320-UT	2906100	10

Surge protection and interference suppression filters

Surge protection for the power supply

Type 2 surge protective device for PCB mounting

- Powerful type 2 surge protection
- Can be soldered directly onto the printed-circuit board
- Very small footprint
- Low height matching standard PCB components
- Available with remote indication contact or visual status indicator as an option
- Safe mechanical disconnection in the event of an overload



3-conductor system; L, N, PE with visual status indicator



3-conductor system; L, N, PE with remote indication contact

Notes:

If only one value is specified under mode of protection in the technical data, this value is valid for all modes of protection specified.

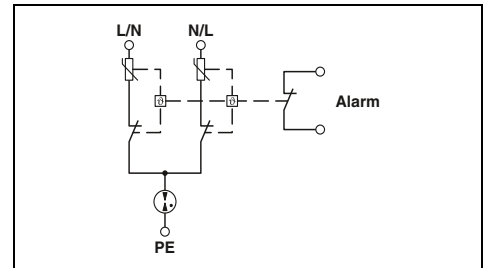
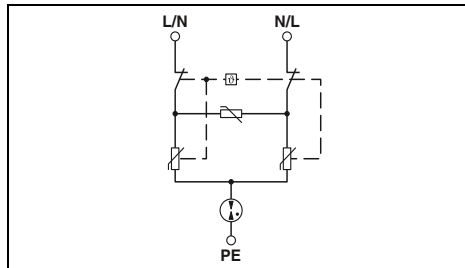

Technical data

Technical data

Electrical data	
IEC test classification	II, T2
Nominal voltage U_N	230 V AC (TN) / 230 V AC (TT)
Mode of protection	L-N / L-PE / N-PE
Maximum continuous operating voltage U_C	350 V AC
Nominal discharge current I_n (8/20) μ s	5 kA
Protection level U_p	≤ 1.5 kV
Response time t_A	≤ 25 ns / ≤ 100 ns / ≤ 100 ns
Short-circuit current rating I_{SCCR}	1 kA
Maximum backup fuse for branch wiring	16 A AC (MCB B/general purpose)

Electrical data	
IEC test classification	II, T2
Nominal voltage U_N	230 V AC (TN) / 230 V AC (TT)
Mode of protection	L-N / L-PE / N-PE
Maximum continuous operating voltage U_C	350 V AC
Nominal discharge current I_n (8/20) μ s	20 kA
Protection level U_p	≤ 2.5 kV / ≤ 1.8 kV / ≤ 1.8 kV
Response time t_A	≤ 25 ns / ≤ 100 ns / ≤ 100 ns
Short-circuit current rating I_{SCCR}	1 kA
Maximum backup fuse for branch wiring	63 A (MCB C)

General data	
Dimensions W/H/D	24 mm / 15.7 mm / 25.3 mm
Conductive path width	≥ 12 mm (2 OZ) / ≥ 8 mm (3 OZ)
Temperature range	-40°C ... 85°C
Test standards	IEC 61643-11 / EN 61643-11

General data	
Dimensions W/H/D	38.4 mm / 41 mm / 22.4 mm
Conductive path width	≥ 28 mm (2 OZ) / ≥ 19 mm (3 OZ)
Temperature range	-40°C ... 85°C
Test standards	IEC 61643-11 / EN 61643-11

Remote indication contact	
Max. operating voltage	- / -
Max. operating current	- / -

Remote indication contact	
Max. operating voltage	250 V AC / 30 V DC
Max. operating current	1 A AC / 1 A DC

Ordering data

Ordering data

Description	Type	Order No.	Pcs./Pkt.
PRINTRAB	PRT-1S-350/5S	2908551	10

Description	Type	Order No.	Pcs./Pkt.
PRINTRAB	PRT-1S-350/20R	2905977	20

Surge protection and interference suppression filters

Surge protection for the power supply

Type 2 surge protective device for PCB mounting

Solderable surge protection

- Can be soldered directly onto the printed-circuit board
- Very small footprint
- Low height matching standard PCB components
- Available with remote indication contact and/or visual status indicator
- Safe mechanical disconnection in the event of an overload

Solderable base element, 1-pos.

- Pluggable
- Direct soldering and fixing onto the PCB
- Double insulation between the remote signaling and main circuits
- For 1500 V DC and 690 V AC applications
- Suitable for all T1 and T2 VAL-MS ... plugs
- Integrated remote indication contact

new



1500 V DC applications, with visual indicator and remote indication contact, double insulation

new



1500 V DC and 690 V AC applications, with visual indicator and remote indication contact, double insulation

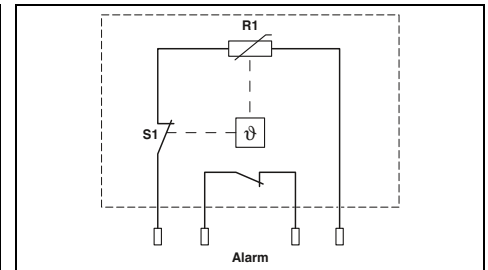
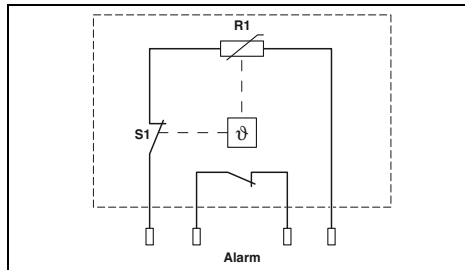

Technical data

Electrical data	
IEC test classification	T2, T2
Nominal voltage U_N	400 V AC (TN) / 690 V AC (TN) / 500 V AC (IT)
Mode of protection	
Maximum continuous operating voltage U_C	680 V AC (single item)
Maximum continuous operating voltage U_{CPV}	895 V DC (single item) 1790 V DC (2 serial connections)
Nominal discharge current I_n (8/20) μ s	
Max. discharge current I_{max} (8/20) μ s	20 kA
Protection level U_p	40 kA
Response time t_A	
Short-circuit current rating I_{SCCR}	≤ 2.7 kV (single item) / ≤ 4.5 kV (2 serial connections)
Short-circuit current I_{SCPV}	≤ 25 ns
Maximum backup fuse for branch wiring	25 kA
	-
	125 A (aR)
General data	
Dimensions W/H/D	18.8 mm / 44 mm / 41.9 mm
Conductive path width	≥ 10 mm
Temperature range	-40°C ... 85°C
Test standards	EN 50539-11 / IEC 61643-11 / IEC 61643-11
Remote indication contact	
Max. operating voltage	normal/deterioration
Max. operating current	30 V AC / 30 V DC
	1 A AC / 1 A DC

Technical data	
T2, T2	
400 V AC (TN) / 690 V AC (TN) / 500 V AC (IT)	
Mode of protection	
550 V AC (single item)	
750 V DC (single item)	
1500 V DC (2 serial connections)	
20 kA	
40 kA	
≤ 2.25 kV (single item) / ≤ 4.5 kV (2 serial connections)	
≤ 25 ns	
25 kA	
-	
125 A (aR)	
General data	
18.8 mm / 44 mm / 41.9 mm	
≥ 10 mm	
-40°C ... 85°C	
EN 50539-11 / IEC 61643-11 / IEC 61643-11	
Remote indication contact	
normal/deterioration	
30 V AC / 30 V DC	
1 A AC / 1 A DC	

Ordering data

Description	PRINTRAB
	VALVETRAB MS

Type	Order No.	Pcs./Pkt.
PRT-PV-P-1500/20-680	1026507	10

Ordering data

Type	Order No.	Pcs./Pkt.
PRT-PV-P-1500/20-550	1013424	10

new



Solder base element for VAL-MS... plugs

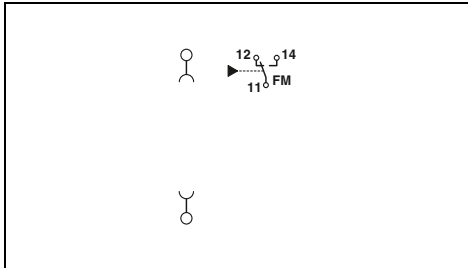

Technical data

I / II, T1 / T2

760 V AC
800 V DC

20 kA
40 kA

-
6000 A (DC)
250 A (gG)

20 mm / 88 mm / 53 mm

-40°C ... 85°C
IEC 61643-11 / EN 61643-11 / EN 50539-11

PDT contact
30 V AC / 30 V DC
1 A AC / 1 A DC

Ordering data

Type	Order No.	Pcs./Pkt.
VAL-MS-BE-PCB-FM	1035864	10

Surge protection and interference suppression filters

Surge protection for the power supply

Type 3 device protection PLUGTRAB SEC

- Varistor-based type 3 surge protection
- For single and three-phase power supply units
- With Push-in or screw connection technology
- Pluggable
- Through wiring
- Optical, mechanical status indicator
- With floating remote indication contact
- Plugs can be tested with CHECKMASTER 2

Notes:
If only one value is specified under mode of protection in the technical data, this value is valid for all modes of protection specified.



5-conductor system; L1, L2, L3, N, PE



new

3-conductor system, L, N, PE or DC+, DC-, PE, 24 V nominal voltage

ERC

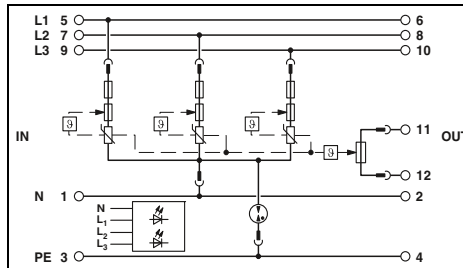

Technical data

III, T3
230 V AC
L-N / L-PE / N-PE
264 V AC
26 A (30°C)
3 kA
6 kV
L-N / L(N)-PE $\leq 1.4 \text{ kV} / \leq 1.5 \text{ kV}$
L-N / L(N)-PE $\leq 25 \text{ ns} / \leq 100 \text{ ns}$
1.5 kA AC

not required

Electrical data
IEC test classification
Nominal voltage U_N
Mode of protection
Maximum continuous operating voltage U_C

Rated load current I_L
Nominal discharge current I_n (8/20) μs
Combined surge U_{OC}
Protection level U_p
Response time t_A
Short-circuit current rating I_{SCCR}

Maximum backup fuse for branch wiring

General data
Dimensions W/H/D
IEC connection data Rigid / flexible / AWG
Temperature range
Test standards
Remote indication contact
IEC connection data Rigid / flexible / AWG
Max. operating voltage
Max. operating current

35.4 mm / 90 mm / 74.5 mm
0.2 ... 4 mm² / 0.2 ... 2.5 mm² / 24 ... 12
-40°C ... 70°C
IEC 61643-11 / EN 61643-11
N/C contact
0.2 ... 4 mm² / 0.2 ... 2.5 mm² / 24 ... 12
250 V AC / 125 V DC
3 A AC / 1 A DC (30 V DC)

Ordering data

Description	Type	Order No.	Pcs./Pkt.
PLUGTRAB-SEC, consisting of plug and base element			
Push-in connection technology			
Screw connection technology			
	PLT-SEC-T3-3S-230-FM	2905230	1

Accessories

Replacement plug	Type	Order No.	Pcs./Pkt.
Base element			
Push-in connection technology			
Screw connection technology			
	PLT-SEC-T3-3S-230-P	2905236	1

ERC KEBA CB

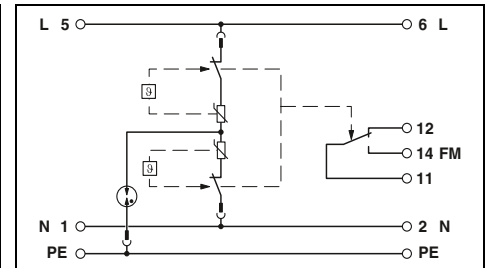

Technical data

III, T3
24 V AC
L-N / L-PE / N-PE
34 V AC
44 V DC
26 A (at 30°C)
1 kA
2 kV
 $\leq 0.2 \text{ kV} / \leq 0.6 \text{ kV}$
 $\leq 25 \text{ ns} / \leq 100 \text{ ns}$
10 kA AC
0.25 kA DC (without additional backup fuse) /
5 kA DC (for 20 A gG / B backup fuse)
32 A (gG / B / C)

17.7 mm / 101 mm / 74.5 mm
0.2 ... 4 mm² / 0.2 ... 2.5 mm² / 24 ... 12
-40°C ... 80°C
IEC 61643-11 / EN 61643-11
PDT contact
0.2 ... 2.5 mm² / 0.2 ... 2.5 mm² / 30 ... 12
250 V AC / 125 V DC
0.5 A AC / 0.5 A DC (75 V DC)

Ordering data

Description	Type	Order No.	Pcs./Pkt.
PLUGTRAB-SEC, consisting of plug and base element			
Push-in connection technology			
Screw connection technology			
	PLT-SEC-T3-24-FM-PT	2907925	5
	PLT-SEC-T3-24-FM-UT	2907916	5

Accessories

Replacement plug	Type	Order No.	Pcs./Pkt.
Base element			
Push-in connection technology			
Screw connection technology			
	PLT-SEC-T3-24-P-UT/PT	2907920	10
	PLT-SEC-T3-BE-FM-PT	2907929	10
	PLT-SEC-T3-BE-FM-UT	2907924	10

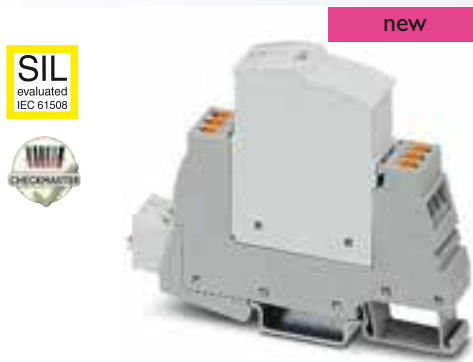

new

SIL
evaluated
IEC 61508



3-conductor system, L, N, PE or DC+, DC-, PE,
60 V nominal voltage



new

SIL
evaluated
IEC 61508



3-conductor system, L, N, PE or DC+, DC-, PE,
120 V nominal voltage

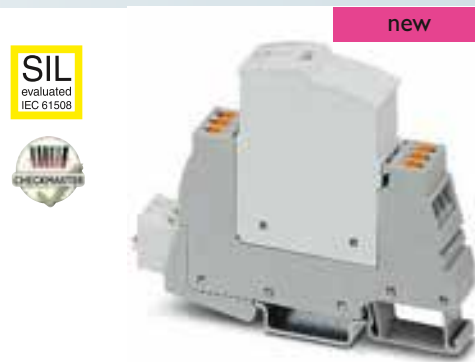

new

SIL
evaluated
IEC 61508



3-conductor system, L, N, PE or DC+, DC-, PE,
240 V nominal voltage

ERC (KEMA) CB

ERC (KEMA) CB

ERC (KEMA) CB

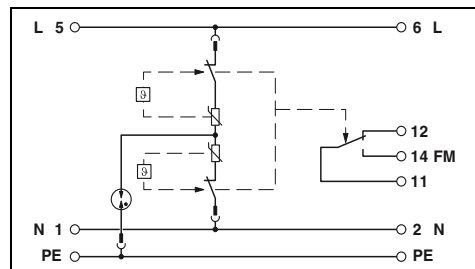
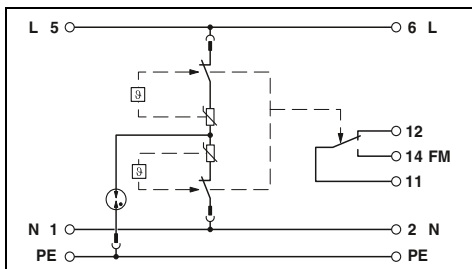
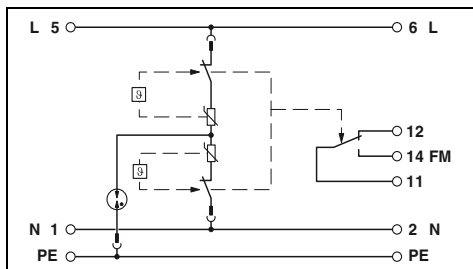

Technical data

Technical data

Technical data

III, T3
60 V AC
L-N / L-PE / N-PE
80 V AC
80 V DC
26 A (at 30°C)
2 kA
4 kV
≤ 0.48 kV / ≤ 0.8 kV
≤ 25 ns / ≤ 100 ns
10 kA AC
0.25 kA DC (without additional backup fuse) /
5 kA DC (for 20 A gG / B backup fuse)
32 A (gG / B / C)

II / III, T2 / T3
120 V AC
L-N / L-PE / N-PE
150 V AC
150 V DC
26 A (at 30°C)
5 kA
6 kV
≤ 0.75 kV (at U_{OC}) / ≤ 0.85 kV
≤ 25 ns / ≤ 100 ns
10 kA AC
0.25 kA DC (without additional backup fuse) /
5 kA DC (for 20 A gG / B backup fuse)
32 A (gG / B / C)

II / III, T2 / T3
240 V AC
L-N / L-PE / N-PE
264 V AC
240 V DC
26 A (at 30°C)
5 kA
6 kV
≤ 1.25 kV (at U_{OC}) / ≤ 1.4 kV
≤ 25 ns / ≤ 100 ns
10 kA AC
0.25 kA DC (without additional backup fuse) /
5 kA DC (for 20 A gG / B backup fuse)
32 A (gG / B / C)

17.7 mm / 101 mm / 74.5 mm
0.2 ... 4 mm² / 0.2 ... 2.5 mm² / 24 ... 12
-40°C ... 80°C
IEC 61643-11 / EN 61643-11
PDT contact
0.2 ... 2.5 mm² / 0.2 ... 2.5 mm² / 30 ... 12
250 V AC / 125 V DC
0.5 A AC / 0.5 A DC (75 V DC)

17.7 mm / 101 mm / 74.5 mm
0.2 ... 4 mm² / 0.2 ... 2.5 mm² / 24 ... 12
-40°C ... 80°C
IEC 61643-11 / EN 61643-11
PDT contact
0.2 ... 2.5 mm² / 0.2 ... 2.5 mm² / 30 ... 12
250 V AC / 125 V DC
0.5 A AC / 0.5 A DC (75 V DC)

17.7 mm / 101 mm / 74.5 mm
0.2 ... 4 mm² / 0.2 ... 2.5 mm² / 24 ... 12
-40°C ... 80°C
IEC 61643-11 / EN 61643-11
PDT contact
0.2 ... 2.5 mm² / 0.2 ... 2.5 mm² / 30 ... 12
250 V AC / 125 V DC
0.5 A AC / 0.5 A DC (75 V DC)

Ordering data

Ordering data

Ordering data

Type	Order No.	Pcs./Pkt.
PLT-SEC-T3-60-FM-PT	2907926	5
PLT-SEC-T3-60-FM-UT	2907917	5

Type	Order No.	Pcs./Pkt.
PLT-SEC-T3-120-FM-PT	2907927	5
PLT-SEC-T3-120-FM-UT	2907918	5

Type	Order No.	Pcs./Pkt.
PLT-SEC-T3-230-FM-PT	2907928	5
PLT-SEC-T3-230-FM-UT	2907919	5

Accessories

Accessories

Accessories

PLT-SEC-T3-60-P-UT/PT	2907921	10
PLT-SEC-T3-BE-FM-PT	2907929	10
PLT-SEC-T3-BE-FM-UT	2907924	10

PLT-SEC-T3-120-P-UT/PT	2907922	10
PLT-SEC-T3-BE-FM-PT	2907929	10
PLT-SEC-T3-BE-FM-UT	2907924	10

PLT-SEC-T3-230-P-UT/PT	2907923	10
PLT-SEC-T3-BE-FM-PT	2907929	10
PLT-SEC-T3-BE-FM-UT	2907924	10

Surge protection and interference suppression filters

Surge protection for the power supply

Type 3 device protection PLUGTRAB

- For 48 V DC or 230 V IT power supply equipment
- Pluggable
- Through wiring
- Optical status indicator via LED
- Tool-free plug replacement
- With floating remote indication contact
- Plugs can be tested with CHECKMASTER 2



For 48 V DC power supplies



For 230 V AC power supplies,
3-conductor system, L1, L2, PE (IT systems)

Notes:
If only one value is specified under mode of protection in the technical data, this value is valid for all modes of protection specified.

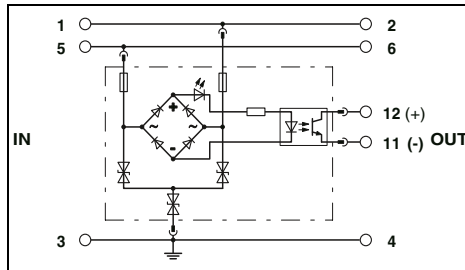

Technical data

Electrical data	
IEC test classification	III, T3
Nominal voltage U_N	- / 48 V DC
Mode of protection	L-N / L-PE / N-PE / (L+) - (L-) / (L+/L-) - PE
Maximum continuous operating voltage U_C	60 V DC
Maximum continuous operating voltage U_C	L-N / L-PE
Rated load current I_L	26 A (30°C)
Nominal discharge current I_n (8/20) μ s	500 A
Combined surge U_{OC}	1 kV (2 Ω) / 6 kV (12 Ω)
Protection level U_p	≤ 120 V
Protection level U_p	L-N / L(N)-PE
Response time t_A	≤ 1 ns / ≤ 1 ns
Maximum backup fuse in acc. with IEC	-
Maximum backup fuse for branch wiring	50 A (gG)
Maximum backup fuse for through wiring	25 A (gG)

General data	
Dimensions W/H/D	17.7 mm / 90 mm / 65.5 mm
IEC connection data	Rigid / flexible / AWG
Temperature range	-40°C ... 80°C
Test standards	EN 61643-11 / IEC 61643-11

Ordering data

Description	Type	Order No.	Pcs./Pkt.
MAINS-PLUGTRAB, consisting of a plug and base element	PT 2+1-S-48DC/FM	2817958	10

Accessories

Replacement plug	Type	Order No.	Pcs./Pkt.
PLUGTRAB base element, for mounting on NS 35	PT 2+1-S-48DC-ST	2839648	10
	PT-BE/FM	2839282	10

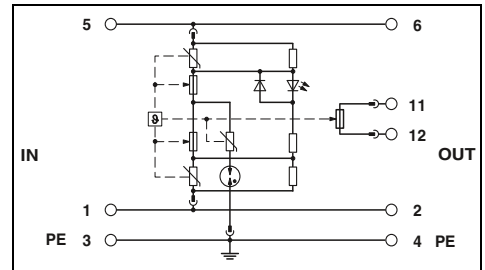

Technical data

Electrical data	
IEC test classification	III, T3
Nominal voltage U_N	230 V AC
Mode of protection	L-L / L-PE
Maximum continuous operating voltage U_C	275 V AC / 440 V AC
Maximum continuous operating voltage U_C	L-L / L-PE
Rated load current I_L	16 A (60°C)
Nominal discharge current I_n (8/20) μ s	3 kA
Combined surge U_{OC}	6 kV
Protection level U_p	-
Protection level U_p	≤ 1.2 kV / ≤ 1.5 kV
Response time t_A	≤ 25 ns / ≤ 100 ns
Maximum backup fuse in acc. with IEC	16 A (MCB B)
Maximum backup fuse for branch wiring	16 A (MCB B)
Maximum backup fuse for through wiring	16 A (MCB B)

General data	
Dimensions W/H/D	17.7 mm / 90 mm / 65.5 mm
IEC connection data	Rigid / flexible / AWG
Temperature range	-40°C ... 70°C
Test standards	IEC 61643-11 / EN 61643-11

Ordering data

Description	Type	Order No.	Pcs./Pkt.
MAINS-PLUGTRAB, consisting of a plug and base element	PLT-T3-IT-230-FM	2906450	1

Accessories

Replacement plug	Type	Order No.	Pcs./Pkt.
PLUGTRAB base element, for mounting on NS 35	PLT-T3-IT-230-P	2906451	1
	PT-BE/FM	2839282	10

Type 3 device protection TERMITRAB complete

- Diode-based type 3 surge protection
- Overall width of just 6.2 mm
- Same shape as PTCB electrical device circuit breakers
- With Push-in or screw connection technology
- Pluggable
- Integrated mechanical status indicator
- Plugs can be tested with CHECKMASTER 2



new



For 24 V DC power supplies

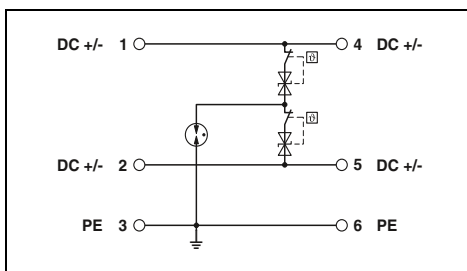

Technical data

Electrical data	
IEC test classification	III, T3
Nominal voltage U_N	- / 24 V DC
Mode of protection	(DC+) - (DC-) / (DC+/DC-) - PE
Maximum continuous operating voltage U_C	30 V DC
Rated load current I_L	6 A (30°C)
Nominal discharge current I_n (8/20) μ s	1 kA
Combined surge U_{oc}	2 kV (2 Ω) / 6 kV (12 Ω)
Protection level U_p	-
	(DC+) - (DC-) ≤ 0.09 kV ($U_{oc}=2$ kV) / ≤ 0.2 kV ($U_{oc}=6$ kV)
	(DC+/DC-) - PE ≤ 0.7 kV
Response time t_A	(DC+) - (DC-) ≤ 1 ns
	(DC+/DC-) - PE ≤ 100 ns
Maximum backup fuse for branch wiring	6 A (gG)
General data	
Dimensions W/H/D	6.2 mm / 105.8 mm / 100 mm
IEC connection data	Rigid / flexible / AWG 0.2 ... 4 mm ² / 0.2 ... 2.5 mm ² / 24 ... 12
Temperature range	-40°C ... 80°C
Test standards	IEC 61643-11 / EN 61643-11

Ordering data

Description	Type	Order No.	Pcs./Pkt.
TERMITRAB complete			
Push-in connection technology	TTC-6P-T3-24DC-PT-I	1027586	1
Screw connection technology	TTC-6P-T3-24DC-UT-I	1027584	1

Accessories

Replacement plug	1L-N & N-PE	TTC-6P-T3-24DC-I-P	1027591	1
------------------	-------------	--------------------	---------	---

Surge protection and interference suppression filters

Surge protection for the power supply

Type 3 device protection BLOCKTRAB

- Type 3 varistor-based surge protective device
- For mounting in a fixed installation
- Audible fault indication
- Thermal disconnect device



new



For mounting in junction boxes, cable ducts, and underfloor systems



new



For mounting on standard ground contact sockets

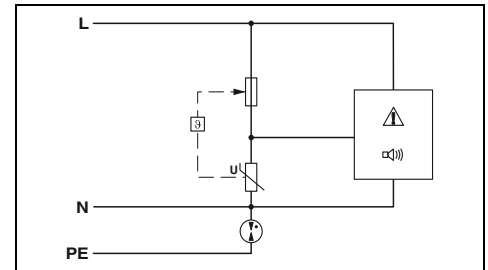
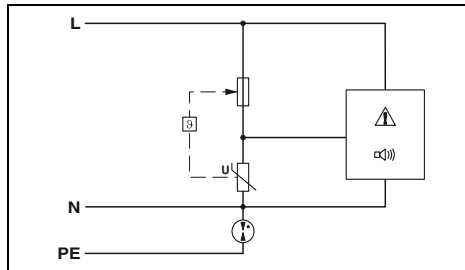

Technical data

Electrical data	
IEC test classification	III, T3
Nominal voltage U_N	230 V AC
Mode of protection	L-N / L-PE / N-PE
Maximum continuous operating voltage U_C	L-N / L-PE - / -
Rated load current I_L	-
Nominal discharge current I_n (8/20) μ s	-
Combined surge U_{OC}	6 kV
Protection level U_p	≤ 1.5 kV
Response time t_A	L-N / L(N)-PE ≤ 25 ns / ≤ 100 ns
Maximum backup fuse in acc. with IEC	16 A (MCB B)
General data	
Dimensions W/H/D	12,5 mm / 31 mm / 36 mm
IEC connection data	Rigid / flexible / AWG mm^2 / mm^2 / -
Temperature range	-20°C ... 70°C
Test standards	IEC 61643-11 / EN 61643-11

Technical data	
III, T3	
230 V AC	
L-N / L-PE / N-PE	
- / -	
-	
-	
6 kV	
≤ 1.5 kV	
L-N / L(N)-PE ≤ 25 ns / ≤ 100 ns	
16 A (MCB B)	
General data	
53 mm / 53 mm / 32 mm	
mm^2 / mm^2 / -	
-20°C ... 70°C	
IEC 61643-11 / EN 61643-11	

Ordering data

Description	Type	Order No.	Pcs./Pkt.
BLOCKTRAB, for universal mounting	BLT3-230-A	1038841	10

Ordering data		
Type	Order No.	Pcs./Pkt.
BLT-SKT-230-A	1038842	1

Type 3 device protection BLOCKTRAB

- BT-1S-230AC/...** serves as device protection in deep installation boxes (in acc. with DIN 49073), cable ducts, underfloor systems, and end devices.
- With double spring-cage terminal blocks for tool-free conductor connection
 - Side latches for easy fixing
 - Optical or acoustic signaling of disconnection



For universal mounting,
optical signaling



For universal mounting,
acoustic signaling

Notes:

If only one value is specified under mode of protection in the technical data, this value is valid for all modes of protection specified.

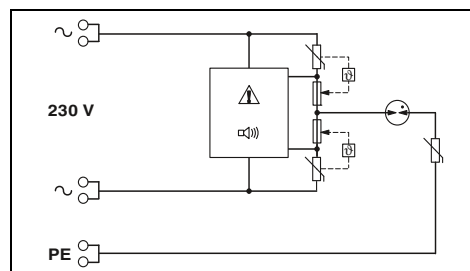
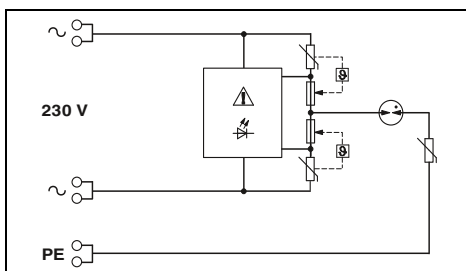

Technical data

Technical data

Electrical data	
IEC test classification	III, T3
Nominal voltage U_N	230 V AC
Mode of protection	L-N / L-PE / N-PE
Maximum continuous operating voltage U_C	L-N / L-PE 275 V AC / 440 V AC
Rated load current I_L	16 A (30°C)
Nominal discharge current I_n (8/20) μ s	3 kA
Combined surge U_{oc}	6 kV
Protection level U_p	L-N / L(N)-PE ≤ 1.3 kV / ≤ 1.5 kV
Response time t_A	L-N / L(N)-PE ≤ 25 ns / ≤ 100 ns
Maximum backup fuse in acc. with IEC	16 A (MCB B)
General data	
Dimensions W/H/D	22.5 mm / 43 mm / 27.4 mm
IEC connection data	Rigid / flexible / AWG 0.2 ... 2.5 mm ² / 0.2 ... 2.5 mm ² / 24 ... 14
Temperature range	-30°C ... 75°C
Test standards	IEC 61643-11 / EN 61643-11

Technical data	
IEC test classification	III, T3
Nominal voltage U_N	230 V AC
Mode of protection	L-N / L-PE / N-PE
Maximum continuous operating voltage U_C	L-N / L-PE 275 V AC / 440 V AC
Rated load current I_L	16 A (30°C)
Nominal discharge current I_n (8/20) μ s	3 kA
Combined surge U_{oc}	6 kV
Protection level U_p	L-N / L(N)-PE ≤ 1.3 kV / ≤ 1.5 kV
Response time t_A	L-N / L(N)-PE ≤ 25 ns / ≤ 100 ns
Maximum backup fuse in acc. with IEC	16 A (MCB B)
General data	
Dimensions W/H/D	22.5 mm / 43 mm / 26.2 mm
IEC connection data	Rigid / flexible / AWG 0.2 ... 2.5 mm ² / 0.2 ... 2.5 mm ² / 24 ... 14
Temperature range	-30°C ... 75°C
Test standards	IEC 61643-11 / EN 61643-11

Ordering data

Ordering data

Description	Voltage U_N
BLOCKTRAB , for universal mounting	230 V AC

Type	Order No.	Pcs./Pkt.
BT-1S-230AC/O	2800625	1

Type	Order No.	Pcs./Pkt.
BT-1S-230AC/A	2803409	10

Surge protection and interference suppression filters

Surge protection for the power supply

Type 3 device protection MAINTRAB

- Attachment plug in black or white
- For individual end devices
- With increased touch-proof protection
- Optical signaling of the surge voltage function via LED
- For protecting the power supply and signal lines
- Including required accessories
- Country-specific versions available



Attachment plug



For telecommunications systems with TAE connection

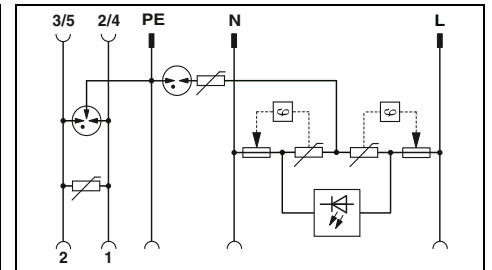
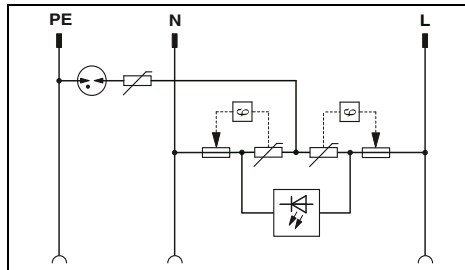

Technical data

Electrical data	
IEC test classification/EN type	- / T3
Nominal voltage U_N	230 V AC
Maximum continuous operating voltage U_C	L-N / L-PE without reference direction 275 V AC / 360 V AC
Combined surge U_{OC}	4 kV
Nominal load current I_L	16 A (30°C)
Rated current	-
Nominal discharge current I_n (8/20) μ s	without reference direction 3 kA (> 5x)
Protection level U_p	Core-Core / Core-Ground / Core-Shield L-N / N-PE / L-PE ≤ 1.2 kV / ≤ 1.5 kV / ≤ 1.5 kV Core-Core / Core-Ground / Core-Shield - / - / -
Response time t_d	L-N / L-PE ≤ 25 ns / ≤ 100 ns Core-Ground / Core-Shield / Shield-Ground - / - / -
Cut-off frequency f_g (3 dB)	In a 100 Ω system Core-Core - In a 75 Ω system Core-Shield -
General data	
Dimensions W/H/D	56 mm / 76 mm / 78 mm
Temperature range	-25°C ... 75°C
Test standards	IEC 61643-11 / EN 61643-11

Technical data

Mains protection	Data protection
/ T3	C1
230 V AC	
275 V AC / 360 V AC	200 V DC
4 kV	-
16 A (30°C)	150 mA (25°C)
-	1 kA / 2.5 kA / -
3 kA (> 5x)	-
-	≤ 460 V (C2 - 1 kA) / ≤ 900 V (C2 - 2 kA) / -
≤ 1.2 kV / ≤ 1.5 kV / ≤ 1.5 kV	-
-	-
≤ 25 ns / ≤ 100 ns	-
-	-
-	typ. 4 MHz
-	-
IEC 61643-11 / EN 61643-11 / EN 61643-21 /	

Ordering data

Description	can be used in the following:
MAINTRAB , attachment plug with signal lamp for plugging into a socket, for device protection	
black	D, A, NL, E, S, FIN, TR
white	D, A, NL, E, S, FIN, TR
black	D
white	D
black	NL, E, I, S, FIN, TR
black	B, F, CZ, SVK, PL
black	CH

Type	Order No.	Pcs./Pkt.
MNT-1 D	2882200	1
MNT-1 D/WH	2882213	1
MNT-NET B/F	2882226	1
MNT-1 CH II	2882255	1

Ordering data

Type	Order No.	Pcs./Pkt.
MNT-TAE D	2882381	1
MNT-TAE D/WH	2882394	1



For telecommunications systems with RJ12 connection



For network and TV antennas/cables and SAT systems, with F connector and IEC adapter

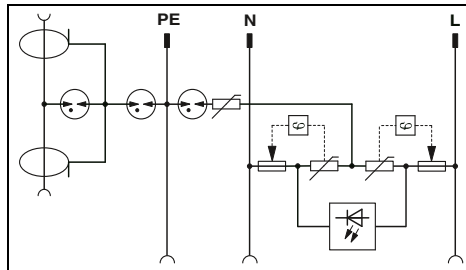
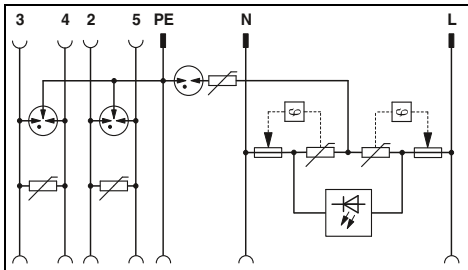

Technical data	
Mains protection / T3	Data protection C1
230 V AC	
275 V AC / 360 V AC	200 V DC
-	-
4 kV	-
16 A (30°C)	150 mA (25°C)
-	1 kA / 2.5 kA / -
3 kA (> 5x)	-
-	1 kA / 2.5 kA / -
≤ 1.2 kV / ≤ 1.5 kV / ≤ 1.5 kV	-
-	≤ 460 V (C2 - 1 kA) / ≤ 900 V (C2 - 2 kA) / -
≤ 25 ns / ≤ 100 ns	-
-	≤ 25 ns / ≤ 100 ns / -
-	typ. 4 MHz
-	-
63 mm / 103 mm / 78 mm -25°C ... 75°C IEC 61643-11 / EN 61643-11 / EN 61643-21 /	

Technical data	
Mains protection / T3	Data protection C2
230 V AC	
275 V AC / 360 V AC	24 V DC
-	-
4 kV	-
16 A (30°C)	1.5 A (25°C)
-	1.5 A (25°C)
3 kA (> 5x)	-
-	- / 2.5 kA / 2.5 kA
≤ 1.2 kV / ≤ 1.5 kV / ≤ 1.5 kV	-
-	- / - / ≤ 700 V (C2 - 2 kA)
≤ 25 ns / ≤ 100 ns	-
-	- / - / ≤ 100 ns
-	-
-	typ. 2.5 GHz
63 mm / 107 mm / 78 mm -25°C ... 75°C IEC 61643-11 / EN 61643-11 / EN 61643-21 /	

Ordering data		
Type	Order No.	Pcs./Pkt.
MNT-TELE E	2882417	1
MNT-TEL B/F	2882404	1

Ordering data		
Type	Order No.	Pcs./Pkt.
MNT-TV-SAT D	2882284	1
MNT-TV-SAT D/WH	2882297	1
MNT-TV-SAT B/F	2882307	1

Surge protection and interference suppression filters

Surge protection for the power supply

Surge protection for NEMA systems

- VALVETRAB US – Single-phase**
- Surge protection in accordance with UL Listed type 1
 - Just one connection terminal block for GND
 - Consistent pluggable design
 - Disconnect device on each individual plug
 - Optical, mechanical status indication for the individual arresters
 - With floating remote indication contact
 - Mechanical coding of all slots
 - Plugs can be tested with CHECKMASTER 2



2-conductor system, DC+, DC-, for (-) 48 V DC



3-conductor system, DC+, DC-, G, for (-) 48 V DC

UL US
Total width 17.8 mm

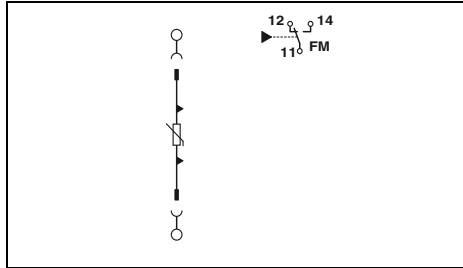

Technical data

	...48/40...	...48/65...
Electrical data		
UL type	type 4	type 1
Nominal voltage U_N	60 V DC	48 V DC
Mode of protection	(DC+) - (DC-)	(DC+) - (DC-)
Maximum continuous operating voltage (MCOV)	100 V DC	100 V DC
Nominal discharge current I_n	20 kA	20 kA
Total discharge current I_{total} (8/20) μ s	40 kA	65 kA
Maximum surge current per phase	40 kA	65 kA
Voltage protection rating (VPR)		400 V
Short-circuit current rating (SCCR)	-	5 kA
General data		
Dimensions W/H/D	17.8 mm / 96.8 mm / 65.5 mm	
UL connection data	AWG	10 ... 2
Standards/specifications	UL 1449 Edition 4	
Remote indication contact	PDT contact	
UL connection data	AWG	30 ... 14
Max. operating voltage	125 V AC	
Max. operating current	1 A AC	

UL US
Total width 35.6 mm

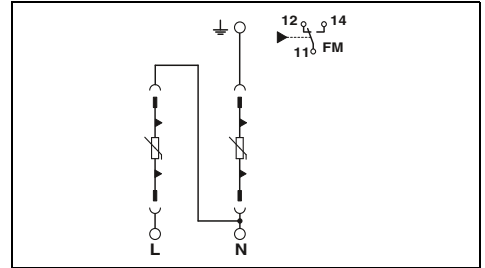

Technical data

	...48/40...	...48/65...
Electrical data		
UL type	type 4	type 1
Nominal voltage U_N	60 V DC	48 V DC
Mode of protection	(DC+) - (DC-) / (DC+) - G	(DC+) - (DC-) / (DC+) - G
Maximum continuous operating voltage (MCOV)	(DC+)-(DC-): 100 V DC (DC+)-G: 100 V DC (DC-)-G: 200 V DC	(DC+)-(DC-): 100 V DC (DC+)-G: 100 V DC (DC-)-G: 100 V DC
Nominal discharge current I_n	20 kA	20 kA
Total discharge current I_{total} (8/20) μ s	40 kA	130 kA
Maximum surge current per phase	40 kA	65 kA
Voltage protection rating (VPR)		(DC+)-(DC-): 400 V (DC+)-G: 400 V (DC-)-G: 600 V
Short-circuit current rating (SCCR)	-	5 kA
General data		
Dimensions W/H/D	35.6 mm / 96.8 mm / 65.5 mm	
UL connection data	AWG	10 ... 2
Standards/specifications	UL 1449 Edition 4	
Remote indication contact	PDT contact	
UL connection data	AWG	30 ... 14
Max. operating voltage	125 V AC	
Max. operating current	1 A AC	

Ordering data

Description	Type	Order No.	Pcs./Pkt.
VALVETRAB US	VAL-US-48/40/1+0-FM	2910343	1
	VAL-US-48/65/1+0-FM	2910345	1

Ordering data

Description	Type	Order No.	Pcs./Pkt.
VALVETRAB US	VAL-US-48/40/1+1V-FM	2910344	1
	VAL-US-48/65/1+1V-FM	2910346	1

Accessories

Replacement plug	Type	Order No.	Pcs./Pkt.
L-N/L-G/N-G	VAL-US-48/40-P	2910333	1
L-N/L-G/N-G	VAL-US-48/65-P	2910328	1

Accessories

Replacement plug	Type	Order No.	Pcs./Pkt.
L-N/L-G/N-G	VAL-US-48/40-P	2910333	1
L-N/L-G/N-G	VAL-US-48/65-P	2910328	1

Surge protection and interference suppression filters

Surge protection for the power supply

Surge protection for NEMA systems

VALVETRAB US – Single-phase

- Surge protection in accordance with UL Listed type 1
- Just one connection terminal block for GND
- Consistent pluggable design
- Disconnect device on each individual plug
- Optical, mechanical status indication for the individual arresters
- With floating remote indication contact
- Mechanical coding of all slots
- Plugs can be tested with CHECKMASTER 2



2-conductor system, L, N/G, single-phase



2-conductor system, L, N/G, single-phase



Total width 17.8 mm

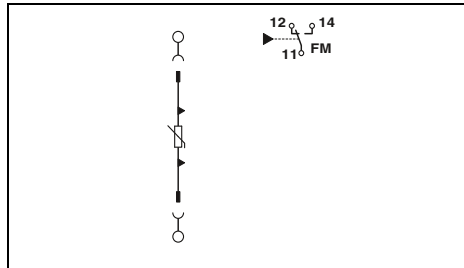

Technical data

Electrical data	...120/40...	...120/65...	...240/40...
	UL type	type 1	type 1
Nominal voltage U_N	120 V AC	120 V AC	240 V AC
Mode of protection	L-N	L-N / L-G	L-N / L-G
Maximum continuous operating voltage (MCOV)	175 V AC	175 V AC	385 V AC
Nominal discharge current I_n	20 kA	20 kA	20 kA
Total discharge current I_{total} (8/20) μ s	40 kA	65 kA	40 kA
Maximum surge current per phase	40 kA	65 kA	40 kA
Voltage protection rating (VPR)	700 V	700 V	1500 V
Short-circuit current rating (SCCR)	200 kA	200 kA	200 kA
General data			
Dimensions W/H/D	17.8 mm / 96.8 mm / 65.5 mm		
UL connection data	AWG 10 ... 2		
Standards/specifications	UL 1449 Edition 4		
Remote indication contact	PDT contact		
UL connection data	AWG 30 ... 14		
Max. operating voltage	125 V AC		
Max. operating current	1 A AC		



Total width 17.8 mm

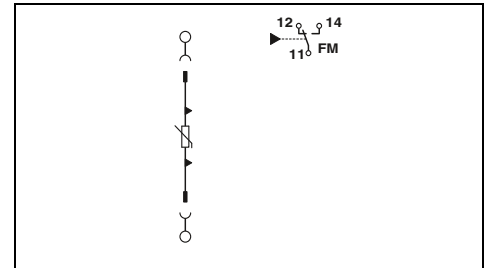

Technical data

Electrical data	...277/40...	...277/80...	...347/30...
	UL type	type 1	type 1
Nominal voltage U_N	277 V AC	277/480 V AC	347 V AC
Mode of protection	L-N / L-G	L-N / L-G	L-N / L-G
Maximum continuous operating voltage (MCOV)	385 V AC	385 V AC	580 V AC
Nominal discharge current I_n	20 kA	20 kA	20 kA
Total discharge current I_{total} (8/20) μ s	40 kA	80 kA	30 kA
Maximum surge current per phase	40 kA	80 kA	30 kA
Voltage protection rating (VPR)	1500 V	1500 V	2000 V
Short-circuit current rating (SCCR)	200 kA	200 kA	200 kA
General data			
Dimensions W/H/D	17.8 mm / 96.8 mm / 65.5 mm		
UL connection data	AWG 10 ... 2		
Standards/specifications	UL 1449 Edition 4		
Remote indication contact	PDT contact		
UL connection data	AWG 30 ... 14		
Max. operating voltage	125 V AC		
Max. operating current	1 A AC		

Ordering data

Description	Type	Order No.	Pcs./Pkt.
	VALVETRAB US		
	VAL-US-120/40/1+0-FM	2910348	1
	VAL-US-120/65/1+0-FM	2910355	1
	VAL-US-240/40/1+0-FM	2910361	1

Ordering data

Description	Type	Order No.	Pcs./Pkt.
	VALVETRAB US		
	VAL-US-277/40/1+0-FM	2910372	1
	VAL-US-277/80/1+0-FM	2910377	1
	VAL-US-347/30/1+0-FM	2910381	1

Accessories

Replacement plug		Type	Order No.	Pcs./Pkt.
	L-N/L-G/N-G	VAL-US-120/40-P	2910335	1
	L-N/L-G/N-G	VAL-US-120/65-P	2910330	1
	L-N/L-G/N-G	VAL-US-240/40-P	2910336	1
	N-G			
	N-G			

Accessories

Replacement plug		Type	Order No.	Pcs./Pkt.
	L-N/L-G/N-G	VAL-US-277/40-P	2910338	1
	L-N/L-G/N-G	VAL-US-277/80-P	2910331	1
	L-N/L-G/N-G	VAL-US-347/30-P	2910339	1
	N-G			
	N-G			



new



3-conductor system, L, N, G, single-phase



new



3-conductor system, L, N, G, single-phase, gas-filled surge arrester between N-G



new



3-conductor system, L, N, G, single-phase, varistor between N-G



Total width 35.6 mm

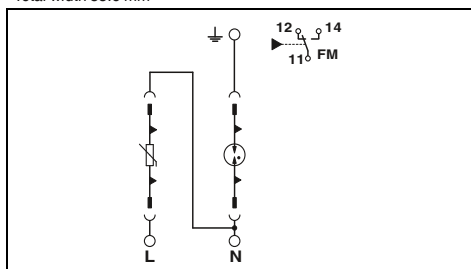

Total width 35.6 mm

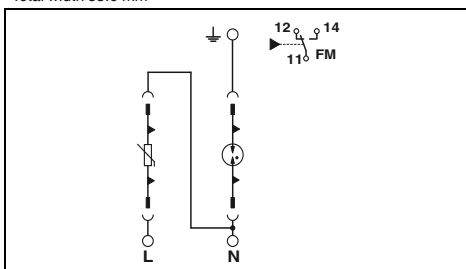

Total width 35.6 mm

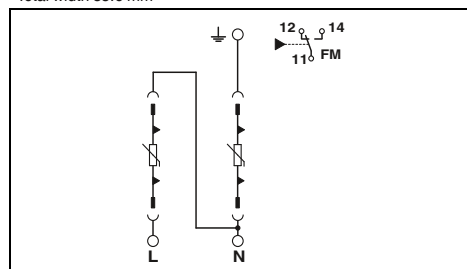

Technical data

...120/40...	...120/65...
type 1	type 1
120 V AC	120 V AC
L-N / L-G / N-G	L-N / L-G / N-G
L-N: 175 V AC	L-N: 175 V AC
L-G: 175 V AC	L-G: 175 V AC
N-G: 305 V AC	N-G: 264 V AC
20 kA	20 kA
80 kA	130 kA
40 kA	65 kA
L-N: 700 V	L-N: 700 V
L-G: 1800 V	L-G: 1500 V
N-G: 1200 V	N-G: 1200 V
200 kA	200 kA

35.6 mm / 96.8 mm / 65.5 mm

10 ... 2

UL 1449 Edition 4

PDT contact

30 ... 14

125 V AC

1 A AC

Technical data

...240/40...	...277/40...
type 1	type 1
240 V AC	277 V AC
L-N / L-G / N-G	L-N / L-G / N-G
L-N: 385 V AC	L-N: 385 V AC
L-G: 385 V AC	L-G: 385 V AC
N-G: 305 V AC	N-G: 305 V AC
20 kA	20 kA
80 kA	80 kA
40 kA	40 kA
L-N: 1500 V	L-N: 1500 V
L-G: 2000 V	L-G: 2000 V
N-G: 1200 V	N-G: 1200 V
200 kA	200 kA

35.6 mm / 96.8 mm / 65.5 mm

10 ... 2

UL 1449 Edition 4

PDT contact

30 ... 14

125 V AC

1 A AC

Technical data

...277/80...	...347/30...
type 1	type 1
277 V AC	347 V AC
L-N / L-G / N-G	L-N / L-G / N-G
L-N: 385 V AC	L-N: 580 V AC
L-G: 750 V AC	L-G: 750 V AC
N-G: 385 V AC	N-G: 580 V AC
20 kA	20 kA
160 kA	60 kA
80 kA	30 kA
L-N: 1500 V	L-N: 2000 V
L-G: 2500 V	L-G: 4000 V
N-G: 1200 V	N-G: 2000 V
200 kA	200 kA

35.6 mm / 96.8 mm / 65.5 mm

10 ... 2

UL 1449 Edition 4

PDT contact

30 ... 14

125 V AC

1 A AC

Ordering data

Type	Order No.	Pcs./Pkt.
VAL-US-120/40/1+1-FM	2910349	1
VAL-US-120/65/1+1-FM	2910356	1

Ordering data

Type	Order No.	Pcs./Pkt.
VAL-US-240/40/1+1-FM	2910362	1
VAL-US-277/40/1+1-FM	2910373	1

Ordering data

Type	Order No.	Pcs./Pkt.
VAL-US-277/80/1+1V-FM	2910378	1
VAL-US-347/30/1+1V-FM	2910382	1

Accessories

Type	Order No.	Pcs./Pkt.
VAL-US-120/40-P	2910335	1
VAL-US-120/65-P	2910330	1
GDT-US-NG/40-P	2910342	1
GDT-US-NG/80-P	2910332	1

Accessories

Type	Order No.	Pcs./Pkt.
VAL-US-240/40-P	2910336	1
VAL-US-277/40-P	2910338	1
GDT-US-NG/40-P	2910342	1

Accessories

Type	Order No.	Pcs./Pkt.
VAL-US-277/80-P	2910331	1
VAL-US-347/30-P	2910339	1

Surge protection and interference suppression filters

Surge protection for the power supply

Surge protection for NEMA systems

VALVETRAB US – Split-phase

- Surge protection in accordance with UL Listed type 1
- Just one connection terminal block for GND
- Consistent pluggable design
- Disconnect device on each individual plug
- Optical, mechanical status indication for the individual arresters
- With floating remote indication contact
- Mechanical coding of all slots
- Plugs can be tested with CHECKMASTER 2



3-conductor system, L1, L2, G, split-phase



4-conductor system, L1, L2, N, G, split-phase



Total width 35.6 mm

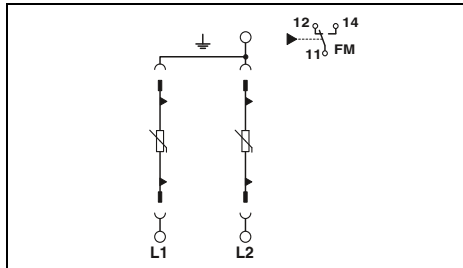

Total width 53.4 mm

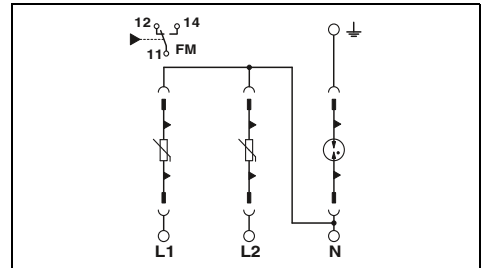

Technical data

Electrical data	...120/40...	...120/65...	...240/40...
	UL type	type 1	type 1
Nominal voltage U_N	120/240 V AC (Split-phase)	120/240 V AC (Split-phase)	240 V AC
Mode of protection	L-L / L-G	L-L / L-G	L-L / L-G
Maximum continuous operating voltage (MCOV)	L-L: 350 V AC L-G: 175 V AC	L-L: 350 V AC L-G: 175 V AC	L-L: 750 V AC L-G: 385 V AC
Nominal discharge current I_n	20 kA	20 kA	20 kA
Total discharge current I_{total} (8/20) μ s	80 kA	130 kA	80 kA
Maximum surge current per phase	40 kA	65 kA	40 kA
Voltage protection rating (VPR)	L-L: 1200 V L-G: 700 V	L-L: 1200 V L-G: 700 V	L-L: 2500 V L-G: 1500 V
Short-circuit current rating (SCCR)	200 kA	200 kA	200 kA
General data			
Dimensions W/H/D	35.6 mm / 96.8 mm / 65.5 mm		
UL connection data	AWG 10 ... 2		
Standards/specifications	UL 1449 Edition 4		
Remote indication contact	PDT contact		
UL connection data	AWG 30 ... 14		
Max. operating voltage	125 V AC		
Max. operating current	1 A AC		

Technical data

Electrical data	...120/40...	...120/65...	...240/40...
	UL type	type 1	type 1
Nominal voltage U_N	120/240 V AC (Split-phase)	120/240 V AC (Split-phase)	240 V AC
Mode of protection	L-L / L-N / L-G / N-G	L-L / L-N / L-G / N-G	L-L / L-N / L-G / N-G
Maximum continuous operating voltage (MCOV)	L-L: 350 V AC L-N: 175 V AC L-G: 175 V AC N-G: 305 V AC	L-L: 350 V AC L-N: 175 V AC L-G: 175 V AC N-G: 264 V AC	L-L: 750 V AC L-N: 385 V AC L-G: 385 V AC N-G: 305 V AC
Nominal discharge current I_n	20 kA	20 kA	20 kA
Total discharge current I_{total} (8/20) μ s	120 kA	195 kA	120 kA
Maximum surge current per phase	40 kA	65 kA	40 kA
Voltage protection rating (VPR)	L-L: 1200 V L-N: 700 V L-G: 1800 V N-G: 1200 V	L-L: 1200 V L-N: 700 V L-G: 1500 V N-G: 1200 V	L-L: 2500 V L-N: 1500 V L-G: 2000 V N-G: 1200 V
Short-circuit current rating (SCCR)	200 kA	200 kA	200 kA
General data			
Dimensions W/H/D	53.4 mm / 98.7 mm / 65.5 mm		
UL connection data	AWG 10 ... 2		
Standards/specifications	UL 1449 Edition 4		
Remote indication contact	PDT contact		
UL connection data	AWG 30 ... 14		
Max. operating voltage	125 V AC		
Max. operating current	1 A AC		

Ordering data

Description	Type	Order No.	Pcs./Pkt.
	VALVETRAB US	VAL-US-120/40/2+0-FM	2910351
	VAL-US-120/65/2+0-FM	2910357	1
	VAL-US-240/40/2+0-FM	2910364	1

Ordering data

Description	Type	Order No.	Pcs./Pkt.
	VALVETRAB US	VAL-US-120/40/2+1-FM	2910352
	VAL-US-120/65/2+1-FM	2910358	1
	VAL-US-240/40/2+1-FM	2910365	1

Accessories

Replacement plug	Type	Order No.	Pcs./Pkt.
	L-N/L-G/N-G	VAL-US-120/40-P	2910335
L-N/L-G/N-G	VAL-US-120/65-P	2910330	1
L-N/L-G/N-G	VAL-US-240/40-P	2910336	1
N-G			
N-G			

Accessories

Replacement plug	Type	Order No.	Pcs./Pkt.
	L-N/L-G/N-G	VAL-US-120/40-P	2910335
L-N/L-G/N-G	VAL-US-120/65-P	2910330	1
L-N/L-G/N-G	VAL-US-240/40-P	2910336	1
N-G	GDT-US-NG/40-P	2910342	1
N-G	GDT-US-NG/80-P	2910332	1

Surge protection for NEMA systems

VALVETRAB US – 3-phase wye

- Surge protection in accordance with UL Listed type 1
- Just one connection terminal block for GND
- Consistent pluggable design
- Disconnect device on each individual plug
- Optical, mechanical status indication for the individual arresters
- With floating remote indication contact
- Mechanical coding of all slots
- Plugs can be tested with CHECKMASTER 2



4-conductor system, L1, L2, L3, G, split-phase



4-conductor system, L1, L2, L3, G, 3-phase wye



Total width 53.4 mm

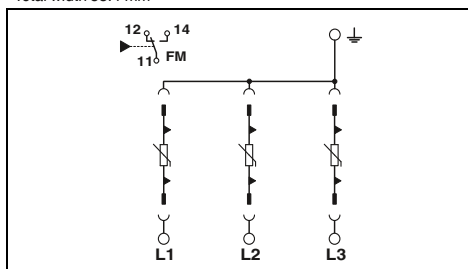

Total width 53.4 mm

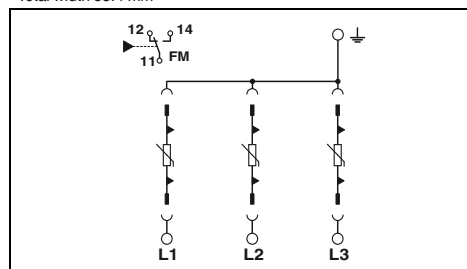

Technical data

Electrical data	...120/40...	...120/65...	...240/40...
UL type	type 1	type 1	type 1
Nominal voltage U_N	120/208 V AC (Wye)	120/208 V AC (Wye)	240 V AC
Mode of protection	120/240 V AC (Split-phase)	120/240 V AC (Split-phase)	L-L / L-G
Maximum continuous operating voltage (MCOV)	L-L: 350 V AC L-N: 350 V L-G: 175 V AC N-G: 175 V	L-L: 350 V AC L-N: 350 V L-G: 175 V AC N-G: 175 V	L-L: 750 V AC L-N: 750 V L-G: 385 V AC N-G: 385 V
Nominal discharge current I_n	20 kA	20 kA	20 kA
Total discharge current I_{total} (8/20) μ s	120 kA	195 kA	120 kA
Maximum surge current per phase	40 kA	65 kA	40 kA
Voltage protection rating (VPR)	L-L: 1200 V L-N: 1200 V L-G: 700 V N-G: 700 V	L-L: 1200 V L-N: 1200 V L-G: 700 V N-G: 700 V	L-L: 2500 V L-N: 3000 V L-G: 1500 V N-G: 1500 V
Short-circuit current rating (SCCR)	200 kA	200 kA	200 kA
General data	53.4 mm / 98.7 mm / 65.5 mm		
Dimensions W/H/D	10 ... 2		
UL connection data	AWG	UL 1449 Edition 4	
Standards/specifications	PDT contact		
Remote indication contact	30 ... 14		
UL connection data	AWG	125 V AC	
Max. operating voltage	1 A AC		
Max. operating current			

Technical data

Electrical data	...277/80...	...347/30...
UL type	type 1	type 1
Nominal voltage U_N	277/480 V AC (3-phase Wye)	347/600 V AC (3-phase Wye)
Mode of protection	L-L / L-G	L-L / L-G
Maximum continuous operating voltage (MCOV)	L-L: 750 V AC L-G: 385 V AC	L-L: 750 V AC L-G: 580 V AC
Nominal discharge current I_n	20 kA	20 kA
Total discharge current I_{total} (8/20) μ s	240 kA	90 kA
Maximum surge current per phase	80 kA	30 kA
Voltage protection rating (VPR)	L-L: 2500 V L-G: 1500 V	L-L: 4000 V L-G: 2000 V
Short-circuit current rating (SCCR)	200 kA	200 kA
General data	53.4 mm / 98.7 mm / 77.5 mm	
Dimensions W/H/D	10 ... 2	
UL connection data	UL 1449 Edition 4	
Standards/specifications	PDT contact	
Remote indication contact	30 ... 14	
UL connection data	125 V AC	
Max. operating voltage	1 A AC	
Max. operating current		

Ordering data

Description	Type	Order No.	Pcs./Pkt.
VALVETRAB US	VAL-US-120/40/3+0-FM	2910353	1
	VAL-US-120/65/3+0-FM	2910359	1
	VAL-US-240/40/3+0-FM	2910366	1

Ordering data

Description	Type	Order No.	Pcs./Pkt.
VALVETRAB US	VAL-US-277/80/3+0-FM	1075896	1
	VAL-US-347/30/3+0-FM	2910383	1

Accessories

Replacement plug	Type	Order No.	Pcs./Pkt.
L-N/L-G/N-G	VAL-US-120/40-P	2910335	1
L-N/L-G/N-G	VAL-US-120/65-P	2910330	1
L-N/L-G/N-G	VAL-US-240/40-P	2910336	1

Accessories

Replacement plug	Type	Order No.	Pcs./Pkt.
L-N/L-G/N-G	VAL-US-277/80-P	2910331	1
L-N/L-G/N-G	VAL-US-347/30-P	2910339	1

Surge protection and interference suppression filters

Surge protection for the power supply

Surge protection for NEMA systems

VALVETRAB US – 3-phase wye

- Surge protection in accordance with UL Listed type 1
- Just one connection terminal block for GND
- Consistent pluggable design
- Disconnect device on each individual plug
- Optical, mechanical status indication for the individual arresters
- With floating remote indication contact
- Mechanical coding of all slots
- Plugs can be tested with CHECKMASTER 2



5-conductor system, L1, L2, L3, N, G,
3-phase wye



5-conductor system, L1, L2, L3, N, G,
3-phase wye



Total width 71.2 mm

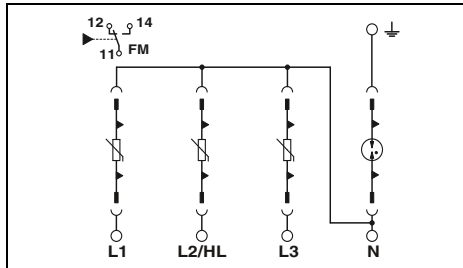

Technical data

	...120/40...	...120/65...
	UL type	type 1
Nominal voltage U_N	120/208 V AC (Wye)	120/208 V AC (Wye)
Mode of protection	L-N / N-G / L-G	L-N / N-G / L-G
Maximum continuous operating voltage (MCOV)	L-L: 350 V AC L-N: 175 V AC L-G: 175 V AC N-G: 305 V AC	L-L: 350 V AC L-N: 175 V AC L-G: 175 V AC N-G: 264 V AC
Nominal discharge current I_n	20 kA	20 kA
Total discharge current I_{total} (8/20) μ s	160 kA	260 kA
Maximum surge current per phase	40 kA	65 kA
Voltage protection rating (VPR)	L-L: 1200 V L-N: 700 V L-G: 1800 V N-G: 1200 V	L-L: 1200 V L-N: 700 V L-G: 1500 V N-G: 1200 V
Short-circuit current rating (SCCR)	200 kA	200 kA
General data	71.2 mm / 98.7 mm / 65.5 mm	
Dimensions W/H/D	10 ... 2	
UL connection data	AWG	
Standards/specifications	UL 1449 Edition 4	
Remote indication contact	PDT contact	
UL connection data	30 ... 14	
Max. operating voltage	125 V AC	
Max. operating current	1 A AC	



Total width 71.2 mm

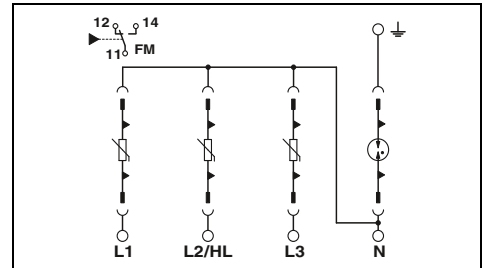

Technical data

	...240/40...	...277/40...
	UL type	type 1
Nominal voltage U_N	240/415 V AC (Wye)	277/480 V AC (Wye)
Mode of protection	L-N / N-G / L-G	L-N / N-G / L-G
Maximum continuous operating voltage (MCOV)	L-L: 750 V AC L-N: 385 V AC L-G: 385 V AC N-G: 305 V AC	L-L: 750 V AC L-N: 385 V AC L-G: 385 V AC N-G: 305 V AC
Nominal discharge current I_n	20 kA	20 kA
Total discharge current I_{total} (8/20) μ s	160 kA	160 kA
Maximum surge current per phase	40 kA	40 kA
Voltage protection rating (VPR)	L-L: 2500 V L-N: 1500 V L-G: 2000 V N-G: 1200 V	L-L: 2500 V L-N: 1500 V L-G: 2000 V N-G: 1200 V
Short-circuit current rating (SCCR)	200 kA	200 kA
General data	71.2 mm / 98.7 mm / 65.5 mm	
Dimensions W/H/D	10 ... 2	
UL connection data	AWG	
Standards/specifications	UL 1449 Edition 4	
Remote indication contact	PDT contact	
UL connection data	30 ... 14	
Max. operating voltage	125 V AC	
Max. operating current	1 A AC	

Ordering data

Description	Type	Order No.	Pcs./Pkt.
	VALVETRAB US	VAL-US-120/40/3+1-FM	2910354
	VAL-US-120/65/3+1-FM	2910360	1

Ordering data

Description	Type	Order No.	Pcs./Pkt.
	VALVETRAB US	VAL-US-240/40/3+1-FM	2910367
	VAL-US-277/40/3+1-FM	2910374	1

Accessories

Replacement plug		Type	Order No.	Pcs./Pkt.
		L-N/L-G/N-G	VAL-US-120/40-P	2910335
L-N/L-G/N-G	VAL-US-120/65-P	2910330	1	
N-G	GDT-US-NG/40-P	2910342	1	
N-G	GDT-US-NG/80-P	2910332	1	

Accessories

Replacement plug		Type	Order No.	Pcs./Pkt.
		L-N/L-G/N-G	VAL-US-240/40-P	2910336
L-N/L-G/N-G	VAL-US-277/40-P	2910338	1	
N-G	GDT-US-NG/40-P	2910342	1	



new

5-conductor system, L1, L2, L3, N, G,
3-phase wye



new

5-conductor system, L1, L2, L3, N, G,
3-phase wye



Total width 71.2 mm

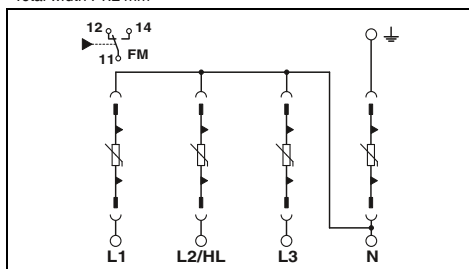

Total width 71.2 mm

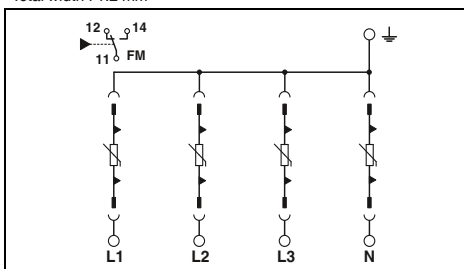

Technical data

...277/80...	...347/30...
type 1	type 1
277/480 V AC (Wye)	347/600 V AC (Wye) 400/690 V AC (Wye)
L-N / N-G / L-G	L-N / N-G / L-G
L-L: 750 V AC	L-L: 750 V AC
L-N: 385 V AC	L-N: 580 V AC
L-G: 750 V AC	L-G: 750 V AC
N-G: 385 V AC	N-G: 580 V AC
20 kA	20 kA
320 kA	30 kA
80 kA	30 kA
L-L: 2500 V	L-L: 4000 V
L-N: 1500 V	L-N: 2000 V
L-G: 2500 V	L-G: 4000 V
N-G: 1200 V	N-G: 2000 V
200 kA	200 kA

71.2 mm / 98.7 mm / 65.5 mm

10 ... 2

UL 1449 Edition 4

PDT contact

30 ... 14

125 V AC

1 A AC

Technical data

...277/40...	...277/80...
type 1	type 1
277/480 V AC	277/480 V AC
L-L / L-N / L-G / N-G	L-L / L-N / L-G / N-G
L-L: 750 V AC	L-L: 750 V AC
L-N: 750 V AC	L-N: 750 V AC
L-G: 385 V AC	L-G: 385 V AC
N-G: 385 V AC	N-G: 385 V AC
20 kA	20 kA
160 kA	320 kA
40 kA	80 kA
L-L: 2500 V	L-L: 2500 V
L-N: 1500 V	L-N: 2500 V
L-G: 2000 V	L-G: 1500 V
N-G: 1500 V	N-G: 1200 V
200 kA	200 kA

71.2 mm / 98.7 mm / 65.5 mm

10 ... 2

UL 1449 Edition 4

PDT contact

30 ... 14

125 V AC

1 A AC

Ordering data

Type	Order No.	Pcs./Pkt.
VAL-US-277/80/3+1V-FM	2910379	1
VAL-US-347/30/3+1V-FM	1079099	1

Accessories

VAL-US-277/80-P	2910331	1
VAL-US-347/30-P	2910339	1

Ordering data

Type	Order No.	Pcs./Pkt.
VAL-US-277/40/4+0-FM	2910375	1
VAL-US-277/80/4+0-FM	2910380	1

Accessories

VAL-US-277/40-P	2910338	1
VAL-US-277/80-P	2910331	1

Surge protection and interference suppression filters

Surge protection for the power supply

Surge protection for NEMA systems

VALVETRAB US – Delta

- Surge protection in accordance with UL Listed type 1
- Just one connection terminal block for GND
- Consistent pluggable design
- Disconnect device on each individual plug
- Optical, mechanical status indication for the individual arresters
- With floating remote indication contact
- Mechanical coding of all slots
- Plug can be tested with CHECKMASTER 2



2-conductor system, L, N/G, single-phase for delta



3-conductor system, L1, L2, G, 3-phase corner-grounded delta



Total width 17.8 mm

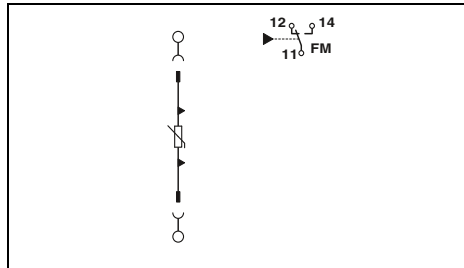

Technical data

Electrical data	...240D/40...	...480D/30...	...600D/30...
UL type	type 1	type 1	type 1
Nominal voltage U_N	240 V AC (Single-phase)	480 V AC (Single-phase)	600 V AC
Mode of protection	L-G	L-G	L-G
Maximum continuous operating voltage (MCOV)	275 V AC	580 V AC	750 V AC
Nominal discharge current I_n	20 kA	20 kA	20 kA
Total discharge current I_{total} (8/20) μ s	40 kA	30 kA	30 kA
Maximum surge current per phase	40 kA	30 kA	30 kA
Voltage protection rating (VPR)	1000 V	2000 V	2500 V
Short-circuit current rating (SCCR)	200 kA	200 kA	200 kA
General data	17.8 mm / 96.8 mm / 65.5 mm		
Dimensions W/H/D	10 ... 2		
UL connection data	AWG		
Standards/specifications	UL 1449 Edition 4		
Remote indication contact	PDT contact		
UL connection data	AWG		
Max. operating voltage	125 V AC		
Max. operating current	1 A AC		



Total width 35.6 mm

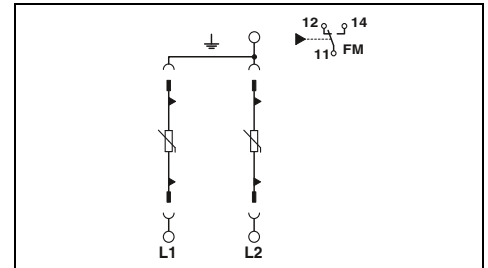

Technical data

Electrical data	...240D/40...	...480D/30...	...600D/30...
UL type	type 1	type 1	type 1
Nominal voltage U_N	240 V AC (3-phase corner-grounded delta)	480 V AC (3-phase corner-grounded delta)	600 V AC
Mode of protection	L-L / L-G	L-L / L-G	L-L / L-G
Maximum continuous operating voltage (MCOV)	L-L: 550 V L-G: 275 V AC	L-L: 750 V AC L-G: 580 V AC	L-L: 750 V AC L-G: 750 V AC
Nominal discharge current I_n	20 kA	20 kA	20 kA
Total discharge current I_{total} (8/20) μ s	80 kA	60 kA	60 kA
Maximum surge current per phase	40 kA	30 kA	30 kA
Voltage protection rating (VPR)	L-L: 1800 V L-G: 1000 V	L-L: 4000 V L-G: 2000 V	L-L: 4000 V L-G: 2500 V
Short-circuit current rating (SCCR)	200 kA	200 kA	200 kA
General data	35.6 mm / 96.8 mm / 65.5 mm		
Dimensions W/H/D	10 ... 2		
UL connection data	AWG		
Standards/specifications	UL 1449 Edition 4		
Remote indication contact	PDT contact		
UL connection data	AWG		
Max. operating voltage	125 V AC		
Max. operating current	1 A AC		

Ordering data

Description	Type	Order No.	Pcs./Pkt.
VALVETRAB US	VAL-US-240D/40/1+0-FM	2910368	1
	VAL-US-480D/30/1+0-FM	2910384	1
	VAL-US-600D/30/1+0-FM	2910388	1

Accessories

Replacement plug	Type	Order No.	Pcs./Pkt.
L-L/L-G	VAL-US-240D/40-P	2910337	1
L-L/L-G	VAL-US-480D/30-P	2910340	1
L-L/L-G	VAL-US-600D/30-P	2910341	1
N-G			

Ordering data

Description	Type	Order No.	Pcs./Pkt.
VALVETRAB US	VAL-US-240D/40/2+0-FM	2910369	1
	VAL-US-480D/30/2+0-FM	2910385	1
	VAL-US-600D/30/2+0-FM	2910390	1

Accessories

Replacement plug	Type	Order No.	Pcs./Pkt.
L-L/L-G	VAL-US-240D/40-P	2910337	1
L-L/L-G	VAL-US-480D/30-P	2910340	1
L-L/L-G	VAL-US-600D/30-P	2910341	1



new



4-conductor system, L1, L2, L3, G,
3-phase delta



new



5-conductor system, L1, HL, L3, N, G,
high-leg delta



new



5-conductor system, L1, HL, L3, N, G,
high-leg delta



Total width 53.4 mm

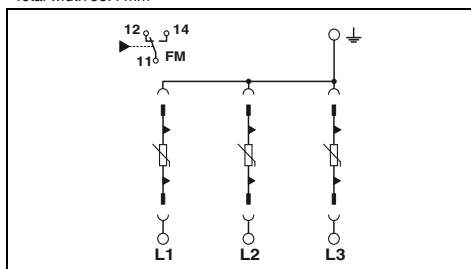

Technical data

...240D/40...	...480D/30...	...600D/30...
type 1	type 1	type 1
240 V AC (3-phase delta)	480 V AC (3-phase delta)	600 V AC
L-L / L-G L-L: 550 V AC L-G: 275 V AC	L-L / L-G L-L: 750 V AC L-G: 580 V AC	L-L / L-G L-L: 750 V AC L-G: 750 V AC
20 kA 120 kA 40 kA L-L: 1800 V L-G: 1000 V	20 kA 90 kA 30 kA L-L: 4000 V L-G: 2000 V	20 kA 90 kA 30 kA L-L: 4000 V L-G: 2500 V
200 kA	200 kA	200 kA

53.4 mm / 98.7 mm / 65.5 mm
10 ... 2
UL 1449 Edition 4
PDT contact
30 ... 14
125 V AC
1 A AC

Ordering data

Type	Order No.	Pcs./Pkt.
VAL-US-240D/40/3+0-FM	2910370	1
VAL-US-480D/30/3+0-FM	2910386	1
VAL-US-600D/30/3+0-FM	2910391	1

Accessories

Type	Order No.	Pcs./Pkt.
VAL-US-240D/40-P	2910337	1
VAL-US-480D/30-P	2910340	1
VAL-US-600D/30-P	2910341	1



Total width 71.2 mm

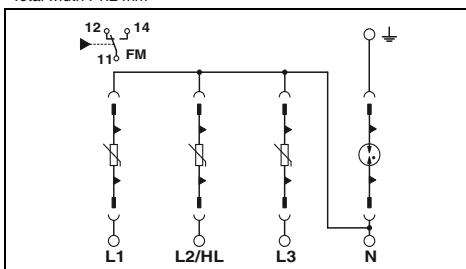

Technical data

...240HLD/40...
type 1
120/240 V AC (High-leg delta)
L-N (HL-N) / N-G / L-G (HL-G) L-L: 350 V AC HL-L: 450 V AC L-N: 175 V AC HL-N: 275 V AC L-G: 175 V AC N-G: 305 V AC
20 kA 160 kA 40 kA L-L: 1200 V HL-L: 1500 V L-N: 700 V HL-N: 1000 V L-G: 1200 V N-G: 1200 V
200 kA

71.2 mm / 98.7 mm / 65.5 mm
10 ... 2
UL 1449 Edition 4
PDT contact
30 ... 14
125 V AC
1 A AC

Ordering data

Type	Order No.	Pcs./Pkt.
VAL-US-240HLD/40/3+1-FM	2910371	1

Accessories

Type	Order No.	Pcs./Pkt.
VAL-US-120/40-P	2910335	1
VAL-US-240D/40-P	2910337	1
GDT-US-NG/40-P	2910342	1



Total width 71.2 mm

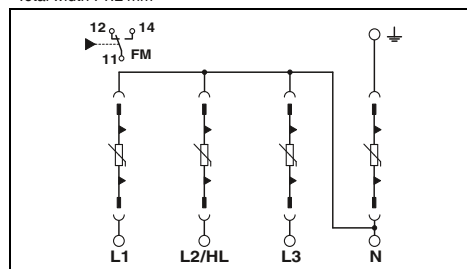

Technical data

...480HLD/30...
type 1
240/480 V AC (High-leg delta)
L-N (HL-N) / N-G / L-G (HL-G) L-L: 750 V AC HL-L: 750 V AC L-N: 385 V AC HL-N: 580 V AC L-G: 750 V AC N-G: 385 V AC
20 kA 120 kA 30 kA L-L: 2500 V HL-L: 3000 V L-N: 1500 V HL-N: 2000 V L-G: 3000 V N-G: 1500 V
200 kA

71.2 mm / 98.7 mm / 65.5 mm
10 ... 2
UL 1449 Edition 4
PDT contact
30 ... 14
125 V AC
1 A AC

Ordering data

Type	Order No.	Pcs./Pkt.
VAL-US-480HLD/30/3+1V-FM	2910387	1

Accessories

Type	Order No.	Pcs./Pkt.
VAL-US-240/40-P	2910336	1
VAL-US-480D/30-P	2910340	1

Surge protection and interference suppression filters

Surge protection for the power supply

Feed-through terminal block and equipotential bonding strip

Feed-through terminal block

- For wiring mixed combinations of lightning current and surge arresters

Equipotential bonding strip

- For main equipotential bonding in accordance with DIN VDE 0100
- Also for lightning protection equipotential bonding in accordance with DIN EN 62305



Feed-through terminal block



Equipotential bonding strip

Total width 17.7 mm

Technical data

Electrical data	
Maximum continuous operating voltage U_c	500 V AC
Nominal current I_N	-
Impulse discharge curr. I_{imp} (10/350) μ s	Peak value 100 kA
General data	
Dimensions W/H/D	17.7 mm / 89.8 mm / 65.5 mm
Connection data rigid / flexible / AWG	0.5 ... 35 mm ² / 0.5 ... 25 mm ² / 20 ... 2
Temperature range	-40°C ... 85°C
Flammability rating in accordance with UL 94	V-0
Test standards	EN 60947-7-1 / IEC 61643-11 / EN 61643-11

Ordering data

Description	
Feed-through terminal block with biconnect connecting terminal blocks as wiring aid for lightning current and surge arrester applications.	
Equipotential bonding strip	

Type	Order No.	Pcs./Pkt.
DK-BIC-35	2749880	1

Total width 59 mm

Technical data

Electrical data	
Maximum continuous operating voltage U_c	-
Nominal current I_N	-
Impulse discharge curr. I_{imp} (10/350) μ s	Peak value -
General data	
Dimensions W/H/D	59 mm / 149 mm / -
Connection data rigid / flexible / AWG	2.5 ... 95 mm ² / mm ² / -
Temperature range	-
Flammability rating in accordance with UL 94	-
Test standards	-

Ordering data

Type	Order No.	Pcs./Pkt.
PAS-1	2765615	1

Wiring bridges and marking materials

Marking material

- For clear and logical identification
- Can be marked with the MARKING system or by hand using B-STIFT

Wiring bridges

- 1-phase with various numbers of positions



Wiring bridges



Marking label for the SEC product range

Total width 20 mm

Description	Ordering data			Ordering data		
	Type	Order No.	Pcs./Pkt.	Type	Order No.	Pcs./Pkt.
Wiring bridge , for wiring applications with lightning current and surge arresters; these can be found on the website under the corresponding items 2-pos. 3-pos. 4-pos. 5-pos. 6-pos. 8-pos. 9-pos. 12-pos. 57-pos.	MPB 18/1- 2 MPB 18/1- 3 MPB 18/1- 4 MPB 18/1- 5 MPB 18/1- 6 MPB 18/1- 8 MPB 18/1- 9 MPB 18/1-12 MPB 18/1-57	2809209 2809212 2809225 2817864 2748564 2748577 2748580 2748593 2809238	10 10 10 10 10 10 10 10 10 1			
Wiring bridge , 35 mm ² 6-pos. 8-pos.	MPB 18/1-6/35 MPB 18/1-8/35	2908705 2908704	10 10			
Continuous labels , can be marked with thermal transfer printers, can be separated with a cutter, pitch as desired, strip length up to 1000 mm, 1 roll = 40 m continuous, height: 20 mm Color: yellow				EML (20XE)R EML (20XE)R YE	0803452 0803453	1 1

Isolating spark gap and accessories

- Isolating spark gap for indirect equipotential bonding
- Protection of insulating flanges in pipelines
- Can be used in Ex protection zone 1
- Accessories for lightning current absorbing connection



Spark gap



Electrical data	
Lightning protection class	H
Lightning surge current I_{imp} (10/350) μ s	100 kA
Nominal discharge current I_n (8/20) μ s	100 kA
Rated power-frequency withstand voltage U_{wAC}	250 V AC
Rated DC withstand voltage U_{wDC}	354 V DC
Rated impulse sparkover voltage $U_{t,imp}$	≤ 1.25 kV
General data	
Dimensions: length/housing diameter	100 mm +2 mm / 45.50 mm
Temperature range	-20°C ... 60°C
Test standards	IEC 62561-3 / EN 62561-3
Approvals	
EC-type examination certificate in accordance with ATEX ATEX	DEKRA 14ATEX0050 X Ex II 2 G Ex d IIC T6 Gb Ex II 2 D Ex tb IIIC T80°C Db IP 66/67
IECEX	Ex d IIC T6 Gb Ex tb IIIC T80°C Db IP66/67

Technical data

Ordering data		
Type	Order No.	Pcs./Pkt.
FLT-ISG-100-EX	2905579	1

Description	Drill hole diameter
Isolating spark gap for the Ex area	
Fixing bracket	11 mm 14 mm 18 mm 22 mm 26 mm 30 mm 33 mm 36 mm 39 mm 42 mm 48 mm 56 mm 62 mm
Mounting rail	11 mm 14 mm 18 mm 22 mm 26 mm 30 mm 33 mm 36 mm 39 mm 42 mm
Connecting cable , conductor cross section: 25 mm ² , conductor designation: H01 N2-D Cable length: 100 mm Cable length: 200 mm Cable length: 300 mm	

Ordering data

Type	Order No.	Pcs./Pkt.
FLT-ISG-100-EX	2905579	1



Fixing bracket



Mounting rail



Connecting cable

Ordering data			Ordering data			Ordering data		
Type	Order No.	Pcs./Pkt.	Type	Order No.	Pcs./Pkt.	Type	Order No.	Pcs./Pkt.
FLT-ISG-BR-11	2905580	1						
FLT-ISG-BR-14	2905581	1						
FLT-ISG-BR-18	2905582	1						
FLT-ISG-BR-22	2905583	1						
FLT-ISG-BR-26	2905757	1						
FLT-ISG-BR-30	2905758	1						
FLT-ISG-BR-33	2905759	1						
FLT-ISG-BR-36	2905760	1						
FLT-ISG-BR-39	2905761	1						
FLT-ISG-BR-42	2905762	1						
FLT-ISG-BR-48	2905763	1						
FLT-ISG-BR-56	2905764	1						
FLT-ISG-BR-62	2905765	1						
			FLT-ISG-PL-11	2905584	1			
			FLT-ISG-PL-14	2905586	1			
			FLT-ISG-PL-18	2905587	1			
			FLT-ISG-PL-22	2905588	1			
			FLT-ISG-PL-26	2905745	1			
			FLT-ISG-PL-30	2905746	1			
			FLT-ISG-PL-33	2905747	1			
			FLT-ISG-PL-36	2905754	1			
			FLT-ISG-PL-39	2905755	1			
			FLT-ISG-PL-42	2905756	1			
						FLT-ISG-CA-100	2905589	1
						FLT-ISG-CA-200	2905590	1
						FLT-ISG-CA-300	2905591	1



Surge protection in thin layers – TERMITRAB complete

Starting from an overall width of 3.5 mm, the TERMITRAB complete product range is a tailored product range for almost all applications in measurement and control technology. Depending on the type of signal to be protected, with TERMITRAB complete you will find an ideally suited circuit version in the portfolio.

Signaling and disconnection

The mechanical status indicator functions without additional auxiliary energy and displays the disconnection of a protective element in the event of an overload. This means you are constantly informed of the status and can replace the overloaded protective device.

Remote signaling

Thanks to the remote signaling modules that are available as an option, you can decide whether and when you require this feature. To monitor retrospectively, you can easily align remote signaling modules to protective devices that are already installed. If a protective element is disconnected in the event of an overload, the disconnect device closes the monitoring channel and group remote signaling is triggered. The overloaded device is detected on site by the status indicator – and that is purely mechanically, without auxiliary energy.

Universal use

The areas of application for TERMITRAB complete are so diverse that they can be used in any industry. Thanks to the narrow overall width, starting from 3.5 mm, the product range is ideal for process technology, as very often a high packing density is required in the distribution cabinets. They protect up to 572 signals on one meter, which means that your systems can be made smaller. The various approvals permit use in onshore and offshore systems, e.g., for petrochemicals or wind power. The tailored TERMITRAB complete portfolio offers you the widest range of features, and therefore an optimum product selection for your applications. This means you can reliably protect your signals against surge voltages – from the field to the controller.

Quick wiring

TERMITRAB complete is available with conventional screw connection and innovative Push-in connection technology. It guarantees quick and easy installation in the control cabinet. At the same time, the Push-in connection technology enables mechanical wiring of the surge protective devices, within the scope of tomorrow's intelligent automation solutions.

i Your web code: **#0292**



The narrowest surge protection

Starting from an overall width of 3.5 mm, TERMITRAB complete is the world's first surge protection solution for measurement and control technology.

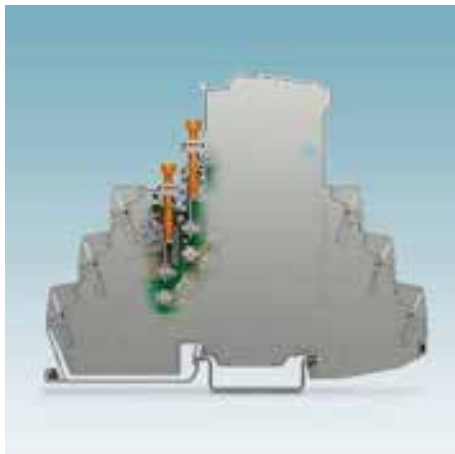

Innovative knife disconnection

The integrated knife disconnection enables the signal path to be broken up, e.g., to carry out isolation measurements. An open signal path is easy to detect from the projecting function screws. The screws are equipped with overwind protection.



Optional visual remote signaling

Up to 40 protective devices are visually monitored with the optional remote signaling modules. Add further protective devices easily to the monitoring system without additional wiring effort.

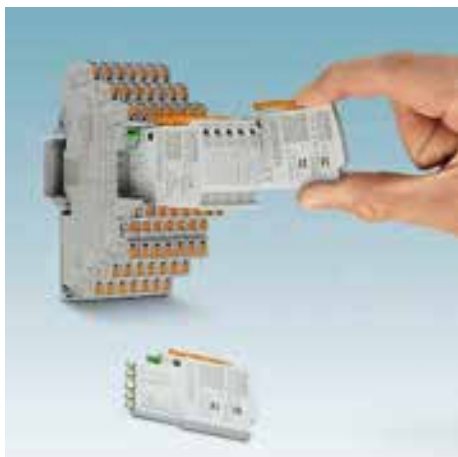

Plug in, remove, and test

For repeated tests, remove the plugs of multi-piece protective devices without impedance. The signals are not interrupted and the controllers do not immediately detect an impedance change in the measuring circuit. Testing and documentation takes place in the CHECKMASTER 2. If a replacement is required, the affected plug is simply replaced without accessing the installation.

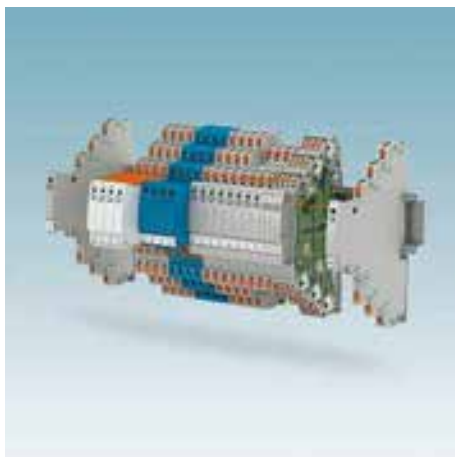

Tailored portfolio

The portfolio ranges from single-stage, one-piece protective devices to multi-stage pluggable versions. A range of voltage and circuit versions that are optimized for different applications and various connection technologies complete the product range.



Versatile

Certain applications require special tests and approvals. TERMITRAB complete meets the requirements of Underwriters Laboratories (UL). Furthermore, versions with ATEX, IEC Ex, and GL approvals are available.



Intelligent and systematic surge protection – PLUGTRAB PT-IQ

The PLUGTRAB PT-IQ product range is the first to offer predictive function monitoring for surge protective devices in the context of measurement and control technology. Boasting a whole range of additional features, the new surge protection system is a real highlight from Phoenix Contact.

Always know what is happening – Predictive monitoring

The individual components of the protective devices are permanently monitored. When the performance limit has been reached as a result of frequent surge voltages, this is indicated by the yellow status symbol. The arrester continues to function and your system is still protected. However, replacement of the protective plug is recommended. This ensures you are informed even earlier and can replace your surge protection before the protective plug is overloaded (red signal). Furthermore, if you use the remote signaling option, you can check how well your system is being protected from anywhere and at any time.

Permanent and error-free installation

The PLUGTRAB PT-IQ minimizes the amount of wiring required. This is made possible by the DIN rail connector (TBUS), which is easily clipped onto the DIN rail. A controller handles the distribution of the power supply and implements remote signaling of all connected surge protective devices via the TBUS. All you have to do then is install the surge protective devices on the TBUS – and you're done! The plug and base element are coded to avoid installation errors during replacement.

Limitless extension

The controller monitors all arresters which are connected to the controller via the TBUS. You can bridge the TBUS across DIN rails to monitor even more protective devices. After 28 protective devices, an additional controller must be installed to supply voltage. Remote signaling can be performed from any controller in the system.

Other surge protective devices

PLUGTRAB PT are pluggable protective devices without remote signaling, also with circuit versions for intrinsically safe signal circuits.

The multi-level terminal blocks in the TERMITRAB or LINETRAB product ranges have an overall width of just 6.2 mm yet are able to offer protection for up to four signal wires.

As they are installed directly on measuring sensors, the SURGETRAB screw connection modules are able to provide reliable protection against transients even in EX i and Ex d applications.

The products in the COMTRAB modular range have been designed specifically for use in marshaling distributors.

i Your web code: #0144



Group message

- Green: protective device OK
- Yellow: performance limit reached, replacement recommended
- Red: protective device overloaded, replace



Multi-stage remote signaling

Connect the remote signaling to the controller that acts as a supply and remote module (one-off connection operation). The status is output according to the priority as red, yellow or green. This ensures you always know what is happening and can always keep an eye on your system's protection.

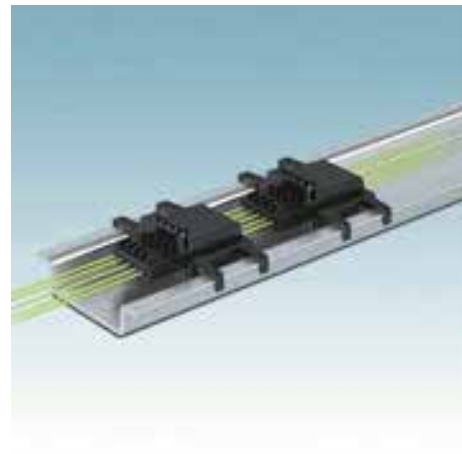

TBUS DIN rail connector

The DIN rail connector (TBUS) supplies voltage to the protection modules and forwards the status of each individual arrester to the controller. You benefit from the reduced wiring costs and can implement surge protection quickly without errors.



For Ex zone 2

With the PLUGTRAB PT-IQ Ex protective devices, it is possible for the first time to install protective devices with multi-stage monitoring and remote signaling directly in Ex zone 2. The intrinsically safe protective circuits can be led up to Ex zone 0.



Special systems

Implement protection in the field directly at the measuring sensor with SURGETRAB screw connection modules.



Easy selection

With just a few clicks, our MCR configurator helps you find the ideal protection for your application. Refine the product selection further by defining additional properties. If the quick search function does not find a solution for your application, use the advanced search to find more products. You can access the MCR configurator using the web code:

i Your web code: #1389

Surge protection and interference filters

Surge protection for measurement and control technology

Selection guide





Explanation of the IEC categories

LPZ zone	Test category for SPD in acc. with IEC 61643-21	Test class for SPD in acc. with IEC 61643-11
0/1	D1	I
1/2	C2	II
2/3	C1	III

Interface-based product selection for surge protection

The STOP-IT (Selection of Protection for Information Technology) selection guide provides support in choosing your surge protection solution for a variety of additional interfaces in information and MCR technology.

i Your web code: #2079

































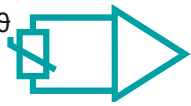





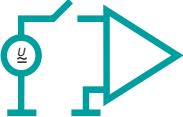









	DIN rail mounting
	Push-in connection
	Screw connection
	Cables
1)	Also available with screw connection technology

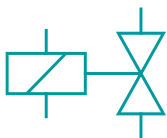

Data for fault analysis in accordance with IEC 61508 is available on the Internet.



Note
Products bearing this stamp (plug elements) can be tested with CHECKMASTER 2.

Application	Installation Properties
 0(4) mA ... 20 mA current loops	 
	  1)
	  1)
	
 0(4) mA ... 20 mA current loops with power supply cable	 
	 
	
	
Analog signal 0 V ...10 V	 
	  1)
	  1)
	
 Resistance-dependent measurement e.g., with Pt 100	  1)
	  1)
	
	
 Digital input/ digital output	Common reference conductor: isolated from ground   1)
	  1)
	
	Common reference conductor: grounded directly  
	  1)
	  1)
 Digital output > 600 mA	Common reference conductor: isolated from ground   1)
	  1)
	
	Common reference conductor: grounded directly   1)

Overall width in mm	IEC category	Status display	Pluggable	Knife disconnection	IQ function monitoring	Protected wires	Surge protective device (SPD)	Order No.	Page
3.5	D1/C2/C1					2	TTC-3-1X2-24DC-PT	2907325	119
6.2	D1/C2/C1	✓	✓	✓		2	TTC-6P-1X2-M-24DC-PT-I	2906750	116
17.5	D1/C2/C1	✓	✓		✓	3	PT-IQ-1X2-24DC-PT	2801255	120
> 17.5	D1/C2/C1					2	S-PT-1X2-24DC	2880668	125
6.2	D1/C2/C1	✓	✓	✓		2	TTC-6P-1X2-M-EX-24DC-UT-I	2906824	152
17.5	D1/C2/C1	✓	✓		✓	2	PT-IQ-1X2-EX-24DC-UT	2801512	153
> 17.5	D1/C2/C1					2	S-PT-EX-24DC	2800034	154
3.5	D1/C2/C1					3	TTC-3-2X1-24DC-PT	2907326	131
6.2	D1/C2/C1	✓	✓	✓		3	TTC-6P-2X1-F-M-24DC-PT-I	2906794	129
17.5	D1/C2/C1	✓	✓		✓	3	PT-IQ-2X1+F-24DC-PT	2801248	133
> 17.5	D1/C2/C1					4	S-PT-4-EX-24DC	2800036	141
6.2	D1/C2/C1	✓	✓	✓		3	TTC-6P-2X1-M-EX-24DC-UT-I	2906825	157
> 17.5	D1/C2/C1					4	S-PT-4-EX-24DC	2800036	141
3.5	D1/C2/C1					2	TTC-3-1X2-24DC-PT	2907325	119
6.2	D1/C2/C1	✓	✓			2	TTC-6P-1X2-12DC-PT-I	2908193	116
17.5	D1/C2/C1	✓	✓		✓	2	PT-IQ-3-HF+F-12DC-PT	2801289	169
> 17.5	D1/C2/C1					2	S-PT-1X2-24DC	2880668	125
6.2	D1/C2/C1	✓	✓	✓		2	TTC-6P-2-HC-M-24DC-PT-I	2906755	136
6.2	D1/C2/C1	✓	✓			3	TTC-6P-3-24DC-PT-I	1061383	143
> 17.5	D1/C2/C1					2	S-PT-EX-24DC	2800034	154
6.2	D1/C2/C1	✓	✓			3	TTC-6P-3-EX-24DC-UT-I	1064665	158
6.2	D1/C2/C1	✓	✓	✓		3	TTC-6P-2X1-F-M-24DC-PT-I	2906794	129
17.5	D1/C2/C1	✓	✓		✓	5	PT-IQ-4X1+F-24DC-PT	2801272	133
> 17.5	D1/C2/C1					5	S-PT-4-EX-24DC	2800036	141
3.5	D1/C2/C1					3	TTC-3-2X1-24DC-PT	2907326	131
6.2	D1/C2/C1	✓	✓	✓		3	TTC-6P-2X1-M-24DC-PT-I	2906753	128
17.5	D1/C2/C1	✓	✓		✓	5	PT-IQ-4X1-24DC-PT	2801271	133
> 17.5	D1/C2/C1					5	S-PT-4-EX-24DC	2800036	141
6.2	D1/C2/C1	✓	✓	✓		3	TTC-6P-2-HC-M-24DC-PT-I	2906755	136
17.5	D1/C2/C1	✓	✓		✓	5	PT-IQ-4X1+F-24DC-PT	2801272	133
> 17.5	D1/C2/C1					2	S-PT-EX-24DC	2800034	154
17.5	D1/C2/C1	✓	✓		✓	5	PT-IQ-4X1-24DC-PT	2801271	133

Surge protection and interference filters

Surge protection for measurement and control technology

Protection of a 0(4) ... 20 mA current loop

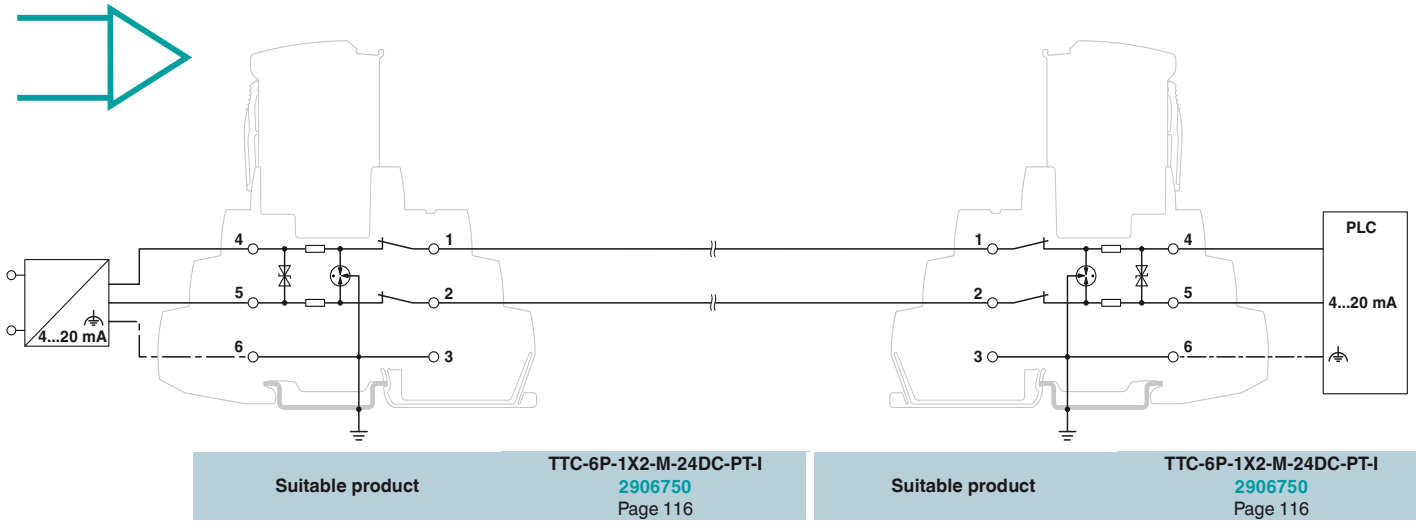

Protection of a 0(4) ... 20 mA current loop, intrinsically safe circuit

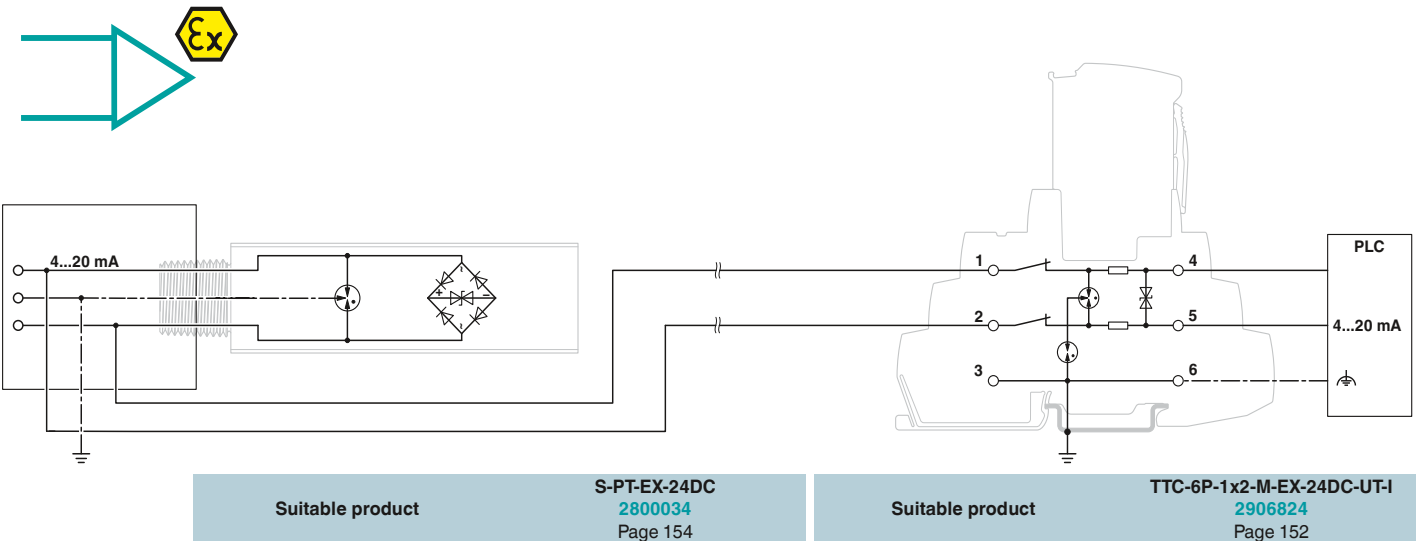

Protection of a 0(4) ... 20 mA current loop and additional power supply

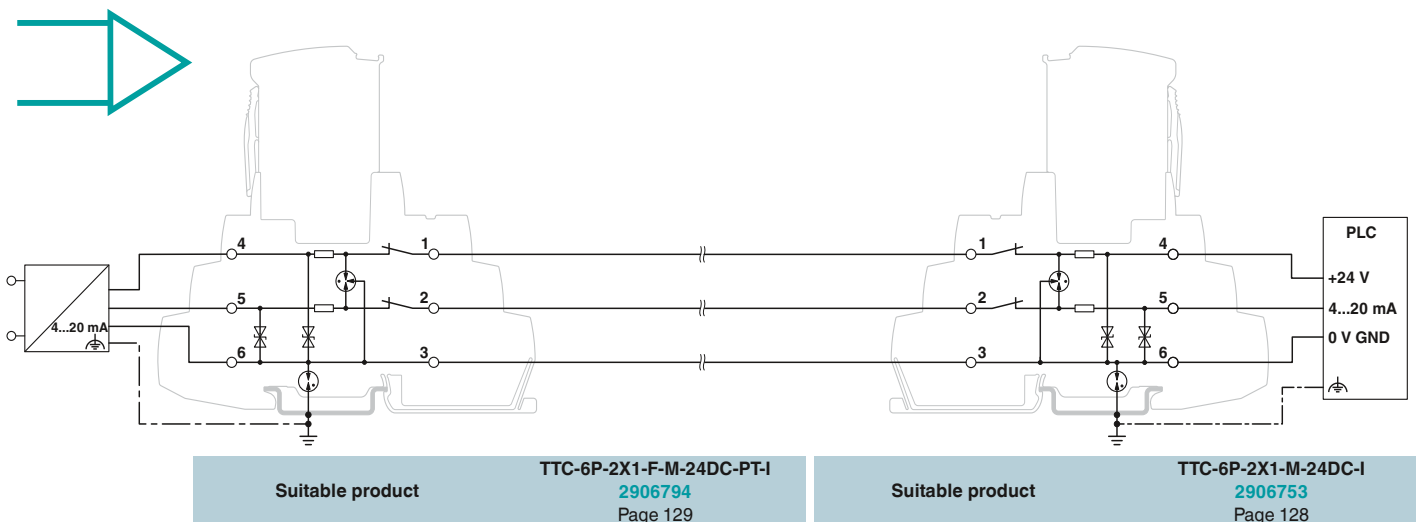

Protection of a 0(4) ... 20 mA current loop

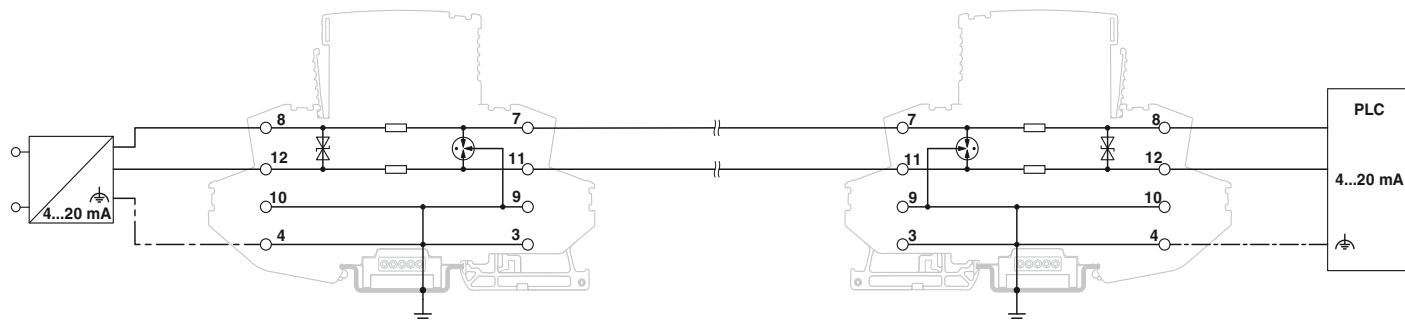
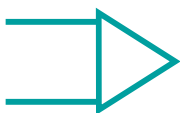

Suitable product

PT-IQ-1X2-24DC-PT
2801255
Page 120

Suitable product

PT-IQ-1X2-24DC-PT
2801255
Page 120

Protection of a 0(4) ... 20 mA current loop, intrinsically safe circuit

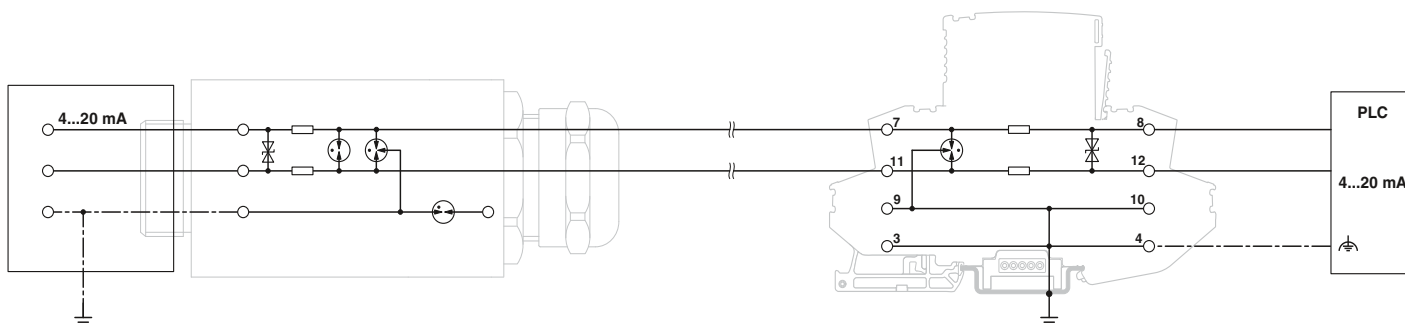

Suitable product

S-PT-EX(I)-24DC
2880671
Page 154

Suitable product

PT-IQ-1X2-EX-24DC-UT
2801512
Page 153

Protection of a 0(4) ... 20 mA current loop and additional power supply

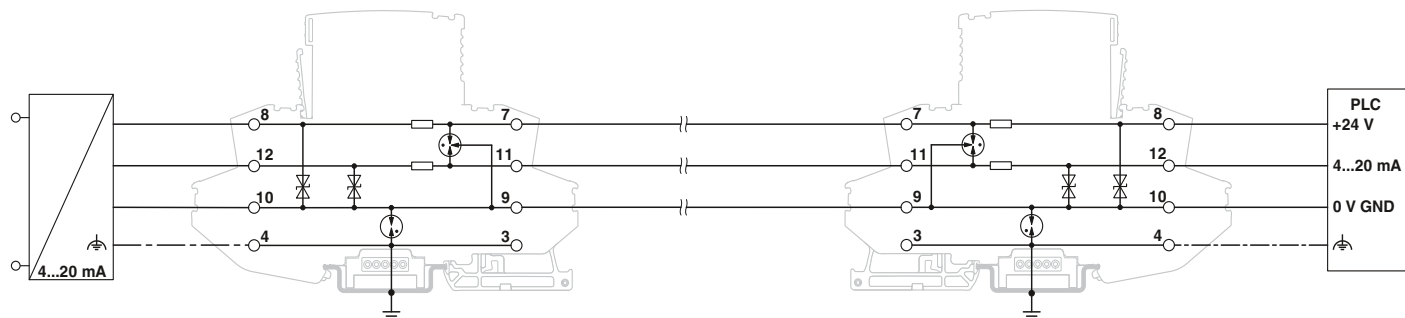
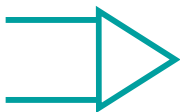

Suitable product

PT-IQ-2X1+F-24DC-PT
2801248
Page 133

Suitable product

PT-IQ-2X1+F-24DC-PT
2801248
Page 133

Surge protection and interference filters

Surge protection for measurement and control technology

Protection of a digital I/O (24 V), reference conductor not grounded

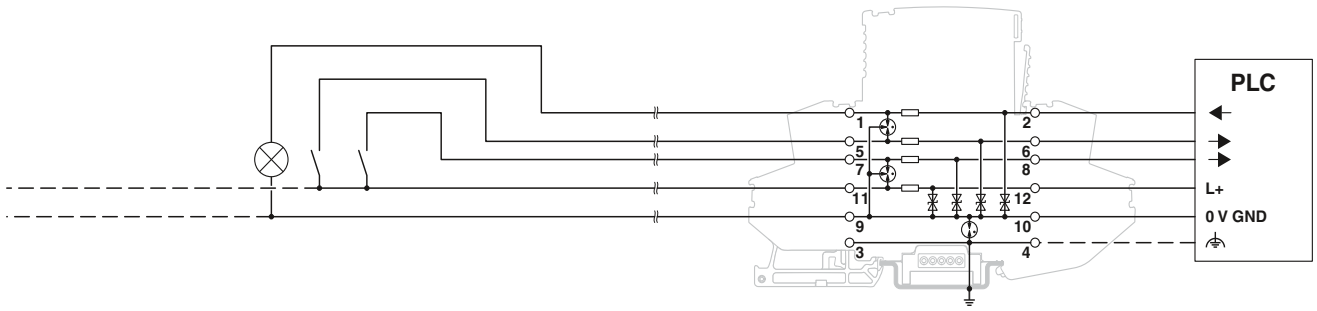
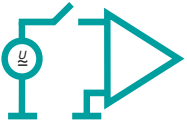

Suitable product

PT-IQ-4X1+F-24DC-PT
2801272
Page 133

Protection of digital inputs (24 V), floating, voltage protection level optimization between all wires by means of bridge

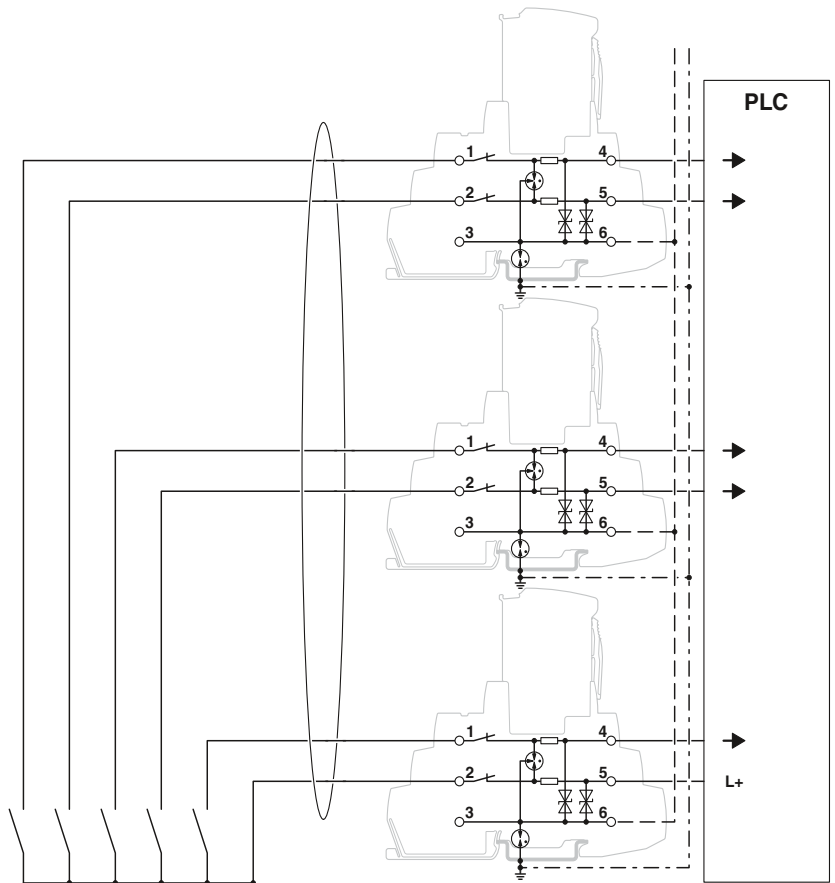
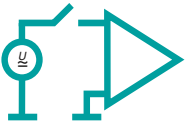

Suitable product

TTC-6P-2X1-F-M-24DC-PT-I
2906794
Page 129

Protection of a digital I/O (24 V), reference conductor grounded

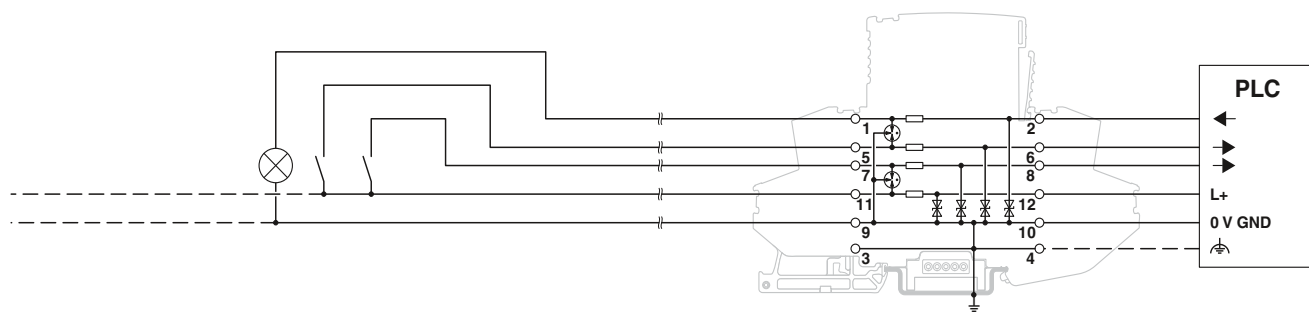
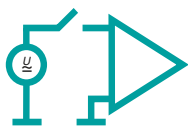

Suitable product **PT-IQ-4X1-24DC-PT**
2801271
Page 133

Protection of digital inputs (24 V), voltage protection level optimization between all wires via grounded DIN rail (ground potential)

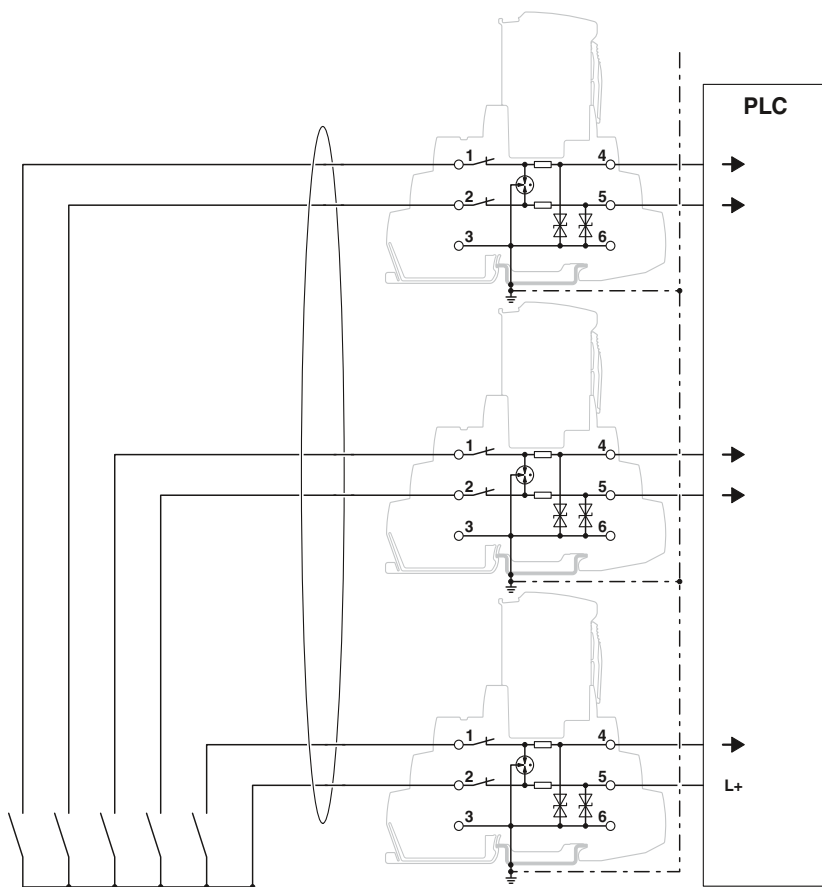
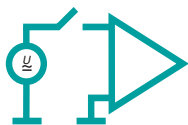

Suitable product **TTC-6P-2X1-M-24DC-PT-I**
2906753
Page 128

Protection of a digital output (actuator)

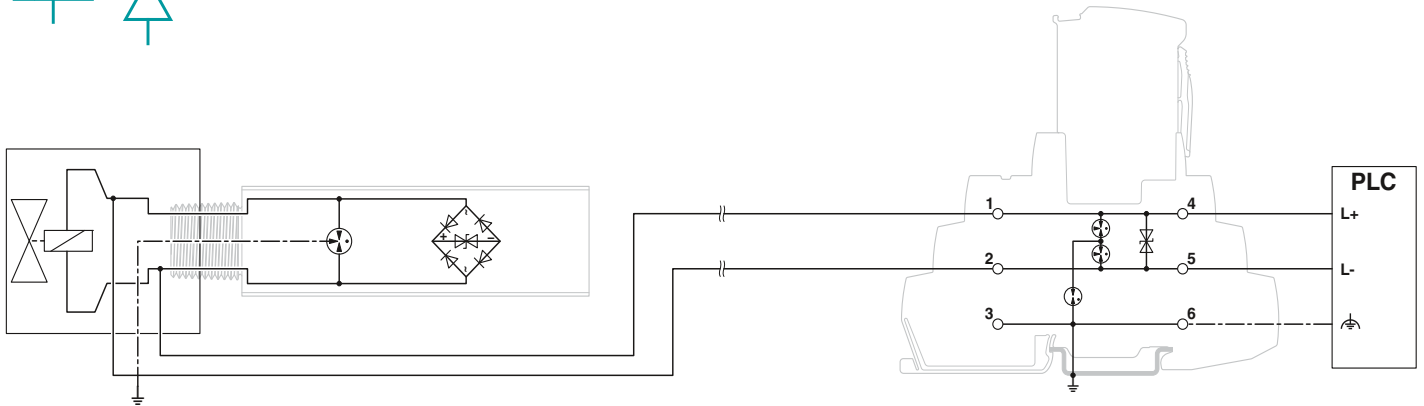
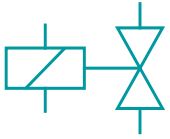

Suitable product

S-PT-EX-24DC
2800034
Page 154

Suitable product

TTC-6P-2-HC-M-24DC-PT-I
2906755
Page 136

Protection of digital inputs (24 V), version with individual floating circuits

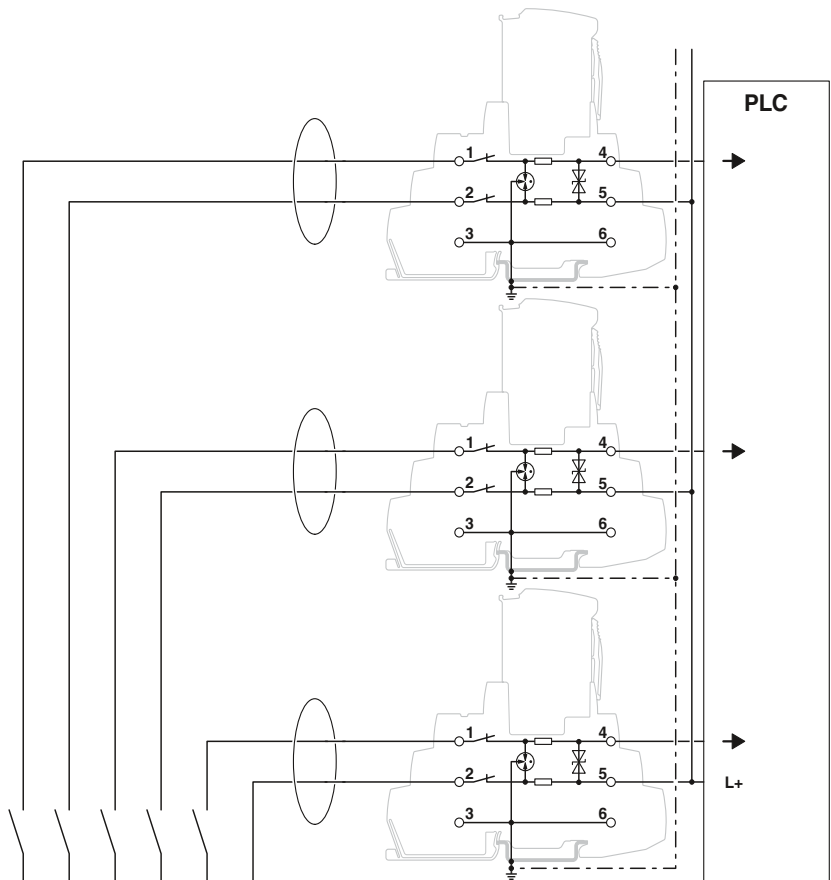
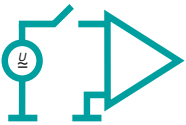

Suitable product

TTC-6P-1X2-M-24DC-PT-I
2906750
Page 116

Protection of two-wire temperature measurement

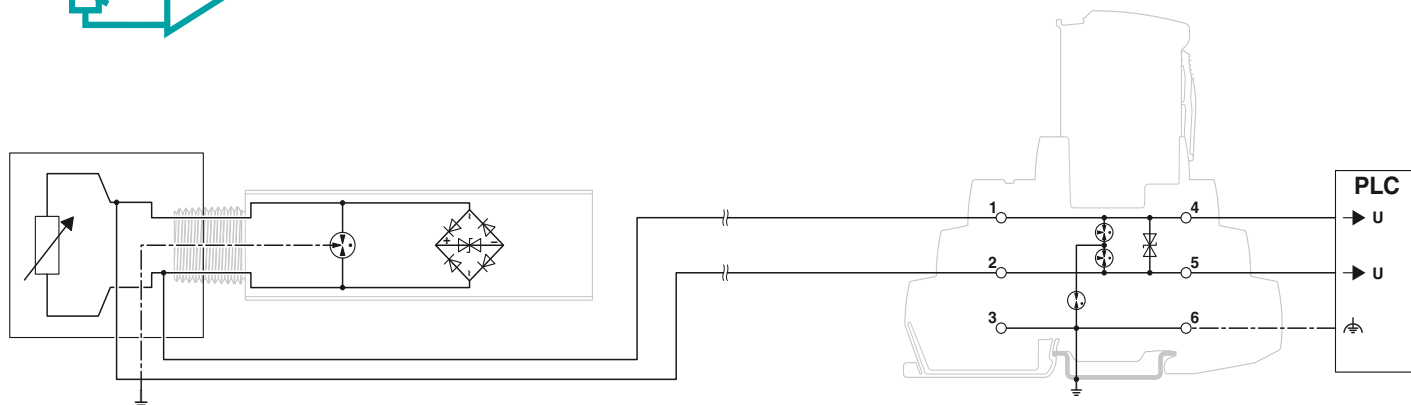
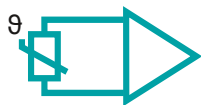

Suitable product **S-PT-EX-24DC**
2800034
Page 154

Suitable product **TTC-6P-2-HC-M-24DC-PT-I**
2906755
Page 136

Protection of four-wire temperature measurement

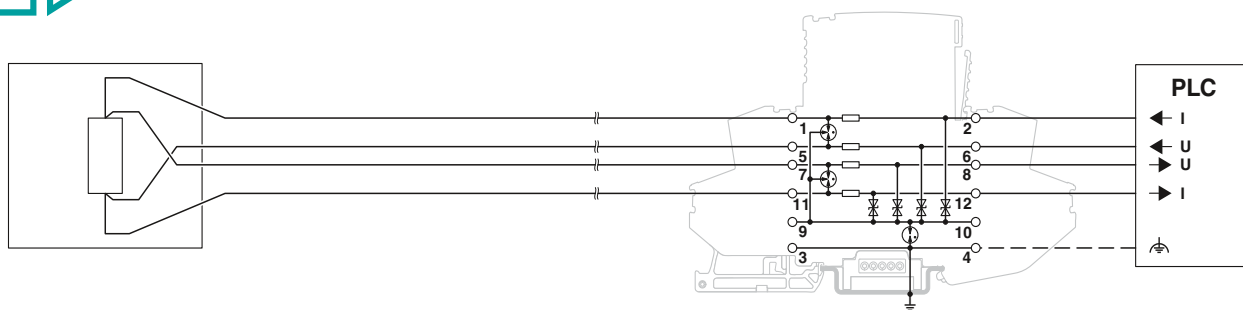

Suitable product **PT-IQ-4X1+F-12DC-PT**
2801272
Page 133

Surge protection and interference filters

Surge protection for measurement and control technology

Isolated signal circuits TERMITRAB complete

- Pluggable surge protection
- Overall width of just 6.2 mm
- With Push-in or screw connection technology
- Impedance-neutral insertion and removal
- Coded plug versions
- With knife disconnection as an option
- Integrated mechanical status indicator
- Optional remote signaling module monitors up to 40 items, without additional wiring
- Plugs can be tested with CHECKMASTER 2



Double wire (loop), floating, 3/6 connection grounded directly, e.g., for 4 ... 20 mA current loop



Double wire (loop), floating, 3/6 connection grounded directly, with knife disconnection, e.g., for 4 ... 20 mA current loop

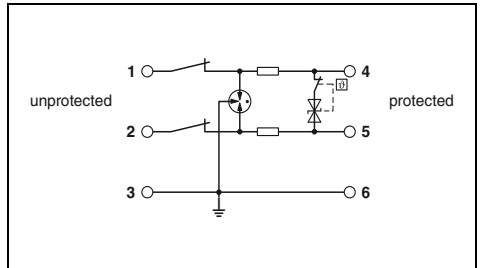
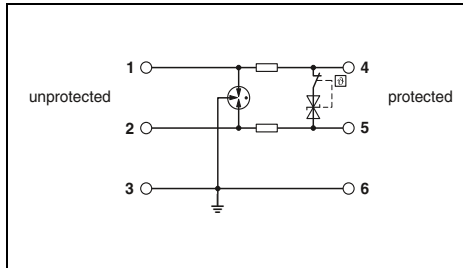

Technical data

Electrical data	... 12DC	... 24DC	... 48DC
IEC test classification/EN type	C1 / C2 / C3 / D1	C1 / C2 / C3 / D1	C1 / C2 / C3 / D1
Maximum continuous operating voltage U_c	15 V DC / 10 V AC	30 V DC / 21 V AC	55.2 V DC / 39 V AC
Rated current	600 mA (56°C)	600 mA (56°C)	160 mA (75°C)
Pulse discharge current I_{imp} (10/350) μ s	0.5 kA	0.5 kA	0.5 kA
Nominal discharge current I_n (8/20) μ s			
	Core-Core	5 kA	5 kA
	Core-Ground	5 kA	5 kA
Total discharge current I_{total} (8/20) μ s		10 kA	10 kA
Protection level U_p			
	Core-Core	≤ 25 V (C3 - 25 A)	≤ 50 V (C3 - 25 A)
	Core-Ground	≤ 700 V (C3 - 25 A)	≤ 700 V (C3 - 25 A)
Cut-off frequency f_g (3 dB)			
	Symmetrical in the 150 Ω system	typ. 420 kHz	typ. 940 kHz
Resistance per path		1.65 Ω	1.65 Ω
General data			
Dimensions W/H/D		6.2 mm / 105.8 mm / 100 mm	
Connection data rigid / flexible / AWG		0.2 ... 4 mm ² / 0.2 ... 2.5 mm ² / 24 ... 12	
Temperature range		-40°C ... 85°C	
Test standards		IEC 61643-21 / EN 61643-21	

Technical data

Electrical data	... 24DC
IEC test classification/EN type	C1 / C2 / C3 / D1
Maximum continuous operating voltage U_c	30 V DC / 21 V AC
Rated current	600 mA (56°C)
Pulse discharge current I_{imp} (10/350) μ s	0.5 kA
Nominal discharge current I_n (8/20) μ s	
	Core-Core
	Core-Ground
Total discharge current I_{total} (8/20) μ s	10 kA
Protection level U_p	
	Core-Core
	Core-Ground
Cut-off frequency f_g (3 dB)	
	Symmetrical in the 150 Ω system
Resistance per path	typ. 940 kHz
General data	
Dimensions W/H/D	6.2 mm / 105.8 mm / 100 mm
Connection data rigid / flexible / AWG	0.2 ... 4 mm ² / 0.2 ... 2.5 mm ² / 24 ... 12
Temperature range	-40°C ... 85°C
Test standards	IEC 61643-21 / EN 61643-21

Ordering data

Description	Voltage U_N	Type	Order No.	Pcs./Pkt.
TERMITRAB complete, with Push-in connection technology	12 V DC	TTC-6P-1X2-12DC-PT-I	2908193	1
	24 V DC	TTC-6P-1X2-24DC-PT-I	2906815	1
	48 V DC	TTC-6P-1X2-48DC-PT-I	2908195	1
TERMITRAB complete, with screw connection technology	12 V DC	TTC-6P-1X2-12DC-UT-I	2908192	1
	24 V DC	TTC-6P-1X2-24DC-UT-I	2906809	1
	48 V DC	TTC-6P-1X2-48DC-UT-I	2908194	1

Ordering data

Description	Voltage U_N	Type	Order No.	Pcs./Pkt.
TERMITRAB complete, with Push-in connection technology	12 V DC	TTC-6P-1X2-12DC-PT-I	2908193	1
	24 V DC	TTC-6P-1X2-24DC-PT-I	2906815	1
	48 V DC	TTC-6P-1X2-48DC-PT-I	2908195	1
TERMITRAB complete, with screw connection technology	12 V DC	TTC-6P-1X2-12DC-UT-I	2908192	1
	24 V DC	TTC-6P-1X2-24DC-UT-I	2906809	1
	48 V DC	TTC-6P-1X2-48DC-UT-I	2908194	1

Accessories

Replacement plug	12 V DC	TTC-6P-1X2-12DC-I-P	2907839	1
	24 V DC	TTC-6P-1X2-24DC-I-P	2907840	1
	48 V DC	TTC-6P-1X2-48DC-I-P	2907841	1
Remote signaling set	Push-in connection technology	TTC-6-FMRS-PT	2907811	1
	Screw connection technology	TTC-6-FMRS-UT	2907810	1
Fuse carrier		TTC-6-FC-UT	1054762	50

Accessories

Replacement plug	12 V DC	TTC-6P-1X2-12DC-I-P	2907839	1
	24 V DC	TTC-6P-1X2-24DC-I-P	2907840	1
	48 V DC	TTC-6P-1X2-48DC-I-P	2907841	1
Remote signaling set	Push-in connection technology	TTC-6-FMRS-PT	2907811	1
	Screw connection technology	TTC-6-FMRS-UT	2907810	1
Fuse carrier		TTC-6-FC-UT	1054762	50



SIL
evaluated
IEC 61508



Double wire (loop), floating, 3/6 connection grounded via gas-filled surge arrester, e.g., for 4 ... 20 mA current loop



SIL
evaluated
IEC 61508



Double wire (loop), floating, 3/6 connection grounded via gas-filled surge arrester, with knife disconnection, e.g., for 4 ... 20 mA current loop

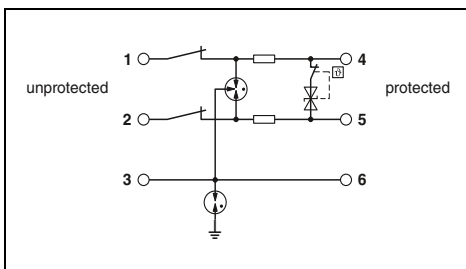
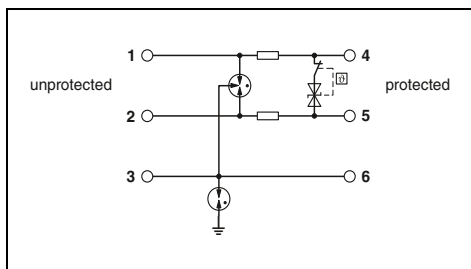

Technical data

... 12DC	... 24DC	... 48DC
C1 / C2 / C3 / D1	C1 / C2 / C3 / D1	C1 / C2 / C3 / D1
15 V DC / 10 V AC	30 V DC / 21 V AC	55.2 V DC / 39 V AC
600 mA (56°C)	600 mA (56°C)	160 mA (75°C)
0.5 kA	0.5 kA	0.5 kA
5 kA	5 kA	5 kA
5 kA	5 kA	5 kA
10 kA	10 kA	10 kA
≤ 25 V (C3 - 25 A)	≤ 1.3 kV (C3 - 25 A)	≤ 1.3 kV (C3 - 25 A)
typ. 420 kHz	typ. 940 kHz	typ. 1.8 MHz
1.65 Ω	1.65 Ω	1.65 Ω
6.2 mm / 105.8 mm / 100 mm		
0.2 ... 4 mm ² / 0.2 ... 2.5 mm ² / 24 ... 12		
-40°C ... 85°C		
IEC 61643-21 / EN 61643-21		

Technical data

... 24DC
C1 / C2 / C3 / D1
30 V DC / 21 V AC
600 mA (56°C)
0.5 kA
5 kA
5 kA
10 kA
≤ 50 V (C3 - 25 A)
≤ 1.3 kV (C3 - 25 A)
typ. 940 kHz
1.65 Ω
6.2 mm / 105.8 mm / 100 mm
0.2 ... 4 mm ² / 0.2 ... 2.5 mm ² / 24 ... 12
-40°C ... 85°C
IEC 61643-21 / EN 61643-21

Ordering data

Type	Order No.	Pcs./Pkt.
TTC-6P-1X2-F-12DC-PT-I	2908198	1
TTC-6P-1X2-F-24DC-PT-I	1065318	1
TTC-6P-1X2-F-48DC-PT-I	2908200	1
TTC-6P-1X2-F-12DC-UT-I	2908196	1
TTC-6P-1X2-F-24DC-UT-I	1065317	1
TTC-6P-1X2-F-48DC-UT-I	2908199	1

Ordering data

Type	Order No.	Pcs./Pkt.
TTC-6P-1X2-F-M-24DC-PT-I	2906790	1
TTC-6P-1X2-F-M-24DC-UT-I	2906781	1

Accessories

TTC-6P-1X2-12DC-I-P	2907839	1
TTC-6P-1X2-24DC-I-P	2907840	1
TTC-6P-1X2-48DC-I-P	2907841	1
TTC-6-FMRS-PT	2907811	1
TTC-6-FMRS-UT	2907810	1
TTC-6-FC-UT	1054762	50

Accessories

TTC-6P-1X2-24DC-I-P	2907840	1
TTC-6-FMRS-PT	2907811	1
TTC-6-FMRS-UT	2907810	1
TTC-6-FC-UT	1054762	50

Surge protection and interference filters

Surge protection for measurement and control technology

Isolated signal circuits TERMITRAB complete

- Overall width of just 6.2 mm
- With Push-in or screw connection technology
- With integrated mechanical status indicator and knife disconnection as an option
- Optional remote signaling module monitors up to 40 items, without additional wiring



Double wire (loop), floating, 3/6 connection grounded directly, e.g., for 4 ... 20 mA current loop



Double wire (loop), floating, 3/6 connection grounded via gas-filled surge arrester, with knife disconnection, e.g., for 4 ... 20mA current loop

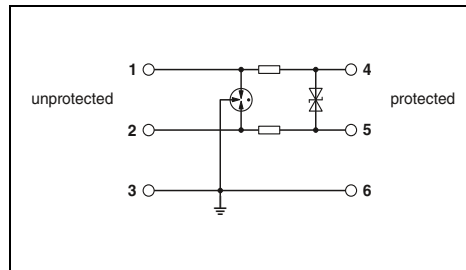

Technical data

Electrical data	
IEC test classification/EN type	C1 / C2 / C3 / D1
Maximum continuous operating voltage U_C	30 V DC / 21 V AC
Rated current	600 mA (40°C)
Pulse discharge current I_{imp} (10/350) μ s	0.5 kA
Nominal discharge current I_n (8/20) μ s	
	Core-Core 5 kA
	Core-Ground 5 kA
Total discharge current I_{total} (8/20) μ s	10 kA
Protection level U_p	
	Core-Core ≤ 50 V (C3 - 25 A)
	Core-Ground ≤ 700 V (C3 - 25 A)
Cut-off frequency f_g (3 dB)	typ. 940 kHz
	1.65 Ω
Resistance per path	Symmetrical in the 150 Ω system
General data	
Dimensions W/H/D	6.2 mm / 105.8 mm / 69.5 mm
Connection data rigid / flexible / AWG	0.2 ... 4 mm ² / 0.2 ... 2.5 mm ² / 24 ... 12
Temperature range	-40°C ... 85°C
Test standards	IEC 61643-21 / EN 61643-21

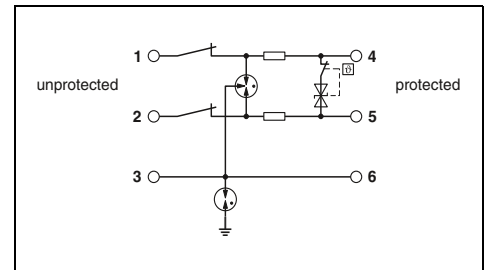

Technical data

Electrical data	
IEC test classification/EN type	C1 / C2 / C3 / D1
Maximum continuous operating voltage U_C	30 V DC / 21 V AC
Rated current	600 mA (40°C)
Pulse discharge current I_{imp} (10/350) μ s	0.5 kA
Nominal discharge current I_n (8/20) μ s	
	5 kA
	5 kA
Total discharge current I_{total} (8/20) μ s	10 kA
Protection level U_p	
	≤ 50 V (C3 - 25 A)
	≤ 1.3 kV (C3 - 25 A)
Cut-off frequency f_g (3 dB)	typ. 940 kHz
	1.65 Ω
Resistance per path	Symmetrical in the 150 Ω system
General data	
Dimensions W/H/D	6.2 mm / 105.8 mm / 83.5 mm
Connection data rigid / flexible / AWG	0.2 ... 4 mm ² / 0.2 ... 2.5 mm ² / 24 ... 12
Temperature range	-40°C ... 85°C
Test standards	IEC 61643-21 / EN 61643-21

Ordering data

Description	Voltage U_N
TERMITRAB complete, with Push-in connection technology	
Without status indicator	24 V DC
With status indicator	24 V DC
TERMITRAB complete, with screw connection technology	
Without status indicator	24 V DC
With status indicator	24 V DC

Type	Order No.	Pcs./Pkt.
TTC-6-1X2-24DC-PT	2906804	1
TTC-6-1X2-M-24DC-PT-I	2906726	1
TTC-6-1X2-24DC-UT	2906798	1
TTC-6-1X2-M-24DC-UT-I	2906713	1

Accessories

Remote signaling set	
Push-in connection technology	
Screw connection technology	
Fuse carrier	

Type	Order No.	Pcs./Pkt.
TTC-6-FMRS-PT	2907811	1
TTC-6-FMRS-UT	2907810	1
TTC-6-FC-UT	1054762	50

Ordering data

Type	Order No.	Pcs./Pkt.
TTC-6-1X2-F-M-24DC-PT-I	2906772	1
TTC-6-1X2-F-M-24DC-UT-I	2906764	1

Accessories

Type	Order No.	Pcs./Pkt.
TTC-6-FMRS-PT	2907811	1
TTC-6-FMRS-UT	2907810	1
TTC-6-FC-UT	1054762	50

Isolated signal circuits TERMITRAB complete

- Overall width of just 3.5 mm
- With Push-in connection technology

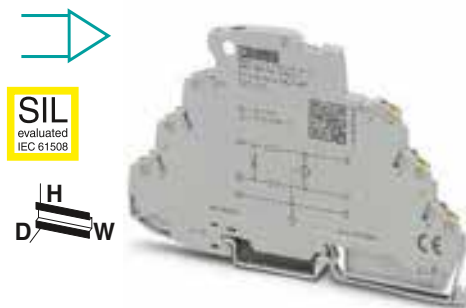

Double wire (loop), floating,
e.g., for 4 ... 20 mA current loops

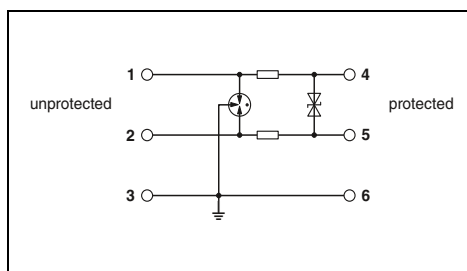

Technical data

Electrical data			
IEC test classification/EN type		C1 / C2 / C3 / D1	
Maximum continuous operating voltage U_C		30 V DC / 21 V AC	
Rated current		250 mA (70°C)	
Pulse discharge current I_{imp} (10/350) μ s		0.5 kA	
Nominal discharge current I_n (8/20) μ s			
	Core-Core	5 kA	
	Core-Ground	5 kA	
Total discharge current I_{total} (8/20) μ s		10 kA	
Protection level U_p			
	Core-Core	≤ 45 V	
	(C3 - 30 A)		
	Core-Ground	≤ 1000 V	
	(C3 - 100 A)		
Cut-off frequency f_g (3 dB)		typ. 2.4 MHz	
	Symmetrical in the 150 Ω system	2.2 Ω	
Resistance per path			
General data			
Dimensions W/H/D		3.5 mm / 106 mm / 69.5 mm	
Connection data rigid / flexible / AWG		0.2 ... 1.5 mm ² / 0.2 ... 1.5 mm ² / 24 ... 16	
Temperature range		-40°C ... 85°C	
Test standards		IEC 61643-21 / EN 61643-21	

Ordering data

Description	Voltage U_N	Type	Order No.	Pcs./Pkt.
TERMITRAB complete, with Push-in connection technology				
	24 V DC	TTC-3-1X2-24DC-PT	2907325	1

Accessories

End cover		TTC-3-LCP	2908843	50
-----------	--	-----------	---------	----

Surge protection and interference filters

Surge protection for measurement and control technology

Isolated signal circuits PLUGTRAB PT-IQ

- Multi-stage status monitoring
- Group message via supply and remote signaling module
- Multi-stage, floating remote signaling
- System supplied via DIN rail bus
- Up to 28 protection modules per supply module
- Maximum ease of maintenance, thanks to the two-piece design
- Plugs are coded
- Impedance-neutral disconnection of plug for maintenance purposes
- PT-IQ... base element with Push-in or screw connection technology
- Base element remains an integral part of the installation
- Corresponding replacement plugs can be found on our website



Supply and remote signaling module



Double wire (loop), floating, connection 9/10 grounded directly, e.g., for 4 ... 20 mA current loop

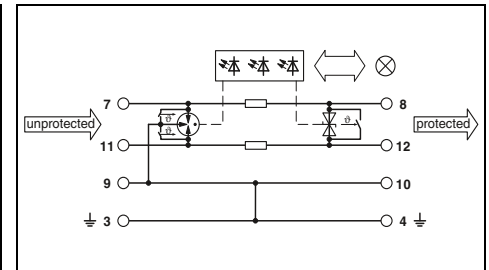
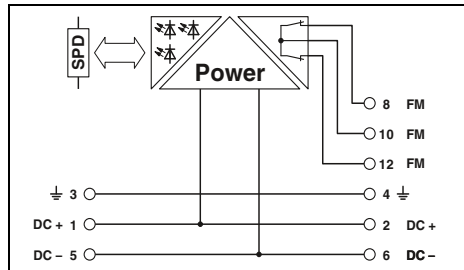

Technical data

Electrical data	
IEC test classification/EN type	
Maximum continuous operating voltage U_c	-
Rated current	-
Pulse discharge current I_{imp} (10/350) μ s	-
Nominal discharge current I_n (8/20) μ s	-
	Core-Core
	Core-Ground
Total discharge current I_{total} (8/20) μ s	-
Protection level U_p	-
	Core-Core
	Core-Ground
Resistance per path	-
General data	
Dimensions W/H/D	
- for Push-in connection technology	17.7 mm / 109.3 mm / 77.5 mm
- for screw connection technology	17.7 mm / 91.1 mm / 77.5 mm
Connection data rigid / flexible / AWG	0.2 ... 4 mm ² / 0.2 ... 2.5 mm ² / 24 ... 12
Temperature range	-40°C ... 70°C
Test standards	EN 61000-6-2 / EN 61000-6-3 / EN 60950-1
Remote indication contact	2x N/C contacts
Connection data rigid / flexible / AWG	0.2 ... 4 mm ² / 0.2 ... 2.5 mm ² / 24 ... 12
Max. operating voltage	30 V AC (50/60 Hz) / 50 V DC
Max. operating current	1 A (up to 50°C)

Technical data

... 24DC	... 48DC
C1 / C2 / C3 / D1	C1 / C2 / C3 / D1
30 V DC / 21 V AC	53 V DC / 37 V AC
1000 mA (40°C)	300 mA
2.5 kA	2.5 kA
10 kA	10 kA
10 kA	10 kA
20 kA	20 kA
≤ 55 V (C3 - 25 A)	≤ 90 V (C3 - 25 A)
≤ 700 V (C3 - 25 A)	≤ 700 V (C3 - 25 A)
1.2 Ω	1.2 Ω
	17.7 mm / 109.3 mm / 77.5 mm
	17.7 mm / 91.1 mm / 77.5 mm
	0.2 ... 4 mm ² / 0.2 ... 2.5 mm ² / 24 ... 12
	-40°C ... 70°C
	IEC 61643-21 / EN 61643-21 / EN 61000-6-2 / EN 61000-6-3
	via DIN rail connector
	- mm ² / - mm ² / -

Ordering data

Description	Voltage U_N	Type	Order No.	Pcs./Pkt.
PLUGTRAB, supply and remote signaling module				
Push-in connection technology		PT-IQ-PTB-PT	2801296	1
Screw connection technology		PT-IQ-PTB-UT	2800768	1
PLUGTRAB, with Push-in connection technology	5 V DC 12 V DC 24 V DC 48 V DC			
PLUGTRAB, with screw connection technology	12 V DC 24 V DC 48 V DC			

Ordering data

Type	Order No.	Pcs./Pkt.
PT-IQ-1X2-24DC-PT	2801255	1
PT-IQ-1X2-48DC-PT	2801257	1
PT-IQ-1X2-24DC-UT	2800976	1
PT-IQ-1X2-48DC-UT	2800978	1



SIL
evaluated
IEC 61508



Double wire (loop), floating, connection 9/10 grounded via gas-filled surge arrester, e.g., for 4 ... 20 mA current loop



SIL
evaluated
IEC 61508



2 double wires (loops), floating, connection 9/10 grounded directly, e.g., for 4 ... 20 mA current loop



SIL
evaluated
IEC 61508



2 double wires (loops), floating, connection 9/10 grounded via gas-filled surge arrester, e.g., for 4 ... 20 mA current loop

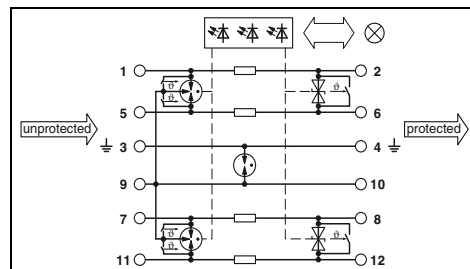
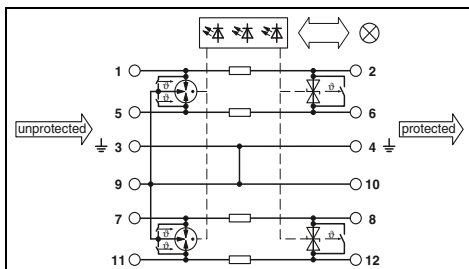
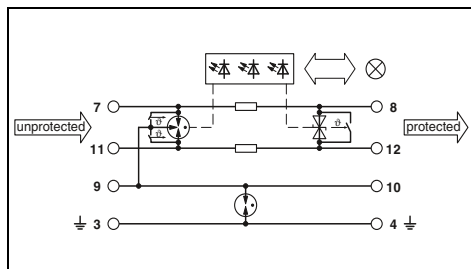

Technical data

... 24DC
C1 / C2 / C3 /
D1
30 V DC /
21 V AC
1000 mA (40°C)
2.5 kA

10 kA
10 kA
20 kA

≤ 55 V
(C3 - 25 A)
≤ 1000 V
(C3 - 25 A)
1.2 Ω

17.7 mm / 109.3 mm / 77.5 mm
17.7 mm / 91.1 mm / 77.5 mm
0.2 ... 4 mm² / 0.2 ... 2.5 mm² / 24 ... 12
-40°C ... 70°C
IEC 61643-21 / EN 61643-21 / EN 61000-6-2 /
EN 61000-6-3
via DIN rail connector
- mm² / - mm² / -

Technical data

... 24DC
C1 / C2 / C3 /
D1
30 V DC /
21 V AC
700 mA (50°C)
2.5 kA

10 kA
10 kA
20 kA

≤ 55 V
(C3 - 25 A)
≤ 700 V
(C3 - 25 A)
1.2 Ω

17.7 mm / 109.3 mm / 77.5 mm
17.7 mm / 91 mm / 77.5 mm
0.2 ... 4 mm² / 0.2 ... 2.5 mm² / 24 ... 12
-40°C ... 70°C
IEC 61643-21 / EN 61643-21 / EN 61000-6-3 /
EN 61000-6-2
via DIN rail connector
- mm² / - mm² / -

... 48DC
C1 / C2 / C3 /
D1
53 V DC /
37 V AC
300 mA
2.5 kA

10 kA
10 kA
20 kA

≤ 90 V
(C3 - 25 A)
≤ 700 V
(C3 - 25 A)
1.2 Ω

Technical data

... 5DC	... 12DC	... 24DC	... 48DC
C1 / C2 / C3 / D1	C1 / C2 / C3 / D1	C1 / C2 / C3 / D1	C1 / C2 / C3 / D1
6 V DC / 4 V AC	15 V DC / 10 V AC	30 V DC / 21 V AC	53 V DC / 37 V AC
700 mA (50°C)	700 mA (50°C)	700 mA (50°C)	300 mA
2.5 kA	2.5 kA	2.5 kA	2.5 kA

10 kA	10 kA	10 kA	10 kA
10 kA	10 kA	10 kA	10 kA
20 kA	20 kA	20 kA	20 kA

≤ 25 V (C3 - 25 A)	≤ 35 V (C3 - 25 A)	≤ 55 V (C3 - 25 A)	≤ 90 V (C3 - 25 A)
≤ 1000 V (C3 - 25 A)	≤ 1000 V (C3 - 25 A)	≤ 1000 V (C3 - 25 A)	≤ 1000 V (C3 - 25 A)
1.2 Ω	1.2 Ω	1.2 Ω	1.2 Ω

17.7 mm / 109.3 mm / 77.5 mm
17.7 mm / 91 mm / 77.5 mm
0.2 ... 4 mm² / 0.2 ... 2.5 mm² / 24 ... 12
-40°C ... 70°C
IEC 61643-21 / EN 61643-21 / EN 61000-6-3 /
EN 61000-6-2
via DIN rail connector
- mm² / - mm² / -

Ordering data

Type	Order No.	Pcs./Pkt.
PT-IQ-1X2+F-24DC-PT	2801256	1
PT-IQ-1X2+F-24DC-UT	2800977	1

Ordering data

Type	Order No.	Pcs./Pkt.
PT-IQ-2X2-24DC-PT	2801263	1
PT-IQ-2X2-24DC-UT	2800980	1
PT-IQ-2X2-48DC-UT	2800986	1

Ordering data

Type	Order No.	Pcs./Pkt.
PT-IQ-2X2+F-5DC-PT	2801260	1
PT-IQ-2X2+F-12DC-PT	2801262	1
PT-IQ-2X2+F-24DC-PT	2801264	1
PT-IQ-2X2+F-48DC-PT	2801266	1
PT-IQ-2X2+F-12DC-UT	2800985	1
PT-IQ-2X2+F-24DC-UT	2800981	1
PT-IQ-2X2+F-48DC-UT	2800987	1

Surge protection and interference filters

Surge protection for measurement and control technology

Isolated signal circuits PLUGTRAB PT

- Consistently pluggable signal circuit protection
- Maximum ease of maintenance, thanks to the two-piece design
- Base element remains an integral part of the installation
- Impedance-neutral disconnection of plug for test and maintenance purposes
- Plugs can be tested with CHECKMASTER 2

Note:

Base elements are grounded differently. For **PT .x.-BE**, connections 9/10 (GND) are connected directly to the mounting foot.

For **PT .x.+F-BE**, connections 9/10 (GND) are connected to the mounting foot via a gas-filled surge arrester.



Double wire (loop), floating, e.g., for 4 ... 20 mA current loops



Double wire (loop), floating, e.g., for 4 ... 20 mA current loops

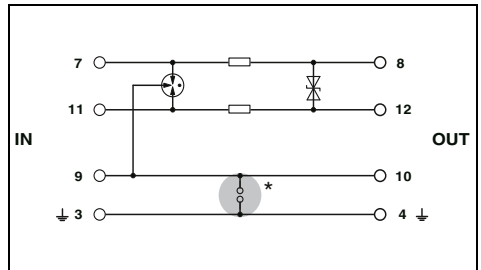
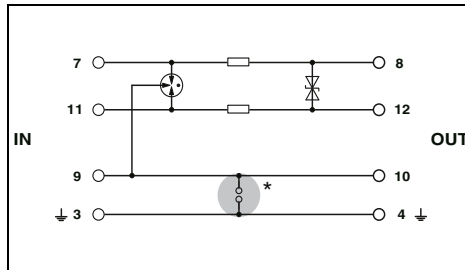

Technical data

Electrical data	... 5DC	... 12DC	... 24DC	... 48DC
IEC test classification/EN type	C1 / C2 / C3 / D1	C1 / C2 / C3 / D1	C1 / C2 / C3 / D1	C1 / C2 / C3 / D1
Maximum continuous operating voltage U_c	6 V DC / 4 V AC	13 V DC / 9 V AC	28 V DC / 20 V AC	53 V DC / 37 V AC
Rated current	450 mA (45°C)	450 mA (45°C)	450 mA (45°C)	450 mA (45°C)
Pulse discharge current I_{imp} (10/350) μ s	2.5 kA	2.5 kA	2.5 kA	2.5 kA
Nominal discharge current I_n (8/20) μ s	10 kA	10 kA	10 kA	10 kA
Total discharge current I_{total} (8/20) μ s	20 kA	20 kA	20 kA	20 kA
Max. discharge current I_{max} (8/20) μ s	10 kA	10 kA	10 kA	20 kA (in total)
Protection level U_p	Core-Core Core-Ground	Core-Core Core-Ground	Core-Core Core-Ground	Core-Core Core-Ground
Output voltage limitation at 1 kV/ μ s	Core-Core Core-Ground	Core-Core Core-Ground	Core-Core Core-Ground	Core-Core Core-Ground
Cut-off frequency f_g (3 dB)	typ. 1 MHz	typ. 3 MHz	typ. 4.5 MHz	typ. 10 MHz
Resistance per path	2.2 Ω	2.2 Ω	2.2 Ω	2.2 Ω

Technical data	... 24AC
IEC test classification/EN type	C1 / C2 / C3 / D1
Maximum continuous operating voltage U_c	40 V DC / 28 V AC
Rated current	450 mA (45°C)
Pulse discharge current I_{imp} (10/350) μ s	2.5 kA
Nominal discharge current I_n (8/20) μ s	10 kA
Total discharge current I_{total} (8/20) μ s	20 kA
Max. discharge current I_{max} (8/20) μ s	10 kA
Protection level U_p	Core-Core Core-Ground
Output voltage limitation at 1 kV/ μ s	Core-Core Core-Ground
Cut-off frequency f_g (3 dB)	typ. 8 MHz
Resistance per path	2.2 Ω

Technical data	... 24AC
Dimensions W/H/D	17.7 mm / 45 mm / 52 mm
Connection data rigid / flexible / AWG	0.2 ... 4 mm ² / 0.2 ... 2.5 mm ² / 24 ... 12
Temperature range	-40°C ... 85°C
Test standards	IEC 61643-21 / EN 61643-21

Ordering data

Description	Voltage U_N
PLUGTRAB plug , with protective circuit for plugging into base element PT	5 V DC 12 V DC 24 V DC 48 V DC 24 V AC
PLUGTRAB base element , for mounting on NS 35	Bridge between 3/4 (\downarrow) and 9/10 Gas-filled surge arrester between 3/4 (\downarrow) and 9/10

Type	Order No.	Pcs./Pkt.
PT 1X2- 5DC-ST	2856016	10
PT 1X2-12DC-ST	2856029	10
PT 1X2-24DC-ST	2856032	10
PT 1X2-48DC-ST	2803658	10
PT 1X2-BE	2856113	10
PT 1X2+F-BE	2856126	10

Ordering data

Type	Order No.	Pcs./Pkt.
PT 1X2-24AC-ST	2856058	10
PT 1X2-BE	2856113	10
PT 1X2+F-BE	2856126	10



SIL
evaluated
IEC 61508



2 double wires (loops), floating,
e.g., for 4 ... 20 mA current loops

ERC
Ex:

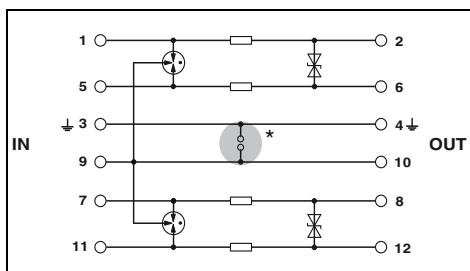

Technical data

... 5DC	... 12DC	... 24DC
C1 / C2 / C3 / D1	C1 / C2 / C3 / D1	C1 / C2 / C3 / D1
6 V DC / 4 V AC	13 V DC / 9 V AC	28 V DC / 20 V AC
450 mA (45°C)	450 mA (45°C)	450 mA (45°C)
2.5 kA	2.5 kA	2.5 kA
10 kA	10 kA	10 kA
10 kA	10 kA	10 kA
20 kA	20 kA	20 kA
10 kA	10 kA	10 kA
-	-	≤ 450 V (C1 - 1 kV / 500 A with PT 2X2-BE)
≤ 10 V	≤ 18 V	≤ 40 V
≤ 450 V	≤ 450 V	≤ 450 V (with PT 2X2-BE)
typ. 1 MHz	typ. 3 MHz	typ. 4.5 MHz
2.2 Ω	2.2 Ω	2.2 Ω

17.5 mm / 44.8 mm / 51.7 mm
0.2 ... 4 mm² / 0.2 ... 2.5 mm² / 24 ... 12
-40°C ... 85°C
IEC 61643-21



SIL
evaluated
IEC 61508



2 double wires (loops), floating,
e.g., for 4 ... 20 mA current loops

ERC
Ex:

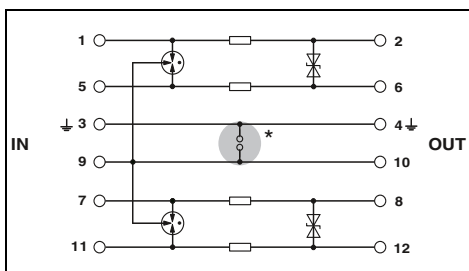

Technical data

... 24AC
C1 / C2 / C3 / D1
40 V DC / 28 V AC
450 mA (45°C)
2.5 kA
10 kA
10 kA
20 kA
20 kA
≤ 80 V (C2 - 10 kV / 5 kA)
≤ 450 V (C2 - 10 kV / 5 kA with PT 2X2-BE)
≤ 55 V
≤ 450 V (with PT 2X2-BE)
typ. 8 MHz
2.2 Ω

17.5 mm / 44.8 mm / 51.7 mm
0.2 ... 4 mm² / 0.2 ... 2.5 mm² / 24 ... 12
-40°C ... 85°C
IEC 61643-21 / EN 61643-21



Checkmate



Combination of double wire protection (floating)
and single-phase power supply

ERC

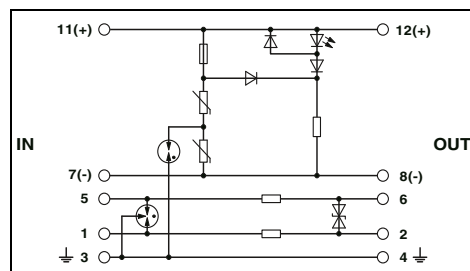

Technical data

Mains protection	Data protection
44 V DC / 34 V AC	C1 / C2 / C3 / D1
6 A (30°C)	40 V DC / 28 V AC
-	450 mA (45°C)
-	2.5 kA
-	20 kA
2 kA	20 kA (in total)
≤ 0.18 kV	≤ 80 V (C2 - 10 kV / 5 kA)
≤ 0.55 kV	≤ 450 V (C2 - 10 kV / 5 kA)
-	≤ 55 V
-	≤ 25 V
-	typ. 8 MHz
-	2.2 Ω

17.5 mm / 44.8 mm / 51.7 mm
0.2 ... 4 mm² / 0.2 ... 2.5 mm² / 24 ... 12
-40°C ... 85°C
IEC 61643-11 / EN 61643-11 / EN 61643-21

Ordering data

Type	Order No.	Pcs./Pkt.
PT 2X2- 5DC-ST	2838241	10
PT 2X2-12DC-ST	2838254	10
PT 2X2-24DC-ST	2838228	10
PT 2X2-BE	2839208	10
PT 2X2+F-BE	2839224	10

Ordering data

Type	Order No.	Pcs./Pkt.
PT 2X2-24AC-ST	2838283	10
PT 2X2-BE	2839208	10
PT 2X2+F-BE	2839224	10

Ordering data

Type	Order No.	Pcs./Pkt.
PT PE/S+1X2-24-ST	2819008	10
PT PE/S+1X2-BE	2856265	10

Surge protection and interference filters

Surge protection for measurement and control technology

Isolated signal circuits LINETRAB LIT

- Protection of up to four signal wires with an overall width of 6.2 mm
- Can be used in binary, analog, and intrinsically safe circuits

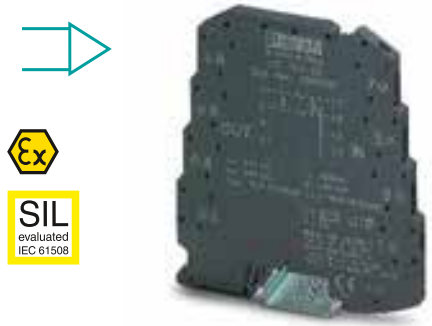

Double wire (loop), floating,
e.g., for 4 ... 20 mA current loops

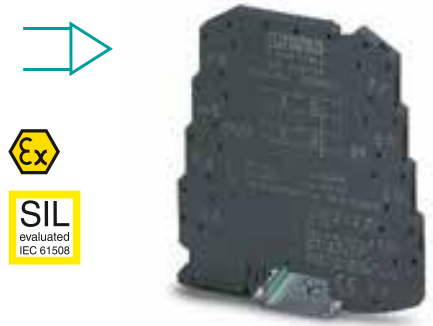

2 double wires (loops), floating,
e.g., for 4 ... 20 mA current loops

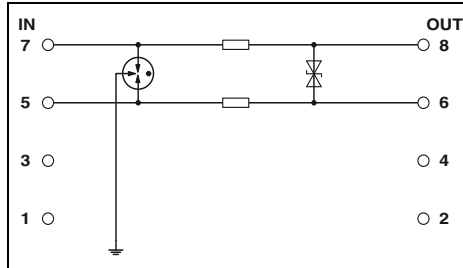

Technical data

Electrical data		C1 / C2 / C3 / D1
IEC test classification/EN type		36 V DC / 25 V AC
Maximum continuous operating voltage U_C		350 mA (40°C)
Rated current		500 A
Pulse discharge current I_{imp} (10/350) μ s		5 kA
Nominal discharge current I_n (8/20) μ s		5 kA
		10 kA
Total discharge current I_{total} (8/20) μ s		≤ 50 V
Protection level U_p		(C3 - 10 A)
		≤ 650 V
		(C1 - 500 V / 250 A)
Cut-off frequency f_g (3 dB)		typ. 6 MHz
Resistance per path		3.3 Ω
Symmetrical in the 50 Ω system		

General data		6.2 mm / 93.1 mm / 102.5 mm
Dimensions W/H/D		0.2 ... 2.5 mm ² / 0.2 ... 2.5 mm ² / 24 ... 14
Connection data rigid / flexible / AWG		-40°C ... 80°C
Temperature range		EN 61643-21 / EN 60079-0 / EN 60079-11 / EN 60079-26 / IEC 60079-0 / IEC 60079-11
Test standards		

Safety data		KEMA 09ATEX0051 X
EC-type examination certificate in accordance with ATEX		typ. 1.3 nF
Maximum inner capacity C_i		< 1 μ H
Maximum inner inductance L_i		350 mA (T4 / ≤ 80°C)
Maximum input current I_i		36 V DC
Maximum input voltage U_i		3 W
Maximum input power P_i		

Ordering data

Description	Voltage U_N	Type	Order No.	Pcs./Pkt.
LINETRAB	24 V DC	LIT 1X2-24	2804610	10

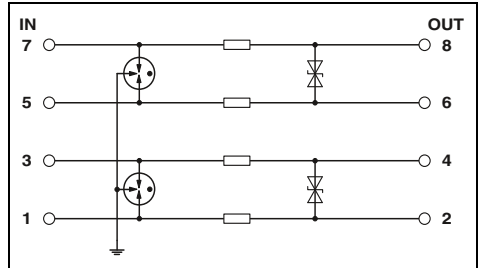

Technical data

Electrical data		C1 / C2 / C3 / D1
IEC test classification/EN type		36 V DC / 25 V AC
Maximum continuous operating voltage U_C		350 mA (40°C)
Rated current		500 A
Pulse discharge current I_{imp} (10/350) μ s		5 kA
Nominal discharge current I_n (8/20) μ s		5 kA
		20 kA
Total discharge current I_{total} (8/20) μ s		≤ 50 V
Protection level U_p		(C3 - 10 A)
		≤ 650 V
		(C1 - 500 V / 250 A)
Cut-off frequency f_g (3 dB)		typ. 6 MHz
Resistance per path		3.3 Ω

General data		6.2 mm / 93.1 mm / 102.5 mm
Dimensions W/H/D		0.2 ... 2.5 mm ² / 0.2 ... 2.5 mm ² / 24 ... 14
Connection data rigid / flexible / AWG		-40°C ... 80°C
Temperature range		EN 61643-21 / EN 60079-0 / EN 60079-11 / EN 60079-26 / IEC 60079-0 / IEC 60079-11
Test standards		

Safety data		KEMA 09ATEX0051 X
EC-type examination certificate in accordance with ATEX		typ. 1.3 nF
Maximum inner capacity C_i		< 1 μ H
Maximum inner inductance L_i		350 mA (T4 / ≤ 80°C)
Maximum input current I_i		36 V DC
Maximum input voltage U_i		3 W
Maximum input power P_i		

Ordering data

Description	Voltage U_N	Type	Order No.	Pcs./Pkt.
LINETRAB	24 V DC	LIT 2X2-24	2804623	10

Isolated signal circuits
SURGETRAB S-PT

- Easy assembly, directly on the field device
- Arresters in hexagonal tube with various outer threads
- **S-PT-1x2...** installation in the signal path feed-through



Double wire (loop), floating, e.g., for 4 ... 20 mA current loops

Notes:
For more information about Ex approvals, visit phoenixcontact.com
For additional safety data, visit phoenixcontact.net/products

ERC

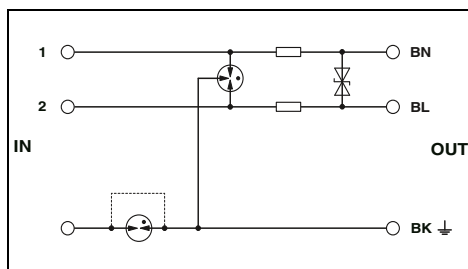

Technical data

Electrical data	
Maximum continuous operating voltage U_c	40 V DC / 28 V AC
Rated current	450 mA (55°C)
Pulse discharge current I_{imp} (10/350) μ s	1 kA
Nominal discharge current I_n (8/20) μ s	
	Core-Core 10 kA
	Core-Ground 10 kA (per path)
Maximum permitted short-circuit current at installation location	1 A
Total discharge current I_{total} (8/20) μ s	20 kA
Max. discharge current I_{max} (8/20) μ s	10 kA (per path)
Protection level U_p	
	Core-Core ≤ 80 V
	(C2 - 10 kV / 5 kA)
	Core-Ground ≤ 450 V
	(C2 - 10 kV / 5 kA)
Output voltage limitation at 1 kV/ μ s	
	Core-Core ≤ 55 V
	Core-Ground ≤ 450 V (Direct grounding)
Resistance per path	2.2 Ω
General data	
Dimensions W/H/D	33.5 mm / 33.5 mm / 137 mm
Temperature range	-40°C ... 85°C
Test standards	IEC 61643-21

Ordering data

Description	Voltage U_N	Type	Order No.	Pcs./Pkt.
SURGETRAB , protective adapter for installation on measuring sensors				
Outer thread: M20 x 1.5	24 V DC	S-PT-1X2-24DC	2880668	1
Outer thread: 1/2" 14 NPT	24 V DC	S-PT-1X2-24DC-1/2"	2882569	1
Outer thread: 3/4" 14 NPT	24 V DC	S-PT-1X2-24DC-3/4"	2882598	1

Surge protection and interference filters

Surge protection for measurement and control technology

Isolated signal circuits COMTRAB CTM

- Space-saving LSA-PLUS connection technology
- Can be used in LSA-PLUS disconnect and control strips or CT-TERMIBLOCK
- The CTM 10-MAG surge protection magazine can be fitted with ten different protective plugs



Double wire (loop), floating

ERC

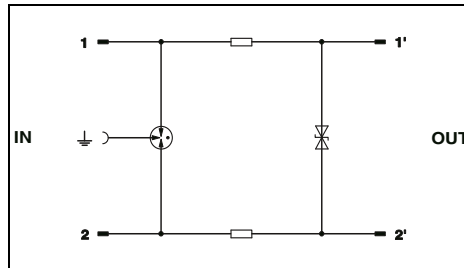

Technical data

Electrical data	... 12DC	... 24DC	... 60DC
IEC test classification/EN type	B2 / C1 / C2 / C3 / D1	B2 / C1 / C2 / C3 / D1	B2 / C1 / C2 / C3 / D1
Maximum continuous operating voltage U_c	± 15 V DC / 10 V AC	± 30 V DC / 21 V AC	60 V DC / 50 V AC
Rated current	380 mA AC (25°C)	380 mA AC (25°C)	380 mA AC (25°C)
Pulse discharge current I_{imp} (10/350) μ s	1 kA	1 kA	1 kA
Nominal discharge current I_n (8/20) μ s	5 kA	5 kA	5 kA
Total discharge current I_{total} (8/20) μ s	10 kA	10 kA	10 kA
Protection level U_p	Core-Core ≤ 25 V (C3 - 7.5 kV/100 A)	Core-Core ≤ 45 V (C3 - 7.5 kV/100 A)	Core-Core ≤ 160 V (C3 - 100 A)
	Core-Ground ≤ 700 V (C3 - 7.5 kV/100 A)	Core-Ground ≤ 700 V (C3 - 7.5 kV/100 A)	Core-Ground ≤ 700 V (C3 - 100 A)
Cut-off frequency f_g (3 dB)	3.3 Ω	3.3 Ω	3.3 Ω
Resistance per path			
General data	9.5 mm / 21 mm / 53.5 mm		
Dimensions W/H/D	-25°C ... 75°C		
Temperature range	IEC 61643-21		
Test standards			

Ordering data

Description	Voltage U_N	Type	Order No.	Pcs./Pkt.
COMTRAB modular	12 V DC	CTM 1X2- 12DC	2838597	10
	24 V DC	CTM 1X2- 24DC	2838513	10
	60 V DC	CTM 1X2- 60DC	2838568	10

Accessories

Magazine , with grounding rail for accommodating up to 10 LSA-PLUS protective plugs (CTM...), for insertion in CT-TERMIBLOCK or LSA-PLUS disconnect strip	CTM 10-MAG	2838610	5
Grounding plug	CTM EST	2838649	10
Screw terminal block , with disconnect contacts for accommodating the CT and CTM protective plugs, design: 10 double wires	CT-TERMIBLOCK 10 DA	0441711	10

Accessories

TERMITRAB complete

Remote signaling set

- Overall width of just 2 x 6.2 mm
- With Push-in or screw connection technology
- Floating remote indication contact
- Visual status indicator on the module
- Monitors up to 40 neighboring SPDs
- No SPD wiring necessary
- No programming necessary

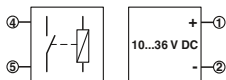

Transceiver module for remote signaling of TTC-6...-I products

General data		Technical data		
Dimensions W/H/D		6.2 mm / 105.8 mm / 83.5 mm		
Temperature range		-40°C ... 60°C		
Test standards		EN 61000-6-2 / EN 61000-6-3		
Remote indication contact		N/C contact		
Connection data rigid / flexible / AWG		0.2 ... 4 mm ² / 0.2 ... 2.5 mm ² / 24 ... 12		
Max. operating voltage		24 V AC / 36 V DC		
Max. operating current		500 mA AC (peak) / 500 mA DC		
Description		Ordering data		
Remote signaling set	Push-in connection technology	Type	Order No.	Pcs./Pkt.
	Screw connection technology	TTC-6-FMRS-PT	2907811	1
		TTC-6-FMRS-UT	2907810	1

Accessories

TERMITRAB complete

Fuse carrier

- For standard 5 x 20 mm miniature fuses
- Can be combined with TTC screw versions
- Can also be used with pluggable TTC products including knife disconnection
- Maximum space savings



Fuse carrier

Electrical data		Technical data		
Max. operating voltage		60 V DC		
Max. operating current		6.3 A (P _v = 1.6 W)		
General data		Dimensions W/H/D		
		6.2 mm / 37 mm / 39 mm		
		Connection data rigid / flexible / AWG		
		0.2 ... 4 mm ² / 0.2 ... 2.5 mm ² / 24 ... 12		
		Temperature range		
		-40°C ... 85°C		
		Test standards		
		EN 60947-7-3		
Description		Ordering data		
Fuse carrier		Type	Order No.	Pcs./Pkt.
		TTC-6-FC-UT	1054762	50

Surge protection and interference filters

Surge protection for measurement and control technology

Signals with common reference potential

TERMITRAB complete

- Pluggable surge protection
- Overall width of just 6.2 mm
- With Push-in or screw connection technology
- Integrated mechanical status indicator
- Impedance-neutral insertion and removal
- Coded plug versions
- With knife disconnection as an option
- Optional remote signaling module monitors up to 40 items, without additional wiring
- Plugs can be tested with CHECKMASTER 2



2-conductor with common reference potential, 3/6 connection grounded directly, e.g., for binary signals



2-conductor with common reference potential, 3/6 connection grounded directly, with knife disconnection, e.g., for binary signals

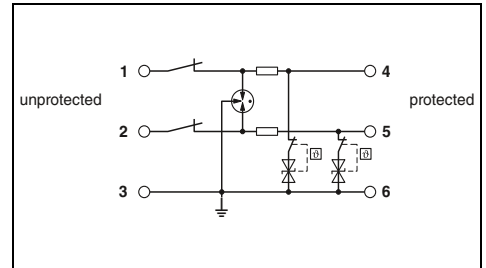
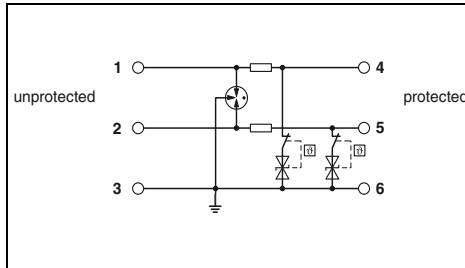

Technical data

Electrical data	... 12DC	... 24DC	... 48DC
IEC test classification/EN type	C1 / C2 / C3 / D1	C1 / C2 / C3 / D1	C1 / C2 / C3 / D1
Maximum continuous operating voltage U_c	15 V DC / 10 V AC	30 V DC / 21 V AC	53 V DC / 37 V AC
Rated current	600 mA (56°C)	600 mA (56°C)	220 mA (75°C)
Pulse discharge current I_{imp} (10/350) μ s	0.5 kA	0.5 kA	0.5 kA
Nominal discharge current I_n (8/20) μ s			
	Core-Core	-	-
	Core-Ground	5 kA	5 kA
Total discharge current I_{total} (8/20) μ s	10 kA	10 kA	10 kA
Protection level U_p			
	Core-Ground	≤ 25 V (C3 - 25 A)	≤ 45 V (C3 - 25 A)
Cut-off frequency f_g (3 dB)			
	Asymmetrical in the 150 Ω system	typ. 440 kHz	typ. 960 kHz
Resistance per path		1.65 Ω	1.65 Ω
General data			
Dimensions W/H/D		6.2 mm / 105.8 mm / 100 mm	
Connection data rigid / flexible / AWG		0.2 ... 4 mm ² / 0.2 ... 2.5 mm ² / 24 ... 12	
Temperature range		-40°C ... 85°C	
Test standards		IEC 61643-21 / EN 61643-21	

Technical data

Electrical data	... 24DC
IEC test classification/EN type	C1 / C2 / C3 / D1
Maximum continuous operating voltage U_c	30 V DC / 21 V AC
Rated current	600 mA (56°C)
Pulse discharge current I_{imp} (10/350) μ s	0.5 kA
Nominal discharge current I_n (8/20) μ s	
	Core-Core
	Core-Ground
Total discharge current I_{total} (8/20) μ s	5 kA
Protection level U_p	
	Core-Ground
Cut-off frequency f_g (3 dB)	
	Asymmetrical in the 150 Ω system
Resistance per path	typ. 960 kHz
General data	
Dimensions W/H/D	6.2 mm / 105.8 mm / 100 mm
Connection data rigid / flexible / AWG	0.2 ... 4 mm ² / 0.2 ... 2.5 mm ² / 24 ... 12
Temperature range	-40°C ... 85°C
Test standards	IEC 61643-21 / EN 61643-21

Ordering data

Description	Voltage U_N	Type	Order No.	Pcs./Pkt.
TERMITRAB complete , with Push-in connection technology	12 V DC	TTC-6P-2X1-12DC-PT-I	2908202	1
	24 V DC	TTC-6P-2X1-24DC-PT-I	2906816	1
	48 V DC	TTC-6P-2X1-48DC-PT-I	2908204	1
TERMITRAB complete , with screw connection technology	12 V DC	TTC-6P-2X1-12DC-UT-I	2908201	1
	24 V DC	TTC-6P-2X1-24DC-UT-I	2906810	1
	48 V DC	TTC-6P-2X1-48DC-UT-I	2908203	1

Ordering data

Description	Voltage U_N	Type	Order No.	Pcs./Pkt.
TERMITRAB complete , with Push-in connection technology	24 V DC	TTC-6P-2X1-M-24DC-PT-I	2906753	1
	48 V DC	TTC-6P-2X1-M-24DC-UT-I	2906741	1

Accessories

Replacement plug	Voltage U_N	Type	Order No.	Pcs./Pkt.
Replacement plug	12 V DC	TTC-6P-2X1-12DC-I-P	2907842	1
	24 V DC	TTC-6P-2X1-24DC-I-P	2907843	1
	48 V DC	TTC-6P-2X1-48DC-I-P	2907844	1
Remote signaling set	Push-in connection technology	TTC-6-FMRS-PT	2907811	1
	Screw connection technology	TTC-6-FMRS-UT	2907810	1
Fuse carrier		TTC-6-FC-UT	1054762	50

Accessories

Replacement plug	Voltage U_N	Type	Order No.	Pcs./Pkt.
Replacement plug	24 V DC	TTC-6P-2X1-24DC-I-P	2907843	1
Remote signaling set	Push-in connection technology	TTC-6-FMRS-PT	2907811	1
	Screw connection technology	TTC-6-FMRS-UT	2907810	1
Fuse carrier		TTC-6-FC-UT	1054762	50



SIL
evaluated
IEC 61508



SIL
evaluated
IEC 61508



2-conductor with common reference potential,
3/6 connection grounded via gas-filled
surge arrester, e.g., for binary signals

2-conductor with common reference potential,
3/6 connection grounded via gas-filled surge arrester,
with knife disconnection, e.g., for binary signals

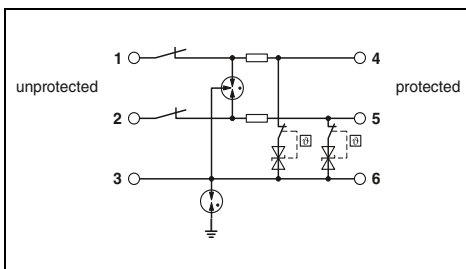
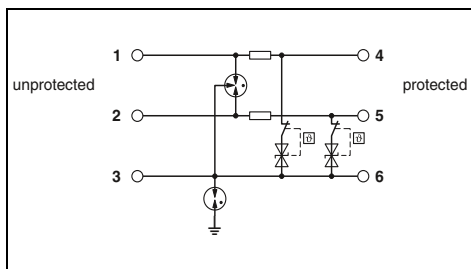

Technical data

... 12DC	... 24DC	... 48DC
C1 / C2 / C3 / D1	C1 / C2 / C3 / D1	C1 / C2 / C3 / D1
15 V DC / 10 V AC	30 V DC / 21 V AC	53 V DC / 37 V AC
600 mA (56°C)	600 mA (56°C)	220 mA (75°C)
0.5 kA	0.5 kA	0.5 kA

-	-	-
5 kA	5 kA	5 kA
10 kA	10 kA	10 kA
≤ 1.2 kV (C3 - 25 A)	≤ 1.3 kV (C3 - 25 A)	≤ 800 V (C3 - 25 A)

-	-	-
1.65 Ω	1.65 Ω	1.65 Ω

6.2 mm / 105.8 mm / 100 mm
0.2 ... 4 mm² / 0.2 ... 2.5 mm² / 24 ... 12
-40°C ... 85°C
IEC 61643-21 / EN 61643-21

Technical data

... 24DC
C1 / C2 / C3 / D1
30 V DC / 21 V AC
600 mA (56°C)
0.5 kA

-
5 kA
10 kA

≤ 1.1 kV (C3 - 25 A)

-
1.65 Ω

6.2 mm / 105.8 mm / 100 mm
0.2 ... 4 mm² / 0.2 ... 2.5 mm² / 24 ... 12
-40°C ... 85°C
IEC 61643-21 / EN 61643-21

Ordering data

Type	Order No.	Pcs./Pkt.
TTC-6P-2X1-F-12DC-PT-I	2908206	1
TTC-6P-2X1-F-24DC-PT-I	1065320	1
TTC-6P-2X1-F-48DC-PT-I	2908209	1
TTC-6P-2X1-F-12DC-UT-I	2908205	1
TTC-6P-2X1-F-24DC-UT-I	1065319	1
TTC-6P-2X1-F-48DC-UT-I	2908208	1

Accessories

TTC-6P-2X1-12DC-I-P	2907842	1
TTC-6P-2X1-24DC-I-P	2907843	1
TTC-6P-2X1-48DC-I-P	2907844	1
TTC-6-FMRS-PT	2907811	1
TTC-6-FMRS-UT	2907810	1
TTC-6-FC-UT	1054762	50

Ordering data

Type	Order No.	Pcs./Pkt.
TTC-6P-2X1-F-M-24DC-PT-I	2906794	1
TTC-6P-2X1-F-M-24DC-UT-I	2906784	1

Accessories

TTC-6P-2X1-24DC-I-P	2907843	1
TTC-6-FMRS-PT	2907811	1
TTC-6-FMRS-UT	2907810	1
TTC-6-FC-UT	1054762	50

Surge protection and interference filters

Surge protection for measurement and control technology

Signals with common reference potential

TERMITRAB complete

- Overall width of just 6.2 mm
- With Push-in or screw connection technology
- With integrated mechanical status indicator and knife disconnection as an option
- Optional remote signaling module monitors up to 40 items, without additional wiring



2-conductor with common reference potential, 3/6 connection grounded via gas-filled surge arrester, with or without status indicator and knife disconnection, e.g., for binary signals



2-conductor with common reference potential, 3/6 connection grounded via gas-filled surge arrester, with knife disconnection, e.g., for binary signals

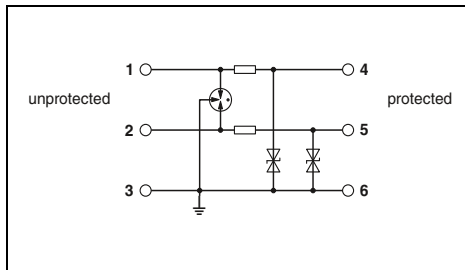

Technical data

Electrical data	... 24DC
IEC test classification/EN type	C1 / C2 / C3 / D1
Maximum continuous operating voltage U_C	30 V DC / 21 V AC
Rated current	600 mA (40°C)
Pulse discharge current I_{imp} (10/350) μ s	0.5 kA
Nominal discharge current I_n (8/20) μ s	
	Core-Core -
	Core-Ground 5 kA
Total discharge current I_{total} (8/20) μ s	10 kA
Protection level U_p	
	Core-Core -
	Core-Ground ≤ 45 V (C3 - 25 A)
Cut-off frequency f_g (3 dB)	
	Asymmetrical in the 150 Ω system
Resistance per path	typ. 960 kHz
General data	1.65 Ω
Dimensions W/H/D	6.2 mm / 105.8 mm / 69.5 mm
Connection data rigid / flexible / AWG	0.2 ... 4 mm ² / 0.2 ... 2.5 mm ² / 24 ... 12
Temperature range	-40°C ... 85°C
Test standards	IEC 61643-21 / EN 61643-21

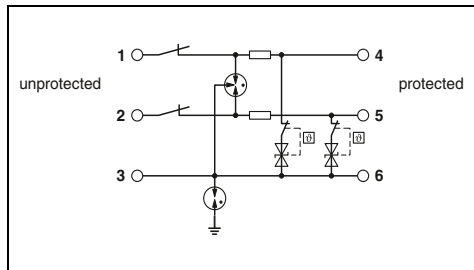

Technical data

Electrical data	... 24DC
IEC test classification/EN type	C1 / C2 / C3 / D1
Maximum continuous operating voltage U_C	30 V DC / 21 V AC
Rated current	600 mA (40°C)
Pulse discharge current I_{imp} (10/350) μ s	0.5 kA
Nominal discharge current I_n (8/20) μ s	
	Core-Core -
	Core-Ground 5 kA
Total discharge current I_{total} (8/20) μ s	10 kA
Protection level U_p	
	Core-Core -
	Core-Ground ≤ 1.1 kV (C3 - 25 A)
Cut-off frequency f_g (3 dB)	
	-
Resistance per path	1.65 Ω
General data	
Dimensions W/H/D	6.2 mm / 105.8 mm / 83.5 mm
Connection data rigid / flexible / AWG	0.2 ... 4 mm ² / 0.2 ... 2.5 mm ² / 24 ... 12
Temperature range	-40°C ... 85°C
Test standards	IEC 61643-21 / EN 61643-21

Ordering data

Description	Voltage U_N
TERMITRAB complete , with Push-in connection technology	
Without status indicator	24 V DC
With status indicator	24 V DC
TERMITRAB complete , with screw connection technology	
Without status indicator	24 V DC
With status indicator	24 V DC

Type	Order No.	Pcs./Pkt.
TTC-6-2X1-24DC-PT	2906805	1
TTC-6-2X1-M-24DC-PT-I	2906729	1
TTC-6-2X1-24DC-UT	2906799	1
TTC-6-2X1-M-24DC-UT-I	2906716	1

Ordering data

Type	Order No.	Pcs./Pkt.
TTC-6-2X1-F-M-24DC-PT-I	2906776	1
TTC-6-2X1-F-M-24DC-UT-I	2906767	1

Accessories

Remote signaling set	
Push-in connection technology	
Screw connection technology	
Fuse carrier	

TTC-6-FMRS-PT	2907811	1
TTC-6-FMRS-UT	2907810	1
TTC-6-FC-UT	1054762	50

Accessories

TTC-6-FMRS-PT	2907811	1
TTC-6-FMRS-UT	2907810	1
TTC-6-FC-UT	1054762	50

Signals with common reference potential

TERMITRAB complete

- Overall width of just 3.5 mm
- With Push-in connection technology



2-conductor with common reference potential, e.g., for binary signals

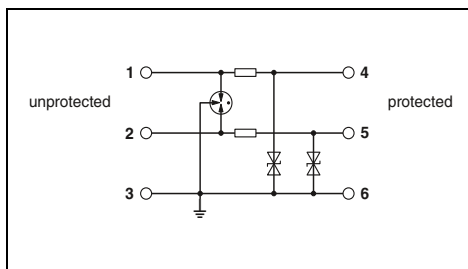

Technical data

Electrical data	... 24DC
IEC test classification/EN type	C1 / C2 / C3 / D1
Maximum continuous operating voltage U_C	30 V DC / 21 V AC
Rated current	250 mA (70°C)
Pulse discharge current I_{imp} (10/350) μ s	0.5 kA
Nominal discharge current I_n (8/20) μ s	
	Core-Core -
	Core-Ground 5 kA
Total discharge current I_{total} (8/20) μ s	10 kA
Protection level U_p	
	Core-Core -
	Core-Ground ≤ 50 V (C3 - 30 A)
Cut-off frequency f_g (3 dB)	-
	Asymmetrical in the 150 Ω system
Resistance per path	2.2 Ω
General data	
Dimensions W/H/D	3.5 mm / 106 mm / 69.5 mm
Connection data rigid / flexible / AWG	0.2 ... 1.5 mm ² / 0.2 ... 1.5 mm ² / 24 ... 16
Temperature range	-40°C ... 85°C
Test standards	IEC 61643-21 / EN 61643-21

Ordering data

Description	Voltage U_N	Type	Order No.	Pcs./Pkt.
TERMITRAB complete, with Push-in connection technology	24 V DC	TTC-3-2X1-24DC-PT	2907326	1

Accessories

End cover	TTC-3-LCP	2908843	50
-----------	-----------	---------	----

Surge protection and interference filters

Surge protection for measurement and control technology

Signals with common reference potential

PLUGTRAB PT-IQ

- Multi-stage status monitoring
- Group message via supply and remote signaling module
- Multi-stage, floating remote signaling
- System supplied via DIN rail bus
- Up to 28 protection modules per supply module
- Maximum ease of maintenance, thanks to the two-piece design
- Plugs are coded
- Impedance-neutral disconnection of plug for maintenance purposes
- PT-IQ... base element with Push-in or screw connection technology
- Base element remains an integral part of the installation
- Corresponding replacement plugs can be found on our website



Supply and remote signaling module



2-conductor with common reference potential, connection 9/10 grounded directly, e.g., for binary signals

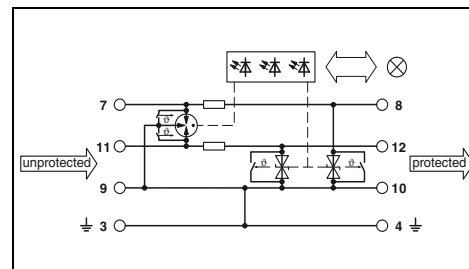
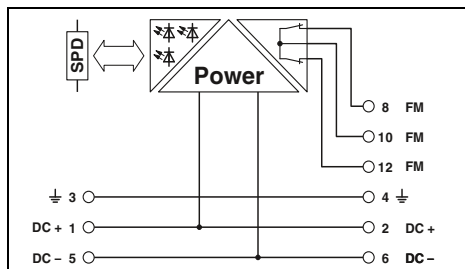

Technical data

Electrical data	
IEC test classification/EN type	
Maximum continuous operating voltage U_C	-
Rated current	-
Pulse discharge current I_{imp} (10/350) μ s	-
Nominal discharge current I_n (8/20) μ s	-
	Core-Core
	Core-Ground
Total discharge current I_{total} (8/20) μ s	-
Protection level U_p	-
	Core-Ground
Resistance per path	-
General data	
Dimensions W/H/D	17.7 mm / 109.3 mm / 77.5 mm
Dimensions W/H/D	
- for Push-in connection technology	17.7 mm / 109.3 mm / 77.5 mm
- for screw connection technology	17.7 mm / 91.1 mm / 77.5 mm
Connection data rigid / flexible / AWG	0.2 ... 4 mm ² / 0.2 ... 2.5 mm ² / 24 ... 12
Temperature range	-40°C ... 70°C
Test standards	EN 61000-6-2 / EN 61000-6-3 / EN 60950-1
Remote indication contact	2x N/C contacts
Connection data rigid / flexible / AWG	0.2 ... 4 mm ² / 0.2 ... 2.5 mm ² / 24 ... 12
Max. operating voltage	30 V AC (50/60 Hz) / 50 V DC
Max. operating current	1 A (up to 50°C)

Technical data

... 24DC
C1 / C2 / C3 / D1
30 V DC / 21 V AC
1000 mA (40°C)
2.5 kA
-
10 kA
20 kA
≤ 55 V
(C3 - 25 A)
1.2 Ω
17.7 mm / 109.3 mm / 77.5 mm
17.7 mm / 109.3 mm / 77.5 mm
17.7 mm / 91.1 mm / 77.5 mm
0.2 ... 4 mm ² / 0.2 ... 2.5 mm ² / 24 ... 12
-40°C ... 70°C
IEC 61643-21 / EN 61643-21 / EN 61000-6-3 / EN 61000-6-2
via DIN rail connector
- mm ² / - mm ² / -
-

Ordering data

Description	Voltage U_N	Type	Order No.	Pcs./Pkt.
PLUGTRAB , supply and remote signaling module				
Push-in connection technology		PT-IQ-PTB-PT	2801296	1
Screw connection technology		PT-IQ-PTB-UT	2800768	1
PLUGTRAB , with Push-in connection technology	24 V DC 48 V DC			
PLUGTRAB , with screw connection technology	24 V DC 48 V DC			

Ordering data

Type	Order No.	Pcs./Pkt.
PT-IQ-2X1-24DC-PT	2801247	1
PT-IQ-2X1-24DC-UT	2800787	1



SIL
evaluated
IEC 61508



SIL
evaluated
IEC 61508



SIL
evaluated
IEC 61508



2-conductor with common reference potential, connection 9/10 grounded via gas-filled surge arrester, e.g., for binary signals

4-conductor with common reference potential, connection 9/10 grounded directly, e.g., for binary signals

4-conductor with common reference potential, connection 9/10 grounded via gas-filled surge arrester, e.g., for binary signals

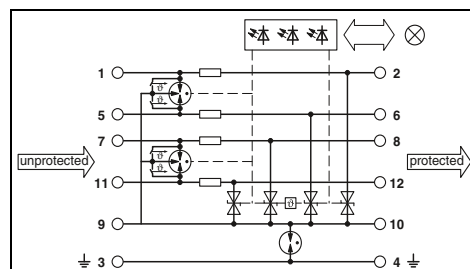
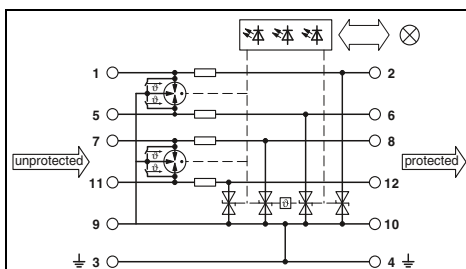
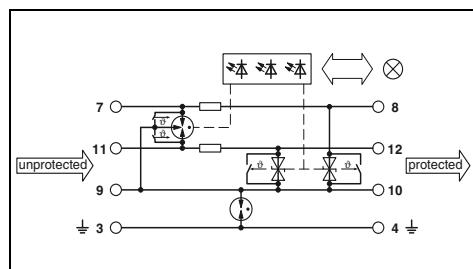

Technical data

... 24DC	... 48DC
C1 / C2 / C3 / D1	C1 / C2 / C3 / D1
30 V DC / 21 V AC	53 V DC / 37 V AC
1000 mA (40°C)	300 mA
2.5 kA	300 mA
-	2.5 kA
10 kA	10 kA
20 kA	20 kA
≤ 780 V (C3 - 25 A)	≤ 850 V (C3 - 25 A)
1.2 Ω	1.2 Ω

17.7 mm / 109.3 mm / 77.5 mm

17.7 mm / 109.3 mm / 77.5 mm

17.7 mm / 91.1 mm / 77.5 mm

0.2 ... 4 mm² / 0.2 ... 2.5 mm² / 24 ... 12

-40°C ... 70°C

IEC 61643-21 / EN 61643-21 / EN 61000-6-3 / EN 61000-6-2

via DIN rail connector

- mm² / - mm² / -

Technical data

... 24DC	... 48DC
C1 / C2 / C3 / D1	C1 / C2 / C3 / D1
30 V DC / 21 V AC	53 V DC / 37 V AC
700 mA (50°C)	300 mA
2.5 kA	300 mA
-	2.5 kA
10 kA	10 kA
20 kA	20 kA
≤ 55 V (C3 - 25 A)	≤ 90 V (C3 - 25 A)
1.2 Ω	1.2 Ω

17.7 mm / 109.3 mm / 77.5 mm

17.7 mm / 109.3 mm / 77.5 mm

17.7 mm / 91.1 mm / 77.5 mm

0.5 ... 4 mm² / 0.2 ... 2.5 mm² / 24 ... 12

-40°C ... 70°C

IEC 61643-21 / EN 61643-21 / EN 61000-6-3 / EN 61000-6-2

via DIN rail connector

- mm² / - mm² / -

Technical data

... 24DC	... 48DC
C1 / C2 / C3 / D1	C1 / C2 / C3 / D1
30 V DC / 21 V AC	53 V DC / 37 V AC
700 mA (50°C)	300 mA
2.5 kA	300 mA
-	2.5 kA
10 kA	10 kA
20 kA	20 kA
≤ 780 V (C3 - 25 A)	≤ 850 V (C3 - 25 A)
1.2 Ω	1.2 Ω

17.7 mm / 109.3 mm / 77.5 mm

17.7 mm / 109.3 mm / 77.5 mm

17.7 mm / 91.1 mm / 77.5 mm

0.5 ... 4 mm² / 0.2 ... 2.5 mm² / 24 ... 12

-40°C ... 70°C

IEC 61643-21 / EN 61643-21 / EN 61000-6-3 / EN 61000-6-2

via DIN rail connector

- mm² / - mm² / -

Ordering data

Type	Order No.	Pcs./Pkt.
PT-IQ-2X1+F-24DC-PT	2801248	1
PT-IQ-2X1+F-48DC-PT	2801250	1
PT-IQ-2X1+F-24DC-UT	2800788	1
PT-IQ-2X1+F-48DC-UT	2800790	1

Ordering data

Type	Order No.	Pcs./Pkt.
PT-IQ-4X1-24DC-PT	2801271	1
PT-IQ-4X1-24DC-UT	2800982	1
PT-IQ-4X1-48DC-UT	2801219	1

Ordering data

Type	Order No.	Pcs./Pkt.
PT-IQ-4X1+F-24DC-PT	2801272	1
PT-IQ-4X1+F-48DC-PT	2801274	1
PT-IQ-4X1+F-24DC-UT	2800983	1
PT-IQ-4X1+F-48DC-UT	2801220	1

Surge protection and interference filters

Surge protection for measurement and control technology

Signals with common reference potential PLUGTRAB PT

- Consistently pluggable signal circuit protection
- Maximum ease of maintenance, thanks to the two-piece design
- Base element remains an integral part of the installation
- Impedance-neutral disconnection of plug for test and maintenance purposes
- Plugs can be tested with CHECKMASTER 2

Note:

Base elements are grounded differently. For **PT .x.-BE**, connections 9/10 (GND) are connected directly to the mounting foot.

For **PT .x.+F-BE**, connections 9/10 (GND) are connected to the mounting foot via a gas-filled surge arrester.

Notes:

For approvals and dimensional drawing, visit phoenixcontact.net/products



2-conductor, with common reference potential, e.g., for binary signals

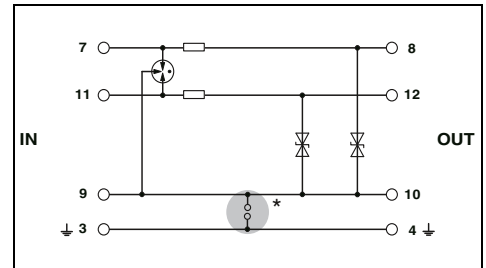

Technical data

Electrical data	... 5DC	... 12DC	... 24DC
	IEC test classification/EN type	C1 / C2 / C3 / D1	C1 / C2 / C3 / D1
Maximum continuous operating voltage U_c	6 V DC / 4 V AC	13 V DC / 9 V AC	28 V DC / 20 V AC
Rated current	300 mA (45°C)	300 mA (45°C)	300 mA (45°C)
Pulse discharge current I_{imp} (10/350) μ s	2.5 kA	2.5 kA	2.5 kA
Nominal discharge current I_n (8/20) μ s			
	Core-Core	-	-
	Core-Ground	10 kA	10 kA
Total discharge current I_{total} (8/20) μ s	20 kA	20 kA	20 kA
Max. discharge current I_{max} (8/20) μ s	10 kA	10 kA	10 kA
Output voltage limitation at 1 kV/ μ s			
	Core-Ground	≤ 10 V	≤ 18 V
Core-Ground	≤ 10 V	≤ 18 V	≤ 40 V
Cut-off frequency f_g (3 dB)			
	Symmetrical/asymmetrical in the 50 Ω system	- / typ. 1 MHz	- / typ. 3 MHz
Resistance per path		4.7 Ω	4.7 Ω
General data			
Dimensions W/H/D			17.5 mm / 44.8 mm / 51.7 mm
Connection data rigid / flexible / AWG			0.2 ... 4 mm ² / 0.2 ... 2.5 mm ² / 24 ... 12
Temperature range			-40°C ... 85°C
Test standards			IEC 61643-21

Ordering data

Description	Voltage U_N	Type	Order No.	Pcs./Pkt.
PLUGTRAB plug , with protective circuit for plugging into base element PT	5 V DC	PT 2X1- 5DC-ST	2856061	10
	12 V DC	PT 2X1-12DC-ST	2856074	10
	24 V DC	PT 2X1-24DC-ST	2856087	10
	48 V DC			
	24 V AC			
PLUGTRAB base element , for mounting on NS 35		PT 2X1-BE	2856139	10
	with bridge between connections 3/4 (\downarrow) and 9/10	PT 2X1+F-BE	2856142	10
	with gas-filled surge arrester between connections 3/4 (\downarrow) and 9/10			

Accessories

Shield fast connection	Order No.	Pcs./Pkt.
For \varnothing 3-6 mm	2839295	10
For \varnothing 5-10 mm	2839512	10



2-conductor, with common reference potential, e.g., for binary signals



4-conductor with common reference potential, connection 9/10 grounded directly, e.g., for binary signals



4-conductor with common reference potential, connection 9/10 grounded via gas-filled surge arrester, e.g., for binary signals

ERC
Ex:

ERC
Ex:

ERC
Ex:

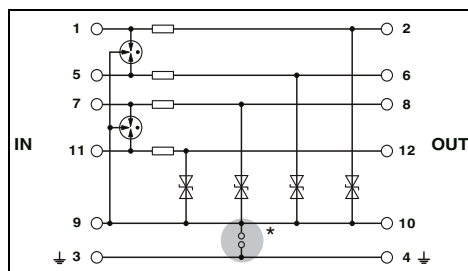
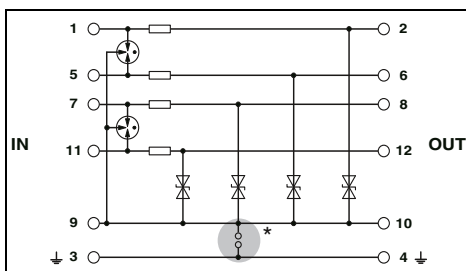
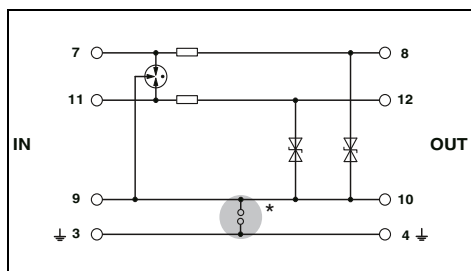

Technical data

... 24AC
C1 / C2 / C3 /
D1
40 V DC /
28 V AC
300 mA (45°C)
2.5 kA

-
10 kA
20 kA
10 kA

≤ 55 V (with PT 2x1-BE)

- / typ. 8 MHz
4.7 Ω

17.5 mm / 44.8 mm / 51.7 mm
0.2 ... 4 mm² / 0.2 ... 2.5 mm² / 24 ... 12
-40°C ... 85°C
IEC 61643-21 / EN 61643-21

Technical data

... 5DC	... 12DC	... 24DC	... 48DC
C1 / C2 / C3 / D1	C1 / C2 / C3 / D1	C1 / C2 / C3 / D1	C1 / C2 / C3 / D1
6 V DC / 4 V AC	13 V DC / 9 V AC	28 V DC / 20 V AC	53 V DC / 37 V AC
300 mA (45°C) 2.5 kA	300 mA (45°C) 2.5 kA	300 mA (45°C) 2.5 kA	300 mA (45°C) 2.5 kA

-	-	-	-
10 kA	10 kA	10 kA	10 kA
20 kA	20 kA	20 kA	20 kA
10 kA	10 kA	10 kA	10 kA

≤ 10 V ≤ 18 V ≤ 40 V ≤ 70 V

- / typ. 1 MHz - / typ. 3 MHz - / typ. 6 MHz - / typ. 9 MHz
4.7 Ω 4.7 Ω 4.7 Ω 4.7 Ω

17.7 mm / 45 mm / 52 mm
0.2 ... 4 mm² / 0.2 ... 2.5 mm² / 24 ... 12
-40°C ... 85°C
IEC 61643-21

Technical data

... 24AC	... 48AC
C1 / C2 / C3 / D1	C1 / C2 / C3 / D1
40 V DC / 28 V AC	77 V DC / 55 V AC
300 mA (45°C) 2.5 kA	300 mA (45°C) 2.5 kA

-	-
10 kA	10 kA
20 kA	20 kA
10 kA	10 kA (per path)

≤ 55 V ≤ 50 V (with PT 4X1+F-BE)

- / typ. 8 MHz - / typ. 10 MHz
4.7 Ω 4.7 Ω

17.7 mm / 45 mm / 52 mm
- mm² / - mm² / -
-40°C ... 85°C
IEC 61643-21

Ordering data

Type	Order No.	Pcs./Pkt.
PT 2X1-24AC-ST	2856100	10
PT 2X1-BE	2856139	10
PT 2X1+F-BE	2856142	10

Accessories

SSA 3-6	2839295	10
SSA 5-10	2839512	10

Ordering data

Type	Order No.	Pcs./Pkt.
PT 4X1-5DC-ST	2838306	10
PT 4X1-12DC-ST	2838319	10
PT 4X1-24DC-ST	2838322	10
PT 4X1-48DC-ST	2858014	10
PT 4X1-BE	2839363	10
PT 4X1+F-BE	2839376	10

Accessories

SSA 3-6	2839295	10
SSA 5-10	2839512	10

Ordering data

Type	Order No.	Pcs./Pkt.
PT 4X1-24AC-ST	2838351	10
PT 4X1-48AC-ST	2804856	10
PT 4X1-BE	2839363	10
PT 4X1+F-BE	2839376	10

Accessories

SSA 3-6	2839295	10
SSA 5-10	2839512	10

Surge protection and interference filters

Surge protection for measurement and control technology

Isolated signal circuits TERMITRAB complete

- For use with high rated current
- One-piece or pluggable surge protection
- Overall width of just 6.2 mm
- With Push-in or screw connection technology
- Integrated mechanical status indicator
- Impedance-neutral insertion and removal
- Coded plug versions
- With knife disconnection as an option
- Optional remote signaling module monitors up to 40 items, without additional wiring
- Plugs can be tested with CHECKMASTER 2



2-conductor, floating, pluggable,
e.g., for actuator circuits



2-conductor, floating, pluggable,
with knife disconnection,
e.g., for actuator circuits

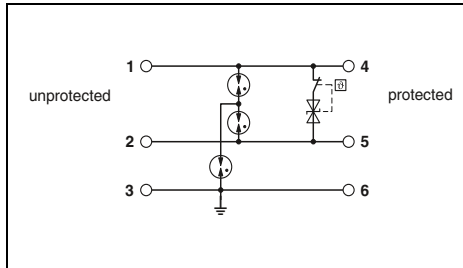

Technical data

Electrical data	... 24DC
IEC test classification/EN type	C1 / C2 / C3 / D1
Maximum continuous operating voltage U_C	30 V DC / 21 V AC
Rated current	6 A (55°C)
Pulse discharge current I_{imp} (10/350) μ s	0.5 kA
Nominal discharge current I_n (8/20) μ s	
	Core-Core 0.5 kA
	Core-Ground 5 kA
Total discharge current I_{total} (8/20) μ s	5 kA
Protection level U_p	
	Core-Core ≤ 45 V (C3 - 25 A)
	Core-Ground ≤ 850 V (C3 - 25 A)
Cut-off frequency f_g (3 dB)	typ. 1 MHz
Resistance per path	100 m Ω
General data	
Dimensions W/H/D	6.2 mm / 105.8 mm / 100 mm
Connection data rigid / flexible / AWG	0.2 ... 4 mm ² / 0.2 ... 2.5 mm ² / 24 ... 12
Temperature range	-40°C ... 85°C
Test standards	IEC 61643-21 / EN 61643-21

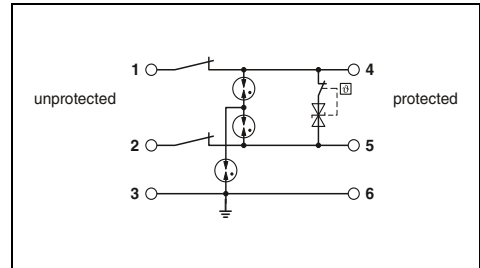

Technical data

Electrical data	... 24DC
IEC test classification/EN type	C1 / C2 / C3 / D1
Maximum continuous operating voltage U_C	30 V DC / 21 V AC
Rated current	6 A (55°C)
Pulse discharge current I_{imp} (10/350) μ s	0.5 kA
Nominal discharge current I_n (8/20) μ s	
	Core-Core 0.5 kA
	Core-Ground 5 kA
Total discharge current I_{total} (8/20) μ s	5 kA
Protection level U_p	
	Core-Core ≤ 45 V (C3 - 25 A)
	Core-Ground ≤ 850 V (C3 - 25 A)
Cut-off frequency f_g (3 dB)	typ. 1 MHz
Resistance per path	100 m Ω
General data	
Dimensions W/H/D	6.2 mm / 105.8 mm / 100 mm
Connection data rigid / flexible / AWG	0.2 ... 4 mm ² / 0.2 ... 2.5 mm ² / 24 ... 12
Temperature range	-40°C ... 85°C
Test standards	IEC 61643-21 / EN 61643-21

Ordering data

Description	Voltage U_N
TERMITRAB complete	
Push-in connection technology	24 V DC
Screw connection technology	24 V DC

Type	Order No.	Pcs./Pkt.
TTC-6P-2-HC-24DC-PT-I	2906817	1
TTC-6P-2-HC-24DC-UT-I	2906811	1

Ordering data

Type	Order No.	Pcs./Pkt.
TTC-6P-2-HC-M-24DC-PT-I	2906755	1
TTC-6P-2-HC-M-24DC-UT-I	2906743	1

Accessories

Replacement plug	
Remote signaling set	
Push-in connection technology	
Screw connection technology	
Fuse carrier	

TTC-6P-2-HC-24DC-I-P	2907845	1
TTC-6-FMRS-PT	2907811	1
TTC-6-FMRS-UT	2907810	1
TTC-6-FC-UT	1054762	50

Accessories

TTC-6P-2-HC-24DC-I-P	2907845	1
TTC-6-FMRS-PT	2907811	1
TTC-6-FMRS-UT	2907810	1
TTC-6-FC-UT	1054762	50



SIL
evaluated
IEC 61508



2-conductor, floating, one-piece,
e.g., for actuator circuits



SIL
evaluated
IEC 61508



2-conductor, floating, one-piece,
with knife disconnection,
e.g., for actuator circuits

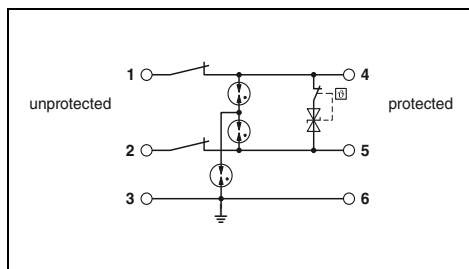
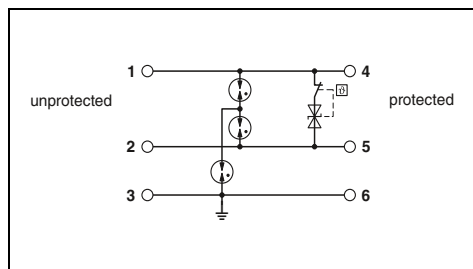

Technical data

... 24DC
C1 / C2 / C3 / D1
30 V DC / 21 V AC
6 A (55°C)
0.5 kA

0.5 kA
5 kA
5 kA

≤ 45 V
(C3 - 25 A)
≤ 850 V
(C3 - 25 A)

typ. 1 MHz
100 mΩ

6.2 mm / 105.8 mm / 83.5 mm
0.2 ... 4 mm² / 0.2 ... 2.5 mm² / 24 ... 12
-40°C ... 85°C
IEC 61643-21 / EN 61643-21

Technical data

... 24DC
C1 / C2 / C3 / D1
30 V DC / 21 V AC
6 A (55°C)
0.5 kA

0.5 kA
5 kA
5 kA

≤ 45 V
(C3 - 25 A)
≤ 850 V
(C3 - 25 A)

typ. 1 MHz
100 mΩ

6.2 mm / 105.8 mm / 83.5 mm
0.2 ... 4 mm² / 0.2 ... 2.5 mm² / 24 ... 12
-40°C ... 85°C
IEC 61643-21 / EN 61643-21

Ordering data

Type	Order No.	Pcs./Pkt.
TTC-6-2-HC-24DC-PT-I	2908439	1
TTC-6-2-HC-24DC-UT-I	2908438	1

Ordering data

Type	Order No.	Pcs./Pkt.
TTC-6-2-HC-M-24DC-PT-I	2906731	1
TTC-6-2-HC-M-24DC-UT-I	2906719	1

Accessories

Type	Order No.	Pcs./Pkt.
TTC-6-FMRS-PT	2907811	1
TTC-6-FMRS-UT	2907810	1
TTC-6-FC-UT	1054762	50

Accessories

Type	Order No.	Pcs./Pkt.
TTC-6-FMRS-PT	2907811	1
TTC-6-FMRS-UT	2907810	1
TTC-6-FC-UT	1054762	50

Surge protection and interference filters

Surge protection for measurement and control technology

Signal circuits with high rated current PLUGTRAB PT

- Protective devices for higher nominal power
- Consistently pluggable signal circuit protection
- Maximum ease of maintenance, thanks to the two-piece design
- Base element remains an integral part of the installation
- Impedance-neutral disconnection of plug for test and maintenance purposes
- Plugs can be tested with CHECKMASTER 2
- FM types with permanent and independent monitoring by a diagnostics unit
- * **Note:** If no protective plug is inserted, there is no electrical connection.



2-conductor, floating, free of leakage current, e.g., for actuator circuits



2-conductor, with common reference potential, remote signaling, e.g., for actuator circuits

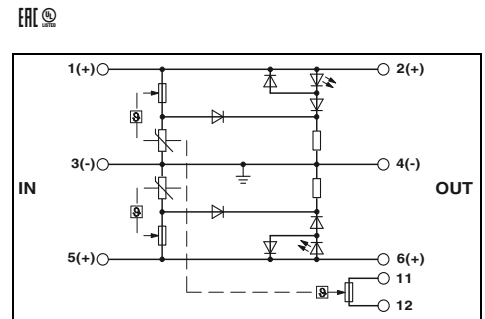
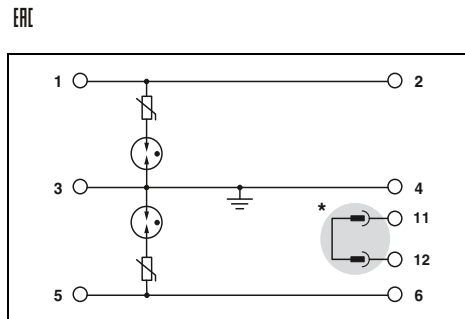

	Technical data		Technical data		
	... 120AC	... 230AC	... 60AC	... 120AC	... 230AC
Electrical data	... 120AC	... 230AC	... 60AC	... 120AC	... 230AC
IEC test classification/EN type	C1 / C2 / C3	C1 / C2 / C3 / D1	C1 / C2 / C3 / D1	C1 / C2 / C3 / D1	C1 / C2 / C3 / D1
Maximum continuous operating voltage U_c	- / 175 V AC	- / 250 V AC	100 V DC / 75 V AC (50/60 Hz)	150 V DC / 150 V AC (50/60 Hz)	275 V DC / 275 V AC (50/60 Hz)
Rated current	6 A	6 A	26 A AC (30°C)	26 A AC (30°C)	26 A AC (30°C)
Pulse discharge current I_{imp} (10/350) μ s	300 A	500 A	500 A	500 A	500 A
Nominal discharge current I_n (8/20) μ s					
Total discharge current I_{total} (8/20) μ s	Core-Ground 3 kA 8 kA	Core-Ground 3 kA 8 kA	2 kA 4 kA	2.5 kA 5 kA	2.5 kA 5 kA
Output voltage limitation at 1 kV/ μ s	Core-Ground \leq 950 V (C2 - 1 kA)	Core-Ground \leq 1.5 kV (C2 - 4 kV / 2 kA)	\leq 300 V (C2 - 4 kV / 2 kA)	\leq 550 V (C2 - 5 kV / 2.5 kA)	\leq 900 V (C2 - 5 kV / 2.5 kA)
General data					
Dimensions W/H/D	17.5 mm / 44.8 mm / 51.7 mm		17.5 mm / 44.8 mm / 51.7 mm		
Connection data rigid / flexible / AWG	0.2 ... 4 mm ² / 0.2 ... 2.5 mm ² / 24 ... 12		0.2 ... 4 mm ² / 0.2 ... 2.5 mm ² / 24 ... 12		
Temperature range	-40°C ... 80°C		-40°C ... 85°C		
Test standards	EN 61643-21		IEC 61643 / EN 61643-21		

Description	Voltage U_N	Ordering data			Ordering data		
		Type	Order No.	Pcs./Pkt.	Type	Order No.	Pcs./Pkt.
MAINS-PLUGTRAB , consisting of a plug and a base element	120 V AC	PT 2X1-VF-120AC	2859327	10			
	230 V AC	PT 2X1-VF-230AC	2805460	10			
PLUGTRAB plug , with protective circuit for plugging into base element PT	60 V AC				PT 2X1VA- 60AC-ST	2839172	10
	120 V AC	PT 2X1-VF-120AC-ST	2856799	10	PT 2X1VA-120AC-ST	2839185	10
	230 V AC	PT 2X1-VF-230AC-ST	2921365	10	PT 2X1VA-230AC-ST	2839198	10
PLUGTRAB base element , for mounting on NS 35		PT-BE/FM	2839282	10	PT-BE/FM	2839282	10

Accessories				Accessories			
Shield fast connection For \varnothing 3-6 mm For \varnothing 5-10 mm	SSA 3-6	2839295	10	SSA 3-6	2839295	10	
	SSA 5-10	2839512	10	SSA 5-10	2839512	10	

Isolated signal circuits PLUGTRAB PT

- For use with high rated current
- For systems with high dielectric strength or fine protection installed
- Installation location is directly where the MCR cable enters the building
- Consistently pluggable signal circuit protection
- Maximum ease of maintenance, thanks to the two-piece design
- Base element remains an integral part of the installation
- Impedance-neutral disconnection of plug for test and maintenance purposes
- Plugs can be tested with CHECKMASTER 2



2-conductor, coarse protection,
e.g., for actuator circuits



4-conductor, coarse protection,
e.g., for actuator circuits

ERC

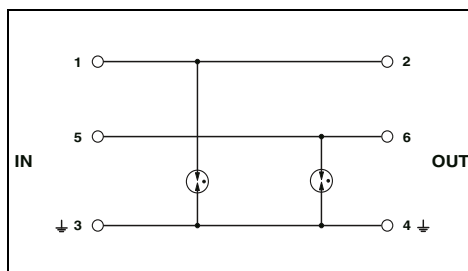

ERC

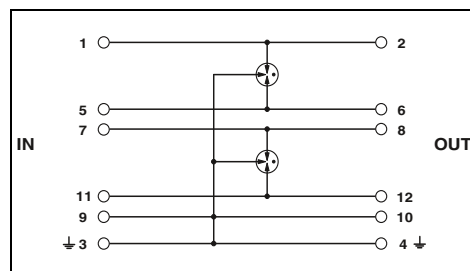

Technical data

Electrical data	
IEC test classification/EN type	C1 / C2 / C3 / D1
Maximum continuous operating voltage U_C	60 V DC / 48 V AC
Rated current	2 A AC (80°C)
Pulse discharge current I_{imp} (10/350) μ s	5 kA
Nominal discharge current I_n (8/20) μ s	
	Core-Core
	-
	Core-Ground
	20 kA
	20 kA
Total discharge current I_{total} (8/20) μ s	
Protection level U_p	
	Core-Ground
	≤ 600 V
	(C2 - 10 kV / 5 kA)
Output voltage limitation at 1 kV/ μ s	
	Core-Ground
	≤ 600 V
General data	
Dimensions W/H/D	17.7 mm / 45 mm / 52 mm
Connection data rigid / flexible / AWG	0.2 ... 4 mm ² / 0.2 ... 2.5 mm ² / 24 ... 12
Temperature range	-40°C ... 85°C
Test standards	IEC 61643-21 / EN 61643-21

Technical data	
C1 / C2 / C3 / D1	
60 V DC / 120 V AC	
2 A AC (80°C)	
2.5 kA	
10 kA	
10 kA	
20 kA	
≤ 450 V	
(C2 - 10 kV / 5 kA with PT 4-BE)	
≤ 450 V (with PT 4-BE)	
General data	
17.7 mm / 45 mm / 52 mm	
0.2 ... 4 mm ² / 0.2 ... 2.5 mm ² / 24 ... 12	
-40°C ... 85°C	
IEC 61643-21 / EN 61643-21	

Ordering data

Description	Voltage U_N
PLUGTRAB plug , with protective circuit for plugging into base element PT	48 V AC 110 V AC
PLUGTRAB base element , for mounting on NS 35	
Bridge between 3/4 ($\frac{1}{2}$) and 9/10	

Type	Order No.	Pcs./Pkt.
PT 2-F-ST	2859000	10
PT-BE/FM	2839282	10

Type	Order No.	Pcs./Pkt.
PT 4-F-ST	2858441	10
PT 4-BE	2839402	10

Accessories

Shield fast connection
For \varnothing 3-6 mm
For \varnothing 5-10 mm

SSA 3-6	2839295	10
SSA 5-10	2839512	10

SSA 3-6	2839295	10
SSA 5-10	2839512	10

Surge protection and interference filters

Surge protection for measurement and control technology

Signals with common reference potential LINETRAB LIT

- Protection of up to four signal wires with an overall width of 6.2 mm
- Can be used in binary, analog, and intrinsically safe circuits

Notes:

For approvals and dimensional drawing, visit phoenixcontact.net/products



Protection for two conductors with a common reference potential



Protection for four conductors with a common reference potential

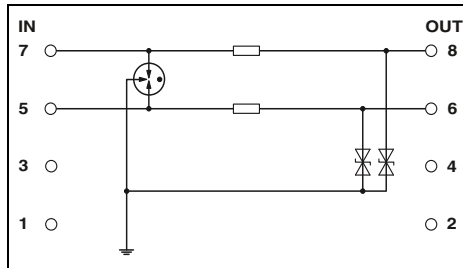

Technical data

Electrical data	
IEC test classification/EN type	C1 / C2 / C3 / D1
Maximum continuous operating voltage U_C	36 V DC / 25 V AC
Rated current	350 mA (40°C)
Pulse discharge current I_{imp} (10/350) μ s	500 A
Nominal discharge current I_n (8/20) μ s	
	Core-Core -
	Core-Ground 5 kA
Total discharge current I_{total} (8/20) μ s	10 kA
Max. discharge current I_{max} (8/20) μ s	20 kA (in total)
Protection level U_p	
	Core-Core -
	Core-Ground ≤ 60 V
	(C1 - 500 V / 250 A)
Cut-off frequency f_g (3 dB)	Asymmetrical in the 50 Ω system
Resistance per path	typ. 6 MHz
General data	3.3 Ω
Dimensions W/H/D	6.2 mm / 93.1 mm / 102.5 mm
Connection data rigid / flexible / AWG	0.2 ... 2.5 mm ² / 0.2 ... 2.5 mm ² / 24 ... 14
Temperature range	-40°C ... 80°C
Test standards	IEC 61643-21 / EN 61643-21

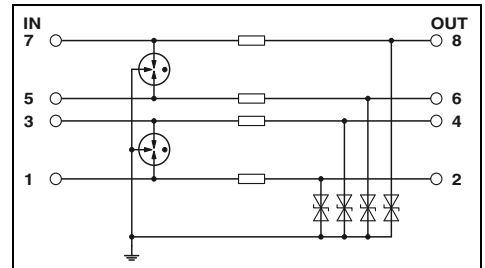

Technical data

Electrical data	
IEC test classification/EN type	C1 / C2 / C3 / D1
Maximum continuous operating voltage U_C	36 V DC / 25 V AC
Rated current	350 mA (40°C)
Pulse discharge current I_{imp} (10/350) μ s	500 A
Nominal discharge current I_n (8/20) μ s	
	Core-Core -
	Core-Ground 5 kA
Total discharge current I_{total} (8/20) μ s	20 kA
Max. discharge current I_{max} (8/20) μ s	10 kA
Protection level U_p	
	Core-Core -
	Core-Ground ≤ 60 V
	(C1 - 500 V / 250 A)
Cut-off frequency f_g (3 dB)	Asymmetrical in the 50 Ω system
Resistance per path	typ. 6 MHz
General data	3.3 Ω
Dimensions W/H/D	6.2 mm / 93.1 mm / 102.5 mm
Connection data rigid / flexible / AWG	0.2 ... 2.5 mm ² / 0.2 ... 2.5 mm ² / 24 ... 14
Temperature range	-40°C ... 80°C
Test standards	IEC 61643-21 / EN 61643-21

Ordering data

Description	Voltage U_N	Type	Order No.	Pcs./Pkt.
LINETRAB LIT surge protection	24 V DC	LIT 2X1-24	2804636	10

Ordering data

Description	Voltage U_N	Type	Order No.	Pcs./Pkt.
LINETRAB LIT surge protection	24 V DC	LIT 4X1-24	2804649	10

Signals with common reference potential

SURGETRAB S-PT

- Easy assembly, directly on the field device
- Arresters in hexagonal tube with various outer threads
- **S-PT-4-EX** installation in a separate cable gland parallel to the signal cables



4-conductor with common reference potential, intrinsically safe, encapsulated, without decoupling resistance

ERC

Ex:

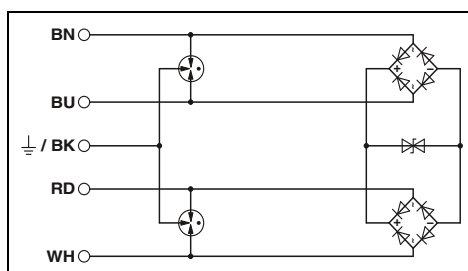

Technical data

Electrical data		
IEC test classification/EN type		C1 / C2 / C3 / D1
Maximum continuous operating voltage U_C		36 V DC / 25 V AC
Pulse discharge current I_{imp} (10/350) μ s		1 kA
Nominal discharge current I_n (8/20) μ s		
	Core-Core	260 A
	Core-Ground	10 kA
Maximum permitted short-circuit current at installation location		1 A (non-Ex)
Total discharge current I_{total} (8/20) μ s		20 kA
Protection level U_p		
	Core-Core	≤ 65 V (C3 - 10 A)
	Core-Ground	≤ 1.1 kV (C3 - 100 A)
Output voltage limitation at 1 kV/ μ s		
	Core-Core	≤ 60 V
	Core-Ground	-
General data		
Dimensions W/H/D		28 mm / 28 mm / 79 mm
Temperature range		-40°C ... 80°C (non-Ex)
Test standards		EN 61643-21 / EN 60079-0 / EN 60079-1 / EN 60079-11 / EN 60079-31 / IEC 60079-0
Safety data		
EC-type examination certificate in accordance with ATEX		KEMA 09ATEX0028 X
Maximum inner capacity C_i		1.65 nF
Maximum inner inductance L_i		1 μ H
Maximum input current I_i		500 mA ($T_4 / \leq 75^\circ\text{C}$)
Maximum input voltage U_i		36 V DC
Maximum input power P_i		3 W

Ordering data

Description	Voltage U_N	Type	Order No.	Pcs./Pkt.
SURGETRAB protective adapter for installation on measuring sensors for Ex protection zones				
Outer thread: M20 x 1.5	24 V DC	S-PT-4-EX-24DC	2800036	1
Outer thread: 1/2" 14 NPT	24 V DC	S-PT-4-EX-24DC-1/2"	2800037	1

Surge protection and interference filters

Surge protection for measurement and control technology

Signals with common reference potential

COMTRAB CTM

- Space-saving LSA-PLUS connection technology
- Can be used in LSA-PLUS disconnect and control strips or CT-TERMIBLOCK
- The CTM 10-MAG surge protection magazine can be fitted with ten different protective plugs



2-conductor,
with common reference potential

ERC

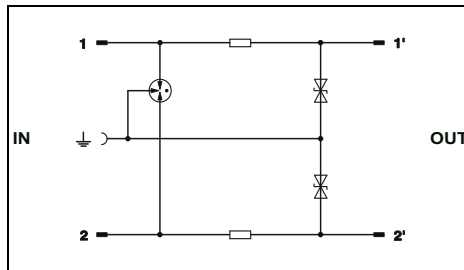

Technical data

Electrical data	... 12DC	... 24DC	... 60DC
IEC test classification/EN type	B2 / C1 / C2 / C3 / D1	B2 / C1 / C2 / C3 / D1	B2 / C1 / C2 / C3 / D1
Maximum continuous operating voltage U_c	± 15 V DC / 10 V AC	± 30 V DC / 21 V AC	60 V DC / 50 V AC
Rated current	380 mA AC (25°C)	380 mA AC (25°C)	380 mA AC (25°C)
Pulse discharge current I_{imp} (10/350) μ s	1 kA	1 kA	1 kA
Nominal discharge current I_n (8/20) μ s			
	Core-Core	-	-
	Core-Ground	5 kA	5 kA
Total discharge current I_{total} (8/20) μ s	10 kA	10 kA	10 kA
Output voltage limitation at 1 kV/ μ s			
	Core-Core	-	-
	Core-Ground	≤ 22 V	≤ 45 V
Cut-off frequency f_g (3 dB)			≤ 160 V
Resistance per path	3.3 Ω	3.3 Ω	3.3 Ω
General data			
Dimensions W/H/D	9.5 mm / 21 mm / 53.5 mm		
Temperature range	-25°C ... 75°C		
Test standards	IEC 61643-21		

Ordering data

Description	Voltage U_N	Type	Order No.	Pcs./Pkt.
COMTRAB modular , surge protection for a double wire with coarse and fine protection and ohmic decoupling, DSL-compatible	12 V DC	CTM 2X1- 12DC	2838584	10
	24 V DC	CTM 2X1- 24DC	2838500	10
	60 V DC	CTM 2X1- 60DC	2838542	10

Accessories

Magazine , with grounding rail for accommodating up to 10 LSA-PLUS protective plugs (CTM...), for insertion in CT-TERMIBLOCK or LSA-PLUS disconnect strip	CTM 10-MAG	2838610	5
Grounding plug	CTM EST	2838649	10
Screw terminal block , with disconnect contacts for accommodating the CT and CTM protective plugs, design: 10 double wires	CT-TERMIBLOCK 10 DA	0441711	10

new

Resistance-dependent measurements
TERMITRAB complete

- Overall width of just 6.2 mm
- With Push-in or screw connection technology



2-conductor, floating, impedance-free, e.g., for temperature measurement



3-conductor, floating, impedance-free, e.g., for temperature measurement

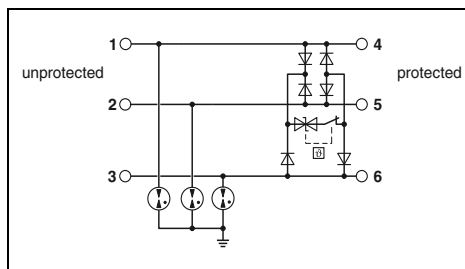
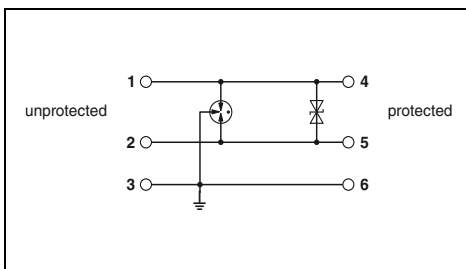

Technical data

Technical data

Electrical data	
IEC test classification/EN type	C1 / C2 / C3 / D1
Maximum continuous operating voltage U_C	30 V DC / 21 V AC
Rated current	450 mA (80°C)
Pulse discharge current I_{imp} (10/350) μ s	0.5 kA
Nominal discharge current I_n (8/20) μ s	
	Core-Core 0.5 kA
	Core-Ground 5 kA
Total discharge current I_{total} (8/20) μ s	10 kA
Protection level U_p	
	Core-Core ≤ 45 V (C3 - 25 A)
	Core-Ground ≤ 600 V (C3 - 25 A)
Cut-off frequency f_g (3 dB)	typ. 965 kHz
Resistance per path	100 m Ω
General data	
Dimensions W/H/D	6.2 mm / 105.8 mm / 69.5 mm
Connection data rigid / flexible / AWG	0.2 ... 4 mm ² / 0.2 ... 2.5 mm ² / 24 ... 12
Temperature range	-40°C ... 85°C
Test standards	IEC 61643-21 / EN 61643-21

... 5DC	... 24DC
C1 / C2 / C3	C1 / C2 / C3 / D1
5 V DC / 3 V AC	30 V DC / 21 V AC
5 A (55°C)	5 A (55°C)
-	0.5 kA
0.5 kA	0.5 kA
5 kA	5 kA
10 kA	10 kA
≤ 100 V (C1 - 1 kV/500 A)	≤ 68 V (C1 - 1 kV/500 A)
≤ 700 V (C1 - 1 kV/500 A)	≤ 700 V (C1 - 1 kV/500 A)
typ. 33 MHz	typ. 60 MHz
0.1 Ω	0.1 Ω
6.2 mm / 105.8 mm / 100 mm	
0.2 ... 4 mm ² / 0.2 ... 2.5 mm ² / 24 ... 12	
-40°C ... 85°C	
IEC 61643-21 / EN 61643-21	

Ordering data

Ordering data

Description	Voltage U_N
TERMITRAB complete, with Push-in connection technology	
	5 V DC
	24 V DC
TERMITRAB complete, with screw connection technology	
	24 V DC

Type	Order No.	Pcs./Pkt.
TTC-6-2-24DC-PT	2906806	1
TTC-6-2-24DC-UT	2906800	1

Type	Order No.	Pcs./Pkt.
TTC-6P-3-5DC-PT-I	1061385	1
TTC-6P-3-24DC-PT-I	1061383	1

Accessories

Accessories

Replacement plug	5 V DC
	24 V DC
Fuse carrier	

TTC-6-FC-UT	1054762	50
-------------	---------	----

TTC-6P-3-5DC-I-P	1061386	1
TTC-6P-3-24DC-I-P	1061384	1
TTC-6-FC-UT	1054762	50

Surge protection and interference filters

Surge protection for measurement and control technology

Resistance-dependent measurements PLUGTRAB PT

- Consistently pluggable signal circuit protection
- Maximum ease of maintenance, thanks to the two-piece design
- Base element remains an integral part of the installation
- Impedance-neutral disconnection of plug for test and maintenance purposes
- Plugs can be tested with CHECKMASTER 2



4-conductor, floating, impedance-free, e.g., for temperature measurement

Note:

Base elements are grounded differently. For **PT .x.-BE**, connections 9/10 (GND) are connected directly to the mounting foot.

For **PT .x.+F-BE**, connections 9/10 (GND) are connected to the mounting foot via a gas-filled surge arrester.

ERC

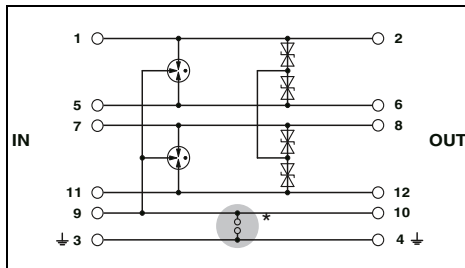

Technical data

Electrical data		... 5DC	... 12DC	... 24DC	... 24AC
		C1 / C2 / C3 / D1	C1 / C2 / C3 / D1	C1 / C2 / C3 / D1	C1 / C2 / C3 / D1
IEC test classification/EN type		6 V DC / 4 V AC	12.8 V DC / 9 V AC	27 V DC / 19 V AC	40 V DC / 28 V AC
Maximum continuous operating voltage U_c		2 A (80°C)	2 A (80°C)	2 A (80°C)	2 A AC (80°C)
Rated current		2.5 kA	2.5 kA	2.5 kA	2.5 kA
Pulse discharge current I_{imp} (10/350) μ s		720 A	690 A	365 A	187 A
Nominal discharge current I_n (8/20) μ s	Core-Core	10 kA	10 kA	10 kA	10 kA
	Core-Ground	20 kA	20 kA	20 kA	20 kA
Total discharge current I_{total} (8/20) μ s		10 kA	10 kA	10 kA	10 kA
Max. discharge current I_{max} (8/20) μ s		≤ 30 V	≤ 40 V	≤ 50 V	≤ 85 V
Protection level U_p	Core-Core	(C1 - 1 kV / 500 A)	(C1 - 1 kV / 500 A)	(C1 - 500 V / 250 A)	(C1 - 500 V / 250 A)
	Core-Ground	≤ 450 V	≤ 450 V	≤ 500 V	≤ 450 V
				(C2 - 10 kV / 5 kA with PT 4-BE)	(C2 - 10 kV / 5 kA with PT 4-BE)
Output voltage limitation at 1 kV/ μ s		≤ 10 V	≤ 18 V	≤ 40 V	≤ 75 V
	Core-Core	≤ 450 V	≤ 450 V	≤ 450 V (with PT 4-BE)	≤ 450 V (with PT 4-BE)
General data		17.7 mm / 45 mm / 52 mm			
Dimensions W/H/D		0.2 ... 4 mm ² / 0.2 ... 2.5 mm ² / 24 ... 12			
Connection data rigid / flexible / AWG		-40°C ... 85°C			
Temperature range		IEC 61643-21			
Test standards					

Ordering data

Description	Voltage U_N	Type	Order No.	Pcs./Pkt.
PLUGTRAB plug , with protective circuit for plugging into base element PT	5 V DC	PT 4-5DC-ST	2839211	10
	12 V DC	PT 4-12DC-ST	2839237	10
	24 V DC	PT 4-24DC-ST	2839240	10
	24 V AC	PT 4-24AC-ST	2800078	1
PLUGTRAB base element , for mounting on NS 35		PT 4-BE	2839402	10
	Bridge between 3/4 (\downarrow) and 9/10 Gas-filled surge arrester between 3/4 (\downarrow) and 9/10	PT 4+F-BE	2839415	10

Accessories

Shield fast connection			
For \varnothing 3-6 mm		2839295	10
For \varnothing 5-10 mm		2839512	10

Resistance-dependent measurements
LINETRAB LIT

- Protection of up to four signal wires with an overall width of 6.2 mm
- Can be used in binary, analog, and intrinsically safe circuits



Notes:
For approvals and dimensional drawing, visit phoenixcontact.net/products
For additional safety data, visit phoenixcontact.net/products

4-conductor, floating, impedance-free, e.g., for temperature measurement

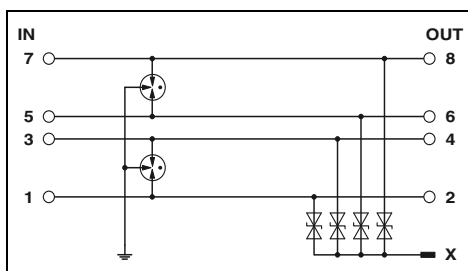

Technical data

Electrical data	... 12DC	... 24DC	
IEC test classification/EN type	C1 / C2 / C3 / D1	C1 / C2 / C3 / D1	
Maximum continuous operating voltage U_C	18 V DC / 13 V AC	36 V DC / 25 V AC	
Rated current	500 mA (40°C)	500 mA (40°C)	
Pulse discharge current I_{imp} (10/350) μ s	500 A	500 A	
Nominal discharge current I_n (8/20) μ s			
	Core-Core	350 A	250 A
	Core-Ground	5 kA	5 kA
Total discharge current I_{total} (8/20) μ s		20 kA	20 kA
Max. discharge current I_{max} (8/20) μ s		10 kA	10 kA
Protection level U_p			
	Core-Core	≤ 35 V (C3 - 10 A)	≤ 55 V (C3 - 10 A)
	Core-Ground	≤ 650 V (C2 - 10 kV / 5 kA)	≤ 650 V (C2 - 10 kV / 5 kA)
Cut-off frequency f_g (3 dB)	Symmetrical in the 50 Ω system	typ. 5 MHz	typ. 7.7 MHz
Resistance per path		0 Ω	0 Ω
General data			
Dimensions W/H/D		6.2 mm / 93.1 mm / 102.5 mm	
Connection data rigid / flexible / AWG		0.2 ... 2.5 mm ² / 0.2 ... 2.5 mm ² / 24 ... 14	
Temperature range		-40°C ... 80°C	
Test standards		EN 61643-21 / EN 60079-0 / EN 60079-11 / EN 60079-26 / IEC 60079-0 / IEC 60079-11	
Safety data			
EC-type examination certificate in accordance with ATEX	KEMA 09ATEX0051 X	KEMA 09ATEX0051 X	
Maximum inner capacity C_i	typ. 6 nF	typ. 2.5 nF	
Maximum inner inductance L_i	< 1 μ H	< 1 μ H	
Maximum input current I_i	500 mA (T4 / $\leq 80^\circ$ C)	500 mA (T4 / $\leq 80^\circ$ C)	
Maximum input voltage U_i	18 V DC	36 V DC	
Maximum input power P_i	550 mW	550 mW	

Ordering data

Description	Voltage U_N	Type	Order No.	Pcs./Pkt.
LINETRAB	12 V DC	LIT 4-12	2804704	10
	24 V DC	LIT 4-24	2804678	10

Accessories

DIN rail connector	ME 6,2 TBUS-2 1,5/5-ST-3,81KMGY	2969401	10
---------------------------	---------------------------------	---------	----

Surge protection and interference filters

Surge protection for measurement and control technology

Resistance-dependent measurements SURGETRAB S-PT

- Easy assembly, directly on the field device
- Arresters in hexagonal tube with various outer threads
- **S-PT-4-EX** installation in a separate cable gland parallel to the signal cables



**4-conductor with common reference potential,
intrinsically safe, encapsulated,
without decoupling resistance**

ERC
Ex: IEC RoHS

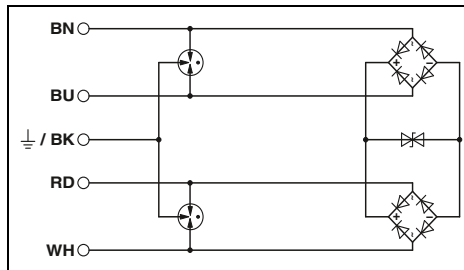

Technical data

Electrical data	... 24DC
IEC test classification/EN type	C1 / C2 / C3 / D1
Maximum continuous operating voltage U_C	36 V DC / 25 V AC
Pulse discharge current I_{imp} (10/350) μ s	1 kA
Nominal discharge current I_n (8/20) μ s	
	Core-Core 260 A
	Core-Ground 10 kA
Maximum permitted short-circuit current at installation location	1 A (non-Ex)
Total discharge current I_{total} (8/20) μ s	20 kA
Max. discharge current I_{max} (8/20) μ s	-
Protection level U_p	
	Core-Core ≤ 65 V (C3 - 10 A)
	Core-Ground ≤ 1.1 kV (C3 - 100 A)
Output voltage limitation at 1 kV/ μ s	
	Core-Core ≤ 60 V
	Core-Ground -
General data	
Dimensions W/H/D	28 mm / 28 mm / 79 mm
Temperature range	-40°C ... 80°C (non-Ex)
Test standards	EN 61643-21 / EN 60079-0 / EN 60079-1 / EN 60079-11 / EN 60079-31 / IEC 60079-0
Safety data	
EC-type examination certificate in accordance with ATEX	KEMA 09ATEX0028 X
Maximum inner capacity C_i	1.65 nF
Maximum inner inductance L_i	1 μ H
Maximum input current I_i	500 mA ($T_4 \leq 75^\circ\text{C}$)
Maximum input voltage U_i	36 V DC
Maximum input power P_i	3 W

Ordering data

Description	Voltage U_N	Type	Order No.	Pcs./Pkt.
SURGETRAB protective adapter for installation on measuring sensors for Ex protection zones				
Outer thread: M20 x 1.5	24 V DC	S-PT-4-EX-24DC	2800036	1
Outer thread: 1/2" 14 NPT	24 V DC	S-PT-4-EX-24DC-1/2"	2800037	1

Surge protection and interference filters

Surge protection for measurement and control technology

Single-stage protective devices

TERMITRAB complete

- Fine surge protection for signal circuits on electronic controllers
- Overall width of just 6.2 mm
- With Push-in or screw connection technology
- Integrated mechanical status indicator
- Optional remote signaling module monitors up to 40 items, without additional wiring



**2-conductor
with common reference potential,
e.g., for binary signals**



**1-conductor
with grounded reference potential**

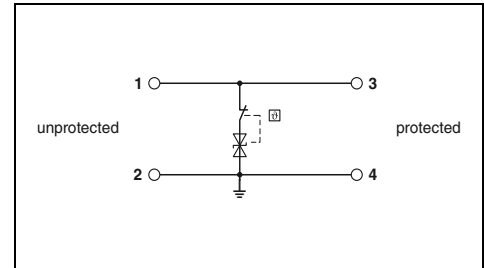
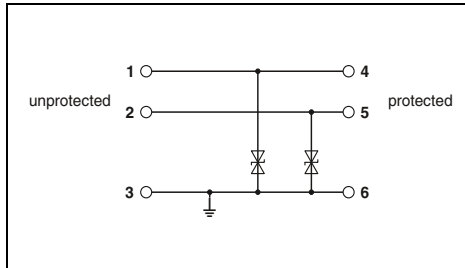

Technical data

Electrical data	... 24DC	... 12DC
IEC test classification/EN type	C1 / C2 / C3	C1 / C3
Maximum continuous operating voltage U_C	15 V DC / 10 V AC	30 V DC / 21 V AC
Rated current	6 A (55°C)	6 A (55°C)
Nominal discharge current I_n (8/20) μ s		
Protection level U_p	Core-Core	-
	Core-Ground	0.5 kA
Cut-off frequency f_g (3 dB)	Core-Core	-
	Core-Ground	≤ 25 V (C3 - 25 A)
Resistance per path	Symmetrical in the 150 Ω system	-
	Asymmetrical in the 150 Ω system	typ. 420 kHz 100 m Ω
General data		
Dimensions W/H/D	6.2 mm / 105.8 mm / 69.5 mm	
Connection data rigid / flexible / AWG	0.2 ... 4 mm ² / 0.2 ... 2.5 mm ² / 24 ... 12	
Temperature range	-40°C ... 85°C	
Test standards	IEC 61643-21 / EN 61643-21	

Technical data

... 12DC	... 24DC	... 48DC	... 60DC
C1 / C3	C3	C3	C3
15 V DC / 10 V AC	30 V DC / 21 V AC	53 V DC / 37 V AC	75 V DC / 53 V AC
10 A (60°C)	10 A (60°C)	10 A (60°C)	10 A (60°C)
300 A	150 A	90 A	60 A
≤ 22 V (C3 - 25 A)	≤ 50 V (C3 - 25 A)	≤ 80 V (C3 - 18 A)	≤ 110 V (C3 - 12 A)
typ. 1.1 MHz 100 m Ω	typ. 1.7 MHz 100 m Ω	typ. 3.5 MHz 100 m Ω	typ. 4 MHz 100 m Ω
6.2 mm / 92 mm / 69.5 mm			
0.2 ... 4 mm ² / 0.2 ... 2.5 mm ² / 24 ... 12			
-40°C ... 85°C			
IEC 61643-21 / EN 61643-21			

Ordering data

Description	Voltage U_N
TERMITRAB complete , with Push-in connection technology	
	12 V DC
	24 V DC
TERMITRAB complete , with Push-in connection technology	
	12 V DC
	24 V DC
	48 V DC
	60 V DC
TERMITRAB complete , with screw connection technology	
	12 V DC
	24 V DC
	48 V DC
	60 V DC

Type	Order No.	Pcs./Pkt.
TTC-6-2XTVSD-12DC-PT	2906807	1
TTC-6-2XTVSD-24DC-PT	2906808	1

Ordering data

Type	Order No.	Pcs./Pkt.
TTC-6-TVSD-C-12DC-PT-I	2906847	1
TTC-6-TVSD-C-24DC-PT-I	2906848	1
TTC-6-TVSD-C-48DC-PT-I	2906849	1
TTC-6-TVSD-C-60DC-PT-I	2906850	1
TTC-6-TVSD-C-12DC-UT-I	2906829	1
TTC-6-TVSD-C-24DC-UT-I	2906831	1
TTC-6-TVSD-C-48DC-UT-I	2906832	1
TTC-6-TVSD-C-60DC-UT-I	2906833	1

Accessories

End cover	
Remote signaling set	
Push-in connection technology	
Screw connection technology	

--	--

Accessories

TTC-6-LCP	2908729	50
TTC-6-FMRS-PT	2907811	1
TTC-6-FMRS-UT	2907810	1



2-conductor,
floating

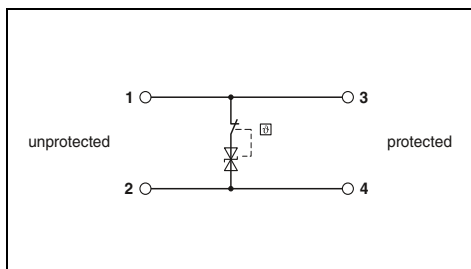

Technical data

... 24DC	... 48DC	... 60DC
C3	C3	C3
30 V DC / 21 V AC	53 V DC / 37 V AC	75 V DC / 53 V AC
10 A (60°C)	10 A (60°C)	10 A (60°C)
150 A	90 A	60 A
-	-	-
≤ 50 V (C3 - 25 A)	≤ 80 V (C3 - 18 A)	≤ 110 V (C3 - 12 A)
-	-	-
typ. 1.7 MHz	typ. 3.5 MHz	typ. 4 MHz
-	-	-
100 mΩ	100 mΩ	100 mΩ

6.2 mm / 92 mm / 69.5 mm
 0.2 ... 4 mm² / 0.2 ... 2.5 mm² / 24 ... 12
 -40°C ... 85°C
 IEC 61643-21 / EN 61643-21

Ordering data

Type	Order No.	Pcs./Pkt.
TTC-6-TVSD-D-24DC-PT-I	2906851	1
TTC-6-TVSD-D-48DC-PT-I	2906852	1
TTC-6-TVSD-D-60DC-PT-I	2906853	1
TTC-6-TVSD-D-24DC-UT-I	2906834	1
TTC-6-TVSD-D-48DC-UT-I	2906835	1
TTC-6-TVSD-D-60DC-UT-I	2906836	1

Accessories

TTC-6-LCP	2908729	50
TTC-6-FMRS-PT	2907811	1
TTC-6-FMRS-UT	2907810	1

Surge protection and interference filters

Surge protection for measurement and control technology

Single-stage protective devices

TERMITRAB complete

- Medium surge protection for signal circuits on electronic controllers
- Overall width of just 6.2 mm
- With Push-in or screw connection technology
- Integrated mechanical status indicator
- Optional remote signaling module monitors up to 40 items, without additional wiring



1-conductor
with grounded reference potential



2-conductor,
floating

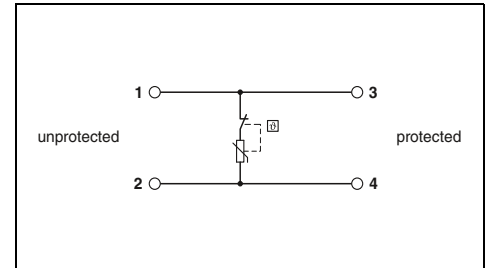
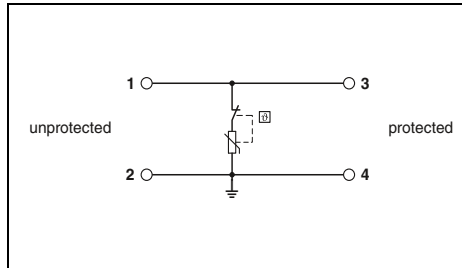

Technical data

	Technical data			
	... 24DC	... 48DC	... 60DC	... 120AC
IEC test classification/EN type	C1 / C2 / C3	C1 / C2 / C3	C1 / C2 / C3	C1 / C2 / C3
Maximum continuous operating voltage U_C	30 V DC / 21 V AC	60 V DC / 42 V AC	75 V DC / 53 V AC	150 V DC / 150 V AC
Rated current	10 A (60°C)	10 A (60°C)	10 A (60°C)	10 A (60°C)
Nominal discharge current I_n (8/20) μ s	-	-	-	2 kA
Protection level U_p	Core-Core	-	-	-
	Core-Ground	2 kA	2 kA	2.5 kA
Cut-off frequency f_g (3 dB)	Core-Core	-	-	-
	Core-Ground	≤ 80 V (C3 - 25 A)	≤ 150 V (C3 - 25 A)	≤ 190 V (C3 - 25 A)
Resistance per path	Symmetrical in the 150 Ω system	-	-	-
	Asymmetrical in the 150 Ω system	typ. 200 kHz 100 m Ω	typ. 650 kHz 100 m Ω	typ. 650 kHz 100 m Ω
General data				
Dimensions W/H/D	6.2 mm / 92 mm / 69.5 mm			
Connection data rigid / flexible / AWG	0.2 ... 4 mm ² / 0.2 ... 2.5 mm ² / 24 ... 12			
Temperature range	-40°C ... 85°C			
Test standards	IEC 61643-21 / EN 61643-21			

Technical data

	Technical data			
	... 24DC	... 48DC	... 60DC	... 120AC
IEC test classification/EN type	C1 / C2 / C3	C1 / C2 / C3	C1 / C2 / C3	C1 / C2 / C3
Maximum continuous operating voltage U_C	30 V DC / 21 V AC	60 V DC / 42 V AC	75 V DC / 53 V AC	150 V DC / 150 V AC
Rated current	10 A (60°C)	10 A (60°C)	10 A (60°C)	10 A (60°C)
Nominal discharge current I_n (8/20) μ s	-	-	-	2 kA
Protection level U_p	Core-Core	-	-	-
	Core-Ground	≤ 80 V (C3 - 25 A)	≤ 150 V (C3 - 25 A)	≤ 190 V (C3 - 25 A)
Cut-off frequency f_g (3 dB)	Core-Core	-	-	-
	Core-Ground	≤ 80 V (C3 - 25 A)	≤ 150 V (C3 - 25 A)	≤ 190 V (C3 - 25 A)
Resistance per path	Symmetrical in the 150 Ω system	-	-	-
	Asymmetrical in the 150 Ω system	typ. 200 kHz 100 m Ω	typ. 650 kHz 100 m Ω	typ. 650 kHz 100 m Ω
General data				
Dimensions W/H/D	6.2 mm / 92 mm / 69.5 mm			
Connection data rigid / flexible / AWG	0.2 ... 4 mm ² / 0.2 ... 2.5 mm ² / 24 ... 12			
Temperature range	-40°C ... 85°C			
Test standards	IEC 61643-21 / EN 61643-21			

Ordering data

Description	Voltage U_N	Ordering data		
		Type	Order No.	Pcs./Pkt.
TERMITRAB complete, with Push-in connection technology	24 V DC	TTC-6-MOV-C-24DC-PT-I	2906854	1
	48 V DC	TTC-6-MOV-C-48DC-PT-I	2906855	1
	60 V DC	TTC-6-MOV-C-60DC-PT-I	2906857	1
	120 V AC	TTC-6-MOV-C-120AC-PT-I	2906858	1
TERMITRAB complete, with screw connection technology	24 V DC	TTC-6-MOV-C-24DC-UT-I	2906837	1
	48 V DC	TTC-6-MOV-C-48DC-UT-I	2906838	1
	60 V DC	TTC-6-MOV-C-60DC-UT-I	2906839	1
	120 V AC	TTC-6-MOV-C-120AC-UT-I	2906840	1

Ordering data

Description	Voltage U_N	Ordering data		
		Type	Order No.	Pcs./Pkt.
TERMITRAB complete, with Push-in connection technology	24 V DC	TTC-6-MOV-D-24DC-PT-I	2906859	1
	48 V DC	TTC-6-MOV-D-48DC-PT-I	2906860	1
	60 V DC	TTC-6-MOV-D-60DC-PT-I	2906861	1
	120 V AC	TTC-6-MOV-D-120AC-PT-I	2906862	1
TERMITRAB complete, with screw connection technology	24 V DC	TTC-6-MOV-D-24DC-UT-I	2906841	1
	48 V DC	TTC-6-MOV-D-48DC-UT-I	2906842	1
	60 V DC	TTC-6-MOV-D-60DC-UT-I	2906843	1
	120 V AC	TTC-6-MOV-D-120AC-UT-I	2906844	1

Accessories

Description	Accessories		
	Type	Order No.	Pcs./Pkt.
End cover	TTC-6-LCP	2908729	50
Remote signaling set	TTC-6-FMRS-PT	2907811	1
	TTC-6-FMRS-UT	2907810	1

Accessories

Description	Accessories		
	Type	Order No.	Pcs./Pkt.
End cover	TTC-6-LCP	2908729	50
Remote signaling set	TTC-6-FMRS-PT	2907811	1
	TTC-6-FMRS-UT	2907810	1

Single-stage protective devices TERMITRAB complete

- Coarse surge protection, right at the building entrance, with an MCR cable
- Overall width of just 6.2 mm
- With Push-in or screw connection technology
- Integrated mechanical status indicator
- Optional remote signaling module monitors up to 40 items, without additional wiring



**1-conductor
with grounded reference potential**



**2-conductor,
floating**

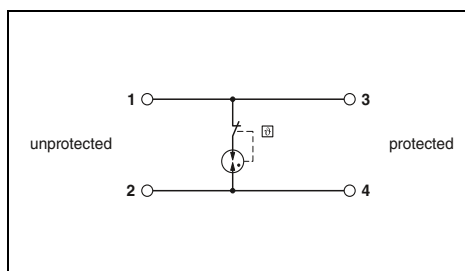
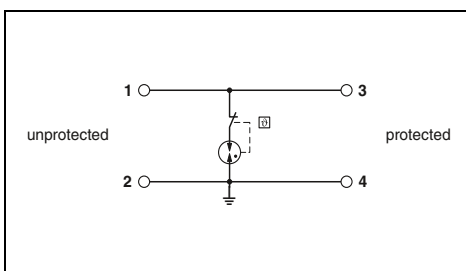

Technical data

Electrical data	... 24AC	... 110AC
IEC test classification/EN type	C1 / C2 / C3 / D1	C1 / C2 / C3 / D1
Maximum continuous operating voltage U_C	28 V DC / 36 V AC	- / 130 V AC
Rated current	1 A DC (60°C)	2 A (60°C)
Pulse discharge current I_{imp} (10/350) μ s	0.5 kA	0.5 kA
Nominal discharge current I_n (8/20) μ s	-	-
Protection level U_p	Core-Core Core-Ground	- 5 kA
Cut-off frequency f_g (3 dB)	Core-Core Core-Ground	- - ≤ 900 V (C3 - 100 A)
Resistance per path	Symmetrical in the 150 Ω system Asymmetrical in the 150 Ω system	- - typ. 25 MHz 100 m Ω
General data	Dimensions W/H/D	6.2 mm / 92 mm / 69.5 mm
Connection data rigid / flexible / AWG	Temperature range	0.2 ... 4 mm ² / 0.2 ... 2.5 mm ² / 24 ... 12 -40°C ... 85°C
Test standards		IEC 61643-21 / EN 61643-21

Technical data

Electrical data	... 24AC	... 60AC
IEC test classification/EN type	C1 / C2 / C3 / D1	C1 / C2 / C3 / D1
Maximum continuous operating voltage U_C	28 V DC / 30 V AC	- / 75 V AC
Rated current	1 A DC (60°C)	2 A (60°C)
Pulse discharge current I_{imp} (10/350) μ s	-	-
Nominal discharge current I_n (8/20) μ s	-	-
Protection level U_p	Core-Core Core-Ground	5 kA - ≤ 800 V (C3 - 25 A)
Cut-off frequency f_g (3 dB)	Core-Core Core-Ground	- - ≤ 800 V (C3 - 25 A)
Resistance per path	Symmetrical in the 150 Ω system Asymmetrical in the 150 Ω system	- - typ. 25 MHz 100 m Ω
General data	Dimensions W/H/D	6.2 mm / 92 mm / 69.5 mm
Connection data rigid / flexible / AWG	Temperature range	0.2 ... 4 mm ² / 0.2 ... 2.5 mm ² / 24 ... 12 -40°C ... 85°C
Test standards		IEC 61643-21 / EN 61643-21

Ordering data

Description	Voltage U_N
TERMITRAB complete, with Push-in connection technology	
	24 V AC
	60 V AC
	110 V AC
TERMITRAB complete, with screw connection technology	
	24 V AC
	60 V AC
	110 V AC

Type	Order No.	Pcs./Pkt.
TTC-6-GDT-C-24AC-PT-I	2906860	1
TTC-6-GDT-C-110AC-PT-I	2906861	1
TTC-6-GDT-C-24AC-UT-I	2906842	1
TTC-6-GDT-C-110AC-UT-I	2906844	1

Ordering data

Type	Order No.	Pcs./Pkt.
TTC-6-GDT-D-24AC-PT-I	2906862	1
TTC-6-GDT-D-60AC-PT-I	2906863	1
TTC-6-GDT-D-24AC-UT-I	2906845	1
TTC-6-GDT-D-60AC-UT-I	2906846	1

Accessories

End cover	Remote signaling set
	Push-in connection technology
	Screw connection technology

Type	Order No.	Pcs./Pkt.
TTC-6-LCP	2908729	50
TTC-6-FMRS-PT	2907811	1
TTC-6-FMRS-UT	2907810	1

Accessories

Type	Order No.	Pcs./Pkt.
TTC-6-LCP	2908729	50
TTC-6-FMRS-PT	2907811	1
TTC-6-FMRS-UT	2907810	1

Surge protection and interference filters

Surge protection for measurement and control technology

Potentially explosive applications TERMITRAB complete

- One-piece or pluggable surge protection
- Tailored to the special requirements of intrinsically safe circuits
- Overall width of just 6.2 mm
- With screw connection technology
- Integrated mechanical status indicator
- With knife disconnection
- Impedance-neutral insertion and removal
- Coded plug versions
- Plugs can be tested with CHECKMASTER 2

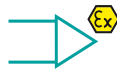

Double wire (loop), floating, intrinsically safe, one-piece, e.g., for 4 ... 20 mA current loop



Double wire (loop), floating, intrinsically safe, pluggable, e.g., for 4 ... 20 mA current loop

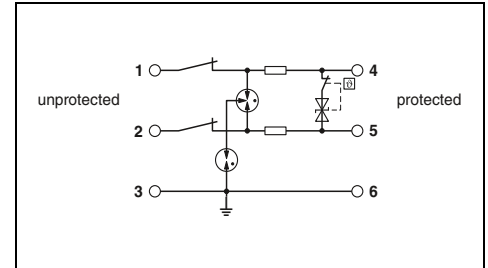
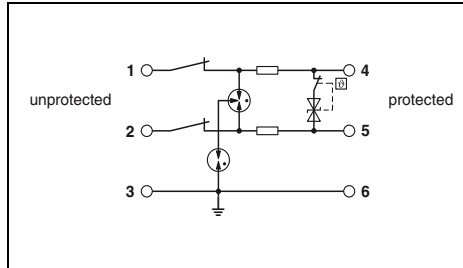

Technical data

Electrical data	... 24DC
IEC test classification/EN type	C1 / C2 / C3 / D1
Maximum continuous operating voltage U_C	30 V DC
Rated current	600 mA (40°C)
Pulse discharge current I_{imp} (10/350) μ s	0.5 kA
Nominal discharge current I_n (8/20) μ s	
	Core-Core 5 kA
	Core-Ground 5 kA
Total discharge current I_{total} (8/20) μ s	10 kA
Protection level U_p	
	Core-Core ≤ 55 V (C3 - 100 A)
	Core-Ground ≤ 1.4 kV (C3 - 100 A)
Cut-off frequency f_g (3 dB)	typ. 940 kHz
	Symmetrical in the 150 Ω system 1.65 Ω
Resistance per path	
General data	
Dimensions W/H/D	6.2 mm / 105.8 mm / 83.5 mm
Connection data rigid / flexible / AWG	0.2 ... 4 mm ² / 0.2 ... 2.5 mm ² / 24 ... 12
Temperature range	-40°C ... 85°C
Test standards	EN 60079-0 / EN 60079-11 / EN 61643-21 / IEC 60079-0 / IEC 60079-11 / IEC 61643-21
Safety data	
EC-type examination certificate in accordance with ATEX	BVS 16 ATEX E 125 X
Maximum inner capacity C_i	negligible
Maximum inner inductance L_i	negligible
Maximum input current I_i	400 mA (T4 / $\leq 50^\circ$ C)
Maximum input voltage U_i	30 V DC
Maximum input power P_i	-

Electrical data	... 24DC
IEC test classification/EN type	C1 / C2 / C3 / D1
Maximum continuous operating voltage U_C	30 V DC
Rated current	600 mA (40°C)
Pulse discharge current I_{imp} (10/350) μ s	0.5 kA
Nominal discharge current I_n (8/20) μ s	
	5 kA
	5 kA
Total discharge current I_{total} (8/20) μ s	10 kA
Protection level U_p	
	≤ 55 V (C3 - 100 A)
	≤ 1.4 kV (C3 - 100 A)
Cut-off frequency f_g (3 dB)	typ. 940 kHz
	1.65 Ω
Resistance per path	
General data	
Dimensions W/H/D	6.2 mm / 105.8 mm / 100 mm
Connection data rigid / flexible / AWG	0.2 ... 4 mm ² / 0.2 ... 2.5 mm ² / 24 ... 12
Temperature range	-40°C ... 85°C
Test standards	EN 60079-0 / EN 60079-11 / EN 61643-21 / IEC 60079-0 / IEC 60079-11 / IEC 61643-21
Safety data	
EC-type examination certificate in accordance with ATEX	BVS 16 ATEX E 125 X
Maximum inner capacity C_i	negligible
Maximum inner inductance L_i	negligible
Maximum input current I_i	400 mA (T4 / $\leq 50^\circ$ C)
Maximum input voltage U_i	30 V DC
Maximum input power P_i	-

Ordering data

Description	Voltage U_N
TERMITRAB complete , with screw connection technology	
With knife disconnection	24 V DC
Without knife disconnection	24 V DC

Type	Order No.	Pcs./Pkt.
TTC-6-1X2-M-EX-24DC-UT-I	2906820	1

Ordering data

Type	Order No.	Pcs./Pkt.
TTC-6P-1X2-M-EX-24DC-UT-I	2906824	1
TTC-6P-1X2-EX-24DC-UT-I	1065312	1

Accessories

Replacement plug		
Remote signaling set		
Screw connection technology		
Separating plate		

TTC-6-FMRS-UT	2907810	1
TTC-EX-PP	1011977	10

Accessories

TTC-6P-1X2-EX-24DC-I-P	2907831	1
TTC-6-FMRS-UT	2907810	1
TTC-EX-PP	1011977	10

Potentially explosive applications PLUGTRAB PT-IQ

- Tailored to the special requirements of intrinsically safe circuits
- Multi-stage status monitoring
- Group message via supply and remote signaling module
- Multi-stage, floating remote signaling
- System supplied via DIN rail bus
- Up to 10 protection modules per supply module
- Maximum ease of maintenance, thanks to the two-piece design
- Plugs are coded
- Impedance-neutral disconnection of plug for maintenance purposes
- Base element remains an integral part of the installation
- Corresponding replacement plugs can be found on our website



Double wire (loop), floating, connection 9/10 grounded directly, e.g., for 4 ... 20 mA current loop



2 double wires (loops), floating, connection 9/10 grounded directly, e.g., for 4 ... 20 mA current loop

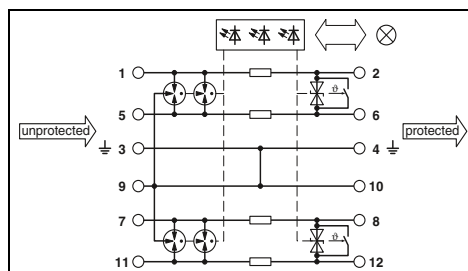
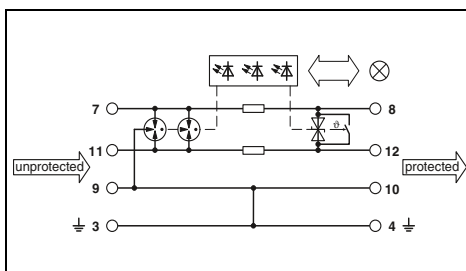

Technical data

Electrical data	
IEC test classification/EN type	... 24DC
Maximum continuous operating voltage U_C	C1 / C2 / C3 / D1
Rated current	30 V DC / 21 V AC
Pulse discharge current I_{imp} (10/350) μ s	350 mA
Nominal discharge current I_n (8/20) μ s	2 kA

Core-Core	10 kA
Core-Ground	10 kA
	20 kA

Total discharge current I_{total} (8/20) μ s	
Protection level U_p	

Core-Core	≤ 50 V
	(C3 - 25 A)
Core-Ground	≤ 1.3 kV
	(C3 - 100 A)

Cut-off frequency f_g (3 dB)	
--------------------------------	--

Symmetrical in the 150 Ω system	typ. 1.1 MHz
	1.2 Ω

Resistance per path	
---------------------	--

General data	
--------------	--

Dimensions W/H/D	17.7 mm / 91.1 mm / 77.5 mm
------------------	-----------------------------

Connection data rigid / flexible / AWG	0.2 ... 4 mm ² / 0.2 ... 2.5 mm ² / 24 ... 12
--	---

Temperature range	-40°C ... 70°C
-------------------	----------------

Test standards	EN 61643-21/A2 / IEC 61643-21/A2 / EN 61000-6-2 / EN 61000-6-3/A1
----------------	---

Technical data	
----------------	--

... 24DC	
C1 / C2 / C3 / D1	
30 V DC / 21 V AC	
350 mA	
2 kA	

10 kA	
10 kA	
20 kA	

≤ 50 V	
(C3 - 25 A)	
≤ 1.3 kV	
(C3 - 100 A)	

typ. 1.1 MHz	
1.2 Ω	

17.7 mm / 91.1 mm / 77.5 mm	
-----------------------------	--

0.2 ... 4 mm ² / 0.2 ... 2.5 mm ² / 24 ... 12	
---	--

-40°C ... 70°C	
----------------	--

EN 61643-21 / IEC 61643-21 / EN 61000-6-2 / EN 61000-6-3/A1	
---	--

Technical data	
----------------	--

... 24DC	
C1 / C2 / C3 / D1	
30 V DC / 21 V AC	
350 mA	
2 kA	

10 kA	
10 kA	
20 kA	

≤ 50 V	
(C3 - 25 A)	
≤ 1.3 kV	
(C3 - 100 A)	

typ. 1.1 MHz	
1.2 Ω	

17.7 mm / 91.1 mm / 77.5 mm	
-----------------------------	--

0.2 ... 4 mm ² / 0.2 ... 2.5 mm ² / 24 ... 12	
---	--

-40°C ... 70°C	
----------------	--

EN 61643-21 / IEC 61643-21 / EN 61000-6-2 / EN 61000-6-3/A1	
---	--

Safety data	
-------------	--

EC-type examination certificate in accordance with ATEX	BVS 14 ATEX E 020 X
---	---------------------

Maximum inner capacity C_i	negligible
------------------------------	------------

Maximum inner inductance L_i	negligible
--------------------------------	------------

Maximum input current I_i	350 mA
-----------------------------	--------

Maximum input voltage U_i	30 V DC
-----------------------------	---------

Maximum input power P_i	1.2 W
---------------------------	-------

BVS 14 ATEX E 020 X	
---------------------	--

negligible	
------------	--

negligible	
------------	--

350 mA	
--------	--

30 V DC	
---------	--

1.2 W	
-------	--

BVS 14 ATEX E 020 X	
---------------------	--

negligible	
------------	--

negligible	
------------	--

350 mA	
--------	--

30 V DC	
---------	--

1.2 W	
-------	--

Ordering data

Description	Voltage U_N
MCR-PLUGTRAB, with screw connection technology	24 V DC

Type	Order No.	Pcs./Pkt.
PT-IQ-1X2-EX-24DC-UT	2801512	1

Ordering data

Type	Order No.	Pcs./Pkt.
PT-IQ-2X2-EX-24DC-UT	2801513	1

Accessories

Replacement plug	24 V DC
PLUGTRAB, supply and remote signaling module	
Screw connection technology	

Type	Order No.	Pcs./Pkt.
PT-IQ-1X2-EX-24DC-P	2801514	1
PT-IQ-PTB-UT	2800768	1

Accessories

Type	Order No.	Pcs./Pkt.
PT-IQ-2X2-EX-24DC-P	2801515	1
PT-IQ-PTB-UT	2800768	1

Surge protection and interference filters

Surge protection for measurement and control technology

Potentially explosive applications SURGETRAB S-PT

- Arresters in hexagonal tube with various outer threads
- **S-PT-EX(I)...** installation in the signal path feed-through
- **S-PT-EX, S-PT-2xEX...** installation in a separate cable gland parallel to the signal lines



Double wire (loop), intrinsically safe, e.g., for 4 ... 20 mA current loops



Double wire (loop), floating, intrinsically safe, encapsulated, without decoupling resistance

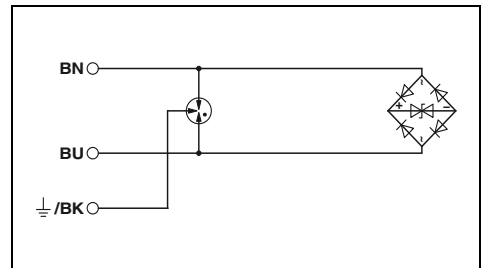
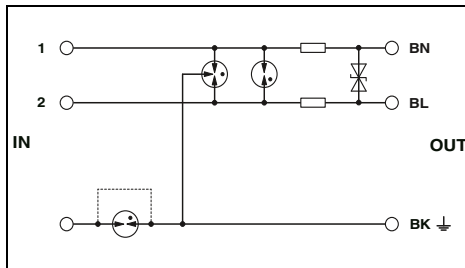

Technical data

Electrical data	... 24DC
IEC test classification/EN type	C1 / C2 / C3 / D1
Maximum continuous operating voltage U_C	30 V DC / 21 V AC
Rated current	350 mA (50°C)
Pulse discharge current I_{imp} (10/350) μ s	1 kA
Nominal discharge current I_n (8/20) μ s	10 kA
	Core-Core
	10 kA (per path)
Maximum permitted short-circuit current at installation location	350 mA
Total discharge current I_{total} (8/20) μ s	-
Max. discharge current I_{max} (8/20) μ s	10 kA (per path)
Protection level U_p	Core-Core
	≤ 50 V
	(C3 - 25 A)
	Core-Ground
	≤ 1.4 kV
	(C3 - 100 A)
Output voltage limitation at 1 kV/ μ s	Core-Core
	≤ 50 V
	Core-Ground
	≤ 1.4 kV (Direct grounding)
	2.2 Ω
Resistance per path	
General data	
Dimensions W/H/D	33.5 mm / 33.5 mm / 137 mm
Temperature range	-40°C ... 50°C
Test standards	EN 61643-21 / EN 60079-0 / EN 60079-11 / EN 60079-26 / IEC 60079-0 / IEC 60079-11
Safety data	
EC-type examination certificate in accordance with ATEX	KEMA 06ATEX0002
Maximum inner capacity C_i	2 nF
Maximum inner inductance L_i	1 μ H
Maximum input current I_i	350 mA ($T_4 / \leq 50^\circ\text{C}$)
Maximum input voltage U_i	30 V
Maximum input power P_i	3 W

Technical data

... 24DC	... 48DC
C1 / C2 / C3 / D1	C1 / C2 / C3 / D1
36 V DC / 25 V AC	53 V DC / 37 V AC
-	-
1 kA	1 kA
260 A	170 A
10 kA	10 kA
1 A (non-Ex)	1 A (non-Ex)
20 kA	20 kA
20 kA	-
≤ 65 V	≤ 90 V
(C3 - 10 A)	(C3 - 10 A)
≤ 1.1 kV	≤ 1.1 kV
(C3 - 100 A)	(C3 - 100 A)
≤ 60 V	≤ 80 V
-	-
-	-
	28 mm / 28 mm / 79 mm
	-40°C ... 80°C (non-Ex)
	EN 61643-21 / EN 60079-0 / EN 60079-1 / EN 60079-11 / EN 60079-31 / IEC 60079-0
KEMA 09ATEX0028 X	KEMA 09ATEX0028 X
1.65 nF	1.14 nF
1 μ H	1 μ H
500 mA ($T_4 / \leq 75^\circ\text{C}$)	500 mA ($T_4 / \leq 75^\circ\text{C}$)
36 V DC	53 V DC
3 W	3 W

Ordering data

Description	Voltage U_N	Type	Order No.	Pcs./Pkt.
SURGETRAB protective adapter for installation on measuring sensors for Ex protection zones				
Outer thread: M20 x 1.5	24 V DC	S-PT-EX(I)-24DC	2880671	1
Outer thread: 1/2" 14 NPT	24 V DC	S-PT-EX(I)-24DC-1/2"	2882572	1
Outer thread: 3/4" 14 NPT	24 V DC	S-PT-EX(I)-24DC-3/4"	2882585	1
Outer thread: M20 x 1.5	48 V DC			
Outer thread: 1/2" 14 NPT	48 V DC			

Ordering data

Type	Order No.	Pcs./Pkt.
S-PT-EX-24DC	2800034	1
S-PT-EX-24DC-1/2"	2800035	1
S-PT-EX-48DC	2800053	1
S-PT-EX-48DC-1/2"	2800054	1



2 double wires (loops), floating, intrinsically safe, encapsulated, without decoupling resistance

ERC

Ex:

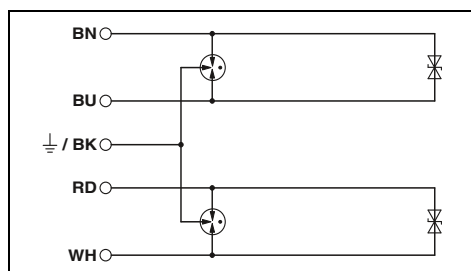

Technical data

... 24DC	... 48DC
C1 / C2 / C3 / D1	C1 / C2 / C3 / D1
36 V DC / 25 V AC	53 V DC / 37 V AC
-	-
1 kA	1 kA
260 A	170 A
10 kA	10 kA
1 A (non-Ex)	1 A (non-Ex)
20 kA	20 kA
-	-
≤ 50 V (C3 - 10 A)	≤ 80 V (C3 - 10 A)
≤ 1.1 kV (C3 - 100 A)	≤ 1.1 kV (C3 - 100 A)
≤ 50 V	≤ 80 V
-	-
-	-

28 mm / 28 mm / 79 mm

-40°C ... 80°C (non-Ex)

EN 61643-21 / EN 60079-0 / EN 60079-1 /
EN 60079-11 / EN 60079-31 / IEC 60079-0

KEMA 09ATEX0028 X	KEMA 09ATEX0028 X
1.65 nF	1.14 nF
1 μH	1 μH
500 mA (T4 / ≤ 75°C)	500 mA (T4 / ≤ 75°C)
36 V DC	53 V DC
3 W	3 W

Ordering data

Type	Order No.	Pcs./Pkt.
S-PT-2XEX-24DC	2800040	1
S-PT-2XEX-24DC-1/2"	2800041	1
S-PT-2XEX-48DC	2800038	1
S-PT-2XEX-48DC-1/2"	2800039	1

Surge protection and interference filters

Surge protection for measurement and control technology

Potentially explosive applications PLUGTRAB PT

- Tailored to the special requirements of intrinsically safe circuits
- Consistently pluggable signal circuit protection
- Maximum ease of maintenance, thanks to the two-piece design
- Base element remains an integral part of the installation
- Impedance-neutral disconnection of plug for test and maintenance purposes
- Plugs can be tested with CHECKMASTER 2



2 double wires (loops), intrinsically safe, e.g., for 4 ... 20 mA current loops



4-conductor, intrinsically safe, impedance-free, e.g., for temperature measurements

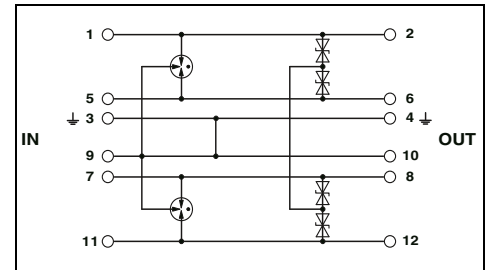
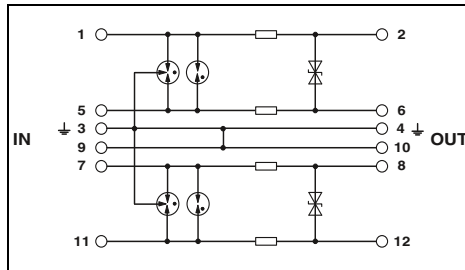

Technical data

Electrical data	
IEC test classification/EN type	
Maximum continuous operating voltage U_C	
Rated current	
Pulse discharge current I_{imp} (10/350) μ s	
Nominal discharge current I_n (8/20) μ s	
	Core-Core
	Core-Ground
Total discharge current I_{total} (8/20) μ s	
Max. discharge current I_{max} (8/20) μ s	
Protection level U_p	
	Core-Core
	Core-Ground
Output voltage limitation at 1 kV/ μ s	
	Core-Core
	Core-Ground
Cut-off frequency f_g (3 dB)	
	Symmetrical in the 50 Ω system
Resistance per path	
General data	
Dimensions W/H/D	
Connection data rigid / flexible / AWG	
Temperature range	
Test standards	
Safety data	
EC-type examination certificate in accordance with ATEX	
Maximum inner capacity C_i	
Maximum inner inductance L_i	
Maximum input current I_i	
Maximum input voltage U_i	
Maximum input power P_i	

C1 / C2 / C3 / D1	10 kA
30 V DC / 21 V AC	10 kA
325 mA (40°C)	20 kA
2 kA	20 kA (in total)
	308 A
	10 kA
	20 kA
	20 kA (in total)
	≤ 50 V
	(C3 - 25 A)
	≤ 1 kV
	(C2 - 10 kV / 5 kA)
	≤ 45 V
	≤ 1 kV
	typ. 4.5 MHz
	2.2 Ω
	17.5 mm / 44.8 mm / 51.7 mm
	0.2 ... 4 mm ² / 0.2 ... 2.5 mm ² / 24 ... 12
	-40°C ... 85°C
	EN 61643-21 / EN 60079-0 / EN 60079-11 / EN 60079-26 / IEC 61643-21 / IEC 60079-0
	KEMA 00ATEX1099 X
	1.3 nF
	1 μ H
	325 mA (T4 / $\leq 80^\circ$ C)
	30 V DC
	3 W

Technical data

C1 / C2 / C3 / D1	308 A
30 V DC / 21 V AC	10 kA
500 mA (40°C)	20 kA
1 kA	20 kA (in total)
	≤ 50 V
	(C3 - 25 A)
	≤ 1 kV
	(C2 - 10 kV / 5 kA)
	≤ 45 V
	≤ 1 kV
	typ. 7 MHz
	0 Ω
	17.7 mm / 45 mm / 52 mm
	0.2 ... 4 mm ² / 0.2 ... 2.5 mm ² / 24 ... 12
	-40°C ... 85°C
	EN 61643-21 / EN 60079-0 / EN 60079-11 / EN 60079-26 / IEC 61643-21 / IEC 60079-0
	KEMA 00ATEX1099 X
	1.1 nF
	1 μ H
	500 mA (T4 / $\leq 80^\circ$ C)
	30 V DC
	850 mW (T4 / $\leq 80^\circ$ C)

Ordering data

Description	Voltage U_N
PLUGTRAB plug, with protective circuit for plugging into base element PT	24 V DC
PLUGTRAB base element, for mounting on NS 35	24 V DC

Type	Order No.	Pcs./Pkt.
PT 2XEX(I)-24DC-ST	2838225	10
PT 2XEX(I)-BE	2839279	10

Ordering data

Type	Order No.	Pcs./Pkt.
PT 4-EX(I)-24DC-ST	2839253	10
PT 4-EX(I)-BE	2839486	10

Accessories

Shield fast connection
For \varnothing 3-6 mm
For \varnothing 5-10 mm

SSA 3-6	2839295	10
SSA 5-10	2839512	10

Accessories

SSA 3-6	2839295	10
SSA 5-10	2839512	10

Potentially explosive applications TERMITRAB complete

- One-piece or pluggable surge protection
- Tailored to the special requirements of intrinsically safe circuits
- Overall width of just 6.2 mm
- With screw connection technology
- Integrated mechanical status indicator
- With knife disconnection
- Impedance-neutral insertion and removal
- Coded plug versions
- Plugs can be tested with CHECKMASTER 2



2-conductor with common reference potential, intrinsically safe, one-piece



2-conductor with common reference potential, intrinsically safe, pluggable



Ex:



Ex:

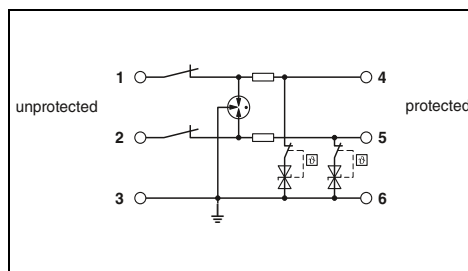
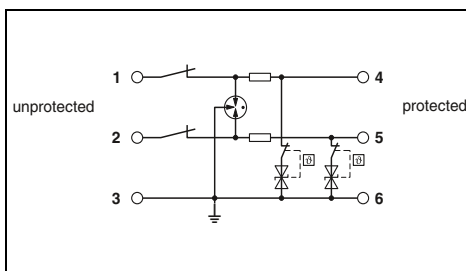

Technical data

Technical data

Electrical data	
IEC test classification/EN type	C1 / C2 / C3 / D1
Maximum continuous operating voltage U_C	30 V DC
Rated current	600 mA (40°C)
Pulse discharge current I_{imp} (10/350) μ s	0.5 kA
Nominal discharge current I_n (8/20) μ s	-

Technical data	
IEC test classification/EN type	C1 / C2 / C3 / D1
Maximum continuous operating voltage U_C	30 V DC
Rated current	600 mA (40°C)
Pulse discharge current I_{imp} (10/350) μ s	0.5 kA
Nominal discharge current I_n (8/20) μ s	-

Technical data	
IEC test classification/EN type	C1 / C2 / C3 / D1
Maximum continuous operating voltage U_C	30 V DC
Rated current	600 mA (40°C)
Pulse discharge current I_{imp} (10/350) μ s	0.5 kA
Nominal discharge current I_n (8/20) μ s	-

General data	
Total discharge current I_{total} (8/20) μ s	Core-Core 5 kA
Protection level U_p	Core-Ground 10 kA

General data	
Total discharge current I_{total} (8/20) μ s	Core-Core 5 kA
Protection level U_p	Core-Ground 10 kA

General data	
Total discharge current I_{total} (8/20) μ s	Core-Core 5 kA
Protection level U_p	Core-Ground 10 kA

Cut-off frequency f_g (3 dB)	Symmetrical in the 150 Ω system	-
Resistance per path		1.65 Ω

Cut-off frequency f_g (3 dB)	Symmetrical in the 150 Ω system	-
Resistance per path		1.65 Ω

Cut-off frequency f_g (3 dB)	Symmetrical in the 150 Ω system	-
Resistance per path		1.65 Ω

General data	
Dimensions W/H/D	6.2 mm / 105.8 mm / 83.5 mm
Connection data rigid / flexible / AWG	0.2 ... 4 mm ² / 0.2 ... 2.5 mm ² / 24 ... 12
Temperature range	-40°C ... 85°C
Test standards	EN 60079-0 / EN 60079-11 / EN 61643-21 / IEC 60079-0 / IEC 60079-11 / IEC 61643-21

General data	
Dimensions W/H/D	6.2 mm / 105.8 mm / 83.5 mm
Connection data rigid / flexible / AWG	0.2 ... 4 mm ² / 0.2 ... 2.5 mm ² / 24 ... 12
Temperature range	-40°C ... 85°C
Test standards	EN 60079-0 / EN 60079-11 / EN 61643-21 / IEC 60079-0 / IEC 60079-11 / IEC 61643-21

General data	
Dimensions W/H/D	6.2 mm / 105.8 mm / 100 mm
Connection data rigid / flexible / AWG	0.2 ... 4 mm ² / 0.2 ... 2.5 mm ² / 24 ... 12
Temperature range	-40°C ... 85°C
Test standards	EN 60079-0 / EN 60079-11 / EN 61643-21 / IEC 60079-0 / IEC 60079-11 / IEC 61643-21

Safety data	
EC-type examination certificate in accordance with ATEX	BVS 16 ATEX E 125 X
Maximum inner capacity C_i	negligible
Maximum inner inductance L_i	negligible
Maximum input current I_i	400 mA ($T_4 / \leq 50^\circ\text{C}$)
Maximum input voltage U_i	30 V DC
Maximum input power P_i	-

Safety data	
EC-type examination certificate in accordance with ATEX	BVS 16 ATEX E 125 X
Maximum inner capacity C_i	negligible
Maximum inner inductance L_i	negligible
Maximum input current I_i	400 mA ($T_4 / \leq 50^\circ\text{C}$)
Maximum input voltage U_i	30 V DC
Maximum input power P_i	-

Safety data	
EC-type examination certificate in accordance with ATEX	BVS 16 ATEX E 125 X
Maximum inner capacity C_i	negligible
Maximum inner inductance L_i	negligible
Maximum input current I_i	400 mA ($T_4 / \leq 50^\circ\text{C}$)
Maximum input voltage U_i	30 V DC
Maximum input power P_i	-

Ordering data

Ordering data

Description	Voltage U_N
TERMITRAB complete, with screw connection technology	
	24 V DC

Type	Order No.	Pcs./Pkt.
TTC-6-2X1-M-EX-24DC-UT-I	2906821	1

Type	Order No.	Pcs./Pkt.
TTC-6P-2X1-M-EX-24DC-UT-I	2906825	1

Accessories

Accessories

Replacement plug	
Remote signaling set	
Screw connection technology	
Separating plate	

Type	Order No.	Pcs./Pkt.
TTC-6-FMRS-UT	2907810	1
TTC-EX-PP	1011977	10

Type	Order No.	Pcs./Pkt.
TTC-6P-2X1-EX-24DC-I-P	2907832	1
TTC-6-FMRS-UT	2907810	1
TTC-EX-PP	1011977	10

Surge protection and interference filters

Surge protection for measurement and control technology

Potentially explosive applications TERMITRAB complete

- Pluggable surge protection
- Tailored to the special requirements of intrinsically safe circuits
- Overall width of just 6.2 mm
- Impedance-neutral insertion and removal
- Coded plug versions
- Plugs can be tested with CHECKMASTER 2



3-conductor, intrinsically safe, impedance-free, e.g., for temperature measurements

Ex:

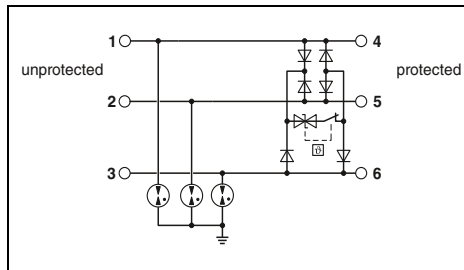

Technical data

Electrical data		
IEC test classification/EN type		C1 / C2 / C3 / D1
Maximum continuous operating voltage U_C		30 V DC
Rated current		5 A (55°C)
Pulse discharge current I_{imp} (10/350) μ s		0.5 kA
Nominal discharge current I_n (8/20) μ s		
	Core-Core	0.5 kA
	Core-Ground	5 kA
		10 kA
Total discharge current I_{total} (8/20) μ s		
Protection level U_p		
	Core-Core	≤ 68 V (C1 - 1 kV/500 A)
	Core-Ground	≤ 700 V (C1 - 1 kV/500 A)
Cut-off frequency f_g (3 dB)		typ. 60 MHz
	Symmetrical in the 150 Ω system	0.1 Ω
Resistance per path		
General data		
Dimensions W/H/D		6.2 mm / 105.8 mm / 100 mm
Connection data rigid / flexible / AWG		0.2 ... 4 mm ² / 0.2 ... 2.5 mm ² / 24 ... 12
Temperature range		-40°C ... 85°C
Test standards		EN 60079-0 / EN 60079-11 / EN 61643-21 / IEC 60079-0 / IEC 60079-11 / IEC 61643-21
Safety data		
EC-type examination certificate in accordance with ATEX		BVS 16 ATEX E 125 X
Maximum inner capacity C_i		negligible
Maximum inner inductance L_i		negligible
Maximum input current I_i		400 mA ($T_4 / \leq 50^\circ\text{C}$)
Maximum input voltage U_i		30 V DC
Maximum input power P_i		-

Ordering data

Description	Voltage U_N	Type	Order No.	Pcs./Pkt.
TERMITRAB complete, with screw connection technology	24 V DC	TTC-6P-3-EX-24DC-UT-I	1064665	1

Accessories

Replacement plug	TTC-6P-3-EX-24DC-I-P	1064663	1
Remote signaling set	TTC-6-FMRS-UT	2907810	1
Separating plate	TTC-EX-PP	1011977	10

Potentially explosive applications
SURGETRAB S-PT

- Arresters in hexagonal tube with various outer threads
- **S-PT-4-EX** installation in a separate cable gland parallel to the signal cables
- **S-PT-EX...** devices are approved for Ex i and Ex d measuring probes



4-conductor with common reference potential, intrinsically safe, encapsulated, without decoupling resistance

ERC
Ex: IEC

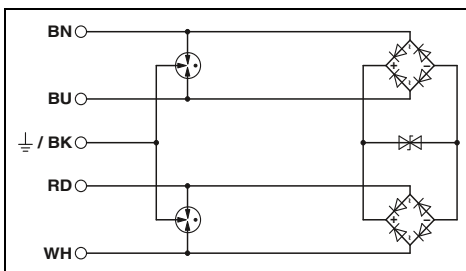

Technical data

Electrical data		
IEC test classification/EN type		C1 / C2 / C3 / D1
Maximum continuous operating voltage U_C		36 V DC / 25 V AC
Pulse discharge current I_{imp} (10/350) μ s		1 kA
Nominal discharge current I_n (8/20) μ s		
	Core-Core	260 A
	Core-Ground	10 kA
Maximum permitted short-circuit current at installation location		1 A (non-Ex)
Total discharge current I_{total} (8/20) μ s		20 kA
Max. discharge current I_{max} (8/20) μ s		-
Protection level U_p		
	Core-Core	≤ 65 V (C3 - 10 A)
	Core-Ground	≤ 1.1 kV (C3 - 100 A)
Output voltage limitation at 1 kV/ μ s		
	Core-Core	≤ 60 V
	Core-Ground	-
General data		
Dimensions W/H/D		28 mm / 28 mm / 79 mm
Temperature range		-40°C ... 80°C (non-Ex)
Test standards		EN 61643-21 / EN 60079-0 / EN 60079-1 / EN 60079-11 / EN 60079-31 / IEC 60079-0
Safety data		
EC-type examination certificate in accordance with ATEX		KEMA 09ATEX0028 X
Maximum inner capacity C_i		1.65 nF
Maximum inner inductance L_i		1 μ H
Maximum input current I_i		500 mA ($T_4 \leq 75^\circ\text{C}$)
Maximum input voltage U_i		36 V DC
Maximum input power P_i		3 W

Ordering data

Description	Voltage U_N	Type	Order No.	Pcs./Pkt.
SURGETRAB protective adapter for installation on measuring sensors for Ex protection zones				
Outer thread: M20 x 1.5	24 V DC	S-PT-4-EX-24DC	2800036	1
Outer thread: 1/2" 14 NPT	24 V DC	S-PT-4-EX-24DC-1/2"	2800037	1



Low signal levels at high frequencies require special protective circuits in data processing and telecommunications. The arresters must guarantee short response times to quickly limit the surge voltages to safe values, without impairing signal quality. In addition, the protective devices support system-specific connections, such as RJ45 or D-SUB connectors, and all types of network topology.

DATATRAB DT – The all-round solution for protecting data interfaces

DATATRAB DT reliably protects high-speed networks against damage caused by surge voltages. DT-LAN-CAT.6+ supports various data protocols at very high transmission speeds, such as Ethernet, Power over Ethernet (PoE), ISDN, token ring, and DS1, in a single device.

The housing has a ground connection snap-on foot into which the ground connection cover with equipotential bonding cable is inserted. DATATRAB can be therefore used either as an adapter or a DIN rail module after removing the ground connection cover.

i Your web code: [#0145](#)

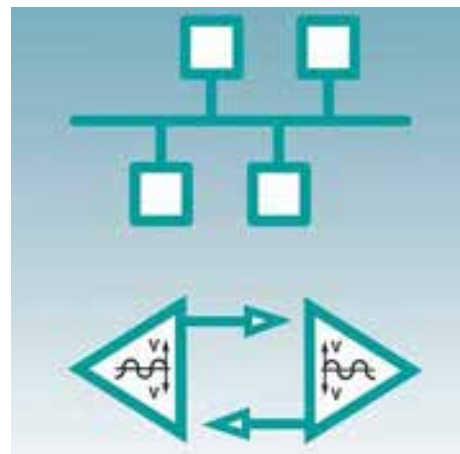

Versatile

The DATATRAB product range can offer a suitable protective device for many and varied applications. The protective devices are simply installed between the signal paths with interfaces for RJ11/12, RJ45, D-SUB, or screw connection.

Speed

Used in EDP systems with a transmission speed of up to 10 Gbps (CAT6/CLASS E₂) and in telecommunications networks with 50 Mbps (VDSL).

Use

Protective devices suitable for all common applications including Ethernet, token ring, ISDN, DS1, DSL, analog telecommunications, RS-485, V.24, V.11, etc. are available.

The circuit breakers also support Power over Ethernet (PoE+) in Mode A and B versions.



The narrowest surge protection

Starting from a width of 3.5 mm, TERMITRAB complete is the world's narrowest surge protection solution for MCR and fieldbus applications.

COMTRAB modular

For protecting telecommunications systems

- Direct insertion in LSA-PLUS marshaling panels
- Coarse protection magazines with gas-filled surge arrester
- Modular miniature connectors with combined coarse and fine protection elements for optimum protection

Other designs

Other application-specific protective devices include:

- Two-piece pluggable protective devices in the PLUGTRAB product range
- Combined adapters for the power supply and MAINTRAB interfaces

Surge protection and interference filters

Surge protection for information technology and telecommunications









Selection guide

Explanation of the IEC categories		
LPZ zone	Test category for SPD in acc. with IEC 61643-21	Test class for SPD in acc. with IEC 61643-11
0/1	D1	I
1/2	C2	II
2/3	C1	III

Interface-based product selection for surge protection

The STOP-IT (Selection of Protection for Information Technology) selection guide provides support in choosing your surge protection solution for a variety of additional interfaces in information and MCR technology.











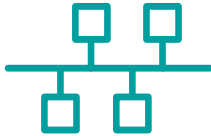











































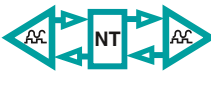

i Your web code: #2079

	DIN rail mounting
	Push-in connection
	Screw connection
	Schuko plug-in connection
	RJ45 plug-in connection
	RJ12 plug-in connection
	TAE plug-in connection
	Coaxial plug-in connection
	D-SUB plug-in connection
1)	Also available with screw connection technology



Note

Products bearing this stamp (plug elements) can be tested with CHECKMASTER 2.

Technology	Interface	Mounting type/ connection method	
	CAN bus/CANopen®	 	
	DeviceNet™	 	
	Ethernet	  	
	Gigabit Ethernet (1/10 GBase-T)	  	
	FOUNDATION Fieldbus H1	 	
	FOUNDATION Fieldbus Ex (i)	 	
	INTERBUS Inline (analog I/Os)	  1)	
	INTERBUS Inline (digital I/Os)	  1)	
	INTERBUS remote bus	 	
	LON (Works)	  1)	
	PROFIBUS DP (FMS)	  1)	
	PROFIBUS PA (FMS)	 	
	PROFINET	 	
	RS-422A, V.11, X.27, RS-423A	  1)	
	RS-485	  1)	
	RS-232-C/V.24	   1)	
	TTY, 0(4) - 20 mA	 1)	
		ADSL 2+, T-DSL- HDSL, VDSL, analog phone	  1) LSA
		DSL broadband (coax)	 
		ISDN (S ₀ and S _{2M} bus)	 LSA  
		ISDN (U _{k0})	  / 
		ISDN (U _{k0})	 LSA  / 
		SHDSL	  / 

IEC category	Protected wires	Surge protective device (SPD)	Order No.	Page
D1/C2/C1	3	PT-IQ-3-HF-12DC-UT	2800786	176
T3	2	PLT-SEC-T3-24-FM-UT	2905223	82
D1/C2/C1	3	PT-IQ-3-HF-12DC-UT	2800786	176
T3	2	PLT-SEC-T3-24-FM-UT	2905223	82
D1/C2/C1	8	DT-LAN-CAT.6+	2881007	166
C2/C1	24 x 8	D-LAN-19"-24	2838791	167
D1/C2/C1	8	DT-LAN-CAT.6+	2881007	166
D1/C2/C1	4	PT 2X2-FF-ST + PT 4-BE	2800755 + 2839402	185
D1/C2/C1	2	TTC-6P-1X2-M-EX-24DC-UT-I	2906824	152
T3	2	PLT-SEC-T3-24-FM-UT	2905223	82
D1/C2/C1	4	PT-IQ-2X2-24DC-PT	2801263	121
D1/C2/C1	5	PT-IQ-4X1-24DC-PT	2801271	133
D1/C2/C1	5	DT-UFB-IB-RBI	2800055	183
	5	DT-UFB-IB-RB0	2800056	183
D1/C2/C1	2	PT-IQ-1X2-48DC-PT	2801257	120
D1/C2/C1	3	TTC-6P-3-HF-M-12DC-PT-I	2906756	171
		PT-IQ-3-PB-PT	2801286	172
C1	2	D-UFB-PB	2880642	179
D1/C2/C1	2	TTC-6P-3-HF-F-M-EX-24DC-UT-I	2906828	181
	4	PT 4-EX(I)-24DC-ST + PT 4-EX(I)-BE	2839253 + 2839486	156
D1/C2/C1	8	DT-LAN-CAT.6+	2881007	166
D1/C2/C1	5	PT-IQ-5-HF+F-12DC-PT	2801295	173
D1/C2/C1	3	TTC-6P-3-HF-F-M-12DC-PT-I	2906796	169
	5	PT-IQ-5-HF+F-12DC-PT	2801295	173
D1/C2/C1	5	DT-UFB-485/BS	2920612	173
C2/C1	9	DT-UFB-V24/S-9-SB	2803069	168
D1/C2/C1	3	TTC-6P-3-HF-F-M-12DC-PT-I	2906796	169
D1/C2/C1	4	PT-IQ-2X2-24DC-PT	2801263	121
D1/C2/C1	4	DT-TELE-RJ45	2882925	186
D1/C2/C1	2	PT-IQ-1X2-TELE-PT	2801290	187
D1/C2/C1	2	CTM 1X2-110AC + CTM 10-MAG	2838539 + 2838610	190
D1/C2/C1	4	TAE-TRAB FM-NFN-AP	2749628	189
D1/C2/C1 & T3	2	MNT-TEL... / MNT-TAE	2882404 / 2882394	89
D1/C2/C1	2	C-TV-SAT	2856993	205
D1/C2/C1 & T3	2	MNT-TV-SAT D/WH	2882297	89
D1/C2/C1	2 x 2	CTM ISDN (2x) + CTM 10-MAG	2838555 + 2838610	191
D1/C2/C1	4	DT-LAN-CAT.6+	2881007	166
D1/C2/C1	4	DT-TELE-RJ45	2882925	186
D1/C2/C1	2	PT 2-TELE	2882828	188
D1/C2/C1	2	CTM 1X2-110AC + CTM 10-MAG	2838539 + 2838610	190
D1/C2/C1 & T3	2	MNT-TEL... / MNT-TAE	2882404 / 2882394	89
D1/C2/C1	4	DT-TELE-SHDSL	2801593	186

Surge protection and interference filters

Surge protection for information technology and telecommunications

Protection of PROFIBUS DP

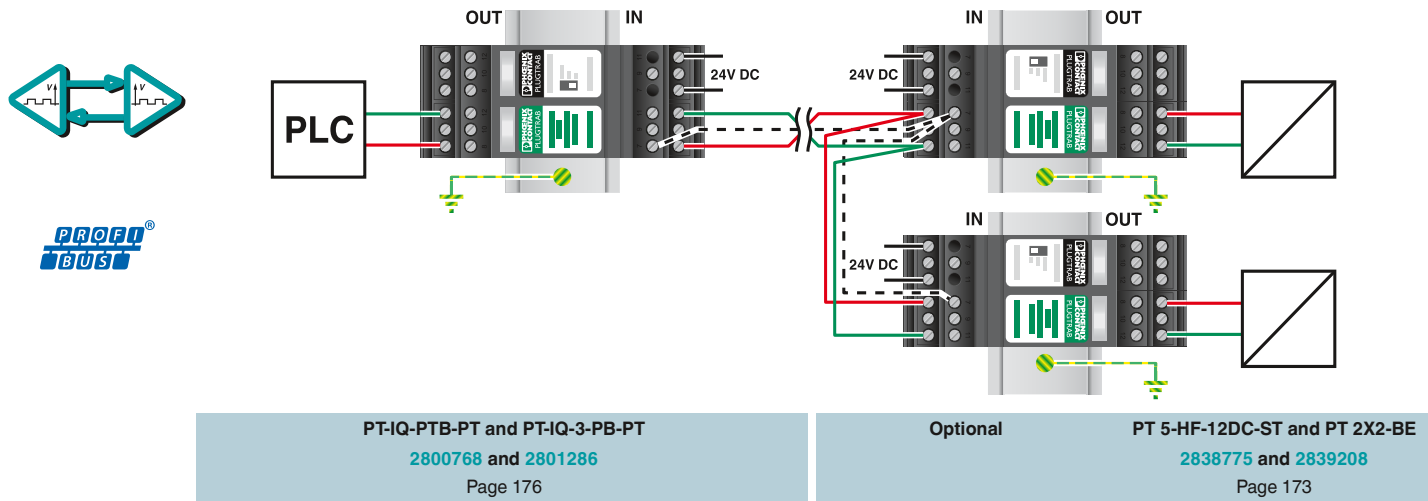

Protection of PROFIBUS PA

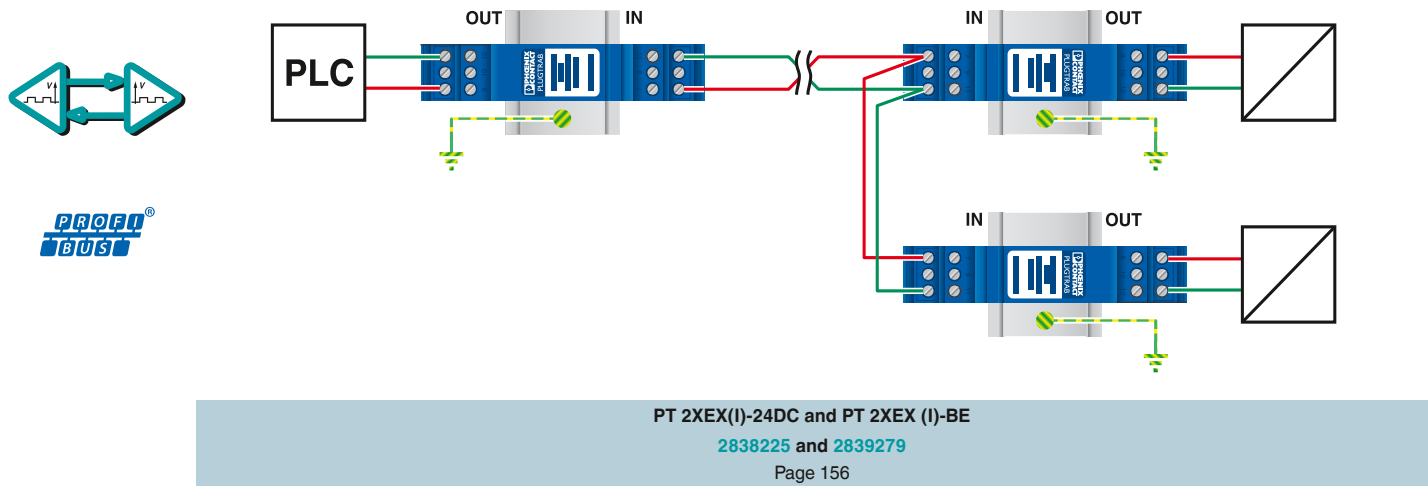

Protection of CANopen®/DeviceNet™

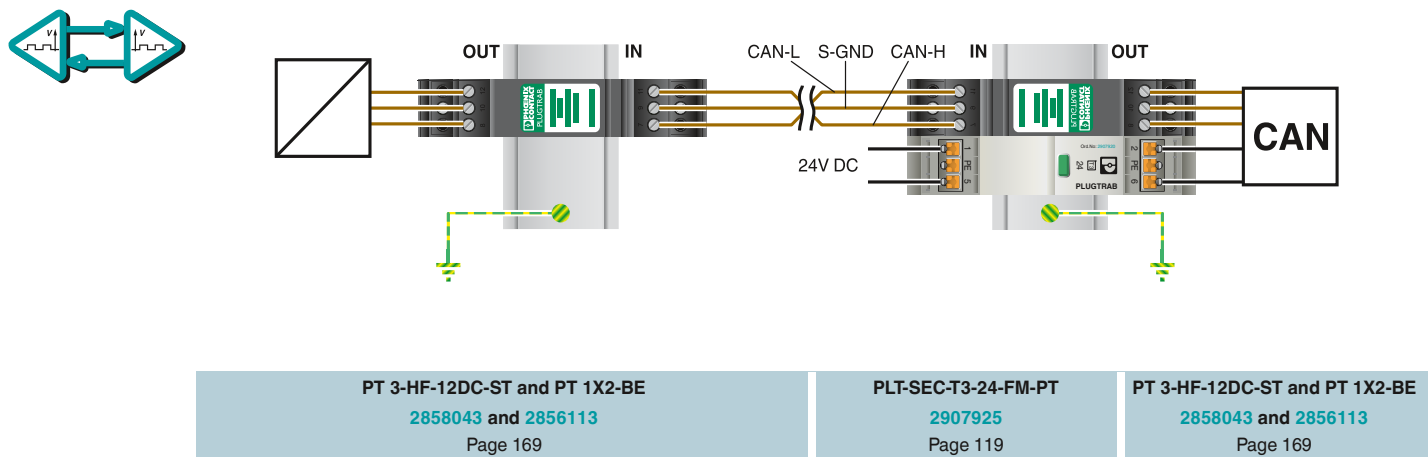

Protection of an RS-485 interface

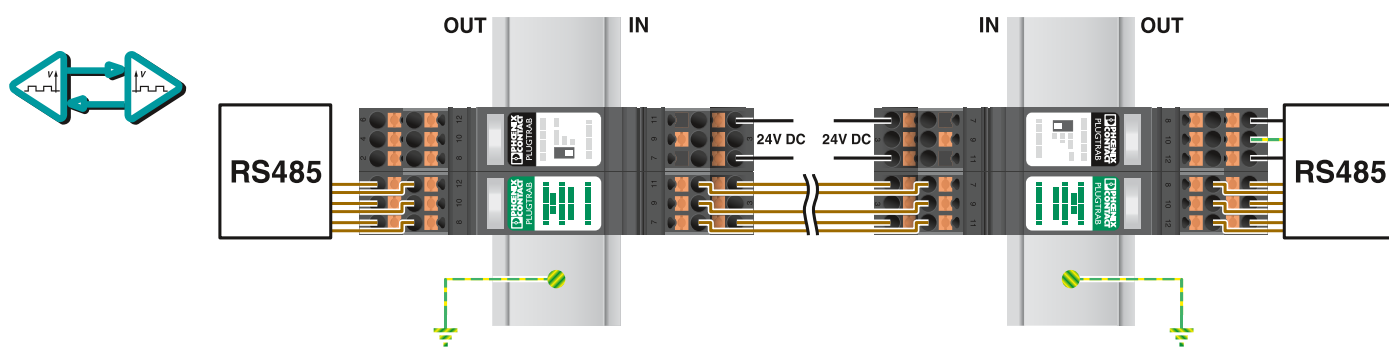

PT-IQ-PTB-PT and PT-IQ-5-HF+F-12DC-PT
 2801296 and 2801295
 Page 173

Optional PT 5-HF-12DC-ST and PT 2X2+F-BE
 2838775 and 2839224
 Page 173

Protection of an Ethernet interface (including PoE)

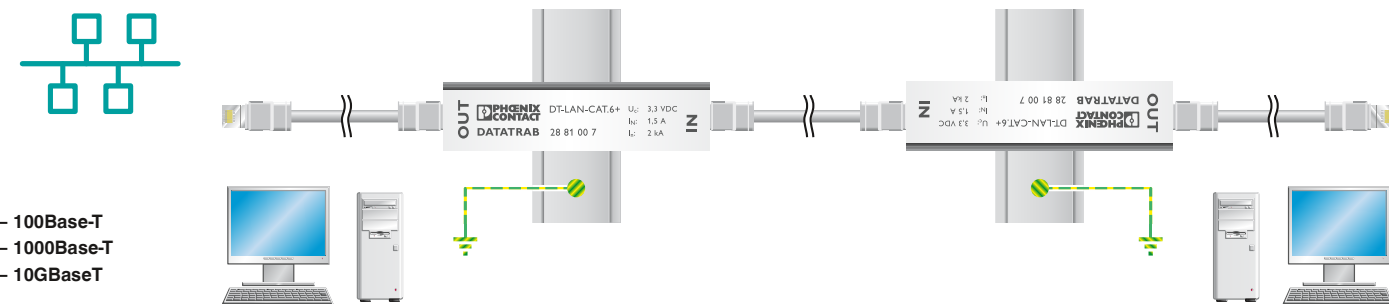

- 100Base-T
- 1000Base-T
- 10GBase-T

DT-LAN-CAT.6+
 2881007
 Page 166

Protection of a DSL interface

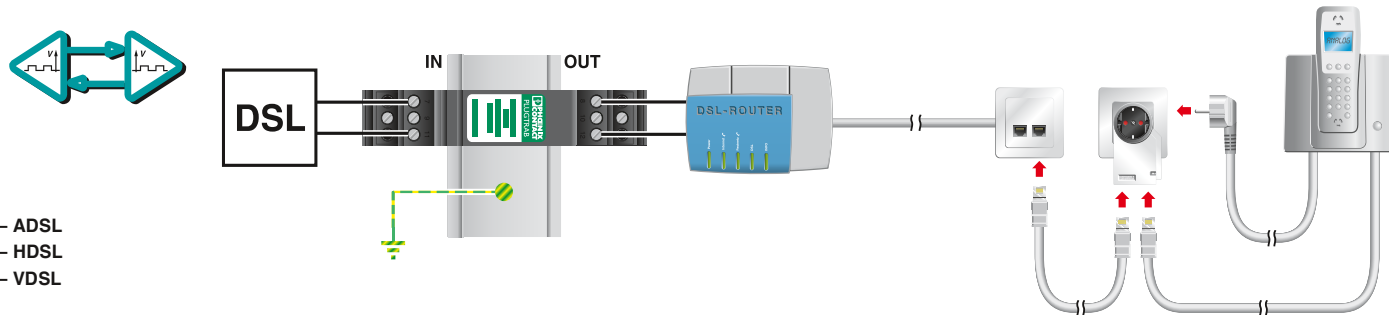

- ADSL
- HDSL
- VDSL

PT 2-TELE
 2882828
 Page 188

MNT-TAE D/WH
 2882394
 Page 88

Surge protection and interference filters

Surge protection for information technology and telecommunications

Ethernet/PROFINET networks with twisted pair cabling

DT-LAN-CAT.6+

- Suitable for category 6 high-speed data networks
- Secure data transmission up to 10 Gbps
- Protective adapter for eight signal paths via RJ45 connector
- Can be installed in a control cabinet by removing a ground connection adapter

D-LAN-CAT.5-FP

- Suitable for category 5 data networks
- Secure data transmission up to 1 Gbps
- Protective adapter for eight signal paths via RJ45 connector

D-LAN-19"

- 19" rack for installation in storey distributors
- Up to 24 ports with RJ45 connection
- Secure data transmission up to 1 Gbps
- Protection of all eight signal wires of the data cable
- Indirect grounding via a gas-filled surge arrester in the housing
- Direct grounding via a connection on the housing



For LAN interfaces (Class E_A/CAT 6) including PoE+ and ISDN S₀ protection

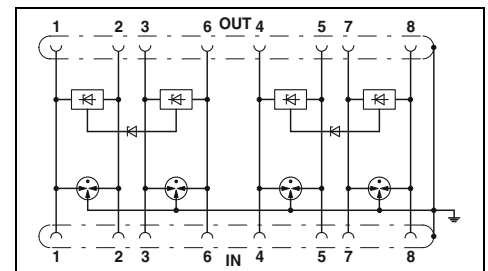

Electrical data		Technical data	
IEC test classification/EN type		B2 / C1 / C2 / C3 / D1	
Maximum continuous operating voltage U _c		≤ 1.5 A (25°C)	
Rated current		Core-Core	100 A
Nominal discharge current I _n (8/20) μs		Core-Ground	2 kA (per signal pair) 10 kA
Total discharge current I _{total} (8/20) μs		Core-Core	≤ 9 V (B2 - 1 kV / 25 A)
Protection level U _p		Core-Ground	≤ 900 V (B2 - 4 kV / 100 A)
Output voltage limitation at 1 kV/μs		Core-Core	≤ 9 V
Input attenuation aE (typical)		Core-Ground	≤ 700 V
Cut-off frequency f _g (3 dB)		≤ 1 dB (up to 100 MHz/direct measuring)	
In a 100 Ω system	Symmetrical	-	
General data		Ordering data	
Temperature range		-40°C ... 70°C	
Connection method		RJ45	
Test standards		IEC 61643-21 / EN 50173-1 / ISO/IEC 11801-Am.1	

Description		Ordering data	
DATATRAB adapter , protective adapter to be inserted into the data line		Type	Order No.
DATATRAB , for use in Ethernet, token ring, FDDI/CDDI in acc. with Cat.D/CAT5 EN 50173 (1000Base-T)		DAT-LAN-CAT.6+	2881007
	24 ports		Pcs./Pkt.
	20 ports		1
	16 ports		
	12 ports		
	8 ports		
	4 ports		
Surge protection PCB as replacement or for retrofitting in D-LAN-19" ... products, incl. RJ45 female connector			
	4 ports		



For LAN interfaces (Class D/CAT 5) including PoE+ and ISDN S₀ protection



For data interfaces, with RJ45 connection Class D/CAT5e

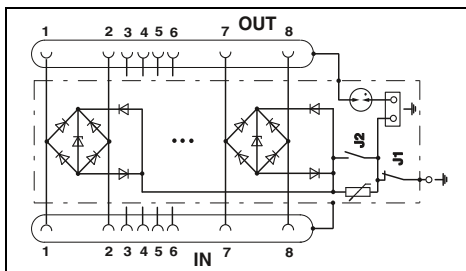
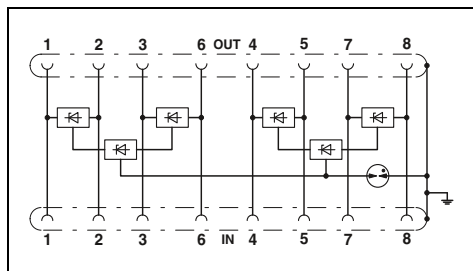

Technical data

B2 / C1
± 5 V DC
-
350 A
350 A
-
≤ 35 V (C1 - 700 V/350 A)
≤ 700 V (C1 - 700 V/350 A)
≤ 25 V
≤ 750 V
≤ 1 dB (100 MHz/100 Ω)
> 100 MHz
-40°C ... 85°C
RJ45
IEC 61643-21/A1 / GB/T 18802.21 / EN 61643-21/A1

Technical data

C1 / C2 / C3 / B3
6 V DC
1.5 A (25°C)
350 A
350 A
10 kA
≤ 50 V (C1 - 500 V / 250 A)
≤ 40 V (C1 - 500 V / 250 A (J2 ON))
≤ 20 V
≤ 30 V (J2 plugged)
typ. 1 dB (≤ 100 MHz)
> 100 MHz
-40°C ... 80°C
RJ45
IEC 61643-21

Ordering data

Type	Order No.	Pcs./Pkt.
D-LAN-CAT.5-FP	2800723	1

Ordering data

Type	Order No.	Pcs./Pkt.
D-LAN-19"-24	2838791	1
D-LAN-19"-20	2880134	1
D-LAN-19"-16	2880147	1
D-LAN-19"-12	2880150	1
D-LAN-19"-8	2880163	1
D-LAN-19"-4	2880176	1
D-LAN-19"-D-P	2880192	1

V.24/RS-232 interfaces

DT-UFB-V24/S

- Connection: D-SUB 9
- For data and handshake cables

Pin assignment DT-UFB-V24/S-9-SB

- 1, 2, 3, 4, 6, 7, 8, 9 Data lines
- 5 Signal ground (Ground)

PLUGTRAB PT 3-HF-12DC

- Connection: Screw terminal blocks
- For high transmission speeds
- High discharge capacity
- Plugs can be tested with CHECKMASTER 2

Pin assignment PT 3-HF-12DC:

- 7.11 Data lines
- 9 Signal ground (Ground)
- 3 \perp

Note:

PT .x.+F-BE: connections 9/10 (GND) are connected to the mounting foot via a gas-filled surge arrester.

PLUGTRAB PT-IQ 3-HF-12DC

- Connection: Push-in or screw connection technology
- For high transmission speeds
- High discharge capacity
- Multi-stage, floating remote signaling
- Group message via supply and remote signaling module

Pin assignment PT-IQ 3-HF-12DC

- 7.11 Data lines
- 9 Signal ground (Ground)
- 3 \perp

TERMITRAB complete TTC-6P-3-HF..

- Pluggable surge protection
- Overall width of just 6.2 mm
- Integrated mechanical status indicator
- Impedance-neutral insertion and removal
- Coded plug versions
- With knife disconnection
- Optional remote signaling module monitors up to 40 items, without additional wiring
- Plugs can be tested with CHECKMASTER 2

Pin assignment of TTC-6P-3-HF..

- 1,2 Data cables
- 3 Signal ground (Ground)



Protective adapter with 9-pos. D-SUB

Total width 25 mm

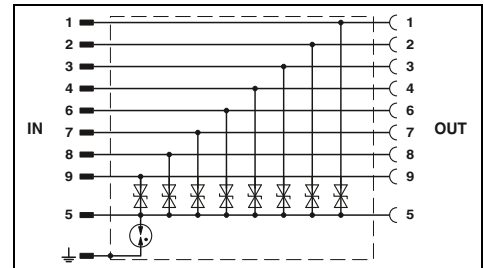

Technical data

Electrical data

IEC test classification/EN type
Maximum continuous operating voltage U_c
Rated current
Nominal discharge current I_n (8/20) μ s

Core-Ground ≤ 250 A
Core-GND ≤ 250 A

B2 / C1 / C2 / C3
15 V DC / 10 V AC
 ≤ 1 A (25°C)

Total discharge current I_{total} (8/20) μ s
Protection level U_p

Core-Core ≤ 55 V (C1 - 250 A)
Core-Ground ≤ 450 V (C1 - 250 A)

Cut-off frequency f_g (3 dB)

In a 100 Ω system
In a 100 Ω system
In a 150 Ω system
In a 150 Ω system

Symm. / asymm. (PE)
Symm. / asymm. (GND)
Symm. / asymm. (PE)
Symm. / asymm. (GND)

typ. 2.5 MHz / -
typ. 2.5 MHz / typ. 1.3 MHz
typ. 2.5 MHz / -
typ. 2.5 MHz / typ. 1.3 MHz

General data

Dimensions W/H/D
Temperature range
Connection method

25 mm / 102 mm / 63.5 mm
-40°C ... 85°C
D-SUB-9

Test standards

DIN EN 61643-21 / IEC 61643-21

Description

DATATRAB adapter, protective adapter for inserting into the data line for protecting the V.24 / RS-232 interface with D-SUB-9 connector

PLUGTRAB plug, with protective circuit for plugging into base element PT

PLUGTRAB base element, for mounting on NS 35

Gas-filled surge arrester between 3/4 (\perp) and 9/10

PLUGTRAB, consisting of a plug, base element, and DIN rail bus

Push-in connection technology
Screw connection technology

PLUGTRAB, supply and remote signaling module

Push-in connection technology
Screw connection technology

Marking material

Ordering data

Type	Order No.	Pcs./Pkt.
DT-UFB-V24/S-9-SB	2803069	1

Accessories

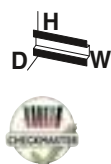

Pluggable arrester with screw connection, for three conductors, with common reference potential



3-conductor protection for fieldbus and serial interface, connection 9/10 grounded via gas-filled surge arrester



3-conductor with common reference potential, 3/6 connection grounded via gas-filled surge arrester, pluggable

Total width 17.7 mm

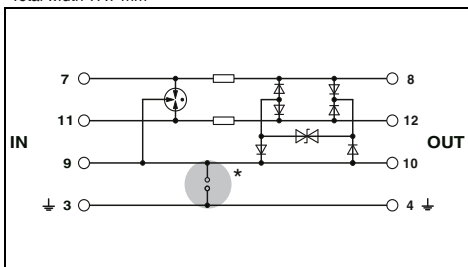

Technical data

C1 / C2 / C3 / D1
14 V DC / 9.8 V AC
450 mA (45°C)

10 kA
10 kA
20 kA

≤ 50 V (C3 - 25 A)
≤ 50 V (C3 - 25 A)

typ. 60 MHz / -
typ. 60 MHz / -
- / -
- / -

17.7 mm / 45 mm / 52 mm
-40°C ... 85°C
Screw connection
(in connection with the base element)
EN 61643-21/A1 / IEC 61643-21/A1

Total width 17.7 mm

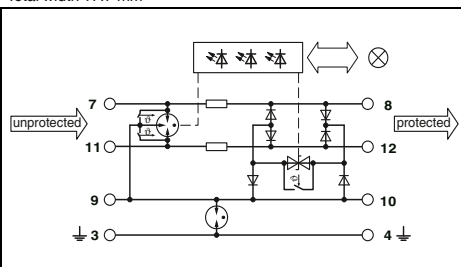

Technical data

C1 / C2 / C3 / D1
15 V DC / 10 V AC
600 mA (40°C)

10 kA
-
20 kA

≤ 40 V (C3 - 25 A)
≤ 900 V (C3 - 25 A)

- / -
- / -
typ. 60 MHz / -
typ. 60 MHz / typ. 60 MHz

17.7 mm / 91.1 mm / 77.5 mm
-40°C ... 70°C
Screw connection
IEC 61643-21 / EN 61643-21 / EN 61000-6-2 / EN 61000-6-3

Total width 6.2 mm

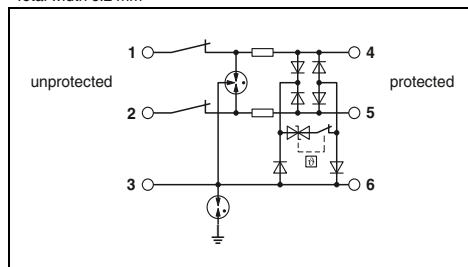

Technical data

C1 / C2 / C3 / D1
15 V DC / 10 V AC
600 mA (56°C)

5 kA
5 kA
10 kA

≤ 145 V (C1 - 1 kV/500 A)
≤ 750 V (C1 - 1 kV/500 A)

- / -
- / -
typ. 60 MHz / -
typ. 60 MHz / typ. 60 MHz

6.2 mm / 105.8 mm / 100 mm
-40°C ... 85°C
Push-in connection

IEC 61643-21 / EN 61643-21

Ordering data

Type	Order No.	Pcs./Pkt.
PT 3-HF-12DC-ST	2858043	10
PT 1X2+F-BE	2856126	10

Accessories

PT-IQ-PTB-PT	2801296	1
PT-IQ-PTB-UT	2800768	1
ZBF ..., see page 223		

Ordering data

Type	Order No.	Pcs./Pkt.
PT-IQ-3-HF+F-12DC-PT	2801289	1
PT-IQ-3-HF+F-12DC-UT	2800995	1

Accessories

PT-IQ-PTB-PT	2801296	1
PT-IQ-PTB-UT	2800768	1
ZBF ..., see page 223		

Ordering data

Type	Order No.	Pcs./Pkt.
TTC-6P-3-HF-F-M-12DC-PT-I	2906796	1

Accessories

ZBF ..., see page 223		
-----------------------	--	--

Surge protection and interference filters

Surge protection for information technology and telecommunications

RS-485 interfaces

TERMITRAB complete

- One-piece or pluggable surge protection
- Overall width of just 6.2 mm
- With Push-in or screw connection technology
- Integrated mechanical status indicator
- Impedance-neutral insertion and removal
- Coded plug versions
- With and without knife disconnection
- Optional remote signaling module monitors up to 40 items, without additional wiring
- Plugs can be tested with CHECKMASTER 2



3-conductor with common reference potential, 3/6 connection grounded directly, one-piece

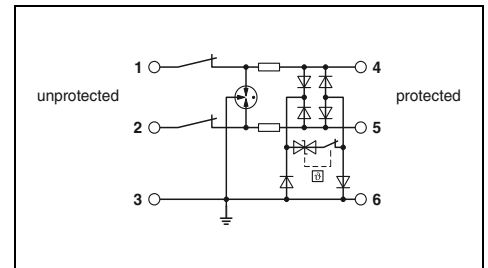

Technical data

Electrical data	... 12DC
IEC test classification/EN type	C1 / C2 / C3 / D1
Maximum continuous operating voltage U_c	15 V DC / 10 V AC
Rated current	600 mA (40°C)
Pulse discharge current I_{imp} (10/350) μ s	0.5 kA
Nominal discharge current I_n (8/20) μ s	
	Core-Core 5 kA
	Core-Ground 5 kA
	10 kA
Total discharge current I_{total} (8/20) μ s	
Protection level U_p	Core-Core ≤ 25 V (C3 - 25 A)
	Core-Ground ≤ 25 V (C3 - 25 A)
Cut-off frequency f_g (3 dB)	typ. 60 MHz
	Symmetrical in the 150 Ω system 1.65 Ω
Resistance per path	
General data	
Dimensions W/H/D	6.2 mm / 105.8 mm / 83.5 mm
Connection data rigid / flexible / AWG	0.2 ... 4 mm ² / 0.2 ... 2.5 mm ² / 24 ... 12
Temperature range	-40°C ... 85°C
Test standards	IEC 61643-21 / EN 61643-21

Ordering data

Description	Voltage U_N	Type	Order No.	Pcs./Pkt.
	12 V DC 24 V DC	TTC-6-3-HF-M-12DC-PT-I	2906732	1
TERMITRAB complete , with screw connection technology and knife disconnection	12 V DC 24 V DC	TTC-6-3-HF-M-12DC-UT-I	2906721	1
TERMITRAB complete , with Push-in connection technology, without knife disconnection	12 V DC	TTC-6-3-HF-12DC-PT	1065316	1

Accessories

Replacement plug	12 V DC 24 V DC			
------------------	--------------------	--	--	--

SIL
evaluated
IEC 61508



SIL
evaluated
IEC 61508



SIL
evaluated
IEC 61508



3-conductor with common reference potential,
3/6 connection grounded via gas-filled
surge arrester, one-piece

3-conductor with common reference potential,
3/6 connection grounded directly, pluggable

3-conductor with common reference potential,
3/6 connection grounded via gas-filled
surge arrester, pluggable

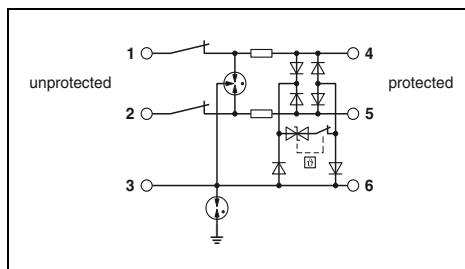
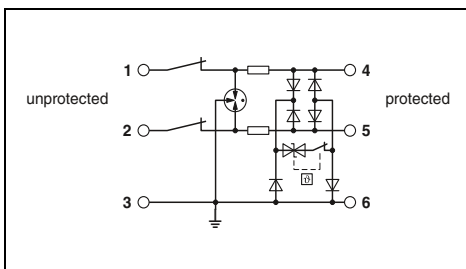
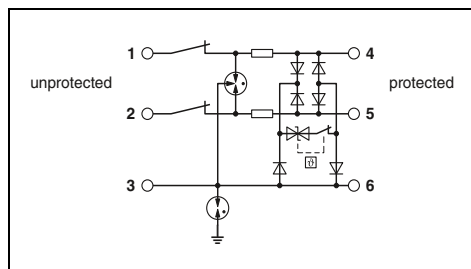

Technical data	
... 12DC	... 24DC
C1 / C2 / C3 / D1	C1 / C2 / C3 / D1
15 V DC / 10 V AC	30 V DC / 21 V AC
600 mA (40°C)	600 mA (40°C)
0.5 kA	0.5 kA
5 kA	5 kA
5 kA	5 kA
10 kA	10 kA
≤ 25 V (C3 - 25 A)	≤ 45 V (C3 - 25 A)
≤ 1.1 kV (C3 - 25 A)	≤ 1.1 kV (C3 - 25 A)
typ. 60 MHz	typ. 60 MHz
1.65 Ω	1.65 Ω
6.2 mm / 105.8 mm / 83.5 mm	
0.2 ... 4 mm ² / 0.2 ... 2.5 mm ² / 24 ... 12	
-40°C ... 85°C	
IEC 61643-21 / EN 61643-21	

Technical data	
... 12DC	
C1 / C2 / C3 / D1	
15 V DC / 10 V AC	
600 mA (56°C)	
0.5 kA	
5 kA	
5 kA	
10 kA	
≤ 25 V (C3 - 25 A)	-
≤ 25 V (C3 - 25 A)	
typ. 60 MHz	
1.65 Ω	
6.2 mm / 105.8 mm / 100 mm	
0.2 ... 4 mm ² / 0.2 ... 2.5 mm ² / 24 ... 12	
-40°C ... 85°C	
IEC 61643-21 / EN 61643-21	

Technical data	
... 12DC	... 24DC
C1 / C2 / C3 / D1	C1 / C2 / C3 / D1
15 V DC / 10 V AC	30 V DC / 21 V AC
600 mA (56°C)	600 mA (56°C)
0.5 kA	0.5 kA
5 kA	5 kA
5 kA	5 kA
10 kA	10 kA
≤ 25 V (C3 - 25 A)	≤ 45 V (C3 - 25 A)
≤ 1.1 kV (C3 - 25 A)	≤ 1.1 kV (C3 - 25 A)
typ. 60 MHz	typ. 60 MHz
1.65 Ω	1.65 Ω
6.2 mm / 105.8 mm / 100 mm	
0.2 ... 4 mm ² / 0.2 ... 2.5 mm ² / 24 ... 12	
-40°C ... 85°C	
IEC 61643-21 / EN 61643-21	

Ordering data		
Type	Order No.	Pcs./Pkt.
TTC-6-3-HF-F-M-12DC-PT-I	2906778	1
TTC-6-3-HF-F-M-24DC-PT-I	2906779	1
TTC-6-3-HF-F-M-12DC-UT-I	2906769	1
TTC-6-3-HF-F-M-24DC-UT-I	2906770	1
TTC-6P-3-HF-F-12DC-PT-I	1065314	1

Ordering data		
Type	Order No.	Pcs./Pkt.
TTC-6P-3-HF-F-M-12DC-PT-I	2906756	1
TTC-6P-3-HF-F-M-12DC-UT-I	2906744	1
TTC-6P-3-HF-12DC-PT-I	1065313	1

Ordering data		
Type	Order No.	Pcs./Pkt.
TTC-6P-3-HF-F-M-12DC-PT-I	2906796	1
TTC-6P-3-HF-F-M-24DC-PT-I	2906797	1
TTC-6P-3-HF-F-M-12DC-UT-I	2906786	1
TTC-6P-3-HF-F-M-24DC-UT-I	2906787	1

Accessories		

Accessories		
TTC-6P-3-HF-12DC-I-P	2907846	1

Accessories		
TTC-6P-3-HF-12DC-I-P	2907846	1
TTC-6P-3-HF-24DC-I-P	2907847	1



5-conductor with common reference potential, 9/10 connection grounded via gas-filled surge arrester



Pluggable arrester with screw connection, for five conductors, with common reference potential



Protective adapter with 9-pos. D-SUB

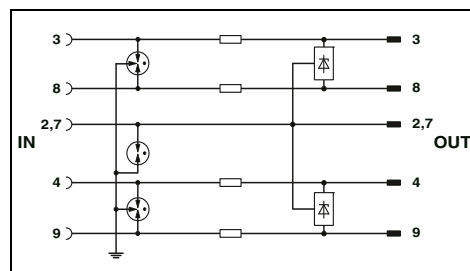
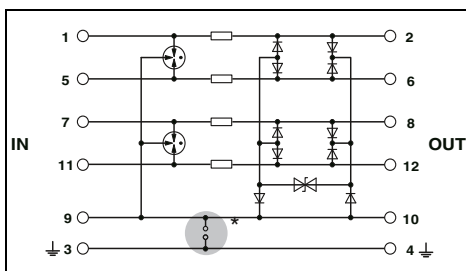
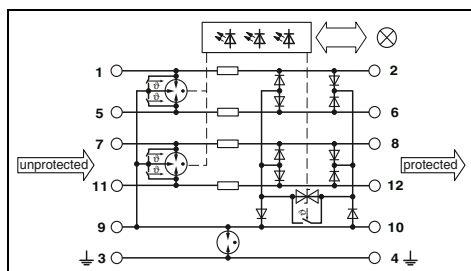

Technical data	
... 5DC	... 12DC
C1 / C2 / C3 / D1	C1 / C2 / C3 / D1
6 V DC / 4 V AC	15 V DC / 10 V AC
600 mA (40°C)	600 mA (40°C)
10 kA	10 kA
10 kA	10 kA
20 kA	20 kA
≤ 30 V (C3 - 25 A)	≤ 40 V (C3 - 25 A)
≤ 900 V (C3 - 25 A)	≤ 900 V (C3 - 25 A)
-	-
typ. 60 MHz	typ. 60 MHz
-40°C ... 70°C	
Screw connection	Push-in connection
IEC 61643-21 / EN 61643-21 / EN 61000-6-2 / EN 61000-6-3	

Technical data	
... 5DC	... 12DC
C1 / C2 / C3 / D1	C1 / C2 / C3 / D1
5.2 V DC / 3.6 V AC	14 V DC / 9.8 V AC
450 mA (45°C)	450 mA (45°C)
10 kA	10 kA
10 kA	20 kA (in total)
20 kA	20 kA
≤ 45 V (C3 - 25 A)	≤ 50 V (C3 - 25 A)
≤ 45 V (C3 - 25 A)	≤ 50 V (C3 - 25 A with PT 2X2-BE)
typ. 60 MHz	typ. 60 MHz
-	-
-40°C ... 85°C	
Screw connection (in connection with the base element)	Screw connection (in connection with the base element)
EN 61643-21/A1 / IEC 61643-21/A1	

Technical data	
B2 / C1 / C2 / C3 / D1	
12 V DC	
≤ 380 mA (25°C)	
≤ 5 kA	
≤ 5 kA	
10 kA	
≤ 30 V (C1 - 500 A)	
≤ 700 V (C1 - 500 A)	
typ. 50 MHz	
-	
-40°C ... 85°C	
D-SUB-9	
DIN EN 61643-21	

Ordering data		
Type	Order No.	Pcs./Pkt.
PT-IQ-5-HF+F-5DC-UT	2800798	1
PT-IQ-5-HF+F-12DC-UT	2800801	1
PT-IQ-5-HF+F-5DC-PT	2801292	1
PT-IQ-5-HF+F-12DC-PT	2801295	1

Ordering data		
Type	Order No.	Pcs./Pkt.
PT 5-HF- 5 DC-ST	2838762	10
PT 5-HF-12 DC-ST	2838775	10
PT 2X2-BE	2839208	10
PT 2X2+F-BE	2839224	10

Ordering data		
Type	Order No.	Pcs./Pkt.
DT-UFB-485/BS	2920612	1

Accessories		
Type	Order No.	Pcs./Pkt.
PT-IQ-PTB-UT	2800768	1
PT-IQ-PTB-PT	2801296	1

Accessories		
Type	Order No.	Pcs./Pkt.

Accessories		
Type	Order No.	Pcs./Pkt.

Surge protection and interference filters

Surge protection for information technology and telecommunications

V.11/RS-422 interfaces

PLUGTRAB PT 5-HF-12DC

- For high data transmission rates
- Plugs can be tested with CHECKMASTER 2
- 9/10 connections (GND) are connected to the mounting foot via a gas-filled surge arrester

PLUGTRAB PT-IQ-5-HF-12DC

- Connection: Push-in or screw connection technology
- For high transmission speeds
- Multi-stage, floating remote signaling
- Group message via supply and remote signaling module



Pluggable arrester with screw connection, for five conductors, with common reference potential



5-conductor with common reference potential, 9/10 connection grounded via gas-filled surge arrester

Notes:
Attenuation characteristics at phoenixcontact.net/products

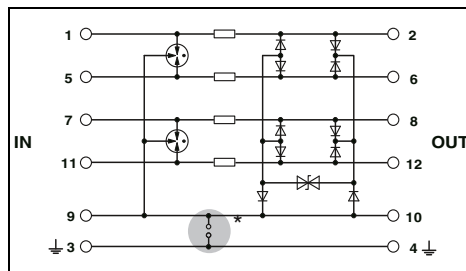

Technical data

Electrical data	
IEC test classification/EN type	C1 / C2 / C3 / D1
Maximum continuous operating voltage U_C	
Rated current	450 mA (45°C)
Nominal discharge current I_n (8/20) μ s	Core-Core 10 kA Core-Ground 20 kA (in total) 20 kA
Total discharge current I_{total} (8/20) μ s	
Protection level U_p	Core-Core ≤ 50 V (C3 - 25 A) Core-Ground ≤ 50 V (C3 - 25 A with PT 2X2-BE)
Cut-off frequency f_g (3 dB)	
In a 100 Ω system	Symmetrical typ. 60 MHz
In a 150 Ω system	Symm. / asymm. (GND) - / -
General data	
Temperature range	-40°C ... 85°C
Test standards	EN 61643-21 / IEC 61643-21

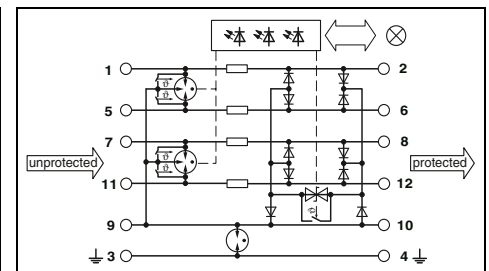

Technical data

Electrical data	
IEC test classification/EN type	C1 / C2 / C3 / D1
Maximum continuous operating voltage U_C	
Rated current	600 mA (40°C)
Nominal discharge current I_n (8/20) μ s	10 kA 10 kA 20 kA
Total discharge current I_{total} (8/20) μ s	
Protection level U_p	≤ 40 V (C3 - 25 A) ≤ 900 V (C3 - 25 A)
Cut-off frequency f_g (3 dB)	
In a 100 Ω system	-
In a 150 Ω system	typ. 60 MHz / typ. 60 MHz
General data	
Temperature range	-40°C ... 70°C
Test standards	IEC 61643-21 / EN 61643-21 / EN 61000-6-2 / EN 61000-6-3

Ordering data

Description	Nominal voltage U_N
PLUGTRAB plug, with protective circuit for inserting in PT base element	12 V DC
PLUGTRAB base element, for mounting on NS 35	
Gas-filled surge arrester between 3/4 ($\frac{1}{2}$) and 9/10	
PLUGTRAB, consisting of plug, base element, and DIN rail bus with screw connection technology	
PLUGTRAB, consisting of plug, base element, and DIN rail bus with Push-in connection technology	

Type	Order No.	Pcs./Pkt.
PT 5-HF-12 DC-ST	2838775	10
PT 2X2+F-BE	2839224	10
PT-IQ-5-HF+F-12DC-UT	2800801	1
PT-IQ-5-HF+F-12DC-PT	2801295	1

Accessories

PLUGTRAB, supply and remote signaling module		
Screw connection technology		
Push-in connection technology		

PT-IQ-PTB-UT	2800768	1
PT-IQ-PTB-PT	2801296	1

Marking material

ZBF ..., see page 223

TTY interfaces

PLUGTRAB PT 2X2-24DC

- Plugs can be tested with CHECKMASTER 2
- 9/10 connections (GND) are directly connected to the mounting foot

PLUGTRAB PT-IQ-2X2-24DC

- Connection: Push-in or screw connection technology
- Multi-stage, floating remote signaling
- Group message via supply and remote signaling module



Two double wires (loops), floating, for 20 mA current loops



2 double wires (loops), floating, connection 9/10 grounded directly, e.g., for 4 ... 20 mA current loop

Notes:
Attenuation characteristics at phoenixcontact.net/products

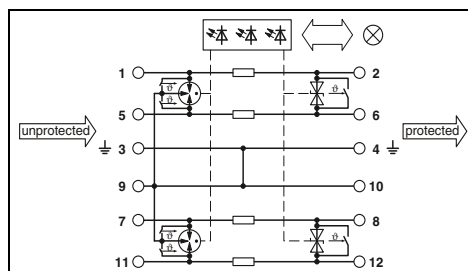
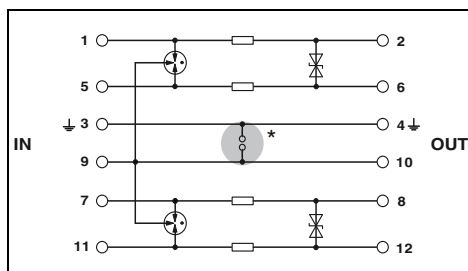

Electrical data	
IEC test classification/EN type	
Maximum continuous operating voltage U_C	
Rated current	
Nominal discharge current I_n (8/20) μ s	
Total discharge current I_{total} (8/20) μ s	
Protection level U_p	
Cut-off frequency f_g (3 dB)	
In a 50 Ω system	
General data	
Temperature range	
Test standards	

Technical data	
C1 / C2 / C3 / D1	
450 mA (45°C)	
Core-Core	10 kA
Core-Ground	10 kA
	20 kA
Core-Core	≤ 50 V (C3 - 25 A)
Core-Ground	≤ 450 V (C1 - 1 kV / 500 A with PT 2X2-BE)
	typ. 4.5 MHz
-40°C ... 85°C	
IEC 61643-21 / EN 61643-21	

Technical data	
C1 / C2 / C3 / D1	
700 mA (50°C)	
	10 kA
	10 kA
	20 kA
	≤ 55 V (C3 - 25 A)
	≤ 700 V (C3 - 25 A)
-40°C ... 70°C	
IEC 61643-21 / EN 61643-21 / EN 61000-6-3 / EN 61000-6-2	

Description	Nominal voltage U_N
PLUGTRAB plug, with protective circuit for inserting in PT base element	24 V DC
PLUGTRAB base element, for mounting on NS 35	Bridge between 3/4 (\pm) and 9/10
PLUGTRAB, with screw connection technology	
PLUGTRAB, with Push-in connection technology	

Ordering data		
Type	Order No.	Pcs./Pkt.
PT 2X2-24DC-ST	2838228	10
PT 2X2-BE	2839208	10

Ordering data		
Type	Order No.	Pcs./Pkt.
PT-IQ-2X2-24DC-UT	2800980	1
PT-IQ-2X2-24DC-PT	2801263	1

Shield fast connection	
	For \varnothing 3-6 mm
	For \varnothing 5-10 mm
PLUGTRAB, supply and remote signaling module	
	Screw connection technology
	Push-in connection technology

Accessories		
Type	Order No.	Pcs./Pkt.
SSA 3-6	2839295	10
SSA 5-10	2839512	10

Accessories		
Type	Order No.	Pcs./Pkt.
PT-IQ-PTB-UT	2800768	1
PT-IQ-PTB-PT	2801296	1

Surge protection and interference filters

Surge protection for information technology and telecommunications

PROFIBUS DP fieldbus system PLUGTRAB PT-IQ

- Multi-stage status monitoring
- Group message via supply and remote signaling module
- Multi-stage, floating remote signaling
- System supplied via DIN rail bus
- Up to 28 protection modules per supply module
- Maximum ease of maintenance, thanks to the two-piece design
- Plugs are coded
- Impedance-neutral disconnection of plug for maintenance purposes
- PT-IQ...-UT base element with screw connection technology
- PT-IQ...-PT base element with Push-in connection technology
- Base element remains an integral part of the installation
- Corresponding replacement plugs can be found on our website



3-conductor protection for fieldbus and serial interface, connection 9/10 grounded directly

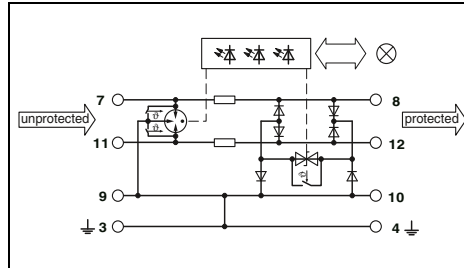

Technical data

Electrical data	... 5DC	... 12DC
IEC test classification/EN type	C1 / C2 / C3 / D1	C1 / C2 / C3 / D1
Maximum continuous operating voltage U_c	6 V DC / 4 V AC	15 V DC / 10 V AC
Rated current	600 mA (40°C)	600 mA (40°C)
Pulse discharge current I_{imp} (10/350) μ s	2.5 kA	2.5 kA
Nominal discharge current I_n (8/20) μ s		
	Core-Core	10 kA
	Core-Ground	10 kA
Total discharge current I_{total} (8/20) μ s		20 kA
Max. discharge current I_{max} (8/20) μ s		-
Protection level U_p		
	Core-Core	≤ 30 V (C3 - 25 A)
	Core-Ground	≤ 40 V (C3 - 25 A)
Cut-off frequency f_g (3 dB)		
	Symmetrical in the 150 Ω system	typ. 60 MHz
Resistance per path		1.2 Ω
General data		
Connection data rigid / flexible / AWG		0.2 ... 4 mm ² / 0.2 ... 2.5 mm ² / 24 ... 12
Temperature range		-40°C ... 70°C
Test standards		IEC 61643-21 / EN 61643-21 / EN 61000-6-2 / EN 61000-6-3

Ordering data

Description	Voltage U_N	Type	Order No.	Pcs./Pkt.
PLUGTRAB, with Push-in connection technology	5 V DC	PT-IQ-3-PB-PT	2801286	1
	12 V DC	PT-IQ-3-HF-12DC-PT	2801288	1
PLUGTRAB, with screw connection technology	5 V DC	PT-IQ-3-PB-UT	2800785	1
	12 V DC	PT-IQ-3-HF-12DC-UT	2800786	1
Accessories				
PLUGTRAB, supply and remote signaling module	Push-in connection technology	PT-IQ-PTB-PT	2801296	1
	Screw connection technology	PT-IQ-PTB-UT	2800768	1



5-conductor with common reference potential, 9/10 connection grounded directly

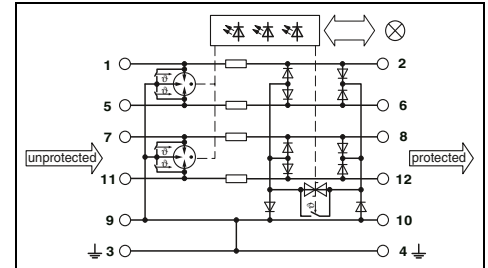

Technical data

Electrical data	... 5DC	... 12DC
IEC test classification/EN type	C1 / C2 / C3 / D1	C1 / C2 / C3 / D1
Maximum continuous operating voltage U_c	6 V DC / 4 V AC	15 V DC / 10 V AC
Rated current	600 mA (40°C)	600 mA (40°C)
Pulse discharge current I_{imp} (10/350) μ s	2.5 kA	2.5 kA
Nominal discharge current I_n (8/20) μ s		
	Core-Core	10 kA
	Core-Ground	10 kA
Total discharge current I_{total} (8/20) μ s		20 kA
Max. discharge current I_{max} (8/20) μ s		-
Protection level U_p		
	Core-Core	≤ 30 V (C3 - 25 A)
	Core-Ground	≤ 40 V (C3 - 25 A)
Cut-off frequency f_g (3 dB)		
	Symmetrical in the 150 Ω system	typ. 60 MHz
Resistance per path		1.2 Ω
General data		
Connection data rigid / flexible / AWG		0.2 ... 4 mm ² / 0.2 ... 2.5 mm ² / 24 ... 12
Temperature range		-40°C ... 70°C
Test standards		IEC 61643-21 / EN 61643-21 / EN 61000-6-2 / EN 61000-6-3

Ordering data

Description	Voltage U_N	Type	Order No.	Pcs./Pkt.
PLUGTRAB, with Push-in connection technology	5 V DC	PT-IQ-5-HF-5DC-PT	2801291	1
	12 V DC	PT-IQ-5-HF-12DC-PT	2801293	1
PLUGTRAB, with screw connection technology	5 V DC	PT-IQ-5-HF-5DC-UT	2800797	1
	12 V DC	PT-IQ-5-HF-12DC-UT	2800799	1
Accessories				
PLUGTRAB, supply and remote signaling module	Push-in connection technology	PT-IQ-PTB-PT	2801296	1
	Screw connection technology	PT-IQ-PTB-UT	2800768	1

PROFIBUS DP fieldbus system TERMITRAB complete

- One-piece or pluggable surge protection
- Overall width of just 6.2 mm
- With Push-in or screw connection technology
- Integrated mechanical status indicator
- Impedance-neutral insertion and removal
- Coded plug versions
- With and without knife disconnection
- Optional remote signaling module monitors up to 40 items, without additional wiring
- Plugs can be tested with CHECKMASTER 2



3-conductor with common reference potential, 3/6 connection grounded directly, one-piece



3-conductor with common reference potential, 3/6 connection grounded directly, pluggable

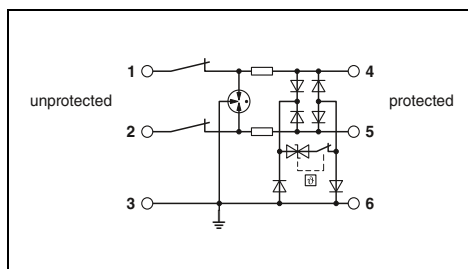

Technical data

Electrical data	
IEC test classification/EN type	C1 / C2 / C3 / D1
Maximum continuous operating voltage U_C	15 V DC / 10 V AC
Rated current	600 mA (40°C)
Pulse discharge current I_{imp} (10/350) μ s	0.5 kA
Nominal discharge current I_n (8/20) μ s	
	Core-Core
	5 kA
	Core-Ground
	5 kA
Total discharge current I_{total} (8/20) μ s	10 kA
Max. discharge current I_{max} (8/20) μ s	-
Protection level U_p	
	Core-Core
	≤ 25 V (C3 - 25 A)
	Core-Ground
	≤ 25 V (C3 - 25 A)
Cut-off frequency f_g (3 dB)	typ. 60 MHz
	Symmetrical in the 150 Ω system
Resistance per path	1.65 Ω
General data	
Connection data rigid / flexible / AWG	0.2 ... 4 mm ² / 0.2 ... 2.5 mm ² / 24 ... 12
Temperature range	-40°C ... 85°C
Test standards	IEC 61643-21 / EN 61643-21

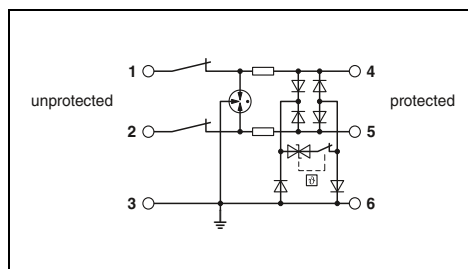

Technical data

Electrical data	
IEC test classification/EN type	C1 / C2 / C3 / D1
Maximum continuous operating voltage U_C	15 V DC / 10 V AC
Rated current	600 mA (56°C)
Pulse discharge current I_{imp} (10/350) μ s	0.5 kA
Nominal discharge current I_n (8/20) μ s	
	Core-Core
	5 kA
	Core-Ground
	5 kA
Total discharge current I_{total} (8/20) μ s	10 kA
Max. discharge current I_{max} (8/20) μ s	-
Protection level U_p	
	Core-Core
	≤ 25 V (C3 - 25 A)
	Core-Ground
	≤ 25 V (C3 - 25 A)
Cut-off frequency f_g (3 dB)	typ. 60 MHz
	Symmetrical in the 150 Ω system
Resistance per path	1.65 Ω
General data	
Connection data rigid / flexible / AWG	0.2 ... 4 mm ² / 0.2 ... 2.5 mm ² / 24 ... 12
Temperature range	-40°C ... 85°C
Test standards	IEC 61643-21 / EN 61643-21

Ordering data

Description	Voltage U_N
TERMITRAB complete, with screw connection technology and knife disconnection	12 V DC
TERMITRAB complete, with Push-in connection technology, without knife disconnection	12 V DC
	12 V DC

Type	Order No.	Pcs./Pkt.
TTC-6-3-HF-M-12DC-PT-I	2906732	1
TTC-6-3-HF-M-12DC-UT-I	2906721	1
TTC-6-3-HF-12DC-PT	1065316	1

Ordering data

Type	Order No.	Pcs./Pkt.
TTC-6P-3-HF-M-12DC-PT-I	2906756	1
TTC-6P-3-HF-M-12DC-UT-I	2906744	1
TTC-6P-3-HF-12DC-PT-I	1065313	1

Accessories

Remote signaling set	Push-in connection technology	
	Screw connection technology	

--	--	--

Accessories

TTC-6-FMRS-PT	2907811	1
TTC-6-FMRS-UT	2907810	1

Surge protection and interference filters

Surge protection for information technology and telecommunications

PROFIBUS DP fieldbus system PLUGTRAB PT

Notes:
Attenuation characteristics at phoenixcontact.net/products



Pluggable arrester with screw connection, for five conductors, with common reference potential

PLUGTRAB PT 3-PB(HF)... / PT 5-HF...

- Protection for PROFIBUS (up to 12 Mbps), in three- to five-conductor technology
- Cable shield connection with SSA... shield fast connection
- Maximum ease of maintenance, thanks to the two-piece design
- Base element remains an integral part of the installation
- Impedance-neutral disconnection of plug for test and maintenance purposes

DATATRAB D-UFB-PB

- Direct use at the PROFIBUS interface
- Data transmission rate up to 12 Mbps
- Integrated termination resistor

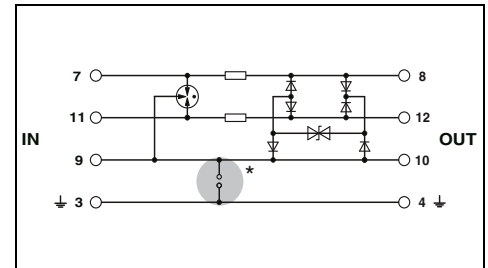

Technical data

Electrical data		
IEC test classification/EN type		C1 / C2 / C3 / D1
Maximum continuous operating voltage U_c		
Rated current		450 mA (45°C)
Nominal discharge current I_n (8/20) μ s	Core-Core	10 kA
	Core-Ground	10 kA
		20 kA
Total discharge current I_{total} (8/20) μ s	Core-Core	≤ 45 V (C3 - 25 A)
Protection level U_p	Core-Ground	≤ 45 V (C3 - 25 A)
	Core-Core	≤ 15 V
Output voltage limitation at 1 kV/ μ s	Core-Ground	≤ 15 V
	Core-Core	≤ 15 V
Cut-off frequency f_g (3 dB) in a 100 Ω system	Symmetrical	typ. 60 MHz
General data		
Temperature range		-40°C ... 85°C
Connection method		Screw connection (in connection with the base element)
Test standards		EN 61643-21/A1 / IEC 61643-21/A1

Ordering data

Description	Nominal voltage U_N	Type	Order No.	Pcs./Pkt.
PLUGTRAB plug , with protective circuit for inserting in PT base element	5 V DC 12 V DC	PT 3-PB-ST PT 3-HF-12DC-ST	2858030 2858043	10 10
PLUGTRAB base element , for mounting on NS 35	Bridge between 3/4 (\pm) and 9/10	PT 1X2-BE	2856113	10
DATATRAB , protective device for PROFIBUS DP applications with up to 12 Mbps				

Accessories

Shield fast connection	SSA 3-6	SSA 5-10
For \varnothing 3-6 mm	2839295	10
For \varnothing 5-10 mm	2839512	10

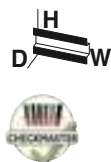

Pluggable arrester with screw connection, for five conductors, with common reference potential



PROFIBUS fine protection with D-SUB 9

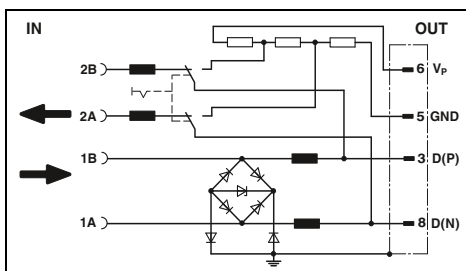
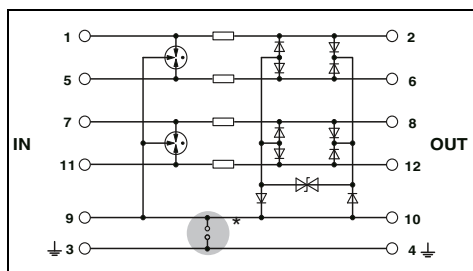

Technical data

Technical data

C1 / C2 / C3 / D1

C1 / C3 / B2

450 mA (45°C)

250 mA (25°C)

10 kA
20 kA (in total)
20 kA

350 A
350 A
350 A

≤ 50 V (C3 - 25 A)
≤ 50 V (C3 - 25 A with PT 2X2-BE)

≤ 25 V (C1 - 500 V / 250 A)
≤ 25 V (C1 - 500 V / 250 A)

≤ 25 V
≤ 25 V (with PT 2X2-BE)

≤ 14 V
≤ 14 V

typ. 60 MHz

typ. 70 MHz

-40°C ... 85°C
Screw connection
(in connection with the base element)
EN 61643-21 / IEC 61643-21

-20°C ... 75°C
Screw connection & D-SUB-9
IEC 61643-21

Ordering data

Ordering data

Type	Order No.	Pcs./Pkt.
PT 5-HF-12 DC-ST	2838775	10
PT 2X2-BE	2839208	10

Type	Order No.	Pcs./Pkt.
D-UFB-PB	2880642	1

Accessories

Accessories

Type	Order No.	Pcs./Pkt.
SSA 3-6	2839295	10
SSA 5-10	2839512	10

Type	Order No.	Pcs./Pkt.

Surge protection and interference filters

Surge protection for information technology and telecommunications

PROFIBUS PA fieldbus system

Notes:

For corresponding replacement plugs, visit phoenixcontact.net/products

TERMITRAB complete

- One-piece or pluggable surge protection
- Tailored to the special requirements of intrinsically safe circuits
- Overall width of just 6.2 mm
- Integrated mechanical status indicator
- Impedance-neutral insertion and removal
- Coded plug versions
- With knife disconnection
- Plugs can be tested with CHECKMASTER 2

PLUGTRAB PT-IQ-EX

- Tailored to the special requirements of intrinsically safe circuits
- Multi-stage status monitoring
- Group message via supply and remote signaling module
- Multi-stage, floating remote signaling
- System supplied via DIN rail bus
- Up to 10 protection modules per supply module
- Maximum ease of maintenance, thanks to the two-piece design
- Plugs are coded
- Impedance-neutral disconnection of plug for maintenance purposes
- Base element remains an integral part of the installation

PLUGTRAB PT 2XEX(I)

- Tailored to the special requirements of intrinsically safe circuits
- Consistently pluggable signal circuit protection
- Maximum ease of maintenance, thanks to the two-piece design
- Base element remains an integral part of the installation
- Impedance-neutral disconnection of plug for test and maintenance purposes
- Plugs can be tested with CHECKMASTER 2



3-conductor with common reference potential, intrinsically safe, one-piece

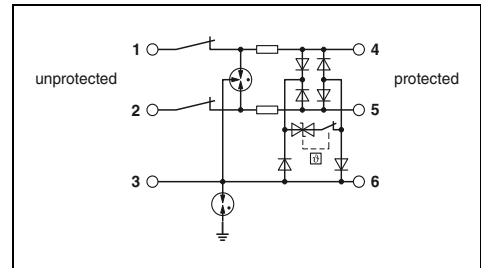

Technical data

Electrical data	... 12DC	... 24DC
IEC test classification/EN type	C1 / C2 / C3 / D1	C1 / C2 / C3 / D1
Maximum continuous operating voltage U_c	15 V DC	30 V DC
Rated current	600 mA (40°C)	600 mA (40°C)
Pulse discharge current I_{mp} (10/350) μ s	0.5 kA	0.5 kA
Nominal discharge current I_n (8/20) μ s		
	Core-Core	5 kA
	Core-Ground	5 kA
		10 kA
Total discharge current I_{total} (8/20) μ s		
Protection level U_p		
	Core-Core	≤ 145 V (C1 - 1 kV/500 A)
	Core-Ground	≤ 750 V (C1 - 1 kV/500 A)
	Core-GND	≤ 80 V (C1 - 1 kV/500 A)
Cut-off frequency f_g (3 dB)		
	Symmetrical in the 150 Ω system	typ. 60 MHz
Resistance per path	1.65 Ω	1.65 Ω
General data		
Dimensions W/H/D	6.2 mm / 105.8 mm / 83.5 mm	
Connection data rigid / flexible / AWG	0.2 ... 4 mm ² / 0.2 ... 2.5 mm ² / 24 ... 12	
Temperature range	-40°C ... 85°C	
Test standards	EN 60079-0 / EN 60079-11 / EN 61643-21 / IEC 60079-0 / IEC 60079-11 / IEC 61643-21	
Safety data		
EC-type examination certificate in accordance with ATEX	BVS 16 ATEX E 125 X	BVS 16 ATEX E 125 X
Maximum inner capacity C_i	negligible	negligible
Maximum inner inductance L_i	negligible	negligible
Maximum input current I_i	400 mA (T4 / $\leq 50^\circ$ C)	400 mA (T4 / $\leq 50^\circ$ C)
Maximum input voltage U_i	15 V DC	30 V DC
Maximum input power P_i	-	-

Ordering data

Description	Voltage U_N	Type	Order No.	Pcs./Pkt.
TERMITRAB complete, with screw connection technology	12 V DC	TTC-6-3-HF-F-M-EX-12DC-UT-I	2906822	1
	24 V DC	TTC-6-3-HF-F-M-EX-24DC-UT-I	2906823	1
MCR-PLUGTRAB, with screw connection technology	24 V DC			
PLUGTRAB plug, with protective circuit for plugging into base element PT	24 V DC			
PLUGTRAB base element, for mounting on NS 35	24 V DC			



SIL
evaluated
IEC 61508



3-conductor with common reference potential, intrinsically safe, pluggable

Ex: IEC RoHS



SIL
evaluated
IEC 61508

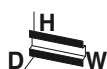

Double wire (loop), floating, connection 9/10 grounded directly, e.g., for 4 ... 20 mA current loop

Ex: IEC RoHS



SIL
evaluated
IEC 61508



Double-wire protection for two intrinsically safe circuits

Ex: IEC RoHS

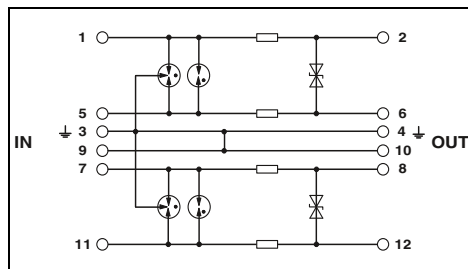
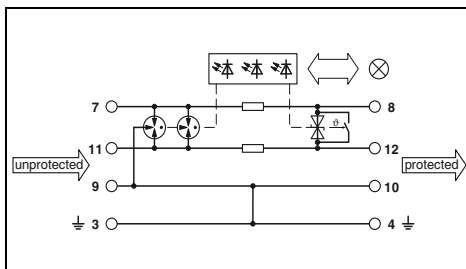
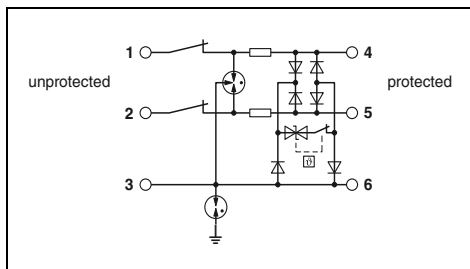

Technical data

... 12DC	... 24DC
C1 / C2 / C3 / D1	C1 / C2 / C3 / D1
15 V DC	30 V DC
600 mA (40°C)	600 mA (40°C)
0.5 kA	0.5 kA
5 kA	5 kA
5 kA	5 kA
10 kA	10 kA
≤ 145 V (C1 - 1 kV/500 A)	≤ 150 V (C1 - 1 kV/500 A)
≤ 1.1 kV (C1 - 1 kV/500 A)	≤ 750 V (C1 - 1 kV/500 A)
≤ 95 V (C1 - 1 kV/500 A)	≤ 80 V (C1 - 1 kV/500 A)
typ. 60 MHz	typ. 60 MHz
1.65 Ω	1.65 Ω

Technical data

C1 / C2 / C3 / D1
30 V DC / 21 V AC
350 mA
2 kA
10 kA
10 kA
20 kA
≤ 60 V (C1 - 1 kV/500 A)
≤ 1.3 kV (C2 - 10 kV / 5 kA)
-
typ. 1.1 MHz
1.2 Ω

Technical data

C1 / C2 / C3 / D1
30 V DC / 21 V AC
325 mA (40°C)
2 kA
10 kA
10 kA
20 kA
≤ 45 V (C1 - 0.5 kV / 250 A)
≤ 1 kV (C1 - 1 kV/500 A)
-
typ. 1.6 MHz
2.2 Ω

6.2 mm / 105.8 mm / 100 mm
0.2 ... 4 mm² / 0.2 ... 2.5 mm² / 24 ... 12
-40°C ... 85°C
EN 60079-0 / EN 60079-11 / EN 61643-21 /
IEC 60079-0 / IEC 60079-11 / IEC 61643-21

17.7 mm / 91.1 mm / 77.5 mm
0.2 ... 4 mm² / 0.2 ... 2.5 mm² / 24 ... 12
-40°C ... 70°C
EN 61643-21/A2 / IEC 61643-21/A2 / EN 61000-6-2 /
EN 61000-6-3/A1

17.5 mm / 44.8 mm / 51.7 mm
0.2 ... 4 mm² / 0.2 ... 2.5 mm² / 24 ... 12
-40°C ... 85°C
EN 61643-21 / EN 60079-0 / EN 60079-11 /
EN 60079-26 / IEC 61643-21 / IEC 60079-0

BVS 16 ATEX E 125 X	BVS 16 ATEX E 125 X
negligible	negligible
negligible	negligible
400 mA (T4 / ≤ 50°C)	400 mA (T4 / ≤ 50°C)
15 V DC	30 V DC
-	-

BVS 14 ATEX E 020 X
negligible
negligible
350 mA
30 V DC
1.2 W

KEMA 00ATEX1099 X
1.3 nF
1 μH
325 mA (T4 / ≤ 80°C)
30 V DC
3 W

Ordering data

Type	Order No.	Pcs./Pkt.
TTC-6P-3-HF-F-M-EX-12DC-UT-I	2906826	1
TTC-6P-3-HF-F-M-EX-24DC-UT-I	2906828	1

Ordering data

Type	Order No.	Pcs./Pkt.
PT-IQ-1X2-EX-24DC-UT	2801512	1

Ordering data

Type	Order No.	Pcs./Pkt.
PT 2XEX(I)-24DC-ST	2838225	10
PT 2XEX(I)-BE	2839279	10

Surge protection and interference filters

Surge protection for information technology and telecommunications

INTERBUS remote bus

PLUGTRAB PT-IQ 5-HF

- Surge protection system
- Group message via supply and remote signaling module
- Multi-stage, floating remote signaling
- System supplied via DIN rail bus
- Base element with screw connection technology

PLUGTRAB PT 5-HF

- High transmission speed
- Fast response time
- High discharge capacity
- Plugs can be tested with CHECKMASTER 2

DATATRAB DT-UFB-IB-RBI/ -RBO

- Adapter type
- 9-pos. D-SUB connection
- For remote bus modules
- DIN rail mounting possible by removing the cap
- D-SUB cable included

Note:

PT .x.+F-BE: connections 9/10 (GND) are connected to the mounting foot via a gas-filled surge arrester.

Notes:

For approvals and dimensional drawing, visit phoenixcontact.net/products



Pluggable arrester with screw connection, for five conductors, with common reference potential

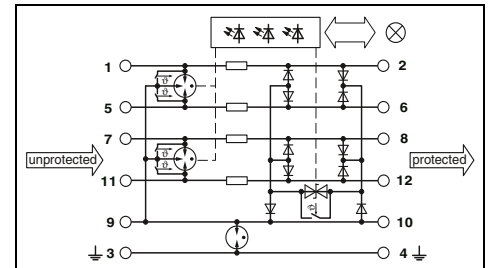

Technical data

Electrical data		
IEC test classification/EN type		C1 / C2 / C3 / D1
Maximum continuous operating voltage U_c		6 V DC / 4 V AC
Rated current		600 mA (40°C)
Nominal discharge current I_n (8/20) μ s	Core-Core	10 kA
	Core-Ground	10 kA
Total discharge current I_{total} (8/20) μ s		20 kA
Protection level U_p	Core-Core	≤ 30 V (C3 - 25 A)
	Core-Ground	≤ 900 V (C3 - 25 A)
Cut-off frequency f_g (3 dB)		
In a 100 Ω system	Symmetrical	-
In a 150 Ω system	Symmetrical	typ. 60 MHz
General data		
Temperature range		-40°C ... 70°C
Connection method		Screw connection
Test standards		
		IEC 61643-21 / EN 61643-21 / EN 61000-6-2 / EN 61000-6-3

Ordering data

Description	Nominal voltage U_N	Type	Order No.	Pcs./Pkt.
MCR-PLUGTRAB , consisting of a plug, base element, and DIN rail bus, with screw connection technology				
PLUGTRAB plug , with protective circuit for plugging into base element PT	5 V DC	PT-IQ-5-HF+F-5DC-UT	2800798	1
PLUGTRAB base element , for mounting on NS 35				
DATATRAB adapter , protective adapter for inserting into the data line				

Accessories

PLUGTRAB , supply and remote signaling module				
Screw connection technology	PT-IQ-PTB-UT	2800768	1	
Push-in connection technology	PT-IQ-PTB-PT	2801296	1	



Pluggable arrester with screw connection, for five conductors, with common reference potential



Protective adapter for 5-conductor remote bus input



Protective adapter for 5-conductor remote bus output

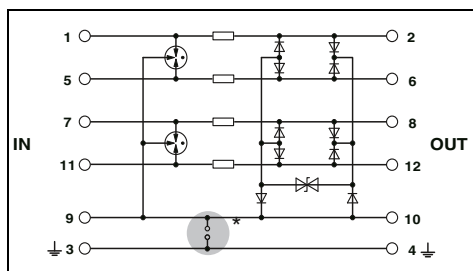

Technical data

C1 / C2 / C3 / D1
5.2 V DC / 3.6 V AC
450 mA (45°C)

10 kA
10 kA
20 kA

≤ 45 V (C3 - 25 A)
≤ 45 V (C3 - 25 A)

typ. 60 MHz

-40°C ... 85°C
Screw connection (in connection with the base element)

EN 61643-21/A1 / IEC 61643-21/A1

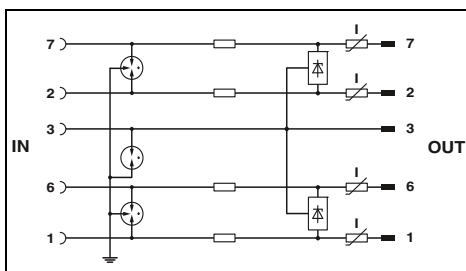

Technical data

B2 / C1 / C2 / C3 / D1
5.8 V DC
≤ 180 mA (25°C)

≤ 5 kA
≤ 5 kA
10 kA

≤ 20 V (C1 - 500 A)
≤ 700 V (C1 - 500 A)

≥ 100 MHz
≥ 100 MHz

-40°C ... 85°C
D-SUB-9

DIN EN 61643-21 / IEC 61643-21

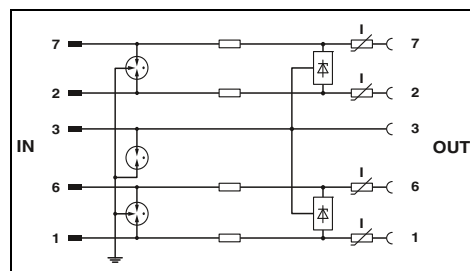

Technical data

B2 / C1 / C2 / C3 / D1
5.8 V DC
≤ 180 mA (25°C)

≤ 5 kA
≤ 5 kA
10 kA

≤ 20 V (C1 - 500 A)
≤ 700 V (C1 - 500 A)

≥ 100 MHz
≥ 100 MHz

-40°C ... 85°C
D-SUB-9

DIN EN 61643-21 / IEC 61643-21

Ordering data

Type	Order No.	Pcs./Pkt.
PT 5-HF- 5 DC-ST	2838762	10
PT 2X2+F-BE	2839224	10

Accessories

Type	Order No.	Pcs./Pkt.

Ordering data

Type	Order No.	Pcs./Pkt.
DT-UFB-IB-RB0	2800056	1

Accessories

Type	Order No.	Pcs./Pkt.

Ordering data

Type	Order No.	Pcs./Pkt.
DT-UFB-IB-RBI	2800055	1

Accessories

Type	Order No.	Pcs./Pkt.

Surge protection and interference filters

Surge protection for information technology and telecommunications

MCR-PLUGTRAB, for various applications

- Protection for fieldbus systems and signal circuits with three- to five-conductor technology
- Cable shield connection using SSA... shield fast connection
- Maximum ease of maintenance, thanks to the two-piece design
- Base element remains an integral part of the installation
- Impedance-neutral disconnection of plug for test and maintenance purposes

Note:

Base elements are grounded differently. For **PT .x.-BE**, connections 9/10 (GND) are connected directly to the mounting foot. For **PT .x.+F-BE**, connections 9/10 (GND) are connected to the mounting foot via a gas-filled surge arrester.

Notes:
Attenuation characteristics at phoenixcontact.net/products



5-conductor protection for fieldbus and serial interface

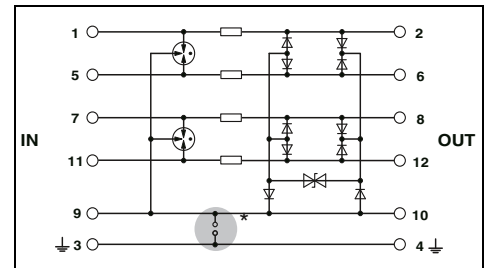

Electrical data		... 5DC	... 12DC	... 24DC
IEC test classification/EN type		C1 / C2 / C3 / D1	C1 / C2 / C3 / D1	C1 / C2 / C3 / D1
Maximum continuous operating voltage U_c		5.2 V DC / 3.6 V AC	14 V DC / 9.8 V AC	28 V DC
Rated current		450 mA (45°C)	450 mA (45°C)	450 mA (45°C)
Pulse discharge current I_{imp} (10/350) μ s		2.5 kA	2.5 kA	2.5 kA
Nominal discharge current I_n (8/20) μ s	Core-Core	10 kA	10 kA	10 kA
	Core-Ground	10 kA	20 kA (in total)	10 kA (with PT 2X2+F-BE)
Total discharge current I_{total} (8/20) μ s		20 kA	20 kA	20 kA
Max. discharge current I_{max} (8/20) μ s		10 kA	20 kA (in total)	-
Output voltage limitation at 1 kV/ μ s	Core-Core	\leq 15 V	\leq 25 V	-
	Core-Ground	\leq 15 V	\leq 25 V (with PT 2X2-BE)	-
Cut-off frequency f_g (3 dB)	Symmetrical in the 100 Ω system	typ. 60 MHz	typ. 60 MHz	typ. 70 MHz
Resistance per path		2.2 Ω	2.2 Ω	2.2 Ω

Technical data			
... 5DC ... 12DC ... 24DC			
C1 / C2 / C3 / D1			
5.2 V DC / 3.6 V AC			
14 V DC / 9.8 V AC			
28 V DC			
450 mA (45°C)			
2.5 kA			
10 kA			
20 kA (in total)			
10 kA (with PT 2X2+F-BE)			
20 kA			
-			
\leq 15 V			
\leq 25 V			
\leq 25 V (with PT 2X2-BE)			
typ. 60 MHz			
typ. 60 MHz			
typ. 70 MHz			
2.2 Ω			
2.2 Ω			
2.2 Ω			
17.7 mm / 45 mm / 52 mm			
0.2 ... 4 mm ² / 0.2 ... 2.5 mm ² / 24 ... 12			
-40°C ... 85°C			
EN 61643-21/A1 / IEC 61643-21/A1			

General data	
Dimensions W/H/D	
Connection data rigid / flexible / AWG	
Temperature range	
Test standards	
Description	Voltage U_N
PLUGTRAB plug , with protective circuit for inserting in PT base element	5 V DC
	12 V DC
	24 V DC
	32 V DC
PLUGTRAB base element , for mounting on NS 35	
	Bridge between 3/4 (\downarrow) and 9/10
	Gas-filled surge arrester between 3/4 (\downarrow) and 9/10
Shield fast connection	
	For \varnothing 3-6 mm
	For \varnothing 5-10 mm

Ordering data			
Type	Order No.	Pcs./Pkt.	
PT 5-HF- 5 DC-ST	2838762	10	
PT 5-HF-12 DC-ST	2838775	10	
PT 5-HF-24DC-ST	2906002	1	
PT 2X2-BE	2839208	10	
PT 2X2+F-BE	2839224	10	

Accessories			
SSA 3-6	2839295	10	
SSA 5-10	2839512	10	

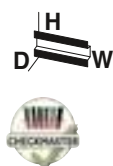

2 x 2-conductor protection for 2-wire bus system



2 x 2-conductor protection for FOUNDATION Fieldbus

ERC
Ex:

ERC
Ex:

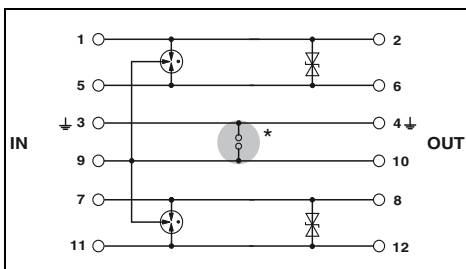
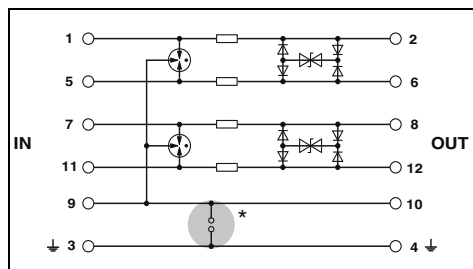

Technical data

Technical data

... 5DC	... 12DC	... 24DC
C1 / C2 / C3 / D1	C1 / C2 / C3 / D1	C1 / C2 / C3 / D1
5.2 V DC / 3.6 V AC	13 V DC / 9 V AC	28 V DC / 19.8 V AC
450 mA (45°C)	450 mA (45°C)	450 mA (45°C)
2.5 kA	2.5 kA	2.5 kA
10 kA	10 kA	10 kA
10 kA	10 kA	10 kA
20 kA	20 kA	20 kA
10 kA	10 kA	10 kA
≤ 15 V	≤ 25 V	≤ 45 V
-	-	-
typ. 70 MHz	typ. 70 MHz	typ. 70 MHz
2.2 Ω	2.2 Ω	2.2 Ω

C1 / C2 / C3 / D1
36 V DC
1.6 A
1 kA
100 A
10 kA
-
10 kA
≤ 75 V
-
-
1 Ω

17.7 mm / 45 mm / 52 mm
0.2 ... 4 mm² / 0.2 ... 2.5 mm² / 24 ... 12
-40°C ... 85°C
IEC 61643-21

17.7 mm / 45 mm / 52 mm
- mm² / - mm² / -
-40°C ... 85°C
EN 61643-21/A1

Ordering data

Ordering data

Type	Order No.	Pcs./Pkt.
PT 2X2-HF-5 DC-ST	2839567	10
PT 2X2-HF-12 DC-ST	2839570	10
PT 2X2-HF-24 DC-ST	2839729	10
PT 2X2-BE	2839208	10
PT 2X2+F-BE	2839224	10

Type	Order No.	Pcs./Pkt.
PT 2X2-FF-ST	2800755	10
PT 4-BE	2839402	10
PT 4+F-BE	2839415	10

Accessories

Accessories

Type	Order No.	Pcs./Pkt.
SSA 3-6	2839295	10
SSA 5-10	2839512	10

Type	Order No.	Pcs./Pkt.
SSA 3-6	2839295	10
SSA 5-10	2839512	10

Surge protection and interference filters

Surge protection for information technology and telecommunications

DSL telecommunications DATATRAB DT

- Protection for two DSL ports
- Connection: RJ45 (RJ12/RJ11) and plug-in screw terminal block (COMBICON)
- Alternatively, can be snapped onto a DIN rail
- Protective circuit:
Coarse/fine protection combination between all cables of signal wire pairs, as well as common mode voltage coarse protection between all signal wires and ground
- Separate ground connection line
- The adapter included enables conversion from RJ45 to RJ11 and RJ12 (for contacting, see circuit diagram)



Attachment plug
for two VDSL interfaces (ports)



Attachment plug
for two SHDSL interfaces (ports)

ERC

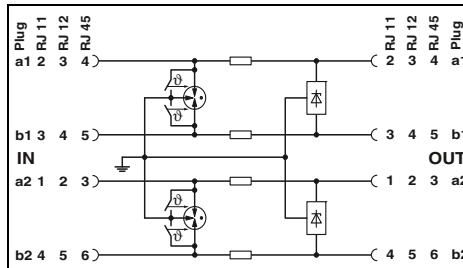

Technical data

Electrical data	
IEC test classification/EN type	B2 / C1 / C2 / C3 / D1
Maximum continuous operating voltage U_C	185 V DC / 130 V AC
Rated current	≤ 380 mA (25°C)
Nominal discharge current I_n (8/20) μ s	Core-Core ≤ 5 kA Core-Ground ≤ 5 kA 10 kA
Total discharge current I_{total} (8/20) μ s	
Protection level U_p	Core-Core ≤ 250 V (C1 - 1 kV/500 A) Core-Ground ≤ 250 V (C1 - 1 kV/500 A)
Cut-off frequency f_g (3 dB) In a 100 Ω system	Symmetrical typ. 50 MHz
General data	
Dimensions W/H/D	25 mm / 102 mm / 63.5 mm
Temperature range	-40°C ... 85°C
Connection method	RJ45/COMBICON
Connection data rigid / flexible / AWG	0.14 ... 1.5 mm ² / 0.14 ... 1.5 mm ² / 28 ... 16
Test standards	IEC 61643-21 / EN 61643-21

ERC

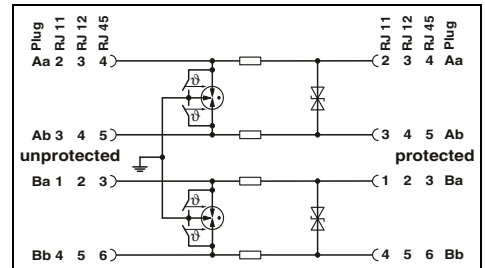

Technical data

Electrical data	
IEC test classification/EN type	B2 / C1 / C2 / C3 / D1
Maximum continuous operating voltage U_C	185 V DC / 130 V AC
Rated current	≤ 380 mA (25°C)
Nominal discharge current I_n (8/20) μ s	≤ 5 kA ≤ 5 kA 10 kA
Total discharge current I_{total} (8/20) μ s	
Protection level U_p	≤ 250 V (C1 - 500 A) ≤ 580 V (C1 - 500 A)
Cut-off frequency f_g (3 dB) In a 100 Ω system	25 MHz
General data	
Dimensions W/H/D	25 mm / 103 mm / 63 mm
Temperature range	-40°C ... 85°C
Connection method	RJ45/COMBICON
Connection data rigid / flexible / AWG	0.14 ... 1.5 mm ² / 0.14 ... 1.5 mm ² / 28 ... 16
Test standards	IEC 61643-21

Ordering data

Description	
DATATRAB , protective adapter for insertion in the data cable	
DT-TELE-RJ45	

Type	Order No.	Pcs./Pkt.
DT-TELE-RJ45	2882925	1

Ordering data

Description	
DATATRAB , protective adapter for insertion in the data cable	
DT-TELE-SHDSL	

Type	Order No.	Pcs./Pkt.
DT-TELE-SHDSL	2801593	1

DSL telecommunications PLUGTRAB PT-IQ

- Multi-stage status monitoring
- Group message via supply and remote signaling module
- Multi-stage, floating remote signaling
- System supplied via DIN rail bus
- Up to 28 protection modules per supply module
- Maximum ease of maintenance, thanks to the two-piece design
- Plugs are coded
- Impedance-neutral disconnection of plug for maintenance purposes
- PT-IQ...-UT base element with screw connection technology
- PT-IQ...-PT base element with Push-in connection technology
- Base element remains an integral part of the installation
- Corresponding replacement plugs can be found on our website



DSL



Double wire (loop), floating, connection 9/10 grounded directly, e.g., for DSL applications

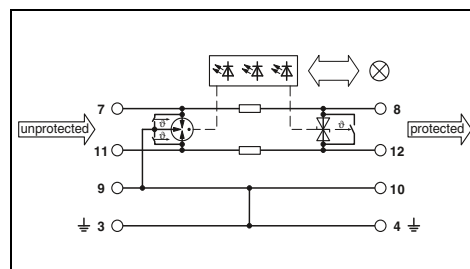

Technical data

Electrical data		C1 / C2 / C3 / D1 / B2
IEC test classification/EN type		180 V DC
Maximum continuous operating voltage U_c		150 mA (25°C)
Rated current		2.5 kA
Pulse discharge current I_{imp} (10/350) μ s		
Nominal discharge current I_n (8/20) μ s	Core-Core	10 kA
	Core-Ground	10 kA
		20 kA
Total discharge current I_{total} (8/20) μ s		
Protection level U_p	Core-Core	≤ 290 V (C3 - 50 A)
	Core-Ground	≤ 700 V (C3 - 50 A)
Cut-off frequency f_g (3 dB)	Symmetrical in the 150 Ω system	typ. 25 MHz
Resistance per path		1.2 Ω
General data		
Dimensions W/H/D		17.7 mm / 91.1 mm / 77.5 mm
Connection data rigid / flexible / AWG		0.2 ... 4 mm ² / 0.2 ... 2.5 mm ² / 24 ... 12
Temperature range		-40°C ... 70°C
Test standards		IEC 61643-21 / EN 61643-21 / EN 61000-6-2 / EN 61000-6-3
Remote indication contact		via DIN rail connector

Ordering data

Description	Type	Order No.	Pcs./Pkt.
DATA-PLUGTRAB			
	Screw connection technology	PT-IQ-1X2-TELE-UT	2800769
	Push-in connection technology	PT-IQ-1X2-TELE-PT	2801290

Accessories

Replacement plug	PT-IQ-1X2-TELE-P	2800782	1
PLUGTRAB , supply and remote signaling module			
	Screw connection technology	PT-IQ-PTB-UT	2800768
	Push-in connection technology	PT-IQ-PTB-PT	2801296

Surge protection and interference filters

Surge protection for information technology and telecommunications

DSL telecommunications PT 2-TELE

- For analog telecommunications
- Two-piece, pluggable
- Universal use
- High discharge capacity
- Plugs can be tested with CHECKMASTER 2

Notes:
Attenuation characteristics at phoenixcontact.net/products



DSL



3-conductor protection for DSL (ISDN U_{k0}) applications with common reference potential

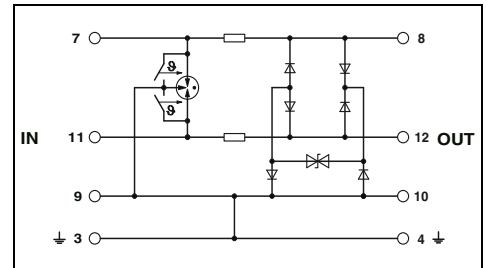

Technical data

Electrical data		
IEC test classification/EN type		B2 / C1 / C2 / C3 / D1
Maximum continuous operating voltage U _c		185 V DC / 130 V AC
Rated current		450 mA AC (45°C)
Pulse discharge current I _{imp} (10/350) μs		1 kA
Nominal discharge current I _n (8/20) μs	Core-Core	10 kA
	Core-Ground	10 kA
Total discharge current I _{total} (8/20) μs		18 kA
Max. discharge current I _{max} (8/20) μs		18 kA
Output voltage limitation at 1 kV/μs	Core-Core	≤ 300 V
	Core-Ground	≤ 300 V
Cut-off frequency f _g (3 dB)	Symmetrical in the 100 Ω system	typ. 20 MHz
Resistance per path		2.2 Ω
General data		
Dimensions W/H/D		17.7 mm / 90 mm / 65.5 mm
Connection data rigid / flexible / AWG		0.2 ... 4 mm ² / 0.2 ... 2.5 mm ² / 24 ... 12
Temperature range		-40°C ... 85°C
Test standards		IEC 61643-21 / EN 61643-21

Ordering data

Type	Order No.	Pcs./Pkt.
PT 2-TELE	2882828	10

Accessories

PT 2-TELE-ST	2838733	10
SSA 3-6	2839295	10
SSA 5-10	2839512	10

Description	DATA-PLUGTRAB , consisting of plug and base element
--------------------	--

Replacement plug	Shield fast connection For Ø 3-6 mm For Ø 5-10 mm
-------------------------	--

DSL telecommunications

- For surface mounting
- Three TAE6 slots
- For two N-coded and one F-coded end device
- Suitable for ADSL and VDSL
- Main areas of application: phone terminals, answering machines, modems, and fax machines



TAE outlet box (NFN) for VDSL

ERIC

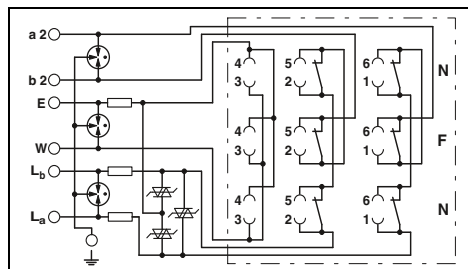

Technical data

Electrical data		
IEC test classification/EN type		B2 / C1 / C2 / C3 / D1
Nominal voltage U_N		60 V DC
Maximum continuous operating voltage U_C		185 V DC
Rated current		450 mA ($\leq 40^\circ\text{C}$)
Nominal discharge current I_n (8/20) μs	Core-Core	5 kA
	Core-Ground	5 kA
Total discharge current I_{total} (8/20) μs		10 kA
Protection level U_p	Core-Core	≤ 250 V (C2 - 10 kV / 5 kA)
	Core-Ground	≤ 500 V (C2 - 10 kV / 5 kA)
Output voltage limitation at 1 kV/ μs	Core-Core	≤ 250 V
	Core-Ground	≤ 450 V
Cut-off frequency f_g (3 dB)	Core-Core	typ. 2 MHz
In a 600 Ω system		
General data		
Dimensions W/H/D		65 mm / 27 mm / 80 mm
Temperature range		$-40^\circ\text{C} \dots 80^\circ\text{C}$
Connection method		Screw connection & TAE 6
Test standards		DIN EN 61643-21 / IEC 61643-21

Ordering data

Description	For country-specific use in	Type	Order No.	Pcs./Pkt.
TAE outlet box (NFN) with surge protection for analog telecommunications interfaces		TAE-TRAB FM-NFN-AP	2749628	1
Surface-mounted socket	D			



2-conductor,
with common reference potential



DSL



2-conductor, coarse protection,
with failsafe contact



2-conductor, coarse protection,
with failsafe contact and current protection
(Powercross)

ERIC

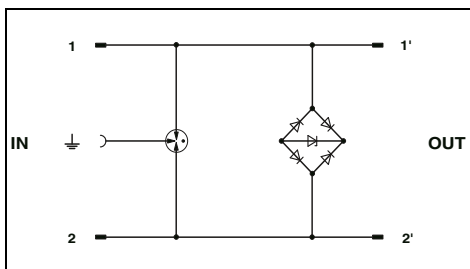

Technical data

B2 / C2 / C3 / D1 / C1
 ± 6 V DC
 1.5 A (25°C)
 1 kA
 350 A
 5 kA
 10 kA
 ≤ 18 V (C3 - 7.5 kV/100 A)
 ≤ 700 V (C3 - 7.5 kV / 100 A, spike)

9.5 mm / 21 mm / 53.5 mm
 -25°C ... 75°C
 IEC 61643-21

Ordering data

Type	Order No.	Pcs./Pkt.
CTM ISDN	2838555	10

Accessories

CTM 10-MAG	2838610	5
CTM EST	2838649	10

ERIC

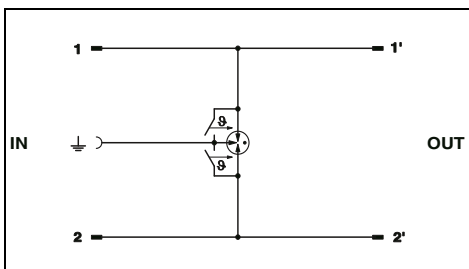

Technical data

A2 / B1 / B2 / B3 / C1 / C2 / C3 / D1 / D2
 ± 180 V DC
 1.5 A (25°C)
 1 kA
 -
 5 kA
 10 kA
 -
 ≤ 1 kV (C3 - 7.5 kV / 100 A, spike)

9.5 mm / 21 mm / 53.5 mm
 -40°C ... 85°C
 IEC 61643-21

Ordering data

Type	Order No.	Pcs./Pkt.
CTM 2X1-180DC-GS	2838636	10

Accessories

CTM 10-MAG	2838610	5
CTM EST	2838649	10

ERIC

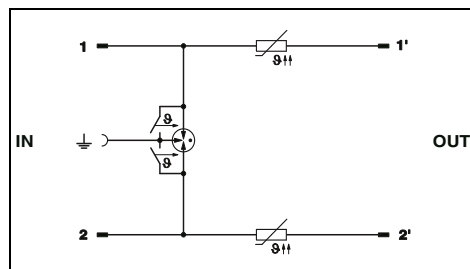

Technical data

A2 / B1 / B2 / B3 / C1 / C2 / C3 / D1 / D2
 ± 180 V DC
 120 mA (25°C)
 1 kA
 -
 5 kA
 10 kA
 -
 ≤ 1 kV (C3 - 7.5 kV / 100 A, spike)

9.5 mm / 21 mm / 53.5 mm
 -40°C ... 85°C
 IEC 61643-21

Ordering data

Type	Order No.	Pcs./Pkt.
CTM 2X1-180DC-GS-P	2838623	10

Accessories

CTM 10-MAG	2838610	5
CTM EST	2838649	10

Surge protection and interference filters

Surge protection for information technology and telecommunications

LSA-PLUS coarse protection magazine

- For use in CT-TERMIBLOCK or in LSA-PLUS and LSA-PROFIL disconnect and terminal strips

CT 10-2/2-GS

- For fitting with 20 two-electrode arresters filled with inert gas
- Common mode voltage coarse protection for 20 signal wires

CT ...-2/2-GS/3E

- Fitted with up to 10 three-electrode arresters filled with inert gas
- When the gas-filled arrester is triggered, the potentials of the three connections a-b- \perp are equalized
- Coarse protection both in the normal mode voltage branch and the common mode voltage branch for 10 double wires

Notes:
For dimensional drawings, see phoenixcontact.net/products



For 10 double wires (loops) and 20 two-electrode GDTs



For 10 double wires (loops) and 10 three-electrode GDTs

ERC

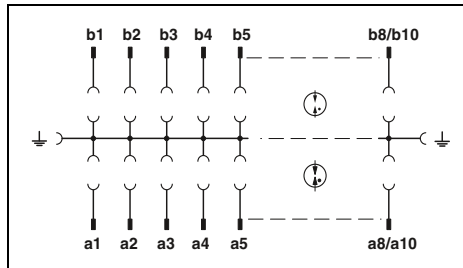

ERC

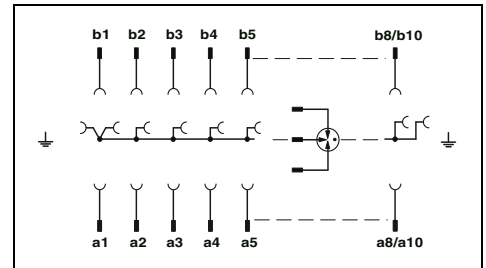

Ordering data

Type	Order No.	Pcs./Pkt.
CT 10-2/2-GS	2765398	5

Ordering data

Type	Order No.	Pcs./Pkt.
CT 10-2/2-GS/3E	2765408	5
CT 10-2/2-GS/3E-110AC	2920829	10

Accessories

Type	Order No.	Pcs./Pkt.
SVP 2E- 48AC	2788919	10
SVP 2E-110AC	2765534	10

Accessories

Type	Order No.	Pcs./Pkt.
SVP 3E-110AC	2765521	10

Description	Voltage U _N
Coarse protection magazine, to accommodate 20 two-electrode gas-filled surge arresters, type H, unassembled, model: 10 double wires	
Coarse protection magazine, for 10 double wires	
unassembled , for accommodating 10 three-electrode gas-filled surge arresters	
assembled , with 10 three-electrode gas-filled surge arresters	110 V AC
2-electrode gas-filled surge arrester filled with inert gas, type H, for use in CT 10-2/2-GS coarse protection magazine	48 V AC 110 V AC
3-electrode gas-filled surge arrester filled with inert gas, for use in CT 10-2/2-GS/3E coarse protection magazine	110 V AC

CT-TERMIBLOCK

- Screw terminal block
- For COMTRAB protective plugs
- Automatically closing feed-through/disconnect contacts
- Ground terminal blocks on both sides with plug-in connection for the protective plugs used
- Mounting on DIN rails in accordance with EN 60715

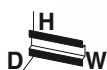

For accommodating the CT and CTM protective plugs, with screw connection



Magazine for 10 CTM

General data	
Dimensions W/H/D	
Connection data rigid / flexible / AWG	
Temperature range	
Degree of protection in acc. with IEC 60529/EN 60529	
Flammability rating in accordance with UL 94	

Technical data			
Dimensions W/H/D	118 mm / 43 mm / 40.9 mm		
Connection data rigid / flexible / AWG	0.2...2.5 mm ² / 0.2...2.5 mm ² / 24 ... 12		
Temperature range	-40°C ... 85°C		
Degree of protection in acc. with IEC 60529/EN 60529	IP20		
Flammability rating in accordance with UL 94	V2		

Technical data			
Dimensions W/H/D	112.5 mm / 21.8 mm / 44 mm		
Connection data rigid / flexible / AWG	- mm ² / - mm ² / -		
Temperature range	-25°C ... 75°C		
Degree of protection in acc. with IEC 60529/EN 60529	IP20		
Flammability rating in accordance with UL 94	V-0		

Description	

Ordering data			
Type	Order No.	Pcs./Pkt.	
CT-TERMIBLOCK 10 DA	0441711	10	
Magazine, with grounding rail for accommodating up to 10 LSA-PLUS protective plugs (CTM...), for insertion in CT-TERMIBLOCK or LSA-PLUS disconnect strip			

Ordering data			
Type	Order No.	Pcs./Pkt.	
CTM 10-MAG	2838610	5	

COMTRAB disconnect strip

- LSA-PLUS disconnect strip
- For COMTRAB protective plugs
- For up to 10 CTM plugs

Notes:	
For dimensional drawings, see phoenixcontact.net/products	



For accommodating the CT and CTM protective plugs, with LSA-PLUS connection



Ground rail for CTM protective plug

Description	
LSA-PLUS disconnect strip for accommodating the CTM and CT 10 protection modules, model: 10 double wires	
Ground rail for CTM protective plug when used in combination with LSA-PLUS disconnect strip, model: 10 double wires	

Ordering data			
Type	Order No.	Pcs./Pkt.	
CT 10-TL	2765356	5	

Ordering data			
Type	Order No.	Pcs./Pkt.	
CT 1-10-ES	2765547	10	



You won't lose reception with COAXTRAB

Transceiver systems are generally considered to be particularly susceptible to surge voltages. Antenna cables which extend beyond a building and are usually very long, plus the antennas themselves, are directly exposed to atmospheric discharge.

Cables with a coaxial structure and therefore favorable EMC properties are primarily used in antenna systems. However, the risk of surge voltage coupling in antenna cables and potential transfer through to the sensitive interfaces of transceiver systems is not eliminated.

Thanks to interface-optimized surge protective devices, the COAXTRAB product range significantly increases safety for transceiver equipment. The aim of such safety measures is to increase the availability and operability of the devices affected.

i Your web code: **#0146**

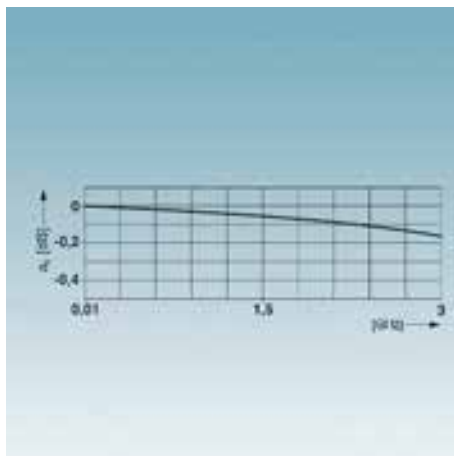

Shielding

Good shielding properties are vital for a clean transmission. The robust metal housings provide ideal shielding properties and are also suitable for use in harsh industrial environments.

Customized products

Appropriate protective devices are available for all applications including SAT receiver systems, mobile phones, and video monitoring.

The very low attenuation values ensure that data transmission is clean.

Performance classes

The protective devices conform to standards in all performance classes. This applies for coarse protection in accordance with Category D1, 10/350 μ s and for fine protection in accordance with Category C2 and C1, 8/20 μ s.



Connection technology

The right connection technology to suit the application: F connector, TV connector, type N, 7/16, BNC, SMA.

Surge protection and interference filters

Surge protection for transceiver systems

Selection guide

The interface matrix indicates the suitable surge protective device for a specific interface.

1) The PT-IQ-PTB-UT supply module is required in order to operate the PT-IQ series.













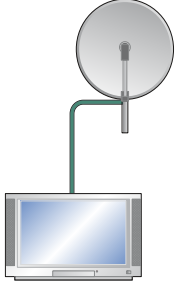

Explanation of the IEC categories



LPZ zone	Test category for SPD in acc. with IEC 61643-21	Test class for SPD in acc. with IEC 61643-11
0/1	D1	I
1/2	C2	II
2/3	C1	III

Interface-based product selection for surge protection

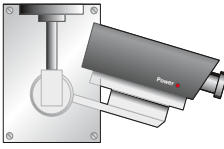
The STOP-IT (Selection of Protection for Information Technology) selection guide provides support in choosing your surge protection solution for a variety of additional interfaces in information and MCR technology.

i Your web code: #2079

Technology	Interface	Connection technology
	GPS, GSM, UMTS, LTE (900, 1800, 1900 MHz)	 Type N
	GSM, UMTS, LTE (without COAX DC supply) (900, 1800, 1900 MHz)	 Type N
	WiMAX, LTE (2.4 ... 6 GHz)	 Type N
	GSM, Industrial Wireless (2.4 GHz)	 Type SMA
	Satellite television (upstream of the antenna distributor)	 Type F
	Satellite television (upstream of the SAT receiver or TV)	 Type F
	Cable/terrestrial TV	  Type F + IEC
		 Type IEC
		  Type F + IEC
	Video monitoring (coaxial connection)	 Type BNC
	Video monitoring (2-wire connection)	

	Screw connection
	Schuko plug-in connection
	Coaxial plug-in connection

IEC category	Protected wires	Surge protective device (SPD)	Order No.	Page
D1/C2/C3	2	CN-UB-280DC-3	2801050 / 2801051	200
D1/C2/C3	2	CN-UB-70-6	2803166 / 2803153	200
D1/C2/C3	2	CN-LAMBDA/4-2.25	2801057 / 2801056	202
D1/C2/C3	2	CN-LAMBDA/4-5.9	2838490 / 2800023	202
D1/C2/C3	2	CSMA-LAMBDA/4-2.0-BS-SET	2800491	202
D1/C2/C1	5 x 2	C-SAT-BOX	2880561	204
D1/C2/C1	2	C-TV-SAT	2856993	204
D1/C2/C3 & T3	2	MNT-TV-SAT	2882297	88
D1/C2/C1	2	C-TV/HIFI	2857002	204
D1/C2/C3 & T3	2	MNT-TV-SAT	2882297	88
D1/C2/C3	2	C-UFB-5DC/E	2782300	200
D1/C2/C3	2	C-UFB-5DC/E 75	2763604	200
D1/C2/C1	2	PT-IQ-5-HF+F-5DC-UT	2800798	173

Surge protection and interference filters

Surge protection for transceiver systems

Protection of video signals

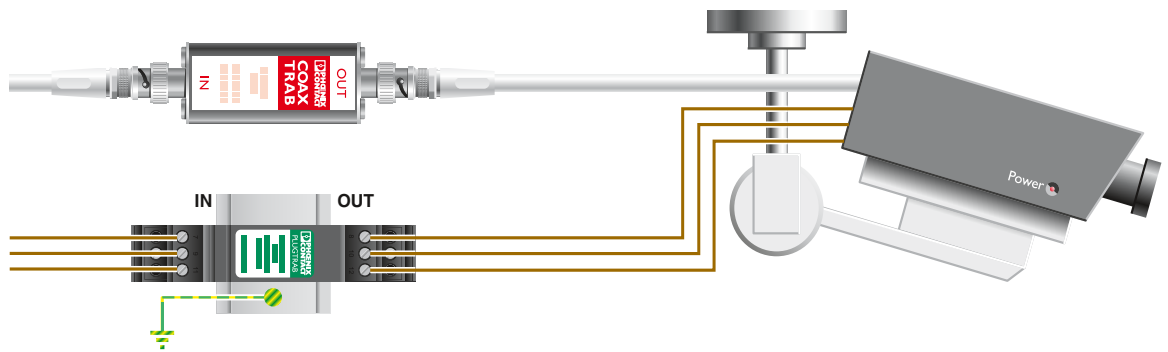
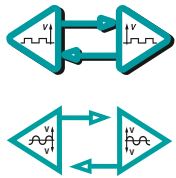

C-UBF 5DC
2797858
Page 201

PT 3-HF-12DC-ST + PT 1X2-BE
2858043 and 2856113
Page 168

Protection of the SAT antenna connection

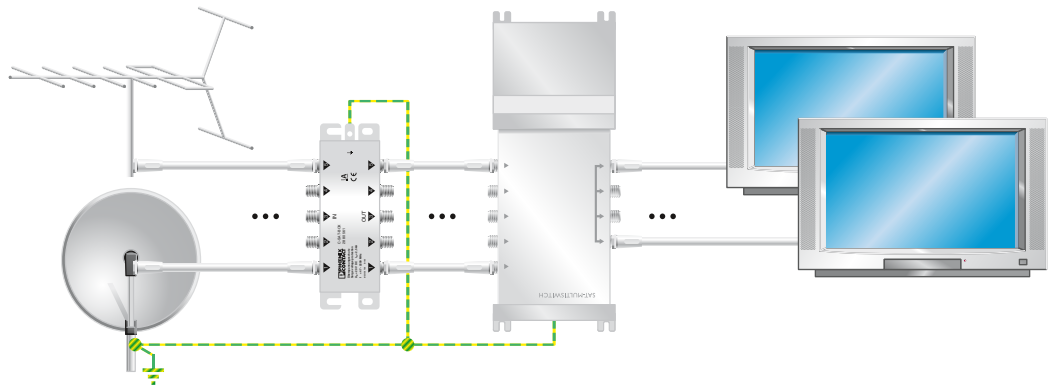
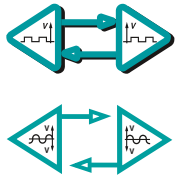

C-SAT-BOX
2880561
Page 204

Protection of the cable TV connection

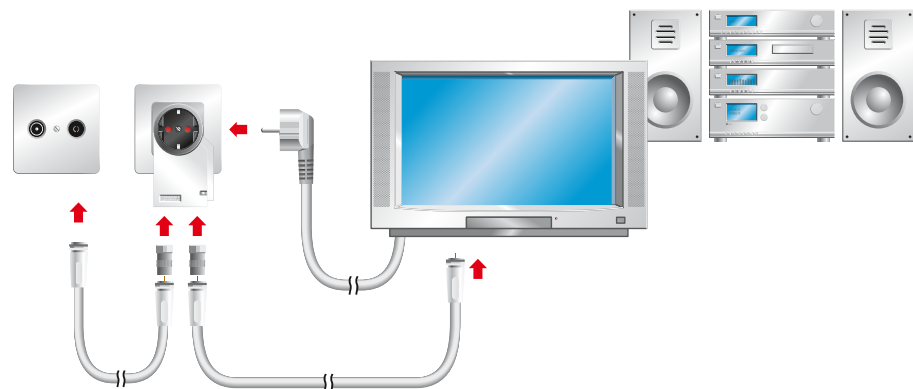
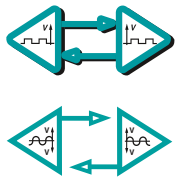

MNT-TV-SAT D
2882284
Page 89

Protection of antenna signals

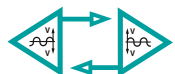

- GPS
- GSM
- UMTS

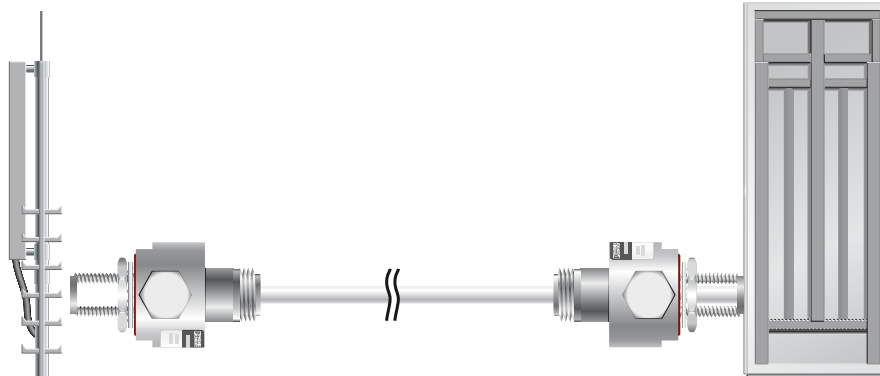

CN-UB-280DC-3-BB

2801050

Page 200

Optional

CN-LAMBDA/4-2.25-BB

2801057

Page 202

Surge protection and interference filters

Surge protection for transceiver systems

Antenna systems

- For antennas with N and BNC connection
- High transmission capacities even for frequencies up to 6 GHz
- Mounting plate enables fixed mounting, e.g., in a control cabinet
- The protective adapters can also be used in a 75 Ω system with 50 Ω BNC connectors
- For the CN-UB-280DC, the gas-filled surge arrester can be replaced in case of malfunction



For GSM systems (0 - 3 GHz), grounded shield, connection: type N



For GSM systems (0 - 6 GHz), grounded shield, connection: type N

Notes:
Attenuation characteristics at phoenixcontact.net/products

ERC

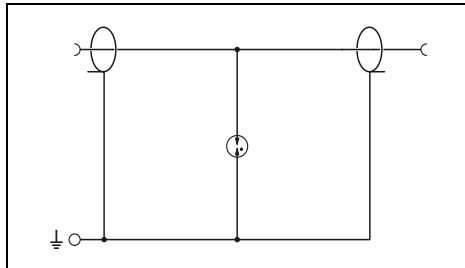

ERC

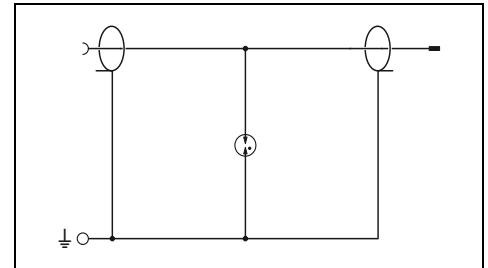

Technical data

Electrical data	
IEC test classification/EN type	
Maximum continuous operating voltage U_C	
Rated current	
Nominal discharge current I_n (8/20) μ s	
	Core-Shield
	Core-Ground
Total discharge current I_{total} (8/20) μ s	
Protection level U_p	
	Core-Shield
	Core-Ground
Cut-off frequency f_g (3 dB)	
Asymmetrical in the 50 Ω system	
Standing wave ratio SWR in a 50 Ω system	
Permissible. RF power P_{max}	
General data	
Dimensions W/H/D	
Temperature range	
Degree of protection in acc. with IEC 60529/EN 60529	
Connection method	
Test standards	

C2 / C3 / D1
280 V DC
5 A (25°C)
20 kA
20 kA
20 kA
≤ 900 V (C1 - 1 kV/500 A)
≤ 900 V (C1 - 1 kV/500 A)
> 3 GHz
typ. 1.15 (≤ 3 GHz)
700 W (VSWR = 1.1)
31 mm / 33.5 mm / -
-40°C ... 80°C
IP55
N connector 50 Ω
IEC 61643-21/A1 / EN 61643-21/A1

Technical data	
C2 / C3 / D1	
70 V DC / 50 V AC	
10 A	
5 kA	
5 kA	
5 kA	
≤ 800 V (C2 - 4 kV / 2 kA)	
≤ 800 V (C2 - 4 kV / 2 kA)	
> 6 GHz	
typ. 1.15 (≤ 6 GHz)	
30 W (VSWR = 1.15)	
24 mm / 24 mm / 50 mm	
-40°C ... 90°C	
IP68	
N connector 50 Ω	
IEC 61643-21	

Ordering data

Description	
COAXTRAB, protective adapter for antenna connections	
	Female-female
	Male-female
COAXTRAB, as surge protection for coaxial cables, connection via male and female connectors	
	BNC 50 Ω
	BNC 75 Ω
	BNC 50 Ω

Type	Order No.	Pcs./Pkt.
CN-UB-280DC-3-BB	2801050	1
CN-UB-280DC-3-SB	2801051	1

Ordering data

Type	Order No.	Pcs./Pkt.
CN-UB-70DC-6-BB	2803166	1
CN-UB-70DC-6-SB	2803153	1

Accessories

Mounting plate , for individual attachment to housing panels	
	straight
	angled
Adapter , insertion loss <0.3 dB at 2.4 GHz	
N (male) -> SMA (female)	
Adapter cable (pigtail)	
0.3 m, N (female) -> SMA (male)	
0.5 m, N (female) -> RSMA (male)	

Type	Order No.	Pcs./Pkt.
CN-UB/MP	2818135	10
CN-UB/MP-90DEG-50	2803137	1
RAD-ADP-N/M-SMA/F	2917036	1
RAD-PIG-EF316-N-SMA	2867694	1
RAD-PIG-EF316-N-RSMA	2701402	1

Accessories

Type	Order No.	Pcs./Pkt.
CN-UB/MP	2818135	10
CN-UB/MP-90DEG-50	2803137	1
RAD-ADP-N/M-SMA/F	2917036	1
RAD-PIG-EF316-N-SMA	2867694	1
RAD-PIG-EF316-N-RSMA	2701402	1



For TETRA systems (380 MHz - 470 MHz), floating shield, connection: type N



For video systems, floating shield, coarse protection, connection: BNC



For video systems, floating shield, connection: BNC

ERC

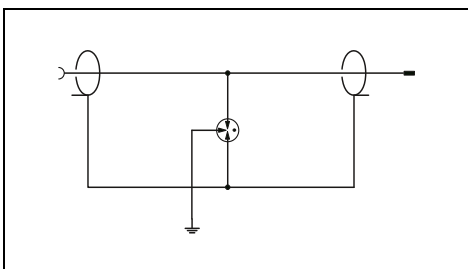

Technical data

C2 / C3 / D1
180 V DC / 130 V AC
5 A
(25°C)

5 kA
5 kA
10 kA

≤ 700 V
(C2 - 10 kV / 5 kA)
≤ 500 V
(C2 - 10 kV / 5 kA)

typ. 1 GHz
typ. 1.2 (≤ 200 MHz)
300 W (VSWR = 1.1)

25.4 mm / 25.4 mm / 96 mm
-40°C ... 80°C
IP20
N connector 50 Ω
IEC 61643-21 / EN 61643-21

ERC

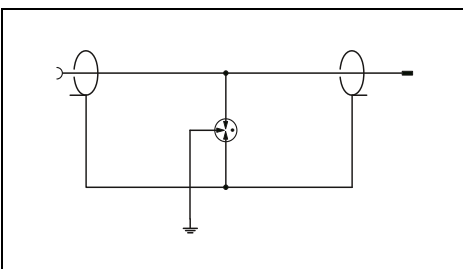

Technical data

C2 / C3 / D1
180 V DC / 130 V AC
3.5 A
(25°C)

5 kA
5 kA
10 kA

≤ 700 V
(C2 - 10 kV / 5 kA)
≤ 500 V
(C2 - 10 kV / 5 kA)

typ. 1 GHz
typ. 1.3 (≤ 150 MHz)
300 W (VSWR = 1.1)

25.4 mm / 25.4 mm / 80 mm
-40°C ... 80°C
IP20
BNC 50 Ω
IEC 61643-21 / EN 61643-21

ERC

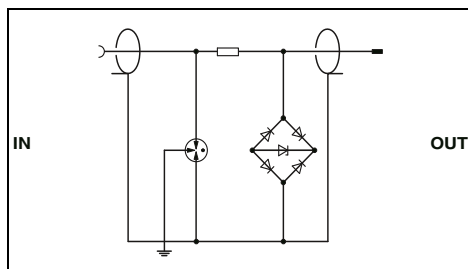

Technical data

... 5DC/E	... 24DC/E	... 5DC/E 75
C2 / C3 / D1	C2 / C3 / D1	C2 / C3 / D1
5 V DC	30 V DC	5 V DC
185 mA (25°C)	185 mA (25°C)	185 mA (25°C)

10 kA	10 kA	10 kA
10 kA	10 kA	10 kA
20 kA	20 kA	20 kA

≤ 25 V (C3 - 10 A)	≤ 50 V (C3 - 10 A)	≤ 25 V (C3 - 10 A)
≤ 500 V (C3 - 10 A)	≤ 500 V (C3 - 10 A)	≤ 500 V (C3 - 10 A)

typ. 90 MHz	typ. 90 MHz	typ. 80 MHz
		-

BNC 50 Ω	BNC 50 Ω	BNC 75 Ω
		IEC 61643-21

Ordering data

Type	Order No.	Pcs./Pkt.
CN-UB/E-BB	2817686	1
CN-UB/E	2763691	1

Accessories

Ordering data

Type	Order No.	Pcs./Pkt.
C-UB/E	2763701	10

Accessories

Ordering data

Type	Order No.	Pcs./Pkt.
C-UBB- 5DC/E	2782300	10
C-UBB- 5DC/E 75	2763604	10
C-UBB-24DC/E	2782313	10

Accessories

Surge protection and interference filters

Surge protection for transceiver systems

Antenna systems

- For antennas with N and SMA connection
- High transmission capacities even for frequencies up to 6 GHz
- Maintenance-free surge protection with Lambda/4 technology
- Low protection level

Notes:
Attenuation characteristics at phoenixcontact.net/products



For TETRA systems (380 MHz - 470 MHz), grounded shield, connection: type N



For GSM systems (0.8 GHz - 2.25 GHz), grounded shield, connection: type N

ERC

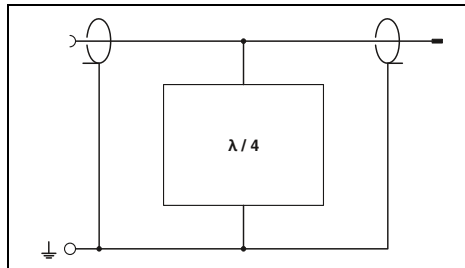

ERC

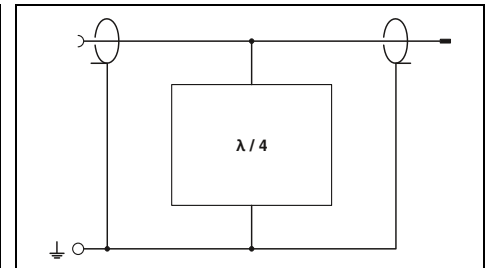

Technical data

Electrical data	
IEC test classification/EN type	C2 / C3 / D1
Rated current	5 A (25°C)
Nominal discharge current I_n (8/20) μ s	Core-Shield 20 kA Core-Ground 20 kA
Total discharge current I_{total} (8/20) μ s	30 kA
Protection level U_p	Core-Ground ≤ 95 V (C2 - 10 kV / 5 kA) Core-Shield ≤ 95 V (C2 - 10 kV / 5 kA)
Frequency range	380 MHz ... 470 MHz
Standing wave ratio SWR in a 50 Ω system	typ. 1.05 ($\leq 1,15$)
Permissible. RF power P_{max}	≤ 800 W
General data	
Temperature range	-40°C ... 90°C
Degree of protection in acc. with IEC 60529/EN 60529	IP68
Connection method	N connector
Test standards	IEC 61643-21

Technical data

Electrical data	
IEC test classification/EN type	C2 / C3 / D1
Rated current	-
Nominal discharge current I_n (8/20) μ s	50 kA
Total discharge current I_{total} (8/20) μ s	50 kA
Protection level U_p	-
Frequency range	≤ 5 V (C1 - 1 kV/500 A) ≤ 5 V (C1 - 1 kV/500 A) 0.8 GHz ... 2.25 GHz
Standing wave ratio SWR in a 50 Ω system	typ. 1.2
Permissible. RF power P_{max}	≤ 500 W
General data	
Temperature range	-40°C ... 85°C
Degree of protection in acc. with IEC 60529/EN 60529	IP68
Connection method	N connector 50 Ω
Test standards	IEC 61643-21/A1 / EN 61643-21/A1

Ordering data

Description	
COAXTRAB, protective adapter for antenna connections with Lambda/4 technology	Female-female Male-female
Surge protection for UMTS and quad-band GSM antenna, with SMA plug and SMA coupling	

Type	Order No.	Pcs./Pkt.
CN-LAMBDA/4-0.47-BB	2800021	1
CN-LAMBDA/4-0.47-SB	2800022	1

Ordering data

Type	Order No.	Pcs./Pkt.
CN-LAMBDA/4-2.25-BB	2801057	1
CN-LAMBDA/4-2.25-SB	2801056	1

Accessories

Mounting plate, for individual attachment to housing panels	straight angled
Adapter, insertion loss <0.3 dB at 2.4 GHz	N (male) -> SMA (female)
Adapter cable (pigtail)	0.3 m, N (female) -> SMA (male) 0.5 m, N (female) -> RSMA (male)

Type	Order No.	Pcs./Pkt.
CN-UB/MP CN-UB/MP-90DEG-50	2803137	1
RAD-ADP-N/M-SMA/F	2917036	1
RAD-PIG-EF316-N-SMA RAD-PIG-EF316-N-RSMA	2867694 2701402	1 1

Accessories

Type	Order No.	Pcs./Pkt.
CN-UB/MP CN-UB/MP-90DEG-50	2818135 2803137	10 1
RAD-ADP-N/M-SMA/F	2917036	1
RAD-PIG-EF316-N-SMA RAD-PIG-EF316-N-RSMA	2867694 2701402	1 1



For GSM systems (0.8 GHz - 2.25 GHz), grounded shield, connection: SMA



For GSM and WIMAX systems (2.4 GHz - 5.9 GHz), grounded shield, connection: type N

ERC

ERC

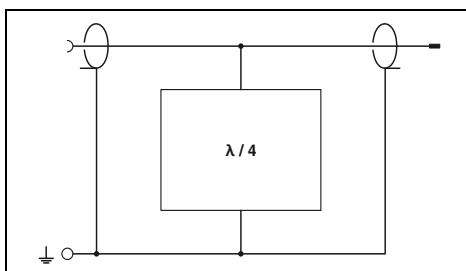
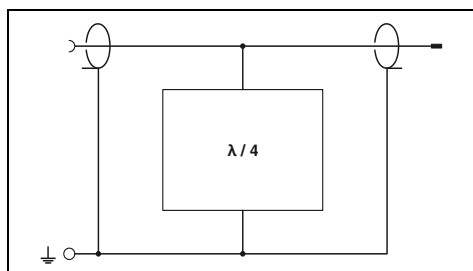

Technical data

Technical data

C2 / C3 / D1
2 A (25°C)

6 kA
6 kA
6 kA

≤ 5 V (C1 - 1 kV/500 A)
-
0.8 GHz ... 2.25 GHz
≤ 1.2 (0.8 GHz ... 2.25 GHz)
≤ 110 W (VSWR = 1.0)

C2 / C3 / D1
5 A (25°C)

50 kA
50 kA
60 kA

≤ 11 V (6 kV / 3 kA)
≤ 11 V (6 kV / 3 kA)
2.4 GHz ... 5.9 GHz
typ. 1.1 (≤ 1.20 (2.4 GHz...5.9 GHz))
≤ 500 W

-40°C ... 70°C
IP55
SMA connector
IEC 61643-21/A1 / EN 61643-21/A1

-40°C ... 90°C
IP68
N connector
IEC 61643-21

Ordering data

Ordering data

Type	Order No.	Pcs./Pkt.
CSMA-LAMBDA/4-2.0-BS-SET	2800491	1

Type	Order No.	Pcs./Pkt.
CN-LAMBDA/4-5.9-BB	2838490	1
CN-LAMBDA/4-5.9-SB	2800023	1

Accessories

Accessories

Type	Order No.	Pcs./Pkt.
CN-UB/MP	2818135	10
CN-UB/MP-90DEG-50	2803137	1

Type	Order No.	Pcs./Pkt.
CN-UB/MP-90DEG-50	2803137	1
RAD-ADP-N/M-SMA/F	2917036	1
RAD-PIG-EF316-N-RSMA	2701402	1

Surge protection and interference filters

Surge protection for transceiver systems

TV and radio systems

Notes:
Attenuation characteristics at phoenixcontact.net/products

C-SAT-BOX

- Protection for antenna inputs in satellite receiver technology
- Use upstream of antenna distributor or multi-switch
- Analog and digital SAT signals
- Terrestrial antenna signals
- Direct wall mounting supported

C-TV-SAT and C-TV/HIFI

- Protective adapter for antenna connections
- Use on broadband cable or SAT connection
- TV (IEC) or F connector



For antenna distributor or multi-switch, grounded shield, connection: F

ERC

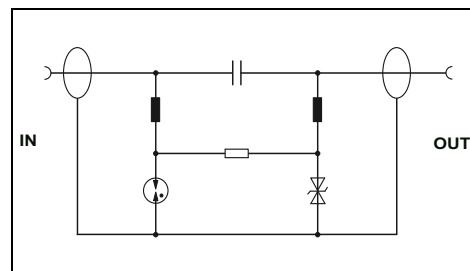

Electrical data	
IEC test classification/EN type	B2 / C1 / C2 / C3 / D1
Maximum continuous operating voltage U_c	20 V DC
Rated current	400 mA
Nominal discharge current I_n (8/20) μ s	Core-Shield 2.5 kA
	Core-Ground -
Total discharge current I_{total} (8/20) μ s	10 kA
Output voltage limitation at 1 kV/ μ s	Core-Shield \leq 80 V
	Core-Ground -
Cut-off frequency f_g (3 dB)	
In a 75 Ω system	Symm. / asymm. (shield)
	- / > 2.5 GHz
General data	
Dimensions W/H/D	144.9 mm / 31.5 mm / 71.5 mm
Temperature range	-25°C ... 55°C
Degree of protection in acc. with IEC 60529/EN 60529	IP40
Flammability rating in accordance with UL 94	-
Connection method	F connector
Test standards	IEC 61643-21 / EN 61643-21 / EN 50083-2

Technical data

Description
COAXTRAB , protective device for antenna distributors/ multi-switches for insertion in the antenna line
COAXTRAB , surge protection adapter
F connector TV connector

Ordering data		
Type	Order No.	Pcs./Pkt.
C-SAT-BOX	2880561	1

Adapter , to connect the C-SAT-BOX with antenna distributors with a pitch of 20 mm (e.g. ASTRO, SPAUN)
Connection cable , to connect the C-SAT-BOX with the antenna distributor, length: 0.2 m

Accessories		
ADAPTER KOAX TYP F	2880972	5
KBL-SAT/20	2880985	5



For TV equipment and SAT systems,
grounded shield, connection: F or TV (IEC)

ERC

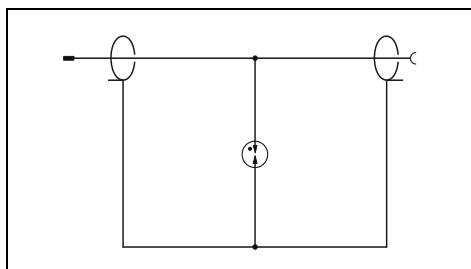

Technical data

F-connector	TV connector
C1 / C2 / C3 / D1	C1 / C2 / C3 / D1
24 V DC	24 V DC
1.5 A (25°C)	1.5 A (25°C)
2.5 kA	2.5 kA
-	-
≤ 600 V	≤ 600 V
- / > 3 GHz	- / > 1 GHz

28 mm / 44 mm / 66 mm
-25°C ... 75°C
IP20
V-0

F connector PAL-TV (IEC 169-2)
IEC 61643-21 / EN 61643-21 / EN 50083

Ordering data

Type	Order No.	Pcs./Pkt.
C-TV-SAT	2856993	1
C-TV/HIFI	2857002	1

Accessories

--	--	--



Reliable signals by means of interference suppression filters with integrated surge protection

High-frequency interference can also be caused by power electronics equipment. Switching operations triggered mechanically or electronically generate pulse-like and high-frequency interference voltages. These voltages spread unimpeded across the cable network. All the devices within this cable network are affected. Data errors, uncontrolled functions, and system crashes can result, with data processing devices at particular risk.

Interference voltage filters for power supply units

Interference suppression filters limit conducted high-frequency interference voltages. Devices used in data processing or automation particularly benefit from a clean power supply. The end result is safe operation and reliable measured results. Thanks to the integrated surge protection, surge pulses are effectively limited and surge currents are safely discharged.

i Your web code: #0149

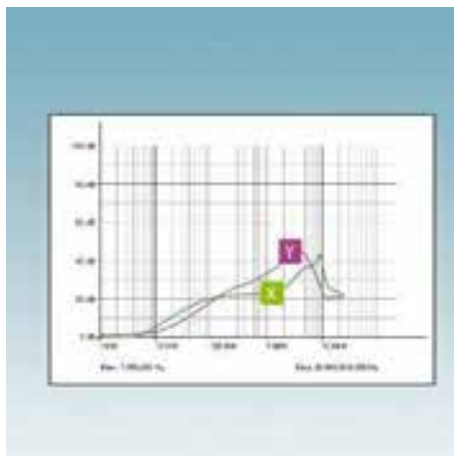
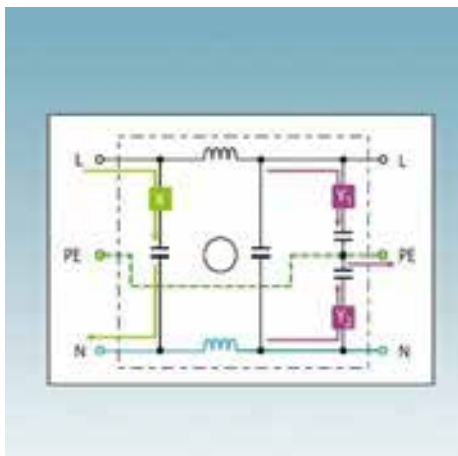

Mains interference filters – Operating principle and range

Filtering of symmetrical disturbance variables

X - Interference voltages between the phase and neutral conductor are filtered.

Filtering of asymmetrical disturbance variables

Y₁, Y₂ - The opposite grounded interference voltages from phase to PE and from the neutral conductor to PE are filtered.

Operating range of filters

An attenuation curve diagram illustrates the effective operating range of mains interference filters. The relevant frequency-dependent attenuation can be read according to the symmetrical or asymmetrical filter circuit.

Interference suppression filters with surge protection

Interference suppression filters with integrated surge protection have two tasks: they absorb transient overvoltages and also limit high-frequency interference voltages and interference currents.

Versions are available for the power supply and for signal circuits.

Surge protection and interference filters

Interference suppression filters

DIN-rail-mountable device protection with interference suppression filter, SFP filter

- Combined protective circuit for absorbing transient surge voltages and high-frequency interference voltages
- Thermal monitoring of the protective circuit
- Disconnection status signaled via floating remote indication contact
- Can be installed in industrial environments



20 A nominal current

Total width 112 mm

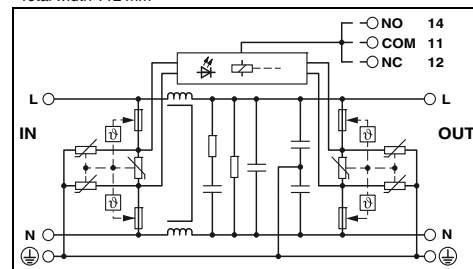

Technical data

Electrical data	... 120AC	... 230AC
IEC test classification / EN type / SPD type (UL)	- / T3 / 2CA	- / T3 / -
Nominal voltage U_N	120 V AC (TN) / 120 V AC (TT - only in use with RCD) / 120 V AC (IT)	240 V AC (TN) / 240 V AC (TT - only in use with RCD) / 240 V AC (IT - only in use with RCD)
Maximum continuous operating voltage U_c	150 V AC	264 V AC
Nominal load current I_L	20 A (40°C)	20 A (40°C)
Combined surge U_{OC}	6 kV (3 kA)	10 kV (5 kA)
Protection level U_p	≤ 0.45 kV	≤ 1 kV
Response time t_A	≤ 25 ns	≤ 25 ns
Maximum backup fuse in acc. with IEC	20 A (MCB B/general purpose)	20 A (MCB B/general purpose)
Input attenuation a_i		
	Symmetrical	20 dB (≥ 100 kHz / 50 Ω)
	Asymmetrical	30 dB (≥ 1 MHz / 50 Ω)
Inductance	2x 1 mH $\pm 30\%$ (with current compensation)	2x 1 mH $\pm 30\%$ (with current compensation)
General data		
Dimensions W/H/D		112 mm / 86.6 mm / 79 mm
Connection data rigid / flexible / AWG		2.5 mm ² ... 6 mm ² / 2.5 mm ² ... 4 mm ² / 14 ... 10
Temperature range	-25°C ... 70°C	-25°C ... 70°C
Flammability rating in accordance with UL 94		V-0
Test standards		IEC 61643-11 / EN 61643-11
Remote indication contact		PDT contact
Connection data rigid / flexible / AWG		0.14 mm ² ... 1.5 mm ² / 0.14 mm ² ... 1.5 mm ² / 26 ... 16
Max. operating voltage		250 V AC / 250 V DC
Max. operating current		1 A AC / 1 A DC

Ordering data

Description	Voltage U_N	Type	Order No.	Pcs./Pkt.
SFP-TRAB , DIN-rail-mountable device protection TVSS with integrated mains interference filter and visual signaling				
Nominal current: 20 A	120 V AC	SFP 1-20/120AC	2856702	1
Nominal current: 20 A	240 V AC	SFP 1-20/230AC	2859987	1
SFP-TRAB , DIN-rail-mountable device protection with integrated mains interference filter and visual signaling				
Nominal current: 5 A	120 V AC			
Nominal current: 10 A	120 V AC			
Nominal current: 15 A	120 V AC			



5 A nominal current



10 A nominal current



15 A nominal current

Total width 112 mm

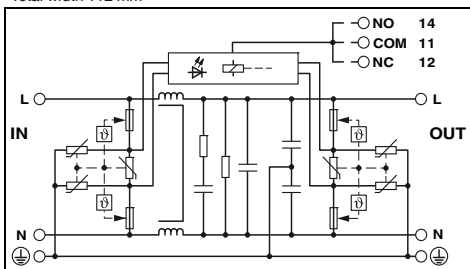

Technical data

- / T3 / 2CA
120 V AC (TN) /
120 V AC (TT - only in use with RCD) /
120 V AC (IT)

150 V AC
5 A (70°C)
6 kV (3 kA)
≤ 0.45 kV
≤ 25 ns
20 A (MCB B/general purpose)

20 dB (≥ 100 kHz / 50 Ω)
30 dB (≥ 1 MHz / 50 Ω)
2x 1 mH ±30% (with current compensation)

112 mm / 86.6 mm / 79 mm
2.5 mm² ... 6 mm² / 2.5 mm² ... 4 mm² / 14 ... 10
-25°C ... 70°C
V-0
IEC 61643-11 / EN 61643-11

PDT contact
0.14 mm² ... 1.5 mm² / 0.14 mm² ... 1.5 mm² / 26 ... 16
250 V AC / 250 V DC
1 A AC / 1 A DC

Ordering data

Type	Order No.	Pcs./Pkt.
SFP 1-5/120AC	2920667	1

Total width 112 mm

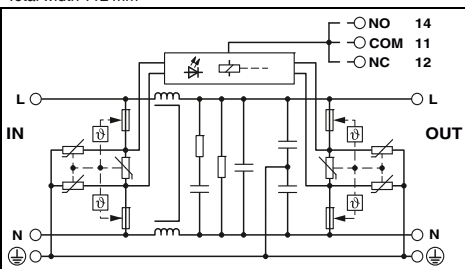

Technical data

- / T3 / 2CA
120 V AC (TN) /
120 V AC (TT - only in use with RCD) /
120 V AC (IT)

150 V AC
10 A (60°C)
6 kV (3 kA)
≤ 0.45 kV
≤ 25 ns
20 A (MCB B/general purpose)

20 dB (≥ 100 kHz / 50 Ω)
30 dB (≥ 1 MHz / 50 Ω)
2x 1 mH ±30% (with current compensation)

112 mm / 86.6 mm / 79 mm
2.5 mm² ... 6 mm² / 2.5 mm² ... 4 mm² / 14 ... 10
-25°C ... 70°C
V-0
IEC 61643-11 / EN 61643-11

PDT contact
0.14 mm² ... 1.5 mm² / 0.14 mm² ... 1.5 mm² / 26 ... 16
250 V AC / 250 V DC
1 A AC / 1 A DC

Ordering data

Type	Order No.	Pcs./Pkt.
SFP 1-10/120AC	2920670	1

Total width 112 mm

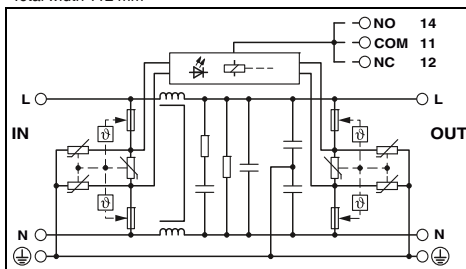

Technical data

- / T3 / 2CA
120 V AC (TN) /
120 V AC (TT - only in use with RCD) /
120 V AC (IT)

150 V AC
15 A (50°C)
6 kV (3 kA)
≤ 0.45 kV
≤ 25 ns
20 A (MCB B/general purpose)

20 dB (≥ 100 kHz / 50 Ω)
30 dB (≥ 1 MHz / 50 Ω)
2x 1 mH ±30% (with current compensation)

112 mm / 86.6 mm / 79 mm
2.5 mm² ... 6 mm² / 2.5 mm² ... 4 mm² / 14 ... 10
-25°C ... 70°C
V-0
IEC 61643-11 / EN 61643-11

PDT contact
0.14 mm² ... 1.5 mm² / 0.14 mm² ... 1.5 mm² / 26 ... 16
250 V AC / 250 V DC
1 A AC / 1 A DC

Ordering data

Type	Order No.	Pcs./Pkt.
SFP 1-15/120AC	2920683	1

Surge protection and interference filters

Interference suppression filters

TERMITRAB

Notes:
Attenuation characteristics at phoenixcontact.net/products

- Combined protective circuit for absorbing transient surge voltages and high-frequency interference voltages
- With spring-cage connection
- Disconnection of signal circuits by disconnect knife



Protection for two conductors with a common reference potential

ERC

Total width 6.2 mm

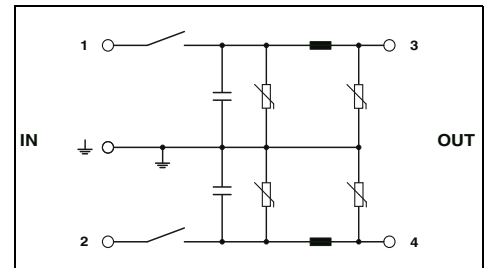

Technical data

Electrical data		
IEC test classification/EN type		C1 / C3
Maximum continuous operating voltage U_c		38 V DC / 30 V AC
Rated current		500 mA (55°C)
Nominal discharge current I_n (8/20) μ s		350 A (per path)
	Core-Ground	700 A
Total discharge current I_{total} (8/20) μ s		1.5 kA (per path)
Max. discharge current I_{max} (8/20) μ s		
Output voltage limitation at 1 kV/ μ s	Core-Ground	≤ 70 V (per path)
Cut-off frequency f_g (3 dB)	Asymmetrical in the 50 Ω system	typ. 60 kHz
Resistance per path		0.5 Ω
Inductance per path		typ. 100 μ H
Capacity per path		typ. 130 nF
General data		
Connection data rigid / flexible / AWG		0.2 ... 4 mm ² / 0.2 ... 2.5 mm ² / 24 ... 12
Temperature range		-40°C ... 85°C
Degree of protection in acc. with IEC 60529/EN 60529		IP20
Flammability rating in accordance with UL 94		V-0
Test standards		IEC 61643-21 / EN 61643-21

Ordering data

Description	Voltage U_N	Type	Order No.	Pcs./Pkt.
TERMITRAB , spring-cage terminal block with integrated surge protection as a filter circuit and disconnect knives, for mounting on NS 35	24 V AC	TT-ST-M-SFP-24AC	2858946	10

Accessories

Cover , for terminating a row of terminal blocks	TT-D-STTCO-BK	2858994	50
---	----------------------	----------------	----

FILTRAB

- Low-pass filters for nominal currents of 1 to 10 A
- For single-phase circuits
- DIN rail module

Notes:
Attenuation characteristics at phoenixcontact.net/products



1 A / 3 A nominal current



6 A / 10 A nominal current

ERIC Total width 25 mm

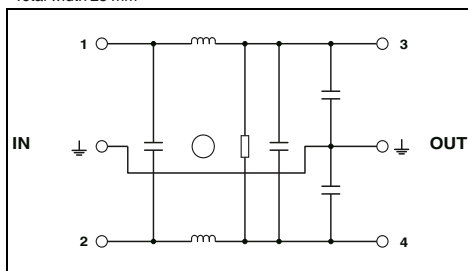

ERIC Total width 40 mm

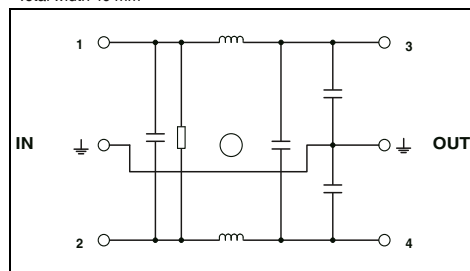

Technical data

	NEF 1- 1	NEF 1- 3
Rated voltage	240 V AC (L-N)	240 V AC (L-N)
Maximum continuous operating voltage U_c	264 V AC (L-N) / 264 V AC (L-PE)	264 V AC (L-N) / 264 V AC (L-PE)
Rated current	1 A (40°C)	3 A (40°C)
Maximum backup fuse in acc. with IEC	1 A (gL)	3 A (gL)
Inductance	2x 10 mH	2x 2.7 mH
Input attenuation a_i	Symmetrical > 65 dB (50 Ω / 1 MHz) Asymmetrical > 45 dB (50 Ω / 1 MHz)	Symmetrical > 55 dB (50 Ω / 1 MHz) Asymmetrical > 35 dB (50 Ω / 1 MHz)

Technical data

	NEF 1- 6	NEF 1-10
Rated voltage	240 V AC (L-N)	240 V AC (L-N)
Maximum continuous operating voltage U_c	264 V AC (L-N) / 264 V AC (L-PE)	264 V AC (L-N) / 264 V AC (L-PE)
Rated current	6 A (40°C)	10 A (40°C)
Maximum backup fuse in acc. with IEC	6.3 A (gL/C)	10 A (gL)
Inductance	2x 2.7 mH	2x 1.8 mH
Input attenuation a_i	Symmetrical > 80 dB (50 Ω / 1 MHz) Asymmetrical > 40 dB (50 Ω / 1 MHz)	Symmetrical > 80 dB (50 Ω / 1 MHz) Asymmetrical > 40 dB (50 Ω / 1 MHz)

Electrical data	
Rated voltage	
Maximum continuous operating voltage U_c	
Rated current	
Maximum backup fuse in acc. with IEC	
Inductance	
Input attenuation a_i	
General data	
Dimensions W/H/D	25 mm / 79.4 mm / 84.15 mm
Connection data rigid / flexible / AWG	0.2 ... 4 mm ² / 0.2 ... 2.5 mm ² / 24 - 12
Temperature range	-25°C ... 100°C (HMF)
Flammability rating in accordance with UL 94	V-2
Test standards	IEC 60939-2 / EN 60939-2

General data	
Dimensions W/H/D	40 mm / 79.4 mm / 84.1 mm
Connection data rigid / flexible / AWG	0.2 ... 4 mm ² / 0.2 ... 2.5 mm ² / 24 - 12
Temperature range	-25°C ... 100°C (HMF)
Flammability rating in accordance with UL 94	V-2
Test standards	IEC 60939-2 / EN 60939-2

Ordering data

Type	Order No.	Pcs./Pkt.
1 A	NEF 1- 1	2794123
3 A	NEF 1- 3	2794110
6 A		
10 A		

Ordering data

Type	Order No.	Pcs./Pkt.
6 A	NEF 1- 6	2783082
10 A	NEF 1-10	2788977

Description	Nominal load current I_N
FILTRAB , interference suppression filter for single-phase current circuits, for mounting on NS 32 or NS 35...	
	1 A
	3 A
	6 A
	10 A



Clear insight into the system

ImpulseCheck is the world's first intelligent assistance system for surge protection in the field of mains protection. The module allows you to measure the state of health of every single protective device via cloud connection and provides new digital services.

Optimum protection for sensitive systems

In many cases, SPDs can limit surge voltages and discharge surge currents without your system sustaining any damage. Depending on the number, duration, and amplitude of the surge currents, SPDs may be pushed to their very limits and fail. Other faults in the electrical installation, such as short circuits or ground faults, can also contribute to the failure of SPDs. A failure is indicated by a status indicator on the SPD itself and additional remote signaling, if necessary.

The current, actual load on the SPDs can only be determined by performing an electrical test on the individual modules. However, this is laborious and only provides an insight into the state of the SPDs at the time of testing.

How does ImpulseCheck work?

ImpulseCheck enables the continuous monitoring of SPDs. Thanks to external sensor cables, the system can be easily installed or retrofitted in both new and existing systems. It takes just a few simple steps to attach up to 4 sensors to the connecting cables of the monitored SPD.

Surge currents with a very high time resolution are captured on each channel. Both high-frequency events and sustained currents are measured reliably. Electromagnetic interference is detected, allocated a time stamp, and transmitted to PROFICLOUD. Important parameters are evaluated and indicated from the signal curves for surge current events. In addition, the remote indication contact of the monitored SPD can be evaluated.

For Phoenix Contact SPDs, the actual load is determined at all times based on the recorded events. The determined status (green, yellow, red) is displayed in PROFICLOUD as well as on the device itself. This allows you to respond proactively before an SPD actually fails.

Benefit from digital added value

The cloud-based evaluation of measured data enables the direct use of new digital services. Status messages regarding surge protection can be displayed on any web-enabled device. For example, you can configure custom notifications for various events in PROFICLOUD or create standard-compliant status reports at the push of a button.

Thanks to the ongoing further development of new and existing devices for PROFICLOUD as well as the platform itself, it will be possible to network a wide range of applications and services in the future.

i Your web code: #2095

new

Intelligent assistance system for surge protection

ImpulseCheck IPCH

- Determination and display of remaining service life (state of health) for each monitored mode of protection in PROFICLOUD
- Multi-stage state of health signaling for each monitored mode of protection directly on the device
- Real-time measurement of surge currents and detection of electromagnetic interference in order to diagnose problems in the system
- Automatic calculation of amplitude, charge, and specific energy
- Measurement of multiple pulses and sustained currents
- Display and retrieval of waveforms for individual recorded surge current events in PROFICLOUD
- Cloud-based notification on status change of the monitored modes of protection
- Additional interface for integrating the SPD remote indication contact
- Configuration of network connection via local web server
- Power supply via screw connection or DIN rail connector
- Easy installation, even when retrofitting, thanks to separate sensor cable
- Connection of up to 4 sensor cables, depending on the SPD circuit version

Notes:
ImpulseCheck is supplied without sensors. They must be ordered separately.



Evaluation and communication unit, for up to 4 sensors, Ethernet via RJ45

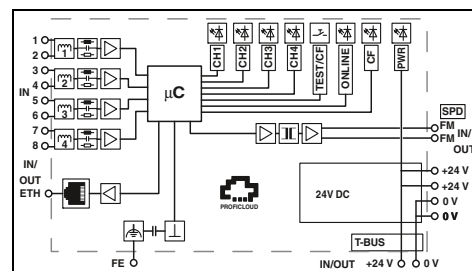

Ambient conditions	
Ambient temperature (operation)	-35°C ... 85°C
Degree of protection	IP20
General technical data	
Mounting type	DIN rail: 35 mm
Operating voltage	24 V DC (-15% ... +20%)
Detectable values (current strength)	100 A ... 40 kA
Sampling rate	500 kHz
Maximum measuring period	1 s
Connection designation	
	Connection method
	Conductor cross section rigid / flexible / AWG
Connection designation	
	Connection method
	Conductor cross section rigid / flexible / AWG
Connection designation	
	Connection method
	Transmission speed

Technical data

Technical data		
-35°C ... 85°C		
IP20		
DIN rail: 35 mm		
24 V DC (-15% ... +20%)		
100 A ... 40 kA		
500 kHz		
1 s		
24 V supply		
Screw terminal block		
0.14 mm ² ... 2.5 mm ² / 0.14 mm ² ... 2.5 mm ² / 26 ... 14		
Remote signaling		
Screw terminal block		
0.14 mm ² ... 2.5 mm ² / 0.14 mm ² ... 2.5 mm ² / 26 ... 14		
Ethernet		
RJ45		
10/100 Mbps		

Description
ImpulseCheck

Ordering data

Type	Order No.	Pcs./Pkt.
IPCH-4X-PCL-TCP-24DC-UT	1045379	1

Sensor, with connecting cable length of:
1.5 m
3.0 m

Accessories

Type	Order No.	Pcs./Pkt.
IPCH-SC-1.5	1045380	1
IPCH-SC-3.0	1069191	1



Lightning strikes cause devastating damage to buildings and systems. It is practically impossible for employees to continuously monitor exposed or large-scale systems, which means that damage is detected too late.

Detecting lightning with the lightning monitoring system

The LM-S lightning monitoring system supports continuous monitoring. Lightning events are detected, evaluated, and remotely monitored via network access. By consolidating the system operating parameters and the measuring data, the system provides a better basis for making decisions regarding control and maintenance.

The LM-S lightning current monitoring system consists of the following components:

- Sensor
- Connecting cable
- O/E module
- Evaluation unit



Faraday effect as a reliable measuring method

The internal measuring principle of the LM-S is based on the Faraday effect. Polarized light in a specific medium is rotated through a magnetic field over a defined length and measured.

The higher the amperage (i) generated by a lightning strike the greater the magnetic flux density (B) and, therefore, the rotation of the polarized light.

The lightning monitoring system detects this change in the light signal and uses this as the basis for the corresponding measured value results.

Remote monitoring in real time

The evaluation unit can be easily integrated into standard network systems via the RJ45 Ethernet interface. The data acquired can be accessed and the system can be configured via web interface, Modbus/TCP or OPC UA. The web interface is opened via the Internet browser on a PC connected to the system using IP addressing.

Detection and evaluation

The sensors are mounted on the lightning arrester cables. They record the magnetic field that occurs around the conductor due to the lightning surge current. The measured result is transmitted via fiber optics to the O/E module of the evaluation unit, where the optical signal is converted into an electrical signal. Based on the values obtained, the evaluation unit determines the lightning characteristics with their typical parameters, including, for example, the maximum lightning current strength, lightning current rate of rise, charge, and energy. These results can be forwarded to an available management system via the Ethernet interface.

Surge protection and interference filters

Lightning current measurement

Sensor

- Optical sensor for measuring lightning surge currents
- Subsequent mounting is possible
- Resistant to humidity
- Good UV resistance



Sensor

Technical data	
Detectable values	
Maximum current strength	400 kA
FO interface	
Connection method	SC-RJ socket with push/pull connector, IP67
General data	
Ambient temperature (operation)	-30°C ... 60°C
Ambient temperature (storage/transport)	-40°C ... 85°C
Degree of protection	IP67

Ordering data		
Type	Order No.	Pcs./Pkt.
LM-S-LS-H	2800616	1

Description
Sensor

Evaluation unit

- Real-time analysis and exact time allocation
- Status and diagnostic indicators
- Communication via Ethernet
- Operation and configuration via web interface, Modbus/TCP, and OPC-UA



Evaluation unit with O/E module



O/E module (replacement part)

Technical data	
Operating voltage	24 V DC ±4 V
Ethernet ports	RJ45
Transmission speed	10/100 Mbps
FO interface	B-FOC (ST®)
Number of ports	3
Remote indication contact	M12 D-coded
Max. operating voltage	60 V DC
General data	
Ambient temperature (operation)	-30°C ... 60°C
Degree of protection	IP20

Ordering data		
Type	Order No.	Pcs./Pkt.
LM-S-A/C-3S-ETH	2800618	1

Description
Evaluation unit with O/E module
Opto-electronic module O/E module only

Technical data	
Operating voltage	3.3 V DC
Ethernet ports	-
Transmission speed	-
FO interface	B-FOC (ST®)
Number of ports	3
Remote indication contact	-
Max. operating voltage	-
General data	
Ambient temperature (operation)	-30°C ... 60°C
Degree of protection	IP20

Ordering data		
Type	Order No.	Pcs./Pkt.
LM-S-C-3LS	2800617	1

Assembled connecting cables

- Fiber optics for connecting LM-S sensors to the O/E module
- Cable in robust conduit for installation in harsh environments
- Ozone and UV resistant



General data		Technical data		
Ambient temperature (operation)		-40°C ... 70°C		
Description		Ordering data		
Assembled FO cable		Type	Order No.	Pcs./Pkt.
Length: 10 m		FOC-ST:A-SJ:C-HB02/10 PR	1423846	1
Length: 13 m		FOC-ST:A-SJ:C-HB02/13 PR	1426160	1

Connecting cable

- HCS cable for connecting LM-S sensors to the O/E module
- Good UV resistance
- Good oil resistance

Notes:
The specified plug configuration (see ordering example) must be used in order to use the connecting cable in the LM-S lightning monitoring system.
Recommended length: 10 to 200 m



Connecting cable for LM-S

Ordering example for LM-S connecting cable with variable cable length:

Assembled connecting cable for the LM-S lightning monitoring system, with a metal push-pull connector, a B-FOC plug, and a cable length of 10 m.

Description		Ordering data		
Connecting cable, variable		Type	Order No.	Pcs./Pkt.
		FOC-SJ:14-ST/HB02/...	1417723	1

Order No.	Length [m]
1417723 / FOC-SJ:14-ST/HB02	10.0
Increments: 10.0 m ... 200 m = 1.0 m	



CHECKMASTER 2 – The intelligent test device for surge protective devices

Outdoor and indoor lightning protection must be regularly tested in accordance with normative requirements (IEC 62305) and official regulations. A basic visual check is not enough to identify damage to surge protective devices. Only an electrical check using the CHECKMASTER 2 produces meaningful results. The electrical check is performed with the aid of a programmable logic controller, a high-voltage source, and a constant current source. During the check, a program-controlled electrical test is performed on all the relevant components of the surge protective device. Thanks to the integrated database for surge protective devices, spark gaps, gas-filled surge arresters, varistors, and suppressor diodes can be checked automatically. Surge protective devices that were previously damaged, surge protective devices that are nearing the electrical tolerance limits, and faulty surge protective devices can be safely identified.

In industries where high demands are placed on system availability, the CHECKMASTER 2 enables predictive maintenance to be carried out on surge protective devices. This provides additional security for failure-critical systems.

i Your web code: [#0147](#)



Easy selection

The CHECKMASTER 2 has a modular design. Corresponding test adapters are available for the various surge protective devices. Further information about the test adapters required can be found on the next page.



Convenient scanning

The barcodes on the surge protective devices present a fast and error-free solution for entering items. Plant-specific ID codes or user-defined designations can be entered via the color touch display or read from individually created barcode labels.



Fast logging and easy data export

The tests are documented in accordance with IEC 62305. The CHECKMASTER 2 saves all test results to the internal memory with mains failure protection. The test reports are available via USB stick for convenient further processing in Office programs.

CHECKMASTER 2

- Modular test device for pluggable surge protective devices from Phoenix Contact
- Easy and tool-free changing of test adapters
- Integrated programmable logic controller with high-voltage source and constant current source
- Automatic and program-controlled testing of surge protective devices
- Easy operation by means of color touch display with virtual keypad
- User interfaces: German, English
- Further languages available for download: French, Italian, Spanish, Portuguese, Turkish, Russian
- Barcode scanner for automatic identification of surge protective devices and for reading user-specific barcodes (e.g., plant identification codes)
- Plant identification codes can also be entered using the virtual keypad
- USB interface for connecting standard USB sticks
- Easy transfer of test reports to Office programs and easy system software update via USB stick
- No additional software required
- No data cable required
- Power supply cable with SCHUKO connector
- Robust plastic transport case; with removable lid
- Additional compartment for another test adapter
- Calibration certificate

Test adapters are not supplied as standard with the CHECKMASTER 2. The required test adapters must be ordered separately.

PA-CASE 2 transport case for test adapters

- Padded compartments for holding test adapters for the CHECKMASTER 2
- Test adapters are not supplied as standard with the PA-CASE 2

Free software for updating the CHECKMASTER 2 can be found in the download area on the Phoenix Contact homepage.

The CHECKMASTER 2 is designed for use in industrial environments (EMC: class A product) and may not meet the requirements for radiated disturbance variables for use in residential areas.

Nominal voltage U_N
Temperature range

Description

Test device, for testing the correct function of surge protective devices from Phoenix Contact; test adapters must be ordered separately

Transport case, to hold four test adapters

Test adapter, for testing the correct function of surge protective devices from Phoenix Contact:

FLASHTRAB-SEC-HYBRID
FLASHTRAB FLT-CP/SEC and VALVETRAB VAL-CP/SEC

VALVETRAB VAL-MS
PLUGTRAB PLT-SEC...UT/PT (width: 17.5 mm)

PLUGTRAB PT/PLT (width: 17.5 mm)
PLUGTRAB PT/PLT (width: 35 mm)

PLUGTRAB UFBK/UAK
TERMITRAB complete
COMTRAB CTM



Test device



Transport case



Test adapter

Total width 432 mm

Technical data

100 V AC ... 240 V AC
5°C ... 35°C

Ordering data			Ordering data			Ordering data		
Type	Order No.	Pcs./Pkt.	Type	Order No.	Pcs./Pkt.	Type	Order No.	Pcs./Pkt.
CHECKMASTER 2	2905256	1						
			PA-CASE 2	2906272	1			
						CM 2-PA-SEC-HYBRID	2907889	1
						CM 2-PA-FLT/VAL-CP/SEC	2905283	1
						CM 2-PA-VAL-MS	2905265	1
						CM 2-PA-PLT-UT/PT	1027866	1
						CM 2-PA-PT/PLT	2905284	1
						CM 2-PA-PT4/PLT3S	2907019	1
						CM 2-PA-PT/A	2907891	1
						CM 2-PA-TTC	2908707	1
						CM 2-PA-CTM	2905282	1

Surge protection and interference filters

Accessories for surge protection

Feed-through terminal block

- For wiring mixed combinations of lightning current and surge arresters
- As a system extension for FLASHTRAB and VALVETRAB applications
- Practical wiring of all common applications



Feed-through terminal block

Electrical data	
Maximum continuous operating voltage U_c	500 V AC
Nominal current I_N	-
Impulse discharge curr. I_{imp} (10/350) μ s	Peak value 100 kA
General data	
Dimensions W/H/D	17.7 mm / 89.8 mm / 65.5 mm
Connection data rigid / flexible / AWG	0.5 ... 35 mm ² / 0.5 ... 25 mm ² / 20 ... 2
Temperature range	-40°C ... 85°C
Flammability rating in accordance with UL 94	V-0
Test standards	EN 60947-7-1 / IEC 61643-11 / EN 61643-11

Technical data

Ordering data		
Type	Order No.	Pcs./Pkt.
DK-BIC-35	2749880	1

Description	
Feed-through terminal block with biconnect connecting terminal blocks as wiring aid for lightning current and surge arrester applications.	

Equipotential bonding and TRABTECH housings

Equipotential bonding strip

- For main equipotential bonding in accordance with DIN VDE 0100
- Also for lightning protection equipotential bonding in accordance with DIN EN 62305 TRABTECH housing
- Use in harsh environmental conditions at the installation location
- Installation outdoors or indoors possible



Equipotential bonding strip

Ordering data

Description		Type	Order No.	Pcs./Pkt.
Equipotential bonding strip		PAS-1	2765615	1

Marking material

- For clear and logical identification
- The multi-section ZB strips can be easily separated
- Can be marked with the MARKING system or by hand using B-STIFT



For terminal width 6.2 mm



Marking label for the SEC product range

Description	Ordering data			Ordering data		
	Type	Order No.	Pcs./Pkt.	Type	Order No.	Pcs./Pkt.
Marking labels , corresponding material can be found on the website Can be marked acc. to customer specifications UniCard materials , can be marked with BLUEMARK, corresponding material can be found on our website	ZBN 18 CUS	0825059	1			
	UC-TM 6 GN	0818360	10			
Zack marker strip, 5-section, unprinted , corresponding material can be found on our website 5-section Continuous labels , can be marked with thermal transfer printers, can be separated with a cutter, pitch as desired, strip length up to 1000 mm, 1 roll = 40 m continuous, height: 20 mm Color: yellow	ZB 12:UNPRINTED	0812120	10			
				EML (20XE)R	0803452	1
				EML (20XE)R YE	0803453	1

Shield fast connection and wiring bridges

- For connecting cable shielding to cable terminal points
- Easy assembly

Wiring bridges

- 1-phase with various numbers of positions



Shield fast connection



Wiring bridges

Description	Ordering data			Ordering data		
	Type	Order No.	Pcs./Pkt.	Type	Order No.	Pcs./Pkt.
Shield fast connection For Ø 3-6 mm For Ø 5-10 mm	SSA 3-6	2839295	10			
	SSA 5-10	2839512	10			
Wiring bridge , for wiring applications with lightning current and surge arresters; these can be found on the website under the corresponding items 2-pos. 3-pos. 4-pos. 5-pos. 6-pos. 8-pos. 9-pos. 12-pos. 57-pos. Wiring bridge , 35 mm ² 6-pos. 8-pos.				MPB 18/1- 2	2809209	10
				MPB 18/1- 3	2809212	10
				MPB 18/1- 4	2809225	10
				MPB 18/1- 5	2817864	10
				MPB 18/1- 6	2748564	10
				MPB 18/1- 8	2748577	10
				MPB 18/1- 9	2748580	10
				MPB 18/1-12	2748593	10
				MPB 18/1-57	2809238	1
				MPB 18/1-6/35	2908705	10
				MPB 18/1-8/35	2908704	10



Power supplies and UPS

For superior system availability

The product ranges differ with regard to their design, performance, and functionality. Select the ideal solution based on your requirements:

- QUINT POWER – maximum functionality
- TRIO POWER – robust standard functionality
- UNO POWER – compact basic functionality

The product range is supplemented with designs tailor-made for specific applications:

- MINI POWER for measurement and control technology
- STEP POWER for distribution boards and flat control panels

Power supplies

Thanks to high-quality products featuring leading technology, our QUINT, TRIO, UNO, MINI and STEP POWER product ranges optimally equip you for international competition.

DC/DC converters

Change the voltage level, regenerate the voltage at the end of long cables or enable the creation of independent supply systems with the QUINT and MINI DC/DC converters.

Redundancy modules

A redundant power supply system is the result of the parallel connection of two power supply units. Optimize this solution with the QUINT ORING and QUINT-S-ORING redundancy modules and the QUINT, TRIO, UNO, and STEP diodes for superior system availability.

Uninterruptible power supplies (UPS) for the control cabinet

IQ Technology is the key to an intelligent energy supply solution. The UPS monitors and optimizes the energy storage device. Avoid interruptions when working with the intelligent UPS for non-stop energy.

 Your web code: #0150

Power supplies and UPS

Selection guides	226
Power supplies	232
QUINT POWER with SFB Technology	234
QUINT POWER < 100 W	248
TRIO POWER	254
UNO POWER	266
MINI POWER	276
STEP POWER	278
DC/DC converters	286
QUINT DC/DC converters	288
QUINT DC/DC converters, with protective coating	296
MINI DC/DC converters	298
Redundancy modules	300
QUINT ORING	302
QUINT S-ORING	304
QUINT DIODE	306
TRIO DIODE	308
UNO DIODE	309
STEP DIODE	309
Accessories	310
Uninterruptible power supplies for the control cabinet	312
Selection guide for QUINT DC UPS	314
QUINT DC UPS	316
Selection guide for AC UPS	328
QUINT AC-UPS	330
TRIO AC UPS	332
Energy storage for QUINT UPS	334
Accessories	340
Selection guide for UPS modules	342
UPS module with integrated energy storage	344
UPS module with integrated power supply	350
Energy storage for TRIO UPS and MINI UPS	353

Power supplies and UPS

Product range overview

QUINT POWER, with SFB Technology, 1~



24 DC / 5 A
Page 234



24 DC / 10 A
Page 235
48 DC / 5 A
Page 241
12 DC / 15 A
Page 240



24 DC / 20 A
Page 235
48 DC / 10 A
Page 241



24 DC / 20 A +
Page 238



24 DC / 40 A
Page 235

QUINT POWER, with SFB Technology, 3~



24 DC / 5 A
Page 236



24 DC / 10 A
Page 237



24 DC / 20 A
Page 237



24 DC / 40 A
Page 237

QUINT POWER, with SFB Technology



1~ / 24 DC / 3.5 A
Page 242



1~ / 12 DC / 20 A
Page 243



1~ / 48 DC / 20 A
Page 243



3~ / 48 DC / 20 A
Page 244

QUINT POWER, with SFB Technology, with protective coating, 1~



1~ / 24 DC / 5 A CO
Page 246



1~ / 24 DC / 10 A CO
Page 247



1~ / 24 DC / 20 A CO
Page 247



3~ / 24 DC / 20 A CO
Page 247

QUINT POWER, with Push-in connection, < 100 W, 1~



24 DC / 1.3 A
Page 248
12 DC / 2.5 A
Page 252
5 DC / 5 A
Page 253



24 DC / 2.5 A
Page 249



24 DC / 3.8 A
Page 249
12 DC / 7.5 A
Page 253



24 DC / 1.3 A
Page 250



24 DC / 2.5 A
Page 251



24 DC / 3.8 A
Page 251

QUINT POWER, with screw connection, < 100 W, 1~

TRIO POWER 1~



24 DC / 3 A
Page 254

12 DC / 5 A
Page 260



24 DC / 5 A
Page 255

12 DC / 10 A
Page 261



24 DC / 5 A B+D
Page 255



24 DC / 10 A
Page 256
48 DC / 5 A
Page 261



24 DC / 10 A B+D
Page 257



24 DC / 20 A
Page 257
48 DC / 10 A
Page 261

TRIO POWER 3~



24 DC / 5 A
Page 258



24 DC / 10 A
Page 258



24 DC / 20 A
Page 259



24 DC / 40 A
Page 259

TRIO CrossPower



~3 / 24 DC / 5 A
Page 262

TRIO POWER, IP67, 1~



24 DC / 20 A
Page 264

TRIO POWER, IP67, 3~



24 DC / 20 A
Page 265

UNO POWER 1~



24 DC / 30 W
Page 266

15 DC / 30 W
Page 272

12 DC / 30 W
Page 270

5 DC / 25 W
Page 271



24 DC / 60 W
Page 266

48 DC / 60 W
Page 273

15 DC / 55 W
Page 272

12 DC / 55 W
Page 270

5 DC / 40 W
Page 271



24 DC / 100 W
Page 267

48 DC / 100 W
Page 273

15 DC / 100 W
Page 273

12 DC / 100 W
Page 271



24 DC / 480 W
Page 268



24 DC / 150 W
Page 267



24 DC / 240 W
Page 267



C2LPS

1~ / 24 DC / 90 W
Page 269

2~ / 24 DC / 90 W
Page 269

MINI POWER 1~



5 DC / 3 A
Page 277



24 DC / 1.5 A
Page 276



±15 DC / 1 A Ex
Page 277



24 DC / 1.5 A Ex
Page 277

Power supplies and UPS

Product range overview

STEP POWER 1~



24 DC / 0.5 A
Page 278
48 AC / 24 DC / 0.5 A
Page 279
12 DC / 1 A
Page 284
5 DC / 2 A
Page 282



24 DC / 0.75 A / FL
Page 279
12 DC / 1.5 A / FL
Page 284



24 DC / 0.75 A
Page 279
12 DC / 1.5 A
Page 285



24 DC / 1.75 A
Page 280
12 DC / 3 A
Page 285



24 DC / 2.5 A
Page 280
5 DC / 6.5 A
Page 283
12 DC / 5 A
Page 285
15 DC / 4 A
Page 283



24 DC / 4.2 A
Page 281
24 DC / 100 W
Page 281
48 DC / 2 A
Page 283
277 AC/24 DC / 3.5 A
Page 281

QUINT DC/DC converters, Push-in connection



24 DC / 24 DC / 5 A
Page 288
24 DC / 12 DC / 8 A
Page 289
24 DC / 48 DC / 5 A
Page 289



24 DC / 24 DC / 10 A
Page 289



24 DC / 24 DC / 5 A
Page 290



24 DC / 24 DC / 10 A
Page 291

QUINT DC/DC converters



12 DC / 24 DC / 5 A
Page 293
12 DC / 12 DC / 8 A
Page 293



48 DC / 48 DC / 5 A
Page 293
60-72 DC / 24 DC / 10 A
Page 294
96-110 DC / 24 DC / 10 A
Page 295



24 DC / 24 DC / 20 A
Page 292



24 DC / 24 DC / 5 A / CO
Page 296



24 DC / 24 DC / 10 A / CO
Page 296



24 DC / 24 DC / 20 A / CO
Page 297



60-72DC/24DC/10 A / CO
Page 297
96-110DC/24DC/10 A / CO
Page 297

UNO DC/DC converters



350-900 DC / 24 DC / 60 W
Page 274

MINI DC/DC converters



12-24 DC / 24 DC / 1 A
Page 298
48-60 DC / 24 DC / 1 A
Page 299
12-24 DC / 5-15 DC / 2 A
Page 298
12-24 DC / 48 DC / 0.7 A
Page 299



AC power module
Page 299

For frequency converters



2 AC / 1 DC / 24 DC / 20 A
Page 245



600 DC / 24 DC / 20 A
Page 245

Redundancy modules – QUINT



24 DC / 2x10 A
Page 302



24 DC / 2x20 A
Page 303



24 DC / 2x40
Page 303



12-24 DC / 1x40 A
Page 304
12-24 DC / 1x40 A/VP
Page 305
12-24 DC / 1x40 A/+
Page 305



12-24 DC / 2x20 A
Page 306
48 DC / 2x20 A
Page 307

Redundancy modules – TRIO



12-24 DC / 2x10 A
Page 308



12-24 DC / 2x20 A
Page 309



5-24 DC / 2x10 A
Page 309



5-24 DC / 2x5 A
Page 309

- UNO

- STEP

Power supplies and UPS

Product range overview

QUINT DC UPS



24 DC / 5 A / PN
Page 316



24 DC / 10 A / PN
Page 317



24 DC / 20 A / PN
Page 317



24 DC / 40 A / PN
Page 317



12 DC / 5 A / 24 DC / 10 A
Page 326

24 DC / 5 A / EIP
Page 318

24 DC / 10 A / EIP
Page 319

24 DC / 20 A / EIP
Page 319

24 DC / 40 A / EIP
Page 319

24 DC / 5 A / EC
Page 320

24 DC / 10 A / EC
Page 321

24 DC / 20 A / EC
Page 321

24 DC / 40 A / EC
Page 321

24 DC / 5 A / USB
Page 322

24 DC / 10 A / USB
Page 323

24 DC / 20 A / USB
Page 323

24 DC / 40 A / USB
Page 323

24 DC / 5 A
Page 324

24 DC / 10 A
Page 325

24 DC / 20 A
Page 325

24 DC / 40 A
Page 325

QUINT AC UPS



1~ / 1 AC / 500 VA
Page 330



1~ / 1 AC / 1 kVA
Page 331



1~ / 1 AC / 750 VA
Page 332

TRIO AC UPS

UPS-CAP for QUINT UPS



24 DC / 10 A / 10 KJ
Page 334



24 DC / 20 A / 20 KJ
Page 334



24 DC / 120 WH
Page 335



24 DC / 925 WH
Page 335

UPS-BAT/VRLA-WTR for QUINT UPS



24 DC / 13 Ah
Page 338



24 DC / 26 Ah
Page 338

UPS-BAT/VRLA for QUINT UPS



24 DC / 1.3 Ah
Page 336



24 DC / 3.4 Ah
Page 336



24 DC / 7.2 Ah
Page 337



24 DC / 12 Ah
Page 337



24 DC / 38 Ah
Page 337

UPS with integrated QUINT, UNO, STEP energy storage



24 DC / 5 A / 1.3 Ah
Page 344



24 DC / 10 A / 3.4 Ah
Page 344



24 DC / 60 W
Page 349



24 DC / 3 A
Page 348

12 DC / 4 A
Page 348

QUINT BUFFER



24 DC / 20 A
Page 345



24 DC / 40 A
Page 345



24 DC / 5 A / 4 KJ
Page 346



24 DC / 5 A / 8 KJ
Page 347

QUINT CAP

MINI UPS with integrated power supply and energy storage



1~ / 24 DC / 2 A
Page 350



24 DC / 1.3 Ah
Page 353



24 DC / 0.8 Ah
Page 352

1~ / 12 DC / 4 A
Page 350

12 DC / 2.6 Ah
Page 353

12 DC / 1.6 Ah
Page 353

TRIO UPS with integrated power supply and energy storage



1~ / 24 DC / 5 A
Page 354



1~ / 24 DC / 10 A
Page 354



3~ / 24 DC / 20 A
Page 355

UPS-BAT/VRLA for TRIO DC UPS



24 DC / 1.3 Ah
Page 356



24 DC / 3.4 Ah
Page 356



24 DC / 7.2 Ah
Page 356



24 DC / 12 Ah
Page 356



24 DC / 38 Ah
Page 356



Leading technology and high quality – Power supplies for superior system availability

Thanks to high-quality products featuring leading technology, with our power supply solutions from the QUINT, TRIO, UNO, MINI, and STEP POWER product ranges, you are optimally equipped to handle competitors on an international scale.

Functionality, performance class, and design are tailored to the demands of various different industries and always offer the ideal solution.

QUINT POWER – Maximum functionality

Cost-effective selective fuse protection with SFB Technology:

In order to trip miniature circuit breakers magnetically and quickly, power supplies must be able to supply several times the nominal current for a short period. SFB (Selective Fuse Breaking) Technology supplies six times the nominal current for 15 ms. Faulty current paths are switched off selectively, the fault is located, and important system parts remain in operation.

Preventive function monitoring:

Comprehensive diagnostics are provided through constant monitoring of all relevant parameters (including the output voltage and output current). This preventive function monitoring visualizes critical operating states, before errors can occur. Remote monitoring is performed by means of active switching outputs and floating relay contacts.

Power reserves:

- Easy system extension with static boost with sustained power of up to 125%
- Start heavy loads with dynamic boost, providing up to 200% power for 5 s

Adaptable:

- Signaling thresholds and characteristic curves can be individually adjusted via NFC

Connection technology:

- Free choice between Push-in connection and screw connection for devices up to 100 W

TRIO POWER – Robust standard functionality

The reliable supply of the loads under challenging ambient conditions is ensured by the power supply units, which feature an extremely robust electrical and mechanical design. TRIO POWER supplies up to 1.5 times the nominal current for five seconds with the dynamic boost. Loads with high starting currents can therefore be started without other loads being affected by voltage dips.

UNO POWER – Compact basic functionality

UNO POWER offers maximum energy efficiency thanks to its high efficiency of up to 94% and low idling losses below 0.3 W. The extremely high power density of up to 500 W/dm³ enables a very compact design. Thanks to the wide range of products and the temperature range from -25°C to +70°C, the devices support flexible use.

i Your web code: #0151



Power supplies - A comparison of the advantages

- QUINT POWER – maximum flexibility up to 1000 W
- TRIO POWER – standard functionality up to 1000 W
- UNO POWER – compact basic functionality up to 480 W



QUINT POWER

High-performance QUINT POWER power supplies with SFB Technology ensure maximum system availability.

The new QUINT POWER power supplies < 100 W are the first to offer maximum system availability in the smallest size.

All the devices in this range feature preventative function monitoring and exceptional power reserves.



TRIO POWER

The TRIO POWER power supplies represent standard functionality, high quality, and reliability. They are therefore perfect for use in machine building.

- Robust design
- Reliable supply of loads with high switch-on currents, thanks to the dynamic boost
- Time savings during installation, thanks to Push-in connection technology



UNO POWER

The UNO POWER power supplies offer extremely compact basic functionality.

- The wide range of products covers all common voltage levels
- Save energy, thanks to high efficiency and low idling losses
- Compact design saves space in the control cabinet



MINI POWER

MINI POWER power supplies in the electronics housing for measurement and control technology.

- Maintenance-friendly connection technology: coded COMBICON connectors
- Active function monitoring with switching output for remote monitoring of the output voltage



STEP POWER

The STEP POWER power supplies are particularly suited to distribution boards and flat control panels.

- Maximum energy efficiency, thanks to incredibly low idling losses and a high degree of efficiency
- Flexible: snap onto the DIN rail or screw onto a level surface

Power supplies and UPS

Power supplies

QUINT POWER power supplies – Maximum functionality

QUINT POWER, 1 AC, 24 V DC

- Easy system extension with static boost
- Starting of heavy loads with dynamic boost
- SFB Technology selectively trips standard circuit breakers; consumers connected in parallel continue working
- High noise immunity, thanks to integrated gas-filled surge arrester and a mains failure buffer time of more than 20 ms
- Comprehensive signaling with preventive function monitoring
- Signaling thresholds and characteristic curves can be set via NFC, available pre-configured from a batch quantity of 1



Power supply,
1 AC, 24 V DC, 5 A

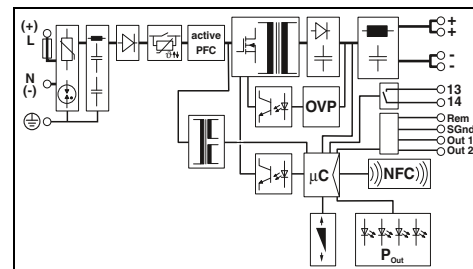

Technical data

Input data			
Input voltage range	100 V AC ... 240 V AC -15% ... +10% 110 V DC ... 250 V DC -18% ... +40%		
Frequency range (f_N)	50 Hz ... 60 Hz -10% ... +10%		
Typical current consumption (in static boost)	1.7 A (100 V AC) / 1.5 A (120 V AC) 0.9 A (230 V AC) / 0.8 A (240 V AC) 1.6 A (110 V DC) / 0.7 A (250 V DC) typ. 14 A / < 0.3 A ^{2s}		
Inrush current limitation at 25°C / I ² t	typ. 28 ms (120 V AC) / typ. 38 ms (230 V AC)		
Mains buffering (I_N)			
Output data			
Nominal output voltage (U_N)	24 V DC		
Output current I_N / $I_{Stat. Boost}$ / $I_{Dyn. Boost}$ / I_{SFB}	5 A / 6.25 A / 10 A (5 s) / 30 A (15 ms)		
Magnetic circuit breaker tripping	A1 ... A4 / B2 / C1 ... C2 / Z1 ... Z4		
Can be connected in parallel/series	Yes / yes		
Max. power dissipation (no load/nominal load)	< 3 W (230 V AC) / < 16 W (230 V AC)		
Efficiency	typ. 88.8% (120 V AC) / typ. 89.2% (230 V AC)		
Residual ripple	< 30 mV _{pp}		
Signaling			
LED signaling	DC OK, utilization indicator		
Configurable signal output	Relay contact 13/14, Out 1 digital, Out 2 digital/analog		
Signal options	I_{Out} , U_{Out} , P_{Out} , U_{In} , OK, Operating hours, Temp. OK, OVP		
General data			
Weight / Dimensions W x H x D	0.7 kg / 36 x 130 x 125 mm		
Connection	alignable: 5 mm horizontally, 15 mm next to active components, 50 mm vertically		
Connection method	Screw connection		
Input connection data rigid / flexible / AWG	0.2 - 2.5 mm ² / 0.2 - 2.5 mm ² / 24 - 14		
Output connection data rigid / flexible / AWG	0.2 - 2.5 mm ² / 0.2 - 2.5 mm ² / 24 - 14		
Signal connection data rigid / flexible / AWG	0.2 - 1 mm ² / 0.2 - 1.5 mm ² / 24 - 16		
Degree of protection / Protection class	IP20 / I		
MTBF (IEC 61709, SN 29500)	> 930000 h (40°C)		
Ambient temperature (operation)	-25°C ... 70°C (> 60°C Derating: 2.5%/K)		
Ambient temperature (startup type tested)	-40°C		
Standards/regulations			
Insulation voltage input/output	2 kV AC (routine test) / 4 kV AC (type test)		
Electromagnetic compatibility	Conformance with EMC Directive 2014/30/EU		
Electrical safety	IEC 60950-1/VDE 0805 (SELV)		
Safety transformers for switched-mode power supply units	EN 61558-2-16		
Overvoltage category in accordance with EN 62477-1,	III (≤ 2000 m), II (≤ 5000 m), II (≤ 5000 m)		
EN 61010-1, EN 60950-1			
UL approvals	UL Listed UL 508, UL/C-UL Recognized UL 60950-1, UL ANSI/ISA-12.12.01 Class I, Division 2, Groups A, B, C, D (Hazardous Location)		
Limitation of harmonic line currents	EN 61000-3-2		
Ordering data			
Description	Type	Order No.	Pcs./Pkt.
Power supply, primary-switched	QUINT4-PS/1AC/24DC/5	2904600	1



Power supply,
1 AC, 24 V DC, 10 A

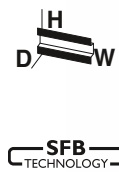

Power supply,
1 AC, 24 V DC, 20 A

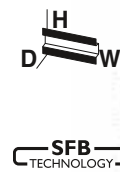

Power supply,
1 AC, 24 V DC, 40 A

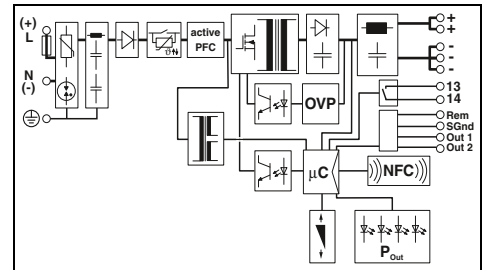
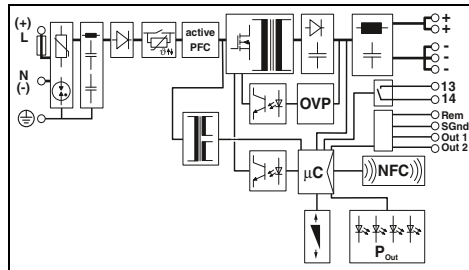
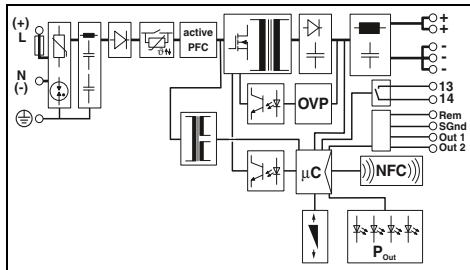

Technical data

100 V AC ... 240 V AC -15% ... +10%
110 V DC ... 250 V DC -18% ... +40%
50 Hz ... 60 Hz -10% ... +10%
3.4 A (100 V AC) / 2.8 A (120 V AC)
1.5 A (230 V AC) / 1.5 A (240 V AC)
3 A (110 V DC) / 1.3 A (250 V DC)
typ. 18 A / < 0.7 A²s
typ. 42 ms (120 V AC) / typ. 44 ms (230 V AC)

24 V DC
10 A / 12.5 A / 20 A (5 s) / 60 A (15 ms)
A1...A6 / B2...B6 / C1...C3 / Z1...Z6
Yes / yes
< 3 W (230 V AC) / < 17 W (230 V AC)
typ. 92.5% (120 V AC) / typ. 93.4% (230 V AC)
< 80 mV_{pp}

DC OK, utilization indicator
Relay contact 13/14, Out 1 digital, Out 2 digital/analog
I_{Out}, U_{Out}, P_{Out}, U_{In}, OK, Operating hours, Temp. OK, OVP

0.9 kg / 50 x 130 x 125 mm
alignable: 5 mm horizontally, 15 mm next to active components,
50 mm vertically
Screw connection
0.2 - 2.5 mm² / 0.2 - 2.5 mm² / 24 - 14
0.2 - 2.5 mm² / 0.2 - 2.5 mm² / 24 - 14
0.2 - 1 mm² / 0.2 - 1.5 mm² / 24 - 16
IP20 / I
> 783000 h (40°C)
-25°C ... 70°C (> 60°C Derating: 2.5%/K)
-40°C

2 kV AC (routine test) / 4 kV AC (type test)
Conformance with EMC Directive 2014/30/EU
IEC 60950-1/VDE 0805 (SELV)
EN 61558-2-16
III (≤ 2000 m), II (≤ 5000 m), II (≤ 5000 m)

UL Listed UL 508, UL/C-UL Recognized UL 60950-1,
UL ANSI/ISA-12.12.01 Class I, Division 2, Groups A, B, C, D
(Hazardous Location)
EN 61000-3-2

Technical data

100 V AC ... 240 V AC -15% ... +10%
110 V DC ... 250 V DC -18% ... +40%
50 Hz ... 60 Hz -10% ... +10%
6.8 A (100 V AC) / 5.5 A (120 V AC)
2.8 A (230 V AC) / 2.7 A (240 V AC)
6 A (110 V DC) / 2.5 A (250 V DC)
typ. 11 A / < 0.4 A²s
typ. 28 ms (120 V AC) / typ. 29 ms (230 V AC)

24 V DC
20 A / 25 A / 30 A (5 s) / 120 A (15 ms)
A1...A16 / B2...B13 / C1...C6 / Z1...Z16
Yes / yes
< 5 W (230 V AC) / < 32 W (230 V AC)
typ. 92.4% (120 V AC) / typ. 94% (230 V AC)
< 50 mV_{pp}

DC OK, utilization indicator
Relay contact 13/14, Out 1 digital, Out 2 digital/analog
I_{Out}, U_{Out}, P_{Out}, U_{In}, OK, Operating hours, Temp. OK, OVP

1.3 kg / 70 x 130 x 125 mm
alignable: 5 mm horizontally, 15 mm next to active components,
50 mm vertically
Screw connection
0.2 - 6 mm² / 0.2 - 4 mm² / 24 - 10
0.2 - 6 mm² / 0.2 - 4 mm² / 24 - 10
0.2 - 1 mm² / 0.2 - 1.5 mm² / 24 - 16
IP20 / I
> 673000 h (40°C)
-25°C ... 70°C (> 60°C Derating: 2.5%/K)
-40°C

2 kV AC (routine test) / 4 kV AC (type test)
Conformance with EMC Directive 2014/30/EU
IEC 60950-1/VDE 0805 (SELV)
EN 61558-2-16
III (≤ 2000 m), II (≤ 5000 m), II (≤ 5000 m)

UL Listed UL 508, UL/C-UL Recognized UL 60950-1,
UL ANSI/ISA-12.12.01 Class I, Division 2, Groups A, B, C, D
(Hazardous Location)
EN 61000-3-2

Technical data

100 V AC ... 240 V AC -15% ... +10%
110 V DC ... 250 V DC -18% ... +40%
50 Hz ... 60 Hz -10% ... +10%
10.6 A (100 V AC) / 10 A (120 V AC)
5.2 A (230 V AC) / 5.7 A (240 V AC)
10.2 A (110 V DC) / 5.6 A (250 V DC)
typ. 11 A / < 0.5 A²s
typ. 24 ms (120 V AC) / typ. 25 ms (230 V AC)

24 V DC
40 A / 45 A / 60 A (5 s) / 215 A (15 ms)
A1 ... A16 / B2 ... B25 / C1 ... C13 / Z1 ... Z16
Yes / yes
< 4 W (230 V AC) / < 56 W (230 V AC)
typ. 95% (120 V AC) / typ. 96% (230 V AC)
< 50 mV_{pp}

DC OK, utilization indicator
Relay contact 13/14, Out 1 digital, Out 2 digital/analog
I_{Out}, U_{Out}, P_{Out}, U_{In}, OK, Operating hours, Temp. OK, OVP

2.6 kg / 120 x 130 x 141 mm
alignable: 5 mm horizontally, 15 mm next to active components,
50 mm vertically
Screw connection
0.2 - 6 mm² / 0.2 - 4 mm² / 24 - 10
0.5 - 16 mm² / 0.5 - 16 mm² / 8 - 6
0.2 - 1.5 mm² / 0.2 - 1.5 mm² / 24 - 16
IP20 / I
> 500000 h (40°C)
-25°C ... 70°C (> 60°C Derating: 2.5%/K)
-40°C

2 kV AC (routine test) / 4 kV AC (type test)
Conformance with EMC Directive 2014/30/EU
IEC 60950-1/VDE 0805 (SELV)
EN 61558-2-16
III (≤ 2000 m), II (≤ 5000 m), II (≤ 5000 m)

UL Listed UL 508, UL/C-UL Recognized UL 60950-1,
UL ANSI/ISA-12.12.01 Class I, Division 2, Groups A, B, C, D
(Hazardous Location)
EN 61000-3-2

Ordering data

Type	Order No.	Pcs./Pkt.
QUINT4-PS/1AC/24DC/10	2904601	1

Ordering data

Type	Order No.	Pcs./Pkt.
QUINT4-PS/1AC/24DC/20	2904602	1

Ordering data

Type	Order No.	Pcs./Pkt.
QUINT4-PS/1AC/24DC/40	2904603	1

Power supplies

QUINT POWER power supplies – Maximum functionality

QUINT POWER, 3 AC, 24 V DC

- Easy system extension with static boost
- Starting of heavy loads with dynamic boost
- SFB Technology selectively trips standard circuit breakers; consumers connected in parallel continue working
- High noise immunity, thanks to integrated gas-filled surge arrester and a mains failure buffer time of more than 20 ms
- Comprehensive signaling with preventive function monitoring
- Signaling thresholds and characteristic curves can be set via NFC, available pre-configured from a batch quantity of 1



**Power supply,
3 AC, 24 V DC, 5 A**

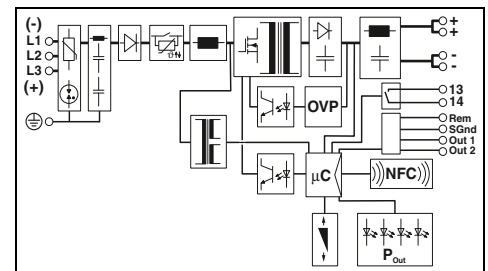

Technical data

Input data			
Input voltage range	3x 400 V AC ... 500 V AC -20% ... +10% 2x 400 V AC ... 500 V AC -10% ... +10% ± 300 V DC -25% ... +30%		
Frequency range (f _N)	50 Hz ... 60 Hz -10% ... +10%		
Typical current consumption (in static boost)	3x 0.53 A (400 V AC) / 3x 0.44 A (480 V AC) 2x 0.9 A (400 V AC) / 2x 0.66 A (480 V AC) 0.3 A (± 300 V DC)		
Inrush current limitation at 25°C / I _t	typ. 11 A / < 0.2 A ² s		
Mains buffering (I _N)	typ. 34 ms (3x 400 V AC) / typ. 50 ms (3x 480 V AC)		
Output data			
Nominal output voltage (U _N)	24 V DC		
Output current I _N / I _{Stat. Boost} / I _{Dyn. Boost} / I _{SFB}	5 A / 6.25 A / 10 A (5 s) / 30 A (15 ms)		
Magnetic circuit breaker tripping	A1 ... A4 / B2 / C1 ... C2 / Z1 ... Z4		
Can be connected in parallel/series	Yes / yes		
Max. power dissipation (no load/nominal load)	< 4 W (480 V AC) / < 17 W (480 V AC)		
Efficiency	typ. 89% (400 V AC) / typ. 87.5% (480 V AC)		
Residual ripple	< 30 mV _{pp}		
Signaling			
LED signaling	DC OK, utilization indicator		
Configurable signal output	Relay contact 13/14, Out 1 digital, Out 2 digital/analog		
Signal options	I _{Out} , U _{Out} , P _{Out} , U _{In} , OK, Operating hours, Temp. OK, OVP		
General data			
Weight / Dimensions W x H x D	0.6 kg / 36 x 130 x 125 mm		
Connection	alignable: 5 mm horizontally, 15 mm next to active components, 50 mm vertically		
Connection method	Screw connection		
Input connection data rigid / flexible / AWG	0.2 - 6 mm ² / 0.2 - 4 mm ² / 24 - 10		
Output connection data rigid / flexible / AWG	0.2 - 2.5 mm ² / 0.2 - 2.5 mm ² / 24 - 14		
Signal connection data rigid / flexible / AWG	0.2 - 1 mm ² / 0.2 - 1.5 mm ² / 24 - 16		
Degree of protection / Protection class	IP20 / I		
MTBF (IEC 61709, SN 29500)	> 914000 h (40°C)		
Ambient temperature (operation)	-25°C ... 70°C (> 60°C Derating: 2.5%/K)		
Ambient temperature (startup type tested)	-40°C		
Standards/regulations			
Insulation voltage input/output	2.4 kV AC (routine test) / 4 kV AC (type test)		
Electromagnetic compatibility	Conformance with EMC Directive 2014/30/EU		
Electrical safety	IEC 60950-1/VDE 0805 (SELV)		
Safety transformers for switched-mode power supply units	EN 61558-2-16		
Overvoltage category in accordance with EN 62477-1, EN 61010-1, EN 60950-1	III (≤ 2000 m), II (≤ 5000 m), I (≤ 5000 m)		
UL approvals	UL Listed UL 508, UL/C-UL Recognized UL 60950-1, UL ANSI/ISA-12.12.01 Class I, Division 2, Groups A, B, C, D (Hazardous Location)		
Limitation of harmonic line currents	EN 61000-3-2		
Ordering data			
Description	Type	Order No.	Pcs./Pkt.
Power supply, primary-switched	QUINT4-PS/3AC/24DC/5	2904620	1



Power supply,
3 AC, 24 V DC, 10 A

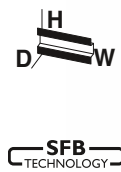

Power supply,
3 AC, 24 V DC, 20 A



Power supply,
3 AC, 24 V DC, 40 A

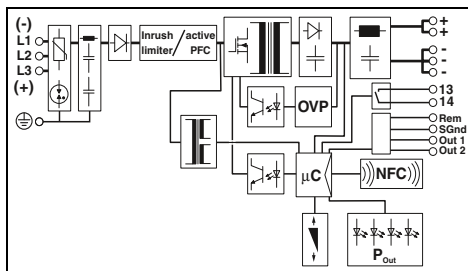

Technical data

3x 400 V AC ... 500 V AC -20% ... +10%
2x 400 V AC ... 500 V AC -10% ... +10%
± 260 V DC ... 300 V DC -13% ... +30%
50 Hz ... 60 Hz -10% ... +10%
3x 0.5 A (400 V AC) / 3x 0.41 A (480 V AC)
2x 1.1 A (400 V AC) / 2x 0.91 A (480 V AC)
0.7 A (± 260 V DC) / 0.6 A (± 300 V DC)
typ. 3 A / < 0.1 A²s
typ. 29 ms (3x 400 V AC) / typ. 26 ms (3x 480 V AC)

24 V DC
10 A / 12.5 A / 20 A / 60 A (15 ms)
A1...A6 / B2...B6 / C1...C3 / Z1...Z6
Yes / yes
< 5 W (480 V AC) / < 20 W (480 V AC)
typ. 93% (400 V AC) / typ. 92.6% (480 V AC)
< 75 mV_{pp}

DC OK, utilization indicator
Relay contact 13/14, Out 1 digital, Out 2 digital/analog
I_{Out}, U_{Out}, P_{Out}, U_{In} OK, operating hours, Temp. OK, OVP, 3AC OK

0.9 kg / 50 x 130 x 125 mm
alignable: 5 mm horizontally, 15 mm next to active components,
50 mm vertically
Screw connection
0.2 - 6 mm² / 0.2 - 4 mm² / 24 - 10
0.2 - 2.5 mm² / 0.2 - 2.5 mm² / 24 - 14
0.2 - 1 mm² / 0.2 - 1.5 mm² / 24 - 16
IP20 / I
> 654000 h (40°C)
-25°C ... 70°C (> 60°C Derating: 2.5%/K)
-40°C

2.4 kV AC (routine test) / 4 kV AC (type test)
Conformance with EMC Directive 2014/30/EU
IEC 60950-1/VDE 0805 (SELV)
EN 61558-2-16
III (≤ 2000 m), II (≤ 5000 m), I (≤ 5000 m)

UL Listed UL 508, UL/C-UL Recognized UL 60950-1,
UL ANSI/ISA-12.12.01 Class I, Division 2, Groups A, B, C, D
(Hazardous Location)
EN 61000-3-2

Ordering data

Type	Order No.	Pcs./Pkt.
QUINT4-PS/3AC/24DC/10	2904621	1

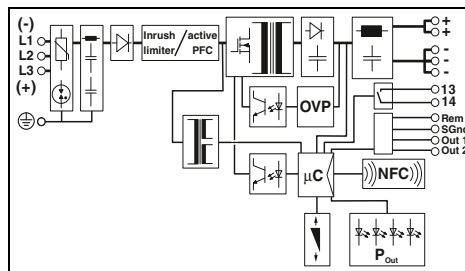

Technical data

3x 400 V AC ... 500 V AC -20% ... +10%
2x 400 V AC ... 500 V AC -10% ... +10%
± 260 V DC ... 300 V DC -13% ... +30%
50 Hz ... 60 Hz -10% ... +10%
3x 0.99 A (400 V AC) / 3x 0.81 A (480 V AC)
2x 1.62 A (400 V AC) / 2x 1.37 A (480 V AC)
1.23 A (± 260 V DC) / 1.06 A (± 300 V DC)
typ. 2 A / < 0.1 A²s
typ. 33 ms (3x 400 V AC) / typ. 33 ms (3x 480 V AC)

24 V DC
20 A / 25 A / 30 A / 120 A (15 ms)
A1...A16 / B2...B13 / C1...C6 / Z1...Z16
Yes / yes
< 7 W (480 V AC) / < 33 W (480 V AC)
typ. 93.9% (400 V AC) / typ. 93.8% (480 V AC)
< 60 mV_{pp}

DC OK, utilization indicator
Relay contact 13/14, Out 1 digital, Out 2 digital/analog
I_{Out}, U_{Out}, P_{Out}, U_{In} OK, operating hours, Temp. OK, OVP, 3AC OK

1.1 kg / 70 x 130 x 125 mm
alignable: 5 mm horizontally, 15 mm next to active components,
50 mm vertically
Screw connection
0.2 - 6 mm² / 0.2 - 4 mm² / 24 - 10
0.2 - 6 mm² / 0.2 - 4 mm² / 24 - 10
0.2 - 1 mm² / 0.2 - 1.5 mm² / 24 - 16
IP20 / I
> 638000 h (40°C)
-25°C ... 70°C (> 60°C Derating: 2.5%/K)
-40°C

2.4 kV AC (routine test) / 4 kV AC (type test)
Conformance with EMC Directive 2014/30/EU
IEC 60950-1/VDE 0805 (SELV)
EN 61558-2-16
III (≤ 2000 m), II (≤ 5000 m), I (≤ 5000 m)

UL Listed UL 508, UL/C-UL Recognized UL 60950-1,
UL ANSI/ISA-12.12.01 Class I, Division 2, Groups A, B, C, D
(Hazardous Location)
EN 61000-3-2

Ordering data

Type	Order No.	Pcs./Pkt.
QUINT4-PS/3AC/24DC/20	2904622	1

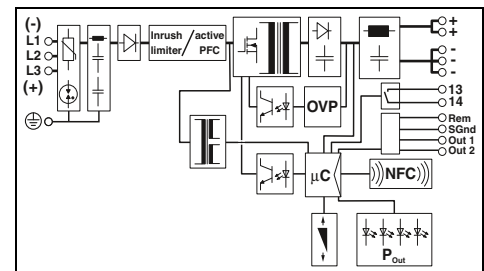

Technical data

3x 400 V AC ... 500 V AC -20% ... +10%
2x 400 V AC ... 500 V AC -10% ... +10%
± 260 V DC ... 300 V DC -13% ... +30%
50 Hz ... 60 Hz -10% ... +10%
3x 3 A (400 V AC) / 2x 3 A (400 V AC)
3x 2.6 A (480 V AC) / 2x 2.5 A (480 V AC)
2.5 A (± 260 V DC) / 2.2 A (± 300 V DC)
typ. 0 A / < 0 A²s
typ. 24 ms (3x 400 V AC) / typ. 25 ms (3x 480 V AC)

24 V DC
40 A / 45 A / 60 A (5 s) / 215 A (15 ms)
A1 ... A16 / B2 ... B25 / C1 ... C13 / Z1 ... Z16
Yes / yes
< 5 W (480 V AC) / < 45 W (480 V AC)
typ. 95% (400 V AC) / typ. 96% (480 V AC)
< 50 mV_{pp}

DC OK, utilization indicator
Relay contact 13/14, Out 1 digital, Out 2 digital/analog
I_{Out}, U_{Out}, P_{Out}, U_{In} OK, operating hours, Temp. OK, OVP, 3AC OK

2.6 kg / 120 x 130 x 125 mm
alignable: 5 mm horizontally, 15 mm next to active components,
50 mm vertically
Screw connection
0.2 - 6 mm² / 0.2 - 4 mm² / 30 - 10
0.5 - 16 mm² / 0.5 - 16 mm² / 8 - 6
0.2 - 1.5 mm² / 0.2 - 1.5 mm² / 24 - 16
IP20 / I
> 500000 h (40°C)
-25°C ... 70°C (> 60°C Derating: 2.5%/K)
-40°C

2.4 kV AC (routine test) / 4 kV AC (type test)
Conformance with EMC Directive 2014/30/EU
IEC 60950-1/VDE 0805 (SELV)
EN 61558-2-16
III (≤ 2000 m), II (≤ 5000 m), I (≤ 5000 m)

UL Listed UL 508, UL/C-UL Recognized UL 60950-1,
UL ANSI/ISA-12.12.01 Class I, Division 2, Groups A, B, C, D
(Hazardous Location)
EN 61000-3-2

Ordering data

Type	Order No.	Pcs./Pkt.
QUINT4-PS/3AC/24DC/40	2904623	1

Power supplies

QUINT POWER power supplies – Maximum functionality

QUINT POWER with protective coating

- The protective coating protects against extreme ambient conditions, such as dust, pollution, corrosive gases, and 100% humidity.
- Integrated decoupling MOSFET for 1+1 and n+1 redundancy
 - Devices with protective coating and IECEx approvals compliant with standards IEC 60079-0, IEC 60079-7, IEC 60079-11, and IEC 60079-15 may be installed in a potentially explosive area (zone 2)
 - They are suitable for use in Class I, Division 2, Groups A, B, C, D
 - OVP (overvoltage protection) with SIL3 certification in accordance with IEC 61508 limits surge voltages to 30 V
 - Wide temperature range from -40°C to +75°C
 - Easy system extension, thanks to static boost; starting of heavy loads, thanks to dynamic boost
 - SFB Technology selectively trips standard circuit breakers; consumers connected in parallel continue working
 - High noise immunity, thanks to integrated gas-filled surge arrester and a mains failure buffer time of more than 20 ms
 - Comprehensive signaling with preventive function monitoring
 - Signaling thresholds and characteristic curves can be set via NFC, available pre-configured from a batch quantity of 1

Input data
Input voltage range
Frequency range (f_N)
Typical current consumption (in static boost)
Inrush current limitation at 25°C / I _{tr}
Mains buffering (I _N)
Output data
Nominal output voltage (U _N)
Output current I _N / I _{Stat. Boost} / I _{Dyn. Boost} / I _{SFB}
Magnetic circuit breaker tripping
Can be connected in parallel/series
Max. power dissipation (no load/nominal load)
Efficiency
Residual ripple
Signaling
LED signaling
Configurable signal output
Signal options
General data
Weight / Dimensions W x H x D
Connection
Connection method
Input connection data rigid / flexible / AWG
Output connection data rigid / flexible / AWG
Signal connection data rigid / flexible / AWG
Degree of protection / Protection class
MTBF (IEC 61709, SN 29500)
Ambient temperature (operation)
Standards/regulations
Insulation voltage input/output
Electromagnetic compatibility
Electrical safety
Safety transformers for switched-mode power supply units
Overvoltage category in accordance with EN 62477-1, EN 61010-1, EN 60950-1
UL approvals
Limitation of harmonic line currents

Description
Power supply, primary-switched



Power supply, 1 AC, 24 V DC, 20 A, plus version

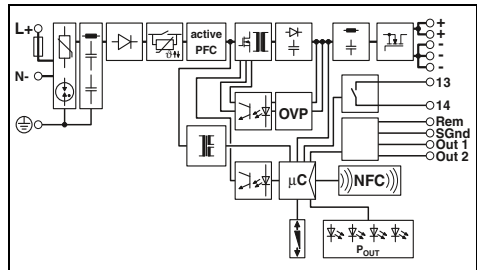

Technical data		
100 V AC ... 240 V AC -15% ... +10%		
110 V DC ... 250 V DC -18% ... +40%		
50 Hz ... 60 Hz -10% ... +10%		
6.8 A (100 V AC) / 5.5 A (120 V AC)		
2.8 A (230 V AC) / 2.7 A (240 V AC)		
6 A (110 V DC) / 2.5 A (250 V DC)		
typ. 10 A / < 0.3 A ² s		
typ. 36 ms (120 V AC) / typ. 36 ms (230 V AC)		
24 V DC		
20 A / 25 A / 30 A (5 s) / 120 A (15 ms)		
A1...A16 / B2...B13 / C1...C6 / Z1...Z16		
Yes / yes		
< 5 W (230 V AC) / < 30 W (230 V AC)		
typ. 92.7% (120 V AC) / typ. 94.2% (230 V AC)		
< 30 mV _{pp}		
DC OK, utilization indicator		
Relay contact 13/14, Out 1 digital, Out 2 digital/analog		
I _{Out} , U _{Out} , P _{Out} , U _{In} , OK, Operating hours, Temp. OK, OVP		
1.3 kg / 70 x 130 x 125 mm		
alignable: 5 mm horizontally, 15 mm next to active components, 50 mm vertically		
Screw connection		
0.2 - 6 mm ² / 0.2 - 4 mm ² / 30 - 10		
0.2 - 6 mm ² / 0.2 - 4 mm ² / 30 - 10		
0.2 - 1.5 mm ² / 0.2 - 1.5 mm ² / 24 - 16		
IP20 / I		
> 524000 h (40°C)		
-40°C ... 75°C (> 60°C Derating: 2.5%/K)		
2 kV AC (routine test) / 4 kV AC (type test)		
Conformance with EMC Directive 2014/30/EU		
IEC 60950-1/VDE 0805 (SELV)		
EN 61558-2-16		
III (≤ 2000 m), II (≤ 5000 m), I (≤ 5000 m)		
UL Listed UL 508, UL/C-UL Recognized UL 60950-1, UL ANSI/ISA-12.12.01 Class I, Division 2, Groups A, B, C, D (Hazardous Location)		
EN 61000-3-2		
Ordering data		
Type	Order No.	Pcs./Pkt.
QUINT4-PS/1AC/24DC/20/+	2904617	1

Power supplies

QUINT POWER power supplies – Maximum functionality

QUINT POWER, 1 AC, 12 V DC and 48 V DC

- Easy system extension with static boost
- Starting of heavy loads with dynamic boost
- SFB Technology selectively trips standard circuit breakers; consumers connected in parallel continue working
- High noise immunity, thanks to integrated gas-filled surge arrester and a mains failure buffer time of more than 20 ms
- Comprehensive signaling with preventive function monitoring
- Signaling thresholds and characteristic curves can be set via NFC, available pre-configured from a batch quantity of 1



new

Power supply,
1 AC, 12 V DC, 15 A

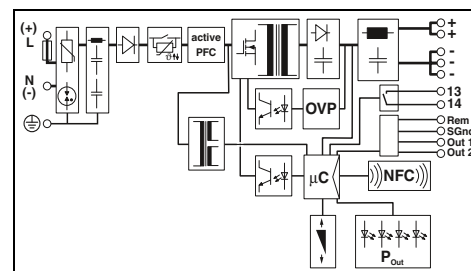

Technical data

Input data	
Input voltage range	100 V AC ... 240 V AC -15% ... +10% 110 V DC ... 250 V DC -18% ... +40%
Frequency range (f _N)	50 Hz ... 60 Hz -10% ... +10%
Typical current consumption (in static boost)	2.4 A (100 V AC) / 1.9 A (120 V AC) 1.1 A (230 V AC) / 1.1 A (240 V AC) 2.2 A (110 V DC) / 1 A (250 V DC) typ. 15 A / < 0.6 A ^{2s}
Inrush current limitation at 25°C / I _{It}	typ. 55 ms (120 V AC) / typ. 56 ms (230 V AC)
Mains buffering (I _N)	
Output data	
Nominal output voltage (U _N)	12 V DC
Output current I _N / I _{Stat. Boost} / I _{Dyn. Boost} / I _{SFB}	15 A / 17.5 A / 20 A (5 s) / 60 A (15 ms)
Magnetic circuit breaker tripping	A1...A6 / B2...B6 / C1...C2 / Z1...Z6
Can be connected in parallel/series	Yes / yes
Max. power dissipation (no load/nominal load)	< 4 W (230 V AC) / < 16 W (230 V AC)
Efficiency	typ. 91.2% (120 V AC) / typ. 92% (230 V AC)
Residual ripple	< 70 mV _{pp}
Signaling	
LED signaling	DC OK, utilization indicator
Configurable signal output	Relay contact 13/14, Out 1 digital, Out 2 digital/analog
Signal options	I _{Out} , U _{Out} , P _{Out} , U _{In} , OK, Operating hours, Temp. OK, OVP
General data	
Weight / Dimensions W x H x D	1 kg / 50 x 130 x 125 mm
Connection	alignable: 5 mm horizontally, 15 mm next to active components, 50 mm vertically
Connection method	Screw connection
Input connection data rigid / flexible / AWG	0.2 - 2.5 mm ² / 0.2 - 2.5 mm ² / 24 - 14
Output connection data rigid / flexible / AWG	0.2 - 2.5 mm ² / 0.2 - 2.5 mm ² / 24 - 14
Signal connection data rigid / flexible / AWG	0.2 - 1 mm ² / 0.2 - 1.5 mm ² / 24 - 16
Degree of protection / Protection class	IP20 / I
MTBF (IEC 61709, SN 29500)	> 749000 h (40°C)
Ambient temperature (operation)	-25°C ... 70°C (> 60°C Derating: 2.5%/K)
Ambient temperature (startup type tested)	-40°C
Standards/regulations	
Insulation voltage input/output	2 kV AC (routine test) / 4 kV AC (type test)
Electromagnetic compatibility	Conformance with EMC Directive 2014/30/EU
Electrical safety	IEC 60950-1/VDE 0805 (SELV)
Safety transformers for switched-mode power supply units	EN 61558-2-16
Overvoltage category in accordance with EN 62477-1, EN 61010-1, EN 60950-1	III (≤ 2000 m), II (≤ 5000 m), I (≤ 5000 m)
UL approvals	UL Listed UL 508, UL/C-UL Recognized UL 60950-1, UL ANSI/ISA-12.12.01 Class I, Division 2, Groups A, B, C, D (Hazardous Location)
Limitation of harmonic line currents	EN 61000-3-2

Ordering data

Description	Type	Order No.	Pcs./Pkt.
Power supply, primary-switched	QUINT4-PS/1AC/12DC/15	2904608	1

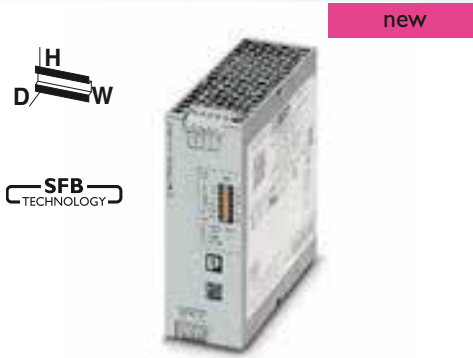

Power supply,
1 AC, 48 V DC, 5 A

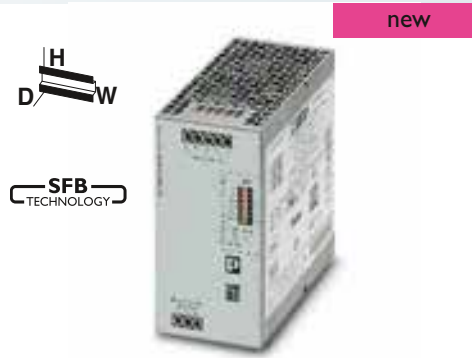

Power supply,
1 AC, 48 V DC, 10 A

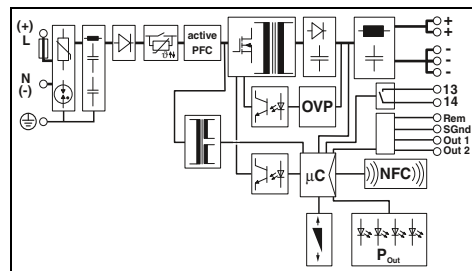
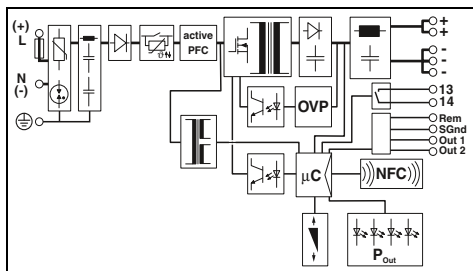

Technical data

Technical data

100 V AC ... 240 V AC -15% ... +10%
110 V DC ... 250 V DC -18% ... +40%
50 Hz ... 60 Hz -10% ... +10%
3.4 A (100 V AC) / 2.8 A (120 V AC)
1.5 A (230 V AC) / 1.5 A (240 V AC)
3 A (110 V DC) / 1.3 A (250 V DC)
typ. 16 A / < 0.5 A²s
typ. 43 ms (120 V AC) / typ. 43 ms (230 V AC)

100 V AC ... 240 V AC -15% ... +10%
110 V DC ... 250 V DC -18% ... +40%
50 Hz ... 60 Hz -10% ... +10%
6.8 A (100 V AC) / 5.5 A (120 V AC)
2.8 A (230 V AC) / 2.7 A (240 V AC)
6 A (110 V DC) / 2.5 A (250 V DC)
typ. 11 A / < 0.4 A²s
typ. 32 ms (120 V AC) / typ. 32 ms (230 V AC)

48 V DC
5 A / 6.25 A / 10 A (5 s) / 30 A (15 ms)
A1...A6 / B2 / C1...C2 / Z1...Z6
Yes / yes
< 3 W (230 V AC) / < 16 W (230 V AC)
typ. 92.3% (120 V AC) / typ. 93.5% (230 V AC)
< 70 mV_{pp}

48 V DC
10 A / 12.5 A / 15 A (5 s) / 60 A (15 ms)
A1...A13 / B2...B6 / C1...C3 / Z1...Z10
Yes / yes
< 5 W (230 V AC) / < 28 W (230 V AC)
typ. 94% (120 V AC) / typ. 95% (230 V AC)
< 70 mV_{pp}

DC OK, utilization indicator
Relay contact 13/14, Out 1 digital, Out 2 digital/analog
I_{Out}, U_{Out}, P_{Out}, U_{In}, OK, Operating hours, Temp. OK, OVP

DC OK, utilization indicator
Relay contact 13/14, Out 1 digital, Out 2 digital/analog
I_{Out}, U_{Out}, P_{Out}, U_{In}, OK, Operating hours, Temp. OK, OVP

1 kg / 50 x 130 x 125 mm
alignable: 5 mm horizontally, 15 mm next to active components,
50 mm vertically
Screw connection
0.2 - 2.5 mm² / 0.2 - 2.5 mm² / 24 - 14
0.2 - 2.5 mm² / 0.2 - 2.5 mm² / 24 - 14
0.2 - 1 mm² / 0.2 - 1.5 mm² / 24 - 16
IP20 / I
> 784000 h (40°C)
-25°C ... 70°C (> 60°C Derating: 2.5%/K)
-40°C

1.3 kg / 70 x 130 x 125 mm
alignable: 5 mm horizontally, 15 mm next to active components,
50 mm vertically
Screw connection
0.2 - 6 mm² / 0.2 - 4 mm² / 30 - 10
0.2 - 2.5 mm² / 0.2 - 2.5 mm² / 30 - 10
0.2 - 1 mm² / 0.2 - 1.5 mm² / 24 - 16
IP20 / I
> 676000 h (40°C)
-25°C ... 70°C (> 60°C Derating: 2.5%/K)
-40°C

2 kV AC (routine test) / 4 kV AC (type test)
Conformance with EMC Directive 2014/30/EU
IEC 60950-1/VDE 0805 (SELV)
EN 61558-2-16
III (≤ 2000 m), II (≤ 5000 m), I (≤ 5000 m)

2 kV AC (routine test) / 4 kV AC (type test)
Conformance with EMC Directive 2014/30/EU
IEC 60950-1/VDE 0805 (SELV)
EN 61558-2-16
III (≤ 2000 m), II (≤ 5000 m), I (≤ 5000 m)

UL Listed UL 508, UL/C-UL Recognized UL 60950-1,
UL ANSI/ISA-12.12.01 Class I, Division 2, Groups A, B, C, D
(Hazardous Location)
EN 61000-3-2

UL Listed UL 508, UL/C-UL Recognized UL 60950-1,
UL ANSI/ISA-12.12.01 Class I, Division 2, Groups A, B, C, D
(Hazardous Location)
EN 61000-3-2

Ordering data

Ordering data

Type	Order No.	Pcs./Pkt.
QUINT4-PS/1AC/48DC/5	2904610	1

Type	Order No.	Pcs./Pkt.
QUINT4-PS/1AC/48DC/10	2904611	1

Power supplies

QUINT POWER power supplies – Maximum functionality

QUINT POWER, 1 AC, 24 V DC

- Fast tripping of standard miniature circuit breakers with dynamic power reserve SFB (Selective Fuse Breaking) Technology with up to 6 times the nominal current for 12 ms
- Reliable starting of heavy loads with the static Power Boost power reserve with up to 1.5 times the nominal current
- Preventive function monitoring
- Flexible, thanks to input voltage ranges for AC and DC voltages
- Approved for semiconductor production in accordance with SEMI F47-0706



Power supply,
1 AC, 24 V DC, 3.5 A

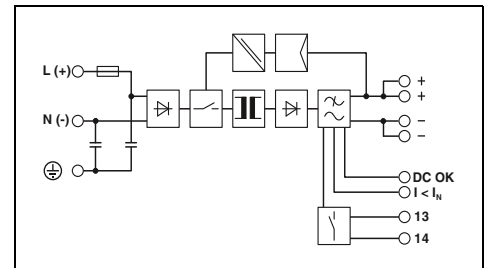

Technical data

Input data	100 V AC ... 240 V AC 85 V AC ... 264 V AC 90 V DC ... 350 V DC 45 Hz ... 65 Hz / 0 Hz 1.4 A (120 V AC) / 0.8 A (230 V AC) < 20 A / < 2 A ² s typ. 20 ms (120 V AC) / typ. 80 ms (230 V AC)
Nominal input voltage range	
Input voltage range	
Frequency range	
Current consumption (nominal load)	
Inrush current limitation at 25°C / I ² t	
Mains buffering (I _N)	
Output data	24 V DC ±1% 18 V DC ... 29.5 V DC (> 24 V DC, constant capacity restricted)
Nominal output voltage (U _N)	
Setting range of the output voltage (U _{set})	
Output current / Power Boost / SFB (12 ms)	3.5 A / 4 A / 15 A
Magnetic circuit breaker tripping	B2
Can be connected in parallel/series	Yes / yes
Max. power dissipation (no load/nominal load)	3.5 W / 11 W
Efficiency	> 88% (for 230 V AC and nominal values)
Residual ripple	< 50 mV _{PP}
Signaling	LED, active switching output, relay contact LED, active switching output
Signaling DC OK	
Boost signaling	
General data	0.5 kg / 32 x 130 x 125 mm alignable: 5 mm horizontally, 15 mm next to active components, 50 mm vertically Plug-in screw connection
Weight / Dimensions W x H x D	
Connection	
Connection method	
Input connection data rigid / flexible / AWG	0.2 - 2.5 mm ² / 0.2 - 2.5 mm ² / 20 - 12
Output connection data rigid / flexible / AWG	0.2 - 2.5 mm ² / 0.2 - 2.5 mm ² / 20 - 12
Signal connection data rigid / flexible / AWG	0.2 - 2.5 mm ² / 0.2 - 2.5 mm ² / 20 - 12
Degree of protection / Protection class	IP20 / I
MTBF (IEC 61709, SN 29500)	> 820000 h (40°C)
Ambient temperature (operation)	-25°C ... 70°C (> 60°C Derating: 2.5%/K)
Standards/regulations	2 kV AC (routine test) / 4 kV AC (type test) Conformance with EMC Directive 2014/30/EU IEC 60950-1/VDE 0805 (SELV) EN 50178/VDE 0160 (PELV) DIN VDE 0100-410 IEC 60601-1, 2 x MOOP UL Listed UL 508, UL/C-UL Recognized UL 60950-1, UL ANSI/ISA-12.12.01 Class I, Division 2, Groups A, B, C, D (Hazardous Location) EN 61000-3-2
Insulation voltage input/output	
Electromagnetic compatibility	
Electrical safety	
Electronic equipm. for electrical power installations	
Safe isolation	
Medical standard	
UL approvals	
Limitation of harmonic line currents	

Ordering data

Description	Type	Order No.	Pcs./Pkt.
Power supply, primary-switched	QUINT-PS/1AC/24DC/ 3.5	2866747	1

QUINT POWER power supplies – Maximum functionality

QUINT POWER, 1 AC, 12 V DC and 48 V DC

- Fast tripping of standard miniature circuit breakers
- Reliable starting of heavy loads
- Preventive function monitoring
- Flexible, thanks to input voltage ranges for AC and DC voltages
- Approved for semiconductor production in accordance with SEMI F47-0706: 12 V DC and 48 V DC, 5 A and 10 A
- Adjustable output voltage of 5 to 18 V DC, or 30 to 56 V DC



**Power supply,
1 AC, 12 V DC, 20 A**



**Power supply,
1 AC, 48 V DC, 20 A**

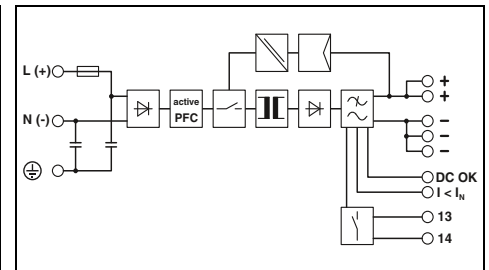
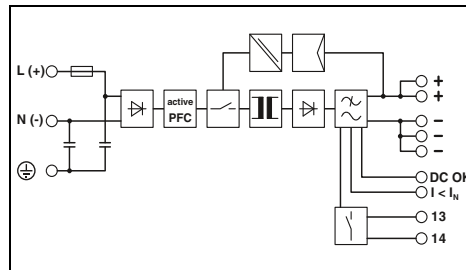

Technical data

Technical data

Input data	
Nominal input voltage range	100 V AC ... 240 V AC
Input voltage range	
Frequency range	85 V AC ... 264 V AC 90 V DC ... 350 V DC
Current consumption (nominal load)	45 Hz ... 65 Hz / 0 Hz
Inrush current limitation at 25°C / I ² t	2.4 A (120 V AC) / 1.4 A (230 V AC)
Mains buffering (I _N)	< 20 A / < 3.2 A ² s
Output data	
Nominal output voltage (U _N)	typ. 40 ms (120 V AC) / typ. 40 ms (230 V AC)
Setting range of the output voltage (U _{Set})	12 V DC ±1%
Output current / Power Boost / SFB (12 ms)	
Magnetic circuit breaker tripping	5 V DC ... 18 V DC (> 12 V DC, constant capacity restricted)
Can be connected in parallel/series	20 A / 26 A / -
Max. power dissipation (no load/nominal load)	B2 / B4 / B6 / B10 / C2 / C4 / C6
Efficiency	Yes / yes
Residual ripple	12 W / 29 W
Signaling	> 90% (for 230 V AC and nominal values)
Signaling DC OK	< 50 mV _{pp}
Boost signaling	LED, active switching output, relay contact
General data	
Weight / Dimensions W x H x D	LED, active switching output
Connection	1.5 kg / 90 x 130 x 125 mm
Connection method	
Input connection data rigid / flexible / AWG	alignable: 5 mm horizontally, 15 mm next to active components, 50 mm vertically
Output connection data rigid / flexible / AWG	Screw connection
Signal connection data rigid / flexible / AWG	0.2 - 6 mm ² / 0.2 - 4 mm ² / 18 - 10
Degree of protection / Protection class	0.2 - 6 mm ² / 0.2 - 4 mm ² / 12 - 10
MTBF (IEC 61709, SN 29500)	0.2 - 6 mm ² / 0.2 - 4 mm ² / 18 - 10
Ambient temperature (operation)	IP20 / I
Standards/regulations	> 600000 h (40°C)
Insulation voltage input/output	-25°C ... 70°C (> 60°C Derating: 2.5%/K)
Electromagnetic compatibility	2 kV AC (routine test) / 4 kV AC (type test)
Electrical safety	Conformance with EMC Directive 2014/30/EU
Electronic equipm. for electrical power installations	IEC 60950-1/VDE 0805 (SELV)
Safe isolation	EN 50178/VDE 0160 (PELV)
Medical standard	DIN VDE 0100-410
UL approvals	IEC 60601-1, 2 x MOOP
Limitation of harmonic line currents	
	UL Listed UL 508, UL/C-UL Recognized UL 60950-1, UL ANSI/ISA-12.12.01 Class I, Division 2, Groups A, B, C, D (Hazardous Location)
	EN 61000-3-2

Technical data	
Nominal input voltage range	100 V AC ... 240 V AC
Input voltage range	
Frequency range	85 V AC ... 264 V AC 90 V DC ... 350 V DC
Current consumption (nominal load)	45 Hz ... 65 Hz / 0 Hz
Inrush current limitation at 25°C / I ² t	2.4 A (120 V AC) / 1.4 A (230 V AC)
Mains buffering (I _N)	< 20 A / < 3.2 A ² s
Output data	
Nominal output voltage (U _N)	typ. 40 ms (120 V AC) / typ. 40 ms (230 V AC)
Setting range of the output voltage (U _{Set})	12 V DC ±1%
Output current / Power Boost / SFB (12 ms)	
Magnetic circuit breaker tripping	5 V DC ... 18 V DC (> 12 V DC, constant capacity restricted)
Can be connected in parallel/series	20 A / 22.5 A / 100 A
Max. power dissipation (no load/nominal load)	B2 / B4 / B6 / B10 / C2 / C4 / C6
Efficiency	Yes / yes
Residual ripple	12 W / 29 W
Signaling	> 93% (for 230 V AC and nominal values)
Signaling DC OK	< 50 mV _{pp}
Boost signaling	LED, active switching output, relay contact
General data	
Weight / Dimensions W x H x D	LED, active switching output
Connection	3.3 kg / 180 x 130 x 125 mm
Connection method	
Input connection data rigid / flexible / AWG	alignable: 5 mm horizontally, 15 mm next to active components, 50 mm vertically
Output connection data rigid / flexible / AWG	Screw connection
Signal connection data rigid / flexible / AWG	0.2 - 6 mm ² / 0.2 - 4 mm ² / 14 - 10
Degree of protection / Protection class	0.5 - 16 mm ² / 0.5 - 16 mm ² / 8 - 6
MTBF (IEC 61709, SN 29500)	0.2 - 6 mm ² / 0.2 - 4 mm ² / 24 - 10
Ambient temperature (operation)	IP20 / I
Standards/regulations	> 523000 h (40°C)
Insulation voltage input/output	-25°C ... 70°C (> 60°C Derating: 2.5%/K)
Electromagnetic compatibility	2 kV AC (routine test) / 4 kV AC (type test)
Electrical safety	Conformance with EMC Directive 2014/30/EU
Electronic equipm. for electrical power installations	IEC 60950-1/VDE 0805 (SELV)
Safe isolation	EN 50178/VDE 0160 (PELV)
Medical standard	DIN VDE 0100-410
UL approvals	-
Limitation of harmonic line currents	
	UL Listed UL 508, UL/C-UL Recognized UL 60950-1, UL ANSI/ISA-12.12.01 Class I, Division 2, Groups A, B, C, D (Hazardous Location)
	EN 61000-3-2

Ordering data

Ordering data

Description	Type	Order No.	Pcs./Pkt.
Power supply, primary-switched	QUINT-PS/1AC/12DC/20	2866721	1

Description	Type	Order No.	Pcs./Pkt.
Power supply, primary-switched	QUINT-PS/1AC/48DC/20	2866695	1

Description	Type	Order No.	Pcs./Pkt.
Power supply, primary-switched	QUINT-PS/1AC/48DC/20	2866695	1

Power supplies and UPS

Power supplies

QUINT POWER power supplies – Maximum functionality

QUINT POWER, 3 AC, 48 V DC

- High system availability even in the event of a permanent phase failure
- High surge strength of up to 6 kV, thanks to integrated gas-filled surge arresters
- Fast tripping of standard miniature circuit breakers with dynamic power reserve SFB (Selective Fuse Breaking) Technology with up to 6 times the nominal current for 12 ms
- Reliable starting of heavy loads with the static Power Boost power reserve with up to 1.5 times the nominal current
- Preventive function monitoring
- Flexible, thanks to input voltage ranges for AC and DC voltages
- Adjustable output voltage of 30 to 56 V DC



Power supply,
3 AC, 48 V DC, 20 A

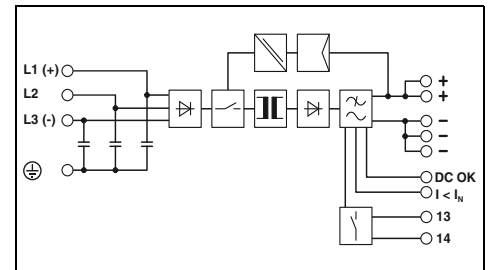

Technical data

Input data	3x 400 V AC ... 500 V AC 3x 320 V AC ... 575 V AC 2x 360 V AC ... 575 V AC 450 V DC ... 800 V DC
Nominal input voltage range	45 Hz ... 65 Hz / 0 Hz
Input voltage range	3x 2.1 A (400 V AC) / 3x 1.7 A (500 V AC) < 20 A / < 1 A ² s typ. 25 ms (400 V AC) / typ. 35 ms (500 V AC)
Frequency range	48 V DC ±1%
Current consumption (nominal load)	30 V DC ... 56 V DC (> 48 V DC, constant capacity restricted)
Inrush current limitation at 25°C / I ² t	20 A / 22.5 A / 100 A B2 / B4 / B6 / B10 / C2 / C4 / C6
Mains buffering (I _N)	Yes / yes 24 W / 70 W
Output data	> 93% (at 400 V AC and nominal values) < 50 mV _{PP}
Nominal output voltage (U _N)	LED, active switching output, relay contact LED, active switching output
Setting range of the output voltage (U _{Set})	2.5 kg / 96 x 130 x 179 mm alignable: 5 mm horizontally, 15 mm next to active components, 50 mm vertically
Output current / Power Boost / SFB (12 ms)	Screw connection
Magnetic circuit breaker tripping	0.2 - 6 mm ² / 0.2 - 4 mm ² / 18 - 10
Can be connected in parallel/series	0.5 - 16 mm ² / 0.5 - 16 mm ² / 8 - 6
Max. power dissipation (no load/nominal load)	0.2 - 6 mm ² / 0.2 - 4 mm ² / 18 - 10
Efficiency	IP20 / I
Residual ripple	> 509000 h (40°C) -25°C ... 70°C (> 60°C Derating: 2.5%/K)
Signaling	2 kV AC (routine test) / 4 kV AC (type test)
Signaling DC OK	Conformance with EMC Directive 2014/30/EU
Boost signaling	IEC 60950-1/VDE 0805 (SELV)
General data	EN 50178/VDE 0160 (PELV)
Weight / Dimensions W x H x D	DIN VDE 0100-410
Connection	UL Listed UL 508, UL/C-UL Recognized UL 60950-1 (3-wire + PE, star net), UL ANSI/ISA-12.12.01 Class I, Division 2, Groups A, B, C, D (Hazardous Location)
Connection method	EN 61000-3-2
Input connection data rigid / flexible / AWG	
Output connection data rigid / flexible / AWG	
Signal connection data rigid / flexible / AWG	
Degree of protection / Protection class	
MTBF (IEC 61709, SN 29500)	
Ambient temperature (operation)	
Standards/regulations	
Insulation voltage input/output	
Electromagnetic compatibility	
Electrical safety	
Electronic equipm. for electrical power installations	
Safe isolation	
UL approvals	
Limitation of harmonic line currents	

Ordering data

Description	Order No.	Pcs./Pkt.
Power supply, primary-switched	2320827	1
QUINT-PS/3AC/48DC/20	2320827	1

Power supplies for frequency inverters

QUINT POWER and TRIO POWER for frequency inverters

- In the event of mains failure, the DC intermediate circuit voltage of the inverter continues to supply all connected 24 V loads without interruption
- Maintenance-free buffer solution: controlled machine stop in the event of mains failure by using the existing capacity in the frequency inverter or by using the kinetic energy of motors

QUINT POWER

- Combined solution with a QUINT POWER power supply

TRIO POWER

- Standard solution with two TRIO POWER power supplies



Power supply with two separate input circuits for frequency inverters
2 AC, 1 DC/24 V DC, 20 A

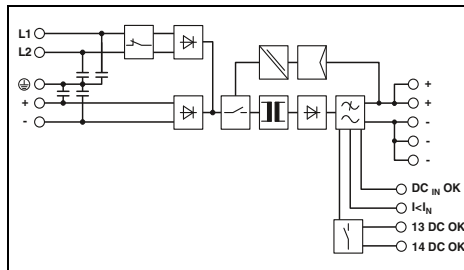

Technical data

Input data	
Nominal input voltage range	2x 400 V AC ... 500 V AC 600 V DC
Input voltage range	2x 360 V AC ... 575 V AC 450 V DC ... 840 V DC
Frequency range	45 Hz ... 65 Hz / 0 Hz
Current consumption (nominal load)	2.5 A (400 V AC) / 2.1 A (500 V AC) 0.9 A (600 V DC)
Inrush current limitation at 25°C / I ² t	< 85 A / < 1.5 A ² s
Mains buffering (I _N)	typ. 20 ms (400 V AC)
Output data	
Nominal output voltage (U _N)	24 V DC ±1%
Setting range of the output voltage (U _{Set})	18 V DC ... 29.5 V DC (U _{IN} ≥ 360 V AC / 480 V DC) 18 V DC ... 26 V DC (< 480 V DC)
Output current / Power Boost / SFB (20 ms)	20 A / 26 A / 120 A
Magnetic circuit breaker tripping	C6 / B16
Max. power dissipation (no load/nominal load)	11 W / 51 W
Efficiency	> 92% (600 V DC) / > 90.5% (400 V AC)
Residual ripple	< 50 mV _{pp}
Signaling	
Signaling DC OK	LED, relay contact
Boost signaling	LED, active switching output
Signaling DC _{IN} OK	LED, active switching output
General data	
Weight / Dimensions W x H x D	2 kg / 120 x 130 x 125 mm
Connection	alignable: 5 mm horizontally, 15 mm next to active components, 50 mm vertically
Connection method	Screw connection
Input connection data rigid / flexible / AWG	0.2 - 6 mm ² / 0.2 - 4 mm ² / 24 - 10
Output connection data rigid / flexible / AWG	0.2 - 6 mm ² / 0.2 - 4 mm ² / 12 - 10
Signal connection data rigid / flexible / AWG	0.2 - 6 mm ² / 0.2 - 4 mm ² / 24 - 10
Degree of protection / Protection class	IP20 / I
MTBF (IEC 61709, SN 29500)	> 860000 h (40°C)
Ambient temperature (operation)	-25°C ... 70°C (> 60°C Derating: 2.5%/K)
Standards/regulations	
Insulation voltage input/output	2 kV AC (routine test) / 1.5 kV AC (type test)
Electromagnetic compatibility	Conformance with EMC Directive 2014/30/EU
Electrical safety	EN 60950-1/VDE 0805 (SELV)
Electronic equipm. for electrical power installations	EN 50178/VDE 0160 (PELV)
Safe isolation	DIN VDE 0100-410
UL approvals	UL/C-UL Listed UL 508, UL/C-UL Recognized UL 60950-1

Ordering data

Description	Type	Order No.	Pcs./Pkt.
Power supply, primary-switched	QUINT-PS/2AC/1DC/24DC/20	2320830	1



Power supply, 600 V DC, 24 V DC, 20 A

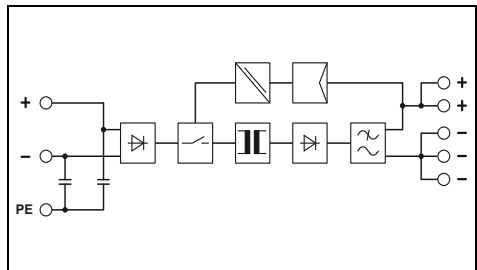

Technical data

Input data	
Nominal input voltage range	600 V DC
Input voltage range	450 V DC ... 840 V DC
Frequency range	- / 0 Hz
Current consumption (nominal load)	0.9 A (600 V DC)
Inrush current limitation at 25°C / I ² t	< 26 A / 0.8 A ² s
Mains buffering (I _N)	typ. 15 ms (600 V DC)
Output data	
Nominal output voltage (U _N)	24 V DC ±1%
Setting range of the output voltage (U _{Set})	22.5 V DC ... 29.5 V DC (U _{IN} > 475 V DC) 22.5 V DC ... 28 V DC (U _{IN} ≤ 475 V DC)
Output current / Power Boost / SFB (20 ms)	20 A / - / -
Magnetic circuit breaker tripping	-
Max. power dissipation (no load/nominal load)	3.8 W / 45 W
Efficiency	> 91% (With 600 V DC and nominal values)
Residual ripple	< 40 mV _{pp}
Signaling	
Signaling DC OK	LED
Boost signaling	-
Signaling DC _{IN} OK	-
General data	
Weight / Dimensions W x H x D	2 kg / 115 x 130 x 152.5 mm
Connection	alignable: horizontally 0 mm, vertically 50 mm
Connection method	Screw connection
Input connection data rigid / flexible / AWG	0.2 - 2.5 mm ² / 0.2 - 2.5 mm ² / 24 - 14
Output connection data rigid / flexible / AWG	0.5 - 6 mm ² / 0.5 - 4 mm ² / 12 - 10
Signal connection data rigid / flexible / AWG	- mm ² / - mm ² / -
Degree of protection / Protection class	IP20 / I
MTBF (IEC 61709, SN 29500)	> 701000 h (40°C)
Ambient temperature (operation)	-25°C ... 70°C (> 55°C derating: 2.5%/K)
Standards/regulations	
Insulation voltage input/output	2 kV AC (routine test) / 4 kV AC (type test)
Electromagnetic compatibility	Conformance with EMC Directive 2014/30/EU
Electrical safety	EN 60950-1/VDE 0805 (SELV)
Electronic equipm. for electrical power installations	EN 50178/VDE 0160 (PELV)
Safe isolation	DIN VDE 0100-410
UL approvals	UL/C-UL Listed UL 508, UL/C-UL Recognized UL 60950-1

Ordering data

Description	Type	Order No.	Pcs./Pkt.
Power supply, primary-switched	TRIO-PS/600DC/24DC/20	2866530	1

Power supplies

Power supplies for extreme requirements

QUINT POWER with protective coating

The protective coating protects against extreme ambient conditions, such as dust, pollution, corrosive gases, and 100% humidity.

- Devices with ATEX approval conform to standard EN 60079-15 and EN 60079-0 and may be installed in a potentially explosive area (zone 2)
- They are suitable for use in Class I, Division 2, Groups A, B, C, D
- Conformance with railway standard EN 50155
- OVP (overvoltage protection) limits surge voltages to 32 V
- Wide temperature range from -40°C to +70°C
- Fast tripping of standard miniature circuit breakers with dynamic power reserve SFB (Selective Fuse Breaking) Technology with up to 6 times the nominal current for 12 ms
- Reliable starting of heavy loads with the static Power Boost power reserve with up to 1.5 times the nominal current
- Preventive function monitoring
- Flexible, thanks to input voltage ranges for AC and DC voltages



Power supply, with protective coating, 1 AC, 24 V DC, 5 A

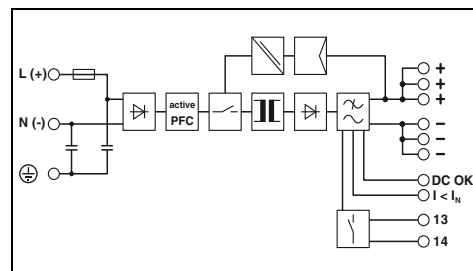

Technical data

Input data	
Nominal input voltage range	100 V AC ... 240 V AC 110 V DC ... 250 V DC
Input voltage range	85 V AC ... 264 V AC 90 V DC ... 410 V DC +5%
Frequency range	45 Hz ... 65 Hz / 0 Hz
Current consumption (nominal load)	1.2 A (120 V AC) / 0.6 A (230 V AC)
Inrush current limitation at 25°C / I ² t	< 15 A / < 1 A ² s
Mains buffering (I _N)	typ. 55 ms (120 V AC) / typ. 55 ms (230 V AC)
Output data	
Nominal output voltage (U _N)	24 V DC ±1%
Setting range of the output voltage (U _{Set})	18 V DC ... 29.5 V DC (> 24 V DC, constant capacity restricted)
Output current / Power Boost / SFB (12 ms)	5 A / 7.5 A / 30 A
Magnetic circuit breaker tripping	B2 / B4 / C2
Can be connected in parallel/series	Yes / yes
Max. power dissipation (no load/nominal load)	3 W / 15 W
Efficiency	> 90% (for 230 V AC and nominal values)
Residual ripple	< 40 mV _{pp}
Signaling	
Signaling DC OK	LED, active switching output, relay contact
Boost signaling	LED, active switching output
General data	
Weight / Dimensions W x H x D	0.7 kg / 40 x 130 x 125 mm
Connection	alignable: 5 mm horizontally, 15 mm next to active components, 50 mm vertically
Connection method	Plug-in screw connection
Input connection data rigid / flexible / AWG	0.2 - 2.5 mm ² / 0.2 - 2.5 mm ² / 20 - 12
Output connection data rigid / flexible / AWG	0.2 - 2.5 mm ² / 0.2 - 2.5 mm ² / 20 - 12
Signal connection data rigid / flexible / AWG	0.2 - 2.5 mm ² / 0.2 - 2.5 mm ² / 20 - 12
Degree of protection / Protection class	IP20 / I
MTBF (IEC 61709, SN 29500)	> 635000 h (40°C)
Ambient temperature (operation)	-40°C ... 70°C (> 60°C Derating: 2.5%/K)
Standards/regulations	
Insulation voltage input/output	2 kV AC (routine test) / 4 kV AC (type test)
Electromagnetic compatibility	Conformance with EMC Directive 2014/30/EU
Electrical safety	IEC 60950-1/VDE 0805 (SELV)
Electronic equipm. for electrical power installations	EN 50178/VDE 0160 (PELV)
Safe isolation	DIN VDE 0100-410
Rail applications	EN 50121-4 / EN 50155
UL approvals	UL/C-UL Listed UL 508, UL/C-UL Recognized UL 60950-1, UL ANSI/ISA-12.12.01 Class I, Division 2, Groups A, B, C, D (Hazardous Location)
Limitation of harmonic line currents	EN 61000-3-2

Ordering data

Description	Type	Order No.	Pcs./Pkt.
Power supply, primary-switched	QUINT-PS/1AC/24DC/ 5/CO	2320908	1



Power supply,
with protective coating,
1 AC, 24 V DC, 10 A

UL, IEC, ENEC, EAC, CE, ClassNK, CB, Ex: Ex



Power supply,
with protective coating,
1 AC, 24 V DC, 20 A

UL, IEC, ENEC, EAC, CE, ClassNK, CB, Ex: Ex



Power supply,
with protective coating,
3 AC, 24 V DC, 20 A

UL, IEC, ENEC, EAC, CE, ClassNK, CB, Ex: Ex

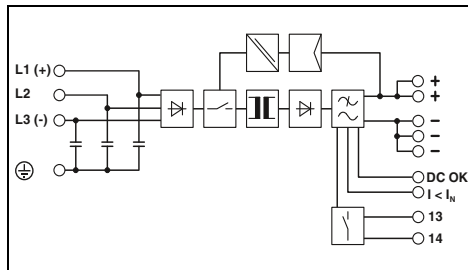
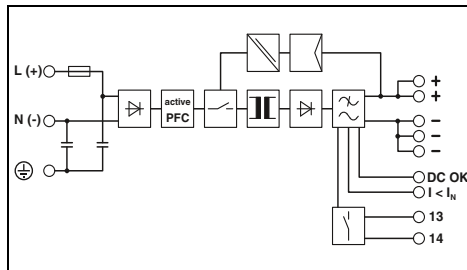
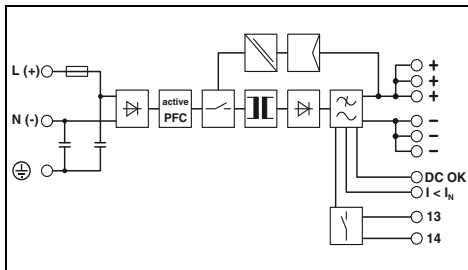

Technical data

Technical data

Technical data

100 V AC ... 240 V AC
110 V DC ... 250 V DC
85 V AC ... 264 V AC
90 V DC ... 410 V DC +5%

45 Hz ... 65 Hz / 0 Hz
2.2 A (120 V AC) / 1.3 A (230 V AC)
< 15 A / < 1.5 A²s
typ. 36 ms (120 V AC) / typ. 36 ms (230 V AC)

24 V DC ±1%
18 V DC ... 29.5 V DC (> 24 V DC, constant capacity restricted)

10 A / 15 A / 60 A
B2 / B4 / B6 / C2 / C4
Yes / yes
9.1 W / 22 W
> 92.5% (for 230 V AC and nominal values)
< 50 mV_{PP}

LED, active switching output, relay contact
LED, active switching output

1.1 kg / 60 x 130 x 125 mm
alignable: 5 mm horizontally, 15 mm next to active components, 50 mm vertically
Plug-in screw connection
0.2 - 2.5 mm² / 0.2 - 2.5 mm² / 16 - 12
0.2 - 2.5 mm² / 0.2 - 2.5 mm² / 16 - 12
0.2 - 2.5 mm² / 0.2 - 2.5 mm² / 16 - 12
IP20 / I
> 530000 h (40°C)
-40°C ... 70°C (> 60°C Derating: 2.5%/K)

2 kV AC (routine test) / 4 kV AC (type test)
Conformance with EMC Directive 2014/30/EU
IEC 60950-1/VDE 0805 (SELV)
EN 50178/VDE 0160 (PELV)
DIN VDE 0100-410
EN 50121-4 / EN 50155
UL/C-UL Listed UL 508, UL/C-UL Recognized UL 60950-1,
UL ANSI/ISA-12.12.01 Class I, Division 2, Groups A, B, C, D
(Hazardous Location)
EN 61000-3-2

100 V AC ... 240 V AC
110 V DC ... 250 V DC
85 V AC ... 264 V AC
90 V DC ... 410 V DC +5%

45 Hz ... 65 Hz / 0 Hz
5.1 A (120 V AC) / 2.3 A (230 V AC)
< 20 A / < 3.2 A²s
typ. 32 ms (120 V AC) / typ. 32 ms (230 V AC)

24 V DC ±1%
18 V DC ... 29.5 V DC (> 24 V DC, constant capacity restricted)

20 A / 26 A / 120 A
B2 / B4 / B6 / B10 / B16 / C2 / C4 / C6
Yes / yes
8 W / 40 W
> 93% (for 230 V AC and nominal values)
< 30 mV_{PP}

LED, active switching output, relay contact
LED, active switching output

1.7 kg / 90 x 130 x 125 mm
alignable: 5 mm horizontally, 15 mm next to active components, 50 mm vertically
Screw connection
0.2 - 6 mm² / 0.2 - 4 mm² / 18 - 10
0.2 - 6 mm² / 0.2 - 4 mm² / 12 - 10
0.2 - 6 mm² / 0.2 - 4 mm² / 18 - 10
IP20 / I
> 520000 h (40°C)
-40°C ... 70°C (> 60°C Derating: 2.5%/K)

2 kV AC (routine test) / 4 kV AC (type test)
Conformance with EMC Directive 2014/30/EU
IEC 60950-1/VDE 0805 (SELV)
EN 50178/VDE 0160 (PELV)
DIN VDE 0100-410
EN 50121-4 / EN 50155
UL/C-UL Listed UL 508, UL/C-UL Recognized UL 60950-1,
UL ANSI/ISA-12.12.01 Class I, Division 2, Groups A, B, C, D
(Hazardous Location)
EN 61000-3-2

3x 400 V AC ... 500 V AC

3x 320 V AC ... 575 V AC
2x 360 V AC ... 575 V AC
450 V DC ... 800 V DC
45 Hz ... 65 Hz / 0 Hz
3x 1.6 A (400 V AC) / 3x 1.3 A (500 V AC)
< 20 A / < 3.2 A²s
typ. 28 ms (400 V AC) / typ. 43 ms (500 V AC)

24 V DC ±1%
18 V DC ... 29.5 V DC (> 24 V DC, constant capacity restricted)

20 A / 26 A / 120 A
B2 / B4 / B6 / B10 / B16 / C2 / C4 / C6
Yes / yes
11 W / 40 W
> 93% (at 400 V AC and nominal values)
< 40 mV_{PP}

LED, active switching output, relay contact
LED, active switching output

1.5 kg / 69 x 130 x 125 mm
alignable: 5 mm horizontally, 15 mm next to active components, 50 mm vertically
Screw connection
0.2 - 6 mm² / 0.2 - 4 mm² / 18 - 10
0.2 - 6 mm² / 0.2 - 4 mm² / 12 - 10
0.2 - 6 mm² / 0.2 - 4 mm² / 18 - 10
IP20 / I
> 534000 h (40°C)
-40°C ... 70°C (> 60°C Derating: 2.5%/K)

2 kV AC (routine test) / 4 kV AC (type test)
Conformance with EMC Directive 2014/30/EU
IEC 60950-1/VDE 0805 (SELV)
EN 50178/VDE 0160 (PELV)
DIN VDE 0100-410
EN 50121-4 / EN 50155
UL/C-UL Listed UL 508, UL/C-UL Recognized UL 60950-1
(3-wire + PE, star net), UL ANSI/ISA-12.12.01 Class I, Division 2,
Groups A, B, C, D (Hazardous Location)
EN 61000-3-2

Ordering data

Ordering data

Ordering data

Type	Order No.	Pcs./Pkt.
QUINT-PS/1AC/24DC/10/CO	2320911	1

Type	Order No.	Pcs./Pkt.
QUINT-PS/1AC/24DC/20/CO	2320898	1

Type	Order No.	Pcs./Pkt.
QUINT-PS/3AC/24DC/20/CO	2320924	1

Power supplies

QUINT POWER power supplies – Maximum functionality

QUINT POWER < 100 W

with Push-in connection, 1 AC, 24 V DC

- Preventive function monitoring indicates critical operating states before errors occur
- Starting of heavy loads with dynamic boost
- High efficiency of up to 93.7% and long service life, with low power dissipation and low heat generation
- Space savings in the control cabinet, thanks to a narrow, slim-line design
- Easy tool-free wiring using Push-in connection technology

QUINT POWER, NEC Class 2

Output power limited to 100 W

- Specifically for applications that require certification in accordance with UL 1310 “Class 2 outputs”



Push-in Technology[®]
Designed by PHOENIX CONTACT



new

Power supply,
1 AC, 24 V DC, 1.3 A, PT
NEC Class 2

Ex:

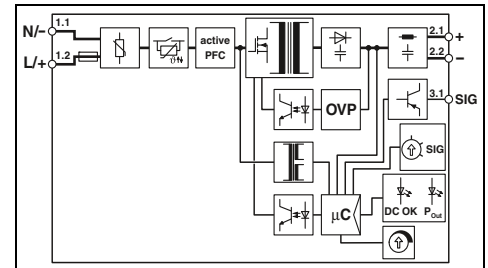

Technical data

Input data	
Input voltage range	100 V AC ... 240 V AC -15% ... +10% 110 V DC ... 250 V DC -20% ... +40%
Frequency range (f_N)	50 Hz ... 60 Hz -10% ... +10%
Current consumption (nominal load)	0.46 A (100 V AC) / 0.37 A (120 V AC) 0.2 A (230 V AC) / 0.2 A (240 V AC) 0.4 A (110 V DC) / 0.17 A (250 V DC) typ. 14 A / < 0.1 A ^{2s}
Inrush current limitation at 25°C / I _{tr}	typ. 43 ms (120 V AC) / typ. 43 ms (230 V AC)
Mains buffering (I_N)	
Output data	
Nominal output voltage (U_N)	24 V DC
Output current I_N / $I_{Stat. Boost}$ / $I_{Dyn. Boost}$ / I_{SFB}	1.3 A / 1.625 A ($\leq 40^\circ\text{C}$) / 2.6 A ($\leq 60^\circ\text{C}$ (5 s)) / -
Can be connected in parallel/series	Yes / yes
Max. power dissipation (no load/nominal load)	< 0.4 W (230 V AC) / < 3.1 W (230 V AC)
Efficiency	typ. 89.2% (120 V AC) / typ. 90.7% (230 V AC)
Residual ripple	< 40 mV _{pp}
Signaling	
LED signaling	DC OK, utilization indicator
Adjustable signal output	SIG digital
Signal options	$P_{Out} > P_{Th}$ (50%, 75%, 100%)
General data	
Weight / Dimensions W x H x D	0.188 kg / 22.5 x 106 x 90 mm
Connection	DIN rail mounting
Connection method	Push-in technology
Input connection data rigid / flexible / AWG	0.2 - 2.5 mm ² / 0.2 - 2.5 mm ² / 24 - 14
Output connection data rigid / flexible / AWG	0.2 - 2.5 mm ² / 0.2 - 2.5 mm ² / 24 - 14
Signal connection data rigid / flexible / AWG	0.2 - 2.5 mm ² / 0.2 - 2.5 mm ² / 24 - 14
Degree of protection / Protection class	IP20 / II
MTBF (IEC 61709, SN 29500)	> 1107000 h (40°C)
Ambient temperature (operation)	-25°C ... 70°C (> 60°C Derating: 2.5%/K)
Ambient temperature (startup type tested)	-40°C
Standards/regulations	
Insulation voltage input/output	3 kV AC (routine test) / 4 kV AC (type test)
Electromagnetic compatibility	Conformance with EMC Directive 2014/30/EU
Electrical safety	IEC 61010-2-201 (SELV)
Safety transformers for switched-mode power supply units	EN 61558-2-16
Overvoltage category in accordance with EN 62477-1	III (≤ 2000 m)
UL approvals	UL Listed UL 61010-1, UL Listed UL 61010-2-201, UL 1310 Class 2 Power Units, ANSI/UL 121201 Class I, Division 2, Groups A, B, C, D (Hazardous Location) EN 61000-3-2

Limitation of harmonic line currents

Technical data	
100 V AC ... 240 V AC -15% ... +10%	
110 V DC ... 250 V DC -20% ... +40%	
50 Hz ... 60 Hz -10% ... +10%	
0.46 A (100 V AC) / 0.37 A (120 V AC)	
0.2 A (230 V AC) / 0.2 A (240 V AC)	
0.4 A (110 V DC) / 0.17 A (250 V DC)	
typ. 14 A / < 0.1 A ^{2s}	
typ. 43 ms (120 V AC) / typ. 43 ms (230 V AC)	
24 V DC	
1.3 A / 1.625 A ($\leq 40^\circ\text{C}$) / 2.6 A ($\leq 60^\circ\text{C}$ (5 s)) / -	
Yes / yes	
< 0.4 W (230 V AC) / < 3.1 W (230 V AC)	
typ. 89.2% (120 V AC) / typ. 90.7% (230 V AC)	
< 40 mV _{pp}	
DC OK, utilization indicator	
SIG digital	
$P_{Out} > P_{Th}$ (50%, 75%, 100%)	
0.188 kg / 22.5 x 106 x 90 mm	
DIN rail mounting	
Push-in technology	
0.2 - 2.5 mm ² / 0.2 - 2.5 mm ² / 24 - 14	
0.2 - 2.5 mm ² / 0.2 - 2.5 mm ² / 24 - 14	
0.2 - 2.5 mm ² / 0.2 - 2.5 mm ² / 24 - 14	
IP20 / II	
> 1107000 h (40°C)	
-25°C ... 70°C (> 60°C Derating: 2.5%/K)	
-40°C	
3 kV AC (routine test) / 4 kV AC (type test)	
Conformance with EMC Directive 2014/30/EU	
IEC 61010-2-201 (SELV)	
EN 61558-2-16	
III (≤ 2000 m)	
UL Listed UL 61010-1, UL Listed UL 61010-2-201, UL 1310 Class 2 Power Units, ANSI/UL 121201 Class I, Division 2, Groups A, B, C, D (Hazardous Location) EN 61000-3-2	

Ordering data

Description	
Power supply, primary-switched	

Type	Order No.	Pcs./Pkt.
QUINT4-PS/1AC/24DC/1.3/PT	2909575	1

new

new



Push-in Technology[®]
Designed by PHOENIX CONTACT

Push-in Technology[®]
Designed by PHOENIX CONTACT



Power supply,
1 AC, 24 V DC, 2.5 A, PT
NEC Class 2

Power supply,
1 AC, 24 V DC, 3.8 A, PT
NEC Class 2

UL ENEC CB
Ex: ATEX

UL ENEC CB
Ex: ATEX

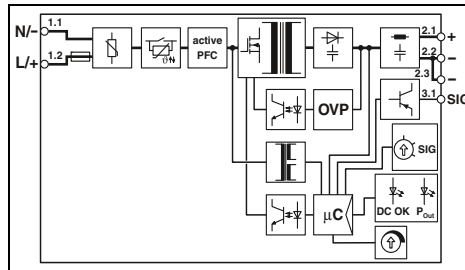
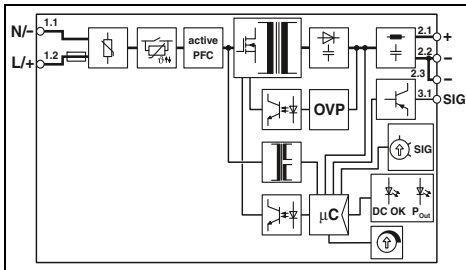

Technical data

Technical data

100 V AC ... 240 V AC -15% ... +10%
110 V DC ... 250 V DC -20% ... +40%
50 Hz ... 60 Hz -10% ... +10%
0.85 A (100 V AC) / 0.7 A (120 V AC)
0.39 A (230 V AC) / 0.37 A (240 V AC)
0.75 A (110 V DC) / 0.33 A (250 V DC)
typ. 10 A / < 0.1 A²s
typ. 54 ms (120 V AC) / typ. 54 ms (230 V AC)

100 V AC ... 240 V AC -15% ... +10%
110 V DC ... 250 V DC -20% ... +40%
50 Hz ... 60 Hz -10% ... +10%
1 A (100 V AC) / 0.83 A (120 V AC)
0.46 A (230 V AC) / 0.44 A (240 V AC)
0.91 A (110 V DC) / 0.4 A (250 V DC)
typ. 13 A / < 0.18 A²s
typ. 35 ms (120 V AC) / typ. 35 ms (230 V AC)

24 V DC
2.5 A / 3.125 A (≤ 40°C) / 5 A (≤ 60°C (5 s), Input < 150 V AC Derating 0.5%/V) / -
Yes / yes
< 1 W (230 V AC) / < 1 W (120 V AC) / < 5 W (230 V AC)
typ. 91.9% (120 V AC) / typ. 92.6% (230 V AC)
< 40 mV_{pp}

24 V DC
3.8 A / - / 7 A (≤ 60°C (5 s)) / -
Yes / yes
< 1 W (230 V AC) / < 6 W (230 V AC)
typ. 92.8% (120 V AC) / typ. 93.7% (230 V AC)
< 45 mV_{pp}

DC OK, utilization indicator
SIG digital
P_{Out} > P_{Thr} (50%, 75%, 100%)

DC OK, utilization indicator
SIG digital
P_{Out} > P_{Thr} (50%, 75%, 100%)

0.244 kg / 32 x 106 x 90 mm
DIN rail mounting
Push-in technology
0.2 - 2.5 mm² / 0.2 - 2.5 mm² / 24 - 14
0.2 - 2.5 mm² / 0.2 - 2.5 mm² / 24 - 14
0.2 - 2.5 mm² / 0.2 - 2.5 mm² / 24 - 14
IP20 / II
> 734000 h (40°C)
-25°C ... 70°C (> 60°C Derating: 2.5%/K)
-40°C

0.296 kg / 45 x 106 x 90 mm
DIN rail mounting
Push-in technology
0.2 - 2.5 mm² / 0.2 - 2.5 mm² / 24 - 14
0.2 - 2.5 mm² / 0.2 - 2.5 mm² / 24 - 14
0.2 - 2.5 mm² / 0.2 - 2.5 mm² / 24 - 14
IP20 / II
> 690000 h (40°C)
-25°C ... 70°C (> 60°C Derating: 2.5%/K)
-40°C

3 kV AC (routine test) / 4 kV AC (type test)
Conformance with EMC Directive 2014/30/EU
IEC 61010-2-201 (SELV)
EN 61558-2-16
III (≤ 2000 m)
UL Listed UL 61010-1, UL Listed UL 61010-2-201,
UL 1310 Class 2 Power Units, ANSI/UL 121201 Class I, Division 2,
Groups A, B, C, D (Hazardous Location)
EN 61000-3-2

3 kV AC (routine test) / 4 kV AC (type test)
Conformance with EMC Directive 2014/30/EU
IEC 61010-2-201 (SELV)
EN 61558-2-16
III (≤ 2000 m)
UL Listed UL 61010-1, UL Listed UL 61010-2-201,
UL 1310 Class 2 Power Units, ANSI/UL 121201 Class I, Division 2,
Groups A, B, C, D (Hazardous Location)
EN 61000-3-2

Ordering data

Ordering data

Type	Order No.	Pcs./Pkt.
QUINT4-PS/1AC/24DC/2.5/PT	2909576	1

Type	Order No.	Pcs./Pkt.
QUINT4-PS/1AC/24DC/3.8/PT	2909577	1

Power supplies

QUINT POWER power supplies – Maximum functionality

QUINT POWER < 100 W

with screw connection, 1 AC, 24 V DC

- Preventive function monitoring indicates critical operating states before errors occur
- Starting of heavy loads with dynamic boost
- High efficiency of up to 93.7% and long service life, with low power dissipation and low heat generation
- Space savings in the control cabinet, thanks to a narrow, slim-line design

QUINT POWER, NEC Class 2

Output power limited to 100 W

- Specifically for applications that require certification in accordance with UL 1310 “Class 2 outputs”



new

Power supply,
1 AC, 24 V DC, 1.3 A, SC
NEC Class 2

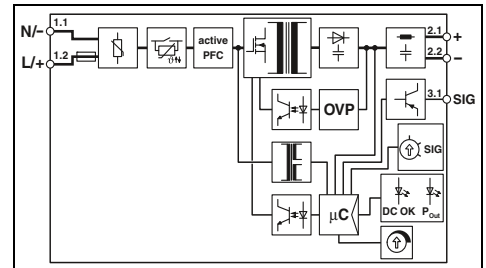

Technical data

Input data	
Input voltage range	100 V AC ... 240 V AC -15% ... +10% 110 V DC ... 250 V DC -20% ... +40%
Frequency range (f_N)	50 Hz ... 60 Hz -10% ... +10%
Current consumption (nominal load)	0.46 A (100 V AC) / 0.37 A (120 V AC) 0.2 A (230 V AC) / 0.2 A (240 V AC) 0.4 A (110 V DC) / 0.17 A (250 V DC) typ. 14 A / < 0.1 A ^{2s}
Inrush current limitation at 25°C / I _t	typ. 43 ms (120 V AC) / typ. 43 ms (230 V AC)
Mains buffering (I _N)	
Output data	
Nominal output voltage (U _N)	24 V DC
Output current I _N / I _{Stat. Boost} / I _{Dyn. Boost} / I _{SFB}	1.3 A / 1.625 A (≤ 40°C) / 2.6 A (≤ 60°C (5 s)) / -
Can be connected in parallel/series	Yes / yes
Max. power dissipation (no load/nominal load)	< 0.4 W (230 V AC) / < 3.1 W (230 V AC)
Efficiency	typ. 89.2% (120 V AC) / typ. 90.7% (230 V AC)
Residual ripple	< 40 mV _{pp}
Signaling	
LED signaling	DC OK, utilization indicator
Adjustable signal output	SIG digital
Signal options	P _{Out} > P _{Th} (50%, 75%, 100%)
General data	
Weight / Dimensions W x H x D	0.188 kg / 22.5 x 99 x 90 mm
Connection	DIN rail mounting
Connection method	Screw connection
Input connection data rigid / flexible / AWG	0.14 - 2.5 mm ² / 0.14 - 2.5 mm ² / 26 - 14
Output connection data rigid / flexible / AWG	0.14 - 2.5 mm ² / 0.14 - 2.5 mm ² / 26 - 14
Signal connection data rigid / flexible / AWG	0.14 - 2.5 mm ² / 0.14 - 2.5 mm ² / 26 - 14
Degree of protection / Protection class	IP20 / II
MTBF (IEC 61709, SN 29500)	> 1107000 h (40°C)
Ambient temperature (operation)	-25°C ... 70°C (> 60°C Derating: 2.5%/K)
Ambient temperature (startup type tested)	-40°C
Standards/regulations	
Insulation voltage input/output	3 kV AC (routine test) / 4 kV AC (type test)
Electromagnetic compatibility	Conformance with EMC Directive 2014/30/EU
Electrical safety	IEC 61010-2-201 (SELV)
Safety transformers for switched-mode power supply units	EN 61558-2-16
Overvoltage category in accordance with EN 62477-1	III (≤ 2000 m)
UL approvals	UL Listed UL 61010-1, UL Listed UL 61010-2-201, UL 1310 Class 2 Power Units, ANSI/UL 121201 Class 1, Division 2, Groups A, B, C, D (Hazardous Location) EN 61000-3-2
Limitation of harmonic line currents	
Description	
Power supply, primary-switched	

Ordering data

Type	Order No.	Pcs./Pkt.
QUINT4-PS/1AC/24DC/1.3/SC	2904597	1



new



Power supply,
1 AC, 24 V DC, 2.5 A, SC
NEC Class 2



Ex:



new



Power supply,
1 AC, 24 V DC, 3.8 A, SC
NEC Class 2



Ex:

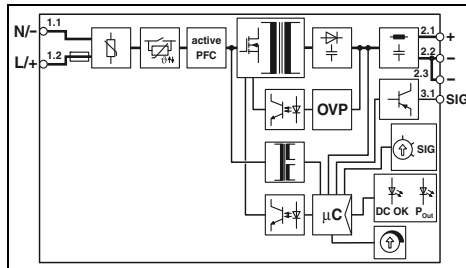
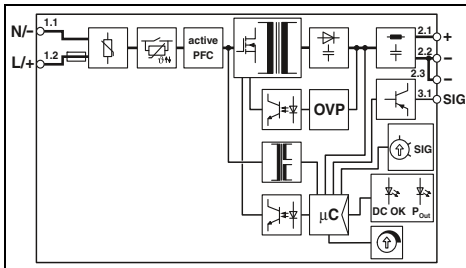

Technical data

100 V AC ... 240 V AC -15% ... +10%
110 V DC ... 250 V DC -20% ... +40%
50 Hz ... 60 Hz -10% ... +10%
0.85 A (100 V AC) / 0.7 A (120 V AC)
0.39 A (230 V AC) / 0.37 A (240 V AC)
0.75 A (110 V DC) / 0.33 A (250 V DC)
typ. 10 A / < 0.1 A²s
typ. 54 ms (120 V AC) / typ. 54 ms (230 V AC)

24 V DC
2.5 A / 3.125 A (≤ 40°C) / 5 A (≤ 60°C (5 s), Input < 150 V AC Derating 0.5%/V) / -
Yes / yes
< 1 W (230 V AC) / < 5 W (230 V AC)
typ. 91.9% (120 V AC) / typ. 92.6% (230 V AC)
< 40 mV_{PP}

DC OK, utilization indicator
SIG digital
P_{Out} > P_{Thr} (50%, 75%, 100%)

0.244 kg / 32 x 99 x 90 mm
DIN rail mounting
Screw connection
0.14 - 2.5 mm² / 0.14 - 2.5 mm² / 26 - 14
0.14 - 2.5 mm² / 0.14 - 2.5 mm² / 26 - 14
0.14 - 2.5 mm² / 0.14 - 2.5 mm² / 26 - 14
IP20 / II
> 734000 h (40°C)
-25°C ... 70°C (> 60°C Derating: 2.5%/K)
-40°C

3 kV AC (routine test) / 4 kV AC (type test)
Conformance with EMC Directive 2014/30/EU
IEC 61010-2-201 (SELV)
EN 61558-2-16

III (≤ 2000 m)
UL Listed UL 61010-1, UL Listed UL 61010-2-201,
UL 1310 Class 2 Power Units, ANSI/UL 121201 Class I, Division 2,
Groups A, B, C, D (Hazardous Location)
EN 61000-3-2

Ordering data

Type	Order No.	Pcs./Pkt.
QUINT4-PS/1AC/24DC/2.5/SC	2904598	1

Technical data

100 V AC ... 240 V AC -15% ... +10%
110 V DC ... 250 V DC -20% ... +40%
50 Hz ... 60 Hz -10% ... +10%
1 A (100 V AC) / 0.83 A (120 V AC)
0.46 A (230 V AC) / 0.44 A (240 V AC)
0.91 A (110 V DC) / 0.4 A (250 V DC)
typ. 13 A / < 0.18 A²s
typ. 35 ms (120 V AC) / typ. 35 ms (230 V AC)

24 V DC
3.8 A / - / 7 A (≤ 60°C (5 s)) / -
Yes / yes
< 1 W (230 V AC) / < 6 W (230 V AC)
typ. 92.8% (120 V AC) / typ. 93.7% (230 V AC)
< 45 mV_{PP}

DC OK, utilization indicator
SIG digital
P_{Out} > P_{Thr} (50%, 75%, 100%)

0.296 kg / 45 x 99 x 90 mm
DIN rail mounting
Screw connection
0.14 - 2.5 mm² / 0.14 - 2.5 mm² / 26 - 14
0.14 - 2.5 mm² / 0.14 - 2.5 mm² / 26 - 14
0.14 - 2.5 mm² / 0.14 - 2.5 mm² / 26 - 14
IP20 / II
> 690000 h (40°C)
-25°C ... 70°C (> 60°C Derating: 2.5%/K)
-40°C

3 kV AC (routine test) / 4 kV AC (type test)
Conformance with EMC Directive 2014/30/EU
IEC 61010-2-201 (SELV)
EN 61558-2-16

III (≤ 2000 m)
UL Listed UL 61010-1, UL Listed UL 61010-2-201,
UL 1310 Class 2 Power Units, ANSI/UL 121201 Class I, Division 2,
Groups A, B, C, D (Hazardous Location)
EN 61000-3-2

Ordering data

Type	Order No.	Pcs./Pkt.
QUINT4-PS/1AC/24DC/3.8/SC	2904599	1

Power supplies

QUINT POWER power supplies – Maximum functionality

QUINT POWER < 100 W

with Push-in connection, 1 AC, 12 and 5 V DC

- Preventive function monitoring indicates critical operating states before errors occur
- Starting of heavy loads with dynamic boost
- High efficiency of up to 93.7% and long service life, with low power dissipation and low heat generation
- Space savings in the control cabinet, thanks to a narrow, slim-line design
- Easy tool-free wiring using Push-in connection technology

QUINT POWER, NEC Class 2

Output power limited to 100 W

- Specifically for applications that require certification in accordance with UL 1310 “Class 2 outputs”



Push-in Technology[®]
Designed by PHOENIX CONTACT



new

Power supply,
1 AC, 12 V DC, 2.5 A, PT
NEC Class 2

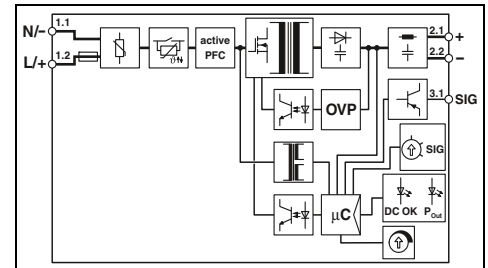

Technical data

Input data	
Input voltage range	100 V AC ... 240 V AC -15% ... +10% 110 V DC ... 250 V DC -20% ... +40%
Frequency range (f_N)	50 Hz ... 60 Hz -10% ... +10%
Current consumption (nominal load)	0.44 A (100 V AC) / 0.35 A (120 V AC) 0.19 A (230 V AC) / 0.2 A (240 V AC) 0.4 A (110 V DC) / 0.17 A (250 V DC) typ. 11.3 A / < 0.1 A ² s
Inrush current limitation at 25°C / I _t	typ. 54 ms (120 V AC) / typ. 54 ms (230 V AC)
Mains buffering (I _N)	
Output data	
Nominal output voltage (U _N)	12 V
Output current I _N / I _{Stat. Boost} / I _{Dyn. Boost} / I _{SFB}	2.5 A / 3.125 A (≤ 40°C) / 4.5 A (≤ 60°C (5 s)) / -
Can be connected in parallel/series	Yes / yes
Max. power dissipation (no load/nominal load)	< 0.5 W (230 V AC) / < 3 W (230 V AC)
Efficiency	typ. 89.5% (120 V AC) / typ. 90.9% (230 V AC)
Residual ripple	< 30 mV _{pp}
Signaling	
LED signaling	DC OK, utilization indicator
Adjustable signal output	SIG digital
Signal options	P _{Out} > P _{Th} (50%, 75%, 100%)
General data	
Weight / Dimensions W x H x D	0.181 kg / 22.5 x 106 x 90 mm
Connection	alignable: 5 mm horizontally, 15 mm next to active components, 30 mm vertically
Connection method	Push-in technology
Input connection data rigid / flexible / AWG	0.2 - 2.5 mm ² / 0.2 - 2.5 mm ² / 24 - 14
Output connection data rigid / flexible / AWG	0.2 - 2.5 mm ² / 0.2 - 2.5 mm ² / 24 - 14
Signal connection data rigid / flexible / AWG	0.2 - 2.5 mm ² / 0.2 - 2.5 mm ² / 24 - 14
Degree of protection / Protection class	IP20 / II
MTBF (IEC 61709, SN 29500)	> 1060000 h (40°C)
Ambient temperature (operation)	-25°C ... 70°C (> 60°C Derating: 2.5%/K)
Ambient temperature (startup type tested)	-
Standards/regulations	
Insulation voltage input/output	3 kV AC (routine test) / 4 kV AC (type test)
Electromagnetic compatibility	Conformance with EMC Directive 2014/30/EU
Electrical safety	IEC 61010-2-201 (SELV)
Safety transformers for switched-mode power supply units	EN 61558-2-16
Oversoltage category in accordance with EN 62477-1	III (≤ 2000 m)
UL approvals	UL Listed UL 61010-1, UL Listed UL 61010-2-201, UL 1310 Class 2 Power Units, ANSI/UL 121201 Class 1, Division 2, Groups A, B, C, D (Hazardous Location)
Limitation of harmonic line currents	EN 61000-3-2

Ordering data

Description	Type	Order No.	Pcs./Pkt.
Power supply, primary-switched	QUINT4-PS/1AC/12DC/2.5/PT	2904605	1

new

new



Push-in Technology[®]
Designed by PHOENIX CONTACT

Push-in Technology[®]
Designed by PHOENIX CONTACT



Power supply,
1 AC, 12 V DC, 7.5 A, PT

Power supply,
1 AC, 5 V DC, 5 A, PT
NEC Class 2

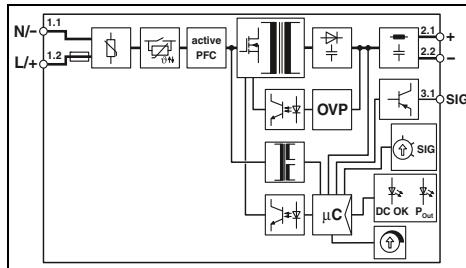
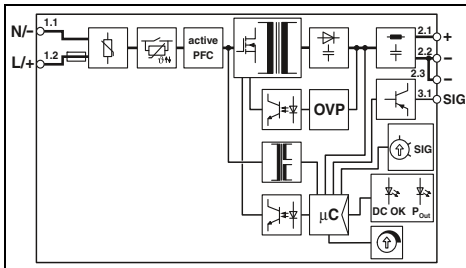

Technical data

Technical data

100 V AC ... 240 V AC -15% ... +10%
110 V DC ... 250 V DC -20% ... +40%
50 Hz ... 60 Hz -10% ... +10%
1 A (100 V AC) / 0.85 A (120 V AC)
0.46 A (230 V AC) / 0.44 A (240 V AC)
0.92 A (110 V DC) / 0.4 A (250 V DC)
typ. 11.4 A / < 0.2 A²s
typ. 48 ms (120 V AC) / typ. 48 ms (230 V AC)

100 V AC ... 240 V AC -15% ... +10%
110 V DC ... 250 V DC -20% ... +40%
-
0.38 A (100 V AC) / 0.32 A (120 V AC)
0.16 A (230 V AC) / 0.17 A (240 V AC)
0.35 A (110 V DC) / 0.15 A (250 V DC)
typ. 11.5 A / < 0.2 A²s
typ. 43 ms

12 V
7.5 A / - / 12.75 A (≤ 60°C (5 s)) / -
Yes / yes
< 0.6 W (230 V AC) / < 7.1 W (230 V AC)
typ. 91.5% (120 V AC) / typ. 92.5% (230 V AC)
< 35 mV_{pp}

5 V
5 A / 6.25 A / 10 A (≤ 60°C (5 s)) / -
Yes / yes
< 0.5 W (230 V AC) / < 2.7 W (230 V AC)
typ. 89.5% (120 V AC) / typ. 90.8% (230 V AC)
< 40 mV_{pp}

DC OK, utilization indicator
SIG digital
P_{Out} > P_{Thr} (50%, 75%, 100%)

DC OK, utilization indicator
SIG digital
P_{Out} > P_{Thr} (50%, 75%, 100%)

0.3 kg / 45 x 106 x 90 mm
alignable: 5 mm horizontally, 15 mm next to active components,
30 mm vertically
Push-in technology
0.2 - 2.5 mm² / 0.2 - 2.5 mm² / 24 - 14
0.2 - 2.5 mm² / 0.2 - 2.5 mm² / 24 - 14
0.2 - 2.5 mm² / 0.2 - 2.5 mm² / 24 - 14
IP20 / II
> 671000 h (40°C)
-25°C ... 70°C (> 60°C Derating: 2.5%/K)
-40°C

- / 22.5 x 106 x 90 mm
alignable: 5 mm horizontally, 15 mm next to active components,
30 mm vertically
Push-in technology
0.2 - 2.5 mm² / 0.2 - 2.5 mm² / 24 - 14
0.2 - 2.5 mm² / 0.2 - 2.5 mm² / 24 - 14
0.2 - 2.5 mm² / 0.2 - 2.5 mm² / 24 - 14
IP20 / -
> 500000 h (40°C)
-25°C ... 70°C (> 60°C Derating: 2.5%/K)
-

3 kV AC (routine test) / 4 kV AC (type test)
Conformance with EMC Directive 2014/30/EU
IEC 61010-2-201 (SELV)
EN 61558-2-16

3 kV AC (routine test) / 4 kV AC (type test)
Conformance with EMC Directive 2014/30/EU
IEC 61010-2-201 (SELV)
EN 61558-2-16

III (≤ 2000 m)
UL Listed UL 61010-1, UL Listed UL 61010-2-201,
UL 1310 Class 2 Power Units, ANSI/UL 121201 Class I, Division 2,
Groups A, B, C, D (Hazardous Location)
EN 61000-3-2

III
UL Listed UL 61010-1, UL Listed UL 61010-2-201,
UL 1310 Class 2 Power Units, ANSI/UL 121201 Class I, Division 2,
Groups A, B, C, D (Hazardous Location)
EN 61000-3-2

Ordering data

Ordering data

Type	Order No.	Pcs./Pkt.
QUINT4-PS/1AC/12DC/7.5/PT	2904607	1

Type	Order No.	Pcs./Pkt.
QUINT4-PS/1AC/5DC/5/PT	2904595	1

Power supplies and UPS

Power supplies

TRIO POWER power supplies – Robust standard functionality

TRIO POWER 1 AC, 24 V DC

- Space savings in the control cabinet, thanks to the narrow design
- Reliable starting of dynamic loads with the dynamic boost, which supplies up to 1.5 times the nominal current for 5 seconds
- High operational reliability, thanks to the robust design
- Wide temperature range from -25°C to +70°C as well as device startup at -40°C (type-tested)
- Maximum availability, thanks to high MTBF (mean time between failure)
- Active function monitoring with DC OK LED and relay contact
- Time savings during installation, thanks to the use of tool-free Push-in connection technology

TRIO POWER, NEC Class 2

Output power limited to 100 W

- Specifically for applications that require certification in accordance with UL 1310/508 Listed Class 2

TRIO POWER, Bridge and Deck

Optimized for use on the ship's bridge



Power supply,
1 AC, 24 V DC, 3 A
NEC Class 2

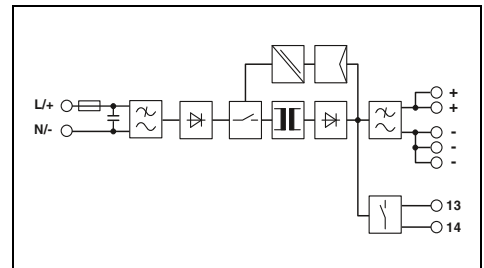

Input data	Nominal input voltage range
Input voltage range	Frequency range
Current consumption (nominal load)	Inrush current limitation at 25°C / I _{It}
Mains buffering (I _b)	Output data
Nominal output voltage	Setting range of the output voltage (U _{Set})
Output current / Dynamic Boost	Can be connected in parallel/series
Max. power dissipation (no load/nominal load)	Efficiency
Residual ripple	Signaling
Signaling DC OK	General data
Weight / Dimensions W x H x D	Connection
Connection method	Input connection data rigid / flexible / AWG
Output connection data rigid / flexible / AWG	Degree of protection / Protection class
MTBF (IEC 61709, SN 29500)	Ambient temperature (operation)
Standards/regulations	Insulation voltage input/output
Electromagnetic compatibility	Electrical safety
Electronic equipm. for electrical power installations	Safe isolation
UL approvals	Limitation of harmonic line currents

Technical data	
100 V AC ... 240 V AC	110 V DC ... 250 V DC
100 V AC ... 240 V AC -15% ... +10%	99 V DC ... 275 V DC
50 Hz ... 60 Hz ±10%	1.4 A (100 V AC) / 1 A (120 V AC)
0.6 A (230 V AC) / 0.7 A (240 V AC)	0.8 A (110 V DC) / 0.3 A (250 V DC)
≤ 15 A / < 0.26 A ² s	typ. 10 ms (120 V AC) / typ. 20 ms (230 V AC)
24 V DC ±1%	24 V DC ... 28 V DC (> 24 V DC, constant capacity restricted)
3 A / 4.5 A (1 s)	yes, with redundancy module / yes
< 1 W / < 10 W	> 89% (for 230 V AC and nominal values)
< 50 mV _{PP}	LED, floating signal contact
0.35 kg / 30 x 130 x 115 mm	alignable: horizontally 0 mm (≤ 40°C) 10 mm (≤ 70°C), vertically 50 mm
Push-in connection	0.2 - 4 mm ² / 0.2 - 2.5 mm ² / 24 - 12
IP20 / II	> 2000000 h (40°C)
-25°C ... 70°C (> 60°C Derating: 2.5%/K)	1.5 kV AC (routine test) / 3 kV AC (type test)
Conformance with EMC Directive 2014/30/EU	IEC 60950-1/VDE 0805 (SELV)
EN 50178/VDE 0160 (PELV)	DIN VDE 0100-410
UL Listed UL 508, UL/C-UL Recognized UL 60950-1, NEC Class 2 as per UL 1310	EN 61000-3-2

Description
Power supply, primary-switched

Ordering data		
Type	Order No.	Pcs./Pkt.
TRIO-PS-2G/1AC/24DC/3/C2LPS	2903147	1



Power supply,
1 AC, 24 V DC, 5 A



Power supply, Bridge and Deck
1 AC, 24 V DC, 5 A

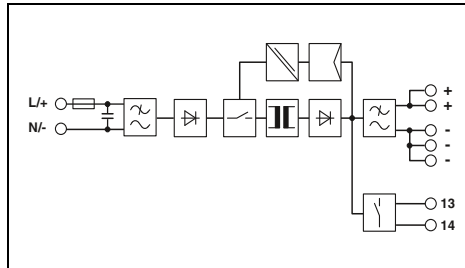
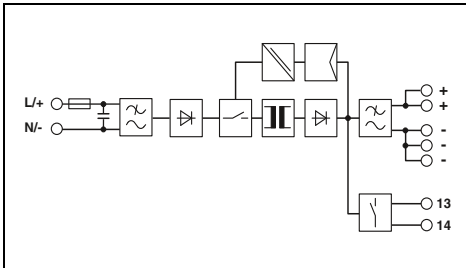

Technical data

100 V AC ... 240 V AC
110 V DC ... 250 V DC
100 V AC ... 240 V AC -15% ... +10%
99 V DC ... 275 V DC
50 Hz ... 60 Hz ±10%
2.2 A (100 V AC) / 1.9 A (120 V AC)
1.1 A (230 V AC) / 1.1 A (240 V AC)
1.4 A (110 V DC) / 0.6 A (250 V DC)
≤ 16 A / < 0.6 A²s
typ. 20 ms (120 V AC) / typ. 100 ms (230 V AC)

24 V DC ±1%
24 V DC ... 28 V DC (> 24 V DC, constant capacity restricted)

5 A / 7.5 A (5 s)
yes, with redundancy module / yes
< 1 W / < 16 W
> 90% (for 230 V AC and nominal values)
< 50 mV_{pp}

LED, floating signal contact

0.45 kg / 35 x 130 x 115 mm
alignable: horizontally 0 mm (≤ 40°C) 10 mm (≤ 70°C),
vertically 50 mm
Push-in connection
0.2 - 4 mm² / 0.2 - 2.5 mm² / 24 - 12
0.2 - 4 mm² / 0.2 - 2.5 mm² / 24 - 12
IP20 / II
> 1970000 h (40°C)
-25°C ... 70°C (> 60°C Derating: 2.5%/K)

1.5 kV AC (routine test) / 3 kV AC (type test)
Conformance with EMC Directive 2014/30/EU
IEC 60950-1/VDE 0805 (SELV)
EN 50178/VDE 0160 (PELV)
DIN VDE 0100-410
UL Listed UL 508, UL/C-UL Recognized UL 60950-1

EN 61000-3-2

Ordering data

Type	Order No.	Pcs./Pkt.
TRIO-PS-2G/1AC/24DC/5	2903148	1

Technical data

100 V AC ... 240 V AC
110 V DC ... 250 V DC
100 V AC ... 240 V AC -15% ... +10%
99 V DC ... 275 V DC
50 Hz ... 60 Hz ±5 Hz
2.2 A (100 V AC) / 1.9 A (120 V AC)
1.1 A (230 V AC) / 1.1 A (240 V AC)
1.4 A (110 V DC) / 0.6 A (250 V DC)
≤ 16 A / < 0.6 A²s
typ. 20 ms (120 V AC) / typ. 100 ms (230 V AC)

24 V DC ±1%
24 V DC ... 28 V DC (> 24 V DC, constant capacity restricted)

5 A / 7.5 A (5 s)
yes, with redundancy module / yes
< 1 W / < 16 W
> 89% (for 230 V AC and nominal values)
< 50 mV_{pp}

LED, floating signal contact

0.45 kg / 35 x 130 x 115 mm
alignable: horizontally 0 mm (≤ 40°C) 10 mm (≤ 70°C),
vertically 50 mm
Push-in connection
0.2 - 4 mm² / 0.2 - 2.5 mm² / 24 - 12
0.2 - 4 mm² / 0.2 - 2.5 mm² / 24 - 12
IP20 / II
> 1970000 h (40°C)
-25°C ... 70°C (> 60°C Derating: 2.5%/K)

1.5 kV AC (routine test) / 3 kV AC (type test)
Conformance with EMC Directive 2014/30/EU
IEC 60950-1/VDE 0805 (SELV)
EN 50178/VDE 0160 (PELV)
DIN VDE 0100-410
UL Listed UL 508, UL/C-UL Recognized UL 60950-1

EN 61000-3-2

Ordering data

Type	Order No.	Pcs./Pkt.
TRIO-PS-2G/1AC/24DC/5/B+D	2903144	1

Power supplies and UPS

Power supplies

TRIO POWER power supplies – Robust standard functionality

TRIO POWER 1 AC, 24 V DC

- Space savings in the control cabinet, thanks to the narrow design
- Reliable starting of dynamic loads with the dynamic boost, which supplies up to 1.5 times the nominal current for 5 seconds
- High operational reliability, thanks to the robust design
- Wide temperature range from -25°C to +70°C as well as device startup at -40°C (type-tested)
- Maximum availability, thanks to high MTBF (mean time between failure)
- Active function monitoring with DC OK LED and relay contact
- Time savings during installation, thanks to the use of tool-free Push-in connection technology

TRIO POWER, NEC Class 2

Output power limited to 100 W

- Specifically for applications that require certification in accordance with UL 1310/508 Listed Class 2

TRIO POWER, Bridge and Deck

Optimized for use on the ship's bridge



Power supply,
1 AC, 24 V DC, 10 A



Ex:

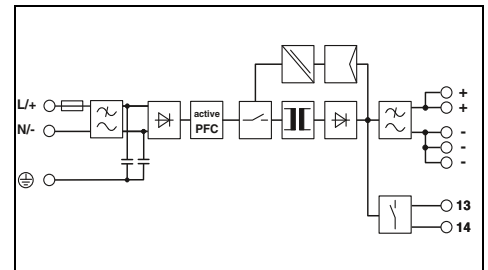

Input data	
Nominal input voltage range	
Input voltage range	
Frequency range	
Current consumption (nominal load)	
Inrush current limitation at 25°C / I _{rt}	
Mains buffering (I _b)	
Output data	
Nominal output voltage	
Setting range of the output voltage (U _{set})	
Output current / Dynamic Boost	
Can be connected in parallel/series	
Max. power dissipation (no load/nominal load)	
Efficiency	
Residual ripple	
Signaling	
Signaling DC OK	
General data	
Weight / Dimensions W x H x D	
Connection	
Connection method	
Input connection data rigid / flexible / AWG	
Output connection data rigid / flexible / AWG	
Degree of protection / Protection class	
MTBF (IEC 61709, SN 29500)	
Ambient temperature (operation)	
Standards/regulations	
Insulation voltage input/output	
Electromagnetic compatibility	
Electrical safety	
Electronic equipm. for electrical power installations	
Safe isolation	
UL approvals	
Limitation of harmonic line currents	

Technical data	
100 V AC ... 240 V AC	110 V DC ... 250 V DC
100 V AC ... 240 V AC -15% ... +10%	110 V DC ... 250 V DC -10% ... +10%
50 Hz ... 60 Hz ±10%	3.1 A (100 V AC) / 2.4 A (120 V AC)
≤ 25 A / < 0.5 A ² s	typ. 15 ms (120 V AC) / typ. 20 ms (230 V AC)
24 V DC ±1%	24 V DC ... 28 V DC (constant capacity)
10 A / 15 A (5 s)	yes, with redundancy module / yes
< 5.1 W (230 V) / < 25 W	> 91% (for 230 V AC and nominal values)
< 10 mV _{pp}	LED, floating signal contact
1 kg / 42 x 130 x 160 mm	alignable: horizontally 0 mm (≤ 40°C) 10 mm (≤ 70°C), vertically 50 mm
Push-in connection	0.2 - 4 mm ² / 0.2 - 2.5 mm ² / 24 - 12
0.2 - 4 mm ² / 0.2 - 2.5 mm ² / 24 - 12	IP20 / I
> 1000000 h (40°C)	-25°C ... 70°C (> 60°C Derating: 2.5%/K)
1.5 kV AC (routine test) / 3 kV AC (type test)	Conformance with EMC Directive 2014/30/EU
IEC 60950-1/VDE 0805 (SELV)	EN 50178/VDE 0160 (PELV)
EN 50178/VDE 0160 (PELV)	DIN VDE 0100-410
DIN VDE 0100-410	UL Listed UL 508, UL/C-UL Recognized UL 60950-1
UL Listed UL 508, UL/C-UL Recognized UL 60950-1	EN 61000-3-2

Description
Power supply, primary-switched

Ordering data		
Type	Order No.	Pcs./Pkt.
TRIO-PS-2G/1AC/24DC/10	2903149	1



Power supply, Bridge and Deck
1 AC, 24 V DC, 10 A



Power supply,
1 AC, 24 V DC, 20 A

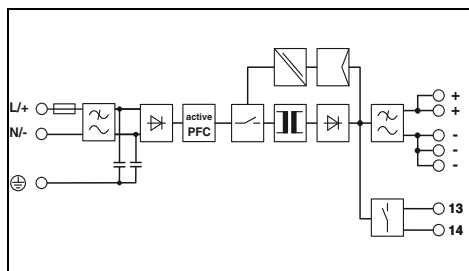
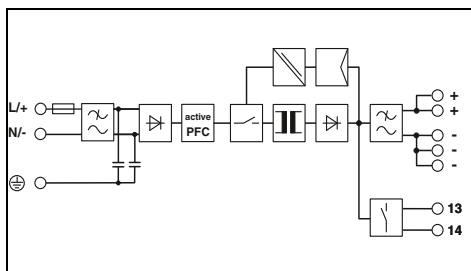

Technical data

100 V AC ... 240 V AC
110 V DC ... 250 V DC
100 V AC ... 240 V AC -15% ... +10%
110 V DC ... 250 V DC -10% ... +10%
50 Hz ... 60 Hz ±5 Hz
3.1 A (100 V AC) / 2.4 A (120 V AC)
typ. 20 A / < 0.5 A²s
typ. 20 ms (120 V AC) / typ. 20 ms (230 V AC)

24 V DC ±1%
24 V DC ... 28 V DC (constant capacity)

10 A / 15 A (5 s)
yes, with redundancy module / yes
< 5.1 W / < 25 W
typ. 90% (120 V AC) / typ. 91.5% (230 V AC)
< 20 mV_{pp}

LED, floating signal contact

1 kg / 42 x 130 x 160 mm
alignable: horizontally 0 mm (≤ 40°C) 10 mm (≤ 70°C),
vertically 50 mm
Push-in connection
0.2 - 4 mm² / 0.2 - 2.5 mm² / 24 - 12
0.2 - 4 mm² / 0.2 - 2.5 mm² / 24 - 12
IP20 / I
> 1000000 h (40°C)
-25°C ... 70°C (> 60°C Derating: 2.5%/K)

1.5 kV AC (routine test) / 3 kV AC (type test)
Conformance with EMC Directive 2014/30/EU
IEC 60950-1/VDE 0805 (SELV)
EN 50178/VDE 0160 (PELV)
DIN VDE 0100-410
UL Listed UL 508, UL/C-UL Recognized UL 60950-1
EN 61000-3-2

Ordering data

Type	Order No.	Pcs./Pkt.
TRIO-PS-2G/1AC/24DC/10/B+D	2903145	1

Technical data

100 V AC ... 240 V AC
110 V DC ... 250 V DC
100 V AC ... 240 V AC -15% ... +10%
99 V DC ... 275 V DC
50 Hz ... 60 Hz ±10%
5.6 A (100 V AC) / 4.3 A (120 V AC)
≤ 20 A / < 0.9 A²s
typ. 10 ms (120 V AC) / typ. 15 ms (230 V AC)

24 V DC ±1%
24 V DC ... 28 V DC (> 24 V DC, constant capacity restricted)

20 A / 30 A (5 s)
yes, with redundancy module / yes
< 5.7 W / < 44 W
> 93% (for 230 V AC and nominal values)
< 30 mV_{pp}

LED, floating signal contact

1.5 kg / 68 x 130 x 160 mm
alignable: horizontally 0 mm (≤ 40°C) 10 mm (≤ 70°C),
vertically 50 mm
Push-in connection
0.2 - 4 mm² / 0.2 - 2.5 mm² / 24 - 12
0.2 - 10 mm² / 0.2 - 6 mm² / 24 - 8
IP20 / I
> 1000000 h (40°C)
-25°C ... 70°C (> 60°C Derating: 2.5%/K)

1.5 kV AC (routine test) / 3 kV AC (type test)
Conformance with EMC Directive 2014/30/EU
IEC 60950-1/VDE 0805 (SELV)
EN 50178/VDE 0160 (PELV)
DIN VDE 0100-410
UL Listed UL 508, UL/C-UL Recognized UL 60950-1
EN 61000-3-2

Ordering data

Type	Order No.	Pcs./Pkt.
TRIO-PS-2G/1AC/24DC/20	2903151	1

Power supplies and UPS

Power supplies

TRIO POWER power supplies – Robust standard functionality

TRIO POWER 3 AC, 24 V DC

- Space savings in the control cabinet, thanks to the narrow design
- Reliable starting of dynamic loads with the dynamic boost, which supplies up to 1.5 times the nominal current for 5 seconds
- High operational reliability, thanks to the robust design
- Wide temperature range from -25°C to +70°C as well as device startup at -40°C (type-tested)
- Maximum availability, thanks to high MTBF (mean time between failure)
- Active function monitoring with DC OK LED and relay contact
- Time savings during installation, thanks to the use of tool-free Push-in connection technology



Power supply,
3 AC, 24 V DC, 5 A

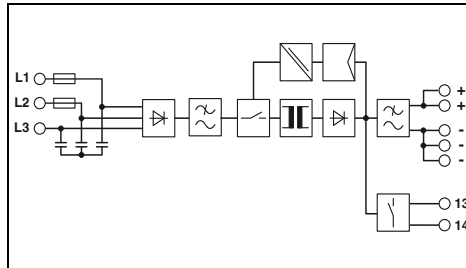

Technical data

Input data	
Nominal input voltage range	3x 400 V AC ... 500 V AC 2x 400 V AC ... 500 V AC
Input voltage range	3x 400 V AC ... 500 V AC -20% ... +15% 2x 400 V AC ... 500 V AC -10% ... +15%
Frequency range	50 Hz ... 60 Hz
Current consumption (nominal load)	3x 0.4 A (400 V AC) / 3x 0.3 A (500 V AC) 2x 0.6 A (400 V AC) / 2x 0.5 A (500 V AC)
Inrush current limitation at 25°C / I ² t	≤ 22 A / ≤ 0.25 A ² s
Mains buffering (I _N)	typ. 20 ms (400 V AC) / typ. 20 ms (500 V AC)
Output data	
Nominal output voltage	24 V DC ±1%
Setting range of the output voltage (U _{set})	24 V DC ... 28 V DC (> 24 V DC, constant capacity restricted)
Output current / Dynamic Boost	5 A / 7.5 A (5 s)
Can be connected in parallel/series	yes, with redundancy module / yes
Max. power dissipation (no load/nominal load)	< 1 W (400 V AC) / < 12 W (480 V AC)
Efficiency	> 91% (at 400 V AC and nominal values)
Residual ripple	≤ 20 mV _{pp}
Signaling	
Signaling DC OK	LED, floating signal contact
General data	
Weight / Dimensions W x H x D	0.4 kg / 35 x 130 x 115 mm
Connection	alignable: horizontally 0 mm (≤ 40°C) 10 mm (≤ 70°C), vertically 50 mm
Connection method	Push-in connection
Input connection data rigid / flexible / AWG	0.2 - 4 mm ² / 0.2 - 2.5 mm ² / 24 - 12
Output connection data rigid / flexible / AWG	0.2 - 4 mm ² / 0.2 - 2.5 mm ² / 24 - 12
Degree of protection / Protection class	IP20 / II
MTBF (IEC 61709, SN 29500)	> 1300000 h (40°C)
Ambient temperature (operation)	-25°C ... 70°C (> 60°C Derating: 2.5%/K)
Standards/regulations	
Insulation voltage input/output	1.5 kV AC (routine test) / 3 kV AC (type test)
Electromagnetic compatibility	Conformance with EMC Directive 2014/30/EU
Electrical safety	IEC 60950-1/VDE 0805 (SELV)
Electronic equipm. for electrical power installations	EN 50178/VDE 0160 (PELV)
Safe isolation	DIN VDE 0100-410
UL approvals	UL Listed UL 508, UL/C-UL Recognized UL 60950-1
Limitation of harmonic line currents	EN 61000-3-2

Ordering data

Description
Power supply, primary-switched

Type	Order No.	Pcs./Pkt.
TRIO-PS-2G/3AC/24DC/5	2903153	1



Power supply,
3 AC, 24 V DC, 10 A

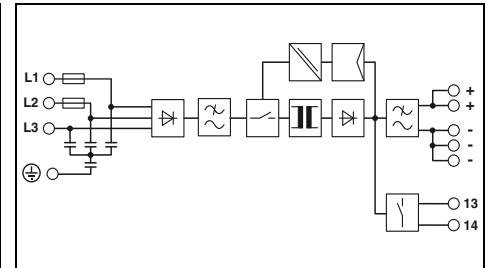

Technical data

Input data	
Nominal input voltage range	3x 400 V AC ... 500 V AC 2x 400 V AC ... 500 V AC
Input voltage range	3x 400 V AC ... 500 V AC -20% ... +15% 2x 400 V AC ... 500 V AC -10% ... +15%
Frequency range	50 Hz ... 60 Hz
Current consumption (nominal load)	3x 0.6 A (400 V AC) / 3x 0.6 A (500 V AC) 2x 1.1 A (400 V AC) / 2x 1.1 A (500 V AC)
Inrush current limitation at 25°C / I ² t	≤ 26 A / ≤ 0.3 A ² s
Mains buffering (I _N)	typ. 10 ms (400 V AC) / typ. 20 ms (500 V AC)
Output data	
Nominal output voltage	24 V DC ±1%
Setting range of the output voltage (U _{set})	24 V DC ... 28 V DC (> 24 V DC, constant capacity restricted)
Output current / Dynamic Boost	10 A / 15 A (5 s)
Can be connected in parallel/series	yes, with redundancy module / yes
Max. power dissipation (no load/nominal load)	< 1.1 W (400 V AC) / < 22 W (480 V AC)
Efficiency	> 92% (at 400 V AC and nominal values)
Residual ripple	≤ 20 mV _{pp}
Signaling	
Signaling DC OK	LED, floating signal contact
General data	
Weight / Dimensions W x H x D	0.9 kg / 42 x 130 x 160 mm
Connection	alignable: horizontally 0 mm (≤ 40°C) 10 mm (≤ 70°C), vertically 50 mm
Connection method	Push-in connection
Input connection data rigid / flexible / AWG	0.2 - 4 mm ² / 0.2 - 2.5 mm ² / 24 - 12
Output connection data rigid / flexible / AWG	0.2 - 4 mm ² / 0.2 - 2.5 mm ² / 24 - 12
Degree of protection / Protection class	IP20 / I
MTBF (IEC 61709, SN 29500)	> 1200000 h (40°C)
Ambient temperature (operation)	-25°C ... 70°C (> 60°C Derating: 2.5%/K)
Standards/regulations	
Insulation voltage input/output	1.5 kV AC (routine test) / 3 kV AC (type test)
Electromagnetic compatibility	Conformance with EMC Directive 2014/30/EU
Electrical safety	IEC 60950-1/VDE 0805 (SELV)
Electronic equipm. for electrical power installations	EN 50178/VDE 0160 (PELV)
Safe isolation	DIN VDE 0100-410
UL approvals	UL Listed UL 508, UL/C-UL Recognized UL 60950-1
Limitation of harmonic line currents	EN 61000-3-2

Ordering data

Type	Order No.	Pcs./Pkt.
TRIO-PS-2G/3AC/24DC/10	2903154	1



Power supply,
3 AC, 24 V DC, 20 A



Power supply,
3 AC, 24 V DC, 40 A

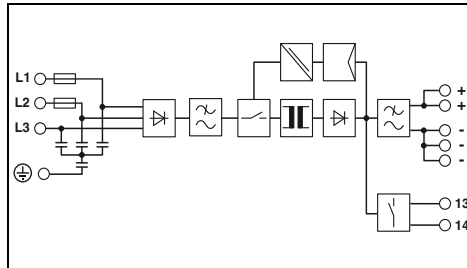
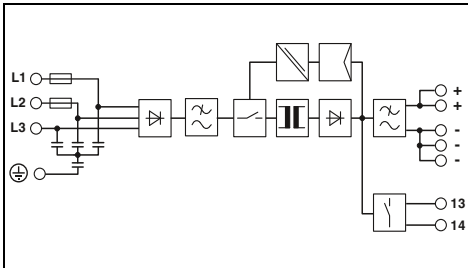

Technical data

Technical data

3x 400 V AC ... 500 V AC
 2x 400 V AC ... 500 V AC
 3x 400 V AC ... 500 V AC -20% ... +15%
 2x 400 V AC ... 500 V AC -10% ... +15%
 50 Hz ... 60 Hz
 3x 1.2 A (400 V AC) / 3x 1 A (500 V AC)
 2x 2.3 A (400 V AC) / 2x 1.9 A (500 V AC)
 $\leq 22 \text{ A} / \leq 0.5 \text{ A}^2\text{s}$
 typ. 10 ms (400 V AC) / typ. 20 ms (500 V AC)

3x 400 V AC ... 500 V AC
 3x 400 V AC ... 500 V AC -20% ... +15%
 50 Hz ... 60 Hz
 3x 1.9 A (400 V AC) / 3x 1.7 A (500 V AC)
 $\leq / \leq 1.1 \text{ A}^2\text{s}$
 typ. 10 ms (400 V AC) / typ. 20 ms (500 V AC)

24 V DC $\pm 1\%$
 24 V DC ... 28 V DC (> 24 V DC, constant capacity restricted)

24 V DC $\pm 1\%$
 24 V DC ... 28 V DC (> 24 V DC, constant capacity restricted)

20 A / 30 A (5 s)
 yes, with redundancy module / yes
 < 1.2 W (400 V AC) / < 38 W (480 V AC)
 > 93% (400 V AC) / 500 V AC
 $\leq 20 \text{ mV}_{\text{pp}}$

40 A / 60 A (5 s)
 yes, with redundancy module / yes
 < 14 W (400 V AC) / < 68 W (480 V AC)
 typ. 93% (400 V AC) / typ. 93.3% (480 V AC)
 $\leq 50 \text{ mV}_{\text{pp}}$

LED, floating signal contact

LED, floating signal contact

1.5 kg / 65 x 130 x 160 mm
 alignable: horizontally 0 mm ($\leq 40^\circ\text{C}$) 10 mm ($\leq 70^\circ\text{C}$),
 vertically 50 mm
 Push-in connection
 0.2 - 4 mm² / 0.2 - 2.5 mm² / 24 - 12
 0.2 - 10 mm² / 0.2 - 6 mm² / 24 - 8
 IP20 / I
 > 110000 h (40°C)
 -25°C ... 70°C (> 60°C Derating: 2.5%/K)

2.6 kg / 110 x 130 x 160 mm
 alignable: horizontally 0 mm ($\leq 40^\circ\text{C}$) 10 mm ($\leq 70^\circ\text{C}$),
 vertically 50 mm
 Push-in connection
 0.2 - 4 mm² / 0.2 - 2.5 mm² / 24 - 12
 0.75 - 16 mm² / 0.75 - 10 mm² / 20 - 4
 IP20 / I
 > 1051000 h (40°C)
 -25°C ... 70°C (> 60°C Derating: 2.5%/K)

1.5 kV AC (routine test) / 3 kV AC (type test)
 Conformance with EMC Directive 2014/30/EU
 IEC 60950-1/VDE 0805 (SELV)
 EN 50178/VDE 0160 (PELV)
 DIN VDE 0100-410
 UL Listed UL 508, UL/C-UL Recognized UL 60950-1
 EN 61000-3-2

1.5 kV AC (routine test) / 3 kV AC (type test)
 Conformance with EMC Directive 2014/30/EU
 IEC 60950-1/VDE 0805 (SELV)
 EN 50178/VDE 0160 (PELV)
 DIN VDE 0100-410
 UL Listed UL 508, UL/C-UL Recognized UL 60950-1
 EN 61000-3-2

Ordering data

Ordering data

Type	Order No.	Pcs./Pkt.
TRIO-PS-2G/3AC/24DC/20	2903155	1

Type	Order No.	Pcs./Pkt.
TRIO-PS-2G/3AC/24DC/40	2903156	1

Power supplies and UPS

Power supplies

TRIO POWER power supplies – Robust standard functionality

TRIO POWER 1 AC, 12 and 48 V DC

- Space savings in the control cabinet, thanks to the narrow design
- Reliable starting of dynamic loads with the dynamic boost, which supplies up to 1.5 times the nominal current for 5 seconds
- High operational reliability, thanks to the robust design
- Wide temperature range from -25°C to +70°C as well as device startup at -40°C (type-tested)
- Maximum availability, thanks to high MTBF (mean time between failure)
- Active function monitoring with DC OK LED and relay contact
- Time savings during installation, thanks to the use of tool-free Push-in connection technology

TRIO POWER, NEC Class 2

Output power limited to 100 W

- Specifically for applications that require certification in accordance with UL 1310/508 Listed Class 2



Power supply,
1 AC, 12 V DC, 5 A
NEC Class 2

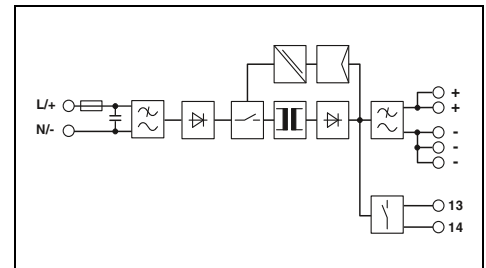

Technical data

Input data	100 V AC ... 240 V AC 110 V DC ... 250 V DC
Nominal input voltage range	100 V AC ... 240 V AC -15% ... +10% 99 V DC ... 275 V DC
Input voltage range	50 Hz ... 60 Hz ±10%
Frequency range	1.1 A (100 V AC) / 1 A (120 V AC) 0.6 A (230 V AC) / 0.6 A (240 V AC) 0.7 A (110 V DC) / 0.3 A (250 V DC)
Current consumption (nominal load)	≤ 25 A / < 0.6 A ² s typ. 20 ms (120 V AC) / typ. 110 ms (230 V AC)
Inrush current limitation at 25°C / I _{lt}	
Mains buffering (I _b)	
Output data	12 V DC ±1% 12 V DC ... 18 V DC (> 12 V DC, constant capacity restricted)
Nominal output voltage	
Setting range of the output voltage (U _{Set})	
Output current / Dynamic Boost	5 A / -
Can be connected in parallel/series	yes, with redundancy module / yes
Max. power dissipation (no load/nominal load)	< 1 W (230 V) / < 10 W (230 V)
Efficiency	> 86% (for 230 V AC and nominal values)
Residual ripple	< 50 mV _{PP}
Signaling	LED, floating signal contact
Signaling DC OK	
General data	0.32 kg / 30 x 130 x 115 mm alignable: horizontally 0 mm (≤ 40°C) 10 mm (≤ 70°C), vertically 50 mm
Weight / Dimensions W x H x D	
Connection	Push-in connection 0.2 - 4 mm ² / 0.2 - 2.5 mm ² / 24 - 12 0.2 - 4 mm ² / 0.2 - 2.5 mm ² / 24 - 12 IP20 / II > 2900000 h (40°C) -25°C ... 70°C (> 60°C Derating: 2.5%/K)
Connection method	
Input connection data rigid / flexible / AWG	
Output connection data rigid / flexible / AWG	
Degree of protection / Protection class	
MTBF (IEC 61709, SN 29500)	
Ambient temperature (operation)	
Standards/regulations	1.5 kV AC (routine test) / 3 kV AC (type test) Conformance with EMC Directive 2014/30/EU IEC 60950-1/VDE 0805 (SELV) EN 50178/VDE 0160 (PELV) DIN VDE 0100-410 UL Listed UL 508, UL/C-UL Recognized UL 60950-1, NEC Class 2 as per UL 1310 EN 61000-3-2
Insulation voltage input/output	
Electromagnetic compatibility	
Electrical safety	
Electronic equipm. for electrical power installations	
Safe isolation	
UL approvals	
Limitation of harmonic line currents	

Ordering data

Description	Type	Order No.	Pcs./Pkt.
Power supply, primary-switched	TRIO-PS-2G/1AC/12DC/5/C2LPS	2903157	1



Power supply,
1 AC, 12 V DC, 10 A



Power supply,
1 AC, 48 V DC, 5 A



Power supply,
1 AC, 48 V DC, 10 A

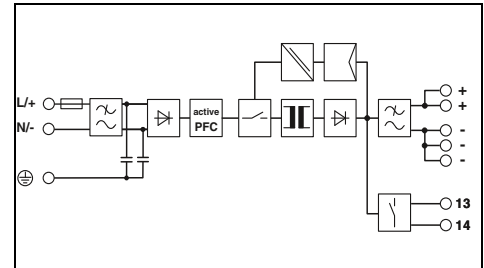
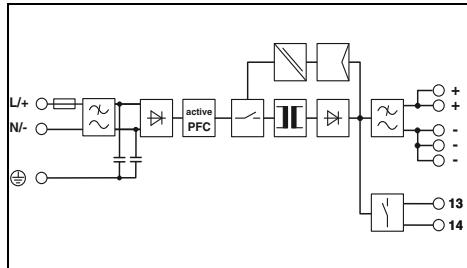
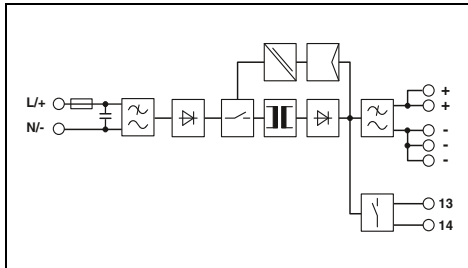

Technical data

Technical data

Technical data

100 V AC ... 240 V AC
110 V DC ... 250 V DC
100 V AC ... 240 V AC -15% ... +10%
99 V DC ... 275 V DC
50 Hz ... 60 Hz ±10%
2.2 A (100 V AC) / 1.9 A (120 V AC)
1.1 A (230 V AC) / 1.1 A (240 V AC)
1.3 A (110 V DC) / 0.6 A (250 V DC)
≤ 30 A / < 1.5 A²s
typ. 20 ms (120 V AC) / typ. 20 ms (230 V AC)

100 V AC ... 240 V AC
110 V DC ... 250 V DC
100 V AC ... 240 V AC -15% ... +10%
110 V DC ... 250 V DC ±10%
50 Hz ... 60 Hz ±10%
2.9 A (100 V AC) / 2.3 A (120 V AC)
1.2 A (230 V AC) / 1.2 A (240 V AC)
2.5 A (110 V DC) / 1.1 A (250 V DC)
< 0.3 A²s
typ. 15 ms (120 V AC) / typ. 15 ms (230 V AC)

100 V AC ... 240 V AC
110 V DC ... 250 V DC
100 V AC ... 240 V AC -15% ... +10%
99 V DC ... 275 V DC
50 Hz ... 60 Hz ±10%
5.6 A (100 V AC) / 5.4 A (120 V AC)
2.6 A (230 V AC) / 2.4 A (240 V AC)
5 A (110 V DC) / 2.2 A (250 V DC)
20 A / < 0.7 A²s
typ. 10 ms (120 V AC) / typ. 15 ms (230 V AC)

12 V DC ±1%
12 V DC ... 18 V DC (> 12 V DC, constant capacity restricted)

48 V DC ±1%
36 V DC ... 55 V DC (> 48 V DC, constant capacity restricted)

48 V DC ±1%
36 V DC ... 55 V DC (> 48 V DC, constant capacity restricted)

10 A / 15 A (5 s)
yes, with redundancy module / yes
< 1 W (230 V) / < 15 W (230 V)
> 89% (for 230 V AC and nominal values)
< 50 mV_{pp}

5 A / 7.5 A (5 s)
yes, with redundancy module / yes
typ. 4 W (120 V AC) / typ. 24.5 W (120 V AC)
typ. 90.5% (120 V AC) / typ. 91% (230 V AC)
< 20 mV_{pp}

10 A / 15 A (5 s)
yes, with redundancy module / yes
< 5.7 W (230 V) / < 44 W
> 93% (for 230 V AC and nominal values)
< 50 mV_{pp}

LED, floating signal contact

LED, floating signal contact

LED, floating signal contact

0.4 kg / 35 x 130 x 115 mm
alignable: horizontally 0 mm (≤ 40°C) 10 mm (≤ 70°C),
vertically 50 mm
Push-in connection
0.2 - 4 mm² / 0.2 - 2.5 mm² / 24 - 12
0.2 - 4 mm² / 0.2 - 2.5 mm² / 24 - 12
IP20 / II
> 170000 h (40°C)
-25°C ... 70°C (> 60°C Derating: 2.5%/K)

0.9 kg / 42 x 130 x 160 mm
alignable: horizontally 0 mm (≤ 40°C) 10 mm (≤ 70°C),
vertically 50 mm
Push-in connection
0.2 - 4 mm² / 0.2 - 2.5 mm² / 24 - 12
0.2 - 4 mm² / 0.2 - 2.5 mm² / 24 - 12
IP20 / I
> 120000 h (40°C)
-25°C ... 70°C (> 60°C Derating: 2.5%/K)

1.4 kg / 68 x 130 x 160 mm
alignable: horizontally 0 mm (≤ 40°C) 10 mm (≤ 70°C),
vertically 50 mm
Push-in connection
0.2 - 4 mm² / 0.2 - 2.5 mm² / 24 - 12
0.2 - 10 mm² / 0.2 - 6 mm² / 24 - 8
IP20 / I
> 800000 h (40°C)
-25°C ... 70°C (> 60°C Derating: 2.5%/K)

1.5 kV AC (routine test) / 3 kV AC (type test)
Conformance with EMC Directive 2014/30/EU
IEC 60950-1/VDE 0805 (SELV)
EN 50178/VDE 0160 (PELV)
DIN VDE 0100-410
UL Listed UL 508, UL/C-UL Recognized UL 60950-1

1.5 kV AC (routine test) / 3 kV AC (type test)
Conformance with EMC Directive 2014/30/EU
IEC 60950-1/VDE 0805 (SELV)
-
DIN VDE 0100-410
UL Listed UL 508, UL/C-UL Recognized UL 60950-1

1.5 kV AC / 3 kV AC
Conformance with EMC Directive 2014/30/EU
IEC 60950-1/VDE 0805 (SELV)
EN 50178/VDE 0160 (PELV)
DIN VDE 0100-410
UL Listed UL 508, UL/C-UL Recognized UL 60950-1

EN 61000-3-2

EN 61000-3-2

EN 61000-3-2

Ordering data

Ordering data

Ordering data

Type	Order No.	Pcs./Pkt.
TRIO-PS-2G/1AC/12DC/10	2903158	1

Type	Order No.	Pcs./Pkt.
TRIO-PS-2G/1AC/48DC/5	2903159	1

Type	Order No.	Pcs./Pkt.
TRIO-PS-2G/1AC/48DC/10	2903160	1

Power supplies

TRIO POWER power supplies – Robust standard functionality

TRIO POWER IP67, 1 AC, 24 V DC

- Direct installation in the field possible
- Installation at the consumer reduces the cable length, saves space in the control cabinet, and results in lower power loss there
- High operational safety, thanks to robust die-cast aluminum housing
- High system availability, thanks to excellent resistance to harmful environmental influences
- Reliable starting of heavy loads with dynamic boost
- Wide temperature range up to +85°C



new

Power supply,
1 AC, 24 V DC, 20 A

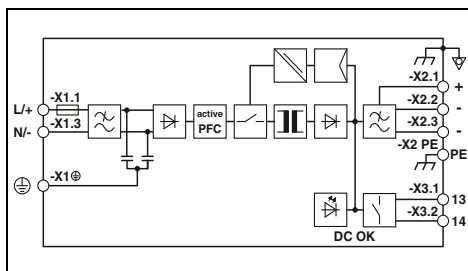

Technical data

Input data	
Nominal input voltage range	100 V AC ... 240 V AC 110 V DC ... 250 V DC
Input voltage range	100 V AC ... 240 V AC ±10% 110 V DC ... 250 V DC ±10%
Frequency range	50 Hz ... 60 Hz ± 5 Hz
Current consumption (nominal load)	5.6 A (100 V AC) / 4.3 A (120 V AC) 2.4 A (230 V AC) / 2.4 A (240 V AC) 4.9 A (110 V DC) / 2.1 A (250 V DC)
Inrush current limitation at 25°C / I _{rt}	≤ 20 A / < 0.9 A ² s
Mains buffering (I _N)	typ. 10 ms (120 V AC) / typ. 15 ms (230 V AC)
Output data	
Nominal output voltage (U _N)	24 V DC ±1%
Output current / Dynamic Boost	20 A / 30 A (5 s)
Can be connected in parallel/series	yes, with redundancy module / yes
Max. power dissipation (no load/nominal load)	< 1.2 W (400 V AC) / < 38 W (480 V AC)
Efficiency	> 91% (100 V AC) / > 93% (230 V AC)
Residual ripple	≤ 20 mV _{pp}
Signaling	
Signal options	DC OK
General data	
Weight / Dimensions W x H x D	3.7 kg / 148 x 304 x 120 mm
Connection	alignable: 20 mm horizontally, 50 mm vertically above, 100 mm vertically below
Connection method	S-coding (plug) M17, 3 pin + PE (socket) A-coding (plug)
Degree of protection / Protection class	IP67 / I
MTBF (IEC 61709, SN 29500)	> (40°C) > 1000000 h (40°C)
Ambient temperature (operation)	-25°C ... 85°C (Derating >60°C: 2.5%/K)
Standards/regulations	
Insulation voltage input/output	1.5 kV AC (routine test) / 3 kV AC (type test)
Electromagnetic compatibility	Conformance with EMC Directive 2014/30/EU
Electrical safety	IEC 61010-1 (SELV)
Electronic equipm. for electrical power installations	EN 50178/VDE 0160 (PELV)
Safe isolation	DIN VDE 0100-410
UL approvals	-
Limitation of harmonic line currents	EN 61000-3-2

Ordering data

Description	Type	Order No.	Pcs./Pkt.
Power supply, primary-switched	TRIO-PS-IP67/1AC/24DC/20	1039830	1

TRIO POWER power supplies – Robust standard functionality

TRIO POWER IP67, 3 AC, 24 V DC

- Direct installation in the field possible
- Installation at the consumer reduces the cable length, saves space in the control cabinet, and results in lower power loss there
- High operational safety, thanks to robust die-cast aluminum housing
- High system availability, thanks to excellent resistance to harmful environmental influences
- Reliable starting of heavy loads with dynamic boost
- Wide temperature range up to +85°C

new



**Power supply,
3 AC, 24 V DC, 20 A**

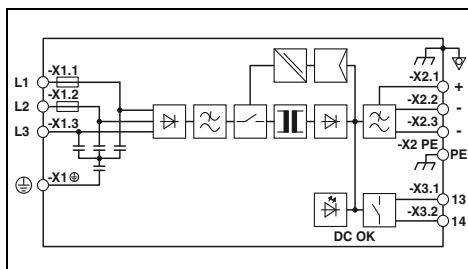

Technical data

Input data	
Nominal input voltage range	3x 400 V AC ... 500 V AC 2x 400 V AC ... 500 V AC
Input voltage range	3x 400 V AC ... 500 V AC -20% ... +15% 2x 400 V AC ... 500 V AC -10% ... +15%
Frequency range	50 Hz ... 60 Hz ± 5 Hz
Current consumption (nominal load)	3x 1.2 A (400 V AC) / 3x 1 A (500 V AC) 2x 2.3 A (400 V AC) / 2x 1.9 A (500 V AC) 4.9 A (110 V DC) / 2.1 A (250 V DC)
Inrush current limitation at 25°C / I _{st}	≤ 22 A / 0.5 A ^{2s}
Mains buffering (I _N)	typ. 10 ms (400 V AC) / typ. 20 ms (500 V AC)
Output data	
Nominal output voltage (U _N)	24 V DC ±1%
Output current / Dynamic Boost	20 A / 30 A (5 s)
Can be connected in parallel/series	yes, with redundancy module / yes
Max. power dissipation (no load/nominal load)	< 1.2 W (400 V AC) / < 38 W (480 V AC)
Efficiency	> 93% (400 V AC) / > 93% (500 V AC)
Residual ripple	≤ 20 mV _{pp}
Signaling	
Signal options	DC OK
General data	
Weight / Dimensions W x H x D	3.7 kg / 148 x 304 x 120 mm
Connection	alignable: 20 mm horizontally, 50 mm vertically above, 100 mm vertically below
Connection method	S-coding (plug) M17, 3 pin + PE (socket) A-coding (plug)
Degree of protection / Protection class	IP67 / I
MTBF (IEC 61709, SN 29500)	> (40°C) > 1100000 h (40°C)
Ambient temperature (operation)	-25°C ... 85°C (Derating > 60°C (3 AC): 2,5%/K / > 50°C (2 AC): 2,5%/K)
Standards/regulations	
Insulation voltage input/output	1.5 kV AC (routine test) / 3 kV AC (type test)
Electromagnetic compatibility	Conformance with EMC Directive 2014/30/EU
Electrical safety	IEC 61010-1 (SELV)
Electronic equipm. for electrical power installations	EN 50178/VDE 0160 (PELV)
Safe isolation	DIN VDE 0100-410
UL approvals	-
Limitation of harmonic line currents	EN 61000-3-2

Ordering data

Description	Type	Order No.	Pcs./Pkt.
Power supply, primary-switched	TRIO-PS-IP67/3AC/24DC/20	1039829	1

Power supplies and UPS

Power supplies

UNO POWER power supplies – Compact basic functionality

UNO POWER, 1 AC, 24 V DC

- The wide range of products covers all common voltage levels
- Maximum energy efficiency: save energy, thanks to high efficiency and extremely low idling losses
- Save space in the control cabinet, thanks to extremely high power density
- 84 mm housing depth for devices up to 100 W, tailored to all standard 120 mm control boxes
- Wide temperature range from -25°C to +70°C

UNO POWER, NEC Class 2

- Output power limited to 100 W
- Specifically for applications that require certification in accordance with UL 1310/508 Listed Class 2



Power supply,
1 AC, 24 DC, 30 W
NEC Class 2



Power supply,
1 AC, 24 DC, 60 W
NEC Class 2

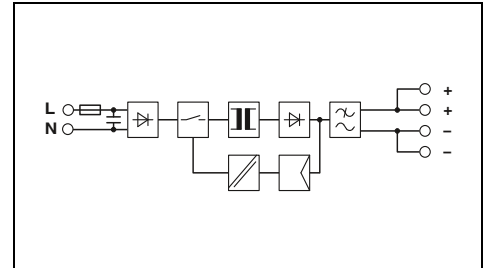
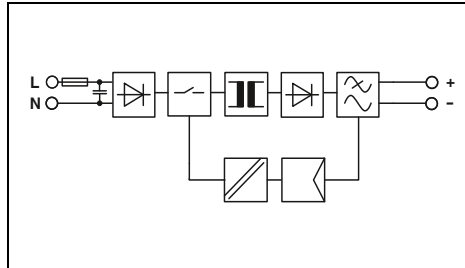

Technical data

Input data
Nominal input voltage range
Input voltage range
Frequency range (f _N)
Current consumption (nominal load)
Inrush current limitation at 25°C / I ² t
Mains buffering (I _N)
Output data
Nominal output voltage (U _N)
Output current
Can be connected in parallel/series
Max. power dissipation (no load/nominal load)
Efficiency
Residual ripple
Signaling
Signaling DC OK
General data
Weight / Dimensions W x H x D
Connection
Connection method
Connection data rigid / flexible / AWG
Degree of protection / Protection class
MTBF (IEC 61709, SN 29500)
Ambient temperature (operation)
Standards/regulations
Insulation voltage input/output
Electromagnetic compatibility
Electrical safety
Electronic equipm. for electrical power installations
Safe isolation
UL approvals
Limitation of harmonic line currents

100 V AC ... 240 V AC
85 V AC ... 264 V AC
50 Hz ... 60 Hz ±10%
0.8 A (100 V AC) / 0.4 A (240 V AC)
< 20 A / < 0.4 A ² s
typ. 25 ms (120 V AC) / typ. 115 ms (230 V AC)
24 V DC ±1%
1.25 A
yes, with redundancy module / yes
< 0.3 W / < 5 W
typ. 87% (120 V AC) / typ. 88% (230 V AC)
< 60 mV _{pp}
LED
0.15 kg / 22.5 x 90 x 84 mm
alignable: 0 mm horizontally, 30 mm vertically
Screw connection
0.2 - 2.5 mm ² / 0.2 - 2.5 mm ² / 24 - 14
IP20 / II
> 1158000 h (40°C)
-25°C ... 70°C (> 55°C Derating: 2.5%/K)
3 kV AC (routine test) / 4 kV AC (type test)
Conformance with EMC Directive 2014/30/EU
IEC 60950-1/VDE 0805 (SELV)
EN 50178/VDE 0160 (PELV)
DIN VDE 0100-410
UL/C-UL Listed UL 508, UL/C-UL Recognized UL 60950-1, NEC Class 2 as per UL 1310, UL/C-UL Listed ANSI/ISA-12.12.01 Class I, Division 2, Groups A, B, C, D T4 (Hazardous Location)
EN 61000-3-2

Ordering data

Description
Power supply, primary-switched

Type	Order No.	Pcs./Pkt.
UNO-PS/1AC/24DC/ 30W	2902991	1

Technical data

100 V AC ... 240 V AC
85 V AC ... 264 V AC
50 Hz ... 60 Hz ±10%
1.3 A (100 V AC) / 0.6 A (240 V AC)
< 30 A / < 0.5 A ² s
typ. 20 ms (120 V AC) / typ. 85 ms (230 V AC)
24 V DC ±1%
2.5 A
yes, with redundancy module / yes
< 0.3 W / < 7 W
typ. 88% (120 V AC) / typ. 90% (230 V AC)
< 30 mV _{pp}
LED
0.2 kg / 35 x 90 x 84 mm
alignable: 0 mm horizontally, 30 mm vertically
Screw connection
0.2 - 2.5 mm ² / 0.2 - 2.5 mm ² / 24 - 14
IP20 / II
> 785000 h (40°C)
-25°C ... 70°C (> 55°C Derating: 2.5%/K)
3 kV AC (routine test) / 4 kV AC (type test)
Conformance with EMC Directive 2014/30/EU
IEC 60950-1/VDE 0805 (SELV)
EN 50178/VDE 0160 (PELV)
DIN VDE 0100-410
UL/C-UL Listed UL 508, UL/C-UL Recognized UL 60950-1, NEC Class 2 as per UL 1310, UL/C-UL Listed ANSI/ISA-12.12.01 Class I, Division 2, Groups A, B, C, D T4A (Hazardous Location)
EN 61000-3-2

Ordering data

Type	Order No.	Pcs./Pkt.
UNO-PS/1AC/24DC/ 60W	2902992	1



Power supply,
1 AC, 24 DC, 100 W



Power supply,
1 AC, 24 DC, 150 W



Power supply,
1 AC, 24 DC, 240 W

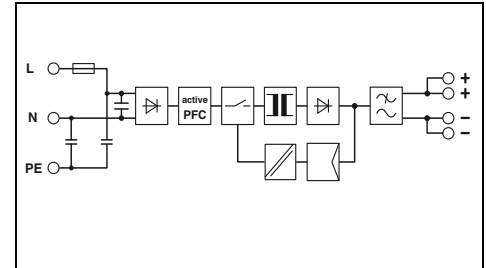
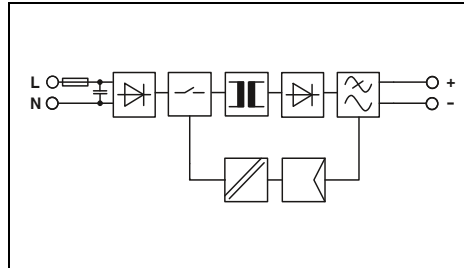
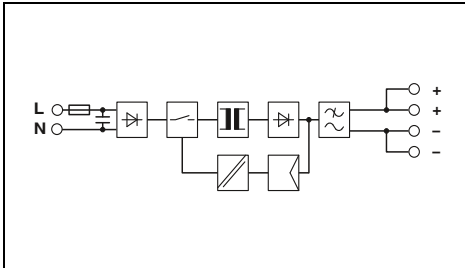

Technical data

100 V AC ... 240 V AC
85 V AC ... 264 V AC
50 Hz ... 60 Hz $\pm 10\%$
2.1 A (100 V AC) / 0.95 A (240 V AC)
< 40 A / < 1.5 A²s
typ. 20 ms (120 V AC) / typ. 100 ms (230 V AC)

24 V DC $\pm 1\%$
4.2 A
yes, with redundancy module / yes
< 0.5 W / < 11 W
typ. 88% (120 V AC) / typ. 89% (230 V AC)
< 30 mV_{pp}

LED

0.34 kg / 55 x 90 x 84 mm
alignable: 0 mm horizontally, 30 mm vertically
Screw connection
0.2 - 2.5 mm² / 0.2 - 2.5 mm² / 24 - 14
IP20 / II
> 738000 h (40°C)
-25°C ... 70°C (> 55°C Derating: 2.5%/K)

3 kV AC (routine test) / 4 kV AC (type test)
Conformance with EMC Directive 2014/30/EU
IEC 60950-1/VDE 0805 (SELV)
EN 50178/VDE 0160 (PELV)
DIN VDE 0100-410
UL/C-UL Listed UL 508, UL/C-UL Recognized UL 60950-1,
UL/C-UL Listed ANSI/ISA-12.12.01 Class I, Division 2,
Groups A, B, C, D T4 (Hazardous Location)
EN 61000-3-2

Ordering data

Type	Order No.	Pcs./Pkt.
UNO-PS/1AC/24DC/100W	2902993	1

Technical data

100 V AC ... 240 V AC
85 V AC ... 264 V AC
50 Hz ... 60 Hz $\pm 10\%$
1.66 A (100 V AC) / 0.68 A (240 V AC)
< 50 A / < 0.8 A²s
typ. 20 ms (120 V AC) / typ. 20 ms (230 V AC)

24 V DC $\pm 1\%$
6.25 A
yes, with redundancy module / No
< 1.2 W / < 9.7 W
typ. 91% (120 V AC) / typ. 94% (230 V AC)
< 40 mV_{pp}

LED

0.5 kg / 37 x 130 x 125 mm
alignable: 0 mm horizontally, 30 mm vertically
Screw connection
0.2 - 2.5 mm² / 0.2 - 2.5 mm² / 24 - 14
IP20 / II
> 868000 h (40°C)
-25°C ... 70°C (> 55°C Derating: 2.5%/K)

3 kV AC (routine test) / 4 kV AC (type test)
Conformance with EMC Directive 2014/30/EU
EN 60950-1/VDE 0805 (SELV)
EN 50178/VDE 0160 (PELV)
DIN VDE 0100-410
UL/C-UL Listed UL 508, UL/C-UL Recognized UL 60950-1,
UL/C-UL Listed ANSI/ISA-12.12.01 Class I, Division 2,
Groups A, B, C, D T4 (Hazardous Location)
EN 61000-3-2

Ordering data

Type	Order No.	Pcs./Pkt.
UNO-PS/1AC/24DC/150W	2904376	1

Technical data

100 V AC ... 240 V AC
85 V AC ... 264 V AC
50 Hz ... 60 Hz $\pm 5\%$
2.69 A (100 V AC) / 1.08 A (240 V AC)
< 80 A / < 2 A²s
typ. 10 ms (120 V AC) / typ. 10 ms (230 V AC)

24 V DC $\pm 1\%$
10 A
yes, with redundancy module / No
< 1.1 W / < 18.8 W
typ. 90% (120 V AC) / typ. 93% (230 V AC)
< 50 mV_{pp}

LED

0.66 kg / 45 x 130 x 125 mm
alignable: 0 mm horizontally, 30 mm vertically
Screw connection
0.2 - 2.5 mm² / 0.2 - 2.5 mm² / 24 - 14
IP20 / I
> 641000 h (40°C)
-25°C ... 70°C (> 55°C Derating: 2.5%/K)

3 kV AC (routine test) / 4 kV AC (type test)
Conformance with EMC Directive 2014/30/EU
EN 60950-1/VDE 0805 (SELV)
EN 50178/VDE 0160 (PELV)
DIN VDE 0100-410
UL/C-UL Listed UL 508, UL/C-UL Recognized UL 60950-1,
UL/C-UL Listed ANSI/ISA-12.12.01 Class I, Division 2,
Groups A, B, C, D T4 (Hazardous Location)
EN 61000-3-2

Ordering data

Type	Order No.	Pcs./Pkt.
UNO-PS/1AC/24DC/240W	2904372	1

Power supplies and UPS

Power supplies

UNO POWER power supplies – Compact basic functionality

UNO POWER, 1 AC, 24 V DC, 480 W

- The wide range of products covers all common voltage levels
- Maximum energy efficiency: save energy, thanks to high efficiency and extremely low idling losses
- Save space in the control cabinet, thanks to extremely high power density
- Wide temperature range from -25°C to +70°C
- Active function monitoring with DC OK LED and relay contact



new

Power supply,
1 AC, 24 DC, 480 W

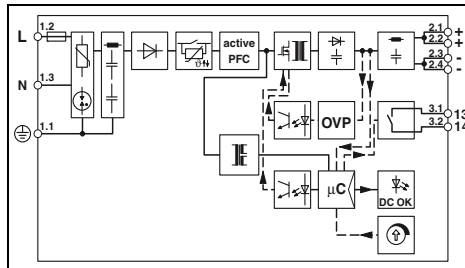

Technical data

Input data	
Nominal input voltage range	100 V AC ... 240 V AC
Input voltage range	100 V AC ... 240 V AC -15% ... +10%
Frequency range (f _N)	50 Hz ... 60 Hz ±10%
Current consumption (nominal load)	5.4 A (100 V AC) / 4.4 A (120 V AC)
Inrush current limitation at 25°C / I ² t	< 20 A / < 1 A ² s
Mains buffering (I _N)	typ. 20 ms (120 V AC) / typ. 20 ms (230 V AC)
Output data	
Nominal output voltage (U _N)	24 V DC
Output current	20 A
Can be connected in parallel/series	yes, with redundancy module / yes
Max. power dissipation (no load/nominal load)	< 4 W / < 36 W
Efficiency	typ. 93% (120 V AC) / typ. 94.6% (230 V AC)
Residual ripple	< 100 mV _{pp}
Signaling	
Signaling DC OK	LED, floating signal contact
General data	
Weight / Dimensions W x H x D	1 kg / 59 x 130 x 125 mm
Connection	alignable: 5 mm horizontally, 15 mm next to active components, 30 mm vertically
Connection method	Screw connection
Connection data rigid / flexible / AWG	0.2 - 6 mm ² / 0.2 - 4 mm ² / 24 - 10
Degree of protection / Protection class	IP20 / I
MTBF (IEC 61709, SN 29500)	> 500000 h (40°C)
Ambient temperature (operation)	-25°C ... 70°C (> 55°C Derating: 2.5%/K)
Standards/regulations	
Insulation voltage input/output	2.5 kV AC (routine test) / 4.43 kV AC (type test)
Electromagnetic compatibility	Conformance with EMC Directive 2014/30/EU
Electrical safety	IEC 61010-2-201 (SELV)
Electronic equipm. for electrical power installations	EN 50178/VDE 0160 (PELV)
Safe isolation	IEC 61558-2-16, IEC 61010-2-201
UL approvals	UL/C-UL Listed UL 61010-1, UL/C-UL Listed UL 61010-2-201
Limitation of harmonic line currents	EN 61000-3-2

Ordering data

Description	Type	Order No.	Pcs./Pkt.
Power supply, primary-switched	UNO2-PS/1AC/24DC/480W	2910105	1

UNO POWER power supplies – Compact basic functionality

UNO POWER, 1 AC and 2 AC, 24 V DC

- The wide range of products covers all common voltage levels
- Maximum energy efficiency: save energy, thanks to high efficiency and extremely low idling losses
- Save space in the control cabinet, thanks to extremely high power density
- Housing depth of 84 mm, tailored to all popular 120 mm control boxes
- Wide temperature range from -25°C to +70°C

UNO POWER, NEC Class 2

- Output power limited to 100 W
- Specifically for applications that require certification in accordance with UL 1310/508 Listed Class 2

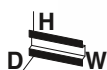

**Power supply,
1 AC, 24 DC, 90 W
NEC Class 2**



**Power supply,
2 AC, 24 DC, 90 W
NEC Class 2**

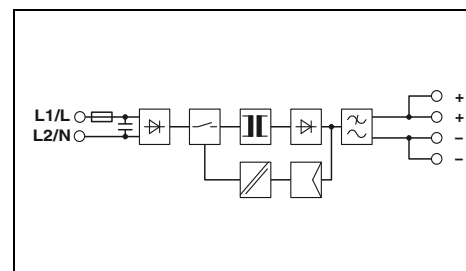
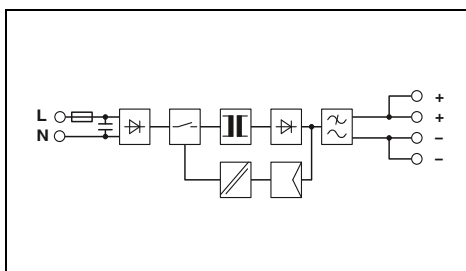

Technical data

Technical data

Input data	
Nominal input voltage range	100 V AC ... 240 V AC
Input voltage range	85 V AC ... 264 V AC
Frequency range (f _{in})	50 Hz ... 60 Hz ±10%
Current consumption (nominal load)	1.8 A (100 V AC) / 0.8 A (240 V AC)
Inrush current limitation at 25°C / I ² t	< 40 A / < 1.5 A ² s
Mains buffering (I _N)	typ. 25 ms (120 V AC) / typ. 100 ms (230 V AC)
Output data	
Nominal output voltage (U _N)	24 V DC ±1%
Output current	3.75 A
Can be connected in parallel/series	No / No
Max. power dissipation (no load/nominal load)	< 0.7 W / < 12 W
Efficiency	typ. 88% (120 V AC) / typ. 88% (230 V AC)
Residual ripple	< 45 mV _{pp}
Signaling	
Signaling DC OK	LED
General data	
Weight / Dimensions W x H x D	0.34 kg / 55 x 90 x 84 mm
Connection	alignable: 0 mm horizontally, 30 mm vertically
Connection method	Screw connection
Connection data rigid / flexible / AWG	0.2 - 2.5 mm ² / 0.2 - 2.5 mm ² / 24 - 14
Degree of protection / Protection class	IP20 / II
MTBF (IEC 61709, SN 29500)	> 1159000 h (40°C)
Ambient temperature (operation)	-25°C ... 70°C (> 55°C Derating: 2.5%/K)
Standards/regulations	
Insulation voltage input/output	3 kV AC (routine test) / 4 kV AC (type test)
Electromagnetic compatibility	Conformance with EMC Directive 2014/30/EU
Electrical safety	IEC 60950-1/VDE 0805 (SELV)
Electronic equipm. for electrical power installations	EN 50178/VDE 0160 (PELV)
Safe isolation	DIN VDE 0100-410
UL approvals	UL/C-UL Listed UL 508, UL/C-UL Recognized UL 60950-1, NEC Class 2 as per UL 1310, UL/C-UL Listed ANSI/ISA-12.12.01 Class I, Division 2, Groups A, B, C, D T4 (Hazardous Location) EN 61000-3-2
Limitation of harmonic line currents	

Technical data	
Nominal input voltage range	2x 400 V AC ... 500 V AC
Input voltage range	2x 264 V AC ... 575 V AC
Frequency range (f _{in})	50 Hz ... 60 Hz ±10%
Current consumption (nominal load)	0.55 A (400 V AC) / 0.48 A (500 V AC)
Inrush current limitation at 25°C / I ² t	< 30 A / < 0.5 A ² s
Mains buffering (I _N)	typ. 65 ms (400 V AC) / typ. 100 ms (500 V AC)
Output data	
Nominal output voltage (U _N)	24 V DC ±1%
Output current	3.75 A
Can be connected in parallel/series	No / No
Max. power dissipation (no load/nominal load)	< 0.7 W / < 12 W
Efficiency	typ. 89% (400 V AC) / typ. 89% (480 V AC)
Residual ripple	< 50 mV _{pp}
Signaling	
Signaling DC OK	LED
General data	
Weight / Dimensions W x H x D	0.32 kg / 55 x 90 x 84 mm
Connection	alignable: 0 mm horizontally, 30 mm vertically
Connection method	Screw connection
Connection data rigid / flexible / AWG	0.2 - 2.5 mm ² / 0.2 - 2.5 mm ² / 24 - 14
Degree of protection / Protection class	IP20 / II
MTBF (IEC 61709, SN 29500)	> 828000 h (40°C)
Ambient temperature (operation)	-25°C ... 70°C (> 55°C Derating: 2.5%/K)
Standards/regulations	
Insulation voltage input/output	3 kV AC (routine test) / 4 kV AC (type test)
Electromagnetic compatibility	Conformance with EMC Directive 2014/30/EU
Electrical safety	IEC 60950-1/VDE 0805 (SELV)
Electronic equipm. for electrical power installations	EN 50178/VDE 0160 (PELV)
Safe isolation	DIN VDE 0100-410
UL approvals	UL/C-UL Listed UL 508, UL/C-UL Recognized UL 60950-1, NEC Class 2 as per UL 1310, UL/C-UL Listed ANSI/ISA-12.12.01 Class I, Division 2, Groups A, B, C, D T4 (Hazardous Location) EN 61000-3-2
Limitation of harmonic line currents	

Ordering data

Ordering data

Description	Type	Order No.	Pcs./Pkt.
Power supply, primary-switched	UNO-PS/1AC/24DC/90W/C2LPS	2902994	1

Description	Type	Order No.	Pcs./Pkt.
Power supply, primary-switched	UNO-PS/2AC/24DC/90W/C2LPS	2904371	1

Description	Type	Order No.	Pcs./Pkt.
Power supply, primary-switched	UNO-PS/2AC/24DC/90W/C2LPS	2904371	1

Power supplies and UPS

Power supplies

UNO POWER power supplies – Compact basic functionality

UNO POWER, 1 AC, 5 to 12 V DC

- The wide range of products covers all common voltage levels
- Maximum energy efficiency: save energy, thanks to high efficiency and extremely low idling losses
- Save space in the control cabinet, thanks to the extremely high power density
- Housing depth of 84 mm, tailored to all popular 120 mm control boxes
- Wide temperature range from -25°C to +70°C



Power supply,
1 AC, 12 DC, 30 W



Power supply,
1 AC, 12 DC, 55 W

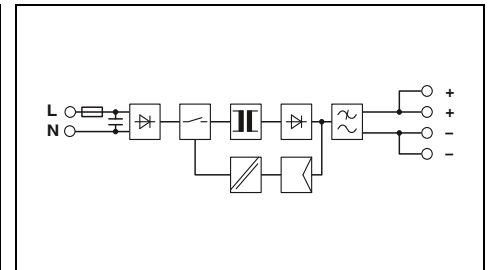
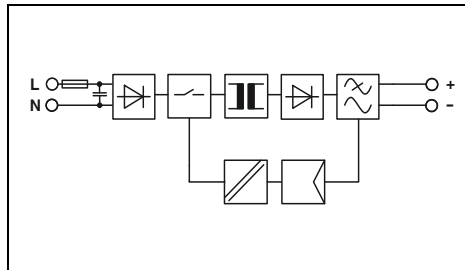

Technical data

Input data
Nominal input voltage range
Input voltage range
Frequency range (f _N)
Current consumption (nominal load)
Inrush current limitation at 25°C / I ² t
Mains buffering (I _N)
Output data
Nominal output voltage (U _N)
Output current
Can be connected in parallel/series
Max. power dissipation (no load/nominal load)
Efficiency
Residual ripple
Signaling
Signaling DC OK
General data
Weight / Dimensions W x H x D
Connection
Connection method
Connection data rigid / flexible / AWG
Degree of protection / Protection class
MTBF (IEC 61709, SN 29500)
Ambient temperature (operation)
Standards/regulations
Insulation voltage input/output
Electromagnetic compatibility
Electrical safety
Electronic equipm. for electrical power installations
Safe isolation
UL approvals
Limitation of harmonic line currents

100 V AC ... 240 V AC
85 V AC ... 264 V AC
50 Hz ... 60 Hz ±5 Hz
0.8 A (100 V AC) / 0.4 A (240 V AC)
< 25 A / < 0.3 A ² s
typ. 20 ms (120 V AC) / typ. 110 ms (230 V AC)
12 V DC ±1%
2.5 A
yes, with redundancy module / yes
< 0.3 W / < 4.6 W
typ. 86% (120 V AC) / typ. 87% (230 V AC)
< 30 mV _{pp}
LED
0.15 kg / 22.5 x 90 x 84 mm
alignable: 0 mm horizontally, 30 mm vertically
Screw connection
0.2 - 2.5 mm ² / 0.2 - 2.5 mm ² / 24 - 14
IP20 / II
> 953000 h (40°C)
-25°C ... 70°C (> 55°C Derating: 2.5%/K)
3 kV AC (routine test) / 4 kV AC (type test)
Conformance with EMC Directive 2014/30/EU
IEC 60950-1/VDE 0805 (SELV)
EN 50178/VDE 0160 (PELV)
DIN VDE 0100-410
UL/C-UL Listed UL 508, UL/C-UL Recognized UL 60950-1,
UL/C-UL Listed ANSI/ISA-12.12.01 Class I, Division 2,
Groups A, B, C, D T4 (Hazardous Location)
EN 61000-3-2

Ordering data

Description
Power supply, primary-switched, 1-phase

Type	Order No.	Pcs./Pkt.
UNO-PS/1AC/12DC/ 30W	2902998	1

Technical data

100 V AC ... 240 V AC
85 V AC ... 264 V AC
50 Hz ... 60 Hz ±5 Hz
1.3 A (100 V AC) / 0.6 A (240 V AC)
< 30 A / < 0.5 A ² s
typ. 20 ms (120 V AC) / typ. 90 ms (230 V AC)
12 V DC ±1%
4.6 A
yes, with redundancy module / yes
< 0.3 W / < 8 W
typ. 87% (120 V AC) / typ. 88% (230 V AC)
< 30 mV _{pp}
LED
0.2 kg / 35 x 90 x 84 mm
alignable: 0 mm horizontally, 30 mm vertically
Screw connection
0.2 - 2.5 mm ² / 0.2 - 2.5 mm ² / 24 - 14
IP20 / II
> 865000 h (40°C)
-25°C ... 70°C (> 55°C Derating: 2.5%/K)
3 kV AC (routine test) / 4 kV AC (type test)
Conformance with EMC Directive 2014/30/EU
IEC 60950-1/VDE 0805 (SELV)
EN 50178/VDE 0160 (PELV)
DIN VDE 0100-410
UL/C-UL Listed UL 508, UL/C-UL Recognized UL 60950-1,
UL/C-UL Listed ANSI/ISA-12.12.01 Class I, Division 2,
Groups A, B, C, D T4A (Hazardous Location)
EN 61000-3-2

Ordering data

Type	Order No.	Pcs./Pkt.
UNO-PS/1AC/12DC/ 55W	2902999	1



Power supply,
1 AC, 12 DC, 100 W



Power supply,
1 AC, 5 DC, 25 W



Power supply,
1 AC, 5 DC, 40 W

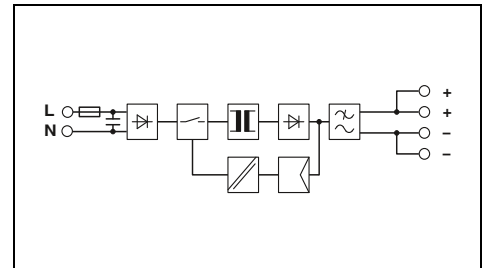
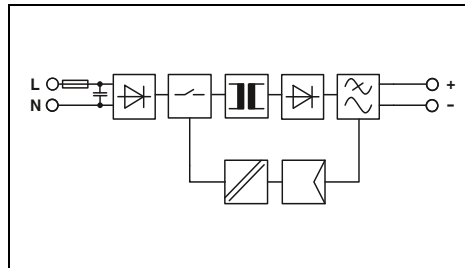
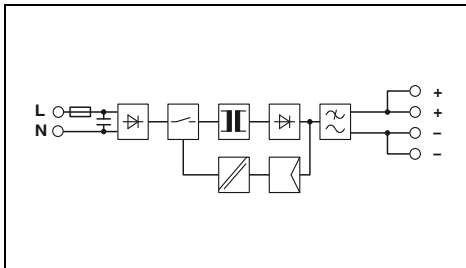

Technical data

100 V AC ... 240 V AC
85 V AC ... 264 V AC
50 Hz ... 60 Hz ± 5 Hz
2.19 A (100 V AC) / 1.13 A (240 V AC)
< 30 A / < 1.5 A²s
typ. 20 ms (120 V AC) / typ. 85 ms (230 V AC)

12 V DC $\pm 1\%$
8.3 A
yes, with redundancy module / yes
< 0.4 W / < 12 W
typ. 88% (120 V AC) / typ. 89% (230 V AC)
< 75 mV_{pp}

LED

0.34 kg / 55 x 90 x 84 mm
alignable: 0 mm horizontally, 30 mm vertically
Screw connection
0.2 - 2.5 mm² / 0.2 - 2.5 mm² / 24 - 14
IP20 / II
> 500000 h (40°C)
-25°C ... 70°C (> 55°C Derating: 2.5%/K)

3 kV AC (routine test) / 4 kV AC (type test)
Conformance with EMC Directive 2014/30/EU
IEC 60950-1/VDE 0805 (SELV)
EN 50178/VDE 0160 (PELV)
DIN VDE 0100-410
UL/C-UL Listed UL 508, UL/C-UL Recognized UL 60950-1,
UL/C-UL Listed ANSI/ISA-12.12.01 Class I, Division 2,
Groups A, B, C, D T4 (Hazardous Location)
EN 61000-3-2

Ordering data

Type	Order No.	Pcs./Pkt.
UNO-PS/1AC/12DC/100W	2902997	1

Technical data

100 V AC ... 240 V AC
85 V AC ... 264 V AC
50 Hz ... 60 Hz $\pm 10\%$
0.53 A (100 V AC) / 0.28 A (240 V AC)
< 30 A / < 0.5 A²s
typ. 35 ms (120 V AC) / typ. 135 ms (230 V AC)

5 V DC $\pm 1\%$
5 A
yes, with redundancy module / yes
< 0.3 W / < 4.5 W
typ. 85% (120 V AC) / typ. 86% (230 V AC)
< 40 mV_{pp}

LED

0.15 kg / 22.5 x 90 x 84 mm
alignable: 0 mm horizontally, 30 mm vertically
Screw connection
0.2 - 2.5 mm² / 0.2 - 2.5 mm² / 24 - 14
IP20 / II
> 2174000 h (40°C)
-25°C ... 70°C (> 55°C Derating: 2.5%/K)

3 kV AC (routine test) / 4 kV AC (type test)
Conformance with EMC Directive 2014/30/EU
IEC 60950-1/VDE 0805 (SELV)
EN 50178/VDE 0160 (PELV)
DIN VDE 0100-410
UL/C-UL Listed UL 508, UL/C-UL Recognized UL 60950-1,
UL/C-UL Listed ANSI/ISA-12.12.01 Class I, Division 2,
Groups A, B, C, D T4 (Hazardous Location)
EN 61000-3-2

Ordering data

Type	Order No.	Pcs./Pkt.
UNO-PS/1AC/5DC/25W	2904374	1

Technical data

100 V AC ... 240 V AC
85 V AC ... 264 V AC
50 Hz ... 60 Hz ± 5 Hz
0.8 A (100 V AC) / 0.4 A (240 V AC)
< 30 A / < 0.5 A²s
typ. 30 ms (120 V AC) / typ. 120 ms (230 V AC)

5 V DC $\pm 1\%$
8 A
yes, with redundancy module / yes
< 0.3 W / < 7.5 W
typ. 84% (120 V AC) / typ. 85% (230 V AC)
< 100 mV_{pp}

LED

0.21 kg / 35 x 90 x 84 mm
alignable: 0 mm horizontally, 30 mm vertically
Screw connection
0.2 - 2.5 mm² / 0.2 - 2.5 mm² / 24 - 14
IP20 / II
> 1201000 h (40°C)
-25°C ... 70°C (> 55°C Derating: 2.5%/K)

3 kV AC (routine test) / 4 kV AC (type test)
Conformance with EMC Directive 2014/30/EU
IEC 60950-1/VDE 0805 (SELV)
EN 50178/VDE 0160 (PELV)
DIN VDE 0100-410
UL/C-UL Listed UL 508, UL/C-UL Recognized UL 60950-1,
UL/C-UL Listed ANSI/ISA-12.12.01 Class I, Division 2,
Groups A, B, C, D T4A (Hazardous Location)
EN 61000-3-2

Ordering data

Type	Order No.	Pcs./Pkt.
UNO-PS/1AC/5DC/40W	2904375	1

Power supplies and UPS

Power supplies

UNO POWER power supplies – Compact basic functionality

UNO POWER, 1 AC, 15 to 48 V DC

- The wide range of products covers all common voltage levels
- Maximum energy efficiency: save energy, thanks to high efficiency and extremely low idling losses
- Save space in the control cabinet, thanks to the extremely high power density
- Housing depth of 84 mm, tailored to all popular 120 mm control boxes
- Wide temperature range from -25°C to +70°C



Power supply,
1 AC, 15 DC, 30 W



Power supply,
1 AC, 15 DC, 55 W

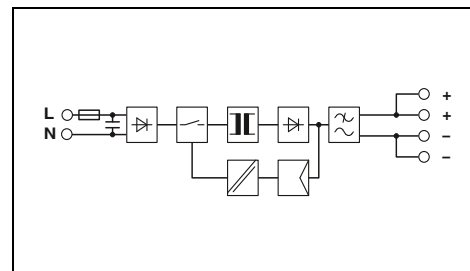
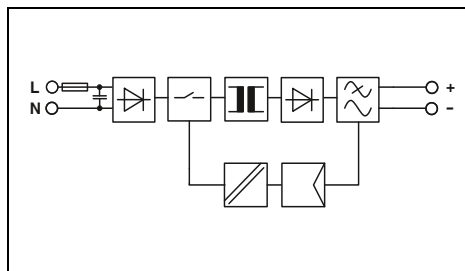

Technical data

Input data
Nominal input voltage range
Input voltage range
Frequency range (f _N)
Current consumption (nominal load)
Inrush current limitation at 25°C / I ² t
Mains buffering (I _N)
Output data
Nominal output voltage (U _N)
Output current
Can be connected in parallel/series
Max. power dissipation (no load/nominal load)
Efficiency
Residual ripple
Signaling
Signaling DC OK
General data
Weight / Dimensions W x H x D
Connection
Connection method
Connection data rigid / flexible / AWG
Degree of protection / Protection class
MTBF (IEC 61709, SN 29500)
Ambient temperature (operation)
Standards/regulations
Insulation voltage input/output
Electromagnetic compatibility
Electrical safety
Electronic equipm. for electrical power installations
Safe isolation
UL approvals
Limitation of harmonic line currents

100 V AC ... 240 V AC
85 V AC ... 264 V AC
50 Hz ... 60 Hz ±10%
0.8 A (100 V AC) / 0.4 A (240 V AC)
< 30 A / < 0.3 A ² s
typ. 20 ms (120 V AC) / typ. 115 ms (230 V AC)
15 V DC ±1%
2 A
yes, with redundancy module / yes
< 0.3 W / < 4.6 W
typ. 85% (120 V AC) / typ. 86% (230 V AC)
< 40 mV _{pp}
LED
0.15 kg / 22.5 x 90 x 84 mm
alignable: 0 mm horizontally, 30 mm vertically
Screw connection
0.2 - 2.5 mm ² / 0.2 - 2.5 mm ² / 24 - 14
IP20 / II
> 911000 h (40°C)
-25°C ... 70°C (> 55°C Derating: 2.5%/K)
3 kV AC (routine test) / 4 kV AC (type test)
Conformance with EMC Directive 2014/30/EU
IEC 60950-1/VDE 0805 (SELV)
EN 50178/VDE 0160 (PELV)
DIN VDE 0100-410
UL/C-UL Listed UL 508, UL/C-UL Recognized UL 60950-1,
UL/C-UL Listed ANSI/ISA-12.12.01 Class I, Division 2,
Groups A, B, C, D T4 (Hazardous Location)
EN 61000-3-2

Ordering data

Description
Power supply , primary-switched, 1-phase

Type	Order No.	Pcs./Pkt.
UNO-PS/1AC/15DC/30W	2903000	1

Technical data

100 V AC ... 240 V AC
85 V AC ... 264 V AC
50 Hz ... 60 Hz ±10%
1.3 A (100 V AC) / 0.6 A (240 V AC)
< 25 A / < 0.5 A ² s
typ. 25 ms (120 V AC) / typ. 90 ms (230 V AC)
15 V DC ±1%
3.7 A
yes, with redundancy module / yes
< 0.3 W / < 7 W
typ. 87% (120 V AC) / typ. 88% (230 V AC)
< 50 mV _{pp}
LED
0.21 kg / 35 x 90 x 84 mm
alignable: 0 mm horizontally, 30 mm vertically
Screw connection
0.2 - 2.5 mm ² / 0.2 - 2.5 mm ² / 24 - 14
IP20 / II
> 647000 h (40°C)
-25°C ... 70°C (> 55°C Derating: 2.5%/K)
3 kV AC (routine test) / 4 kV AC (type test)
Conformance with EMC Directive 2014/30/EU
IEC 60950-1/VDE 0805 (SELV)
EN 50178/VDE 0160 (PELV)
DIN VDE 0100-410
UL/C-UL Listed UL 508, UL/C-UL Recognized UL 60950-1,
UL/C-UL Listed ANSI/ISA-12.12.01 Class I, Division 2,
Groups A, B, C, D T4A (Hazardous Location)
EN 61000-3-2

Ordering data

Type	Order No.	Pcs./Pkt.
UNO-PS/1AC/15DC/ 55W	2903001	1



Power supply,
1 AC, 15 DC, 100 W



Power supply,
1 AC, 48 DC, 60 W



Power supply,
1 AC, 48 DC, 100 W

UL CB
Ex:

UL CB
Ex:

UL CB
Ex:

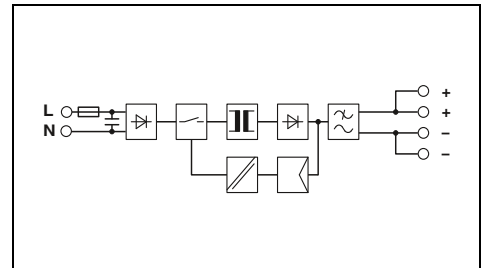
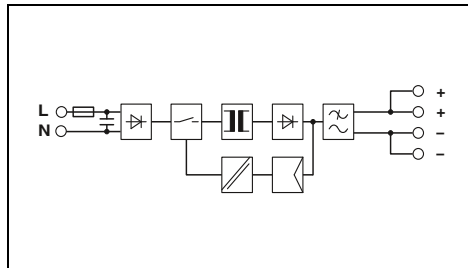
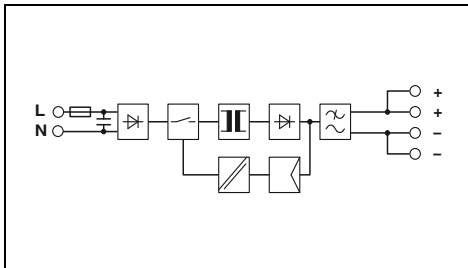

Technical data

100 V AC ... 240 V AC
85 V AC ... 264 V AC
50 Hz ... 60 Hz $\pm 10\%$
2.19 A (100 V AC) / 1.13 A (240 V AC)
< 30 A / < 1.5 A²s
typ. 20 ms (120 V AC) / typ. 85 ms (230 V AC)

15 V DC $\pm 1\%$
6.67 A
yes, with redundancy module / yes
< 0.4 W / < 12 W
typ. 89% (120 V AC) / typ. 89% (230 V AC)
< 75 mV_{pp}

LED

0.34 kg / 55 x 90 x 84 mm
alignable: 0 mm horizontally, 30 mm vertically
Screw connection
0.2 - 2.5 mm² / 0.2 - 2.5 mm² / 24 - 14
IP20 / II
> 727000 h (40°C)
-25°C ... 70°C (> 55°C Derating: 2.5%/K)

3 kV AC (routine test) / 4 kV AC (type test)
Conformance with EMC Directive 2014/30/EU
IEC 60950-1/VDE 0805 (SELV)
EN 50178/VDE 0160 (PELV)
DIN VDE 0100-410
UL/C-UL Listed UL 508, UL/C-UL Recognized UL 60950-1,
UL/C-UL Listed ANSI/ISA-12.12.01 Class I, Division 2,
Groups A, B, C, D T4A (Hazardous Location)
EN 61000-3-2

Ordering data

Type	Order No.	Pcs./Pkt.
UNO-PS/1AC/15DC/100W	2903002	1

Technical data

100 V AC ... 240 V AC
85 V AC ... 264 V AC
50 Hz ... 60 Hz $\pm 10\%$
1.3 A (100 V AC) / 0.6 A (240 V AC)
< 30 A / < 0.5 A²s
typ. 20 ms (120 V AC) / typ. 90 ms (230 V AC)

48 V DC $\pm 1\%$
1.25 A
yes, with redundancy module / yes
< 0.4 W / < 7 W
typ. 89% (120 V AC) / typ. 89% (230 V AC)
< 35 mV_{pp}

LED

0.21 kg / 35 x 90 x 84 mm
alignable: 0 mm horizontally, 30 mm vertically
Screw connection
0.2 - 2.5 mm² / 0.2 - 2.5 mm² / 24 - 14
IP20 / II
> 1138000 h (40°C)
-25°C ... 70°C (> 55°C Derating: 2.5%/K)

3 kV AC (routine test) / 4 kV AC (type test)
Conformance with EMC Directive 2014/30/EU
IEC 60950-1/VDE 0805 (SELV)
EN 50178/VDE 0160 (PELV)
DIN VDE 0100-410
UL/C-UL Listed UL 508, UL/C-UL Recognized UL 60950-1,
UL/C-UL Listed ANSI/ISA-12.12.01 Class I, Division 2,
Groups A, B, C, D T4A (Hazardous Location)
EN 61000-3-2

Ordering data

Type	Order No.	Pcs./Pkt.
UNO-PS/1AC/48DC/ 60W	2902995	1

Technical data

100 V AC ... 240 V AC
85 V AC ... 264 V AC
50 Hz ... 60 Hz $\pm 10\%$
2.2 A (100 V AC) / 1.1 A (240 V AC)
< 40 A / < 1.4 A²s
typ. 25 ms (120 V AC) / typ. 90 ms (230 V AC)

48 V DC $\pm 1\%$
2.1 A
yes, with redundancy module / yes
< 0.4 W / < 11 W
typ. 88% (120 V AC) / typ. 90% (230 V AC)
< 40 mV_{pp}

LED

0.34 kg / 55 x 90 x 84 mm
alignable: 0 mm horizontally, 30 mm vertically
Screw connection
0.2 - 2.5 mm² / 0.2 - 2.5 mm² / 24 - 14
IP20 / II
> 1010000 h (40°C)
-25°C ... 70°C (> 55°C Derating: 2.5%/K)

3 kV AC (routine test) / 4 kV AC (type test)
Conformance with EMC Directive 2014/30/EU
IEC 60950-1/VDE 0805 (SELV)
EN 50178/VDE 0160 (PELV)
DIN VDE 0100-410
UL/C-UL Listed UL 508, UL/C-UL Recognized UL 60950-1,
UL/C-UL Listed ANSI/ISA-12.12.01 Class I, Division 2,
Groups A, B, C, D T4 (Hazardous Location)
EN 61000-3-2

Ordering data

Type	Order No.	Pcs./Pkt.
UNO-PS/1AC/48DC/100W	2902996	1

Power supplies

UNO POWER power supplies – DC/DC converters

UNO POWER, input up to 1000 V

- Connect directly to the PV string: no need to supply an AC connection
- Robust and reliable at temperatures from -25°C to +70°C
- Can also be used in small control boxes, thanks to the compact design and high degree of efficiency
- Simplified startup, thanks to LED function monitoring



**DC/DC converter,
350 - 900 V DC, 24 V DC, 60 W**

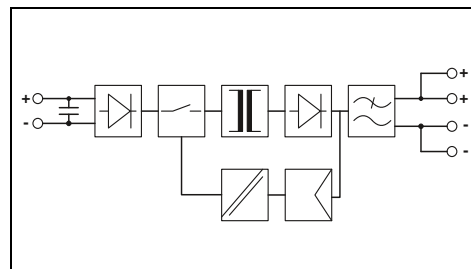

Technical data

Input data	
Nominal input voltage range	350 V DC ... 900 V DC
Input voltage range	300 V DC ... 1000 V DC
Current consumption (nominal load)	0.19 A (350 V DC) / 0.07 A (1000 V DC)
Inrush current limitation at 25°C / I _{rt}	< 1 A / < 0.38 A ² s
Output data	
Nominal output voltage (U _N)	24 V DC ±1%
Output current	2.5 A
Can be connected in parallel/series	yes, with redundancy module / No
Max. power dissipation (no load/nominal load)	< 0.5 W / < 6.5 W
Efficiency	> 90%
Residual ripple	< 20 mV _{pp}
Signaling	
Signaling DC OK	LED
General data	
Weight / Dimensions W x H x D	0.3 kg / 55 x 90 x 84 mm
Connection	alignable: 0 mm horizontally, 30 mm vertically
Connection method	Screw connection
Connection data rigid / flexible / AWG	0.2 - 2.5 mm ² / 0.2 - 2.5 mm ² / 24 - 14
Degree of protection / Protection class	IP20 / II
MTBF (IEC 61709, SN 29500)	> 1160000 h (40°C)
Ambient temperature (operation)	-25°C ... 70°C (> 55°C derating: 2.5%/K)
Standards/regulations	
Insulation voltage input/output	3 kV DC (routine test) / 8 kV DC (type test)
Electromagnetic compatibility	Conformance with EMC Directive 2014/30/EU
Electronic equipm. for electrical power installations	-
Safe isolation	DIN VDE 0100-410
UL approvals	UL 1741
Limitation of harmonic line currents	EN 61000-3-2

Ordering data

Description	Type	Order No.	Pcs./Pkt.
DC/DC converter, primary-switched	UNO-PS/350-900DC/24DC/60W	2906300	1

Power supplies and UPS

Power supplies

MINI POWER power supplies – For measurement and control technology

MINI POWER, 1 AC, 5 to 24 V DC

- Easy-to-maintain connection technology, thanks to coded COMBICON connectors
- Remote monitoring of output voltage via switching output

MINI POWER, 1 AC, ±15 V DC

- For supplying operational amplifiers

MINI POWER EX

Corresponds to standard EN 60079-15

- Mounting in a potentially explosive area in which category 3G equipment is required (zone 2).

MINI POWER, NEC Class 2

- Output power limited to 100 W:
Specifically for applications that require certification in accordance with UL 1310/508 Listed Class 2



Power supply,
1 AC, 24 V DC, 1.5 A,
DIN rail connector optional

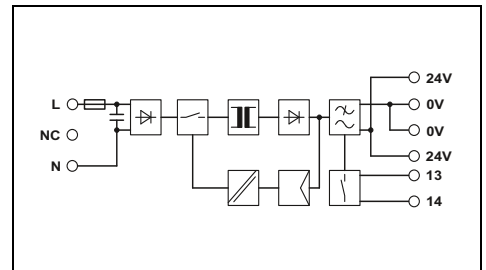

Technical data	
Input data	
Nominal input voltage range	100 V AC ... 240 V AC
Input voltage range	85 V AC ... 264 V AC
Frequency range	45 Hz ... 65 Hz
Current consumption (nominal load)	0.75 A (120 V AC) / 0.45 A (230 V AC)
Inrush current limitation at 25°C / I ² t	< 15 A / 0.6 A ² s
Mains buffering (I _h)	typ. 35 ms (120 V AC) / typ. 150 ms (230 V AC)
Output data	
Nominal output voltage (U _N)	24 V DC ±1%
Setting range of the output voltage (U _{set})	-
Output current / Power Boost	1.5 A / 2 A
Can be connected in parallel/series	Yes / No
Max. power dissipation (no load/nominal load)	1.5 W / 6.5 W
Efficiency	> 84% (for 230 V AC and nominal values)
Residual ripple	< 40 mV _{pp}
Signaling	
Signaling DC OK	LED, relay contact
General data	
Weight / Dimensions W x H x D	0.25 kg / 35 x 99 x 95 mm
Connection	alignable: horizontally 0 mm, vertically 50 mm
Connection method	Plug-in screw connection
Connection data rigid / flexible / AWG	0.2 - 2.5 mm ² / 0.2 - 2.5 mm ² / 24 - 12
Degree of protection / Protection class	IP20 / II
MTBF (IEC 61709, SN 29500)	> 2789000 h (40°C)
Ambient temperature (operation)	-25°C ... 70°C (> 60°C Derating: 2.5%/K)
Standards/regulations	
Insulation voltage input/output	3 kV (routine test) / 4 kV (type test)
Electromagnetic compatibility	Conformance with EMC Directive 2014/30/EU
Electrical safety	EN 60950-1/VDE 0805 (SELV)
Electronic equipm. for electrical power installations	EN 50178/VDE 0160 (PELV)
Safe isolation	DIN VDE 0100-410
UL approvals	UL/C-UL Listed UL 508, UL/C-UL Recognized UL 60950-1, UL ANSI/ISA-12.12.01 Class I, Division 2, Groups A, B, C, D (Hazardous Location)
Limitation of harmonic line currents	EN 61000-3-2

Ordering data		
Type	Order No.	Pcs./Pkt.
MINI-SYS-PS-100-240AC/24DC/1.5	2866983	1

Accessories		
DIN rail connector (optional), for routing through the supply voltage and data signal, two pieces are required per device		
Color: green	ME 17,5 TBUS 1,5/ 5-ST-3,81 GN	2709561 10



Power supply,
1 AC, 5 V DC, 3 A



Power supply,
1 AC, ±15 V DC, 1 A
NEC Class 2



Power supply
1 AC, 24 DC, 1.5 A
DIN rail connector optional

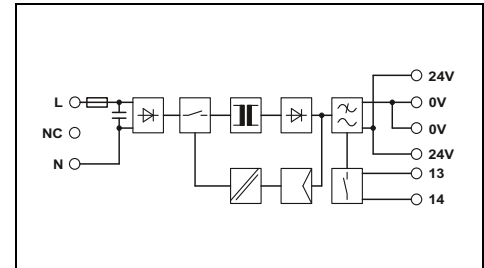
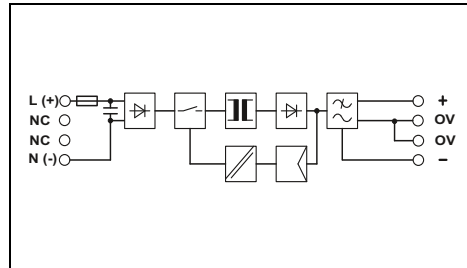
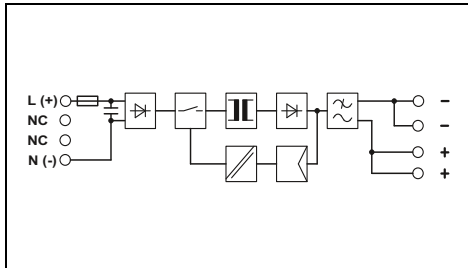

Technical data	
100 V AC ... 240 V AC	
85 V AC ... 264 V AC	
90 V DC ... 350 V DC	
45 Hz ... 65 Hz	
0.4 A (120 V AC) / 0.2 A (230 V AC)	
< 15 A / 1.5 A ² s	
typ. 30 ms (120 V AC) / typ. 140 ms (230 V AC)	
5 V DC ±1%	
4.5 V DC ... 5.5 V DC (> 5 V DC, constant capacity restricted)	
3 A / 5 A	
Yes / yes	
1 W / 5 W	
> 73% (for 230 V AC and nominal values)	
< 40 mV _{pp}	
LED	
0.17 kg / 22.5 x 99 x 107 mm	
alignable: horizontally 0 mm, vertically 50 mm	
Plug-in screw connection	
0.2 - 2.5 mm ² / 0.2 - 2.5 mm ² / 24 - 12	
IP20 / II	
> 766000 h (40°C)	
-25°C ... 70°C (> 60°C Derating: 2.5%/K)	
3 kV (routine test) / 4 kV (type test)	
Conformance with EMC Directive 2014/30/EU	
EN 60950-1/VDE 0805 (SELV)	
EN 50178/VDE 0160 (PELV)	
DIN VDE 0100-410	
UL/C-UL Listed UL 508, UL/C-UL Recognized UL 60950-1, UL ANSI/ISA-12.12.01 Class I, Division 2, Groups A, B, C, D (Hazardous Location)	
EN 61000-3-2	

Technical data	
100 V AC ... 240 V AC	
85 V AC ... 264 V AC	
90 V DC ... 350 V DC	
45 Hz ... 65 Hz	
0.6 A (120 V AC) / 0.4 A (230 V AC)	
< 35 A / 4 A ² s	
typ. 30 ms (120 V AC) / typ. 150 ms (230 V AC)	
± 15 V DC ±1%	
-	
1 A / 1.5 A	
Yes / yes	
2 W / 8 W	
> 80% (for 230 V AC and nominal values)	
< 30 mV _{pp}	
LED	
0.25 kg / 45 x 99 x 107 mm	
alignable: horizontally 0 mm, vertically 50 mm	
Plug-in screw connection	
0.2 - 2.5 mm ² / 0.2 - 2.5 mm ² / 24 - 12	
IP20 / II	
> 500000 h (40°C)	
-25°C ... 70°C (> 60°C Derating: 2.5%/K)	
3 kV (routine test) / 4 kV (type test)	
Conformance with EMC Directive 2014/30/EU	
EN 60950-1/VDE 0805 (SELV)	
EN 50178/VDE 0160 (PELV)	
DIN VDE 0100-410	
UL/C-UL Listed UL 508, UL/C-UL Recognized UL 60950-1, UL ANSI/ISA-12.12.01 Class I, Division 2, Groups A, B, C, D (Hazardous Location), NEC Class 2 as per UL 1310	
EN 61000-3-2	

Technical data	
100 V AC ... 240 V AC	
85 V AC ... 264 V AC	
45 Hz ... 65 Hz	
0.75 A (120 V AC) / 0.45 A (230 V AC)	
< 15 A / 0.6 A ² s	
typ. 35 ms (120 V AC) / typ. 150 ms (230 V AC)	
24 V DC ±1%	
-	
1.5 A / 2 A	
Yes / yes	
1.5 W / 6.5 W	
> 84% (for 230 V AC and nominal values)	
< 40 mV _{pp}	
LED, relay contact	
0.25 kg / 35 x 99 x 95 mm	
alignable: horizontally 0 mm, vertically 50 mm	
Plug-in screw connection	
0.2 - 2.5 mm ² / 0.2 - 2.5 mm ² / 24 - 12	
IP20 / II	
> 2789000 h (40°C)	
-25°C ... 70°C (> 60°C Derating: 2.5%/K)	
3 kV AC (routine test) / 4 kV AC (type test)	
Conformance with EMC Directive 2014/30/EU	
EN 60950-1/VDE 0805 (SELV)	
EN 50178/VDE 0160 (PELV)	
DIN VDE 0100-410	
UL/C-UL Listed UL 508, UL/C-UL Recognized UL 60950-1	
EN 61000-3-2	

Ordering data		
Type	Order No.	Pcs./Pkt.
MINI-PS-100-240AC/ 5DC/3	2938714	1

Ordering data		
Type	Order No.	Pcs./Pkt.
MINI-PS-100-240AC/2X15DC/1	2938743	1

Ordering data		
Type	Order No.	Pcs./Pkt.
MINI-PS-100-240AC/24DC/1.5/EX	2866653	1

Accessories	

Accessories	

Accessories	

Power supplies and UPS

Power supplies

STEP POWER power supplies – For distribution boards and flat control panels

STEP POWER, 1 AC, 24 V DC

- Flexible assembly by simply snapping the product onto the DIN rail or screwing it onto an even surface
- Energy savings, thanks to maximum energy efficiency and incredibly low no-load losses
- Wide temperature range from -25°C to +70°C
- Reliable supply, thanks to the high MTBF (mean time between failure)

STEP POWER, 24 V DC, 0.5 A

- Slim design with an overall width of just 18 mm (1 pitch)

STEP POWER, 24 V DC, 0.75 A

- Meets standard EN 60335-1 for household appliances, suitable for installation in ventilation systems, for example
- Flat design with a depth of just 43 mm

STEP POWER, 48 V AC, 0.5 A

- Connection to 48 V AC operating networks
- Slim design with an overall width of just 18 mm (1 pitch)



Power supply,
1 AC, 24 V DC, 0.5 A
NEC Class 2

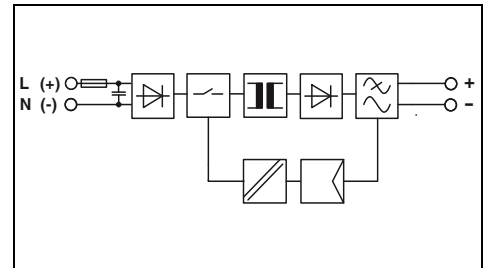

Input data	
Nominal input voltage range	100 V AC ... 240 V AC
Input voltage range	85 V AC ... 264 V AC 95 V DC ... 250 V DC
Frequency range	45 Hz ... 65 Hz / 0 Hz
Current consumption (nominal load)	0.28 A (120 V AC) / 0.13 A (230 V AC)
Inrush current limitation at 25°C / I ² t	< 15 A / < 0.1 A ² s
Mains buffering (I _N)	typ. 15 ms (120 V AC) / typ. 90 ms (230 V AC)
Output data	
Nominal output voltage (U _N)	24 V DC ±1%
Output current	0.5 A
Can be connected in parallel/series	Yes / yes
Max. power dissipation (no load/nominal load)	< 0.3 W / < 2.2 W
Efficiency	> 84% (for 230 V AC and nominal values)
Residual ripple	< 20 mV _{PP}
Signaling	
Signaling DC OK	LED
General data	
Weight / Dimensions W x H x D	0.07 kg / 18 x 90 x 61 mm
Connection	alignable: 0 mm horizontally, 30 mm vertically
Connection method	Screw connection
Connection data rigid / flexible / AWG	0.2 - 2.5 mm ² / 0.2 - 2.5 mm ² / 24 - 12
Degree of protection / Protection class	IP20 / II
MTBF (IEC 61709, SN 29500)	> 1567000 h (40°C)
Ambient temperature (operation)	-25°C ... 70°C (> 55°C derating: 2.5%/K)
Standards/regulations	
Insulation voltage input/output	3.75 kV AC (routine test) / 4 kV AC (type test)
Electromagnetic compatibility	Conformance with EMC Directive 2014/30/EU
Electrical safety	IEC 60950-1/VDE 0805 (SELV)
Electronic equipm. for electrical power installations	EN 50178/VDE 0160 (PELV)
Safe isolation	DIN VDE 0100-410
Budgetary standard	-
UL approvals	UL/C-UL Listed UL 508, UL/C-UL Recognized UL 60950-1, UL ANSI/ISA-12.12.01 Class I, Division 2, Groups A, B, C, D T4 (Hazardous Location), NEC Class 2 as per UL 1310
EN 61000-3-2	

Technical data

Technical data		
100 V AC ... 240 V AC		
85 V AC ... 264 V AC		
95 V DC ... 250 V DC		
45 Hz ... 65 Hz / 0 Hz		
0.28 A (120 V AC) / 0.13 A (230 V AC)		
< 15 A / < 0.1 A ² s		
typ. 15 ms (120 V AC) / typ. 90 ms (230 V AC)		
24 V DC ±1%		
0.5 A		
Yes / yes		
< 0.3 W / < 2.2 W		
> 84% (for 230 V AC and nominal values)		
< 20 mV _{PP}		
LED		
0.07 kg / 18 x 90 x 61 mm		
alignable: 0 mm horizontally, 30 mm vertically		
Screw connection		
0.2 - 2.5 mm ² / 0.2 - 2.5 mm ² / 24 - 12		
IP20 / II		
> 1567000 h (40°C)		
-25°C ... 70°C (> 55°C derating: 2.5%/K)		
3.75 kV AC (routine test) / 4 kV AC (type test)		
Conformance with EMC Directive 2014/30/EU		
IEC 60950-1/VDE 0805 (SELV)		
EN 50178/VDE 0160 (PELV)		
DIN VDE 0100-410		
-		
UL/C-UL Listed UL 508, UL/C-UL Recognized UL 60950-1, UL ANSI/ISA-12.12.01 Class I, Division 2, Groups A, B, C, D T4 (Hazardous Location), NEC Class 2 as per UL 1310		
EN 61000-3-2		

Limitation of harmonic line currents

Ordering data

Description	Power supply, primary-switched
-------------	---------------------------------------

Type	Order No.	Pcs./Pkt.
STEP-PS/ 1AC/24DC/0.5	2868596	1



Power supply,
1 AC, 24 V DC, 0.75 A
flat design, NEC Class 2

UL US ENEC ClassNK CB
Ex:



Power supply,
1 AC, 24 V DC, 0.75 A
NEC Class 2

UL US ENEC ClassNK CB
Ex:



Power supply,
48 V AC, 24 V DC, 0.5 A
NEC Class 2

UL US ENEC CB

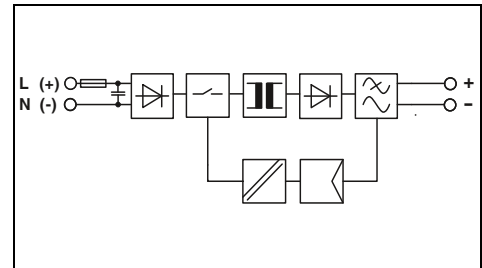
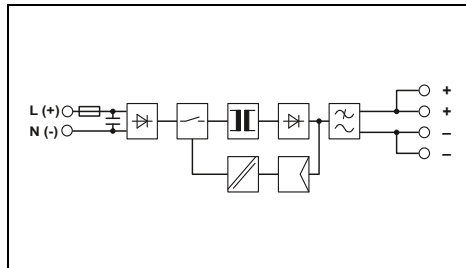
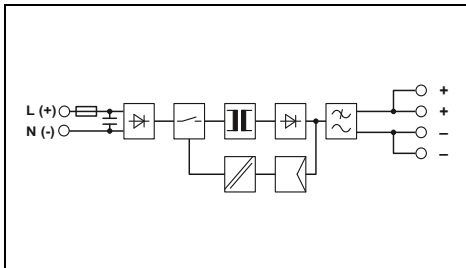

Technical data

100 V AC ... 240 V AC
85 V AC ... 264 V AC
95 V DC ... 250 V DC
45 Hz ... 65 Hz / 0 Hz
0.3 A (120 V AC) / 0.25 A (230 V AC)
< 15 A / < 0.1 A²s
typ. 15 ms (120 V AC) / typ. 70 ms (230 V AC)

24 V DC ±1%
0.75 A
Yes / yes
< 0.5 W / < 3.6 W
> 84% (for 230 V AC and nominal values)
< 75 mV_{pp}

LED

0.11 kg / 36 x 90 x 43 mm
alignable: 0 mm horizontally, 30 mm vertically
Screw connection
0.2 - 2.5 mm² / 0.2 - 2.5 mm² / 24 - 12
IP20 / II
> 926000 h (40°C)
-25°C ... 70°C (> 55°C derating: 2.5%/K)

3.75 kV AC (routine test) / 4 kV AC (type test)
Conformance with EMC Directive 2014/30/EU
IEC 60950-1/VDE 0805 (SELV)
EN 50178/VDE 0160 (PELV)
DIN VDE 0100-410
IEC 60335-1
UL/C-UL Listed UL 508, UL/C-UL Recognized UL 60950-1,
UL ANSI/ISA-12.12.01 Class I, Division 2, Groups A, B, C, D T4
(Hazardous Location), NEC Class 2 as per UL 1310
EN 61000-3-2

Ordering data

Type	Order No.	Pcs./Pkt.
STEP-PS/1AC/24DC/0.75/FL	2868622	1

Technical data

100 V AC ... 240 V AC
85 V AC ... 264 V AC
95 V DC ... 250 V DC
45 Hz ... 65 Hz / 0 Hz
0.3 A (120 V AC) / 0.2 A (230 V AC)
< 15 A / < 0.1 A²s
typ. 15 ms (120 V AC) / typ. 70 ms (230 V AC)

24 V DC ±1%
0.75 A
Yes / yes
0.5 W / 3.6 W
> 84% (for 230 V AC and nominal values)
< 75 mV_{pp}

LED

0.11 kg / 36 x 90 x 61 mm
alignable: 0 mm horizontally, 30 mm vertically
Screw connection
0.2 - 2.5 mm² / 0.2 - 2.5 mm² / 24 - 12
IP20 / II
> 926000 h (40°C)
-25°C ... 70°C (> 55°C derating: 2.5%/K)

3.75 kV AC (routine test) / 4 kV AC (type test)
Conformance with EMC Directive 2014/30/EU
IEC 60950-1/VDE 0805 (SELV)
EN 50178/VDE 0160 (PELV)
DIN VDE 0100-410
IEC 60335-1
UL/C-UL Listed UL 508, UL/C-UL Recognized UL 60950-1,
UL ANSI/ISA-12.12.01 Class I, Division 2, Groups A, B, C, D T4
(Hazardous Location), NEC Class 2 as per UL 1310
EN 61000-3-2

Ordering data

Type	Order No.	Pcs./Pkt.
STEP-PS/1AC/24DC/0.75	2868635	1

Technical data

48 V AC
43 V AC ... 52 V AC
60 V DC ... 80 V DC
45 Hz ... 65 Hz / 0 Hz
0.5 A (43 V AC) / 0.45 A (48 V AC)
< 10 A / < 0.1 A²s
typ. 15 ms (48 V AC) / typ. 20 ms (52 V AC)

24 V DC ±1%
0.5 A
Yes / yes
< 0.3 W / < 3.4 W
> 81% (for 48 V AC and nominal values)
< 30 mV_{pp}

LED

0.07 kg / 18 x 90 x 61 mm
alignable: 0 mm horizontally, 30 mm vertically
Screw connection
0.2 - 2.5 mm² / 0.2 - 2.5 mm² / 24 - 12
IP20 / II
> 1860000 h (40°C)
-25°C ... 70°C (> 55°C Derating: 2.5%/K)

3.75 kV AC (routine test) / 4 kV AC (type test)
Conformance with EMC Directive 2014/30/EU
IEC 60950-1/VDE 0805 (SELV)
EN 50178/VDE 0160 (PELV)
DIN VDE 0100-410
-
UL/C-UL Listed UL 508, UL/C-UL Recognized UL 60950-1,
NEC Class 2 as per UL 1310
EN 61000-3-2

Ordering data

Type	Order No.	Pcs./Pkt.
STEP-PS/48AC/24DC/0.5	2868716	1

Power supplies and UPS

Power supplies

STEP POWER power supplies – For distribution boards and flat control panels

STEP POWER, 1 AC, 24 V DC

- Flexible assembly by simply snapping the product onto the DIN rail or screwing it onto an even surface
- Energy savings, thanks to maximum energy efficiency and incredibly low no-load losses
- Wide temperature range from -25°C to +70°C
- Reliable supply, thanks to the high MTBF (mean time between failure)

STEP POWER, NEC Class 2

- Output power limited to 100 W:
Specifically for applications that require certification in accordance with UL 1310/508 Listed Class 2



Power supply,
1 AC, 24 V DC, 1.75 A
NEC Class 2



Power supply,
1 AC, 24 V DC, 2.5 A
NEC Class 2

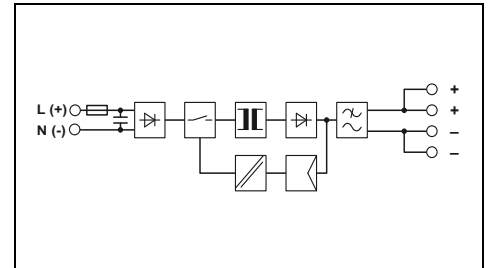
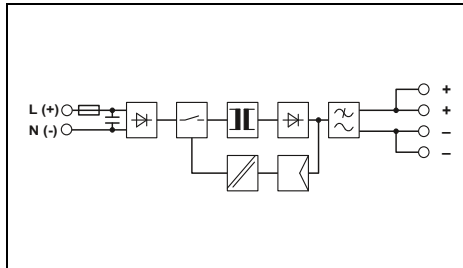

Technical data

Input data	
Nominal input voltage range	100 V AC ... 240 V AC
Input voltage range	85 V AC ... 264 V AC 95 V DC ... 250 V DC
Frequency range	
Current consumption (nominal load)	45 Hz ... 65 Hz / 0 Hz
Inrush current limitation at 25°C / I ² t	0.6 A (120 V AC) / 0.3 A (230 V AC)
Mains buffering (I _N)	< 15 A / < 0.6 A ² s
Output data	
Nominal output voltage (U _N)	24 V DC ±1%
Setting range of the output voltage (U _{set})	22.5 V DC ... 29.5 V DC (> 24 V DC, constant capacity restricted)
Output current	
Can be connected in parallel/series	1.75 A
Max. power dissipation (no load/nominal load)	Yes / yes
Efficiency	< 0.7 W / 5 W
Residual ripple	> 89% (for 230 V AC and nominal values)
Signaling	< 60 mV _{pp}
Signaling DC OK	LED
General data	
Weight / Dimensions W x H x D	0.19 kg / 54 x 90 x 61 mm
Connection	alignable: 0 mm horizontally, 30 mm vertically
Connection method	Screw connection
Connection data rigid / flexible / AWG	0.2 - 2.5 mm ² / 0.2 - 2.5 mm ² / 24 - 12
Degree of protection / Protection class	IP20 / II
MTBF (IEC 61709, SN 29500)	> 1569000 h (40°C)
Ambient temperature (operation)	-25°C ... 70°C (> 55°C derating: 2.5%/K)
Standards/regulations	
Insulation voltage input/output	3.75 kV AC (routine test) / 4 kV AC (type test)
Electromagnetic compatibility	Conformance with EMC Directive 2014/30/EU
Electrical safety	IEC 60950-1/VDE 0805 (SELV)
Electronic equipm. for electrical power installations	EN 50178/VDE 0160 (PELV)
Safe isolation	DIN VDE 0100-410
UL approvals	UL/C-UL Listed UL 508, UL/C-UL Recognized UL 60950-1, UL ANSI/ISA-12.12.01 Class I, Division 2, Groups A, B, C, D T4A (Hazardous Location), NEC Class 2 as per UL 1310
Limitation of harmonic line currents	
EN 61000-3-2	

Ordering data

Description	Type	Order No.	Pcs./Pkt.
Power supply, primary-switched	STEP-PS/ 1AC/24DC/1.75	2868648	1

Technical data

Input data	
Nominal input voltage range	100 V AC ... 240 V AC
Input voltage range	85 V AC ... 264 V AC 95 V DC ... 250 V DC
Frequency range	
Current consumption (nominal load)	45 Hz ... 65 Hz / 0 Hz
Inrush current limitation at 25°C / I ² t	0.8 A (120 V AC) / 0.4 A (230 V AC)
Mains buffering (I _N)	< 15 A / < 0.6 A ² s
Output data	
Nominal output voltage (U _N)	24 V DC ±1%
Setting range of the output voltage (U _{set})	22.5 V DC ... 29.5 V DC (> 24 V DC, constant capacity restricted)
Output current	
Can be connected in parallel/series	2.5 A
Max. power dissipation (no load/nominal load)	Yes / yes
Efficiency	< 0.7 W / 9.9 W
Residual ripple	> 86% (for 230 V AC and nominal values)
Signaling	< 80 mV _{pp}
Signaling DC OK	LED
General data	
Weight / Dimensions W x H x D	0.27 kg / 72 x 90 x 61 mm
Connection	alignable: 0 mm horizontally, 30 mm vertically
Connection method	Screw connection
Connection data rigid / flexible / AWG	0.2 - 2.5 mm ² / 0.2 - 2.5 mm ² / 24 - 12
Degree of protection / Protection class	IP20 / II
MTBF (IEC 61709, SN 29500)	> 1061000 h (40°C)
Ambient temperature (operation)	-25°C ... 70°C (> 55°C derating: 2.5%/K)
Standards/regulations	
Insulation voltage input/output	3.75 kV AC (routine test) / 4 kV AC (type test)
Electromagnetic compatibility	Conformance with EMC Directive 2014/30/EU
Electrical safety	IEC 60950-1/VDE 0805 (SELV)
Electronic equipm. for electrical power installations	EN 50178/VDE 0160 (PELV)
Safe isolation	DIN VDE 0100-410
UL approvals	UL/C-UL Listed UL 508, UL/C-UL Recognized UL 60950-1, UL ANSI/ISA-12.12.01 Class I, Division 2, Groups A, B, C, D T3C (Hazardous Location), NEC Class 2 as per UL 1310
Limitation of harmonic line currents	
EN 61000-3-2	

Ordering data

Description	Type	Order No.	Pcs./Pkt.
Power supply, primary-switched	STEP-PS/ 1AC/24DC/2.5	2868651	1

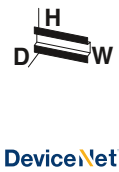

Power supply,
1 AC, 24 V DC, 100 W
NEC Class 2



Power supply,
1 AC, 24 V DC, 4.2 A



Power supply,
1 AC, 24 V DC, 3.5 A
Input up to 277 V AC, NEC Class 2

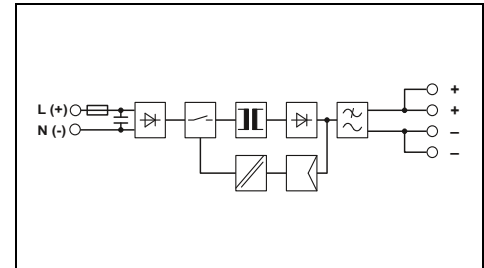
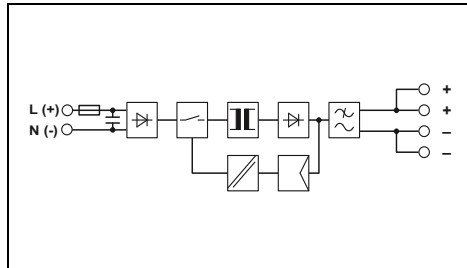
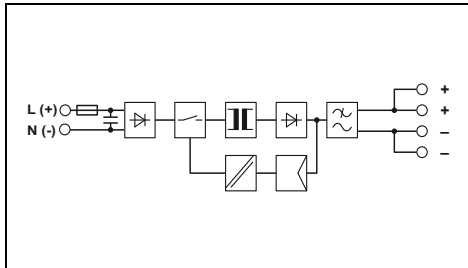

Technical data

Technical data

Technical data

100 V AC ... 240 V AC
85 V AC ... 264 V AC
95 V DC ... 250 V DC
45 Hz ... 65 Hz
1.3 A (120 V AC) / 0.8 A (230 V AC)
< 15 A / < 1 A²s
typ. 25 ms (120 V AC) / typ. 120 ms (230 V AC)

100 V AC ... 240 V AC
85 V AC ... 264 V AC
95 V DC ... 250 V DC
45 Hz ... 65 Hz / 0 Hz
1.3 A (120 V AC) / 0.8 A (230 V AC)
< 15 A / < 1 A²s
typ. 20 ms (120 V AC) / typ. 100 ms (230 V AC)

100 V AC ... 277 V AC
85 V AC ... 305 V AC
95 V DC ... 250 V DC
45 Hz ... 65 Hz / 0 Hz
1.43 A (120 V AC) / 0.75 A (277 V AC)
< 40 A / < 2.8 A²s
typ. 25 ms (120 V AC) / typ. 160 ms (277 V AC)

24 V DC ±1%
22.5 V DC ... 25 V DC (> 24 V DC, constant capacity restricted)

24 V DC ±1%
22.5 V DC ... 29.5 V DC (> 24 V DC, constant capacity restricted)

24 V DC ±1%
22.5 V DC ... 25 V DC (> 24 V DC, constant capacity restricted)

3.8 A
No / No
< 0.7 W / 11.8 W
> 88% (for 230 V AC and nominal values)
< 80 mV_{pp}

4.2 A
Yes / yes
< 0.7 W / 13.2 W
> 88% (for 230 V AC and nominal values)
< 40 mV_{pp}

3.5 A
Yes / yes
< 0.6 W / 11.5 W
> 88% (for 277 V AC and nominal values)
< 10 mV_{pp}

LED

LED

LED

0.33 kg / 90 x 90 x 61 mm
alignable: 0 mm horizontally, 30 mm vertically
Screw connection
0.2 - 2.5 mm² / 0.2 - 2.5 mm² / 24 - 12
IP20 / II
> 897000 h (40°C)
-25°C ... 70°C (> 55°C derating: 2.5%/K)

0.33 kg / 90 x 90 x 61 mm
alignable: 0 mm horizontally, 30 mm vertically
Screw connection
0.2 - 2.5 mm² / 0.2 - 2.5 mm² / 24 - 12
IP20 / II
> 897000 h (40°C)
-25°C ... 70°C (> 55°C derating: 2.5%/K)

0.3 kg / 90 x 90 x 61 mm
alignable: 0 mm horizontally, 30 mm vertically
Screw connection
0.2 - 2.5 mm² / 0.2 - 2.5 mm² / 24 - 12
IP20 / II
> 1094000 h (40°C)
-25°C ... 70°C (> 55°C derating: 2.5%/K)

3.75 kV AC (routine test) / 4 kV AC (type test)
Conformance with EMC Directive 2014/30/EU
IEC 60950-1/VDE 0805 (SELV)
EN 50178/VDE 0160 (PELV)
DIN VDE 0100-410
UL/C-UL Listed UL 508, UL/C-UL Recognized UL 60950-1,
UL ANSI/ISA-12.12.01 Class I, Division 2, Groups A, B, C, D T4A
(Hazardous Location), NEC Class 2 as per UL 1310
EN 61000-3-2

3.75 kV AC (routine test) / 4 kV AC (type test)
Conformance with EMC Directive 2014/30/EU
IEC 60950-1/VDE 0805 (SELV)
EN 50178/VDE 0160 (PELV)
DIN VDE 0100-410
UL/C-UL Listed UL 508, UL/C-UL Recognized UL 60950-1,
UL ANSI/ISA-12.12.01 Class I, Division 2, Groups A, B, C, D T4A
(Hazardous Location)
EN 61000-3-2

3.75 kV AC (routine test) / 4 kV AC (type test)
Conformance with EMC Directive 2014/30/EU
IEC 60950-1/VDE 0805 (SELV)
EN 50178/VDE 0160 (PELV)
DIN VDE 0100-410
UL/C-UL Listed UL 508, UL/C-UL Recognized UL 60950-1,
NEC Class 2 as per UL 1310
EN 61000-3-2

Ordering data

Ordering data

Ordering data

Type	Order No.	Pcs./Pkt.
STEP-PS/ 1AC/24DC/3.8C2LPS	2868677	1

Type	Order No.	Pcs./Pkt.
STEP-PS/ 1AC/24DC/4.2	2868664	1

Type	Order No.	Pcs./Pkt.
STEP-PS/277AC/24DC/3.5	2904945	1

Power supplies and UPS

Power supplies

STEP POWER power supplies – For distribution boards and flat control panels

STEP POWER, 1 AC, 5 to 48 V DC

- Flexible assembly by simply snapping the product onto the DIN rail or screwing it onto an even surface
- Energy savings, thanks to maximum energy efficiency and incredibly low no-load losses
- Wide temperature range from -25°C to +70°C
- Reliable supply, thanks to the high MTBF (mean time between failure)

STEP POWER, 5 V DC, 2 A

- Slim design with an overall width of just 18 mm (1 pitch)

STEP POWER, 5 V DC, 6.5 A

- Adjustable output voltage of 4 to 6.5 V DC

STEP POWER, 15 V DC, 4 A

- Adjustable output voltage of 10 to 16.5 V DC

STEP POWER, 48 V DC, 2 A

- Adjustable output voltage of 30 to 56 V DC



Power supply,
1 AC, 5 V DC, 2 A
NEC Class 2

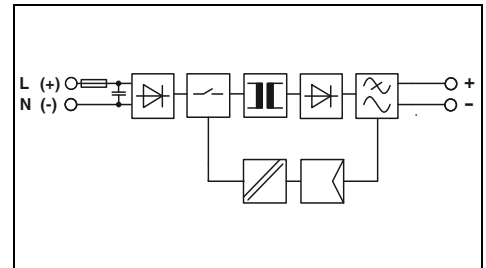

Technical data

Input data	
Nominal input voltage range	100 V AC ... 240 V AC
Input voltage range	85 V AC ... 264 V AC 95 V DC ... 250 V DC
Frequency range	45 Hz ... 65 Hz / 0 Hz
Current consumption (nominal load)	0.2 A (120 V AC) / 0.13 A (230 V AC)
Inrush current limitation at 25°C / I ² t	< 15 A / < 0.1 A ² s
Mains buffering (I _N)	typ. 25 ms (120 V AC) / typ. 110 ms (230 V AC)
Output data	
Nominal output voltage (U _N)	5 V DC ±1%
Setting range of the output voltage (U _{set})	-
Output current	2 A
Can be connected in parallel/series	Yes / yes
Max. power dissipation (no load/nominal load)	< 0.4 W / < 2.6 W
Efficiency	> 81% (for 230 V AC and nominal values)
Residual ripple	< 50 mV _{pp}
Signaling	
Signaling DC OK	LED
General data	
Weight / Dimensions W x H x D	0.1 kg / 18 x 90 x 61 mm
Connection	alignable: 0 mm horizontally, 30 mm vertically
Connection method	Screw connection
Connection data rigid / flexible / AWG	0.2 - 2.5 mm ² / 0.2 - 2.5 mm ² / 24 - 12
Degree of protection / Protection class	IP20 / II
MTBF (IEC 61709, SN 29500)	> 1812000 h (40°C)
Ambient temperature (operation)	-25°C ... 70°C (> 55°C derating: 2.5%/K)
Standards/regulations	
Insulation voltage input/output	3.75 kV AC (routine test) / 4 kV AC (type test)
Electromagnetic compatibility	Conformance with EMC Directive 2014/30/EU
Electrical safety	IEC 60950-1/VDE 0805 (SELV)
Electronic equipm. for electrical power installations	EN 50178/VDE 0160 (PELV)
Safe isolation	DIN VDE 0100-410
UL approvals	UL/C-UL Listed UL 508, UL/C-UL Recognized UL 60950-1, NEC Class 2 as per UL 1310
Limitation of harmonic line currents	EN 61000-3-2

Ordering data

Description	Type	Order No.	Pcs./Pkt.
Power supply, primary-switched, 1-phase	STEP-PS/ 1AC/ 5DC/2	2320513	1



Power supply,
1 AC, 5 V DC, 6.5 A

UL US ENEC ClassNK CB
Ex:



Power supply,
1 AC, 15 V DC, 4 A

UL US ENEC ClassNK CB
Ex:



Power supply,
1 AC, 48 V DC, 2 A

UL US ENEC ClassNK CB
Ex:

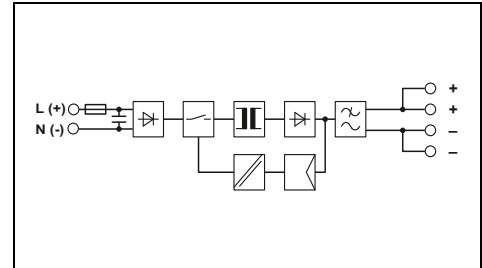
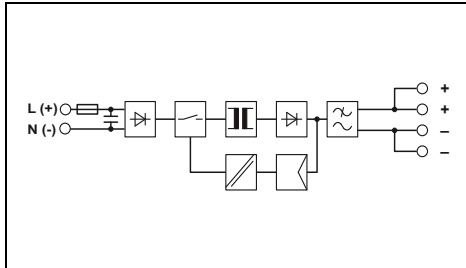
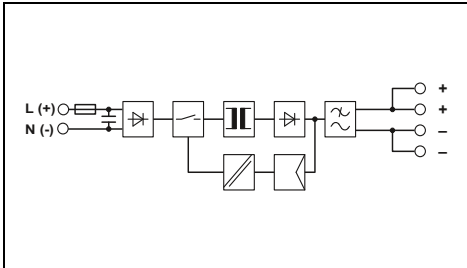

Technical data

100 V AC ... 240 V AC
85 V AC ... 264 V AC
95 V DC ... 250 V DC
45 Hz ... 65 Hz / 0 Hz
0.5 A (120 V AC) / 0.3 A (230 V AC)
< 15 A / < 0.6 A²s
typ. 25 ms (120 V AC) / typ. 140 ms (230 V AC)

5 V DC ±1%
4 V DC ... 6.5 V DC (> 5 V DC, constant capacity restricted)

6.5 A
Yes / yes
< 0.4 W / 8.1 W
> 80% (for 230 V AC and nominal values)
< 50 mV_{pp}

LED

0.27 kg / 72 x 90 x 61 mm
alignable: 0 mm horizontally, 30 mm vertically
Screw connection
0.2 - 2.5 mm² / 0.2 - 2.5 mm² / 24 - 12
IP20 / II
> 1111000 h (40°C)
-25°C ... 70°C (> 55°C derating: 2.5%/K)

3.75 kV AC (routine test) / 4 kV AC (type test)
Conformance with EMC Directive 2014/30/EU
IEC 60950-1/VDE 0805 (SELV)
EN 50178/VDE 0160 (PELV)
DIN VDE 0100-410
UL/C-UL Listed UL 508, UL/C-UL Recognized UL 60950-1,
UL ANSI/ISA-12.12.01 Class I, Division 2, Groups A, B, C, D T4A
(Hazardous Location)
EN 61000-3-2

Ordering data

Type	Order No.	Pcs./Pkt.
STEP-PS/ 1AC/ 5DC/6.5	2868541	1

Technical data

100 V AC ... 240 V AC
85 V AC ... 264 V AC
95 V DC ... 250 V DC
45 Hz ... 65 Hz / 0 Hz
0.8 A (120 V AC) / 0.5 A (230 V AC)
< 15 A / < 0.6 A²s
typ. 27 ms (120 V AC) / typ. 120 ms (230 V AC)

15 V DC ±1%
10 V DC ... 16.5 V DC (> 15 V DC, constant capacity restricted)

4 A
Yes / yes
< 0.5 W / 8.6 W
> 87% (for 230 V AC and nominal values)
< 55 mV_{pp}

LED

0.27 kg / 72 x 90 x 61 mm
alignable: 0 mm horizontally, 30 mm vertically
Screw connection
0.2 - 2.5 mm² / 0.2 - 2.5 mm² / 24 - 12
IP20 / II
> 1134000 h (40°C)
-25°C ... 70°C (> 55°C derating: 2.5%/K)

3.75 kV AC (routine test) / 4 kV AC (type test)
Conformance with EMC Directive 2014/30/EU
IEC 60950-1/VDE 0805 (SELV)
EN 50178/VDE 0160 (PELV)
DIN VDE 0100-410
UL/C-UL Listed UL 508, UL/C-UL Recognized UL 60950-1,
UL ANSI/ISA-12.12.01 Class I, Division 2, Groups A, B, C, D T3C
(Hazardous Location)
EN 61000-3-2

Ordering data

Type	Order No.	Pcs./Pkt.
STEP-PS/ 1AC/15DC/4	2868619	1

Technical data

100 V AC ... 240 V AC
85 V AC ... 264 V AC
95 V DC ... 250 V DC
45 Hz ... 65 Hz / 0 Hz
1.3 A (120 V AC) / 0.8 A (230 V AC)
< 15 A / < 1.4 A²s
typ. 20 ms (120 V AC) / typ. 120 ms (230 V AC)

48 V DC ±1%
30 V DC ... 56 V DC (> 48 V DC, constant capacity restricted)

2 A
Yes / yes
< 0.9 W / 9.6 W
> 90% (for 230 V AC and nominal values)
< 30 mV_{pp}

LED

0.33 kg / 90 x 90 x 61 mm
alignable: 0 mm horizontally, 30 mm vertically
Screw connection
0.2 - 2.5 mm² / 0.2 - 2.5 mm² / 24 - 12
IP20 / II
> 1048000 h (40°C)
-25°C ... 70°C (> 55°C derating: 2.5%/K)

3.75 kV AC (routine test) / 4 kV AC (type test)
Conformance with EMC Directive 2014/30/EU
IEC 60950-1/VDE 0805 (SELV)
EN 50178/VDE 0160 (PELV)
DIN VDE 0100-410
UL/C-UL Listed UL 508, UL/C-UL Recognized UL 60950-1,
UL ANSI/ISA-12.12.01 Class I, Division 2, Groups A, B, C, D T3C
(Hazardous Location)
EN 61000-3-2

Ordering data

Type	Order No.	Pcs./Pkt.
STEP-PS/ 1AC/48DC/2	2868680	1

Power supplies and UPS

Power supplies

STEP POWER power supplies – For distribution boards and flat control panels

STEP POWER, 1 AC, 12 V DC

- Flexible assembly by simply snapping the product onto the DIN rail or screwing it onto an even surface
- Energy savings, thanks to maximum energy efficiency and incredibly low no-load losses
- Wide temperature range from -25°C to +70°C
- Reliable supply, thanks to the high MTBF (mean time between failure)

STEP POWER, 12 V DC, 1.5 A

- Meets standard EN 60335-1 for household appliances, suitable for installation in ventilation systems, for example



Power supply,
1 AC, 12 V DC, 1 A
NEC Class 2



Power supply,
1 AC, 12 V DC, 1.5 A
Flat design, NEC Class 2

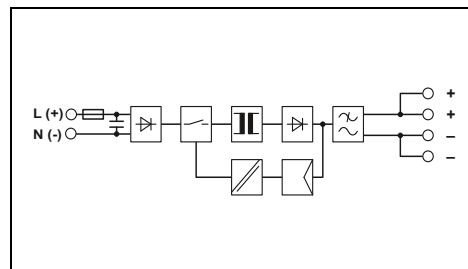
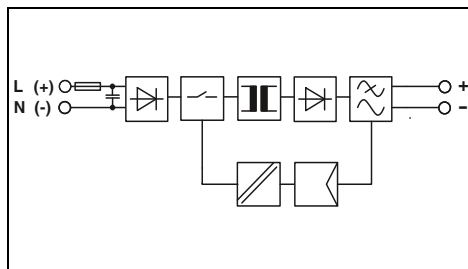

Technical data

Input data
Nominal input voltage range
Input voltage range
Frequency range
Current consumption (nominal load)
Inrush current limitation at 25°C / I _{pt}
Mains buffering (I _N)
Output data
Nominal output voltage (U _N)
Setting range of the output voltage (U _{set})
Output current
Can be connected in parallel/series
Max. power dissipation (no load/nominal load)
Efficiency
Residual ripple
Signaling
Signaling DC OK
General data
Weight / Dimensions W x H x D
Connection
Connection method
Connection data rigid / flexible / AWG
Degree of protection / Protection class
MTBF (IEC 61709, SN 29500)
Ambient temperature (operation)
Standards/regulations
Insulation voltage input/output
Electromagnetic compatibility
Electrical safety
Electronic equipm. for electrical power installations
Safe isolation
Budgetary standard
UL approvals
Limitation of harmonic line currents

100 V AC ... 240 V AC
85 V AC ... 264 V AC
95 V DC ... 250 V DC
45 Hz ... 65 Hz / 0 Hz
0.26 A (120 V AC) / 0.13 A (230 V AC)
< 15 A / < 0.1 A ² s
typ. 15 ms (120 V AC) / typ. 90 ms (230 V AC)
12 V DC ±1%
-
1 A
Yes / yes
< 0.4 W / < 2.8 W
> 83% (for 230 V AC and nominal values)
< 20 mV _{pp}
LED
0.07 kg / 18 x 90 x 61 mm
alignable: 0 mm horizontally, 30 mm vertically
Screw connection
0.2 - 2.5 mm ² / 0.2 - 2.5 mm ² / 24 - 12
IP20 / II
> 1478000 h (40°C)
-25°C ... 70°C (> 55°C derating: 2.5%/K)
3.75 kV AC (routine test) / 4 kV AC (type test)
Conformance with EMC Directive 2014/30/EU
IEC 60950-1/VDE 0805 (SELV)
EN 50178/VDE 0160 (PELV)
DIN VDE 0100-410
-
UL/C-UL Listed UL 508, UL/C-UL Recognized UL 60950-1, UL ANSI/ISA-12.12.01 Class I, Division 2, Groups A, B, C, D T4 (Hazardous Location), NEC Class 2 as per UL 1310
EN 61000-3-2

Ordering data

Description
Power supply, primary-switched

Type	Order No.	Pcs./Pkt.
STEP-PS/ 1AC/12DC/1	2868538	1

Technical data

100 V AC ... 240 V AC
85 V AC ... 264 V AC
95 V DC ... 250 V DC
45 Hz ... 65 Hz / 0 Hz
0.33 A (120 V AC) / 0.18 A (230 V AC)
< 15 A / < 0.1 A ² s
typ. 15 ms (120 V AC) / typ. 70 ms (230 V AC)
12 V DC ±1%
-
1.5 A
Yes / yes
< 0.4 W / < 3.2 W
> 84% (for 230 V AC and nominal values)
< 75 mV _{pp}
LED
0.07 kg / 36 x 90 x 43 mm
alignable: 0 mm horizontally, 30 mm vertically
Screw connection
0.2 - 2.5 mm ² / 0.2 - 2.5 mm ² / 24 - 12
IP20 / II
> 1800000 h (40°C)
-25°C ... 70°C (> 55°C derating: 2.5%/K)
3.75 kV AC (routine test) / 4 kV AC (type test)
Conformance with EMC Directive 2014/30/EU
IEC 60950-1/VDE 0805 (SELV)
EN 50178/VDE 0160 (PELV)
DIN VDE 0100-410
IEC 60335-1
UL/C-UL Listed UL 508, UL/C-UL Recognized UL 60950-1, UL ANSI/ISA-12.12.01 Class I, Division 2, Groups A, B, C, D T4 (Hazardous Location), NEC Class 2 as per UL 1310
EN 61000-3-2

Ordering data

Type	Order No.	Pcs./Pkt.
STEP-PS/ 1AC/12DC/1.5/FL	2868554	1



Power supply,
1 AC, 12 V DC, 1.5 A
NEC Class 2

UL c ENEC EUC ERE ClassNK CB
Ex:



Power supply,
1 AC, 12 V DC, 3 A
NEC Class 2

UL c ENEC EUC ERE ClassNK CB
Ex:



Power supply,
1 AC, 12 V DC, 5 A

UL c ENEC EUC ERE ClassNK CB
Ex:

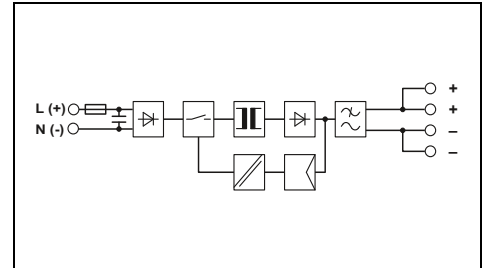
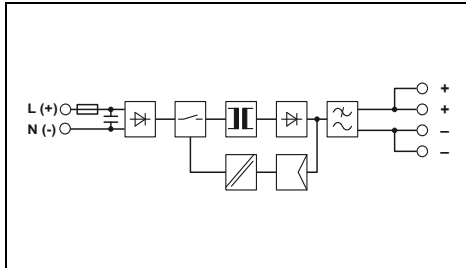
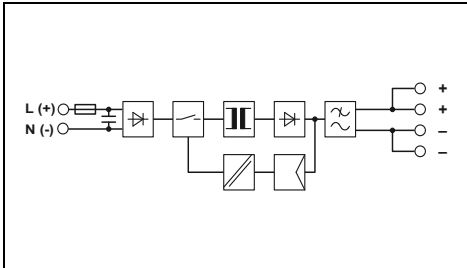

Technical data

100 V AC ... 240 V AC
85 V AC ... 264 V AC
95 V DC ... 250 V DC
45 Hz ... 65 Hz / 0 Hz
0.3 A (120 V AC) / 0.2 A (230 V AC)
< 15 A / < 0.1 A²s
typ. 15 ms (120 V AC) / typ. 70 ms (230 V AC)

12 V DC ±1%
-

1.5 A
Yes / yes
< 0.4 W / < 3.2 W
> 84% (for 230 V AC and nominal values)
< 75 mV_{pp}

LED

0.11 kg / 36 x 90 x 61 mm
alignable: 0 mm horizontally, 30 mm vertically
Screw connection
0.2 - 2.5 mm² / 0.2 - 2.5 mm² / 24 - 12
IP20 / II
> 1800000 h (40°C)
-25°C ... 70°C (> 55°C derating: 2.5%/K)

3.75 kV AC (routine test) / 4 kV AC (type test)
Conformance with EMC Directive 2014/30/EU
IEC 60950-1/VDE 0805 (SELV)
EN 50178/VDE 0160 (PELV)
DIN VDE 0100-410
IEC 60335-1
UL/C-UL Listed UL 508, UL/C-UL Recognized UL 60950-1,
UL ANSI/ISA-12.12.01 Class I, Division 2, Groups A, B, C, D T4
(Hazardous Location), NEC Class 2 as per UL 1310
EN 61000-3-2

Ordering data

Type	Order No.	Pcs./Pkt.
STEP-PS/ 1AC/12DC/1.5	2868567	1

Technical data

100 V AC ... 240 V AC
85 V AC ... 264 V AC
95 V DC ... 250 V DC
45 Hz ... 65 Hz / 0 Hz
0.6 A (120 V AC) / 0.3 A (230 V AC)
< 15 A / < 0.6 A²s
typ. 26 ms (120 V AC) / typ. 160 ms (230 V AC)

12 V DC ±1%
10 V DC ... 16.5 V DC (> 12 V DC, constant capacity restricted)

3 A
Yes / yes
< 0.5 W / 6.4 W
> 85% (for 230 V AC and nominal values)
< 40 mV_{pp}

LED

0.19 kg / 54 x 90 x 61 mm
alignable: 0 mm horizontally, 30 mm vertically
Screw connection
0.2 - 2.5 mm² / 0.2 - 2.5 mm² / 24 - 12
IP20 / II
> 1689000 h (40°C)
-25°C ... 70°C (> 55°C derating: 2.5%/K)

3.75 kV AC (routine test) / 4 kV AC (type test)
Conformance with EMC Directive 2014/30/EU
IEC 60950-1/VDE 0805 (SELV)
EN 50178/VDE 0160 (PELV)
DIN VDE 0100-410
-
UL/C-UL Listed UL 508, UL/C-UL Recognized UL 60950-1,
UL ANSI/ISA-12.12.01 Class I, Division 2, Groups A, B, C, D T4
(Hazardous Location), NEC Class 2 as per UL 1310
EN 61000-3-2

Ordering data

Type	Order No.	Pcs./Pkt.
STEP-PS/ 1AC/12DC/3	2868570	1

Technical data

100 V AC ... 240 V AC
85 V AC ... 264 V AC
95 V DC ... 250 V DC
45 Hz ... 65 Hz / 0 Hz
0.8 A (120 V AC) / 0.5 A (230 V AC)
< 15 A / < 0.6 A²s
typ. 27 ms (120 V AC) / typ. 120 ms (230 V AC)

12 V DC ±1%
10 V DC ... 16.5 V DC (> 12 V DC, constant capacity restricted)

5 A
Yes / yes
< 0.5 W / 8.6 W
> 87% (for 230 V AC and nominal values)
< 55 mV_{pp}

LED

0.27 kg / 72 x 90 x 61 mm
alignable: 0 mm horizontally, 30 mm vertically
Screw connection
0.2 - 2.5 mm² / 0.2 - 2.5 mm² / 24 - 12
IP20 / II
> 1134000 h (40°C)
-25°C ... 70°C (> 55°C derating: 2.5%/K)

3.75 kV AC (routine test) / 4 kV AC (type test)
Conformance with EMC Directive 2014/30/EU
IEC 60950-1/VDE 0805 (SELV)
EN 50178/VDE 0160 (PELV)
DIN VDE 0100-410
-
UL/C-UL Listed UL 508, UL/C-UL Recognized UL 60950-1,
UL ANSI/ISA-12.12.01 Class I, Division 2, Groups A, B, C, D T3C
(Hazardous Location)
EN 61000-3-2

Ordering data

Type	Order No.	Pcs./Pkt.
STEP-PS/ 1AC/12DC/5	2868583	1



QUINT and MINI DC/DC converters alter the voltage level, regenerate the voltage, or enable the creation of independent supply systems by means of electrical isolation.

There are numerous fields of application for DC/DC converters. On long supply lines, they raise the voltage to compensate for voltage drops. In addition, they can convert the DC voltage level present at the input into a different voltage level at the output. This enables various voltage levels to be matched to one another.

DC/DC converters separate circuits from each other by means of electrical isolation and protect sensitive consumers by decoupling them. Furthermore, grounded circuits are isolated from non-grounded circuits.

Thanks to their wide input voltage range, DC/DC converters provide a regulated and stable output voltage even in battery-backed and unregulated supply networks.

QUINT POWER – Maximum functionality

Cost-effective selective fuse protection with SFB Technology:

SFB (Selective Fuse Breaking) Technology trips standard circuit breakers reliably and quickly with up to six times the nominal current for 15 ms. Faulty current paths are switched off selectively, the fault is located, and important system parts remain in operation.

Preventive function monitoring:

Comprehensive diagnostics are provided through constant monitoring of all relevant parameters, such as the input voltage, output voltage, and output current. This preventive monitoring visualizes critical operating states, before errors can occur. Remote monitoring is performed by means of active switching outputs and floating relay contacts.

Power reserves:

- Easy system extension with static boost, providing sustained power of 125%
- Start heavy loads with dynamic boost, providing up to 200% power for 5 s

Adaptable:

Signaling thresholds and characteristic curves can be individually adjusted via NFC.

Connection technology:

Free choice between Push-in connection and screw connection for the new generation of QUINT DC/DC converters.

i Your web code: #0152



QUINT POWER

The DC/DC converters with SFB Technology and preventive function monitoring ensure maximum system availability.

- Suitable for high power ratings with currents up to 20 A
- They provide constant voltages as the output voltage is regenerated even at the end of long cables
- They support conversion to various voltage levels



QUINT POWER CO with protective coating for extreme requirements

The protective coating on these DC/DC converters protects against dust, corrosive gases, and 100% humidity as well as failure caused by corrosion-related creepage currents and electrochemical migration.

- OVP (overvoltage protection) limits surge voltages to 32 V
- Wide temperature range from -40°C to $+70^{\circ}\text{C}$



MINI DC/DC converters – For control technology

MINI DC/DC converters come into their own in fields where modular electronics housing has become the standard.

- Maintenance-friendly connection technology with COMBICON coded connectors
- Active function monitoring with switching output for remote monitoring of the output voltage

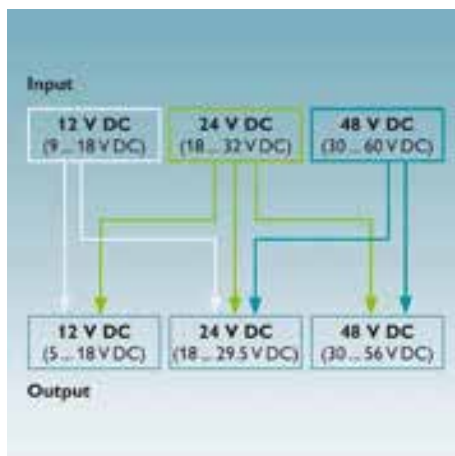

Voltage levels of QUINT DC/DC converters with 12 to 48 V DC

The QUINT DC/DC converters alter the voltage level:

- Input voltages:
 - 12 V DC (9 ... 18 V DC),
 - 24 V DC (18 ... 32 V DC),
 - 48 V DC (30 ... 60 V DC)
- Output voltages:
 - 12 V DC (5 ... 18 V DC),
 - 24 V DC (18 ... 29.5 V DC),
 - 48 V DC (30 ... 56 V DC)

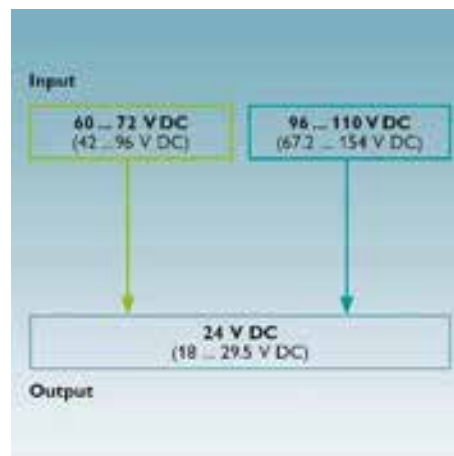

Voltage levels of QUINT DC/DC converters with 60 to 110 V DC

The QUINT DC/DC converters alter the voltage level:

- Input voltages:
 - 60 to 72 V DC (42 ... 96 V DC),
 - 96 to 110 V DC (67 ... 154 V DC)
- Output voltages:
 - 24 V DC (18 ... 29.5 V DC)

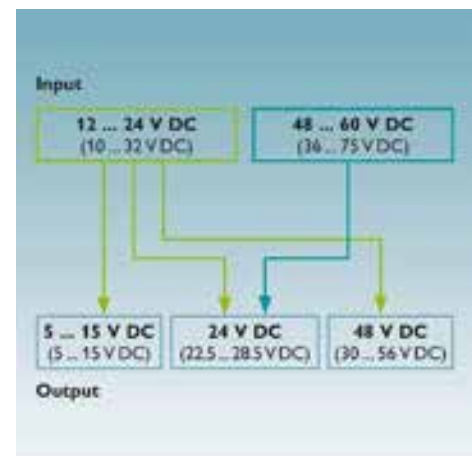

Voltage levels of MINI DC/DC converters

The MINI DC/DC converters alter the voltage level:

- Input voltages:
 - 12 to 24 V DC (10 ... 32 V DC),
 - 48 to 60 V DC (36 ... 75 V DC)
- Output voltages:
 - 5 to 15 V DC (5 ... 15 V DC),
 - 24 V DC (22.5 ... 28.5 V DC),
 - 48 V DC (30 ... 56 V DC)

Power supplies and UPS

DC/DC converters

QUINT DC/DC converters, with Push-in connection

QUINT POWER, 24 V DC to 48 V DC input

- Electrical isolation: for setting up independent supply systems
- Easy system extension with static boost
- Starting of heavy loads with dynamic boost
- SFB Technology selectively trips standard circuit breakers; consumers connected in parallel continue working
- Comprehensive signaling with preventive function monitoring
- Signaling thresholds and characteristic curves can be set via NFC, available pre-configured from a batch quantity of 1
- Free choice between Push-in connection and screw connection

QUINT POWER with IECEx approval

- Devices compliant with standards IEC 60079-0, IEC 60079-7, IEC 60079-11, and IEC 60079-15 may be installed in a potentially explosive area
- Suitable for use in Class I, Division 2
- OVP (overvoltage protection) limits surge voltages to 32 V



Push-in Technology[®]
Designed by PHOENIX CONTACT



new

DC/DC converter
24 V DC / 24 V DC, 5 A, PT

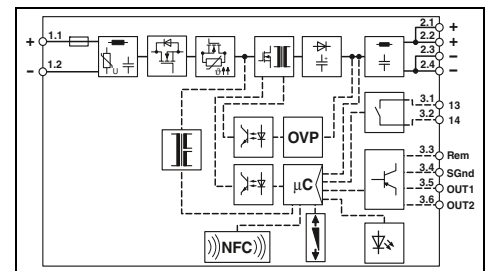

Technical data

Input data	24 V DC -25% ... +40%
Nominal input voltage range	6.9 A (24 V)
Typical current consumption (in static boost)	typ. 1 A / < 0.05 A ² s
Inrush current limitation at 25°C / I ² t	typ. 14 ms (24 V DC)
Mains buffering (I _N)	
Output data	
Nominal output voltage (U _N)	24 V DC
Setting range of the output voltage (U _{Set})	24 V DC ... 29.5 V DC (> 24 V DC, constant capacity)
Output current I _N / I _{Stat.Boost} / I _{Dyn.Boost} / I _{SFB}	5 A / 6.25 A / 10 A (5 s) / 30 A (15 ms)
Magnetic circuit breaker tripping	A1 ... A4 / B2 / C1 ... C2 / Z1 ... Z4
Can be connected in parallel/series	Yes / yes
Max. power dissipation (no load/nominal load)	< 2 W / < 10 W
Efficiency	typ. 92.2% (24 V DC)
Residual ripple	< 10 mV _{pp}
Signaling	
LED signaling	Utilization indicator, DC OK, U _{IN} OK
Configurable signal output	Relay contact 13/14, Out 1 digital, Out 2 digital/analog
Signal options	I _{Out} , U _{Out} , P _{Out} , DC OK, U _{IN} OK, Operating hours, Temp. OK, OVP
General data	
Weight / Dimensions W x H x D	0.6 kg / 36 x 130 x 125 mm
Connection	alignable: 5 mm horizontally, 15 mm next to active components, 50 mm vertically
Connection method	Push-in connection
Input connection data rigid / flexible / AWG	0.2 - 6 mm ² / 0.2 - 6 mm ² / 24 - 10
Output connection data rigid / flexible / AWG	0.2 - 6 mm ² / 0.2 - 6 mm ² / 24 - 10
Signal connection data rigid / flexible / AWG	0.2 - 1 mm ² / 0.2 - 1.5 mm ² / 24 - 16
Degree of protection / Protection class	IP20 / Special with SELV input and output
MTBF (IEC 61709, SN 29500)	> 500000 h (40°C)
Ambient temperature (operation)	-25°C ... 70°C (> 60°C Derating: 2.5%/K)
Ambient temperature (startup type tested)	-40°C
Standards/regulations	
Insulation voltage input/output	1.5 kV DC (routine test) / 2 kV DC (type test)
Electromagnetic compatibility	Conformance with EMC Directive 2014/30/EU
Electrical safety	IEC 60950-1/VDE 0805 (SELV)
Overvoltage category in accordance with EN 62477-1, EN 61010-1	III (≤ 2000 m), II (≤ 5000 m)
Explosive atmospheres	IEC 60079-0 / IEC 60079-7 / IEC 60079-11 / IEC 60079-15
UL approvals	UL applied for, UL ANSI/ISA-12.12.01 Class I, Division 2, Groups A, B, C, D (Hazardous Location)
Ordering data	
Description	Type
DC/DC converter, primary-switched	Order No.
	Pcs./Pkt.
	QUINT4-PS/24DC/24DC/5/PT
	2910119
	1

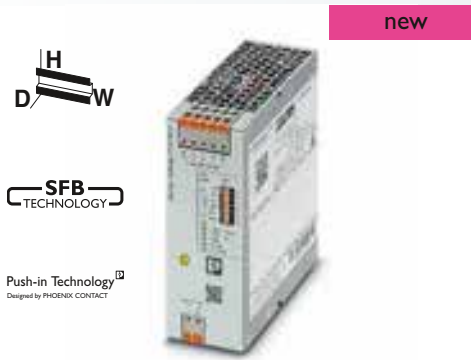

DC/DC converter
24 V DC / 24 V DC, 10 A, PT

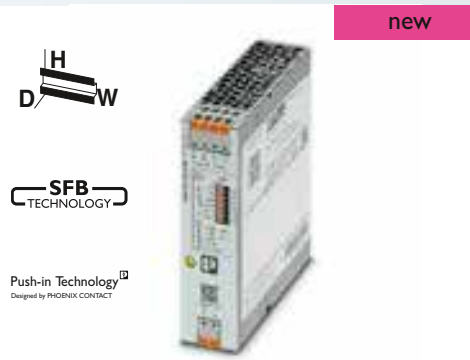

DC/DC converter
24 V DC / 12 V DC, 8 A, PT

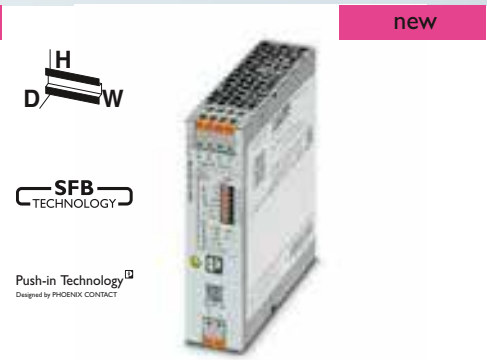

DC/DC converter
48 V DC / 24 V DC, 5 A, PT

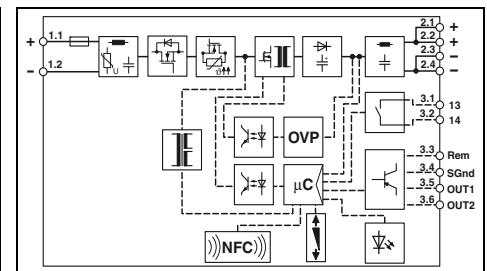
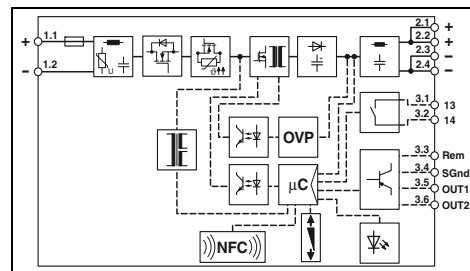
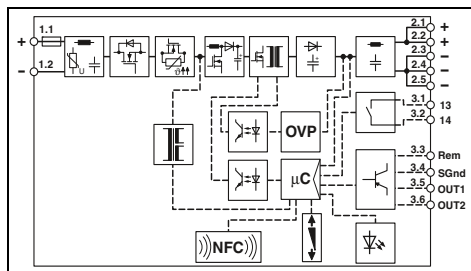

Technical data

Technical data

Technical data

24 V DC -25% ... +40%
14.5 A (24 V)
typ. 1.5 A / < 0.02 A²s
typ. 11 ms (24 V DC)

24 V DC -25% ... +40%
5.5 A (24 V)
typ. 3 A / < 0.02 A²s
typ. 17 ms (24 V DC)

48 V DC -40% ... +25%
3.3 A (24 V)
typ. 2.5 A / < 0.2 A²s
typ. 18 ms (48 V DC)

24 V DC
24 V DC ... 29.5 V DC (> 24 V DC, constant capacity)

12 V DC
12 V DC ... 15 V DC (> 12 V DC, constant capacity)

24 V DC
24 V DC ... 29.5 V DC (> 24 V DC, constant capacity)

10 A / 12.5 A / 20 A (5 s) / 60 A (15 ms)
A1 ... A4 / B2 / C1 ... C2 / Z1 ... Z4
Yes / yes
< 5 W / < 18 W
typ. 93.3% (24 V DC)
< 10 mV_{PP}

8 A / 10 A / 16 A (5 s) / 48 A (15 ms)
A1 ... A4 / B2 / C1 ... C2 / Z1 ... Z4
Yes / yes
< 2 W / < 10 W
typ. 91% (12 V DC)
< 13 mV_{PP}

5 A / 6.25 A / 10 A (5 s) / 30 A (15 ms)
A1 ... A4 / B2 / C1 ... C2 / Z1 ... Z4
Yes / yes
< 2 W / < 8 W
typ. 94% (24 V DC)
< 15 mV_{PP}

Utilization indicator, DC OK, U_{IN} OK
Relay contact 13/14, Out 1 digital, Out 2 digital/analog

Utilization indicator, DC OK, U_{IN} OK
Relay contact 13/14, Out 1 digital, Out 2 digital/analog

Utilization indicator, DC OK, U_{IN} OK
Relay contact 13/14, Out 1 digital, Out 2 digital/analog

I_{Out}, U_{Out}, P_{Out}, DC OK, U_{IN} OK, Operating hours, Temp. OK, OVP

I_{Out}, U_{Out}, P_{Out}, DC OK, U_{IN} OK, Operating hours, Temp. OK, OVP

I_{Out}, U_{Out}, P_{Out}, DC OK, U_{IN} OK, Operating hours, Temp. OK, OVP

0.8 kg / 50 x 130 x 125 mm
alignable: 5 mm horizontally, 15 mm next to active components, 50 mm vertically
Push-in connection
0.2 - 6 mm² / 0.2 - 6 mm² / 24 - 10
0.2 - 6 mm² / 0.2 - 6 mm² / 24 - 10
0.2 - 1 mm² / 0.2 - 1.5 mm² / 24 - 16
IP20 / Special with SELV input and output
> 813000 h (40°C)
-25°C ... 70°C (> 60°C Derating: 2.5%/K)
-40°C

0.6 kg / 36 x 130 x 125 mm
alignable: 5 mm horizontally, 15 mm next to active components, 50 mm vertically
Push-in connection
0.2 - 6 mm² / 0.2 - 6 mm² / 24 - 10
0.2 - 6 mm² / 0.2 - 6 mm² / 24 - 10
0.2 - 1 mm² / 0.2 - 1.5 mm² / 24 - 16
IP20 / Special with SELV input and output
> 500000 h (40°C)
-25°C ... 70°C (> 60°C Derating: 2.5%/K)
-40°C

0.6 kg / 36 x 130 x 125 mm
alignable: 5 mm horizontally, 15 mm next to active components, 50 mm vertically
Push-in connection
0.2 - 6 mm² / 0.2 - 6 mm² / 24 - 10
0.2 - 6 mm² / 0.2 - 6 mm² / 24 - 10
0.2 - 1 mm² / 0.2 - 1.5 mm² / 24 - 16
IP20 / Special with SELV input and output
> 500000 h (40°C)
-25°C ... 70°C (> 60°C Derating: 2.5%/K)
-40°C

1.5 kV DC (routine test) / 2 kV DC (type test)
Conformance with EMC Directive 2014/30/EU
IEC 60950-1/VDE 0805 (SELV)
III (≤ 2000 m), II (≤ 5000 m)

2 kV DC (routine test) / 4 kV DC (type test)
Conformance with EMC Directive 2014/30/EU
IEC 61010-2-201 (SELV)
III, II

2 kV DC (routine test) / 4 kV DC (type test)
Conformance with EMC Directive 2014/30/EU
IEC 61010-2-201 (SELV)
III, II

IEC 60079-0 / IEC 60079-7 / IEC 60079-11 / IEC 60079-15
UL applied for, UL ANSI/ISA-12.12.01 Class I, Division 2, Groups A, B, C, D (Hazardous Location)

IEC 60079-0 / IEC 60079-7 / IEC 60079-11 / IEC 60079-15
UL 61010-2-201, UL ANSI/ISA-12.12.01 Class I, Division 2, Groups A, B, C, D (Hazardous Location)

IEC 60079-0 / IEC 60079-7 / IEC 60079-11 / IEC 60079-15
UL 61010-2-201, UL ANSI/ISA-12.12.01 Class I, Division 2, Groups A, B, C, D (Hazardous Location)

Ordering data

Ordering data

Ordering data

Type	Order No.	Pcs./Pkt.
QUINT4-PS/24DC/24DC/10/PT	2910120	1

Type	Order No.	Pcs./Pkt.
QUINT4-PS/24DC/12DC/8/PT	2910122	1

Type	Order No.	Pcs./Pkt.
QUINT4-PS/48DC/24DC/5/PT	2910125	1

Power supplies and UPS

DC/DC converters

QUINT DC/DC converters, with screw connection

QUINT POWER, 24 V DC input

- Electrical isolation: for setting up independent supply systems
- Easy system extension with static boost
- Starting of heavy loads with dynamic boost
- SFB Technology selectively trips standard circuit breakers; consumers connected in parallel continue working
- Comprehensive signaling with preventive function monitoring
- Signaling thresholds and characteristic curves can be set via NFC, available pre-configured from a batch quantity of 1
- Free choice between Push-in connection and screw connection

QUINT POWER with IECEx approval

- Devices compliant with standards IEC 60079-0, IEC 60079-7, IEC 60079-11, and IEC 60079-15 may be installed in a potentially explosive area
- Suitable for use in Class I, Division 2
- OVP (overvoltage protection) limits surge voltages to 32 V



new

DC/DC converter
24 V DC / 24 V DC, 5 A, SC

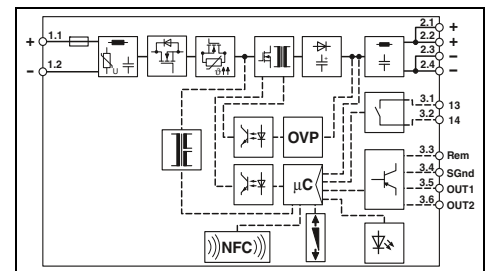

Technical data

Input data	24 V DC -25% ... +40%
Nominal input voltage range	6.9 A (24 V)
Typical current consumption (in static boost)	typ. 1 A / < 0.05 A ^{2s}
Inrush current limitation at 25°C / I ^{2t}	typ. 14 ms (24 V DC)
Mains buffering (I _N)	
Output data	24 V DC
Nominal output voltage (U _N)	24 V DC ... 29.5 V DC (> 24 V DC, constant capacity)
Setting range of the output voltage (U _{Set})	5 A / 6.25 A / 10 A (5 s) / 30 A (15 ms)
Output current I _N / I _{Stat.Boost} / I _{Dyn.Boost} / I _{SFB}	A1 ... A4 / B2 / C1 ... C2 / Z1 ... Z4
Magnetic circuit breaker tripping	Yes / yes
Can be connected in parallel/series	< 2 W / < 10 W
Max. power dissipation (no load/nominal load)	typ. 92.2% (24 V DC)
Efficiency	< 10 mV _{pp}
Residual ripple	
Signaling	Utilization indicator, DC OK, U _{IN} OK
LED signaling	Relay contact 13/14, Out 1 digital, Out 2 digital/analog
Configurable signal output	
	I _{Out} , U _{Out} , P _{Out} , DC OK, U _{IN} OK, Operating hours, Temp. OK, OVP
Signal options	
General data	0.6 kg / 36 x 130 x 125 mm
Weight / Dimensions W x H x D	alignable: 5 mm horizontally, 15 mm next to active components, 50 mm vertically
Connection	Screw connection
Connection method	0.2 - 6 mm ² / 0.2 - 6 mm ² / 24 - 10
Input connection data rigid / flexible / AWG	0.2 - 6 mm ² / 0.2 - 6 mm ² / 24 - 10
Output connection data rigid / flexible / AWG	0.2 - 1 mm ² / 0.2 - 1.5 mm ² / 24 - 16
Signal connection data rigid / flexible / AWG	IP20 / Special with SELV input and output
Degree of protection / Protection class	> 500000 h (40°C)
MTBF (IEC 61709, SN 29500)	-25°C ... 70°C (> 60°C Derating: 2.5%/K)
Ambient temperature (operation)	-40°C
Ambient temperature (startup type tested)	
Standards/regulations	2 kV DC (routine test) / 4 kV DC (type test)
Insulation voltage input/output	Conformance with EMC Directive 2014/30/EU
Electromagnetic compatibility	IEC 61010-2-201 (SELV)
Electrical safety	III, II
Overvoltage category in accordance with EN 62477-1, EN 61010-1	IEC 60079-0 / IEC 60079-7 / IEC 60079-11 / IEC 60079-15
Explosive atmospheres	UL 61010-2-201, UL ANSI/ISA-12.12.01 Class I, Division 2, Groups A, B, C, D (Hazardous Location)
UL approvals	
Ordering data	
Description	Type
DC/DC converter, primary-switched	Order No.
	Pcs./Pkt.
	QUINT4-PS/24DC/24DC/5/SC
	1046800
	1

new



DC/DC converter
24 V DC / 24 V DC, 10 A, SC

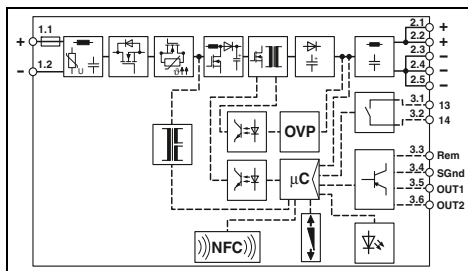

Technical data

24 V DC -25% ... +40%
13.8 A (24 V)
typ. 1.5 A / < 0.02 A²s
typ. 11 ms (24 V DC)

24 V DC
24 V DC ... 29.5 V DC (> 24 V DC, constant capacity)

10 A / 12.5 A / 20 A (5 s) / 60 A (15 ms)
A1 ... A4 / B2 / C1 ... C2 / Z1 ... Z4
Yes / yes
< 5 W / < 18 W
typ. 93.3% (24 V DC)
< 10 mV_{pp}

Utilization indicator, DC OK, U_{IN} OK
Relay contact 13/14, Out 1 digital, Out 2 digital/analog

I_{Out}, U_{Out}, P_{Out}, U_{In} OK, Operating hours, Temp. OK, OVP

0.8 kg / 50 x 130 x 125 mm
alignable: 5 mm horizontally, 15 mm next to active components,
50 mm vertically
Screw connection
0.2 - 6 mm² / 0.2 - 6 mm² / 24 - 10
0.2 - 6 mm² / 0.2 - 6 mm² / 24 - 10
0.2 - 1 mm² / 0.2 - 1.5 mm² / 24 - 16
IP20 / Special with SELV input and output
> 813000 h (40°C)
-25°C ... 70°C (> 60°C Derating: 2.5%/K)
-40°C

2 kV DC (routine test) / 4 kV DC (type test)
Conformance with EMC Directive 2014/30/EU
IEC 61010-2-201 (SELV)
III, II

IEC 60079-0 / IEC 60079-7 / IEC 60079-11 / IEC 60079-15
UL 61010-2-201, UL ANSI/ISA-12.12.01 Class I, Division 2,
Groups A, B, C, D (Hazardous Location)

Ordering data

Type	Order No.	Pcs./Pkt.
QUINT4-PS/24DC/24DC/10/SC	1046803	1

QUINT POWER, 12 to 48 V DC input

- Support conversion to various voltage levels
- Constant voltage: output voltage regenerated even at the end of long cables
- Electrical isolation: for setting up independent supply systems
- SFB Technology: fast tripping of standard circuit breakers, thanks to the dynamic power reserve with up to 6 times the nominal current for 12 ms
- Reliable starting of heavy loads thanks to the static Power Boost power reserve with up to 125% of the nominal current
- Preventive function monitoring



**DC/DC converter,
24 V DC / 24 V DC, 20 A**

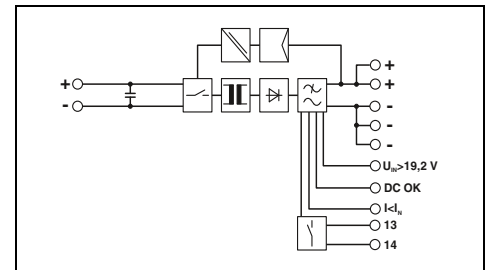

Technical data

Input data	24 V DC 28 A (24 V, I _{BOOST}) < 26 A / < 11 A ² s typ. 10 ms (24 V DC)
Nominal input voltage range	
Current consumption (Power Boost)	
Inrush current limitation at 25°C / I ² t	
Mains buffering (I _N)	
Output data	24 V DC ±1% 18 V DC ... 29.5 V DC (> 24 V DC, constant capacity restricted)
Nominal output voltage (U _N)	
Setting range of the output voltage (U _{Set})	
Output current / Power Boost / SFB (12 ms)	20 A / 25 A / 120 A
Magnetic circuit breaker tripping	B2 / B4 / B6 / B10 / B16 / C2 / C4 / C6
Can be connected in parallel/series	Yes / yes
Max. power dissipation (no load/nominal load)	2.2 W / 39 W
Efficiency	> 93%
Residual ripple	< 20 mV _{PP}
Signaling	LED, active switching output, relay contact LED, active switching output LED, active switching output
Signaling DC OK	
Boost signaling	
U _N signaling	
General data	1.7 kg / 82 x 130 x 125 mm alignable: 5 mm horizontally, 15 mm next to active components, 50 mm vertically Screw connection 0.5 - 16 mm ² / 0.5 - 16 mm ² / 8 - 6 0.2 - 6 mm ² / 0.2 - 4 mm ² / 12 - 10 0.2 - 2.5 mm ² / 0.2 - 2.5 mm ² / 24 - 12 IP20 / III > 554000 h (40°C) -25°C ... 70°C (> 60°C derating, 2.5%/K, startup at -40°C type-tested) ≤ 95% (at 25°C, non-condensing)
Weight / Dimensions W x H x D	
Connection	
Connection method	
Input connection data rigid / flexible / AWG	
Output connection data rigid / flexible / AWG	
Signal connection data rigid / flexible / AWG	
Degree of protection / Protection class	
MTBF (IEC 61709, SN 29500)	
Ambient temperature (operation)	
Max. permissible relative humidity (operation)	
Standards/regulations	1 kV (routine test) / 1.5 kV (type test) Conformance with EMC Directive 2014/30/EU EN 60950-1/VDE 0805 (SELV) EN 50178/VDE 0160 (PELV) DIN VDE 0100-410 UL/C-UL Listed UL 508, UL/C-UL Recognized UL 60950-1, UL ANSI/ISA-12.12.01 Class I, Division 2, Groups A, B, C, D (Hazardous Location)
Insulation voltage input/output	
Electromagnetic compatibility	
Electrical safety	
Electronic equipm. for electrical power installations	
Safe isolation	
UL approvals	

Ordering data

Description	Type	Order No.	Pcs./Pkt.
DC/DC converter, primary-switched	QUINT-PS/24DC/24DC/20	2320102	1



DC/DC converter,
12 V DC / 24 V DC, 5 A



DC/DC converter,
12 V DC/12 V DC, 8 A



DC/DC converter,
48 V DC/48 V DC, 5 A

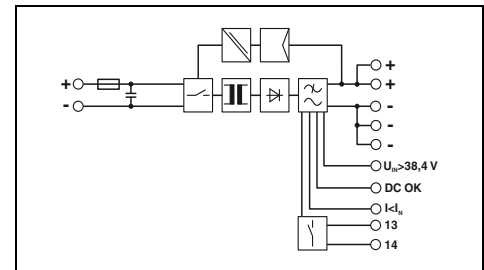
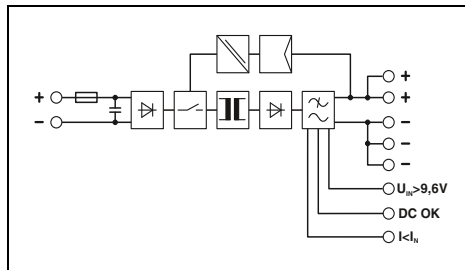
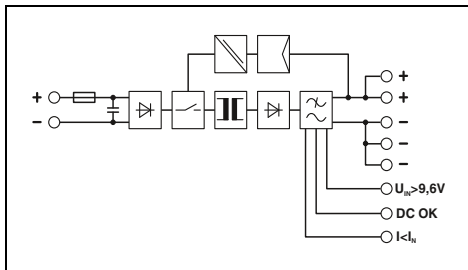

Technical data

Technical data

Technical data

12 V DC
15 A (12 V, I_{BOOST})
< 15 A / < 0.3 A²s
typ. 3 ms (12 V DC)

12 V DC
12 A (12 V, I_{BOOST})
< 6 A / < 0.6 A²s
typ. 3 ms (12 V DC)

48 V DC
7 A (48 V, I_{BOOST})
< 6 A / 0.3 A²s
typ. 10 ms (48 V DC)

24 V DC ±1%
18 V DC ... 29.5 V DC (> 24 V DC, constant capacity restricted)

12 V DC ±1%
5 V DC ... 18 V DC (> 12 V DC, constant capacity restricted)

48 V DC ±1%
30 V DC ... 56 V DC (> 48 V DC, constant capacity restricted)

5 A / 6.25 A / 30 A
B2 / B4 / C2
Yes / yes
2 W / 13.5 W
> 90%
< 75 mV_{PP}

8 A / 10 A / 48 A
B2 / B4 / C2
Yes / yes
1.5 W / 11.8 W
> 89%
< 20 mV_{PP}

5 A / 6.25 A / 30 A
B2 / B4 / C2
Yes / yes
2.7 W / 20 W
> 93%
< 20 mV_{PP}

LED, active switching output
LED, active switching output
LED, active switching output

LED, active switching output
LED, active switching output
LED, active switching output

LED, active switching output
LED, active switching output
LED, active switching output

0.7 kg / 32 x 130 x 125 mm
alignable: 5 mm horizontally, 15 mm next to active components,
50 mm vertically
Plug-in screw connection
0.2 - 2.5 mm² / 0.2 - 2.5 mm² / 18 - 12
0.2 - 2.5 mm² / 0.2 - 2.5 mm² / 18 - 12
0.2 - 2.5 mm² / 0.2 - 2.5 mm² / 24 - 12
IP20 / III
> 1005000 h (40°C)
-25°C ... 70°C (> 60°C Derating: 2.5%/K)

0.8 kg / 32 x 130 x 125 mm
alignable: 5 mm horizontally, 15 mm next to active components,
50 mm vertically
Plug-in screw connection
0.2 - 2.5 mm² / 0.2 - 2.5 mm² / 24 - 12
0.2 - 2.5 mm² / 0.2 - 2.5 mm² / 24 - 12
0.2 - 2.5 mm² / 0.2 - 2.5 mm² / 24 - 12
IP20 / III
> 920000 h (40°C)
-25°C ... 70°C (> 60°C Derating: 2.5%/K)

0.9 kg / 48 x 130 x 125 mm
alignable: 5 mm horizontally, 15 mm next to active components,
50 mm vertically
Plug-in screw connection
0.2 - 2.5 mm² / 0.2 - 2.5 mm² / 24 - 12
0.2 - 2.5 mm² / 0.2 - 2.5 mm² / 24 - 12
0.2 - 2.5 mm² / 0.2 - 2.5 mm² / 24 - 12
IP20 / III
> 872000 h (40°C)
-25°C ... 70°C (> 60°C Derating: 2.5%/K)

≤ 95% (at 25°C, non-condensing)

≤ 95% (at 25°C, non-condensing)

≤ 95% (at 25°C, non-condensing)

1 kV (routine test) / 1.5 kV (type test)
Conformance with EMC Directive 2014/30/EU
EN 60950-1/VDE 0805 (SELV)
EN 50178/VDE 0160 (PELV)
DIN VDE 0100-410
UL/C-UL Listed UL 508, UL/C-UL Recognized UL 60950-1,
UL ANSI/ISA-12.12.01 Class I, Division 2, Groups A, B, C, D
(Hazardous Location)

1 kV (routine test) / 1.5 kV (type test)
Conformance with EMC Directive 2014/30/EU
EN 60950-1/VDE 0805 (SELV)
EN 50178/VDE 0160 (PELV)
DIN VDE 0100-410
UL/C-UL Listed UL 508, UL/C-UL Recognized UL 60950-1,
UL ANSI/ISA-12.12.01 Class I, Division 2, Groups A, B, C, D
(Hazardous Location)

1 kV (routine test) / 1.5 kV (type test)
Conformance with EMC Directive 2014/30/EU
EN 60950-1/VDE 0805 (SELV)
EN 50178/VDE 0160 (PELV)
DIN VDE 0100-410
UL/C-UL Listed UL 508, UL/C-UL Recognized UL 60950-1,
UL ANSI/ISA-12.12.01 Class I, Division 2, Groups A, B, C, D
(Hazardous Location)

Ordering data

Ordering data

Ordering data

Type	Order No.	Pcs./Pkt.
QUINT-PS/12DC/24DC/ 5	2320131	1

Type	Order No.	Pcs./Pkt.
QUINT-PS/12DC/12DC/8	2905007	1

Type	Order No.	Pcs./Pkt.
QUINT-PS/48DC/48DC/5	2905008	1

QUINT POWER with wide-range input

- Support conversion to various voltage levels
- Constant voltage: output voltage regenerated even at the end of long cables
- Electrical isolation: for setting up independent supply systems
- SFB Technology: fast tripping of standard circuit breakers, thanks to the dynamic power reserve with up to 6 times the nominal current for 12 ms
- Reliable starting of heavy loads thanks to the static Power Boost power reserve with up to 125% of the nominal current
- Preventive function monitoring



**DC/DC converter,
60 - 72 V DC/24 V DC, 10 A**

ERC
Ex:

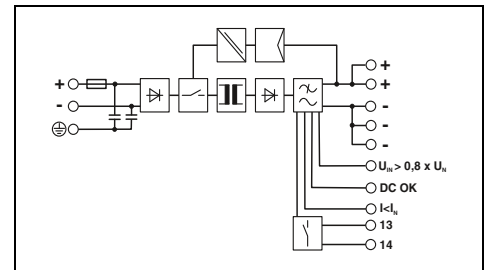

Technical data

Input data	60 V DC ... 72 V DC 5,6 A (60 V DC) / 4,7 A (72 V DC) < 9 A / 0,64 A ² s typ. 10 ms (60 V DC)		
Nominal input voltage range			
Current consumption (Power Boost)			
Inrush current limitation at 25°C / I ² t			
Mains buffering (I _N)			
Output data	24 V DC ±1% 18 V DC ... 29.5 V DC (> 24 V DC, constant capacity restricted)		
Nominal output voltage (U _N)			
Setting range of the output voltage (U _{Set})			
Output current / Power Boost / SFB (12 ms)	10 A / 12.5 A / 60 A		
Magnetic circuit breaker tripping	B2 / B4 / B6		
Can be connected in parallel/series	Yes / yes		
Max. power dissipation (no load/nominal load)	4 W (U _N 60 V DC) / 24 W (U _N 60 V DC)		
Efficiency	> 91% (U _N 60 V DC / U _{OUT} 24 V DC) / > 91% (U _N 72 V DC / U _{OUT} 24 V DC)		
Residual ripple	< 20 mV _{PP}		
Signaling	LED, active switching output, relay contact		
Signaling DC OK	LED, active switching output		
Boost signaling	LED, active switching output		
U _N signaling			
General data	1 kg / 48 x 130 x 125 mm alignable: 5 mm horizontally, 15 mm next to active components, 50 mm vertically		
Weight / Dimensions W x H x D			
Connection	Plug-in screw connection 0.2 - 2.5 mm ² / 0.2 - 2.5 mm ² / 24 - 12 0.2 - 2.5 mm ² / 0.2 - 2.5 mm ² / 24 - 12 0.2 - 2.5 mm ² / 0.2 - 2.5 mm ² / 24 - 12 IP20 / I > 765000 h (40°C) -25°C ... 70°C (> 60°C Derating: 2.5%/K) ≤ 95% (at 25°C, non-condensing)		
Connection method			
Input connection data rigid / flexible / AWG			
Output connection data rigid / flexible / AWG			
Signal connection data rigid / flexible / AWG			
Degree of protection / Protection class			
MTBF (IEC 61709, SN 29500)			
Ambient temperature (operation)			
Max. permissible relative humidity (operation)			
Standards/regulations	1 kV (routine test) / 1.5 kV (type test) Conformance with EMC Directive 2014/30/EU EN 60950-1/VDE 0805 (SELV) EN 50178/VDE 0160 (PELV) DIN VDE 0100-410 UL/C-UL Listed UL 508, UL/C-UL Recognized UL 60950-1, UL ANSI/ISA-12.12.01 Class I, Division 2, Groups A, B, C, D (Hazardous Location)		
Insulation voltage input/output			
Electromagnetic compatibility			
Electrical safety			
Electronic equipm. for electrical power installations			
Safe isolation			
UL approvals			
Ordering data			
Description	Type	Order No.	Pcs./Pkt.
DC/DC converter, primary-switched, dip-coated	QUINT-PS/60-72DC/24DC/10	2905009	1



**DC/DC converter,
96 - 110 V DC/24 V DC, 10 A**

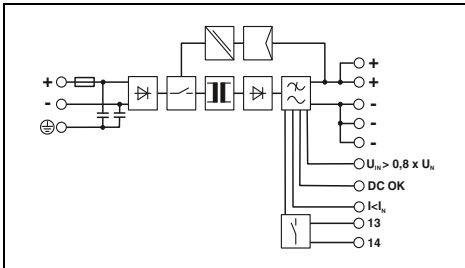

Technical data

96 V DC ... 110 V DC
3.5 A (96 V DC) / 3.1 A (110 V DC)
< 10 A / 0.37 A²s
typ. 10 ms (96 V DC)

24 V DC $\pm 1\%$
18 V DC ... 29.5 V DC (> 24 V DC, constant capacity restricted)

10 A / 12.5 A / 60 A
B2 / B4 / B6
Yes / yes
4 W (U_{IN} 110 V DC) / 22 W (U_{IN} 110 V DC)
> 92% (U_{IN} 96 V DC / U_{OUT} 24 V DC) /
> 92% (U_{IN} 110 V DC / U_{OUT} 24 V DC)
< 20 mV_{PP}

LED, active switching output, relay contact
LED, active switching output
LED, active switching output

0.9 kg / 48 x 130 x 125 mm
alignable: 5 mm horizontally, 15 mm next to active components,
50 mm vertically
Plug-in screw connection
0.2 - 2.5 mm² / 0.2 - 2.5 mm² / 24 - 12
0.2 - 2.5 mm² / 0.2 - 2.5 mm² / 24 - 12
0.2 - 2.5 mm² / 0.2 - 2.5 mm² / 24 - 12
IP20 / I
> 772000 h (40°C)
-25°C ... 70°C (> 60°C Derating: 2.5%/K)
≤ 95% (at 25°C, non-condensing)

1 kV (routine test) / 1.5 kV (type test)
Conformance with EMC Directive 2014/30/EU
EN 60950-1/VDE 0805 (SELV)
EN 50178/VDE 0160 (PELV)
DIN VDE 0100-410
UL/C-UL Listed UL 508, UL/C-UL Recognized UL 60950-1,
UL ANSI/ISA-12.12.01 Class I, Division 2, Groups A, B, C, D
(Hazardous Location)

Ordering data

Type	Order No.	Pcs./Pkt.
QUINT-PS/96-110DC/24DC/10	2905010	1

Power supplies and UPS

DC/DC converters

QUINT DC/DC converters for extreme ambient conditions

QUINT POWER with protective coating

With ATEX approval for superior system availability under extreme ambient conditions, such as dust, dirt, corrosive gases, and 100% humidity

- Devices compliant with standards EN 60079-15 and EN 60079-0 may be installed in a potentially explosive area
- Suitable for use in Class I, Division 2
- OVP (overvoltage protection) limits surge voltages to 32 V
- Temperature range from -40°C to +70°C, Groups A, B, C, D



DC/DC converter, with protective coating, 24 V DC/24 V DC, 5 A



DC/DC converter, with protective coating, 24 V DC/24 V DC, 10 A

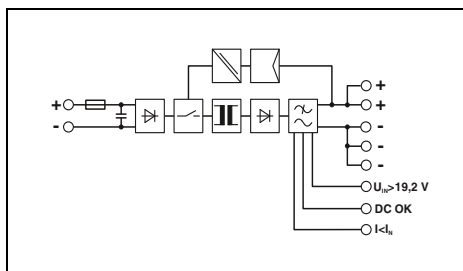

Technical data

Input data	
Nominal input voltage range	24 V DC
Current consumption (Power Boost)	7 A (24 V, I _{BOOST})
Inrush current limitation at 25°C / I ² t	typ. 15 A / < 0.5 A ² s
Mains buffering (I _N)	typ. 10 ms (24 V DC)
Output data	
Nominal output voltage (U _N)	24 V DC ±1%
Setting range of the output voltage (U _{Set})	18 V DC ... 29.5 V DC (> 24 V DC, constant capacity restricted)
Output current / Power Boost / SFB (12 ms)	5 A / 6.25 A / 30 A
Magnetic circuit breaker tripping	B2 / B4 / C2
Can be connected in parallel/series	Yes / yes
Max. power dissipation (no load/nominal load)	2.4 W / 11.4 W
Efficiency	> 92%
Residual ripple	< 20 mV _{pp}
Signaling	
Signaling DC OK	LED, active switching output
Boost signaling	LED, active switching output
U _N signaling	LED, active switching output
General data	
Weight / Dimensions W x H x D	0.7 kg / 32 x 130 x 125 mm
Connection	alignable: 5 mm horizontally, 15 mm next to active components, 50 mm vertically
Connection method	Plug-in screw connection
Input connection data rigid / flexible / AWG	0.2 - 2.5 mm ² / 0.2 - 2.5 mm ² / 24 - 12
Output connection data rigid / flexible / AWG	0.2 - 2.5 mm ² / 0.2 - 2.5 mm ² / 24 - 12
Signal connection data rigid / flexible / AWG	0.2 - 2.5 mm ² / 0.2 - 2.5 mm ² / 24 - 12
Degree of protection / Protection class	IP20 / III
MTBF (IEC 61709, SN 29500)	> 890000 h (40°C)
Ambient temperature (operation)	-25°C ... 70°C (> 60°C derating, 2.5%/K, startup at -40°C type-tested)
Max. permissible relative humidity (operation)	100% (at 25°C, non-condensing)
Standards/regulations	
Insulation voltage input/output	1 kV (routine test) / 1.5 kV (type test)
Electromagnetic compatibility	Conformance with EMC Directive 2014/30/EU
Electrical safety	EN 60950-1/VDE 0805 (SELV)
Electronic equipm. for electrical power installations	EN 50178/VDE 0160 (PELV)
Safe isolation	DIN VDE 0100-410
UL approvals	UL/C-UL Listed UL 508, UL/C-UL Recognized UL 60950-1, UL ANSI/ISA-12.12.01 Class I, Division 2, Groups A, B, C, D (Hazardous Location)

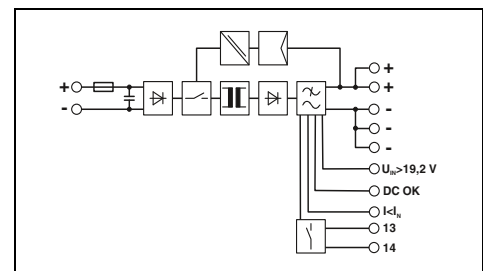

Technical data

Input data	
Nominal input voltage range	24 V DC
Current consumption (Power Boost)	14 A (24 V, I _{BOOST})
Inrush current limitation at 25°C / I ² t	typ. 15 A / < 2.7 A ² s
Mains buffering (I _N)	typ. 12 ms (24 V DC)
Output data	
Nominal output voltage (U _N)	24 V DC ±1%
Setting range of the output voltage (U _{Set})	18 V DC ... 29.5 V DC (> 24 V DC, constant capacity restricted)
Output current / Power Boost / SFB (12 ms)	10 A / 12.5 A / 60 A
Magnetic circuit breaker tripping	B2 / B4 / B6 / C2 / C4
Can be connected in parallel/series	Yes / yes
Max. power dissipation (no load/nominal load)	1.6 W / 24 W
Efficiency	> 92%
Residual ripple	< 20 mV _{pp}
Signaling	
Signaling DC OK	LED, active switching output, relay contact
Boost signaling	LED, active switching output
U _N signaling	LED, active switching output
General data	
Weight / Dimensions W x H x D	0.9 kg / 48 x 130 x 125 mm
Connection	alignable: 5 mm horizontally, 15 mm next to active components, 50 mm vertically
Connection method	Plug-in screw connection
Input connection data rigid / flexible / AWG	0.2 - 2.5 mm ² / 0.2 - 2.5 mm ² / 24 - 12
Output connection data rigid / flexible / AWG	0.2 - 2.5 mm ² / 0.2 - 2.5 mm ² / 24 - 12
Signal connection data rigid / flexible / AWG	0.2 - 2.5 mm ² / 0.2 - 2.5 mm ² / 24 - 12
Degree of protection / Protection class	IP20 / III
MTBF (IEC 61709, SN 29500)	> 763000 h (40°C)
Ambient temperature (operation)	-25°C ... 70°C (> 60°C derating, 2.5%/K, startup at -40°C type-tested)
Max. permissible relative humidity (operation)	100% (at 25°C, non-condensing)
Standards/regulations	
Insulation voltage input/output	1 kV (routine test) / 1.5 kV (type test)
Electromagnetic compatibility	Conformance with EMC Directive 2014/30/EU
Electrical safety	EN 60950-1/VDE 0805 (SELV)
Electronic equipm. for electrical power installations	EN 50178/VDE 0160 (PELV)
Safe isolation	DIN VDE 0100-410
UL approvals	UL/C-UL Listed UL 508, UL/C-UL Recognized UL 60950-1, UL ANSI/ISA-12.12.01 Class I, Division 2, Groups A, B, C, D (Hazardous Location)

Ordering data

Description	
DC/DC converter, primary-switched, dip-coated	

Type	Order No.	Pcs./Pkt.
QUINT-PS/24DC/24DC/ 5/CO	2320542	1

Ordering data

Type	Order No.	Pcs./Pkt.
QUINT-PS/24DC/24DC/10/CO	2320555	1

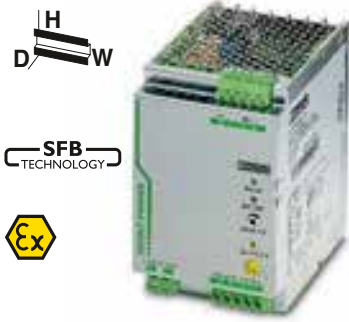

DC/DC converter, with protective coating, 24 V DC/24 V DC, 20 A



DC/DC converter, with protective coating, 60 - 72 V DC/24 V DC, 10 A



DC/DC converter, with protective coating, 96 - 110 V DC/24 V DC, 10 A

UL US ENEC CE ClassNK

EN 50 135

EN 50 135

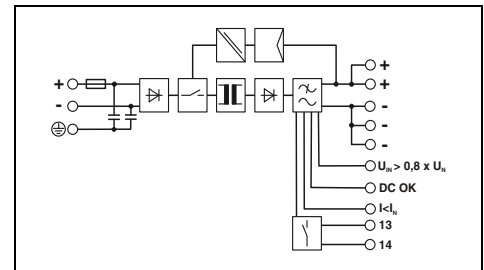
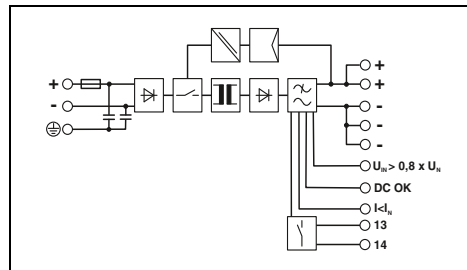
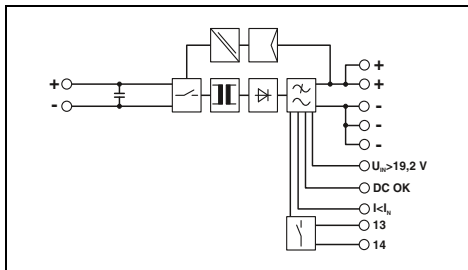

Technical data

Technical data

Technical data

24 V DC
28 A (24 V, I_{BOOST})
typ. 26 A / < 11 A²s
typ. 10 ms (24 V DC)

24 V DC ±1%
18 V DC ... 29.5 V DC (> 24 V DC, constant capacity restricted)

20 A / 25 A / 120 A
B2 / B4 / B6 / B10 / B16 / C2 / C4 / C6
Yes / yes
2.2 W / 39 W
> 92%

< 20 mV_{PP}

LED, active switching output, relay contact
LED, active switching output
LED, active switching output

1.7 kg / 82 x 130 x 125 mm
alignable: 5 mm horizontally, 15 mm next to active components, 50 mm vertically
Screw connection
0.5 - 16 mm² / 0.5 - 16 mm² / 8 - 6
0.2 - 6 mm² / 0.2 - 4 mm² / 12 - 10
0.2 - 2.5 mm² / 0.2 - 2.5 mm² / 24 - 12
IP20 / III
> 554000 h (40°C)
-25°C ... 70°C (> 60°C derating, 2.5%/K, startup at -40°C type-tested)
100% (at 25°C, non-condensing)

1 kV (routine test) / 1.5 kV (type test)
Conformance with EMC Directive 2014/30/EU
EN 60950-1/VDE 0805 (SELV)
EN 50178/VDE 0160 (PELV)
DIN VDE 0100-410
UL/C-UL Listed UL 508, UL/C-UL Recognized UL 60950-1, UL ANSI/ISA-12.12.01 Class I, Division 2, Groups A, B, C, D (Hazardous Location)

60 V DC ... 72 V DC
5.6 A (60 V DC) / 4.7 A (72 V DC)
< 9 A / 0.64 A²s
typ. 10 ms (60 V DC)

24 V DC ±1%
18 V DC ... 29.5 V DC (> 24 V DC, constant capacity restricted)

10 A / 12.5 A / 60 A
B2 / B4 / B6
Yes / yes
4 W (U_{IN} 60 V DC) / 24 W (U_{IN} 60 V DC)
> 91% (U_{IN} 60 V DC / U_{OUT} 24 V DC) / > 91% (U_{IN} 72 V DC / U_{OUT} 24 V DC)
< 20 mV_{PP}

LED, active switching output, relay contact
LED, active switching output
LED, active switching output

1 kg / 48 x 130 x 125 mm
alignable: 5 mm horizontally, 15 mm next to active components, 50 mm vertically
Plug-in screw connection
0.2 - 2.5 mm² / 0.2 - 2.5 mm² / 24 - 12
0.2 - 2.5 mm² / 0.2 - 2.5 mm² / 24 - 12
0.2 - 2.5 mm² / 0.2 - 2.5 mm² / 24 - 12
IP20 / I
> 765000 h (40°C)
-25°C ... 70°C (> 60°C Derating: 2.5%/K)
100% (at 25°C, non-condensing)

1 kV (routine test) / 1.5 kV (type test)
Conformance with EMC Directive 2014/30/EU
EN 60950-1/VDE 0805 (SELV)
EN 50178/VDE 0160 (PELV)
DIN VDE 0100-410
UL/C-UL Listed UL 508, UL/C-UL Recognized UL 60950-1, UL ANSI/ISA-12.12.01 Class I, Division 2, Groups A, B, C, D (Hazardous Location)

96 V DC ... 110 V DC
3.5 A (96 V DC) / 3.1 A (110 V DC)
< 10 A / 0.37 A²s
typ. 10 ms (96 V DC)

24 V DC ±1%
18 V DC ... 29.5 V DC (> 24 V DC, constant capacity restricted)

10 A / 12.5 A / 60 A
B2 / B4 / B6
Yes / yes
4 W (U_{IN} 110 V DC) / 22 W (U_{IN} 110 V DC)
> 92% (U_{IN} 96 V DC / U_{OUT} 24 V DC) / > 92% (U_{IN} 110 V DC / U_{OUT} 24 V DC)
< 20 mV_{PP}

LED, active switching output, relay contact
LED, active switching output
LED, active switching output

0.9 kg / 48 x 130 x 125 mm
alignable: 5 mm horizontally, 15 mm next to active components, 50 mm vertically
Plug-in screw connection
0.2 - 2.5 mm² / 0.2 - 2.5 mm² / 24 - 12
0.2 - 2.5 mm² / 0.2 - 2.5 mm² / 24 - 12
0.2 - 2.5 mm² / 0.2 - 2.5 mm² / 24 - 12
IP20 / I
> 772000 h (40°C)
-25°C ... 70°C (> 60°C Derating: 2.5%/K)
100% (at 25°C, non-condensing)

1 kV (routine test) / 1.5 kV (type test)
Conformance with EMC Directive 2014/30/EU
EN 60950-1/VDE 0805 (SELV)
EN 50178/VDE 0160 (PELV)
DIN VDE 0100-410
UL/C-UL Listed UL 508, UL/C-UL Recognized UL 60950-1, UL ANSI/ISA-12.12.01 Class I, Division 2, Groups A, B, C, D (Hazardous Location)

Ordering data

Ordering data

Ordering data

Type	Order No.	Pcs./Pkt.
QUINT-PS/24DC/24DC/20/CO	2320568	1

Type	Order No.	Pcs./Pkt.
QUINT-PS/60-72DC/24DC/10/CO	2905011	1

Type	Order No.	Pcs./Pkt.
QUINT-PS/96-110DC/24DC/10/CO	2905012	1

DC/DC converters

MINI DC/DC converters

MINI POWER, 12 V DC to 60 V DC input

- Support conversion to various voltage levels
- Constant voltage: output voltage regenerated even at the end of long cables
- Electrical isolation: for setting up independent supply systems

MINI AC power module

- For connection upstream of MINI DC/DC converters
- The AC voltage of a transformer is rectified and filtered



DC/DC converter,
12 - 24 V DC / 24 V DC, 1 A

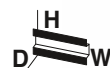

DC/DC converter,
12 - 24 V DC / 5 - 15 V DC, 2 A

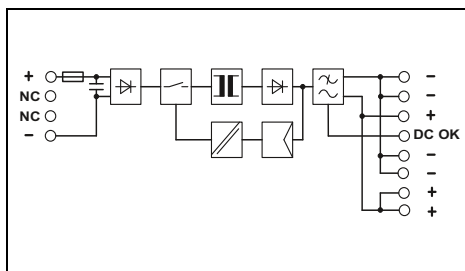

Technical data

Input data	
Nominal input voltage range	12 V DC ... 24 V DC
Current consumption (nominal load)	2.6 A (12 V DC) / 1.3 A (24 V DC)
Inrush current limitation at 25°C / I ² t	< 15 A / 1.8 A ² s
Output data	
Nominal output voltage (U _N)	24 V DC ±1%
Setting range of the output voltage (U _{Set})	22.5 V DC ... 28.5 V DC (> 24 V DC, constant capacity restricted)
Output current	1 A
Can be connected in parallel/series	Yes / yes
Max. power dissipation (no load/nominal load)	< 1.2 W / < 5 W
Efficiency	> 83% (at 24 V DC and nominal values)
Residual ripple	< 30 mV _{pp}
Signaling	
Signaling DC OK	LED, active switching output
General data	
Weight / Dimensions W x H x D	0.2 kg / 22.5 x 99 x 107 mm
Connection	alignable: horizontally 0 mm, vertically 50 mm
Connection method	Plug-in screw connection
Input connection data rigid / flexible / AWG	0.2 - 2.5 mm ² / 0.2 - 2.5 mm ² / 24 - 14
Output connection data rigid / flexible / AWG	0.2 - 2.5 mm ² / 0.2 - 2.5 mm ² / 24 - 14
Signal connection data rigid / flexible / AWG	0.2 - 2.5 mm ² / 0.2 - 2.5 mm ² / 24 - 14
Degree of protection / Protection class	IP20 / III
MTBF (IEC 61709, SN 29500)	> 2569000 h (40°C)
Ambient temperature (operation)	-25°C ... 70°C (> 60°C Derating: 2.5%/K)
Max. permissible relative humidity (operation)	≤ 95% (at 25°C, non-condensing)
Standards/regulations	
Insulation voltage input/output	1 kV (routine test) / 1.5 kV (type test)
Electromagnetic compatibility	Conformance with EMC Directive 2014/30/EU
Electrical safety	EN 60950-1/VDE 0805 (SELV)
Electronic equipm. for electrical power installations	EN 50178/VDE 0160 (PELV)
Safe isolation	DIN VDE 0100-410, DIN VDE 0106-101
UL approvals	UL/C-UL Listed UL 508, UL/C-UL Recognized UL 60950-1, UL ANSI/ISA-12.12.01 Class I, Division 2, Groups A, B, C, D (Hazardous Location)

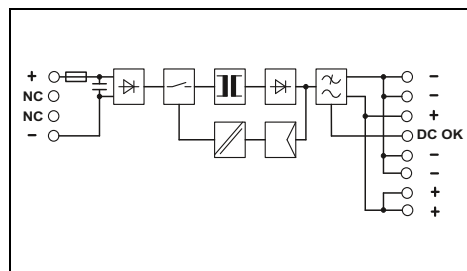

Technical data

Input data	
Nominal input voltage range	12 V DC ... 24 V DC
Current consumption (nominal load)	2.3 A (12 V DC) / 1.1 A (24 V DC)
Inrush current limitation at 25°C / I ² t	< 10 A / 0.2 A ² s
Output data	
Nominal output voltage (U _N)	12 V DC ±1%
Setting range of the output voltage (U _{Set})	5 V DC ... 15 V DC
Output current	2 A
Can be connected in parallel/series	Yes / yes
Max. power dissipation (no load/nominal load)	< 1 W / < 4.2 W
Efficiency	> 88% (at 24 V DC and nominal values)
Residual ripple	< 20 mV _{pp}
Signaling	
Signaling DC OK	LED, active switching output
General data	
Weight / Dimensions W x H x D	0.2 kg / 22.5 x 99 x 107 mm
Connection	alignable: horizontally 0 mm, vertically 50 mm
Connection method	Plug-in screw connection
Input connection data rigid / flexible / AWG	0.2 - 2.5 mm ² / 0.2 - 2.5 mm ² / 24 - 14
Output connection data rigid / flexible / AWG	0.2 - 2.5 mm ² / 0.2 - 2.5 mm ² / 24 - 14
Signal connection data rigid / flexible / AWG	0.2 - 2.5 mm ² / 0.2 - 2.5 mm ² / 24 - 14
Degree of protection / Protection class	IP20 / III
MTBF (IEC 61709, SN 29500)	> 2072000 h (40°C)
Ambient temperature (operation)	-25°C ... 70°C (> +60°C derating)
Max. permissible relative humidity (operation)	≤ 95% (At +25°C, non-condensing)
Standards/regulations	
Insulation voltage input/output	1 kV (routine test) / 1.5 kV (type test)
Electromagnetic compatibility	Conformance with EMC Directive 2014/30/EU
Electrical safety	EN 60950-1/VDE 0805 (SELV)
Electronic equipm. for electrical power installations	EN 50178/VDE 0160 (PELV)
Safe isolation	DIN VDE 0100-410, DIN VDE 0106-101
UL approvals	UL/C-UL Listed UL 508, UL/C-UL Recognized UL 60950-1, UL ANSI/ISA-12.12.01 Class I, Division 2, Groups A, B, C, D (Hazardous Location)

Ordering data

Description	Type	Order No.	Pcs./Pkt.
DC/DC converter, primary-switched	MINI-PS- 12- 24DC/24DC/1	2866284	1

Ordering data

Description	Type	Order No.	Pcs./Pkt.
DC/DC converter, primary-switched	MINI-PS- 12- 24DC/ 5-15DC/2	2320018	1



DC/DC converter,
12 - 24 V DC / 48 V DC, 0.7 A

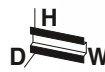

DC/DC converter,
48 - 60 V DC / 24 V DC, 1 A



AC power module
for MINI DC/DC converter

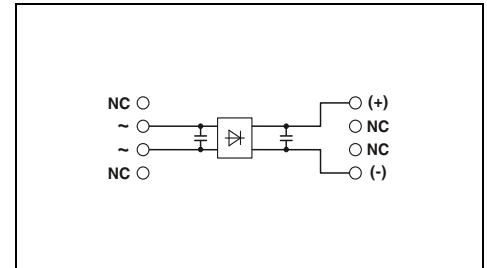
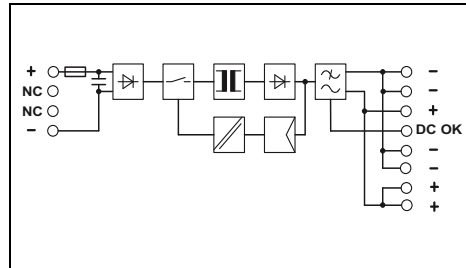
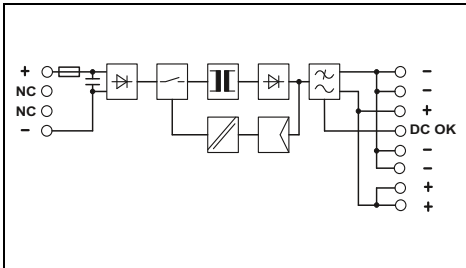

Technical data	
12 V DC ... 24 V DC	
3.2 A (12 V DC) / 1.6 A (24 V DC)	
< 10 A / 0.3 A ² s	
48 V DC ±1%	
30 V DC ... 56 V DC (> 48 V DC, constant capacity restricted)	
0.7 A	
Yes / yes	
< 1.5 W / < 4.5 W	
> 87% (at 24 V DC and nominal values)	
< 20 mV _{pp}	
LED, active switching output	
0.2 kg / 22.5 x 99 x 107 mm	
alignable: horizontally 0 mm, vertically 50 mm	
Plug-in screw connection	
0.2 - 2.5 mm ² / 0.2 - 2.5 mm ² / 24 - 14	
0.2 - 2.5 mm ² / 0.2 - 2.5 mm ² / 24 - 14	
0.2 - 2.5 mm ² / 0.2 - 2.5 mm ² / 24 - 14	
IP20 / III	
> 1993000 h (40°C)	
-25°C ... 70°C (> +60°C derating)	
≤ 95% (At +25°C, non-condensing)	
1 kV (routine test) / 1.5 kV (type test)	
Conformance with EMC Directive 2014/30/EU	
EN 60950-1/VDE 0805 (SELV)	
EN 50178/VDE 0160 (PELV)	
DIN VDE 0100-410, DIN VDE 0106-101	
UL/C-UL Listed UL 508, UL/C-UL Recognized UL 60950-1, UL ANSI/ISA-12.12.01 Class I, Division 2, Groups A, B, C, D (Hazardous Location)	

Technical data	
48 V DC ... 60 V DC	
0.6 A (48 V DC) / 0.5 A (60 V DC)	
< 15 A / 1.8 A ² s	
24 V DC ±1%	
22.5 V DC ... 28.5 V DC (> 24 V DC, constant capacity restricted)	
1 A	
Yes / yes	
< 1.2 W / < 5 W	
> 85% (at 60 V DC and nominal values)	
< 40 mV _{pp}	
LED, active switching output	
0.2 kg / 22.5 x 99 x 107 mm	
alignable: horizontally 0 mm, vertically 50 mm	
Plug-in screw connection	
0.2 - 2.5 mm ² / 0.2 - 2.5 mm ² / 24 - 14	
0.2 - 2.5 mm ² / 0.2 - 2.5 mm ² / 24 - 14	
0.2 - 2.5 mm ² / 0.2 - 2.5 mm ² / 24 - 14	
IP20 / II	
> 1147000 h (40°C)	
-25°C ... 70°C (> 60°C Derating: 2.5%/K)	
≤ 95% (at 25°C, non-condensing)	
1 kV (routine test) / 1.5 kV (type test)	
Conformance with EMC Directive 2014/30/EU	
EN 60950-1/VDE 0805 (SELV)	
EN 50178/VDE 0160 (PELV)	
DIN VDE 0100-410, DIN VDE 0106-101	
UL/C-UL Listed UL 508, UL/C-UL Recognized UL 60950-1, UL ANSI/ISA-12.12.01 Class I, Division 2, Groups A, B, C, D (Hazardous Location)	

Technical data	
10 V AC ... 42 V AC	
6.5 A	
< 45 A / 8 A ² s	
28 V DC ±1%	
-	
3 A	
Yes / No	
< 0.04 W / < 6.9 W	
> 95.7% (For 42 V AC and nominal values)	
< 3.6 V _{pp}	
-	
0.16 kg / 22.5 x 99 x 107 mm	
alignable: horizontally 0 mm, vertically 50 mm	
Plug-in screw connection	
0.2 - 2.5 mm ² / 0.2 - 2.5 mm ² / 24 - 12	
0.2 - 2.5 mm ² / 0.2 - 2.5 mm ² / 24 - 12	
- mm ² / - mm ² / -	
IP20 / III	
> 18175000 h (40°C)	
-25°C ... 70°C (> 60°C Derating: 2.5%/K)	
≤ 95% (at 25°C, non-condensing)	
- / -	
Conformance with EMC Directive 2014/30/EU	
EN 60950-1/VDE 0805 (SELV)	
EN 50178/VDE 0160 (PELV)	
-	
UL/C-UL Listed UL 508, UL/C-UL Recognized UL 60950-1	

Ordering data		
Type	Order No.	Pcs./Pkt.
MINI-PS- 12- 24DC/48DC/0.7	2320021	1

Ordering data		
Type	Order No.	Pcs./Pkt.
MINI-PS- 48- 60DC/24DC/1	2866271	1

Ordering data		
Type	Order No.	Pcs./Pkt.
MINI-PS- 10- 42AC/15-60DC/3	2320199	1



Maximum availability due to redundancy modules

To prevent errors influencing the load in a redundant system and to increase operational reliability, the power supplies must be decoupled from one another using a redundancy module. Phoenix Contact offers various solutions depending on the requirements:

Decoupling with diodes from the QUINT, TRIO, UNO, and STEP ranges

If the power supplies are decoupled, a short circuit at the output of one of the power supplies or in the supply line from the power supply to the diode no longer has any effect on the load.

Decoupling, monitoring, and closed-loop control by means of the QUINT ORING active redundancy modules

The QUINT ORING active redundancy modules monitor the entire redundant solution, i.e., the power supply unit voltages, the wiring, decoupling, and the load current. Critical operating states can therefore be detected at an early stage and redundancy can be restored. E.g., incorrect wiring or faulty cables are indicated.

QUINT ORING with ACB technology doubles the service life of the redundant system:

As a result of asymmetries, the load is often supplied by one power supply unit, while the other runs in no-load operation. This results in a thermal overload of the working power supply unit and thereby rapid aging. If the power supply unit is operated at half the nominal current, it remains significantly cooler.

The ACB technology of the QUINT ORING modules ensures symmetrical loading of the power supplies and thereby up to double the service life of the redundant system.

Decoupling and monitoring by means of the QUINT S-ORING active redundancy modules

The QUINT S-ORING active redundancy modules consistently monitor the redundant system, in combination with the new QUINT POWER power supplies. The QUINT S-ORING modules enable you to guide the cable redundantly and separately to the load.

QUINT S-ORING with protective coating with OVP (overvoltage protection) protects downstream consumers from surge voltages greater than 30 V DC.

The QUINT S-ORING single-channel redundancy module provides maximum operational safety

In combination with the fourth generation of the QUINT POWER power supplies, the input voltage and decoupling section are monitored continuously. The preventive function monitoring feature indicates all critical operating states of the redundant system.

ACB technology doubles the service life

The ACB (Auto Current Balancing) technology ensures symmetrical loading of the power supplies, thereby reducing the operating temperature. This means up to double the service life of the redundant system.

i Your web code: #0153



QUINT ORING for maximum system availability

Consistent monitoring of the redundant system, with energy savings of up to 70%.

- ACB technology
- Two positive output terminals
- Voltage limitation to < 32 V DC (+Version)



The QUINT S-ORING single-channel redundancy module provides maximum operational safety

In combination with the fourth generation of the QUINT POWER power supplies, the input voltage and decoupling section are monitored continuously. The preventive function monitoring feature indicates all critical operating states of the redundant system.

- Separate cable guidance up to the load
- Voltage limitation to < 30 V DC/28.8 V DC (VP/plus version)



Redundancy module QUINT DIODE

- High system availability, thanks to the robust design
- Safe decoupling of power supplies connected in parallel
- Flexible: nominal voltages of 12 V DC to 48 V DC



TRIO DIODE redundancy module

- Safe decoupling of power supplies connected in parallel
- Quick and easy installation, thanks to Push-in connection technology
- System compatible with TRIO POWER power supplies



UNO DIODE redundancy module

- Consistent redundancy up to the load
- Flexible: nominal voltages of 5 V DC to 24 V DC



STEP DIODE redundancy module

- Space-saving: overall width of just 18 mm
- Consistent redundancy up to the load
- Flexible: nominal voltages of 5 V DC to 24 V DC

QUINT ORING

QUINT ORING, 24 V DC

- Preventive function monitoring
- Continuous redundancy right through to the load: the use of two Plus output terminal blocks makes it possible to devise a redundant wiring concept that runs right through to the load
- Double the service life of the redundant solution, thanks to even load distribution: the ACB (Auto Current Balancing) technology automatically and symmetrically distributes the load current to two power supplies operating in parallel
- Save energy: decoupling is achieved with MOSFETs and results in energy savings of up to 70% compared to conventional diodes
- OVP (overvoltage protection): surge voltages are limited to 32 V

QUINT ORING, with protective coating

With ATEX approval for superior system availability under extreme ambient conditions, such as dust, dirt, corrosive gases, and 100% humidity

- Devices compliant with standards EN 60079-15 and EN 60079-0 may be installed in a potentially explosive area
- Suitable for use in Class I, Division 2



Auto Current Balancing Technology[®]
Copyright © 2012 Phoenix Contact



Active redundancy module, with protective coating, 24 V DC, 2 x 10 A, 1 x 20 A

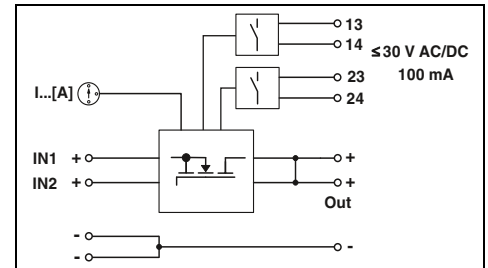

Technical data

Input data	24 V DC 18 V DC ... 28 V DC 2x 10 A (-25°C ... 60°C) 1x 20 A (-25°C ... 60°C) 2x 15 A (-25°C ... 40°C) 1x 30 A (-25°C ... 40°C) Varistor 0.1 V (I _{OUT} = 20 A) 2 W (I _{OUT} = 20 A)
Nominal input voltage range	
Input voltage range	
Nominal current	
Maximum current	0.4 kg / 32 x 130 x 125 mm alignable: 5 mm horizontally, 15 mm next to active components, 50 mm vertically Screw connection 0.2 - 4 mm ² / 0.2 - 2.5 mm ² / 14 - 12 0.2 - 6 mm ² / 0.2 - 4 mm ² / 10 IP20 / III -25°C ... 70°C (> 60°C Derating: 2.5%/K)
Transient surge protection	
Voltage drop, input/output	
Max. power dissipation (nominal load)	
General data	500 V Conformance with EMC Directive 2014/30/EU EN 60950-1/VDE 0805 (SELV) EN 50178/VDE 0160 (PELV) UL/C-UL Listed UL 508, UL/C-UL Recognized UL 60950-1, UL ANSI/ISA-12.12.01 Class I, Division 2, Groups A, B, C, D (Hazardous Location)
Weight / Dimensions W x H x D	
Connection	
Connection method	
Input connection data rigid / flexible / AWG	
Output connection data rigid / flexible / AWG	
Degree of protection / Protection class	
Ambient temperature (operation)	
Standards/regulations	
Insulation voltage: input, output/housing	
Electromagnetic compatibility	
Electrical safety	
Electronic equipm. for electrical power installations	
UL approvals	

Ordering data

Description	Type	Order No.	Pcs./Pkt.
Active redundancy module	QUINT-ORING/24DC/2X10/1X20	2320173	1



Auto Current Balancing Technology[®]



Active redundancy module, with protective coating, 24 V DC, 2 x 20 A, 1 x 40 A



Auto Current Balancing Technology[®]



Active redundancy module 24 V DC, 2 x 40 A, 1 x 80 A

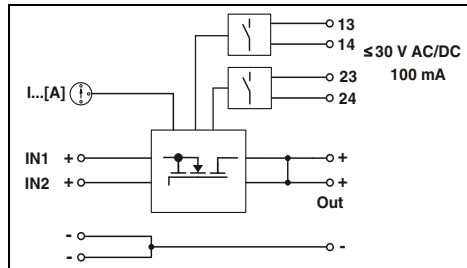
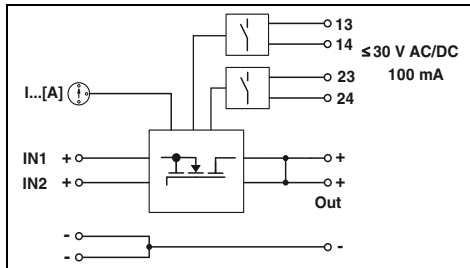

Technical data

24 V DC
18 V DC ... 28 V DC
2x 20 A (-25°C ... 60°C)
1x 40 A (-25°C ... 60°C)
2x 26 A (-25°C ... 40°C)
1x 52 A (-25°C ... 40°C)
Varistor
0.2 V (I_{OUT} = 40 A)
8 W (I_{OUT} = 40 A)

0.6 kg / 38 x 130 x 125 mm
alignable: 5 mm horizontally, 15 mm next to active components, 50 mm vertically
Screw connection
0.2 - 6 mm² / 0.2 - 4 mm² / 10
0.5 - 16 mm² / 0.5 - 16 mm² / 6
IP20 / III
-25°C ... 70°C (> 60°C Derating: 2.5%/K)

500 V
Conformance with EMC Directive 2014/30/EU
EN 60950-1/VDE 0805 (SELV)
EN 50178/VDE 0160 (PELV)
UL/C-UL Listed UL 508, UL/C-UL Recognized UL 60950-1, UL ANSI/ISA-12.12.01 Class I, Division 2, Groups A, B, C, D (Hazardous Location)

Ordering data

Type	Order No.	Pcs./Pkt.
QUINT-ORING/24DC/2X20/1X40	2320186	1

Technical data

24 V DC
18 V DC ... 28 V DC
2x 40 A (-25°C ... 60°C)
1x 80 A (-25°C ... 60°C)
2x 45 A (-25°C ... 40°C)
1x 90 A (-25°C ... 40°C)
Varistor
0.2 V (I_{OUT} = 80 A)
16 W (I_{OUT} = 80 A)

0.9 kg / 66 x 130 x 125 mm
alignable: 5 mm horizontally, 15 mm next to active components, 50 mm vertically
Screw connection
0.5 - 16 mm² / 0.5 - 16 mm² / 6
0.5 - 35 mm² / 0.5 - 35 mm² / 2
IP20 / III
-25°C ... 70°C (> 60°C Derating: 2.5%/K)

500 V
Conformance with EMC Directive 2014/30/EU
EN 60950-1/VDE 0805 (SELV)
EN 50178/VDE 0160 (PELV)
UL/C-UL Listed UL 508, UL/C-UL Recognized UL 60950-1, UL ANSI/ISA-12.12.01 Class I, Division 2, Groups A, B, C, D (Hazardous Location)

Ordering data

Type	Order No.	Pcs./Pkt.
QUINT-ORING/24DC/2X40/1X80	2902879	1

QUINT ORING

QUINT S-ORING, 12 - 24 V DC

- Consistent redundancy: separate cable guidance up to the consumer
- Preventive function monitoring
- Save energy: disconnection is implemented with MOSFETs and therefore has very low power dissipation
- Suitable for use in Class I, Division 2

QUINT S-ORING, VP version and plus version with ATEX approval, with protective coating

- With protective coating for superior system availability under extreme ambient conditions, such as dust, dirt, corrosive gases, and 100% humidity
- Devices compliant with standards EN 60079-15 and EN 60079-0 may be installed in a potentially explosive area

QUINT S-ORING, VP version

- OVP (overvoltage protection): surge voltages are limited to 30 V

QUINT S-ORING, plus version

- OVP (overvoltage protection): surge voltages are limited to 28.8 V



Active redundancy module
12 - 24 V DC, 1 x 40 A

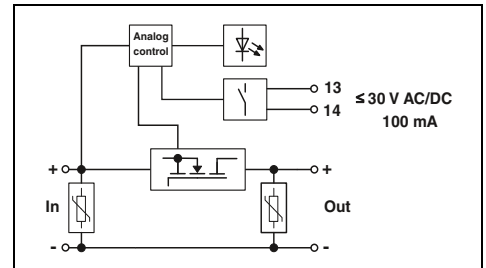

Technical data

Input data	12 V DC ... 24 V DC 8 V DC ... 30 V DC 40 A (-40°C ... 60°C) 45 A (40°C) / 60 A (5 s) / 215 A (15 ms)
Transient surge protection	Varistor
Voltage drop, input/output	0.1 V
Max. power dissipation (nominal load)	6.5 W ($I_{OUT} = 40 A$)
General data	
Weight / Dimensions W x H x D	0.55 kg / 32 x 130 x 125 mm
Connection	alignable: 5 mm horizontally, 15 mm next to active components, 50 mm vertically
Connection method	Screw connection
Input connection data rigid / flexible / AWG	0.5 - 16 mm ² / 0.5 - 16 mm ² / 20 - 6
Output connection data rigid / flexible / AWG	0.5 - 16 mm ² / 0.5 - 16 mm ² / 20 - 6
Degree of protection / Protection class	IP20 / III
Ambient temperature (operation)	-40°C ... 70°C (> 60°C Derating: 2.5%/K)
Standards/regulations	
Insulation voltage: input, output/housing	500 V DC
Electromagnetic compatibility	Conformance with EMC Directive 2014/30/EU
Electrical safety	EN 60950-1/VDE 0805 (SELV)
Electronic equipm. for electrical power installations	EN 50178/VDE 0160 (PELV)
UL approvals	UL/C-UL Listed UL 508, UL/C-UL Recognized UL 60950-1, UL ANSI/ISA-12.12.01 Class I, Division 2, Groups A, B, C, D (Hazardous Location)

Ordering data

Description	Type	Order No.	Pcs./Pkt.
Active redundancy module	QUINT4-S-ORING/12-24DC/1X40	2907752	1

new



Active redundancy module,
with protective coating,
12 - 24 V DC, 1x 40 A, VP



Active redundancy module,
with protective coating,
12 - 24 V DC, 1x 40 A, plus version



Ex:

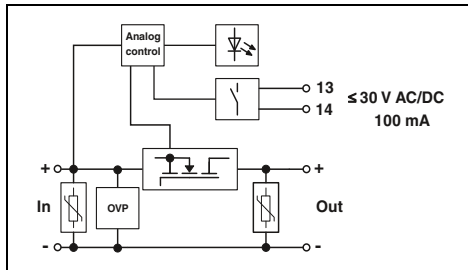

Technical data

12 V DC ... 24 V DC
8 V DC ... 27.5 V DC
40 A (-40°C ... 60°C)
45 A (40°C) / 60 A (5 s) / 215 A (15 ms)

Varistor
0.1 V DC
6.5 W (I_{OUT} = 40 A)

0.4 kg / 32 x 130 x 125 mm
alignable: 5 mm horizontally, 15 mm next to active components,
50 mm vertically
Screw connection
0.5 - 16 mm² / 0.5 - 16 mm² / 20 - 6
0.5 - 16 mm² / 0.5 - 16 mm² / 20 - 6
IP20 / III
-40°C ... 70°C (> 60°C Derating: 2.5%/K)

500 V DC
Conformance with EMC Directive 2014/30/EU
EN 60950-1/VDE 0805 (SELV)
EN 50178/VDE 0160 (PELV)
UL/C-UL Listed UL 508, UL/C-UL Recognized UL 60950-1,
UL ANSI/ISA-12.12.01 Class I, Division 2, Groups A, B, C, D
(Hazardous Location)

Ordering data

Type	Order No.	Pcs./Pkt.
QUINT4-S-ORING/12-24DC/1X40/VP	1043418	1

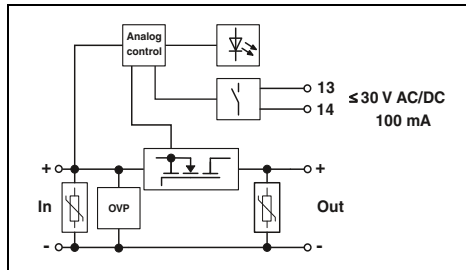

Technical data

12 V DC ... 24 V DC
8 V DC ... 26 V DC
40 A (-40°C ... 60°C)
45 A (40°C) / 60 A (5 s) / 215 A (15 ms)

Varistor
0.1 V DC
6.5 W (I_{OUT} = 40 A)

0.4 kg / 32 x 130 x 125 mm
alignable: 5 mm horizontally, 15 mm next to active components,
50 mm vertically
Screw connection
0.5 - 16 mm² / 0.5 - 16 mm² / 20 - 6
0.5 - 16 mm² / 0.5 - 16 mm² / 20 - 6
IP20 / III
-40°C ... 70°C (> 60°C Derating: 2.5%/K)

500 V DC
Conformance with EMC Directive 2014/30/EU
EN 60950-1/VDE 0805 (SELV)
EN 50178/VDE 0160 (PELV)
UL/C-UL Listed UL 508, UL/C-UL Recognized UL 60950-1,
UL ANSI/ISA-12.12.01 Class I, Division 2, Groups A, B, C, D
(Hazardous Location)

Ordering data

Type	Order No.	Pcs./Pkt.
QUINT4-S-ORING/12-24DC/1X40/+	2907753	1

QUINT DIODE diode modules

QUINT DIODE, 12 - 24 V DC and 48 V DC

- Robust design for currents of up to 60 A
- Continuous redundancy right through to the load: the use of two Plus output terminal blocks makes it possible to devise a redundant wiring concept that runs right through to the load.
- Consistent wiring with large conductor cross sections, thanks to same size of input and output terminals
- Flexible: nominal voltages of 12 V DC to 48 V DC
- Devices compliant with standards EN 60079-15 and EN 60079-0 may be installed in a potentially explosive area
- Suitable for use in Class I, Division 2



**Diode module,
12 - 24 V DC, 2 x 20 A, 1 x 40 A**

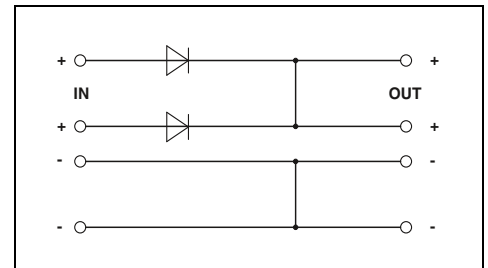

Technical data

Input data	
Nominal input voltage range	12 V DC ... 24 V DC 12 V DC ... 24 V DC
Input voltage range	10 V DC ... 30 V DC 10 V DC ... 30 V DC
Nominal current	2x 20 A (-40°C ... 60°C) 1x 40 A (-40°C ... 60°C)
Maximum current	2x 30 A (-40°C ... 40°C) 1x 60 A (-40°C ... 40°C)
Transient surge protection	Varistor
Voltage drop, input/output	0.5 V
Max. power dissipation (nominal load)	10 W (I _{OUT} = 20 A)
General data	
Weight / Dimensions W x H x D	0.75 kg / 50 x 130 x 125 mm
Connection	alignable: 5 mm horizontally, 15 mm next to active components, 50 mm vertically
Connection method	Screw connection
Input connection data rigid / flexible / AWG	0.5 - 16 mm ² / 0.5 - 16 mm ² / 10 - 6
Output connection data rigid / flexible / AWG	0.5 - 16 mm ² / 0.5 - 16 mm ² / 10 - 6
Degree of protection / Protection class	IP20 / III
Ambient temperature (operation)	-40°C ... 70°C (> 60°C Derating: 2.5%/K)
Standards/regulations	
Insulation voltage: input, output/housing	500 V
Electromagnetic compatibility	Conformance with EMC Directive 2014/30/EU
Electrical safety, safety transformer	EN 60950-1/VDE 0805 (SELV)
Electronic equipm. for electrical power installations	EN 50178/VDE 0160 (PELV)
UL approvals	UL/C-UL Listed UL 508, UL/C-UL Recognized UL 60950-1, UL ANSI/ISA-12.12.01 Class I, Division 2, Groups A, B, C, D (Hazardous Location)

Ordering data

Description	Type	Order No.	Pcs./Pkt.
Diode module	QUINT4-DIODE/12-24DC/2X20/1X40	2907719	1



**Diode module,
48 V DC, 2x 20 A, 1x 40 A**

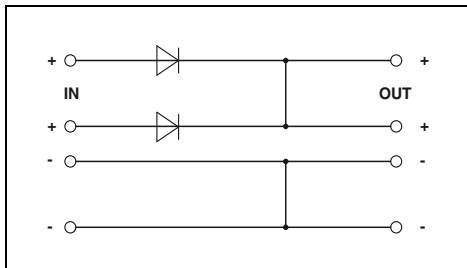

Technical data

48 V DC
48 V DC
30 V DC ... 56 V DC
30 V DC ... 56 V DC
2x 20 A (-40°C ... 60°C)
1x 40 A (-40°C ... 60°C)
2x 30 A (-40°C ... 40°C)
1x 60 A (-40°C ... 40°C)
Varistor
0.7 V
14 W ($I_{OUT} = 20$ A)

0.75 kg / 50 x 130 x 125 mm
alignable: 5 mm horizontally, 15 mm next to active components,
50 mm vertically
Screw connection
0.5 - 16 mm² / 0.5 - 16 mm² / 10 - 6
0.5 - 16 mm² / 0.5 - 16 mm² / 10 - 6
IP20 / III
-40°C ... 70°C (> 60°C Derating: 2.5%/K)

500 V
Conformance with EMC Directive 2014/30/EU
EN 60950-1/VDE 0805 (SELV)
EN 50178/VDE 0160 (PELV)
UL/C-UL Listed UL 508, UL/C-UL Recognized UL 60950-1,
UL ANSI/ISA-12.12.01 Class I, Division 2, Groups A, B, C, D
(Hazardous Location)

Ordering data

Type	Order No.	Pcs./Pkt.
QUINT4-DIODE/48DC/2X20/1X40	2907720	1

Redundancy modules

TRIO DIODE, UNO DIODE, and STEP DIODE diode modules

TRIO DIODE

- Space-saving: overall width of just 35 mm and 41 mm
- Safe decoupling of power supplies connected in parallel
- Quick and easy installation, thanks to Push-in connection technology
- System compatible with TRIO POWER power supplies

UNO DIODE

- Space-saving: overall width of just 22.5 mm
- Continuous redundancy right through to the load: the use of two Plus output terminal blocks makes it possible to devise a redundant wiring concept that runs right through to the load
- Flexible: nominal voltages of 5 V DC to 24 V DC

STEP DIODE

- Space-saving: overall width of just 18 mm
- Continuous redundancy right through to the load: the use of two Plus output terminal blocks makes it possible to devise a redundant wiring concept that runs right through to the load
- Flexible: nominal voltages of 5 V DC to 24 V DC



Diode module,
12 ... 24 V DC, 2 x 10 A, 1 x 20 A

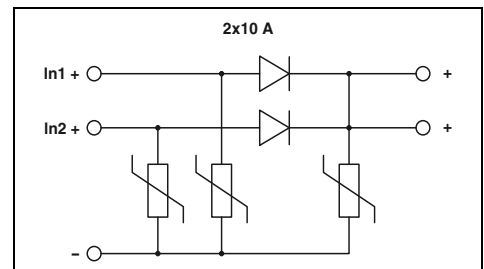

Technical data

Input data	
Nominal input voltage range	12 V DC ... 24 V DC
Input voltage range	10 V DC ... 30 V DC
Nominal current	2x 10 A (-25°C ... 60°C) 1x 20 A (-25°C ... 60°C) 2x 15 A (-25°C ... 40°C) 1x 30 A (-25°C ... 40°C)
Maximum current	Varistor 0,5 V 5 W (I _{OUT} = 10 A)
Transient surge protection	
Voltage drop, input/output	
Max. power dissipation (nominal load)	
General data	
Weight / Dimensions W x H x D	0,4 kg / 35 x 130 x 115 mm
Connection	alignable: horizontally 0 mm, vertically 50 mm
Connection method	Push-in connection
Input connection data rigid / flexible / AWG	0,2 - 4 mm ² / 0,2 - 2,5 mm ² / 24 - 12
Output connection data rigid / flexible / AWG	0,2 - 2,5 mm ² / 0,2 - 2,5 mm ² / 24 - 14
Degree of protection / Protection class	IP20 / III
Ambient temperature (operation)	-25°C ... 70°C (> 60°C Derating: 2.5%/K)
Standards/regulations	
Insulation voltage: input, output/housing	500 V
Electromagnetic compatibility	Conformance with EMC Directive 2014/30/EU
Electrical safety, safety transformer	IEC 60950-1/VDE 0805 (SELV)
Electronic equipm. for electrical power installations	EN 50178/VDE 0160 (PELV)
UL approvals	UL/C-UL Listed UL 508, UL/C-UL Recognized UL 60950-1

Ordering data

Description	Type	Order No.	Pcs./Pkt.
Redundancy module	TRIO2-DIODE/12-24DC/2X10/1X20	2907380	1



Diode module,
12 ... 24 V DC, 2 x 20 A, 1 x 40 A



Diode module,
5 ... 24 V DC, 2 x 10 A, 1 x 20 A



Diode module
5 - 24 V DC, 2x 5 A, 1x 10 A

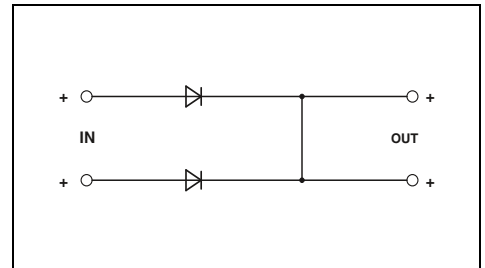
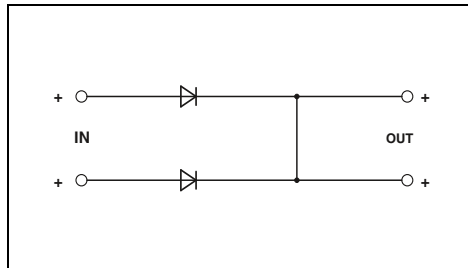
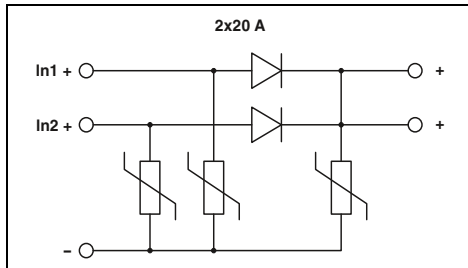

Technical data

Technical data

Technical data

12 V DC ... 24 V DC

10 V DC ... 30 V DC
2x 20 A (-25°C ... 60°C)
1x 40 A (-25°C ... 60°C)
2x 25 A (-25°C ... 40°C)
1x 50 A (-25°C ... 40°C)

Varistor
0.5 V
10 W (I_{OUT} = 20 A)

0.4 kg / 41 x 130 x 115 mm
alignable: horizontally 0 mm, vertically 50 mm
Push-in connection
0.2 - 4 mm² / 0.2 - 2.5 mm² / 24 - 12
0.2 - 2.5 mm² / 0.2 - 2.5 mm² / 24 - 14
IP20 / III
-25°C ... 70°C (> 60°C Derating: 2.5%/K)

500 V
Conformance with EMC Directive 2014/30/EU
IEC 60950-1/VDE 0805 (SELV)
EN 50178/VDE 0160 (PELV)
UL/C-UL Listed UL 508, UL/C-UL Recognized UL 60950-1

5 V DC ... 24 V DC

4.5 V DC ... 30 V DC
2x 10 A (-25°C ... 55°C)
1x 20 A (-25°C ... 55°C)

-
Varistor
0.5 V
5 W (I_{OUT} = 10 A)

0.2 kg / 22.5 x 90 x 84 mm
alignable: 0 mm horizontally, 30 mm vertically
Screw connection
0.2 - 2.5 mm² / 0.2 - 2.5 mm² / 24 - 14
0.2 - 2.5 mm² / 0.2 - 2.5 mm² / 24 - 14
IP20 / III
-25°C ... 70°C (> 55°C Derating: 2.5%/K)

500 V
Conformance with EMC Directive 2014/30/EU
IEC 60950-1/VDE 0805 (SELV)
EN 50178/VDE 0160 (PELV)
UL/C-UL Listed UL 508, UL/C-UL Recognized UL 60950-1

5 V DC ... 24 V DC
5 V DC ... 24 V DC
4.5 V DC ... 30 V DC
2x 5 A (-25°C ... 55°C)
1x 10 A (-25°C ... 55°C)

-
Transil diode
0.5 V
2.5 W (I_{OUT} = 5 A)

0.1 kg / 18 x 90 x 61 mm
alignable: 0 mm horizontally, 30 mm vertically
Screw connection
0.2 - 2.5 mm² / 0.2 - 2.5 mm² / 24 - 12
0.2 - 2.5 mm² / 0.2 - 2.5 mm² / 24 - 12
IP20 / III
-25°C ... 70°C (> 55°C derating : 2.5%/K)

500 V
Conformance with EMC Directive 2014/30/EU
IEC 60950-1/VDE 0805 (SELV)
EN 50178/VDE 0160 (PELV)
UL/C-UL Listed UL 508, UL/C-UL Recognized UL 60950-1

Ordering data

Ordering data

Ordering data

Type	Order No.	Pcs./Pkt.
TRIO2-DIODE/12-24DC/2X20/1X40	2907379	1

Type	Order No.	Pcs./Pkt.
UNO-DIODE/5-24DC/2X10/1X20	2905489	1

Type	Order No.	Pcs./Pkt.
STEP-DIODE/5-24DC/2X5/1X10	2868606	1

Power supply units and UPS

Power supply accessories

Mounting on S7-300 rail

To supply a SIMATIC® S7-300 control unit, QUINT POWER 2.5 A, 5 A, and 10 A are mounted on the S7 rail using a QUINT-PS-ADAPTER-S7.

No further accessories are required for fastening.



Dimensions W x H x D
Material

Technical data			Technical data		
74 / 130 / 11 mm Aluminum			104 / 130 / 11 mm Aluminum		
Ordering data			Ordering data		
Type	Order No.	Pcs./Pkt.	Type	Order No.	Pcs./Pkt.
QUINT-PS-ADAPTERS7/1	2938196	1	QUINT-PS-ADAPTERS7/2	2938206	1

Description

Adapter for S7-300 rail mounting, for:

QUINT-PS/1AC/24DC/3.5
QUINT-PS/1AC/24DC/5
QUINT-PS/3AC/24DC/5

Adapter for S7-300 rail mounting, for:

QUINT-PS/1AC/24DC/10
QUINT-PS/3AC/24DC/10
QUINT-PS/3AC/24DC/20

Fan and potential distributor

With the standard power supply mounting position, the temperature range increases by 10 K (max. ambient temperature of 70°C), when the mounting position is rotated, position-dependent derating no longer applies.

– Tool-free mounting

Potential distributor

Further modules can be found in Catalog 5, Interface technology and switching devices

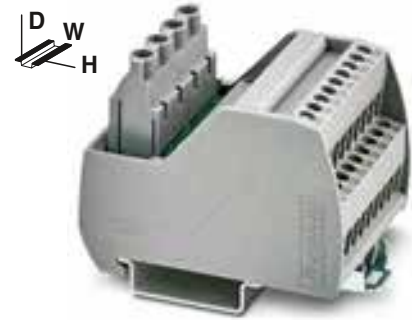

With screw connection and 2 potential levels

Dimensions W x H x D

Technical data			Technical data		
41 / 27 / 42.2 mm			50 / 65.5 / 50 mm		
Ordering data			Ordering data		
Type	Order No.	Pcs./Pkt.	Type	Order No.	Pcs./Pkt.
QUINT-PS-FAN/4	2320076	1	VIP-2/SC/PDM-2/16	2315256	1
			VIP-2/SC/PDM-2/24	2315269	1
			VIP-2/SC/PDM-2/32	2315272	1
			VIP-2/SC/PDM-2/48	2903717	1

Description

Fan for QUINT POWER SFB, 24 V DC

VARIOFACE module, with two busbars (P1, P2) for potential distribution, per potential:

2 power terminal blocks/8 distributor terminal blocks
2 power terminal blocks/12 distributor terminal blocks
2 power terminal blocks/16 distributor terminal blocks
2 power terminal blocks/24 distributor terminal blocks

Universal wall adapter

Adapter for mounting on even surfaces



	Technical data			Technical data		
Dimensions W x H x D	52 / 182 / 9 mm			25 / 130 / 17 mm		
Material	Steel, powder-coated			Steel, powder-coated		
	Ordering data			Ordering data		
Description	Type	Order No.	Pcs./Pkt.	Type	Order No.	Pcs./Pkt.
Universal wall adapter , for mounting the TRIO-PS (from 10 A), QUINT-PS, QUINT-DC-UPS, and QUINT-BUFFER power supplies directly on the wall	UWA 182/52	2938235	1			
Universal wall adapter , for mounting the QUINT-PS/1AC/24DC/40 and QUINT-UPS/1AC/1AC/500VA power supplies directly on the wall				UWA 130	2901664	1

Pluggable thermomagnetic circuit breakers

- Device circuit breakers for protecting against overcurrents and short circuits
- SFB characteristic curve enables longer cables and tripping times < 10 ms
- Maximum ease of maintenance, thanks to the two-piece design
- Further circuit breakers can be found from page 359 onwards

Notes:
For additional technical data, drawings, and accessories, please visit phoenixcontact.net/products.



Pluggable, SFB characteristic curve

	Technical data		
Dimensions W/H/D	12.3 mm / 90 mm / 77.3 mm		
Degree of protection	IP30 (Actuation area)		
	Ordering data		
Description	Type	Order No.	Pcs./Pkt.
Thermomagnetic circuit breaker , pluggable, 1-pos., signal contact 1 PDT			
	0.5 A	CB TM1 0.5A SFB P	2800835 1
	1 A	CB TM1 1A SFB P	2800836 1
	2 A	CB TM1 2A SFB P	2800837 1
	3 A	CB TM1 3A SFB P	2800838 1
	4 A	CB TM1 4A SFB P	2800839 1
	5 A	CB TM1 5A SFB P	2800840 1
	6 A	CB TM1 6A SFB P	2800841 1
	Accessories		
Base element , for accommodating CB TM.../CB E... device circuit breakers			
With Push-in connection technology	CB 1/6-2/4 PT-BE	2800929	10
With screw connection technology	CB 1/10-1/10 UT-BE	2801305	10



The intelligent UPS system ensures superior system availability

Uninterruptible power supplies (UPS) continue to deliver power even in the event of mains failure. An uninterruptible solution consists of three function units:

- Power supply
- UPS module
- Energy storage

QUINT DC UPS

The first intelligent QUINT DC UPS can be easily integrated into any established industrial network via various interfaces. Your systems continue to be supplied with uninterrupted power, even in the event of mains failure. The battery management system with IQ Technology and a very powerful battery charger ensures superior system availability.

IQ Technology and battery management system

Superior system availability is ensured by continuous evaluation of the state of charge (SOC) and by the intelligent battery management system (BMS). It describes the current state of charge and indicates the remaining energy storage life. Connected battery types are automatically detected and their remaining service life is maximized, thanks to an optimally adjusted charging characteristic. Intelligent charging adapts the charging current, thereby ensuring the

fastest possible recharging and availability. Reliable supply of the load is ensured by load prioritization. SOH (state of health) intelligent battery management indicates the remaining energy storage life and warns of pending failure in good time.

Extended load management

The extended load management system of the QUINT DC UPS consists of the following functions:

- Energy monitoring – monitoring of input and output voltages and the associated currents
- A 24 V output of the UPS can be switched on and off remotely
- PC shutdown function – reliable shutdown of the IPC in the event of mains failure without data loss, and autostart of the IPC when power returns
- Cold restart function – UPS startup even without mains power

2-port switch

These uninterruptible power supplies can be flexibly integrated into existing industrial networks using the built-in 2-port switch.

Function blocks and device descriptions

If the appropriate function block for your application is not available, you can create your own custom function blocks using our device descriptions.

Space-saving versions

Our UPS versions with integrated energy storage device or integrated power supply save space in the control cabinet.

Selection guide

Find the right UPS for your application based on the buffer time and load current from page 314.

i Your web code: **#0154**



IQ Technology for an intelligent UPS system

With its IQ Technology and the industry's strongest battery charger, the battery management system ensures superior system availability.

- Automatic battery detection: VRLA, VRLA-WTR or LiFePO4 battery technologies with different capacities
- IQ Technology: reliably determines the remaining service life in months and remaining buffer time in minutes



Industrial Ethernet

The QUINT DC UPS can be easily integrated into any Industrial Ethernet network via various interfaces:

- PROFINET
- EtherNet/IP™
- EtherCAT®

All network technologies are available in all four performance classes (5 A, 10 A, 20 A, and 40 A).



Function blocks and device descriptions

So that the QUINT DC UPS can be started up quickly and easily, we include the corresponding function blocks for the following engineering environments:

- PC Worx
- TIA Portal
- Studio 5000
- TwinCAT

If the appropriate function block for your application is not available, you can create your own custom function blocks using our device descriptions.



AC UPS

The AC UPS delivers a pure sine curve at the output. The sine generated in battery operation is synchronous with the mains previously used for supply.

QUINT UPS with IQ Technology

- Optimum use of the buffer time (SOC) and preventive monitoring of the energy storage device (SOH)

TRIO AC UPS

- Space-saving, as the UPS module and energy storage are combined in one housing



UPS with integrated energy storage

Particularly space-saving and easy to retrofit, the UPS module and energy storage device are combined in the same housing.

- QUINT UPS: energy storage device with lead AGM technology
- STEP UPS: LiPo-based energy storage device
- UNO UPS: energy storage with lead AGM technology
- QUINT BUFFER buffer module and QUINT CAP: capacitor-based energy storage



UPS with integrated power supply

The UPS module and power supply combined in one housing provides a space-saving solution. Only one energy storage device is required to complete the UPS system.

- MINI UPS: for 24 or 12 V DC
- TRIO UPS: for 24 DC

Power supply units and UPS

Uninterruptible power supplies

Selecting the energy storage for QUINT DC UPS

The new modular system for uninterruptible power supplies always offers the ideal solution for superior system availability. The various storage media feature a wide range of different properties: long service life or very long buffer time, no maintenance or use at extreme ambient temperatures. Whatever your requirements, we offer the ideal energy storage.

Your advantages

Fast installation

- Automatic detection of the energy storage device by QUINT UPS
- Tool-free replacement during operation

Maximum availability

- Constant communication with QUINT UPS for continuous monitoring and intelligent management

Extremely long service life

- Optimum charging characteristic according to the technology and ambient conditions

Type	Buffer time Typical	Temperature	Service life At +20°C	Service life At +50°C	Charging cycles At +20°C	Weight Standardized
UPS-CAP...	< 5 min	-40 ... 60°C	> 20 years	5 years	> 500.000	0.4 kg
UPS-BAT/LI-ION...	> 40 min	-20 ... 58°C	15 years	2 years	7000	0.45 kg
UPS-BAT/VRLA-WTR...	> 5 h	-25 ... 60°C	12 years	1.5 years	300	1.3 kg
UPS-BAT/VRLA...	> 8 h	0 ... 40°C	6 ... 9 years	1 year	250	1 kg



**UPS-BAT/VRLA...
(Valve Regulated Lead Acid)**

- Maximum buffer times
- Lead AGM (Absorbent Glass Mat) technology



**UPS-BAT/VRLA-WTR...
(Valve Regulated Lead Acid/
Wide Temperature Range)**

- Maximum buffer times at extreme temperatures
- Pure lead AGM (Absorbent Glass Mat) technology



UPS-BAT/LI-ION...

- Long service life with long buffer times
- Light weight
- Lithium iron phosphate technology

UPS-CAP (capacitor)

- Maximum service life
- Maintenance-free double-layer capacitors

Buffer times for QUINT DC UPS

Buffer times of energy storage devices with double-layer capacitors, lithium iron phosphate and pure lead AGM technology with wide temperature range

Select your **UPS-BAT** and **UPS-CAP** for 24 V DC applications here.

Example: 20 A needs to be buffered for 6 minutes.

Solution:
UPS-BAT/LI-ION/24DC/120WH

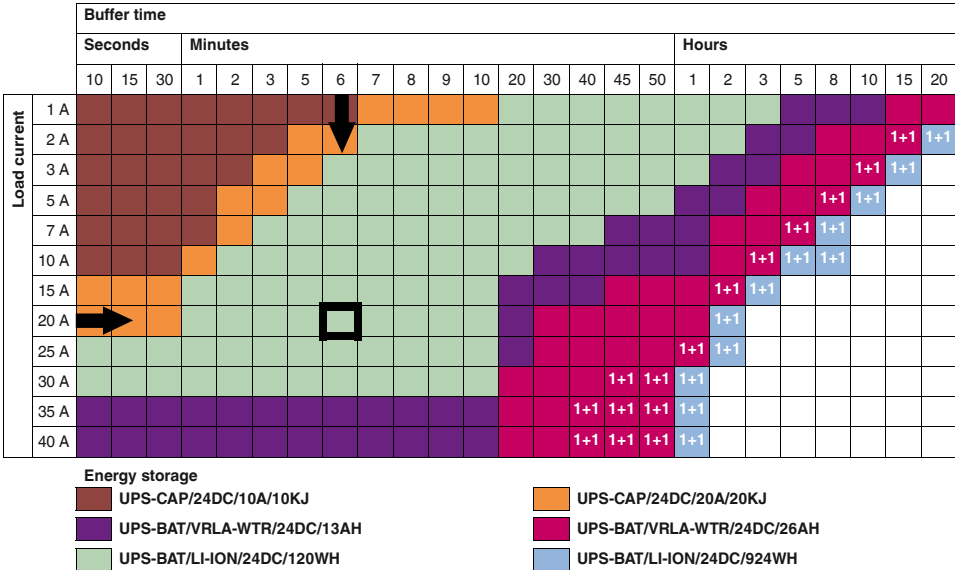

1+1 ... Two energy storage devices of the same capacity are required in this case.
The data is based on an ambient temperature of +20°C.

Buffer times of energy storage devices with lead AGM technology

Select your **UPS-BAT** for 24 V DC applications here.

Example: 20 A needs to be buffered for 10 minutes.

Solution:
UPS-BAT/VRLA/24DC/12AH

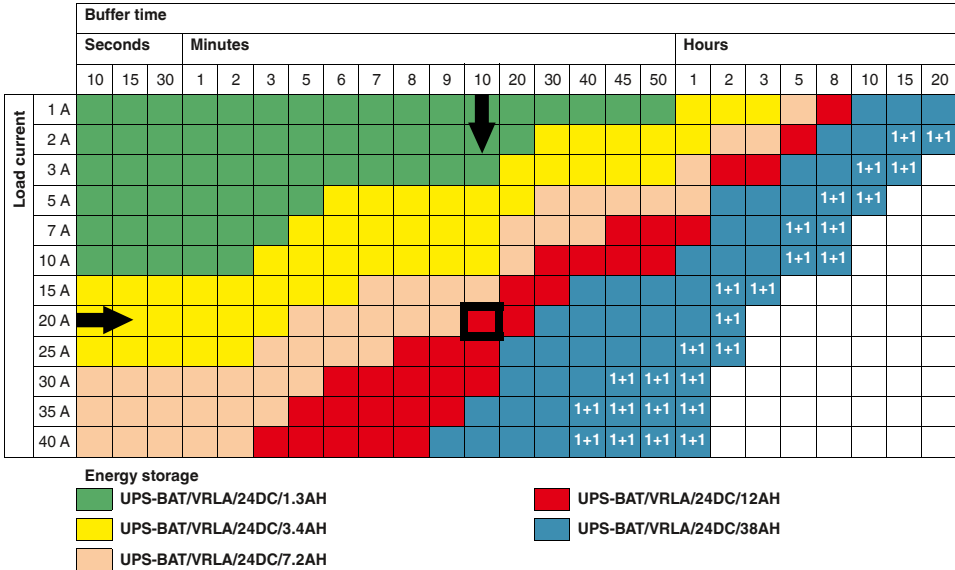

1+1 ... Two energy storage devices of the same capacity are required in this case.
The data is based on an ambient temperature of +20°C.

Power supply units and UPS

Uninterruptible power supplies

QUINT UPS for DC applications

QUINT DC UPS, 24 V DC with PROFINET interface

The UPS modules for 5 to 40 A allow you to create a custom solution combining a power supply, UPS module, and energy storage device.

Easy integration into PROFINET networks:

- Via 2-port switch

Intelligent battery management:

- Automatic detection of battery capacities and technologies
- Maximizes the remaining service life of the energy storage device, thanks to an optimally adjusted charging characteristic
- The very powerful battery charger maximizes system availability

Extended load management:

Energy monitoring – monitoring of input and output voltages and the associated currents

PC shutdown function – reliable shutdown of the IPC in the event of mains failure without data loss, and autostart of the IPC when power returns

Cold restart function – UPS startup even without mains power

Substantial power reserve:

- Static boost up to 125% for a sustained period
- Dynamic boost up to 200% for 5 s
- SFB (Selective Fuse Breaking) Technology

Comprehensive signaling via LEDs and signal contacts:

- Load is being supplied by the energy storage device
- Energy storage device is being charged
- An alarm is present



Uninterruptible power supply, 24 V DC / 24 V DC, 5 A, PN

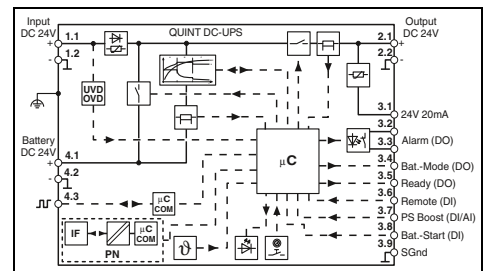

Technical data

Input data	18 V DC ... 30 V DC 22 V DC / 30 V DC Fixed connect threshold Current consumption $I_N / I_{Max} / I_{No-Load} / I_{Charge}$ Power consumption $P_N / P_{Max} / P_{No-Load} / P_{Charge}$	5.1 A / 8.3 A / 105 mA / 1.9 A 123 W / 213 W / 2.5 W / 44 W
Output data (mains operation)	Output voltage Output voltage range Output current $I_N / I_{Stat. Boost} / I_{Dyn. Boost} / I_{SFB}$ Output power $P_N / P_{Stat. Boost} / P_{Dyn. Boost}$	24 V DC ($U_{OUT} = U_{IN} - 0.3 V DC$) 18 V DC ... 30 V DC ($U_{OUT} = U_{IN} - 0.3 V DC$) 5 A / 6.25 A / 10 A (5 s) / 30 A (15 ms) 120 W / 155 W / 240 W (5 s)
Output data (battery operation)	Output voltage Output voltage range Output current $I_N / I_{Stat. Boost} / I_{Dyn. Boost} / I_{SFB}$ Output power $P_N / P_{Stat. Boost} / P_{Dyn. Boost}$	24 V DC ($U_{OUT} = U_{BAT} - 0.3 V DC$) 19 V DC ... 32 V DC ($U_{OUT} = U_{BAT} - 0.3 V DC$) 5 A / 6.25 A / 10 A (5 s) / 30 A (15 ms) 120 W / 150 W / 240 W (5 s)
Energy storage	Charge characteristic curve Nominal voltage U_N End-of-charge voltage (configurable) Charging current (configurable) Deep discharge protection (configurable) Battery technology Nominal capacity (without additional charger) Energy storage device connection in parallel	IU_0U 24 V DC 27.6 V DC max. 1.5 A 19.2 V DC VRLA, VRLA-WTR, LI-ION 0.8 Ah ... 30 Ah Yes, 5 (observe line protection)
Signaling	LED signaling Configurable signal output Channel Interface	DC OK (green), Alarm (red), Bat.-Mode (yellow), SOC (red, green), Data (red, green) OptoMOS, switch contact (floating) 2x DO, 2x DI, 1x DI or AI PROFINET
General data	Weight / Dimensions W x H x D Connection method power / signal Power connection data rigid / flexible / AWG Signal connection data rigid / flexible / AWG Degree of protection / Protection class Ambient temperature (operation) Ambient temperature (storage/transport) Max. permissible relative humidity (operation) Standards/regulations UL approvals	0.5 kg / 35 x 130 x 125 mm Screw connection / Push-in technology 0.2 - 2.5 mm ² / 0.2 - 2.5 mm ² / 30 - 12 0.2 - 1 mm ² / 0.2 - 1 mm ² / 24 - 16 IP20 / III -25°C ... 70°C (> 60°C Derating: 2.5%/K) -40°C ... 85°C ≤ 95% (at 25°C, non-condensing) UL/C-UL Listed UL 61010-1, UL/C-UL Listed UL 61010-2-201, UL/C-UL Listed ANSI/ISA-12.12.01 Class 1, Division 2, Groups A, B, C, D T4 (Hazardous Location)

Ordering data

Description	Type	Order No.	Pcs./Pkt.
Power supply, uninterruptible	QUINT4-UPS/24DC/24DC/5/PN	2906993	1



Uninterruptible power supply,
24 V DC / 24 V DC, 10 A, PN



Uninterruptible power supply,
24 V DC / 24 V DC, 20 A, PN



Uninterruptible power supply,
24 V DC / 24 V DC, 40 A, PN



Ex:



Ex:



Ex:

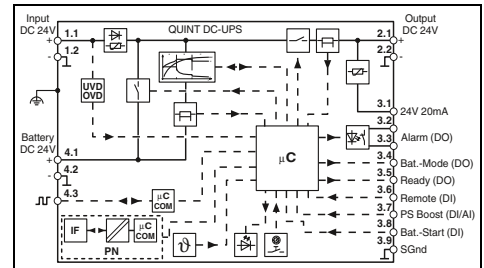
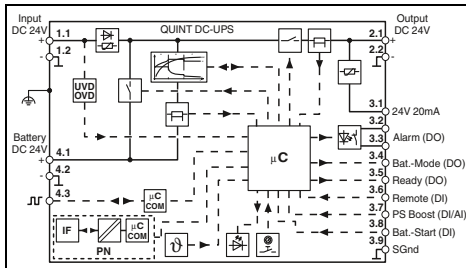
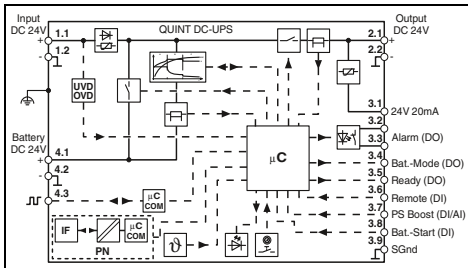

Technical data

18 V DC ... 30 V DC
22 V DC / 30 V DC
10.1 A / 16.3 A / 105 mA / 3.7 A
245 W / 386 W / 2.6 W / 92 W

24 V DC ($U_{OUT} = U_{IN} - 0.4$ V DC)
18 V DC ... 30 V DC
10 A / 12.5 A / 20 A (5 s) / 60 A (15 ms)
240 W / 300 W / 480 W (5 s)

24 V DC ($U_{OUT} = U_{BAT} - 0.4$ V DC)
19 V DC ... 32 V DC
10 A / 12.5 A / 20 A (5 s) / 60 A (15 ms)
240 W / 300 W / 480 W (5 s)

I₀U
24 V DC
27.6 V DC
3 A
19.2 V DC
VRLA, VRLA-WTR, LI-ION
1.2 Ah ... 60 Ah
Yes, 5 (observe line protection)

DC OK (green), Alarm (red), Bat.-Mode (yellow), SOC (red, green),
Data (red, green)
OptoMOS, switch contact (floating)
2x DO, 2x DI, 1x DI or AI
PROFINET

0.5 kg / 35 x 130 x 125 mm
Screw connection / Push-in technology
0.2 - 2.5 mm² / 0.2 - 2.5 mm² / 30 - 12
0.2 - 1 mm² / 0.2 - 1 mm² / 24 - 16
IP20 / III
-25°C ... 70°C (> 60°C Derating: 2.5%/K)
-40°C ... 85°C
≤ 95% (at 25°C, non-condensing)

UL/C-UL Listed UL 61010-1, UL/C-UL Listed UL 61010-2-201,
UL/C-UL Listed ANSI/ISA-12.12.01 Class I, Division 2,
Groups A, B, C, D T4 (Hazardous Location)

Technical data

18 V DC ... 30 V DC
22 V DC / 30 V DC
20.1 A / 31.2 A / 105 mA / 6.1 A
475 W / 740 W / 2.6 W / 148 W

24 V DC ($U_{OUT} = U_{IN} - 0.4$ V DC)
18 V DC ... 30 V DC
20 A / 25 A / 30 A (5 s) / 120 A (15 ms)
480 W / 600 W / -

24 V DC ($U_{OUT} = U_{BAT} - 0.4$ V DC)
19 V DC ... 32 V DC
20 A / 25 A / 30 A (5 s) / 120 A (15 ms)
480 W / 600 W / -

I₀U
24 V DC
27.6 V DC
5 A
19.2 V DC
VRLA, VRLA-WTR, LI-ION
3 Ah ... 100 Ah
Yes, 5 (observe line protection)

DC OK (green), Alarm (red), Bat.-Mode (yellow), SOC (red, green),
Data (red, green)
OptoMOS, switch contact (floating)
2x DO, 2x DI, 1x DI or AI
PROFINET

0.6 kg / 40 x 130 x 125 mm
Screw connection / Push-in technology
0.2 - 6 mm² / 0.2 - 4 mm² / 30 - 10
0.2 - 1 mm² / 0.2 - 1 mm² / 24 - 16
IP20 / III
-25°C ... 70°C (> 60°C Derating: 2.5%/K)
-40°C ... 85°C
≤ 95% (at 25°C, non-condensing)

UL/C-UL Listed UL 61010-1, UL/C-UL Listed UL 61010-2-201,
UL/C-UL Listed ANSI/ISA-12.12.01 Class I, Division 2,
Groups A, B, C, D T4 (Hazardous Location)

Technical data

18 V DC ... 30 V DC
22 V DC / 30 V DC
40.1 A / 51.2 A / 105 mA / 6.1 A
967 W / 1122 W / 2.6 W / 148 W

24 V DC ($U_{OUT} = U_{IN} - 0.5$ V DC)
18 V DC ... 30 V DC
40 A / 45 A / 60 A (5 s) / 215 A (15 ms)
960 W / 1080 W / -

24 V DC ($U_{OUT} = U_{BAT} - 0.5$ V DC)
19 V DC ... 32 V DC
40 A / 45 A / 60 A (5 s) / 215 A (15 ms)
960 W / 1080 W / -

I₀U
24 V DC
27.6 V DC
5 A
19.2 V DC
VRLA, VRLA-WTR, LI-ION
7 Ah ... 100 Ah
Yes, 5 (observe line protection)

DC OK (green), Alarm (red), Bat.-Mode (yellow), SOC (red, green),
Data (red, green)
OptoMOS, switch contact (floating)
2x DO, 2x DI, 1x DI or AI
PROFINET

0.7 kg / 47 x 130 x 125 mm
Screw connection / Push-in technology
0.5 - 16 mm² / 0.5 - 16 mm² / 8 - 6
0.2 - 1 mm² / 0.2 - 1 mm² / 24 - 16
IP20 / III
-25°C ... 70°C (> 60°C Derating: 2.5%/K)
-40°C ... 85°C
≤ 95% (at 25°C, non-condensing)

UL/C-UL Listed UL 61010-1, UL/C-UL Listed UL 61010-2-201,
UL/C-UL Listed ANSI/ISA-12.12.01 Class I, Division 2,
Groups A, B, C, D T4 (Hazardous Location)

Ordering data

Type	Order No.	Pcs./Pkt.
QUINT4-UPS/24DC/24DC/10/PN	2907068	1

Ordering data

Type	Order No.	Pcs./Pkt.
QUINT4-UPS/24DC/24DC/20/PN	2907073	1

Ordering data

Type	Order No.	Pcs./Pkt.
QUINT4-UPS/24DC/24DC/40/PN	2907079	1

Power supply units and UPS

Uninterruptible power supplies

QUINT UPS for DC applications

QUINT DC UPS, 24 V DC with EtherNet/IP™ interface

The UPS modules for 5 to 40 A allow you to create a custom solution combining a power supply, UPS module, and energy storage device.

Easy integration into EtherNet/IP™ networks:

- Via 2-port switch

Intelligent battery management:

- Automatic detection of battery capacities and technologies
- Maximizes the remaining service life of the energy storage device, thanks to an optimally adjusted charging characteristic
- The very powerful battery charger maximizes system availability

Extended load management:

Energy monitoring – monitoring of input and output voltages and the associated currents

Cold restart function – UPS startup even without mains power

Substantial power reserve:

- Static boost up to 125% for a sustained period
- Dynamic boost up to 200% for 5 s
- SFB (Selective Fuse Breaking) Technology

Comprehensive signaling via LEDs and signal contacts:

- Load is being supplied by the energy storage device
- Energy storage device is being charged
- An alarm is present



EtherNet/IP



Uninterruptible power supply, 24 V DC / 24 V DC, 5 A, EIP

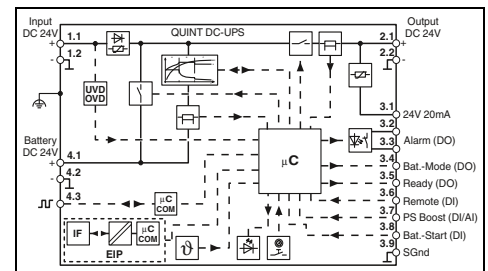

Technical data

Input data	18 V DC ... 30 V DC 22 V DC / 30 V DC 5.1 A / 8.3 A / 105 mA / 1.9 A 123 W / 213 W / 2.5 W / 44 W
Output data (mains operation)	24 V DC ($U_{OUT} = U_{IN} - 0.3 \text{ V DC}$) 18 V DC ... 30 V DC ($U_{OUT} = U_{IN} - 0.3 \text{ V DC}$) 5 A / 6.25 A / 10 A (5 s) / 30 A (15 ms) 120 W / 155 W / 240 W (5 s)
Output data (battery operation)	24 V DC ($U_{OUT} = U_{BAT} - 0.3 \text{ V DC}$) 19 V DC ... 32 V DC ($U_{OUT} = U_{BAT} - 0.3 \text{ V DC}$) 5 A / 6.25 A / 10 A (5 s) / 30 A (15 ms) 120 W / 150 W / 240 W (5 s)
Energy storage	I _{U0} 24 V DC 27.6 V DC max. 1.5 A 19.2 V DC VRLA, VRLA-WTR, LI-ION 0.8 Ah ... 30 Ah Yes, 5 (observe line protection)
Signaling	DC OK (green), Alarm (red), Bat.-Mode (yellow), SOC (red, green), Data (red, green) OptoMOS, switch contact (floating) 2x DO, 2x DI, 1x DI or AI EtherNet/IP™
General data	0.5 kg / 35 x 130 x 125 mm Screw connection / Push-in technology 0.2 - 2.5 mm ² / 0.2 - 2.5 mm ² / 30 - 12 0.2 - 1 mm ² / 0.2 - 1 mm ² / 24 - 16 IP20 / III -25°C ... 70°C (> 60°C Derating: 2.5%/K) -40°C ... 85°C ≤ 95% (at 25°C, non-condensing)
Standards/regulations	UL/C-UL Listed UL 61010-1, UL/C-UL Listed UL 61010-2-201, UL/C-UL Listed ANSI/ISA-12.12.01 Class 1, Division 2, Groups A, B, C, D T4 (Hazardous Location)
Ordering data	
Description	Type Order No. Pcs./Pkt.
Power supply, uninterruptible	QUINT4-UPS/24DC/24DC/5/EIP 2906994 1



EtherNet/IP™



Uninterruptible power supply,
24 V DC / 24 V DC, 10 A, EIP



Ex:

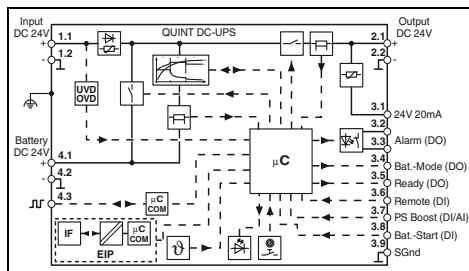

Technical data

18 V DC ... 30 V DC
22 V DC / 30 V DC
10.1 A / 16.3 A / 105 mA / 3.7 A
245 W / 386 W / 2.6 W / 92 W

24 V DC ($U_{OUT} = U_{IN} - 0.4$ V DC)
18 V DC ... 30 V DC
10 A / 12.5 A / 20 A (5 s) / 60 A (15 ms)
240 W / 300 W / 480 W (5 s)

24 V DC ($U_{OUT} = U_{BAT} - 0.4$ V DC)
19 V DC ... 32 V DC
10 A / 12.5 A / 20 A (5 s) / 60 A (15 ms)
240 W / 300 W / 480 W (5 s)

I₀U
24 V DC
27.6 V DC
3 A
19.2 V DC
VRLA, VRLA-WTR, LI-ION
1.2 Ah ... 60 Ah
Yes, 5 (observe line protection)

DC OK (green), Alarm (red), Bat.-Mode (yellow), SOC (red, green),
Data (red, green)
OptoMOS, switch contact (floating)
2x DO, 2x DI, 1x DI or AI
EtherNet/IP™

0.5 kg / 35 x 130 x 125 mm
Screw connection / Push-in technology
0.2 - 2.5 mm² / 0.2 - 2.5 mm² / 30 - 12
0.2 - 1 mm² / 0.2 - 1 mm² / 24 - 16
IP20 / III
-25°C ... 70°C (> 60°C Derating: 2.5%/K)
-40°C ... 85°C
≤ 95% (at 25°C, non-condensing)

UL/C-UL Listed UL 61010-1, UL/C-UL Listed UL 61010-2-201,
UL/C-UL Listed ANSI/ISA-12.12.01 Class I, Division 2,
Groups A, B, C, D T4 (Hazardous Location)

Ordering data

Type	Order No.	Pcs./Pkt.
QUINT4-UPS/24DC/24DC/10/EIP	2907069	1



EtherNet/IP™



Uninterruptible power supply,
24 V DC / 24 V DC, 20 A, EIP



Ex:

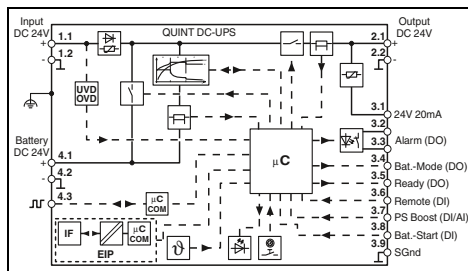

Technical data

18 V DC ... 30 V DC
22 V DC / 30 V DC
20.1 A / 31.2 A / 105 mA / 6.1 A
475 W / 740 W / 2.6 W / 148 W

24 V DC ($U_{OUT} = U_{IN} - 0.4$ V DC)
18 V DC ... 30 V DC
20 A / 25 A / 30 A (5 s) / 120 A (15 ms)
480 W / 600 W / -

24 V DC ($U_{OUT} = U_{BAT} - 0.4$ V DC)
19 V DC ... 32 V DC
20 A / 25 A / 30 A (5 s) / 120 A (15 ms)
480 W / 600 W / -

I₀U
24 V DC
27.6 V DC
5 A
19.2 V DC
VRLA, VRLA-WTR, LI-ION
3 Ah ... 100 Ah
Yes, 5 (observe line protection)

DC OK (green), Alarm (red), Bat.-Mode (yellow), SOC (red, green),
Data (red, green)
OptoMOS, switch contact (floating)
2x DO, 2x DI, 1x DI or AI
EtherNet/IP™

0.6 kg / 40 x 130 x 125 mm
Screw connection / Push-in technology
0.2 - 6 mm² / 0.2 - 4 mm² / 30 - 10
0.2 - 1 mm² / 0.2 - 1 mm² / 24 - 16
IP20 / III
-25°C ... 70°C (> 60°C Derating: 2.5%/K)
-40°C ... 85°C
≤ 95% (at 25°C, non-condensing)

UL/C-UL Listed UL 61010-1, UL/C-UL Listed UL 61010-2-201,
UL/C-UL Listed ANSI/ISA-12.12.01 Class I, Division 2,
Groups A, B, C, D T4 (Hazardous Location)

Ordering data

Type	Order No.	Pcs./Pkt.
QUINT4-UPS/24DC/24DC/20/EIP	2907074	1



EtherNet/IP™



Uninterruptible power supply,
24 V DC / 24 V DC, 40 A, EIP



Ex:

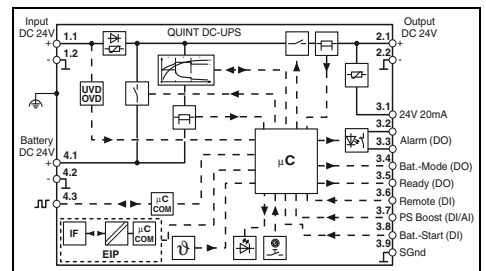

Technical data

18 V DC ... 30 V DC
22 V DC / 30 V DC
40.1 A / 51.2 A / 105 mA / 6.1 A
967 W / 1122 W / 2.6 W / 148 W

24 V DC ($U_{OUT} = U_{IN} - 0.5$ V DC)
18 V DC ... 30 V DC
40 A / 45 A / 60 A (5 s) / 215 A (15 ms)
960 W / 1080 W / -

24 V DC ($U_{OUT} = U_{BAT} - 0.5$ V DC)
19 V DC ... 32 V DC
40 A / 45 A / 60 A (5 s) / 215 A (15 ms)
960 W / 1080 W / -

I₀U
24 V DC
27.6 V DC
5 A
19.2 V DC
VRLA, VRLA-WTR, LI-ION
7 Ah ... 100 Ah
Yes, 5 (observe line protection)

DC OK (green), Alarm (red), Bat.-Mode (yellow), SOC (red, green),
Data (red, green)
OptoMOS, switch contact (floating)
2x DO, 2x DI, 1x DI or AI
EtherNet/IP™

0.7 kg / 47 x 130 x 125 mm
Screw connection / Push-in technology
0.5 - 16 mm² / 0.5 - 16 mm² / 8 - 6
0.2 - 1 mm² / 0.2 - 1 mm² / 24 - 16
IP20 / III
-25°C ... 70°C (> 60°C Derating: 2.5%/K)
-40°C ... 85°C
≤ 95% (at 25°C, non-condensing)

UL/C-UL Listed UL 61010-1, UL/C-UL Listed UL 61010-2-201,
UL/C-UL Listed ANSI/ISA-12.12.01 Class I, Division 2,
Groups A, B, C, D T4 (Hazardous Location)

Ordering data

Type	Order No.	Pcs./Pkt.
QUINT4-UPS/24DC/24DC/40/EIP	2907080	1

Power supply units and UPS

Uninterruptible power supplies

QUINT UPS for DC applications

QUINT DC UPS, 24 V DC with EtherCAT® interface

The UPS modules for 5 to 40 A allow you to create a custom solution combining a power supply, UPS module, and energy storage device.

Easy integration into EtherCAT® networks:

- Via 2-port switch

Intelligent battery management:

- Automatic detection of battery capacities and technologies
- Maximizes the remaining service life of the energy storage device, thanks to an optimally adjusted charging characteristic
- The very powerful battery charger maximizes system availability

Extended load management:

Energy monitoring – monitoring of input and output voltages and the associated currents

Cold restart function – UPS startup even without mains power

Substantial power reserve:

- Static boost up to 125% for a sustained period
- Dynamic boost up to 200% for 5 s
- SFB (Selective Fuse Breaking) Technology

Comprehensive signaling via LEDs and signal contacts:

- Load is being supplied by the energy storage device
- Energy storage device is being charged
- An alarm is present

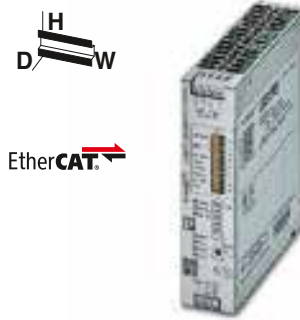

Uninterruptible power supply,
24 V DC / 24 V DC, 5 A, EC

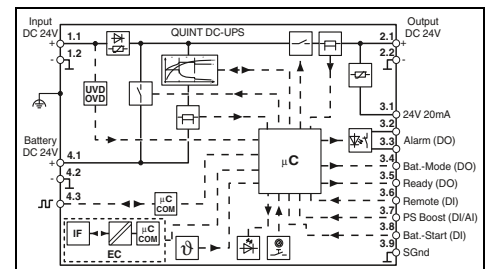

Technical data

Input data	18 V DC ... 30 V DC 22 V DC / 30 V DC 5.1 A / 8.3 A / 105 mA / 1.9 A 123 W / 213 W / 2.5 W / 44 W
Output data (mains operation)	24 V DC ($U_{OUT} = U_{IN} - 0.3 \text{ V DC}$) 18 V DC ... 30 V DC ($U_{OUT} = U_{IN} - 0.3 \text{ V DC}$) 5 A / 6.25 A / 10 A (5 s) / 30 A (15 ms) 120 W / 155 W / 240 W (5 s)
Output data (battery operation)	24 V DC ($U_{OUT} = U_{BAT} - 0.3 \text{ V DC}$) 19 V DC ... 32 V DC ($U_{OUT} = U_{BAT} - 0.3 \text{ V DC}$) 5 A / 6.25 A / 10 A (5 s) / 30 A (15 ms) 120 W / 150 W / 240 W (5 s)
Energy storage	I_{U_0} 24 V DC 27.6 V DC max. 1.5 A 19.2 V DC VRLA, VRLA-WTR, LI-ION 0.8 Ah ... 30 Ah Yes, 5 (observe line protection)
Signaling	DC OK (green), Alarm (red), Bat.-Mode (yellow), SOC (red, green), Data (red, green) OptoMOS, switch contact (floating) 2x DO, 2x DI, 1x DI or AI EtherCAT®
General data	0.5 kg / 35 x 130 x 125 mm Screw connection / Push-in technology 0.2 - 2.5 mm ² / 0.2 - 2.5 mm ² / 30 - 12 0.2 - 1 mm ² / 0.2 - 1 mm ² / 24 - 16 IP20 / III -25°C ... 70°C (> 60°C Derating: 2.5%/K) -40°C ... 85°C ≤ 95% (at 25°C, non-condensing)
Standards/regulations	UL/C-UL Listed UL 61010-1, UL/C-UL Listed UL 61010-2-201, UL/C-UL Listed ANSI/ISA-12.12.01 Class 1, Division 2, Groups A, B, C, D T4 (Hazardous Location)

Ordering data

Description	Type	Order No.	Pcs./Pkt.
Power supply, uninterruptible	QUINT4-UPS/24DC/24DC/5/EC	2906996	1

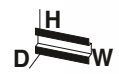

EtherCAT



Uninterruptible power supply,
24 V DC / 24 V DC, 10 A, EC



EtherCAT



Uninterruptible power supply,
24 V DC / 24 V DC, 20 A, EC



EtherCAT



Uninterruptible power supply,
24 V DC / 24 V DC, 40 A, EC



Ex:

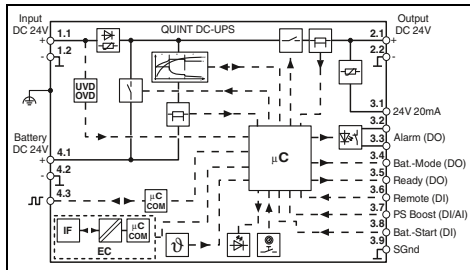

Ex:

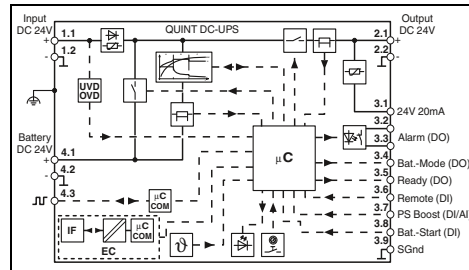

Ex:

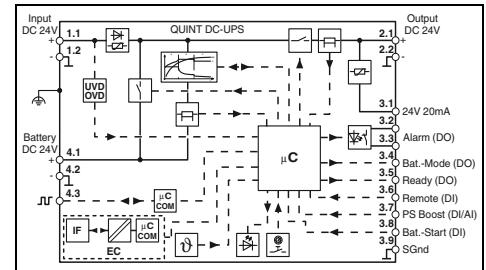

Technical data

18 V DC ... 30 V DC
22 V DC / 30 V DC
10.1 A / 16.3 A / 105 mA / 3.7 A
245 W / 386 W / 2.6 W / 92 W

24 V DC ($U_{OUT} = U_{IN} - 0.4$ V DC)
18 V DC ... 30 V DC
10 A / 12.5 A / 20 A (5 s) / 60 A (15 ms)
240 W / 300 W / 480 W (5 s)

24 V DC ($U_{OUT} = U_{BAT} - 0.4$ V DC)
19 V DC ... 32 V DC
10 A / 12.5 A / 20 A (5 s) / 60 A (15 ms)
240 W / 300 W / 480 W (5 s)

I₀U
24 V DC
27.6 V DC
3 A
19.2 V DC
VRLA, VRLA-WTR, LI-ION
1.2 Ah ... 60 Ah
Yes, 5 (observe line protection)

DC OK (green), Alarm (red), Bat.-Mode (yellow), SOC (red, green),
Data (red, green)
OptoMOS, switch contact (floating)
2x DO, 2x DI, 1x DI or AI
EtherCAT®

0.5 kg / 35 x 130 x 125 mm
Screw connection / Push-in technology
0.2 - 2.5 mm² / 0.2 - 2.5 mm² / 30 - 12
0.2 - 1 mm² / 0.2 - 1 mm² / 24 - 16
IP20 / III
-25°C ... 70°C (> 60°C Derating: 2.5%/K)
-40°C ... 85°C
≤ 95% (at 25°C, non-condensing)

UL/C-UL Listed UL 61010-1, UL/C-UL Listed UL 61010-2-201,
UL/C-UL Listed ANSI/ISA-12.12.01 Class I, Division 2,
Groups A, B, C, D T4 (Hazardous Location)

Ordering data

Type	Order No.	Pcs./Pkt.
QUINT4-UPS/24DC/24DC/10/EC	2907070	1

Technical data

18 V DC ... 30 V DC
22 V DC / 30 V DC
20.1 A / 31.2 A / 105 mA / 6.1 A
475 W / 740 W / 2.6 W / 148 W

24 V DC ($U_{OUT} = U_{IN} - 0.4$ V DC)
18 V DC ... 30 V DC
20 A / 25 A / 30 A (5 s) / 120 A (15 ms)
480 W / 600 W / -

24 V DC ($U_{OUT} = U_{BAT} - 0.4$ V DC)
19 V DC ... 32 V DC
20 A / 25 A / 30 A (5 s) / 120 A (15 ms)
480 W / 600 W / -

I₀U
24 V DC
27.6 V DC
5 A
19.2 V DC
VRLA, VRLA-WTR, LI-ION
3 Ah ... 100 Ah
Yes, 5 (observe line protection)

DC OK (green), Alarm (red), Bat.-Mode (yellow), SOC (red, green),
Data (red, green)
OptoMOS, switch contact (floating)
2x DO, 2x DI, 1x DI or AI
EtherCAT®

0.6 kg / 40 x 130 x 125 mm
Screw connection / Push-in technology
0.2 - 6 mm² / 0.2 - 4 mm² / 30 - 10
0.2 - 1 mm² / 0.2 - 1 mm² / 24 - 16
IP20 / III
-25°C ... 70°C (> 60°C Derating: 2.5%/K)
-40°C ... 85°C
≤ 95% (at 25°C, non-condensing)

UL/C-UL Listed UL 61010-1, UL/C-UL Listed UL 61010-2-201,
UL/C-UL Listed ANSI/ISA-12.12.01 Class I, Division 2,
Groups A, B, C, D T4 (Hazardous Location)

Ordering data

Type	Order No.	Pcs./Pkt.
QUINT4-UPS/24DC/24DC/20/EC	2907076	1

Technical data

18 V DC ... 30 V DC
22 V DC / 30 V DC
40.1 A / 51.2 A / 105 mA / 6.1 A
967 W / 1122 W / 2.6 W / 148 W

24 V DC ($U_{OUT} = U_{IN} - 0.5$ V DC)
18 V DC ... 30 V DC
40 A / 45 A / 60 A (5 s) / 215 A (15 ms)
960 W / 1080 W / -

24 V DC ($U_{OUT} = U_{BAT} - 0.5$ V DC)
19 V DC ... 32 V DC
40 A / 45 A / 60 A (5 s) / 215 A (15 ms)
960 W / 1080 W / -

I₀U
24 V DC
27.6 V DC
5 A
19.2 V DC
VRLA, VRLA-WTR, LI-ION
7 Ah ... 100 Ah
Yes, 5 (observe line protection)

DC OK (green), Alarm (red), Bat.-Mode (yellow), SOC (red, green),
Data (red, green)
OptoMOS, switch contact (floating)
2x DO, 2x DI, 1x DI or AI
EtherCAT®

0.7 kg / 47 x 130 x 125 mm
Screw connection / Push-in technology
0.5 - 16 mm² / 0.5 - 16 mm² / 8 - 6
0.2 - 1 mm² / 0.2 - 1 mm² / 24 - 16
IP20 / III
-25°C ... 70°C (> 60°C Derating: 2.5%/K)
-40°C ... 85°C
≤ 95% (at 25°C, non-condensing)

UL/C-UL Listed UL 61010-1, UL/C-UL Listed UL 61010-2-201,
UL/C-UL Listed ANSI/ISA-12.12.01 Class I, Division 2,
Groups A, B, C, D T4 (Hazardous Location)

Ordering data

Type	Order No.	Pcs./Pkt.
QUINT4-UPS/24DC/24DC/40/EC	2907081	1

Power supply units and UPS

Uninterruptible power supplies

QUINT UPS for DC applications

QUINT DC UPS, 24 V DC with USB interface

The UPS modules for 5 to 40 A allow you to create a custom solution combining a power supply, UPS module, and energy storage device.

Intelligent battery management:

- Automatic detection of battery capacities and technologies
- Maximizes the remaining service life of the energy storage device, thanks to an optimally adjusted charging characteristic
- The very powerful battery charger maximizes system availability

Extended load management:

Energy monitoring – monitoring of input and output voltages and the associated currents

PC shutdown function – reliable shutdown of the IPC in the event of mains failure without data loss, and autostart of the IPC when power returns

Cold restart function – UPS startup even without mains power

Substantial power reserve:

- Static boost up to 125% for a sustained period
- Dynamic boost up to 200% for 5 s
- SFB (Selective Fuse Breaking) Technology

Comprehensive signaling via LEDs and signal contacts:

- Load is being supplied by the energy storage device
- Energy storage device is being charged
- An alarm is present

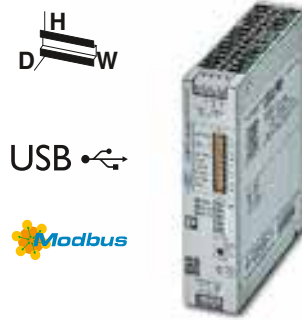

Uninterruptible power supply, 24 V DC / 24 V DC, 5 A, USB

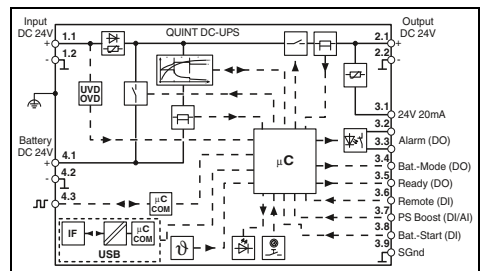

Technical data

Input data	18 V DC ... 30 V DC 22 V DC / 30 V DC 5.1 A / 8.3 A / 45 mA / 1.8 A 121 W / 211 W / 1.1 W / 43 W		
Output data (mains operation)	24 V DC ($U_{OUT} = U_{IN} - 0.3 \text{ V DC}$) 18 V DC ... 30 V DC ($U_{OUT} = U_{IN} - 0.3 \text{ V DC}$) 5 A / 6.25 A / 10 A (5 s) / 30 A (15 ms) 120 W / 155 W / 240 W (5 s)		
Output data (battery operation)	24 V DC ($U_{OUT} = U_{BAT} - 0.3 \text{ V DC}$) 19 V DC ... 32 V DC ($U_{OUT} = U_{BAT} - 0.3 \text{ V DC}$) 5 A / 6.25 A / 10 A (5 s) / 30 A (15 ms) 120 W / 150 W / 240 W (5 s)		
Energy storage	IU ₀ U 24 V DC 27.6 V DC max. 1.5 A 19.2 V DC VRLA, VRLA-WTR, LI-ION 0.8 Ah ... 30 Ah Yes, 5 (observe line protection)		
Signaling	DC OK (green), Alarm (red), Bat.-Mode (yellow), SOC (red, green), Data (red, green) OptoMOS, switch contact (floating) 2x DO, 2x DI, 1x DI or AI USB (Modbus/RTU)		
General data	0.5 kg / 35 x 130 x 125 mm Screw connection / Push-in technology 0.2 - 2.5 mm ² / 0.2 - 2.5 mm ² / 30 - 12 0.2 - 1 mm ² / 0.2 - 1 mm ² / 24 - 16 IP20 / III -25°C ... 70°C (> 60°C Derating: 2.5%/K) -40°C ... 85°C ≤ 95% (at 25°C, non-condensing)		
Standards/regulations	UL/C-UL Listed UL 61010-1, UL/C-UL Listed UL 61010-2-201, UL/C-UL Listed ANSI/ISA-12.12.01 Class 1, Division 2, Groups A, B, C, D T4 (Hazardous Location)		
Ordering data			
Description	Type	Order No.	Pcs./Pkt.
Power supply, uninterruptible	QUINT4-UPS/24DC/24DC/5/USB	2906991	1

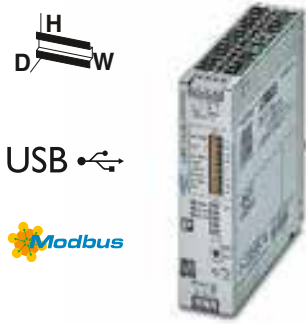

Uninterruptible power supply,
24 V DC / 24 V DC, 10 A, USB

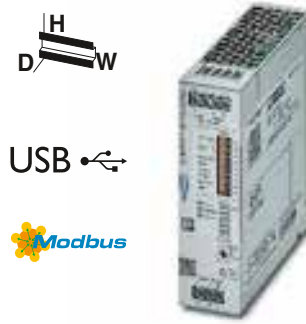

Uninterruptible power supply,
24 V DC / 24 V DC, 20 A, USB

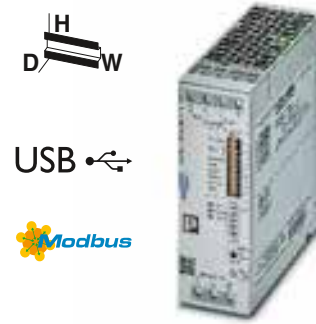

Uninterruptible power supply,
24 V DC / 24 V DC, 40 A, USB



Ex:



Ex:



Ex:

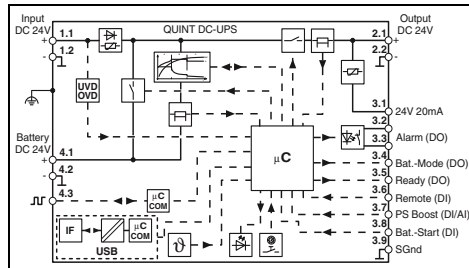
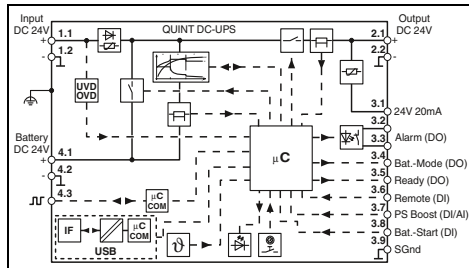
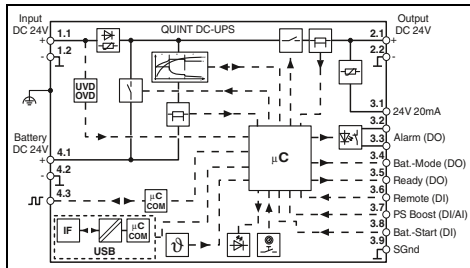

Technical data

18 V DC ... 30 V DC
22 V DC / 30 V DC
10.1 A / 16.3 A / 48 mA / 3.5 A
241 W / 384 W / 1.2 W / 90 W

24 V DC ($U_{OUT} = U_{IN} - 0.4$ V DC)
18 V DC ... 30 V DC
10 A / 12.5 A / 20 A (5 s) / 60 A (15 ms)
240 W / 300 W / 480 W (5 s)

24 V DC ($U_{OUT} = U_{BAT} - 0.4$ V DC)
19 V DC ... 32 V DC
10 A / 12.5 A / 20 A (5 s) / 60 A (15 ms)
240 W / 300 W / 480 W (5 s)

I₀U
24 V DC
27.6 V DC
3 A
19.2 V DC
VRLA, VRLA-WTR, LI-ION
1.2 Ah ... 60 Ah
Yes, 5 (observe line protection)

DC OK (green), Alarm (red), Bat.-Mode (yellow), SOC (red, green),
Data (red, green)
OptoMOS, switch contact (floating)
2x DO, 2x DI, 1x DI or AI
USB (Modbus/RTU)

0.5 kg / 35 x 130 x 125 mm
Screw connection / Push-in technology
0.2 - 2.5 mm² / 0.2 - 2.5 mm² / 30 - 12
0.2 - 1 mm² / 0.2 - 1 mm² / 24 - 16
IP20 / III
-25°C ... 70°C (> 60°C Derating: 2.5%/K)
-40°C ... 85°C
≤ 95% (at 25°C, non-condensing)

UL/C-UL Listed UL 61010-1, UL/C-UL Listed UL 61010-2-201,
UL/C-UL Listed ANSI/ISA-12.12.01 Class I, Division 2,
Groups A, B, C, D T4 (Hazardous Location)

Technical data

18 V DC ... 30 V DC
22 V DC / 30 V DC
20.1 A / 31.2 A / 50 mA / 6.1 A
474 W / 738 W / 1.3 W / 145 W

24 V DC ($U_{OUT} = U_{IN} - 0.4$ V DC)
18 V DC ... 30 V DC
20 A / 25 A / 30 A (5 s) / 120 A (15 ms)
480 W / 600 W / -

24 V DC ($U_{OUT} = U_{BAT} - 0.4$ V DC)
19 V DC ... 32 V DC
20 A / 25 A / 30 A (5 s) / 120 A (15 ms)
480 W / 600 W / -

I₀U
24 V DC
27.6 V DC
5 A
19.2 V DC
VRLA, VRLA-WTR, LI-ION
3 Ah ... 100 Ah
Yes, 5 (observe line protection)

DC OK (green), Alarm (red), Bat.-Mode (yellow), SOC (red, green),
Data (red, green)
OptoMOS, switch contact (floating)
2x DO, 2x DI, 1x DI or AI
USB (Modbus/RTU)

0.6 kg / 40 x 130 x 125 mm
Screw connection / Push-in technology
0.2 - 6 mm² / 0.2 - 4 mm² / 30 - 10
0.2 - 1 mm² / 0.2 - 1 mm² / 24 - 16
IP20 / III
-25°C ... 70°C (> 60°C Derating: 2.5%/K)
-40°C ... 85°C
≤ 95% (at 25°C, non-condensing)

UL/C-UL Listed UL 61010-1, UL/C-UL Listed UL 61010-2-201,
UL/C-UL Listed ANSI/ISA-12.12.01 Class I, Division 2,
Groups A, B, C, D T4 (Hazardous Location)

Technical data

18 V DC ... 30 V DC
22 V DC / 30 V DC
40.1 A / 51.2 A / 50 mA / 6.1 A
965 W / 1120 W / 1.3 W / 147 W

24 V DC ($U_{OUT} = U_{IN} - 0.5$ V DC)
18 V DC ... 30 V DC
40 A / 45 A / 60 A (5 s) / 215 A (15 ms)
960 W / 1080 W / -

24 V DC ($U_{OUT} = U_{BAT} - 0.5$ V DC)
19 V DC ... 32 V DC
40 A / 45 A / 60 A (5 s) / 215 A (15 ms)
960 W / 1080 W / -

I₀U
24 V DC
27.6 V DC
5 A
19.2 V DC
VRLA, VRLA-WTR, LI-ION
7 Ah ... 100 Ah
Yes, 5 (observe line protection)

DC OK (green), Alarm (red), Bat.-Mode (yellow), SOC (red, green),
Data (red, green)
OptoMOS, switch contact (floating)
2x DO, 2x DI, 1x DI or AI
USB (Modbus/RTU)

0.7 kg / 47 x 130 x 125 mm
Screw connection / Push-in technology
0.5 - 16 mm² / 0.5 - 16 mm² / 8 - 6
0.2 - 1 mm² / 0.2 - 1 mm² / 24 - 16
IP20 / III
-25°C ... 70°C (> 60°C Derating: 2.5%/K)
-40°C ... 85°C
≤ 95% (at 25°C, non-condensing)

UL/C-UL Listed UL 61010-1, UL/C-UL Listed UL 61010-2-201,
UL/C-UL Listed ANSI/ISA-12.12.01 Class I, Division 2,
Groups A, B, C, D T4 (Hazardous Location)

Ordering data

Type	Order No.	Pcs./Pkt.
QUINT4-UPS/24DC/24DC/10/USB	2907067	1

Ordering data

Type	Order No.	Pcs./Pkt.
QUINT4-UPS/24DC/24DC/20/USB	2907072	1

Ordering data

Type	Order No.	Pcs./Pkt.
QUINT4-UPS/24DC/24DC/40/USB	2907078	1

Power supply units and UPS

Uninterruptible power supplies

QUINT UPS for DC applications

QUINT DC UPS, 24 V DC

The UPS modules for 5 to 40 A allow you to create a custom solution combining a power supply, UPS module, and energy storage device.

Intelligent battery management:

- Automatic detection of battery capacities and technologies
- Maximizes the remaining service life of the energy storage device, thanks to an optimally adjusted charging characteristic
- The very powerful battery charger maximizes system availability

Extended load management:

Energy monitoring – monitoring of input and output voltages and the associated currents

PC shutdown function – reliable shutdown of the IPC in the event of mains failure without data loss, and autostart of the IPC when power returns

Cold restart function – UPS startup even without mains power

Substantial power reserve:

- Static boost up to 125% for a sustained period
- Dynamic boost up to 200% for 5 s
- SFB (Selective Fuse Breaking) Technology

Comprehensive signaling via LEDs and signal contacts:

- Load is being supplied by the energy storage device
- Energy storage device is being charged
- An alarm is present



Uninterruptible power supply,
24 V DC / 24 V DC, 5 A

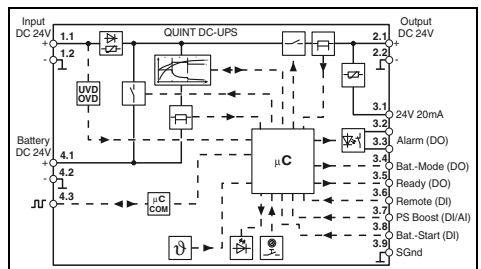

Technical data

Input data	18 V DC ... 30 V DC 22 V DC / 30 V DC 5.1 A / 8.3 A / 45 mA / 1.8 A 121 W / 211 W / 1.1 W / 43 W
Output data (mains operation)	24 V DC ($U_{OUT} = U_{IN} - 0.3$ V DC) 18 V DC ... 30 V DC ($U_{OUT} = U_{IN} - 0.3$ V DC) 5 A / 6.25 A / 10 A (5 s) / 30 A (15 ms) 120 W / 150 W / 240 W (5 s)
Output data (battery operation)	24 V DC ($U_{OUT} = U_{BAT} - 0.3$ V DC) 19 V DC ... 28 V DC ($U_{OUT} = U_{BAT} - 0.3$ V DC) 5 A / 6.25 A / 10 A (5 s) / 30 A (15 ms) 120 W / 150 W / 240 W (5 s)
Energy storage	I_{U_0} 24 V DC 27.6 V DC max. 1.5 A 19.2 V DC VRLA, VRLA-WTR, LI-ION 0.8 Ah ... 40 Ah Yes, 5 (observe line protection)
Signaling	DC OK (green), Alarm (red), Bat.-Mode (yellow), SOC (red, green), Data (red, green) OptoMOS, switch contact (floating) 2x DO, 2x DI, 1x DI or AI -
General data	0.5 kg / 35 x 130 x 125 mm Screw connection / Push-in technology 0.2 - 2.5 mm ² / 0.2 - 2.5 mm ² / 30 - 12 0.2 - 1 mm ² / 0.2 - 1 mm ² / 24 - 16 IP20 / III -25°C ... 70°C (> 60°C Derating: 2.5%/K) -40°C ... 85°C ≤ 95% (at 25°C, non-condensing)
Standards/regulations	UL/C-UL Listed UL 61010-1, UL/C-UL Listed UL 61010-2-201, UL/C-UL Listed ANSI/ISA-12.12.01 Class I, Division 2, Groups A, B, C, D T4 (Hazardous Location)
Ordering data	
Description	Type Order No. Pcs./Pkt.
Power supply, uninterruptible	QUINT4-UPS/24DC/24DC/5 2906990 1



Uninterruptible power supply,
24 V DC / 24 V DC, 10 A

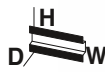

Uninterruptible power supply,
24 V DC / 24 V DC, 20 A



Uninterruptible power supply,
24 V DC / 24 V DC, 40 A



Ex:

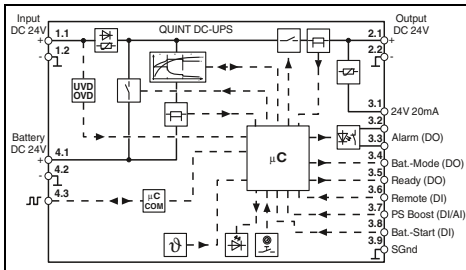

Technical data

18 V DC ... 30 V DC
22 V DC / 30 V DC
10.1 A / 16.2 A / 48 mA / 3.5 A
241 W / 384 W / 1.2 W / 90 W

24 V DC ($U_{OUT} = U_{IN} - 0.4$ V DC)
18 V DC ... 30 V DC ($U_{OUT} = U_{IN} - 0.4$ V DC)
10 A / 12.5 A / 20 A (5 s) / 60 A (15 ms)
240 W / 300 W / 480 W (5 s)

24 V DC ($U_{OUT} = U_{BAT} - 0.4$ V DC)
19 V DC ... 28 V DC ($U_{OUT} = U_{BAT} - 0.4$ V DC)
10 A / 12.5 A / 20 A (5 s) / 60 A (15 ms)
240 W / 300 W / 480 W (5 s)

I_{U0}U
24 V DC
27.6 V DC
max. 3 A
19.2 V DC
VRLA, VRLA-WTR, LI-ION
1.2 Ah ... 80 Ah
Yes, 5 (observe line protection)

DC OK (green), Alarm (red), Bat.-Mode (yellow), SOC (red, green),
Data (red, green)
OptoMOS, switch contact (floating)
2x DO, 2x DI, 1x DI or AI

0.5 kg / 35 x 130 x 125 mm
Screw connection / Push-in technology
0.2 - 2.5 mm² / 0.2 - 2.5 mm² / 30 - 12
0.2 - 1 mm² / 0.2 - 1 mm² / 24 - 16
IP20 / III
-25°C ... 70°C (> 60°C Derating: 2.5%/K)
-40°C ... 85°C
≤ 95% (at 25°C, non-condensing)

UL/C-UL Listed UL 61010-1, UL/C-UL Listed UL 61010-2-201,
UL/C-UL Listed ANSI/ISA-12.12.01 Class I, Division 2,
Groups A, B, C, D T4 (Hazardous Location)

Ordering data

Type	Order No.	Pcs./Pkt.
QUINT4-UPS/24DC/24DC/10	2907066	1



Ex:

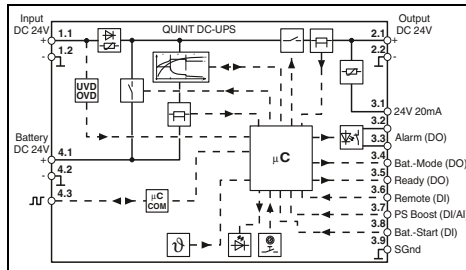

Technical data

18 V DC ... 30 V DC
22 V DC / 30 V DC
20.1 A / 31.4 A / 50 mA / 6.1 A
474 W / 738 W / 1.3 W / 145 W

24 V DC ($U_{OUT} = U_{IN} - 0.4$ V DC)
18 V DC ... 30 V DC ($U_{OUT} = U_{IN} - 0.4$ V DC)
20 A / 25 A / 30 A (5 s) / 120 A (15 ms)
480 W / 600 W / 720 W (5 s)

24 V DC ($U_{OUT} = U_{BAT} - 0.4$ V DC)
19 V DC ... 28 V DC ($U_{OUT} = U_{BAT} - 0.4$ V DC)
20 A / 25 A / 30 A (5 s) / 120 A (15 ms)
480 W / 600 W / 720 W (5 s)

I_{U0}U
24 V DC
27.6 V DC
max. 5 A
19.2 V DC
VRLA, VRLA-WTR, LI-ION
3 Ah ... 135 Ah
Yes, 5 (observe line protection)

DC OK (green), Alarm (red), Bat.-Mode (yellow), SOC (red, green),
Data (red, green)
OptoMOS, switch contact (floating)
2x DO, 2x DI, 1x DI or AI

0.6 kg / 40 x 130 x 125 mm
Screw connection / Push-in technology
0.2 - 6 mm² / 0.2 - 4 mm² / 30 - 10
0.2 - 1 mm² / 0.2 - 1 mm² / 24 - 16
IP20 / III
-25°C ... 70°C (> 60°C Derating: 2.5%/K)
-40°C ... 85°C
≤ 95% (at 25°C, non-condensing)

UL/C-UL Listed UL 61010-1, UL/C-UL Listed UL 61010-2-201,
UL/C-UL Listed ANSI/ISA-12.12.01 Class I, Division 2,
Groups A, B, C, D T4 (Hazardous Location)

Ordering data

Type	Order No.	Pcs./Pkt.
QUINT4-UPS/24DC/24DC/20	2907071	1



Ex:

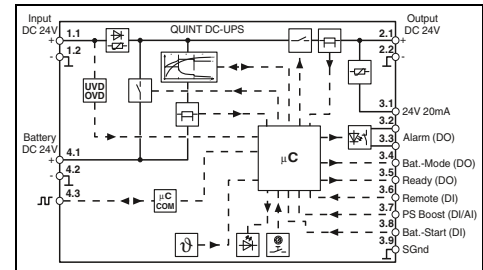

Technical data

18 V DC ... 30 V DC
22 V DC / 30 V DC
40.1 A / 51.2 A / 50 mA / 6.1 A
965 W / 1120 W / 1.3 W / 147 W

24 V DC ($U_{OUT} = U_{IN} - 0.5$ V DC)
18 V DC ... 30 V DC
40 A / 45 A / 60 A (5 s) / 215 A (15 ms)
960 W / 1080 W / -

24 V DC ($U_{OUT} = U_{BAT} - 0.5$ V DC)
19 V DC ... 32 V DC
40 A / 45 A / 60 A (5 s) / 215 A (15 ms)
960 W / 1080 W / -

I_{U0}U
24 V DC
27.6 V DC
max. 5 A
19.2 V DC
VRLA, VRLA-WTR, LI-ION
7 Ah ... 135 Ah
Yes, 5 (observe line protection)

DC OK (green), Alarm (red), Bat.-Mode (yellow), SOC (red, green),
Data (red, green)
OptoMOS, switch contact (floating)
2x DO, 2x DI, 1x DI or AI

0.7 kg / 47 x 130 x 125 mm
Screw connection / Push-in technology
0.5 - 16 mm² / 0.5 - 16 mm² / 8 - 6
0.2 - 1 mm² / 0.2 - 1 mm² / 24 - 16
IP20 / III
-25°C ... 70°C (> 60°C Derating: 2.5%/K)
-40°C ... 85°C
≤ 95% (at 25°C, non-condensing)

UL/C-UL Listed UL 61010-1, UL/C-UL Listed UL 61010-2-201,
UL/C-UL Listed ANSI/ISA-12.12.01 Class I, Division 2,
Groups A, B, C, D T4 (Hazardous Location)

Ordering data

Type	Order No.	Pcs./Pkt.
QUINT4-UPS/24DC/24DC/40	2907077	1

Power supply units and UPS

Uninterruptible power supplies

QUINT UPS for DC applications with dual output voltage

The UPS module for two output voltages, 12 and 24 V DC, allows you to create a custom solution combining a power supply, UPS module, and energy storage device.

- Flexible and space-saving, thanks to two output voltages in one device

Optimum use of the buffer time and preventive monitoring of the energy storage device:

- Detects the current state of charge of the energy storage device and calculates the remaining runtime
- Calculates the current life expectancy of the energy storage device

Substantial power reserve:

- For mains and battery operation
- Power Boost static power reserve
- Dynamic power reserve with SFB (Selective Fuse Breaking) Technology

Extensive signaling and parameterization:

- Floating relay contacts
- Data port (Modbus/RTU)
- Parameterization with memory module

Notes:

The buffer time associated with your solution is dependent on the load current. Exact details for each uninterruptible power supply can be found on page 315.



IQ Technology
Designed by PHOENIX CONTACT



Uninterruptible power supply,
24 V DC/12 V DC, 5 A and 24 V DC, 10 A

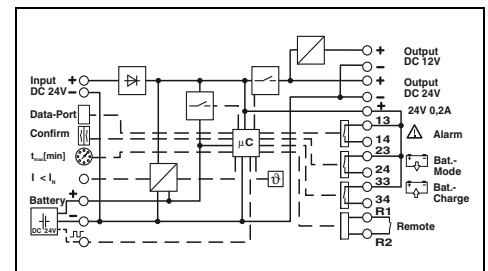

Technical data

Input data	24 V DC
Input voltage	18 V DC ... 30 V DC
Input voltage range	16 A
Max. current consumption	12 V DC
Output data (mains operation)	24 V DC
Nominal output voltage	12 V DC
Output voltage range	18 V DC ... 30 V DC ($U_{OUT} = U_{IN} - 0.5 \text{ V DC}$)
Efficiency (typ.)	> 93% (Mains operation, with charged energy storage)
Output current with convection cooling ($P_{max} = P_{12V} + P_{24V} = 360 \text{ W}$)	> 98% (Mains operation, with charged energy storage)
- Nominal output current I_N (sustained period)	5 A (-25°C ... 60°C)
- SFB Technology (15 ms)	10 A (-25°C ... 60°C)
- Power Boost I_{Boost} (sustained period)	-
Output data (battery operation)	7.5 A (-25°C ... 40°C)
Nominal output voltage	12 V DC
Output voltage range	24 V DC
Output current with convection cooling ($P_{max} = P_{12V} + P_{24V} = 360 \text{ W}$)	12 V DC
- Nominal output current I_N (sustained period)	24 V DC
- SFB Technology (15 ms)	19.2 V DC ... 27.6 V DC ($U_{OUT} = U_{BAT} - 0.5 \text{ V DC}$)
- Power Boost I_{Boost} (sustained period)	5 A (-25°C ... 60°C)
Energy storage	10 A (-25°C ... 60°C)
Nominal voltage U_N	24 V DC
End-of-charge voltage	24 V DC (temperature compensated)
Nominal capacity range	1.3 Ah ... 140 Ah
Max. charging current	0.2 A ... 2.88 A
Signaling	LED, relay contact, interface/software
Signaling	IFS (Interface system data port)
Interfaces	0.6 kg / 35 x 130 x 125 mm
General data	Plug-in screw connection
Weight / Dimensions W x H x D	0.2 - 2.5 mm ² / 0.2 - 2.5 mm ² / 16 - 12
Connection method	0.2 - 2.5 mm ² / 0.2 - 2.5 mm ² / 24 - 12
Input/output connection data rigid / flexible / AWG	IP20 / III
Signal connection data rigid / flexible / AWG	-25°C ... 70°C
Degree of protection / Protection class	60°C ... 70°C (2.5%/K)
Ambient temperature (operation)	
Derating	
Standards/regulations	
UL approvals	UL Listed UL 508, UL/C-UL Recognized UL 60950-1

Ordering data

Description	Type	Order No.	Pcs./Pkt.
Power supply, uninterruptible	QUINT-UPS/ 24DC/12DC/5/24DC/10	2320461	1

Power supply units and UPS

Uninterruptible power supplies

Selecting the energy storage for AC UPS

The new modular system for uninterruptible power supplies always offers the ideal solution for superior system availability. The various storage media feature a wide range of different properties: long service life or very long buffer time, no maintenance or use at extreme ambient temperatures. Whatever your requirements, we offer the ideal energy storage.

Your advantages

- Fast installation
 - Automatic detection of the energy storage device by QUINT UPS
 - Tool-free replacement during operation
- Maximum availability
 - Constant communication with QUINT UPS for continuous monitoring and intelligent management
- Extremely long service life
 - Optimum charging characteristic according to the technology and ambient conditions

Type	Buffer time Typical	Temperature	Service life At +20°C	Service life At +50°C	Charging cycles At +20°C	Weight Standardized
UPS-CAP...	< 5 min	-40 ... 60°C	> 20 years	5 years	> 500.000	0.4 kg
UPS-BAT/LI-ION...	> 40 min	-20 ... 58°C	15 years	2 years	7000	0.45 kg
UPS-BAT/VRLA-WTR...	> 5 h	-25 ... 60°C	12 years	1.5 years	300	1.3 kg
UPS-BAT/VRLA...	> 8 h	0 ... 40°C	6 ... 9 years	1 year	250	1 kg

Buffer times for QUINT AC UPS

Buffer times of energy storage devices with double-layer capacitors, lithium iron phosphate and pure lead AGM technology with wide temperature range

Select **UPS-CAP**, **LI-ION**, and **UPS-BAT/VRLA-WTR** for your **QUINT AC UPS/500 VA** (120/230 V AC applications) here.

Example: 125 W needs to be buffered for one hour.

Solution:
UPS-BAT/VRLA-WTR/24DC/26AH

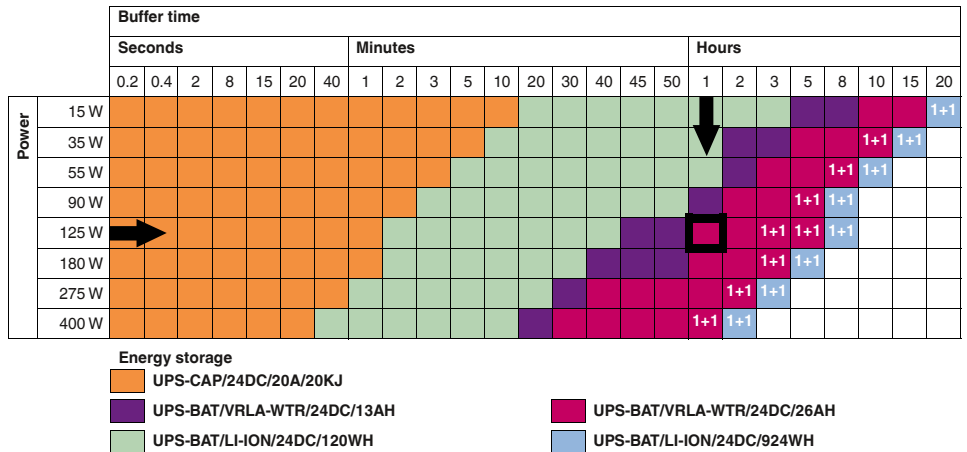

Select **LI-ION** and **UPS-BAT/VRLA-WTR** for your **QUINT AC UPS/1000 VA** (120/230 V AC applications) here.

Example: 400 W needs to be buffered for three hours.

Solution:
2x UPS-BAT/LI-ION /24DC/924WH

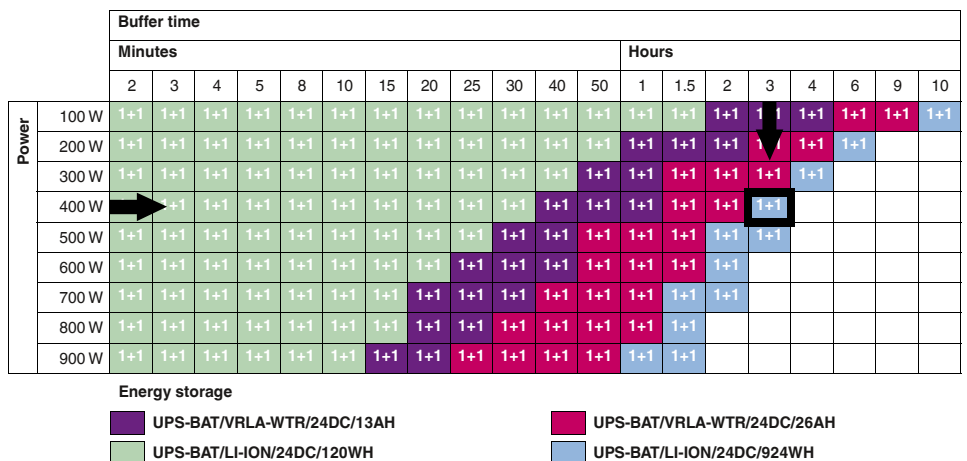

1+1 ... Two energy storage devices of the same capacity are required in this case.
The data is based on an ambient temperature of +20°C.

Power supply units and UPS

Uninterruptible power supplies

QUINT UPS for AC applications

The QUINT UPS for AC applications delivers a pure sine curve at the output. The sine generated in battery operation is synchronous with the mains previously used for supply. The QUINT AC UPS for 120 V AC/230 V AC with 400 W/500 VA power can be combined with all UPS-CAP, LI-ION, and UPS-BAT energy storage devices.

Optimum use of the buffer time and preventive monitoring of the energy storage device:

- Detects the current state of charge of the energy storage device and calculates the remaining runtime
- Calculates the current life expectancy of the energy storage device

Worldwide use:

- Input voltages from 96 to 264 V AC
- Storage of the level and frequency of the input voltage, in the event of mains failure, the output is automatically supplied with 120 V AC/60 Hz or 230 V AC/50 Hz
- Manual voltage pre-selection possible

Maximum energy efficiency:

- Offline operation: 98% efficiency for charged energy storage device
- Power factor $\cos \phi$ 0.8

Extensive signaling and parameterization:

- Switching outputs
- USB interface
- Data port
- Parameterization with memory module

Simplified startup:

- The UPS can be switched on without a power supply network (cold restart)

Notes:

The buffer time associated with your solution is dependent on the load current. Exact details for each uninterruptible power supply can be found on page 328.



IQ Technology[®]
Designed by PHOENIX CONTACT



Uninterruptible power supply,
1 AC / 1 AC, 500 VA

UL US EAC
EX: UL US

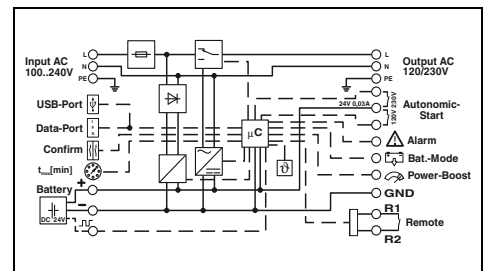

Technical data

General input data	Input voltage range	184 V AC ... 264 V AC
	Frequency range	45 Hz ... 65 Hz
	Activation threshold	Can be configured using UPS-CONF software
Input data	Input data	120 V AC 230 V AC
	Nominal input voltage	120 V AC -20% / +15% 230 V AC -20% / +15%
	Input voltage range AC	102 V AC ... 138 V AC 196 V AC ... 264 V AC
	Nominal frequency	50 Hz ... 60 Hz 50 Hz ... 60 Hz
	Max. current consumption	6.8 A 3.7 A
General output data	Nominal power / Apparent power	400 W / 500 VA
	Derating	> 50°C ... 70°C (2.5%/K)
	Switch-over time	< 10 ms
	Efficiency (typ.)	> 98% > 98% (Mains operation)
Output data (mains operation)	Output data (mains operation)	120 V AC 230 V AC
	Nominal output voltage	120 V AC 230 V AC
	- Nominal output current (sustained period)	4.3 A (-25°C ... 70°C) 2.2 A (-25°C ... 70°C)
	- Power Boost (sustained period)	5.2 A (-25°C ... 70°C) 2.7 A (-25°C ... 70°C)
Output data (battery operation)	Output data (battery operation)	120 V AC 230 V AC
	Nominal output voltage	120 V AC 230 V AC
	- Nominal output current I_N (sustained period)	4.3 A (-25°C ... 50°C) 2.2 A (-25°C ... 50°C)
	- Power Boost I_{Boost} (5 s)	5.2 A (-25°C ... 50°C) 2.7 A (-25°C ... 50°C)
Energy storage	Nominal voltage U_N	24 V DC
	End-of-charge voltage	25 V DC ... 30 V DC (temperature compensated)
	Nominal capacity range	3 Ah ... 200 Ah
	Max. charging current	2 A
Signaling	Signaling	LED, active switching outputs, interface/software
Interfaces	Interfaces	IFS (Interface system data port), MINI-USB type B
General data	Classification according to IEC 62040-3	VFD-SS-311
	Weight / Dimensions W x H x D	2.2 kg / 125 x 130 x 125 mm
	Connection method	Screw connection
	Input/output connection data rigid / flexible / AWG	1.5 - 6 mm ² / 1.5 - 4 mm ² / 18 - 10
	Signal connection data rigid / flexible / AWG	0.2 - 2.5 mm ² / 0.2 - 2.5 mm ² / 24 - 10
	Degree of protection / Protection class	IP20 / I
	Ambient temperature (operation)	-25°C ... 70°C (> 50°C Derating: 2.5%/K)
Standards/regulations	Standards/regulations	UL/C-UL Recognized UL 1778

Ordering data

Description	Type	Order No.	Pcs./Pkt.
Power supply, uninterruptible	QUINT-UPS/ 1AC/ 1AC/500VA	2320270	1



Uninterruptible power supply,
1 AC / 1 AC, 1 KVA

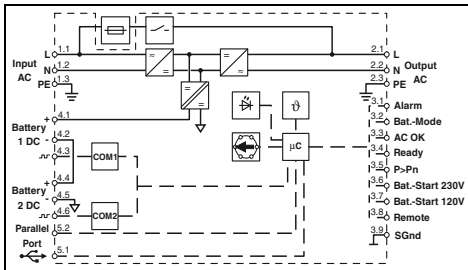

Technical data

90 V AC ... 264 V AC
45 Hz ... 65 Hz

Can be configured using UPS-CONF software

120 V AC	230 V AC
120 V AC -10% / +20%	230 V AC -20% / +15%
96 V AC ... 144 V AC	184 V AC ... 264 V AC
60 Hz ±5%	50 Hz ±5%
10.5 A	5.5 A

900 W / 1 kVA
> 50°C ... 60°C (2.5%/K)
0 ms

> 92% (120 V AC)	> 94% (230 V AC)
120 V AC	230 V AC
120 V AC	230 V AC
8.3 A (-25°C ... 70°C)	4.3 A (-25°C ... 70°C)
13 A (-25°C ... 70°C)	7 A (-25°C ... 70°C)
120 V AC	230 V AC
120 V AC	230 V AC
8.3 A (-25°C ... 70°C)	4.3 A (-25°C ... 70°C)
13 A (-25°C ... 70°C)	7 A (-25°C ... 70°C)

2x 24 V DC
58 V (temperature compensated)
3.4 Ah ... 200 Ah
5 A

LED, active switching output
MINI-USB type B, lockable

VFI-SS-111
5 kg / 290 x 130 x 125 mm
Screw connection
0.2 - 6 mm² / 0.2 - 4 mm² / 30 - 10
0.2 - 2.5 mm² / 0.2 - 2.5 mm² / 30 - 12
IP20 / I
-25°C ... 60°C (> 50°C Derating: 2.5%/K)

UL/C-UL Recognized UL 1778

Ordering data

Type	Order No.	Pcs./Pkt.
QUINT4-UPS/1AC/1AC/1KVA	2320283	1

Power supply units and UPS

Uninterruptible power supplies

TRIO UPS for AC applications

The TRIO UPS for AC applications delivers a pure sine curve at the output. The sine generated in battery operation is synchronous with the mains previously used for supply. Supply AC loads reliably with the new TRIO-UPS-2G uninterruptible power supplies for the DIN rail.

- Space-saving: UPS module and energy storage are combined in one housing
- Long buffer times with integrated VRLA energy storage, can be extended with additional energy storage
- USB interface for connection to higher-level controllers, such as industrial PCs
- Startup from energy storage possible, even without mains input



Uninterruptible power supply,
1 AC / 1 AC, 750 VA



Uninterruptible power supply,
1 AC / 1 AC, 750 VA

ERC CB

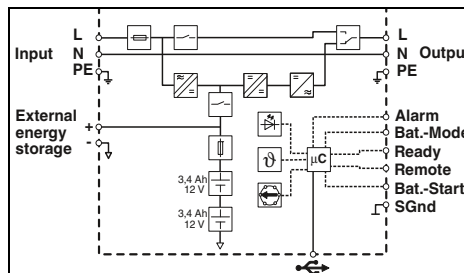

UL US EAC
Ex: cULus

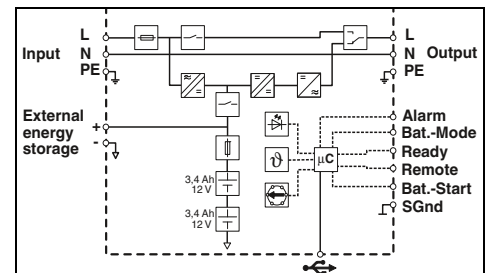

Technical data

Input data	
Input voltage range	184 V AC ... 264 V AC
Frequency range (f _N)	45 Hz ... 55 Hz
Max. current consumption	3 A
General output data	
Input fuse	10 A 400 V gRL
General output data	
Apparent power / Nominal power	750 VA / 600 W
Switch-over time	< 10 ms
Efficiency	> 95% (with charged energy storage device)
Classification according to IEC 62040-3	VFD-SS-311
Output data (mains operation)	
Nominal output voltage	230 V AC
Output current	3 A (750 VA)
Output data (battery operation)	
Nominal output voltage	230 V AC
Output current	3 A (750 VA)
Form of output voltage	Pure sine
Energy storage	
Accumulator type	2x Panasonic UP-VW1220P1
Buffer period	20 min. (100 W) / 4 min. (300 W) / 1 min. (600 W)
Signaling	
LED signaling	AC OK, Alarm, Battery Mode
Transistor switching output	Alarm, Battery Mode, Ready
General data	
Weight / Dimensions W x H x D	5.7 kg / 210 x 170 x 136 mm
Connection method	Push-in connection
Input connection data rigid / flexible / AWG	0.2 - 4 mm ² / 0.2 - 2.5 mm ² / 24 - 12
Output connection data rigid / flexible / AWG	0.2 - 4 mm ² / 0.2 - 2.5 mm ² / 24 - 12
Output connection battery	0.2 - 10 mm ² / 0.2 - 6 mm ² / 24 - 8
Signal connection data rigid / flexible / AWG	0.2 - 1.5 mm ² / 0.2 - 1.5 mm ² / 24 - 16
Degree of protection / Protection class	IP20 / I
MTBF (IEC 61709, SN 29500)	> 206000 h (40°C)
Ambient temperature (operation)	0°C ... 40°C
Ambient temperature (storage/transport)	-15°C ... 40°C (with charged energy storage device)

Standards/regulations	
UL approvals	-

Ordering data

Type	Order No.	Pcs./Pkt.
TRIO-UPS-2G/1AC/1AC/230V/750VA	2905909	1

Technical data

Input data	
Input voltage range	96 V AC ... 138 V AC
Frequency range (f _N)	55 Hz ... 65 Hz
Max. current consumption	6 A
General output data	
Input fuse	10 A 400 V gRL
General output data	
Apparent power / Nominal power	750 VA / 600 W
Switch-over time	< 10 ms
Efficiency	> 95% (with charged energy storage device)
Classification according to IEC 62040-3	VFD-SS-311
Output data (mains operation)	
Nominal output voltage	120 V AC
Output current	6 A (750 VA)
Output data (battery operation)	
Nominal output voltage	120 V AC
Output current	6 A (750 VA)
Form of output voltage	Pure sine
Energy storage	
Accumulator type	2x Panasonic UP-VW1220P1
Buffer period	20 min. (100 W) / 4 min. (300 W) / 1 min. (600 W)
Signaling	
LED signaling	AC OK, Alarm, Battery Mode
Transistor switching output	Alarm, Battery Mode, Ready
General data	
Weight / Dimensions W x H x D	5.7 kg / 210 x 170 x 136 mm
Connection method	Push-in connection
Input connection data rigid / flexible / AWG	0.2 - 4 mm ² / 0.2 - 2.5 mm ² / 24 - 12
Output connection data rigid / flexible / AWG	0.2 - 4 mm ² / 0.2 - 2.5 mm ² / 24 - 12
Output connection battery	0.2 - 10 mm ² / 0.2 - 6 mm ² / 24 - 8
Signal connection data rigid / flexible / AWG	0.2 - 1.5 mm ² / 0.2 - 1.5 mm ² / 24 - 16
Degree of protection / Protection class	IP20 / I
MTBF (IEC 61709, SN 29500)	> 206000 h (40°C)
Ambient temperature (operation)	0°C ... 40°C
Ambient temperature (storage/transport)	-15°C ... 40°C (with charged energy storage device)

Standards/regulations	
UL approvals	UL/C-UL Recognized UL 1778

Ordering data

Type	Order No.	Pcs./Pkt.
TRIO-UPS-2G/1AC/1AC/120V/750VA	2905908	1

USB data cable

MINI-SCREW-USB-DATACABLE

- For communication between the uninterruptible power supply and the UPS-CONF configuration software
- Can be locked in accordance with UL requirements



Description
Data cable for communication between higher-level controllers and uninterruptible power supplies
Cable length: 3 m

Ordering data		
Type	Order No.	Pcs./Pkt.
MINI-SCREW-USB-DATACABLE	2908217	1

Power supply units and UPS

Uninterruptible power supplies

Energy storage for QUINT UPS

Maintenance-free CAP UPS

- Double-layer capacitors
- Life expectancy: > 20 years (20°C), > 5 years (50°C)
- Communication with QUINT UPS
- Integrated temperature sensor
- Works reliably, even in extreme ambient temperatures from -40°C to +60°C



IQ Technology
Designed by PHOENIX CONTACT



Maintenance-free energy storage,
24 V DC, 10 A, 10 kJ



Ex:

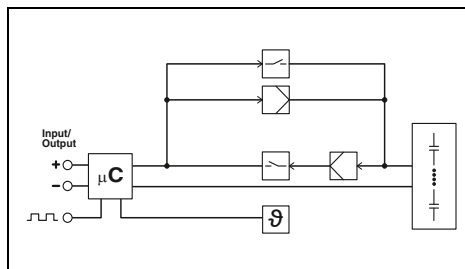

Technical data

Input data	
Nominal capacity	0.1 Ah
Output data	
Output voltage range	22 V DC ... 27 V DC
Output current	10 A
Output fuse	1x 25 A (internal)
Can be connected in parallel/series	No / No
Buffer period	6 min. (1 A) / 33 s (10 A)
General data	
Storage medium	Double-layer capacitor
Weight / Dimensions W x H x D	1.7 kg / 126 x 130 x 126 mm
Degree of protection / Protection class	IP20 / III
Ambient temperature (operation)	-40°C ... 60°C
Ambient temperature (storage/transport)	-40°C ... 60°C
Service life	20 years (20°C)
Standards/regulations	
UL approvals	UL/C-UL Recognized UL 60950-1

Ordering data

Description	
Energy storage	

Type	Order No.	Pcs./Pkt.
UPS-CAP/24DC/10A/10KJ	2320377	1



IQ Technology
Designed by PHOENIX CONTACT



Maintenance-free energy storage,
24 V DC, 20 A, 20 kJ



Ex:

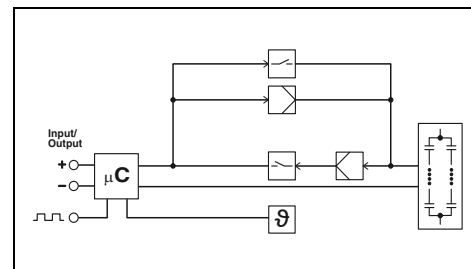

Technical data

Input data	
Nominal capacity	0.2 Ah
Output data	
Output voltage range	22 V DC ... 27 V DC
Output current	20 A
Output fuse	2x 25 A (internal)
Can be connected in parallel/series	No / No
Buffer period	12 min. (1 A) / 33 s (20 A)
General data	
Storage medium	Double-layer capacitor
Weight / Dimensions W x H x D	2.9 kg / 150 x 130 x 176 mm
Degree of protection / Protection class	IP20 / III
Ambient temperature (operation)	-40°C ... 60°C
Ambient temperature (storage/transport)	-40°C ... 60°C
Service life	20 years (20°C)
Standards/regulations	
UL approvals	UL/C-UL Recognized UL 60950-1

Ordering data

Type	Order No.	Pcs./Pkt.
UPS-CAP/24DC/20A/20KJ	2320380	1

Energy storage for QUINT UPS

UPS-BAT/LI-ION for long service life with long buffer times

- Lithium iron phosphate technology
- Works reliably, even in extreme ambient temperatures from -20°C to +58°C
- Communication with QUINT UPS
- Integrated temperature sensor for optimum charging
- Battery can be changed without tools



IQ Technology
Designed by PHOENIX CONTACT



LI-ION energy storage, 120 Wh



LI-ION energy storage, 924 Wh

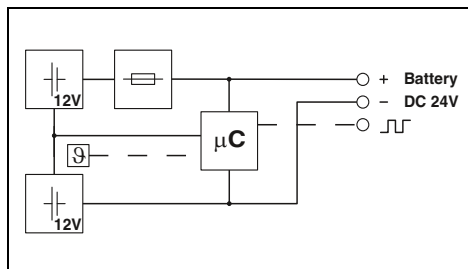

Technical data

Input data/output data	
Nominal input voltage	24 V DC
Nominal capacity	120 Wh
Output current	30 A
Output fuse	1x 30 A ATOF 32V (breaking capacity 1000 A)
Can be connected in parallel/series	Yes / No
Buffer period	14 min. (20 A)
General data	
Storage medium	LI-ION, 120 Wh
Weight / Dimensions W x H x D	2.9 kg / 135 x 202 x 110 mm
Degree of protection / Protection class	IP20 / III
Ambient temperature (operation)	-20°C ... 58°C
Service life	-
Standards/regulations	UL/C-UL Listed UL 508, UL/C-UL Recognized UL 60950-1, UL ANSI/ISA-12.12.01 Class I, Division 2, Groups A, B, C, D (Hazardous Location)
UL approvals	-

Ordering data

Description	Type	Order No.	Pcs./Pkt.
Energy storage	UPS-BAT/LI-ION/24DC/120WH	2320351	1

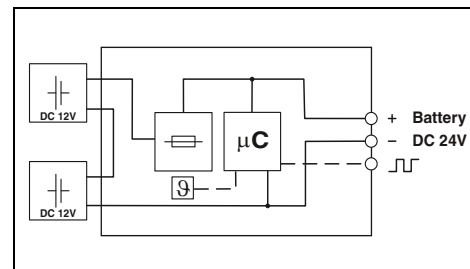

Technical data

Input data/output data	
Nominal input voltage	24 V
Nominal capacity	924 Wh
Output current	45 A
Output fuse	2x 25 A ATOF 32V (breaking capacity 1000 A)
Can be connected in parallel/series	Yes / No
Buffer period	105 min. (20 A (20°C)) / 50 min. (40 A (20°C))
General data	
Storage medium	LI-ION, 924 Wh
Weight / Dimensions W x H x D	12.9 kg / 264 x 224 x 197 mm
Degree of protection / Protection class	IP20 / III
Ambient temperature (operation)	-25°C ... 58°C
Service life	15 years (20°C)
Standards/regulations	-
UL approvals	-

Ordering data

Description	Type	Order No.	Pcs./Pkt.
Energy storage	UPS-BAT/LI-ION/24DC/924WH	2908232	1

Power supply units and UPS

Uninterruptible power supplies

Energy storage for QUINT UPS

UPS BAT/VRLA for maximum buffer times

- Lead AGM (Absorbent Glass Mat) technology
- Ambient temperatures from 0°C to +40°C
- Long buffer times for high currents
- Communication with QUINT UPS
- Integrated temperature sensor for optimum charging
- Battery can be changed without tools



IQ Technology[®]
Designed by PHOENIX CONTACT



VRLA energy storage,
1.3 Ah



IQ Technology[®]
Designed by PHOENIX CONTACT



VRLA energy storage,
3.4 Ah

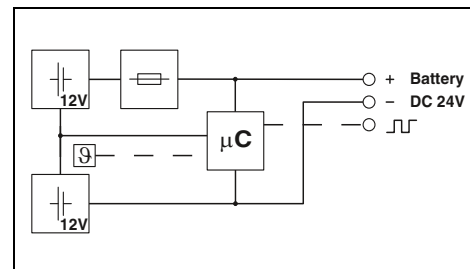
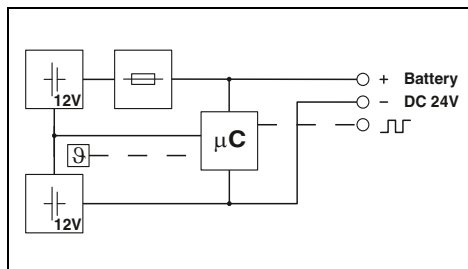

Technical data

Input data/output data
Nominal input voltage
Nominal capacity
Output current
Output fuse
Can be connected in parallel/series
Buffer period
General data
Storage medium
Weight / Dimensions W x H x D
Degree of protection / Protection class
Ambient temperature (operation)
Service life
Standards/regulations
UL approvals

24 V DC
1.3 Ah
15 A
1x 15 A
Yes / No
20 min. (2 A) / 5 min. (5 A)
Lead rechargeable battery module
1.7 kg / 54 x 157 x 113 mm
IP20 / III
0°C ... 40°C
6 years ... 9 years (20°C)
UL/C-UL Listed UL 508, UL/C-UL Recognized UL 60950-1, UL ANSI/ISA-12.12.01 Class I, Division 2, Groups A, B, C, D (Hazardous Location)

Ordering data

Description
Energy storage

Type	Order No.	Pcs./Pkt.
UPS-BAT/VRLA/24DC/1.3AH	2320296	1

Accessories

Fuse
Mounting set
Mounting set

FUSE 15A/32V FK1	2908360	2
------------------	---------	---

Technical data

24 V DC
3.4 Ah
25 A
1x 25 A
Yes / No
4.5 min. (20 A) / 3 min. (25 A)
Lead rechargeable battery module
3.3 kg / 85 x 191 x 110 mm
IP20 / III
0°C ... 40°C
6 years ... 9 years (20°C)
UL/C-UL Listed UL 508, UL/C-UL Recognized UL 60950-1, UL ANSI/ISA-12.12.01 Class I, Division 2, Groups A, B, C, D (Hazardous Location)

Ordering data

Type	Order No.	Pcs./Pkt.
UPS-BAT/VRLA/24DC/3.4AH	2320306	1

Accessories

FUSE 25A/32V ATOF	2908366	2
-------------------	---------	---



IQ Technology[®]
Designed by PHOENIX CONTACT

VRLA energy storage,
7.2 Ah

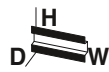

IQ Technology[®]
Designed by PHOENIX CONTACT

VRLA energy storage,
12 Ah

IQ Technology[®]
Designed by PHOENIX CONTACT



VRLA energy storage,
38 Ah



Ex:



Ex:



Ex:

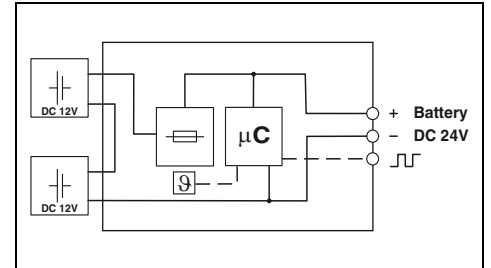
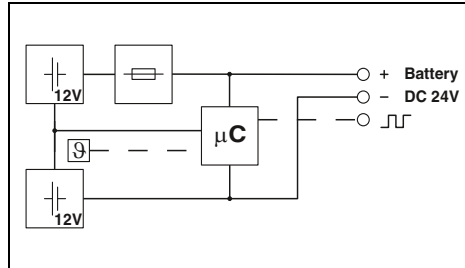
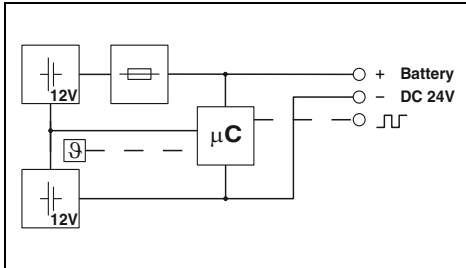

Technical data

24 V DC
7.2 Ah
50 A
2x 25 A
Yes / No
10 min. (20 A) / 3 min. (40 A)

Lead rechargeable battery module
5.9 kg / 135 x 202 x 110 mm
IP20 / III
0°C ... 40°C
6 years ... 9 years (20°C)

UL/C-UL Listed UL 508, UL/C-UL Recognized UL 60950-1,
UL ANSI/ISA-12.12.01 Class I, Division 2, Groups A, B, C, D
(Hazardous Location)

Ordering data

Type	Order No.	Pcs./Pkt.
UPS-BAT/VRLA/24DC/7.2AH	2320319	1

Accessories

Accessories	Order No.	Pcs./Pkt.
FUSE 25A/32V ATOF	2908366	2

Technical data

24 V DC
12 Ah
50 A
2x 25 A
Yes / No
22.5 min. (20 A) / 9 min. (40 A)

Lead rechargeable battery module
8.9 kg / 202 x 202 x 110 mm
IP20 / III
0°C ... 40°C
6 years ... 9 years (20°C)

UL/C-UL Listed UL 508, UL/C-UL Recognized UL 60950-1,
UL ANSI/ISA-12.12.01 Class I, Division 2, Groups A, B, C, D
(Hazardous Location)

Ordering data

Type	Order No.	Pcs./Pkt.
UPS-BAT/VRLA/24DC/12AH	2320322	1

Accessories

Accessories	Order No.	Pcs./Pkt.
FUSE 25A/32V ATOF	2908366	2

Technical data

24 V DC
38 Ah
45 A
2x 25 A ATOF 32V
Yes / No
72 min. (20 A) / 35 min. (40 A)

Lead rechargeable battery module
26 kg / 330 x 221 x 197 mm
IP20 / III
0°C ... 40°C
-

UL/C-UL Listed UL 508, UL/C-UL Recognized UL 60950-1,
UL ANSI/ISA-12.12.01 Class I, Division 2, Groups A, B, C, D
(Hazardous Location)

Ordering data

Type	Order No.	Pcs./Pkt.
UPS-BAT/VRLA/24DC/38AH	2320335	1

Accessories

Accessories	Order No.	Pcs./Pkt.
FUSE 25A/32V ATOF	2908366	2
BATTERY MOUNTING KIT	2320788	1
BATTERY MOUNTING CASE	2320458	1

Power supply units and UPS

Uninterruptible power supplies

Energy storage for QUINT UPS

UPS BAT/VRLA-WTR for temperatures from -25°C to +60°C

- Pure lead AGM technology
- Communication with QUINT UPS
- Integrated temperature sensor for optimum charging

IQ Technology[®]
Designed by PHOENIX CONTACT



Energy storage
with wide temperature range
24 V DC, 13 Ah

UL US EAC CE CB
Ex:

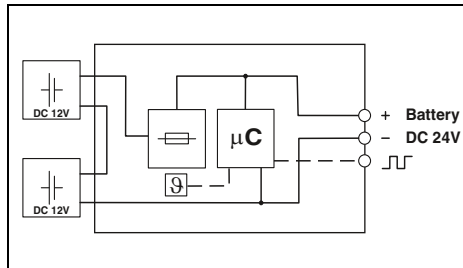

IQ Technology[®]
Designed by PHOENIX CONTACT



Energy storage
with wide temperature range
24 V DC, 26 Ah

UL US EAC CE CB
Ex:

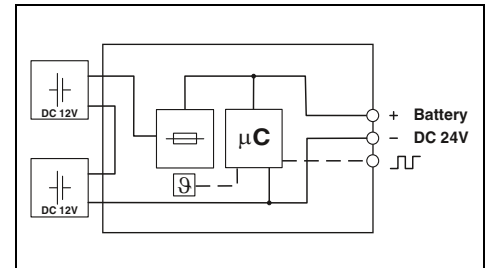

Input data/output data	
Nominal input voltage	24 V DC
Nominal capacity	13 Ah
Output current	45 A
Output fuse	2x 25 A ATOF 32V
Can be connected in parallel/series	Yes / No
Buffer period	50 min. (10 A) / 10 min. (40 A)
General data	
Storage medium	Pure lead AGM
Weight / Dimensions W x H x D	10.8 kg / 172 x 177 x 178 mm
Degree of protection / Protection class	IP20 / III
Ambient temperature (operation)	-25°C ... 60°C
Ambient temperature (storage/transport)	-40°C ... 60°C
Standards/regulations	
UL approvals	UL/C-UL Listed UL 508, UL/C-UL Recognized UL 60950-1
GL approvals	DNV GL (EMC A), ABS

Technical data		
24 V DC		
13 Ah		
45 A		
2x 25 A ATOF 32V		
Yes / No		
50 min. (10 A) / 10 min. (40 A)		
Pure lead AGM		
10.8 kg / 172 x 177 x 178 mm		
IP20 / III		
-25°C ... 60°C		
-40°C ... 60°C		
UL/C-UL Listed UL 508, UL/C-UL Recognized UL 60950-1		
DNV GL (EMC A), ABS		

Technical data		
24 V DC		
26 Ah		
45 A		
2x 25 A ATOF 32V		
Yes / No		
120 min. (10 A) / 30 min. (40 A)		
Pure lead AGM		
21.6 kg / 358 x 174 x 169 mm		
IP20 / III		
-25°C ... 60°C		
-40°C ... 60°C		
UL/C-UL Listed UL 508, UL/C-UL Recognized UL 60950-1		
DNV GL (EMC A), ABS		

Description	Type	Order No.	Pcs./Pkt.
Energy storage	UPS-BAT/VRLA-WTR/24DC/13AH	2320416	1

Ordering data			
Type	Order No.	Pcs./Pkt.	
UPS-BAT/VRLA-WTR/24DC/13AH	2320416	1	

Ordering data			
Type	Order No.	Pcs./Pkt.	
UPS-BAT/VRLA-WTR/24DC/26AH	2320429	1	

Fuse	FUSE 25A/32V ATOF	2908366	2
Mounting set	BATTERY MOUNTING KIT	2320788	1
Mounting set	BATTERY MOUNTING CASE	2320458	1

Accessories			
FUSE 25A/32V ATOF	2908366	2	
BATTERY MOUNTING KIT	2320788	1	
BATTERY MOUNTING CASE	2320458	1	

Accessories			
FUSE 25A/32V ATOF	2908366	2	
BATTERY MOUNTING KIT	2320788	1	
BATTERY MOUNTING CASE	2320458	1	

Mounting accessories

Battery mounting kit

- For attaching individual battery blocks to a mounting plate
- Consists of four powder-coated metal brackets and a fabric lashing strap



Battery mounting case

- Battery frame for universal wall or surface mounting of battery blocks and electronics



Ordering data		
Type	Order No.	Pcs./Pkt.
BATTERY MOUNTING KIT	2320788	1

Ordering data		
Type	Order No.	Pcs./Pkt.
BATTERY MOUNTING CASE	2320458	1

Description
Mounting set

Power supply units and UPS

Uninterruptible power supplies

Configuration software for QUINT UPS, TRIO UPS, and QUINT CAP

The UPS-CONF configuration software can be downloaded free of charge from our homepage. The IFS-USB-DATACABLE is required in order to use the software.

Supported operating systems:

- Windows 7 (32 and 64-bit)
- Windows 8 (32 and 64-bit)
- Windows 8.1 (32 and 64-bit)
- Windows 10 (32 and 64-bit)

Minimum requirements:

- Display: 800 x 600, 256 colors
- Processor: 400 MHz, Pentium processor or similar
- RAM: 96 MB



Description	Ordering data		
	Type	Order No.	Pcs./Pkt.
Configuration software for QUINT UPS, TRIO UPS, and QUINT CAP	UPS-CONF	2320403	1

Accessories for QUINT UPS and TRIO DC UPS

IFS-USB-DATACABLE

- For communication between the uninterruptible power supply and the UPS-CONF configuration software

IFS-CONFSTICK

- For storing the values you have configured and quickly transferring them to other uninterruptible power supplies



Memory module

Description	Ordering data			Ordering data		
	Type	Order No.	Pcs./Pkt.	Type	Order No.	Pcs./Pkt.
Programming adapter for configuring modules with S-PORT interface Cable length: 3 m	IFS-USB-DATACABLE	2320500	1	IFS-CONFSTICK	2986122	1
Multi-functional memory module for the Interface system				IFS-CONFSTICK-L	2901103	1
- Flat design - Tall design						

Accessories for QUINT UPS and TRIO DC UPS

IFS-RS232-DATACABLE

- For Modbus communication with the RS-232 interface
- Connection to the Phoenix Contact COM server for Ethernet communication
- Communicate directly with higher-level controllers, such as Phoenix Contact ILC or RFC, or use as a gateway



IFS-MINI-DIN-DATACABLE

- For direct communication with the ILC from the Phoenix Contact Inline system

IFS-OPEN-END-DATACABLE

- Open cable for flexible communication

QUINT UPS function blocks

- For further processing of information communicated via data cables
- For PC Worx software
- Free download at phoenixcontact.net/products

Description
Data cable for communication between higher-level controllers and QUINT UPS uninterruptible power supplies, cable length: 2 m
Modbus communication
Direct communication
Flexible communication

Ordering data		
Type	Order No.	Pcs./Pkt.
IFS-RS232-DATACABLE	2320490	1
IFS-MINI-DIN-DATACABLE	2320487	1
IFS-OPEN-END-DATACABLE	2320450	1

Accessories for QUINT UPS and TRIO DC UPS

IFS-BT-PROG-ADAPTER

- For wireless communication between the uninterruptible power supply and the UPS-CONF configuration software



Bluetooth adapter

Description
Bluetooth programming adapter , with USB and S-PORT interface

Ordering data		
Type	Order No.	Pcs./Pkt.
IFS-BT-PROG-ADAPTER	2905872	1

Power supply units and UPS

Uninterruptible power supplies

Selection of UPS modules with integrated energy storage or integrated power supply



To save space in the control cabinet or to retrofit existing systems easily, UPS versions with integrated energy storage (QUINT, UNO, and STEP) or integrated power supply (MINI and TRIO) are recommended.

Buffer times for UNO UPS and STEP UPS

Select your UPS solution here.

Example: 2.5 A needs to be buffered for 10 minutes:

Solution:
STEP-UPS/24DC/24DC/3

Load current	Buffer time																										
	Seconds							Minutes													Hours						
	0.2	0.4	1	2	8	16	30	1	2	3	5	6	7	8	9	10	15	20	25	30	40	45	50	1	1.5	2	3
0.5 A	Orange										Blue										Green						
1 A	Orange										Blue										Green						
1.5 A	Orange										Blue										Green						
2 A	Orange										Blue										Green						
2.5 A	Orange										Blue										Green						
3 A	Orange										Blue										Green						
4 A	Orange										Blue										Green						

- UPS modules with integrated energy storage
- UNO-UPS/24DC/24DC/60W
 - STEP-UPS/24DC/24DC/3/46WH
 - STEP-UPS/12DC/12DC/4/46WH

The data is based on an ambient temperature of +20°C.

Buffer times for QUINT CAP

Select your UPS solution here.

Example: 5 A needs to be buffered for 40 seconds:

Solution:
QUINT4-CAP/24DC/10/8KJ

Load current	Buffer time									
	Seconds					Minutes				
	15	20	30	40	50	1	2	3	5	
1 A	Blue					Green				
2.5 A	Blue					Green				
5 A	Blue					Green				
6.25 A	Grey					Green				
7.5 A	Grey					Green				
10 A	Grey					Green				
12.5 A	Grey					Green				

- UPS modules with integrated energy storage
- QUINT4-CAP/24DC/3.8/1KJ/PT
 - QUINT4-CAP/24DC/5/4KJ
 - QUINT4-CAP/24DC/10/8KJ

The data is based on an ambient temperature of +25°C.

Buffer times for QUINT UPS and QUINT BUFFER

Particularly space-saving: UPS module and energy storage combined in one housing. It's just a case of connecting a power supply upstream.

Select your QUINT UPS or QUINT BUFFER here.

Example: 5 A needs to be buffered for 20 minutes.

Solution:
QUINT-UPS/24DC/24DC/10/3.4AH

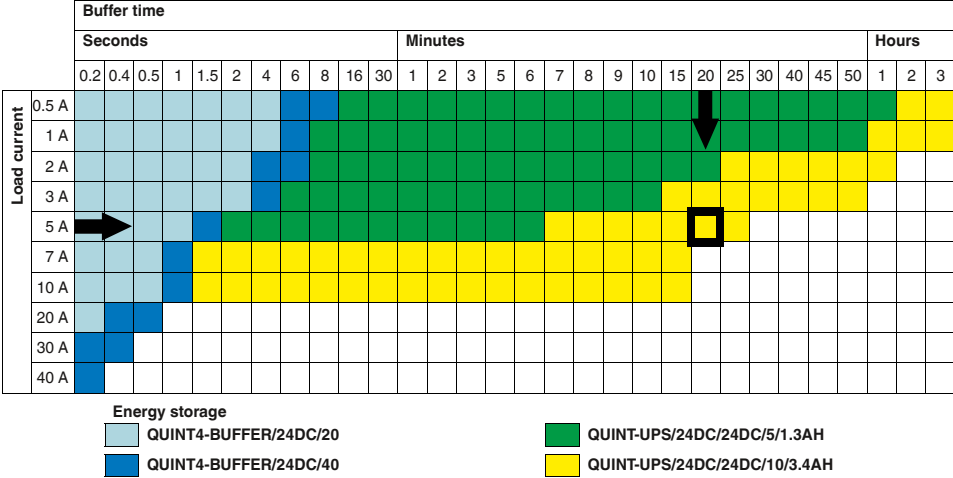

The data is based on an ambient temperature of +20°C.

Buffer times for MINI UPS and TRIO UPS

Particularly space-saving: UPS module and power supply combined in one housing. It's just a case of connecting an energy storage device upstream.

Buffer times for MINI DC UPS
Select your MINI-BAT for your MINI UPS here.

Example: 1 A needs to be buffered for 20 minutes.

Solution:
MINI-DC-UPS/24DC/2 and
MINI-BAT/24DC/0.8AH

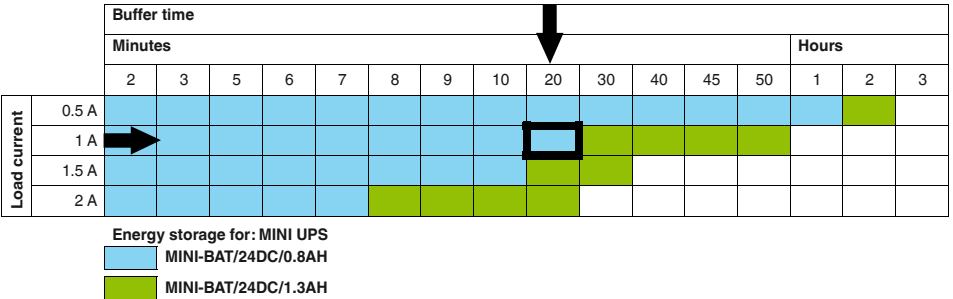

Buffer times for TRIO DC UPS

Select your energy storage device for your TRIO DC UPS here.

Example: 10 A needs to be buffered for 10 minutes.

Solution:
TRIO-UPS-2G/1AC/24DC/10 and
UPS-BAT/VRLA/24DC/3.4AH

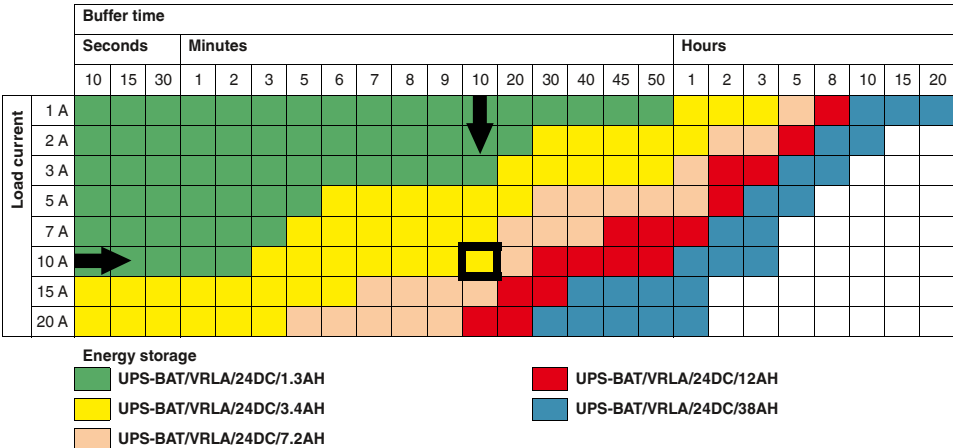

The data is based on an ambient temperature of +20°C.

Power supply units and UPS

Uninterruptible power supplies

UPS module with integrated energy storage

QUINT-UPS is very easy to install in existing systems. It's just a case of connecting a 24 V DC power supply unit upstream and the reliable UPS solution is complete.

- Advantages of using IQ Technology
- Minimal wiring effort
- Maintenance-free energy storage device with lead AGM technology

Notes:
The buffer time associated with your solution is dependent on the load current. Exact details for each uninterruptible power supply can be found on page 343.



IQ Technology
Designed by PHOENIX CONTACT



Uninterruptible power supply with integrated energy storage, 24 V DC / 24 V DC, 5 A, 1.3 Ah

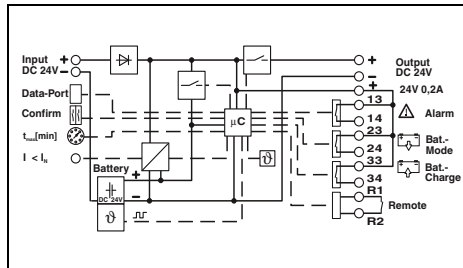

Technical data

Input data	
Input voltage range	18 V DC ... 30 V DC
Max. current consumption	9.3 A (24 V DC)
Output data	
Nominal output voltage	24 V DC
Output voltage range	19.2 V DC ... 27.6 V DC ($U_{OUT} = U_{BAT} - 0.5 V DC$)
Output current	5 A
Can be connected in parallel/series	Yes / No
Buffer period	50 min. (1 A) / 5 min. (5 A)
Max. power dissipation (normal mode / buffer mode)	2.5 W / 3.3 W
Efficiency	> 97.1% (Mains operation, with charged energy storage) / 97.31%
Signaling	
Signaling	LED, relay contact, interface/software
Interfaces	IFS (Interface system data port)
General data	
Storage medium	Lead rechargeable battery module 1.3 Ah
Weight / Dimensions W x H x D	2.2 kg / 88 x 138 x 125 mm
Mounting position	horizontal DIN rail NS 35, EN 60715
Connection	alignable: horizontal 5 mm, vertical 50 mm
Connection method	Plug-in screw connection
Input connection data rigid / flexible / AWG	0.2 - 2.5 mm ² / 0.2 - 2.5 mm ² / 20 - 12
Output connection data rigid / flexible / AWG	0.2 - 2.5 mm ² / 0.2 - 2.5 mm ² / 20 - 12
Signal connection data rigid / flexible / AWG	0.2 - 2.5 mm ² / 0.2 - 2.5 mm ² / 24 - 12
Degree of protection / Protection class	IP20 / III
MTBF (IEC 61709, SN 29500)	> 806000 h (40°C)
Ambient temperature (operation)	0°C ... 40°C
Ambient temperature (storage/transport)	-15°C ... 40°C
Service life	6 years ... 9 years (20°C)
Latest startup	3 Months (0°C ... 20°C) 1 Months (30°C ... 40°C)
Standards/regulations	
Electromagnetic compatibility	Conformance with EMC Directive 2014/30/EU
Electrical safety, safety transformer	EN 60950-1/VDE 0805 (SELV)
Electronic equipm. for electrical power installations	EN 50178/VDE 0160 (PELV)
UL approvals	UL/C-UL Recognized UL 60950-1, UL Listed UL 508

Ordering data

Description	
Power supply, uninterruptible	
Fuse	

Type	Order No.	Pcs./Pkt.
QUINT-UPS/ 24DC/ 24DC/ 5/1.3AH	2320254	1
Accessories		
FUSE 15A/32V FKS ATO	2908361	2



IQ Technology
Designed by PHOENIX CONTACT



Uninterruptible power supply with integrated energy storage, 24 V DC / 24 V DC, 10 A, 3.4 Ah

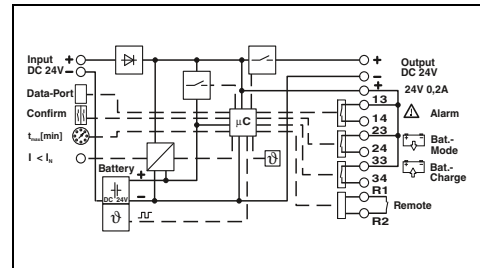

Technical data

Input data	
Input voltage range	18 V DC ... 30 V DC
Max. current consumption	18.6 A (24 V DC)
Output data	
Nominal output voltage	24 V DC
Output voltage range	19.2 V DC ... 27.6 V DC ($U_{OUT} = U_{BAT} - 0.5 V DC$)
Output current	10 A
Can be connected in parallel/series	Yes / No
Buffer period	180 min. (1 A) / 10 min. (10 A)
Max. power dissipation (normal mode / buffer mode)	3.1 W / 6.3 W
Efficiency	> 97.6% (Mains operation, with charged energy storage) / 96.41%
Signaling	
Signaling	LED, relay contact, interface/software
Interfaces	IFS (Interface system data port)
General data	
Storage medium	Lead rechargeable battery module, 3.4 Ah
Weight / Dimensions W x H x D	3.8 kg / 120 x 169 x 125 mm
Mounting position	horizontal DIN rail NS 35, EN 60715
Connection	alignable: horizontal 5 mm, vertical 50 mm
Connection method	Plug-in screw connection
Input connection data rigid / flexible / AWG	0.2 - 2.5 mm ² / 0.2 - 2.5 mm ² / 16 - 12
Output connection data rigid / flexible / AWG	0.2 - 2.5 mm ² / 0.2 - 2.5 mm ² / 16 - 12
Signal connection data rigid / flexible / AWG	0.2 - 2.5 mm ² / 0.2 - 2.5 mm ² / 24 - 12
Degree of protection / Protection class	IP20 / III
MTBF (IEC 61709, SN 29500)	> 806000 h (40°C)
Ambient temperature (operation)	0°C ... 40°C
Ambient temperature (storage/transport)	-15°C ... 40°C
Service life	6 years ... 9 years (20°C)
Latest startup	6 Months (0°C ... 20°C)
Standards/regulations	
Electromagnetic compatibility	Conformance with EMC Directive 2014/30/EU
Electrical safety, safety transformer	EN 60950-1/VDE 0805 (SELV)
Electronic equipm. for electrical power installations	EN 50178/VDE 0160 (PELV)
UL approvals	UL/C-UL Recognized UL 60950-1, UL Listed UL 508

Ordering data

Type	Order No.	Pcs./Pkt.
QUINT-UPS/ 24DC/ 24DC/10/3.4AH	2320267	1
Accessories		
FUSE 15A/32V FKS ATO	2908361	2

Maintenance-free buffer module

The QUINT BUFFER is ideal for failures lasting just seconds.

It combines an electronic switch-over unit and a capacitor-based energy storage device in the same housing.

- High system availability due to long capacitor service life
- Maintenance-free due to electrolytic capacitors
- Thanks to soft start, can be used with power supplies in the low power range
- Space savings, thanks to compact design

Notes:
The buffer time associated with your solution is dependent on the load current. Exact details for each uninterruptible power supply can be found on page 343.



**Maintenance-free capacity module
24 V DC / 20 A**

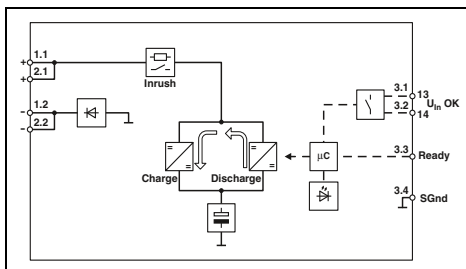

Technical data

Input data	
Input voltage range	22.5 V DC ... 30 V DC
Current consumption (idling/charging process/max.)	0.2 A / 0.6 A / 26 A
Connect threshold (fixed, variable)	< 22 V DC, -
Output data	
Nominal output voltage	24 V DC (depending on the input voltage)
Output current I _N / I _{Stat.Boost} / I _{Dyn.Boost} / I _{SFB}	20 A / 25 A / - / -
Can be connected in parallel/series	No / No
Buffer period	0.2 s (20 A) / 2 s (2 A)
Maximum power dissipation for nominal condition	< 6 W
Signaling	
LED signaling	U _{IN} OK, Ready
Transistor switching output	Ready
Floating signal contact	U _{IN} OK
General data	
Storage medium	Electrolytic capacitor
Weight / Dimensions W x H x D	1 kg / 56 x 130 x 125 mm
Mounting position	horizontal DIN rail NS 35, EN 60715
Connection	alignable: horizontally 0 mm, vertically 50 mm
Connection method	Screw connection
Input connection data rigid / flexible / AWG	0.2 - 6 mm ² / 0.2 - 4 mm ² / 30 - 10
Output connection data rigid / flexible / AWG	0.2 - 6 mm ² / 0.2 - 4 mm ² / 30 - 10
Signal connection data rigid / flexible / AWG	0.2 - 1.5 mm ² / 0.2 - 1.5 mm ² / 24 - 16
Degree of protection / Protection class	IP20 / Special application (SELV input voltage, hazardous voltages are generated in the device).
MTBF (IEC 61709, SN 29500)	2497464 h (40°C)
Ambient temperature (operation)	-25°C ... 70°C (> 40°C Derating: 1%/K / > 60°C Derating: 2.5%/K)
Standards/regulations	
Insulation voltage: input, output/housing	500 V
Electromagnetic compatibility	Conformance with EMC Directive 2014/30/EU
Electrical safety	IEC 60950-1/VDE 0805 (SELV)
Electronic equipm. for electrical power installations	-
UL approvals	UL Listed UL 508, UL/C-UL Recognized UL 60950-1

Ordering data

Description	Type	Order No.	Pcs./Pkt.
Buffer module, maintenance-free	QUINT4-BUFFER/24DC/20	2907913	1



**Maintenance-free capacity module
24 V DC / 40 A**

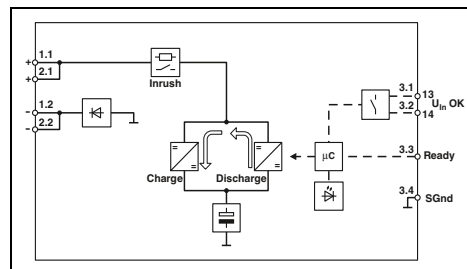

Technical data

Input data	
Input voltage range	22.5 V DC ... 30 V DC
Current consumption (idling/charging process/max.)	0.2 A / 0.8 A / 46 A
Connect threshold (fixed, variable)	< 22 V DC, -
Output data	
Nominal output voltage	24 V DC (depending on the input voltage)
Output current I _N / I _{Stat.Boost} / I _{Dyn.Boost} / I _{SFB}	40 A / 45 A / - / -
Can be connected in parallel/series	No / No
Buffer period	0.2 s (40 A) / 2 s (4 A)
Maximum power dissipation for nominal condition	< 9 W
Signaling	
LED signaling	U _{IN} OK, Ready
Transistor switching output	Ready
Floating signal contact	U _{IN} OK
General data	
Storage medium	Electrolytic capacitor
Weight / Dimensions W x H x D	1.2 kg / 72 x 130 x 125 mm
Mounting position	horizontal DIN rail NS 35, EN 60715
Connection	alignable: horizontally 0 mm, vertically 50 mm
Connection method	Screw connection
Input connection data rigid / flexible / AWG	0.5 - 16 mm ² / 0.5 - 16 mm ² / 10 - 6
Output connection data rigid / flexible / AWG	0.5 - 16 mm ² / 0.5 - 16 mm ² / 10 - 6
Signal connection data rigid / flexible / AWG	0.2 - 1.5 mm ² / 0.2 - 1.5 mm ² / 24 - 16
Degree of protection / Protection class	IP20 / Special application (SELV input voltage, hazardous voltages are generated in the device).
MTBF (IEC 61709, SN 29500)	2813895 h (40°C)
Ambient temperature (operation)	-25°C ... 70°C (> 40°C Derating: 0.56%/K / > 60°C Derating: 2.5%/K)
Standards/regulations	
Insulation voltage: input, output/housing	500 V
Electromagnetic compatibility	Conformance with EMC Directive 2014/30/EU
Electrical safety	IEC 60950-1/VDE 0805 (SELV)
Electronic equipm. for electrical power installations	-
UL approvals	UL Listed UL 508, UL/C-UL Recognized UL 60950-1

Ordering data

Description	Type	Order No.	Pcs./Pkt.
Buffer module, maintenance-free	QUINT4-BUFFER/24DC/40	2908283	1

Power supply units and UPS

Uninterruptible power supplies

Maintenance-free buffer module

QUINT CAP is ideal for cyclical failures lasting up to 30 seconds. It combines an electronic switch-over unit and a capacitor-based energy storage device in the same housing.

- Convenient PC shutdown
- Maintenance-free with a long service life
- Space savings, thanks to compact design
- Long buffer time, thanks to high memory capacity

Notes:

The buffer time associated with your solution is dependent on the load current. Exact details for each uninterruptible power supply can be found on page 342.



**Maintenance-free Ultra-CAP
capacity module
24 V DC, 5 A**

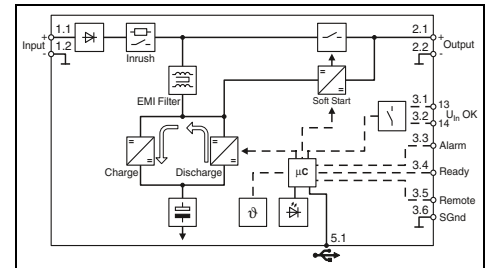

Technical data

Input data		
Input voltage range	22.5 V DC ... 30 V DC	
Current consumption (idling/charging process/max.)	0.1 A / 0.8 A / 7 A	
Connect threshold (fixed, variable)	< 22 V DC, -	
Output data		
Nominal output voltage	24 V DC	
Output current I_N / $I_{Stat. Boost}$ / $I_{Dyn. Boost}$ / I_{SFB}	5 A / 6.25 A / - / -	
Can be connected in parallel/series	No / No	
Buffer period	3 min. (1 A) / 1 min. (2.5 A) / 30 s (5 A)	
Maximum power dissipation for nominal condition	< 3 W	
Signaling		
LED signaling	U_{IN} OK, Alarm, Ready	
Transistor switching output	Alarm, Ready	
Floating signal contact	U_{IN} OK	
General data		
Storage medium	Double-layer capacitor	
Weight / Dimensions W x H x D	1.3 kg / 94 x 130 x 125 mm	
Mounting position	horizontal DIN rail NS 35, EN 60715	
Connection	alignable: horizontally 0 mm, vertically 50 mm	
Connection method	Screw connection	
Input connection data rigid / flexible / AWG	0.2 - 2.5 mm ² / 0.2 - 2.5 mm ² / 30 - 12	
Output connection data rigid / flexible / AWG	0.2 - 2.5 mm ² / 0.2 - 2.5 mm ² / 30 - 12	
Signal connection data rigid / flexible / AWG	0.2 - 1.5 mm ² / 0.2 - 1.5 mm ² / 24 - 16	
Degree of protection / Protection class	IP20 / Special application (SELV input voltage, hazardous voltages are generated in the device).	
MTBF (IEC 61709, SN 29500)	1301923 h (40°C)	
Ambient temperature (operation)	-25°C ... 60°C (> 40°C Derating: 1%/K)	
Standards/regulations		
Insulation voltage: input, output/housing	500 V	
Electromagnetic compatibility	Conformance with EMC Directive 2014/30/EU	
Electrical safety	IEC 60950-1/VDE 0805 (SELV)	
UL approvals	UL Listed UL 508, UL/C-UL Recognized UL 60950-1	
Ordering data		
Type	Order No.	Pcs./Pkt.
QUINT4-CAP/24DC/5/4KJ	2320539	1

Description
Buffer module, maintenance-free



**Maintenance-free Ultra-CAP
capacity module
24 V DC, 10 A**

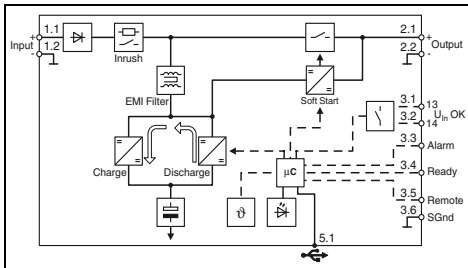

Technical data

22.5 V DC ... 30 V DC
0.1 A / 1 A / 13.5 A
< 22 V DC, -

24 V DC
10 A / 12.5 A / - / -
No / No
5 min. (1 A) / 1 min. (5 A) / 30 s (10 A)
< 6 W

U_N OK, Alarm, Ready
Alarm, Ready
U_NOK

Double-layer capacitor
1.6 kg / 118 x 130 x 125 mm
horizontal DIN rail NS 35, EN 60715
alignable: horizontally 0 mm, vertically 50 mm
Screw connection
0.2 - 2.5 mm² / 0.2 - 2.5 mm² / 30 - 12
0.2 - 2.5 mm² / 0.2 - 2.5 mm² / 30 - 12
0.2 - 1.5 mm² / 0.2 - 1.5 mm² / 24 - 16
IP20 / -

1387186 h (40°C)
-25°C ... 60°C (> 40°C Derating: 1%/K)

500 V
Conformance with EMC Directive 2014/30/EU
IEC 60950-1/VDE 0805 (SELV)
UL Listed UL 508, UL/C-UL Recognized UL 60950-1

Ordering data

Type	Order No.	Pcs./Pkt.
QUINT4-CAP/24DC/10/8KJ	2320571	1

Power supply units and UPS

Uninterruptible power supplies

UPS module with integrated energy storage

STEP UPS

The STEP BAT energy storage device is included when ordering the STEP UPS. It can be re-ordered separately. (See accessories on this page)

Notes:
 With the STEP-UPS/12DC/12DC/4/46WH, buffer times are double those of the STEP-UPS/24DC/24DC/3/46WH. See page 342.
 The buffer time associated with your solution is dependent on the load current. Exact details for each uninterruptible power supply can be found on page 342.



Uninterruptible power supply with integrated battery module, 24 V DC/24 V DC, 4 A, 46WH



Uninterruptible power supply with integrated battery module, 12 V DC/12 V DC, 4 A, 46WH

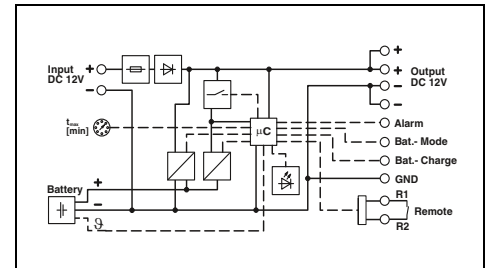
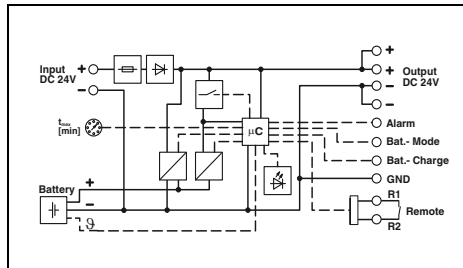

Technical data	
Input data	
Nominal input voltage range	24 V DC
Input voltage range	22.5 V DC ... 29.5 V DC
Max. current consumption	4.7 A
Current consumption charging process	0.5 A
Input fuse	7 A (slow-blow, internal)
Output data	
Nominal output voltage	24 V DC
Output current standard operation	3 A
Output current Power Boost	4 A (0°C ... 35°C)
Can be connected in parallel/series	No / No
Buffer period	90 min. (1 A) / 45 min. (2 A) / 30 min. (3 A)
Max. power dissipation (normal mode / buffer mode)	2 W / 3.8 W
Efficiency	> 98% (Mains operation, with charged energy storage) / > 95% (Battery operation)
Signaling	
Signaling Power OK	LED
Signaling alarm	LED, active transistor switching output
Signaling battery charge	LED, active transistor switching output
Signaling battery mode	LED, active transistor switching output
General data	
Storage medium	Lithium-ion
Weight / Dimensions W x H x D	0.51 kg / 108 x 90 x 71 mm
Mounting position	horizontal DIN rail NS 35, EN 60715
Connection	alignable: horizontally 0 mm, vertically 50 mm
Connection method	Screw connection
Input connection data rigid / flexible / AWG	0.2 - 2.5 mm ² / 0.2 - 2.5 mm ² / 24 - 12
Output connection data rigid / flexible / AWG	0.2 - 2.5 mm ² / 0.2 - 2.5 mm ² / 24 - 12
Signal connection data rigid / flexible / AWG	0.2 - 2.5 mm ² / 0.2 - 2.5 mm ² / 24 - 12
Degree of protection / Protection class	IP20 / III
MTBF (IEC 61709, SN 29500)	> 1401000 h (40°C)
Ambient temperature (operation)	0°C ... 40°C
Standards/regulations	
Electromagnetic compatibility	Conformance with EMC Directive 2014/30/EU
Electrical safety, safety transformer	EN 60950-1/VDE 0805 (SELV)
Electronic equipm. for electrical power installations	EN 50178/VDE 0160 (PELV)
UL approvals	UL Listed UL 508, UL/C-UL Recognized UL 60950-1

Technical data	
Input data	
Nominal input voltage range	12 V DC
Input voltage range	10 V DC ... 16.5 V DC
Max. current consumption	6 A
Current consumption charging process	0.8 A
Input fuse	7 A (slow-blow, internal)
Output data	
Nominal output voltage	12 V DC
Output current standard operation	4 A
Output current Power Boost	5 A (0°C ... 35°C)
Can be connected in parallel/series	No / No
Buffer period	180 min. (1 A) / 90 min. (2 A) / 60 min. (3 A)
Max. power dissipation (normal mode / buffer mode)	1.2 W / 4.4 W
Efficiency	> 97.4% (Mains operation, with charged energy storage) / > 92% (Battery operation)
Signaling	
Signaling Power OK	LED
Signaling alarm	LED, active transistor switching output
Signaling battery charge	LED, active transistor switching output
Signaling battery mode	LED, active transistor switching output
General data	
Storage medium	Lithium-ion
Weight / Dimensions W x H x D	0.52 kg / 108 x 90 x 71 mm
Mounting position	horizontal DIN rail NS 35, EN 60715
Connection	alignable: horizontally 0 mm, vertically 50 mm
Connection method	Screw connection
Input connection data rigid / flexible / AWG	0.2 - 2.5 mm ² / 0.2 - 2.5 mm ² / 24 - 12
Output connection data rigid / flexible / AWG	0.2 - 2.5 mm ² / 0.2 - 2.5 mm ² / 24 - 12
Signal connection data rigid / flexible / AWG	0.2 - 2.5 mm ² / 0.2 - 2.5 mm ² / 24 - 12
Degree of protection / Protection class	IP20 / III
MTBF (IEC 61709, SN 29500)	> 1997000 h (40°C)
Ambient temperature (operation)	0°C ... 40°C
Standards/regulations	
Electromagnetic compatibility	Conformance with EMC Directive 2014/30/EU
Electrical safety, safety transformer	EN 60950-1/VDE 0805 (SELV)
Electronic equipm. for electrical power installations	EN 50178/VDE 0160 (PELV)
UL approvals	UL Listed UL 508, UL/C-UL Recognized UL 60950-1

Ordering data	
Description	
Power supply, uninterruptible	

Ordering data		
Type	Order No.	Pcs./Pkt.
STEP-UPS/24DC/24DC/3/46WH	1081430	1

Accessories	
Energy storage	

Accessories		
Type	Order No.	Pcs./Pkt.
STEP-BAT/LI-ION/18.5DC/46WH	1081355	1

Ordering data		
Type	Order No.	Pcs./Pkt.
STEP-UPS/12DC/12DC/4/46WH	1082548	1

Accessories		
Type	Order No.	Pcs./Pkt.
STEP-BAT/LIPO/18.5DC/1.4AH	2320364	1

UPS module with integrated energy storage

UNO UPS

The energy storage is included when ordering the UNO UPS.



Uninterruptible power supply with integrated rechargeable battery, 24 V DC/24 V DC, 60 W

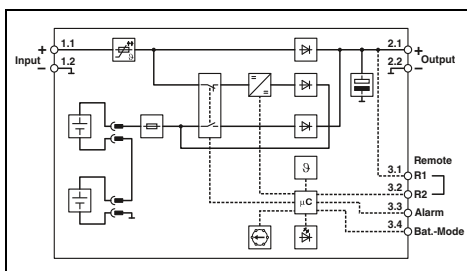

Technical data

Input data	
Nominal input voltage range	24 V DC
Input voltage range	22.5 V DC ... 29.5 V DC
Max. current consumption	2.8 A
Current consumption charging process	0.3 A
Input fuse	5 A (electronic)
Output data	
Nominal output voltage	24 V DC (SELV)
Output current standard operation	2.5 A
Output current Power Boost	-
Can be connected in parallel/series	yes, with redundancy module / No
Buffer period	45 min. (0.5 A) / 20 min. (1 A) / 8 min. (2 A)
Max. power dissipation (normal mode / buffer mode)	3 W / -
Efficiency	> 95% (Mains operation, with charged energy storage) / > 92% (Battery operation)
Signaling	
Signaling Power OK	LED
Signaling alarm	LED, active transistor switching output
Signaling battery charge	-
Signaling battery mode	LED, active transistor switching output
General data	
Storage medium	Lead rechargeable battery module
Weight / Dimensions W x H x D	1 kg / 110 x 90 x 84 mm
Mounting position	horizontal DIN rail NS 35, EN 60715
Connection	alignable: 0 mm horizontally, 30 mm vertically
Connection method	Screw connection
Input connection data rigid / flexible / AWG	0.2 - 2.5 mm ² / 0.2 - 2.5 mm ² / 24 - 14
Output connection data rigid / flexible / AWG	0.2 - 2.5 mm ² / 0.2 - 2.5 mm ² / 24 - 14
Signal connection data rigid / flexible / AWG	0.2 - 2.5 mm ² / 0.2 - 2.5 mm ² / 24 - 14
Degree of protection / Protection class	IP20 / III
MTBF (IEC 61709, SN 29500)	> 1900000 h (40°C)
Ambient temperature (operation)	-15°C ... 50°C
Standards/regulations	
Electromagnetic compatibility	Conformance with EMC Directive 2014/30/EU
Electrical safety, safety transformer	EN 60950-1/VDE 0805 (SELV)
Electronic equipm. for electrical power installations	EN 50178/VDE 0160 (PELV)
UL approvals	UL Listed UL 508, UL/C-UL Recognized UL 60950-1

Ordering data

Description	Type	Order No.	Pcs./Pkt.
Power supply, uninterruptible	UNO-UPS/24DC/24DC/60W	2905907	1

Accessories

Fuse	Type	Order No.	Pcs./Pkt.
	FUSE 5A/32V FK-1	2908367	2

Power supply units and UPS

Uninterruptible power supplies

UPS module with integrated power supply

MINI UPS 24 V DC and 12 V DC

The MINI UPS combines the power supply and the UPS module in the same housing in a particularly space-saving way.

Notes:
 With the MINI-DC-UPS/12DC/4, buffer times are double those of the MINI-DC-UPS/24DC/2.
 The buffer time associated with your solution is dependent on the load current. Exact details for each uninterruptible power supply can be found on page 343.



UPS with integrated power supply,
100 - 240 V AC / 24 V DC, 2 A



UPS with integrated power supply,
100 - 240 V AC / 12 V DC, 4 A

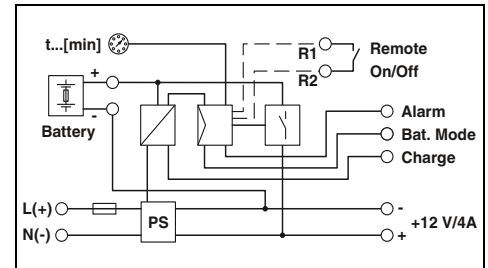
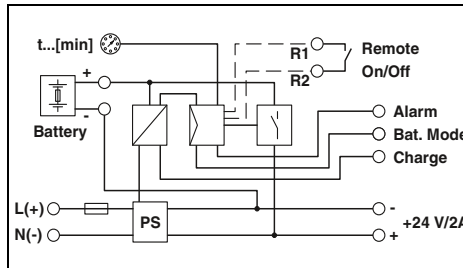

Technical data

Input data	
Nominal input voltage range	100 V AC ... 240 V AC
Input voltage range	85 V AC ... 264 V AC / 100 V DC ... 350 V DC
Max. current consumption in normal mode	0.6 A / 0.85 A (230 V AC), 1.1 A / 1.5 A (120 V AC)
Input fuse	3.15 A (slow-blow, internal)
Reliable backup fuse, circuit breaker	B6, B10, B16
Output data	
Nominal output voltage	24 V DC (available AC input voltage: 22.5 to 29.5 V DC, unavailable AC input voltage: 27.9 to 19.2 V DC)
Output current	2 A
Can be connected in parallel/series	No / yes
Buffer period	20 min. (2 A)
Max. power dissipation (idling / normal mode / buffer mode)	3.8 W / 10.1 W / 2.1 W
Efficiency	> 83%
Signaling	
Signaling Power OK	LED
Signaling alarm	LED, active switching output
Signaling battery charge	LED, active switching output
Signaling battery mode	LED, active switching output
General data	
Storage medium	External, battery 0.8 Ah / 1.3 Ah
Weight / Dimensions W x H x D	0.45 kg / 67.5 x 99 x 107 mm
Mounting position	horizontal DIN rail NS 35, EN 60715
Connection	alignable: horizontally 0 mm, vertically 50 mm
Connection method	COMBICON plug-in screw connections
Input connection data rigid / flexible / AWG	0.2 - 2.5 mm ² / 0.2 - 2.5 mm ² / 24 - 12
Output connection data rigid / flexible / AWG	0.2 - 2.5 mm ² / 0.2 - 2.5 mm ² / 24 - 12
Signal connection data rigid / flexible / AWG	0.2 - 2.5 mm ² / 0.2 - 2.5 mm ² / 24 - 12
Degree of protection / Protection class	IP20 / II
MTBF (IEC 61709, SN 29500)	> 753000 h (40°C)
Ambient temperature (operation)	-25°C ... 70°C (> 60°C Derating: 2.5%/K)
Standards/regulations	
Insulation voltage input/output	2 kV (routine test) / 4 kV (type test)
Electromagnetic compatibility	Conformance with EMC Directive 2014/30/EU
Electrical safety, safety transformer	EN 60950-1/VDE 0805 (SELV)
Electronic equipm. for electrical power installations	EN 50178/VDE 0160 (PELV)
UL approvals	UL Listed UL 508, UL/C-UL Recognized UL 60950-1, UL ANSI/ISA-12.12.01 Class 1, Division 2, Groups A, B, C, D (Hazardous Location)

Ordering data

Description	
Power supply, uninterruptible	

Type	Order No.	Pcs./Pkt.
MINI-DC-UPS/24DC/2	2866640	1

Technical data

Input data	
Nominal input voltage range	100 V AC ... 240 V AC
Input voltage range	85 V AC ... 264 V AC / 100 V DC ... 350 V DC
Max. current consumption in normal mode	0.5 A / 0.65 A (230 V AC), 1.15 A / 1.35 A (120 V AC)
Input fuse	3.15 A (slow-blow, internal)
Reliable backup fuse, circuit breaker	B6, B10, B16
Output data	
Nominal output voltage	12 V DC (available AC input voltage: 10 to 16 V DC, unavailable AC input voltage: 13.6 to 9.6 V DC)
Output current	4 A
Can be connected in parallel/series	No / yes
Buffer period	20 min. (4 A)
Max. power dissipation (idling / normal mode / buffer mode)	1.6 W / 10.5 W / 2.6 W
Efficiency	> 82%
Signaling	
Signaling Power OK	LED
Signaling alarm	LED, active switching output
Signaling battery charge	LED, active switching output
Signaling battery mode	LED, active switching output
General data	
Storage medium	External, rechargeable battery 1.6 Ah / 2.6 Ah
Weight / Dimensions W x H x D	0.45 kg / 67.5 x 99 x 107 mm
Mounting position	horizontal DIN rail NS 35, EN 60715
Connection	alignable: horizontally 0 mm, vertically 50 mm
Connection method	COMBICON plug-in screw connections
Input connection data rigid / flexible / AWG	0.2 - 2.5 mm ² / 0.2 - 2.5 mm ² / 24 - 12
Output connection data rigid / flexible / AWG	0.2 - 2.5 mm ² / 0.2 - 2.5 mm ² / 24 - 12
Signal connection data rigid / flexible / AWG	0.2 - 2.5 mm ² / 0.2 - 2.5 mm ² / 24 - 12
Degree of protection / Protection class	IP20 / II
MTBF (IEC 61709, SN 29500)	> 728000 h (40°C)
Ambient temperature (operation)	-25°C ... 70°C (> 60°C Derating: 2.5%/K)
Standards/regulations	
Insulation voltage input/output	2 kV (routine test) / 4 kV (type test)
Electromagnetic compatibility	Conformance with EMC Directive 2014/30/EU
Electrical safety, safety transformer	EN 60950-1/VDE 0805 (SELV)
Electronic equipm. for electrical power installations	EN 50178/VDE 0160 (PELV)
UL approvals	UL Listed UL 508, UL/C-UL Recognized UL 60950-1, UL ANSI/ISA-12.12.01 Class 1, Division 2, Groups A, B, C, D (Hazardous Location)

Ordering data

Type	Order No.	Pcs./Pkt.
MINI-DC-UPS/12DC/4	2866598	1

Power supply units and UPS

Uninterruptible power supplies

Energy storage for MINI UPS

MINI-BAT

- MINI-BAT for maximum buffer times
- Lead AGM (Absorbent Glass Mat) technology
- Ambient temperatures from 0°C to +40°C

Notes:

The buffer time associated with your solution is dependent on the load current. Exact details for each uninterruptible power supply can be found on page 343.



Energy storage, 24 V DC, 0.8 Ah for MINI UPS 2 A

ERC

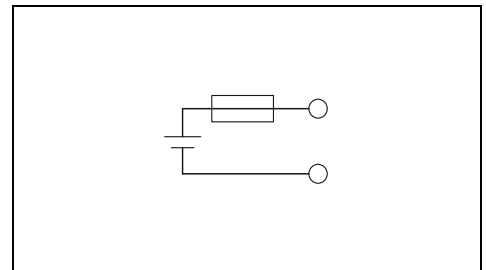

Input data/output data	
Nominal capacity	0.8 Ah
Nominal output voltage	24 V DC
Output current	5 A
Can be connected in parallel/series	Yes / No
General data	
Weight / Dimensions W x H x D	0.9 kg / 67.5 x 99 x 107 mm
Degree of protection / Protection class	IP20 / III
Ambient temperature (operation)	0°C ... 40°C
Service life	4 years (20°C)
Latest startup	6 months (20°C ... 30°C) 3 months (30°C ... 40°C)

Technical data		
Nominal capacity	0.8 Ah	
Nominal output voltage	24 V DC	
Output current	5 A	
Can be connected in parallel/series	Yes / No	
Weight / Dimensions W x H x D	0.9 kg / 67.5 x 99 x 107 mm	
Degree of protection / Protection class	IP20 / III	
Ambient temperature (operation)	0°C ... 40°C	
Service life	4 years (20°C)	
Latest startup	6 months (20°C ... 30°C) 3 months (30°C ... 40°C)	

Description	
Energy storage	

Ordering data		
Type	Order No.	Pcs./Pkt.
MINI-BAT/24DC/0.8AH	2866666	1

Fuse	
FUSE 5A/32V FK-1	

Accessories		
Type	Order No.	Pcs./Pkt.
FUSE 5A/32V FK-1	2908367	2



Energy storage, 24 V DC, 1.3 Ah
for TRIO UPS and MINI UPS 2 A

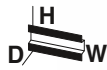

Energy storage, 12 V DC, 1.6 Ah
for MINI UPS 4 A



Energy storage, 12 V DC, 2.6 Ah
for MINI UPS 4 A

ERC

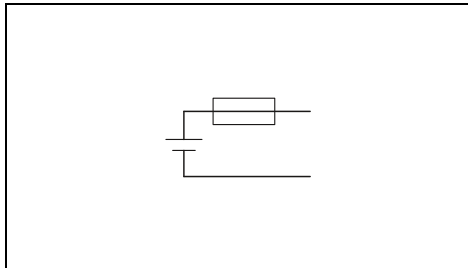

Technical data

1.3 Ah
24 V DC
15 A
Yes / No

1.7 kg / 52 x 130 x 110 mm
IP20 / III
0°C ... 40°C
6 years ... 9 years (20°C)
6 months (20°C ... 30°C)
3 months (30°C ... 40°C)

Ordering data

Type	Order No.	Pcs./Pkt.
MINI-BAT/24DC/1.3AH	2866417	1

Accessories

FUSE 15A/32V FKS ATO	2908361	2
----------------------	---------	---

ERC

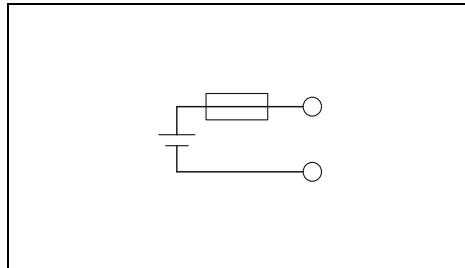

Technical data

1.6 Ah
12 V DC
10 A
Yes / No

0.9 kg / 67.5 x 99 x 107 mm
IP20 / III
0°C ... 40°C
4 years (20°C)
6 months (20°C ... 30°C)
3 months (30°C ... 40°C)

Ordering data

Type	Order No.	Pcs./Pkt.
MINI-BAT/12DC/1.6AH	2866572	1

Accessories

FUSE 10A/32V FK1	2908364	2
------------------	---------	---

ERC

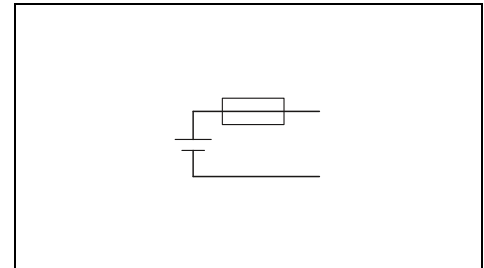

Technical data

2.6 Ah
12 V DC
15 A
Yes / No

1.7 kg / 52 x 130 x 110 mm
IP20 / III
0°C ... 40°C
6 years ... 9 years (20°C)
6 months (20°C ... 30°C)
3 months (30°C ... 40°C)

Ordering data

Type	Order No.	Pcs./Pkt.
MINI-BAT/12DC/2.6AH	2866569	1

Accessories

FUSE 25A/32V FKS	2908363	2
------------------	---------	---

Power supply units and UPS

Uninterruptible power supplies

UPS module with integrated power supply

TRIO DC UPS, 1 AC, 24 V DC

- For the reliable supply of DC loads.
- Space-saving combination of UPS and power supply in the same housing
- Long buffer times, thanks to a large number of VRLA energy storage devices
- USB interface for connection to higher-level controllers, such as industrial PCs
- Startup from energy storage possible, even without mains input
- Push-in connection



UPS with integrated power supply,
1 V AC / 24 V DC, 5 A



UPS with integrated power supply,
1 V AC / 24 V DC, 10 A

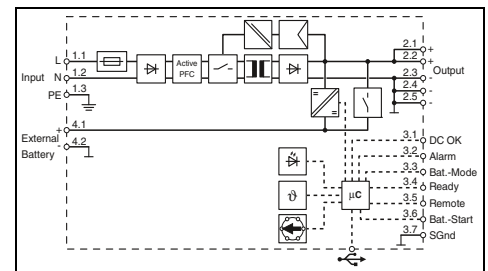
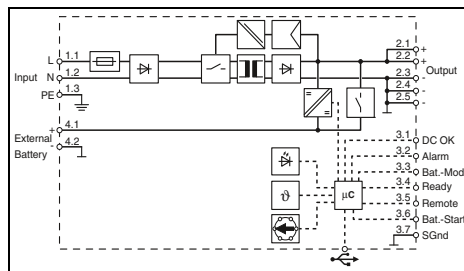

Technical data

Technical data

Input data	
Input voltage range	100 V AC ... 240 V AC 110 V DC ... 250 V DC
Current consumption (nominal load)	1.6 A (240 V AC) / 3.3 A (100 V AC) 0.7 A (250 V DC) / 1.8 A (110 V DC)
Input fuse	6.3 A (slow-blow, internal)
Reliable backup fuse, circuit breaker	B10
Output data	
Nominal output voltage	24 V DC
Setting range of the output voltage (in mains operation)	24 V DC ... 28 V DC (> 24 V constant capacity)
Output current / Dynamic Boost	5 A / 7.5 A
Can be connected in parallel/series	yes, with diode module uncoupled / No
Buffer period	to 2 h
Max. power dissipation (no load/nominal load)	< 3 W (230 V AC) / < 19 W (230 V AC)
Efficiency	typ. 85% (120 V AC) / typ. 87% (230 V AC) / typ. 96% (Battery operation)
Signaling	
LED signaling	DC OK (green), Alarm (red), Bat.-Mode (yellow)
Configurable signal output	DC OK, Alarm, Bat.-Mode, Ready
Interfaces	MINI-USB type B
General data	
Battery technology	VRLA
Charging current	0.2 A ... 1.5 A (-25°C ... 60°C)
Weight / Dimensions W x H x D	0.75 kg / 60 x 130 x 115 mm
Mounting position	horizontal DIN rail NS 35, EN 60715
Connection	alignable: horizontally 0 mm, vertically 50 mm
Connection method	Push-in connection
Input connection data rigid / flexible / AWG	0.2 - 4 mm ² / 0.2 - 2.5 mm ² / 24 - 12
Output connection data rigid / flexible / AWG	0.2 - 4 mm ² / 0.2 - 2.5 mm ² / 24 - 12
Signal connection data rigid / flexible / AWG	0.2 - 1.5 mm ² / 0.2 - 1.5 mm ² / 24 - 16
Degree of protection / Protection class	IP20 / I
MTBF (IEC 61709, SN 29500)	> 825726 h (230 V AC, at 40°C)
Ambient temperature (operation)	-25°C ... 70°C (> 60°C Derating: 2.5%/K)
Standards/regulations	
Insulation voltage input/output	1.5 kV AC (routine test) / 3 kV AC (type test)
Electromagnetic compatibility	Conformance with EMC Directive 2014/30/EU
UL approvals	UL Listed UL 61010, UL/C-UL Listed ANSI/ISA-12.12.01 Class I, Division 2, Groups A, B, C

Input data	
Input voltage range	100 V AC ... 240 V AC 110 V DC ... 250 V DC
Current consumption (nominal load)	2 A (240 V AC) / 4.5 A (100 V AC) 1.8 A (250 V DC) / 4 A (110 V DC)
Input fuse	6.3 A (slow-blow, internal)
Reliable backup fuse, circuit breaker	B10
Output data	
Nominal output voltage	24 V DC
Setting range of the output voltage (in mains operation)	24 V DC ... 28 V DC (> 24 V constant capacity)
Output current / Dynamic Boost	10 A / 15 A
Can be connected in parallel/series	yes, with diode module uncoupled / No
Buffer period	to 3 h
Max. power dissipation (no load/nominal load)	< 3 W (230 V AC) / < 32 W (230 V AC)
Efficiency	typ. 90% (120 V AC) / typ. 91% (230 V AC) / typ. 96% (Battery operation)
Signaling	
LED signaling	DC OK (green), Alarm (red), Bat.-Mode (yellow)
Configurable signal output	DC OK, Alarm, Bat.-Mode, Ready
Interfaces	MINI-USB type B
General data	
Battery technology	VRLA
Charging current	0.2 A ... 3 A (-25°C ... 60°C)
Weight / Dimensions W x H x D	1.34 kg / 68 x 130 x 160 mm
Mounting position	horizontal DIN rail NS 35, EN 60715
Connection	alignable: horizontally 0 mm, vertically 50 mm
Connection method	Push-in connection
Input connection data rigid / flexible / AWG	0.2 - 4 mm ² / 0.2 - 2.5 mm ² / 24 - 12
Output connection data rigid / flexible / AWG	0.2 - 4 mm ² / 0.2 - 2.5 mm ² / 24 - 12
Signal connection data rigid / flexible / AWG	0.2 - 1.5 mm ² / 0.2 - 1.5 mm ² / 24 - 16
Degree of protection / Protection class	IP20 / I
MTBF (IEC 61709, SN 29500)	> 1210518 h (230 V AC, at 40°C)
Ambient temperature (operation)	-25°C ... 70°C (> 60°C Derating: 2.5%/K)
Standards/regulations	
Insulation voltage input/output	2 kV AC (routine test) / 4 kV AC (type test)
Electromagnetic compatibility	Conformance with EMC Directive 2014/30/EU
UL approvals	UL Listed UL 61010, UL/C-UL Listed ANSI/ISA-12.12.01 Class I, Division 2, Groups A, B, C

Ordering data		
Type	Order No.	Pcs./Pkt.
TRIO-UPS-2G/1AC/24DC/5	2907160	1

Ordering data		
Type	Order No.	Pcs./Pkt.
TRIO-UPS-2G/1AC/24DC/10	2907161	1

Ordering data	
Description	Type
Power supply, uninterruptible	TRIO-UPS-2G/1AC/24DC/5

UPS module with integrated power supply

TRIO DC UPS, 3 AC, 24 V DC

- For the reliable supply of DC loads.
- Space-saving combination of UPS and power supply in the same housing
- Long buffer times, thanks to a large number of VRLA energy storage devices
- USB interface for connection to higher-level controllers, such as industrial PCs
- Startup from energy storage possible, even without mains input
- Push-in connection



**UPS with integrated power supply,
3 V AC / 24 V DC, 20 A**

Ex:

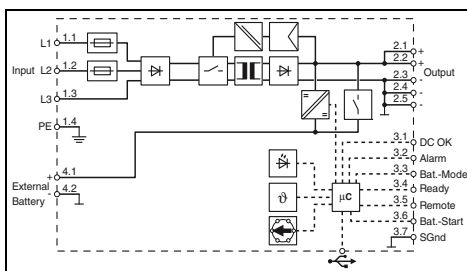

Technical data

Input data	
Input voltage range	3x 400 V AC ... 500 V AC / 2x 400 V AC ... 500 V AC
Current consumption (nominal load)	3x 1.1 A (500 V AC) / 3x 1.3 A (400 V AC) 2x 1.9 A (480 V AC) / 2x 2.2 A (400 V AC)
Input fuse	6.3 A (slow-blow, internal)
Reliable backup fuse, circuit breaker	B10
Output data	
Nominal output voltage	24 V DC
Setting range of the output voltage (in mains operation)	24 V DC ... 28 V DC (> 24 V constant capacity)
Output current / Dynamic Boost	20 A / 30 A
Can be connected in parallel/series	yes, with diode module uncoupled / No
Buffer period	to 1.5 h
Max. power dissipation (no load/nominal load)	< 3.6 W (400 V AC) / < 36 W (400 V AC)
Efficiency	typ. 93% (400 V AC) / typ. 92% (480 V AC) / typ. 94% (Battery operation)
Signaling	
LED signaling	DC OK (green), Alarm (red), Bat.-Mode (yellow)
Configurable signal output	DC OK, Alarm, Bat.-Mode, Ready
Interfaces	MINI-USB type B
General data	
Battery technology	VRLA
Charging current	0.5 A ... 3 A (-25°C ... 60°C)
Weight / Dimensions W x H x D	1.71 kg / 88 x 130 x 160 mm
Mounting position	horizontal DIN rail NS 35, EN 60715
Connection	alignable: horizontally 0 mm, vertically 50 mm
Connection method	Push-in connection
Input connection data rigid / flexible / AWG	0.2 - 4 mm ² / 0.2 - 2.5 mm ² / 24 - 12
Output connection data rigid / flexible / AWG	0.2 - 10 mm ² / 0.2 - 6 mm ² / 24 - 16
Signal connection data rigid / flexible / AWG	0.2 - 1.5 mm ² / 0.2 - 1.5 mm ² / 24 - 16
Degree of protection / Protection class	IP20 / I
MTBF (IEC 61709, SN 29500)	> 680194 h (400 V AC, at 40°C)
Ambient temperature (operation)	-25°C ... 70°C (> 60°C Derating: 2.5%/K)
Standards/regulations	
Insulation voltage input/output	2 kV AC (routine test) / 4 kV AC (type test)
Electromagnetic compatibility	Conformance with EMC Directive 2014/30/EU
UL approvals	UL Listed UL 61010, UL/C-UL Listed ANSI/ISA-12.12.01 Class I, Division 2, Groups A, B, C

Ordering data

Description	Type	Order No.	Pcs./Pkt.
Power supply, uninterruptible	TRIO-UPS-2G/3AC/24DC/20	2906367	1

Power supply units and UPS

Uninterruptible power supplies

Energy storage for TRIO UPS

UPS BAT/VRLA for maximum buffer times

- Lead AGM (Absorbent Glass Mat) technology
- Ambient temperatures from 0°C to +40°C
- Long buffer times for high currents
- Integrated temperature sensor for optimum charging
- Battery can be changed without tools



IQ Technology[®]
Designed by PHOENIX CONTACT



VRLA energy storage,
1.3 Ah



IQ Technology[®]
Designed by PHOENIX CONTACT



VRLA energy storage,
3.4 Ah

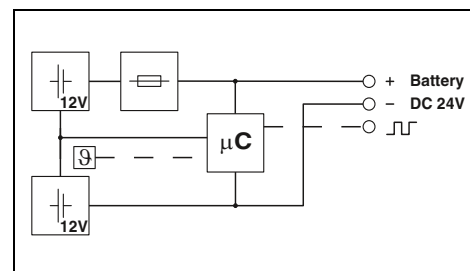
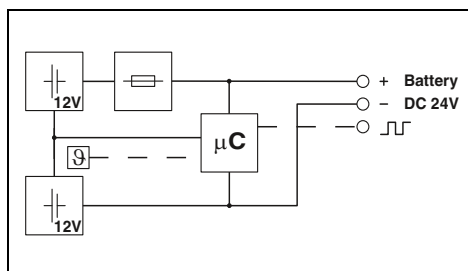

Technical data

Input data/output data
Nominal input voltage
Nominal capacity
Output current
Output fuse
Can be connected in parallel/series
Buffer period
General data
Storage medium
Weight / Dimensions W x H x D
Degree of protection / Protection class
Ambient temperature (operation)
Service life
Standards/regulations
UL approvals

24 V DC
1.3 Ah
15 A
1x 15 A
Yes / No
20 min. (2 A) / 5 min. (5 A)
Lead rechargeable battery module
1.7 kg / 54 x 157 x 113 mm
IP20 / III
0°C ... 40°C
6 years ... 9 years (20°C)
UL/C-UL Listed UL 508, UL/C-UL Recognized UL 60950-1, UL ANSI/ISA-12.12.01 Class I, Division 2, Groups A, B, C, D (Hazardous Location)

Ordering data

Description
Energy storage

Type	Order No.	Pcs./Pkt.
UPS-BAT/VRLA/24DC/1.3AH	2320296	1

Accessories

Fuse
Mounting set
Mounting set

FUSE 15A/32V FK1	2908360	2
------------------	---------	---

Technical data

24 V DC
3.4 Ah
25 A
1x 25 A
Yes / No
4.5 min. (20 A) / 3 min. (25 A)
Lead rechargeable battery module
3.3 kg / 85 x 191 x 110 mm
IP20 / III
0°C ... 40°C
6 years ... 9 years (20°C)
UL/C-UL Listed UL 508, UL/C-UL Recognized UL 60950-1, UL ANSI/ISA-12.12.01 Class I, Division 2, Groups A, B, C, D (Hazardous Location)

Ordering data

Type	Order No.	Pcs./Pkt.
UPS-BAT/VRLA/24DC/3.4AH	2320306	1

Accessories

FUSE 25A/32V ATOF	2908366	2
-------------------	---------	---



IQ Technology
Designed by PHOENIX CONTACT



VRLA energy storage,
7.2 Ah

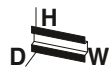

IQ Technology
Designed by PHOENIX CONTACT



VRLA energy storage,
12 Ah



IQ Technology
Designed by PHOENIX CONTACT



VRLA energy storage,
38 Ah

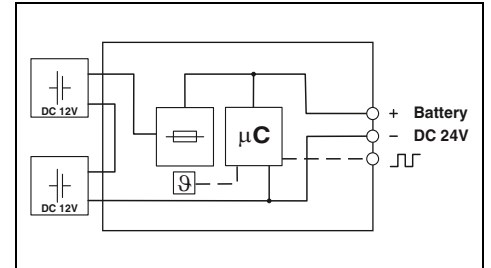
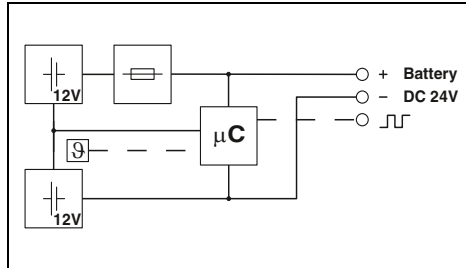
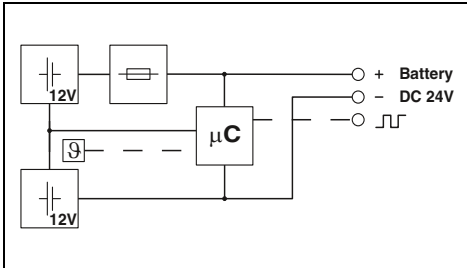

Technical data

24 V DC
7.2 Ah
50 A
2x 25 A
Yes / No
10 min. (20 A) / 3 min. (40 A)

Lead rechargeable battery module
5.9 kg / 135 x 202 x 110 mm
IP20 / III
0°C ... 40°C
6 years ... 9 years (20°C)

UL/C-UL Listed UL 508, UL/C-UL Recognized UL 60950-1,
UL ANSI/ISA-12.12.01 Class I, Division 2, Groups A, B, C, D
(Hazardous Location)

Ordering data

Type	Order No.	Pcs./Pkt.
UPS-BAT/VRLA/24DC/7.2AH	2320319	1

Accessories

FUSE 25A/32V ATOF	2908366	2
-------------------	---------	---

Technical data

24 V DC
12 Ah
50 A
2x 25 A
Yes / No
22.5 min. (20 A) / 9 min. (40 A)

Lead rechargeable battery module
8.9 kg / 202 x 202 x 110 mm
IP20 / III
0°C ... 40°C
6 years ... 9 years (20°C)

UL/C-UL Listed UL 508, UL/C-UL Recognized UL 60950-1,
UL ANSI/ISA-12.12.01 Class I, Division 2, Groups A, B, C, D
(Hazardous Location)

Ordering data

Type	Order No.	Pcs./Pkt.
UPS-BAT/VRLA/24DC/12AH	2320322	1

Accessories

FUSE 25A/32V ATOF	2908366	2
-------------------	---------	---

Technical data

24 V DC
38 Ah
45 A
2x 25 A ATOF 32V
Yes / No
72 min. (20 A) / 35 min. (40 A)

Lead rechargeable battery module
26 kg / 330 x 221 x 197 mm
IP20 / III
0°C ... 40°C
-

UL/C-UL Listed UL 508, UL/C-UL Recognized UL 60950-1,
UL ANSI/ISA-12.12.01 Class I, Division 2, Groups A, B, C, D
(Hazardous Location)

Ordering data

Type	Order No.	Pcs./Pkt.
UPS-BAT/VRLA/24DC/38AH	2320335	1

Accessories

FUSE 25A/32V ATOF	2908366	2
BATTERY MOUNTING KIT	2320788	1
BATTERY MOUNTING CASE	2320458	1



Device circuit breakers

High-quality device circuit breakers provide optimum system protection

Thermomagnetic and electronic device circuit breakers are a key factor in maximizing system availability. In the event of overload and short-circuit currents, they selectively shut down the faulty circuit.

 Your web code: [#0156](#)

Basics	360
<hr/>	
Electronic circuit breakers	362
Multi-channel electronic circuit breakers	364
Single-channel electronic circuit breakers	366
Selection guide	368
Applications	369
CBM electronic circuit breakers	372
CBMC electronic circuit breakers	373
PTCB electronic circuit breakers	378
<hr/>	
Thermomagnetic device circuit breakers	388
Selection guide and applications	390
CB TM pluggable thermomagnetic circuit breakers	390
TMC thermomagnetic circuit breakers	394
<hr/>	
Thermal device circuit breakers	398
Selection guide and applications	399
TCP thermal circuit breakers	400



Why device circuit breakers?

Overload currents and short-circuit currents occur unexpectedly. They cause malfunctions and interrupt the operation of a system. Production downtimes and repair costs can often be an unfortunate consequence.

Minimize damage by protecting individual devices or device groups separately. In this way, end devices are optimally protected against damage or destruction. Unaffected system parts continue operating without interruption, insofar as the overall process allows this.

Overload currents

An overload current occurs if end devices receive a higher current than the intended rated current. Such situations can arise, for example, due to a blocked drive. Temporary starting currents from equipment are also considered to be overload currents. The occurrence of these can be calculated in principle, but nonetheless can vary depending upon the equipment load at startup time.

These conditions must be taken into account when selecting suitable fuses or circuit breakers for such circuits. Safe shutdown should occur in the second to lower minute range.

Short-circuit currents

Short circuits can occur in the event of damage to the insulation between conductors which carry operating voltage. Typical protective devices for disconnecting short-circuit currents include miniature circuit breakers with various tripping mechanisms.

Short-circuit currents are reliably disconnected in the millisecond range.

Selecting the right device circuit breakers

The demands placed on optimum device protection vary depending on where it is deployed and how it is used. Device circuit breakers therefore work with a wide range of technologies:

- Electronic
- Thermomagnetic
- Thermal

The differences lie in the tripping technology and shutdown behavior. Characteristic curves clearly illustrate the shutdown characteristics of the various device circuit breakers.

Device circuit breakers are selected based on the nominal voltage, nominal current, starting current of the end device, and the expected cable length between the circuit breaker and consumer. The expected error situation (short circuit or overload) then determines the appropriate shutdown behavior.

i Your web code: #1253



The right protection for a circuit

The right choice of protective device ensures the safe operation of electrical systems and high system availability.

Miniature circuit breakers protect power distribution cables in buildings or systems. To protect the power supply line against overload, they safely shut down in the event of a short circuit in the end device. The circuit breakers have a high switching capacity of 6 kA upwards.

As the last protection stage for end devices, thermomagnetic and electronic circuit breakers offer the most effective short-circuit and overload protection. If individual consumers or small function groups are protected individually, unaffected system parts can continue operating in the event of an error, insofar as the overall process allows this.

A newly installed circuit is protected appropriately depending on the end device, the cable length, and the conductor cross section. The cables must be designed for the expected operating current, but must also be able to deal with any potential overload and short-circuit currents. To provide the graded protection of system areas, the selectivity between the individual fuses or protective devices must be maintained. This ensures higher system availability as only the faulty circuit is switched off.

Device circuit breakers are easily accessible when installed in the control cabinet. This means they can be switched on again quickly and easily after tripping. So as not to overload the power supply, a control cabinet should not be overpopulated. Sufficient air flow and cooling also reduces the number of false tripping events.

Influence of cable lengths on shutdown behavior

The maximum cable lengths that can be used between a power supply unit and an end device are defined by the following criteria:

- Maximum current of the power supply
- Internal resistance of the circuit breaker
- Cable resistance

The cable resistance is dependent on the cable length and conductor cross section. To reduce the cable resistance, the general principle is to select the shortest cable paths as early as the installation stage.

The length and cross section determine the switch-off conditions for a device circuit breaker.

Cable resistance counteracts a short-circuit current. In the case of low-power voltage sources, a short-circuit current can be limited by the cable resistance to the extent that safety equipment no longer recognizes this current as a short-circuit current. For example, in the case of miniature circuit breakers with C characteristic, the upper tripping limit is significantly higher than the nominal current. Delayed shutdown behavior in the event of a short circuit is highly likely when using this safety equipment.

Optimized protective devices with SFB characteristic or active current limitation detect that the nominal current has been exceeded in good time.



Electronic circuit breakers are used in conjunction with 24 V DC switched-mode power supply units. They are commonly used in machine building, shipbuilding, systems manufacturing, and automation technology. A combination of current analysis and fast tripping in the event of a fault avoids the risk of a switched-mode power supply unit overload. The output voltage remains in place at the switched-mode power supply unit and all other circuits can continue operating. These circuit breakers are ideal for protecting relays, programmable controllers, motors, sensors and actuators, and valves, for example. Combining electronic circuit breakers with a switched-mode power supply increases the availability of systems and machines.

At the heart of an electronic circuit breaker are the semiconductor electronics, which these days are generally supported by intelligent software. The software differentiates between operating currents and harmful currents, and transmits commands to the electronics very quickly. This is because it has to ensure that faults are detected and shut down as quickly as possible while not shutting off an inrush current or normal operating current.

The fault detection process works through the following steps:

- Measurement:
All electrical variables are measured continuously in order to monitor the current situation.
- Analysis:
The measured values are analyzed to determine the appropriate course of action.
- Classification:
The currents are evaluated and classified.
- Protection and switching:
Depending on the class of the analyzed current, the load is started or shut down. The rest of the system remains in operation and unaffected.
- Signaling:
The operating states of all circuits are transmitted continuously to the system operator. If an event occurs, it is detected immediately and reported.
This approach minimizes the duration of a voltage dip. Despite the event, the system voltage remains stable. In the event of an overload current or short circuit, the devices are promptly switched off.

Some electronic circuit breakers feature active current limitation. This function limits the short-circuit and overload currents, depending on the product range, to a value that is 1.25 to 2 times that of the nominal current. This protects the power supply against excessively high currents and prevents a dip in the output voltage at the switched-mode power supply unit.

Another benefit of this electronic technology is the ability to virtually completely plan out the connected load of any DC power supply. In addition, longer cable paths between the power supply and load are possible without negatively impacting the shutdown behavior.



The ideal device protection for every requirement

The product range for electronic circuit breakers offers a complete portfolio of devices. Whether the control cabinet has a modular or block design, the device circuit breakers always provide the right protection. In addition, they can be adjusted flexibly and therefore optimally adapted to the application.



Optimum control of system states

Intelligent software is at the heart of electronic circuit breakers. It continuously monitors the currents that are present and performs the following steps:

- Measurement
- Analysis
- Classification
- Protection
- Signaling



Easy startup

Easy and tool-free direct insertion. Push-in connection technology enables the easy and direct insertion of rigid and flexible conductors without the need for great force. This saves time and costs during installation. Intuitive device operation via single-button control, a potentiometer or the nominal current assistant further simplifies startup.



Information at your fingertips wherever you are

The current status of device circuit breakers is permanently indicated. Stay informed of the system status at all times, anywhere in the world, thanks to the remote control and remote signaling function. As soon as a status changes, this is immediately forwarded to the connected systems. This means that the issue can also be diagnosed remotely. This reduces the number of service call-outs.

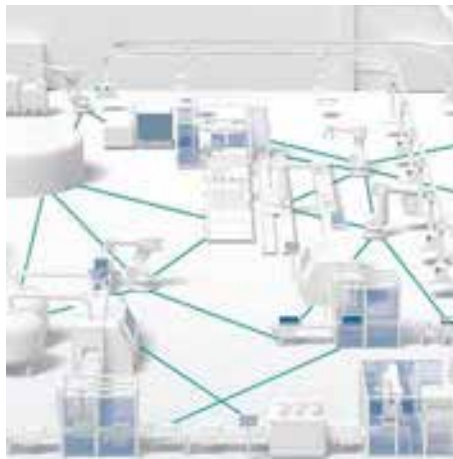

Compatible with Industrie 4.0

Within the scope of Industrie 4.0, production and processes are becoming increasingly networked. Data is exchanged between devices, and is monitored and controlled from mobile cockpits. When it comes to integration into complex networks, data interfaces, such as IO-Link, are playing an increasingly important role – including for device circuit breakers.



Everything from a single source

To achieve high system availability, it is important to consider more than just individual components. From the system input voltage to the load voltage, the components must be coordinated with each other. Phoenix Contact offers the right products that will professionally protect the entire 24 V DC circuit.



Multi-channel electronic circuit breakers

Safely protect against overload and short-circuit currents in a space-saving way. Thanks to multi-channel device circuit breakers, you can protect multiple circuits with just one single device, even in confined spaces. All channels can be individually adjusted and can therefore be adjusted as required to the connected consumers. An integrated electronic interlock secures and protects the parameters you have set from unwanted changes. Push-in connection technology enables quick and tool-free installation of the devices.

All devices constantly check the state of the individual channels. The multi-stage status indicator reliably informs you of the current status of the circuits. An early warning is also generated which indicates utilization over 80%. All devices also feature remote signaling.

Thanks to electronic tripping in the event of a short circuit, the faulty channels are switched off particularly quickly and precisely.

CBMC compact device circuit breaker

With the compact device circuit breakers, you can protect up to four circuits with a single device. The product range offers versions where the nominal current can be adjusted from 1 A to 4 A or 1 A to 10 A. The 1 - 4 A version provides optimum protection for cables and sensors as well as NEC Class 2 circuits by means of an adjusted internal output fuse. Devices with reset input are also available. They enable remote restart. The integrated status output indicates the status of the system.

The product range also includes devices with IO-Link interface. The interface offers comprehensive diagnostic options, so process-related data is always available at a glance. You can therefore see the set nominal current, channel current or even the channel status of the device at all times, anywhere in the world.

Order the CBMC device circuit breakers preconfigured. This means the devices will be tailored precisely to your system. You can decide whether the preprogrammed current values can still be modified or whether they are blocked. Blocked values ensure the safe operation of your system. Specify all the relevant features when ordering, so that you can benefit from easier startup.

CBM highly functional device circuit breaker

The CBM device circuit breakers protect four or eight channels. Both devices protect nominal currents up to 10 A. A nominal current assistant helps you to correctly adjust the channels and makes installation especially easy. The CBM has a reset input, so that disconnected channels can be switched back on again remotely. Furthermore, the device provides the option of indicating utilization over 80% via a signal output.

Thanks to the active current limitation, the current does not exceed a certain threshold value in the event of a short circuit. This reduces the load on the power supply, thereby preventing a voltage drop.



Incremental adjustment

The multi-channel electronic circuit breakers have fine nominal current grading. The CBM can be adjusted in increments from 0.5 A to 10 A, the CBMC from 1 A to 4 A or 10 A, and set individually to the nominal currents of the connected end devices.



Fast connection

Easy and tool-free direct plug-in. Push-in connection technology enables easy and direct insertion of solid and stranded conductors without the need for great force.



Easy to configure

Configuring the CBM could not be easier with the new nominal current assistant. It enables optimal adjustment of the consumer currents.



Analysis and signaling

The currents flowing are constantly monitored. As such, the CBM not only provides the floating signal contact, but also an 80% output. Consequently, you receive a message when at least one channel is heavily overloaded. The disconnected channel can then be easily switched back on remotely via the Reset IN signal input.



Very compact

The CBMC protects four circuits against overload and short-circuit currents on just 36 mm. Thanks to adjustable nominal currents of 1 A to 4 A or 10 A in a single device, storage costs are reduced while simultaneously increasing flexibility for system planning.



Can be ordered preconfigured

Order the CBMC device circuit breaker that is already configured for your system. This means the device can be used immediately, without further configuration effort. The preconfigured devices are also available with fixed, preprogrammed nominal current values.



Easy potential distribution

Single-channel electronic circuit breakers can be individually adapted to the required number of channels. The PTCB circuit breakers offer fixed nominal current values as well as versions that can be adjusted on site from 1 to 8 A. The CB E1 circuit breakers can be pre-wired with a base element and can be fitted with fixed nominal current plugs on site.

Modular extension

It couldn't be easier. A system can be extended with additional device circuit breakers in no time at all. You can bridge the power distribution, remote signaling or even the auxiliary voltage for electronic circuit breakers without this involving significant wiring effort. The uniform housing concept as well as the bridgeability of the base elements simplify installation.

Individual adaptation

Systems and control cabinets can be pre-wired with base elements and individually fitted with corresponding protective plugs on site. Should the demands on a consumer change in the meantime, you can simply replace the relevant protective plug. Various nominal currents are available depending on the application.

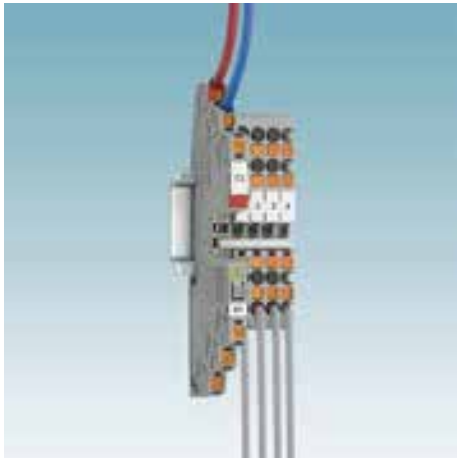

Simple application setup

The PTCB device circuit breaker can be bridged to the CLIPLINE complete terminal block range. With standard terminal blocks and accessories from the CLIPLINE complete system, new materials do not have to be qualified. This enables you to quickly and easily extend existing applications.

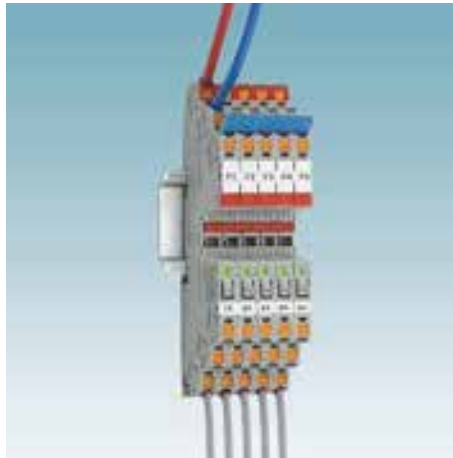

Individual setup

Everything is possible: the device circuit breakers with individual setup offer unlimited possibilities. No matter how many channels need to be protected. Save on unnecessary channels and reduce the costs of your system – with the flexible PTCB device circuit breaker for a wide variety of applications.



Flexible use

With adjustable current values on each device, the PTCB circuit breakers cover a wide range of applications. You can even make modifications during startup. This means you can respond to changes in the application at any time. As a result, warehousing and logistics costs are significantly reduced.

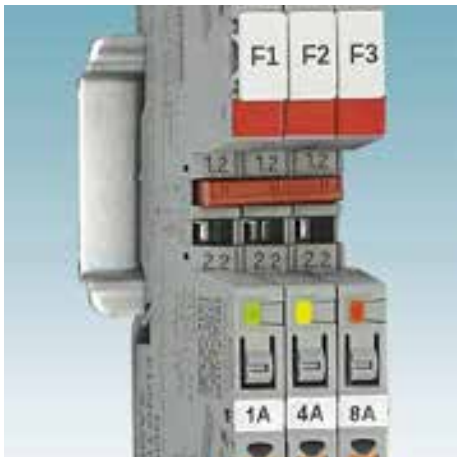

Transparent operating state

The LED indicates the operating state of the product and the connected devices. The state is visualized via traffic light colors. This clear indication allows you to intuitively understand the operating state, which you can see at a glance. Thanks to the remote signaling function, you can forward the status to a remote control room.

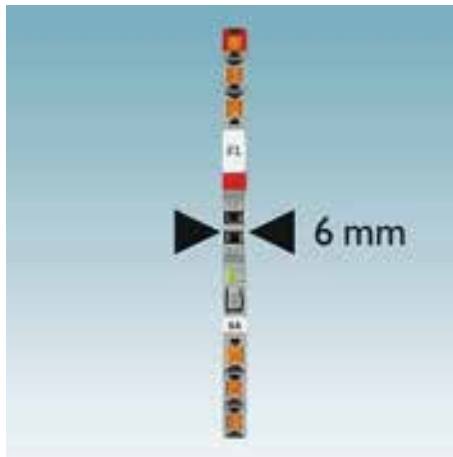

More space in the control cabinet

Space-saving potential distribution can be implemented quickly and easily with the PTCB. It is individually adjustable from 1 to 8 amps, and provides reliable protection against overload and short-circuit currents. You benefit from reliable protection which takes up very little space.

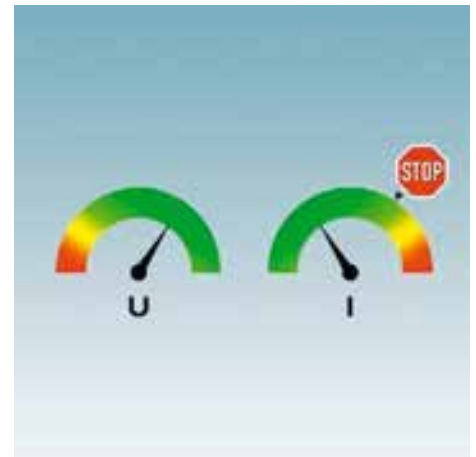

Active current limitation

The active current limitation of electronic circuit breakers restricts short-circuit and overload currents to a value that is 1.25 to 2 times the nominal current. This protects the power supply against excessively high currents and prevents the output voltage dipping at the switched-mode power supply unit. In addition, longer cable paths between the power supply and consumer are possible without negatively impacting the shutdown behavior.

Device circuit breakers

Electronic circuit breakers

Selection guide

Multi-channel electronic circuit breakers

CBM



24 V DC
0.5 A ... 10 A
4 channels
Adjustable

Page 372



24 V DC
0.5 A ... 10 A
8 channels
Adjustable

Page 372



24 V DC
1 A ... 4 A
4 channels
Can be ordered preconfigured

Page 373



24 V DC
1 A ... 10 A
4 channels
Can be ordered preconfigured

Page 373



24 V DC
1 A ... 4 A
4 channels
Adjustable

Page 374



24 V DC
1 A ... 10 A
4 channels
Adjustable

Page 375

CBMC

With status & reset



24 V DC
1 A ... 4 A
4 channels
Adjustable

Page 374



24 V DC
1 A ... 10 A
4 channels
Adjustable

Page 375



24 V DC
1 A ... 8 A
4 channels
Adjustable

Page 375

With electrical isolation



24 V DC
1 A ... 4 A
4 channels
Adjustable

Page 376



24 V DC
1 A ... 10 A
4 channels
Adjustable

Page 377

IO-Link

Single-channel electronic circuit breakers

PTCB



24 V DC
1 A
1 channel
Fixed nominal current

Page 378



24 V DC
2 A
1 channel
Fixed nominal current

Page 378



24 V DC
3 A
1 channel
Fixed nominal current

Page 379



24 V DC
4 A
1 channel
Fixed nominal current

Page 379



24 V DC
6 A
1 channel
Fixed nominal current

Page 379



24 V DC
8 A
1 channel
Fixed nominal current

Page 379

PTCB

CB E1

ECP-E

EC-E



24 V DC
1 A ... 3 A
1 channel
Adjustable

Page 380



24 V DC
1 A ... 4 A
1 channel
Adjustable

Page 381



24 V DC
1 A ... 8 A
1 channel
Adjustable

Page 381



24 V DC
1 A ... 10 A
1 channel
Fixed nominal current

Page 382



24 V DC
1 A ... 12 A
1 channel
Fixed nominal current

Page 384



24 V DC
0.5 A ... 12 A
1 channel
Fixed nominal current

Page 386

Applications

CBM

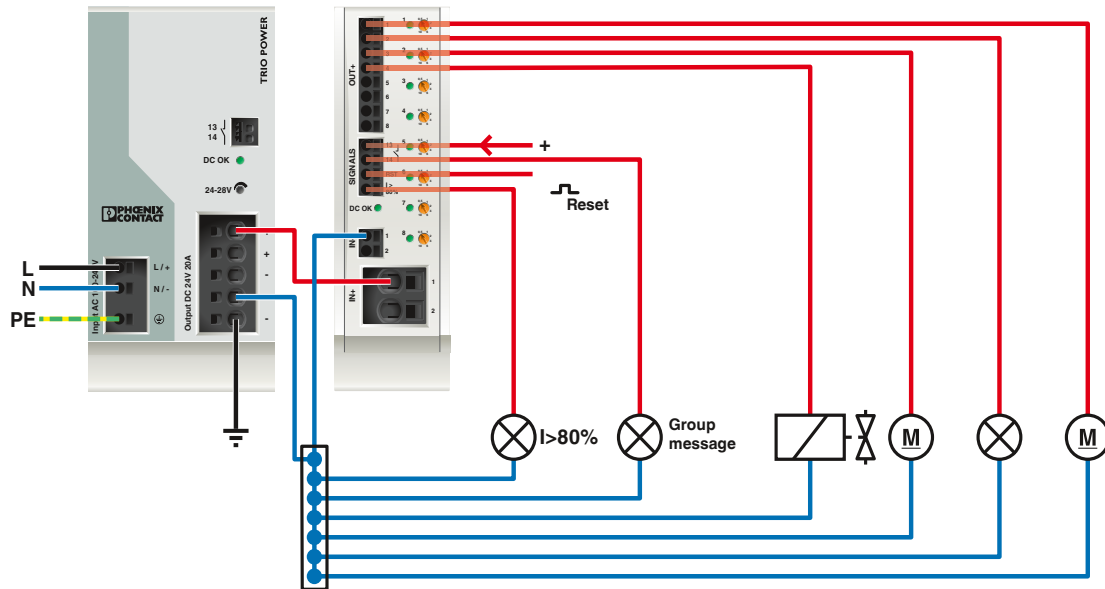

CBM

Page 372

CBMC

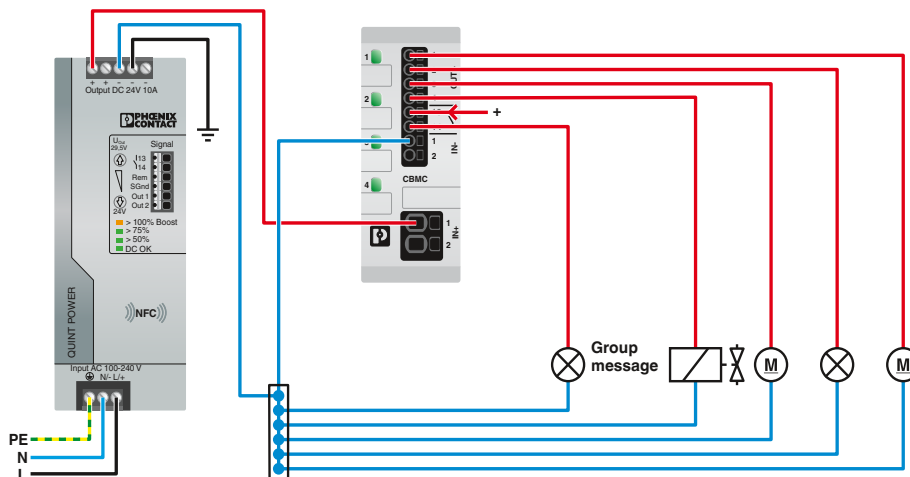

CBMC

Page 373

Device circuit breakers

Electronic circuit breakers

Applications

CBMC with IO-Link interface

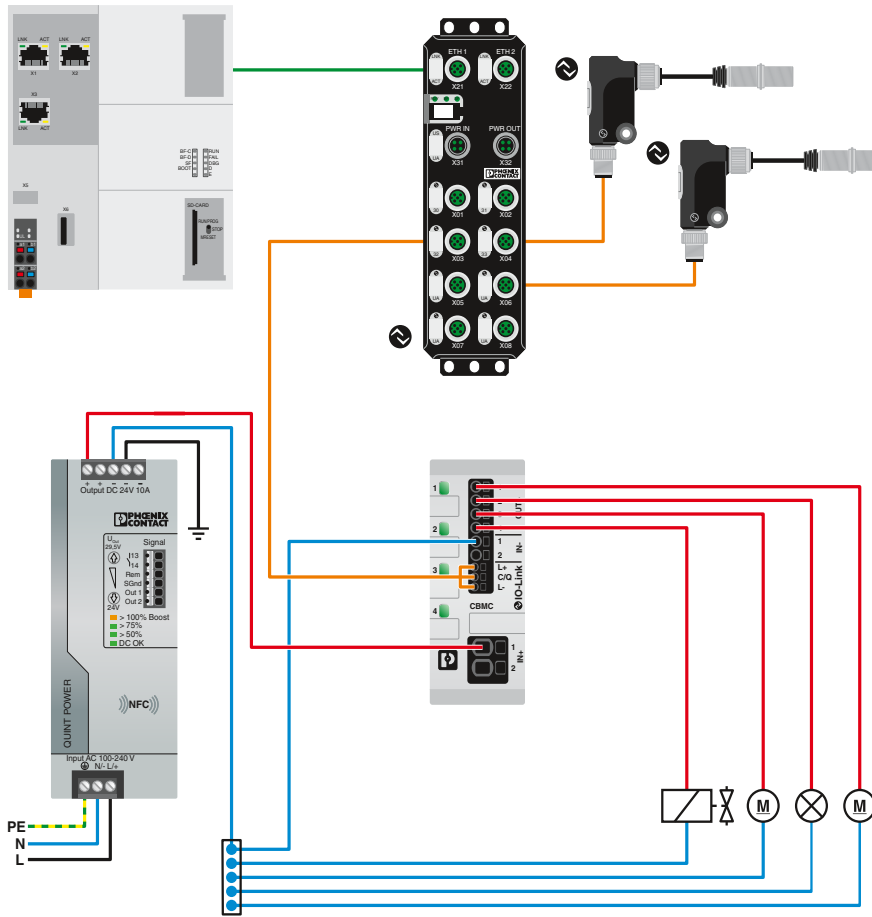

CBMC ... IOL

Page 376

PTCB

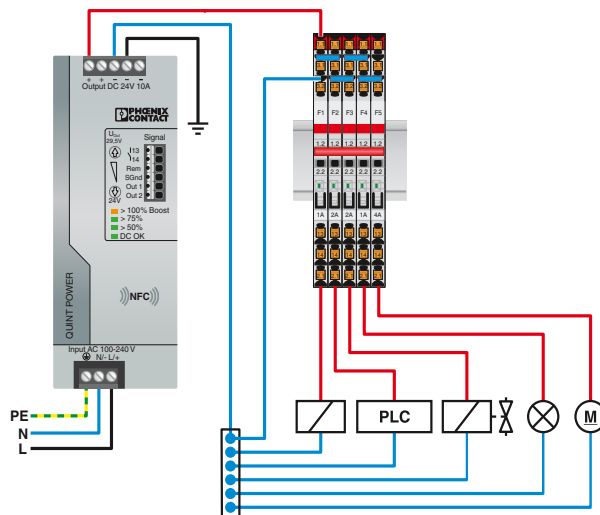

PTCB

Page 378

Applications

CBMC with CLIPLINE terminal blocks

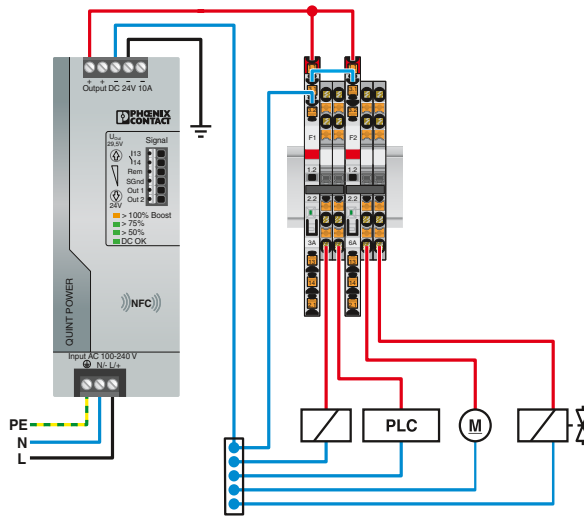

PTCB

Page 376

CB E1

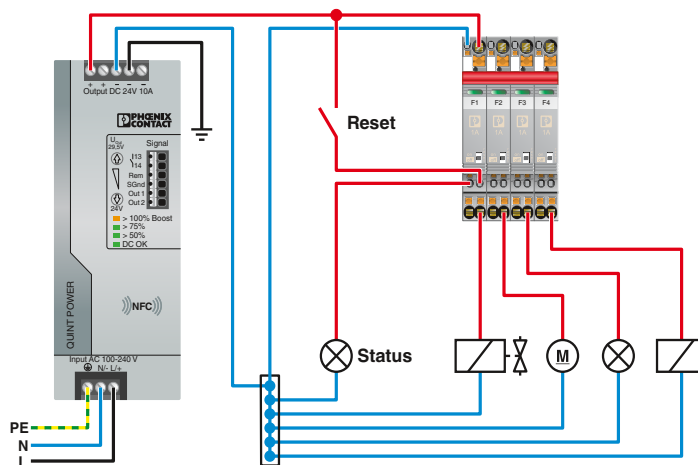

CB E1...

Page 382

Device circuit breakers

Electronic circuit breakers

CBM electronic circuit breakers

- For protection against voltage dips caused by overload and short circuit
- Adjustable from 0.5 - 10 A
- Integrated dynamic current limitation
- Supply of up to 80 A possible
- Slim design

Notes:
For additional technical data, drawings, and accessories, please visit phoenixcontact.net/products.



DIN-rail-mountable,
4-channel



DIN-rail-mountable,
8-channel



Electrical data	
Rated voltage	24 V DC
Rated current I_N	max. 40 A DC
Rated current I_N	0.5 / 1 / 2 / 4 / 6 / 10 A DC (adjustable per output channel)
Switch-on delay	0.1 s (per output channel)
Max. capacitive load	75000 μ F (per channel at 24 V DC)
Internal output fuse	15 A DC (per output channel)
Active current limitation	typ. $2.0 \times I_N$ (0.5 - 1 A) / typ. $1.5 \times I_N$ (2 - 10 A)
Load circuit	
Shutdown time	0.02 s ($> 1.3 \times I_N$) / 30 s ($1.1 \dots 1.3 \times I_N$)
Reset input	
Input voltage range	7 V DC ... 30 V DC (Reset with falling edge)
General data	
Dimensions W/H/D	41 mm / 130 mm / 121 mm
Ambient temperature (operation)	-25°C ... 70°C (Startup at -40°C type-tested)
Standards/regulations	EN 61000-6-2/EN 61000-6-3/EN 60068-2-6/EN 60068-2-11/ EN 60068-2-78/
Remote indication contact	
DC operating voltage	0 V DC ... 30 V DC
DC operating current	1 mA DC ... 100 mA DC

Technical data	
Rated voltage	24 V DC
Rated current I_N	max. 40 A DC
Rated current I_N	0.5 / 1 / 2 / 4 / 6 / 10 A DC (adjustable per output channel)
Switch-on delay	0.1 s (per output channel)
Max. capacitive load	75000 μ F (per channel at 24 V DC)
Internal output fuse	15 A DC (per output channel)
Active current limitation	typ. $2.0 \times I_N$ (0.5 - 1 A) / typ. $1.5 \times I_N$ (2 - 10 A)
Shutdown time	0.02 s ($> 1.3 \times I_N$) / 30 s ($1.1 \dots 1.3 \times I_N$)
Input voltage range	7 V DC ... 30 V DC (Reset with falling edge)
Dimensions W/H/D	41 mm / 130 mm / 121 mm
Ambient temperature (operation)	-25°C ... 70°C (Startup at -40°C type-tested)
Standards/regulations	EN 61000-6-2/EN 61000-6-3/EN 60068-2-6/EN 60068-2-11/ EN 60068-2-78/
DC operating voltage	0 V DC ... 30 V DC
DC operating current	1 mA DC ... 100 mA DC

Technical data	
Rated voltage	24 V DC
Rated current I_N	max. 80 A DC (for double supply IN+ with at least $2 \times 6 \text{ mm}^2$)
Rated current I_N	0.5 / 1 / 2 / 4 / 6 / 10 A DC (adjustable per output channel)
Switch-on delay	0.1 s (per output channel)
Max. capacitive load	75000 μ F (per channel at 24 V DC)
Internal output fuse	15 A DC (per output channel)
Active current limitation	typ. $2.0 \times I_N$ (0.5 - 1 A) / typ. $1.5 \times I_N$ (2 - 10 A)
Shutdown time	0.02 s ($> 1.3 \times I_N$) / 30 s ($1.1 \dots 1.3 \times I_N$)
Input voltage range	7 V DC ... 30 V DC (Reset with falling edge)
Dimensions W/H/D	41 mm / 130 mm / 121 mm
Ambient temperature (operation)	-25°C ... 70°C (Startup at -40°C type-tested)
Standards/regulations	EN 61000-6-2/EN 61000-6-3/EN 60068-2-6/EN 60068-2-11/ EN 60068-2-78/
DC operating voltage	0 V DC ... 30 V DC
DC operating current	1 mA DC ... 100 mA DC

Ordering data	
Description	
Circuit breaker	
4-channel	
8-channel	

Type	Order No.	Pcs./Pkt.
CBM E4 24DC/0.5-10A NO-R	2905743	1

Type	Order No.	Pcs./Pkt.
CBM E8 24DC/0.5-10A NO-R	2905744	1

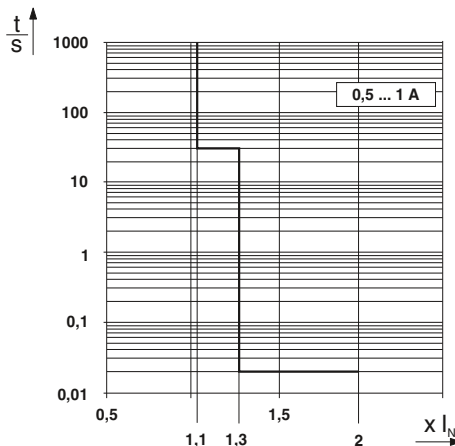

Tripping characteristic in the DC range

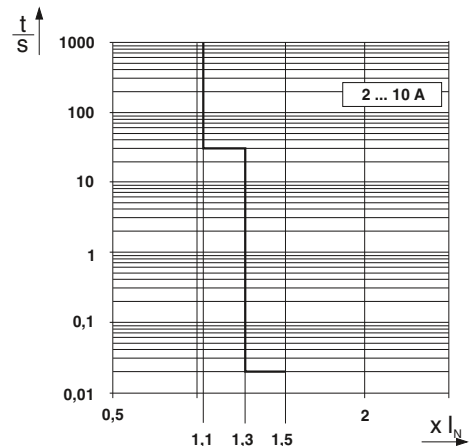

Tripping characteristic in the DC range

CBMC electronic circuit breakers

- For protection against voltage dips caused by overload and short circuit
- Adjustable in 1 A increments up to max. 10 A
- Compact design
- Can be ordered pre-assembled, with fixed or adjustable nominal currents

NEC Class 2
acc. to UL 1310



**DIN-rail-mountable,
4-channel, preconfigurable**



**DIN-rail-mountable,
4-channel, preconfigurable**



Technical data	
Electrical data	
Rated voltage	24 V DC
Rated current I_N	max. 16 A DC (IN+)
Rated current I_N	1 / 2 / 3 / 4 A DC (adjustable or fixed per output channel)
Switch-on delay	0.1 s (per output channel)
Max. capacitive load	30000 μ F (depending on the current setting and the short-circuit current available)
Internal output fuse	4 A DC (per output channel)
Active current limitation	-
Load circuit	
Shutdown time	≤ 10 ms (for short circuit $> 2.0 \times I_N$) / 1 s (1.2 ... 2.0 $\times I_N$)
General data	
Dimensions W/H/D	36 mm / 90 mm / 98 mm
Ambient temperature (operation)	-25°C ... 60°C
Standards/regulations	EN 61000-6-2/EN 61000-6-3/EN 60068-2-6/EN 60068-2-27/ EN 60068-2-78/EN 50178/UL 508/UL 2367/ UL 1310
Remote indication contact	
DC operating voltage	0 V DC ... 30 V DC
DC operating current	100 mA DC

Technical data	
Electrical data	
Rated voltage	24 V DC
Rated current I_N	max. 40 A DC (IN+)
Rated current I_N	1 / 2 / 3 / 4 / 5 / 6 / 7 / 8 / 9 / 10 A DC (adjustable or fixed per output channel)
Switch-on delay	0.1 s (per output channel)
Max. capacitive load	45000 μ F (depending on the current setting and the short-circuit current available)
Internal output fuse	15 A DC (per output channel)
Active current limitation	-
Load circuit	
Shutdown time	≤ 10 ms (for short circuit $> 2.0 \times I_N$) / 1 s (1.2 ... 2.0 $\times I_N$)
General data	
Dimensions W/H/D	36 mm / 90 mm / 98 mm
Ambient temperature (operation)	-25°C ... 60°C
Standards/regulations	EN 61000-6-2/EN 61000-6-3/EN 60068-2-6/EN 60068-2-27/ EN 60068-2-78/EN 50178/UL 2367/UL 508
Remote indication contact	
DC operating voltage	0 V DC ... 30 V DC
DC operating current	100 mA DC

Ordering data			
Type	Order No.	Pcs./Pkt.	
CBMC E4 24DC/1-4A NO-C	2908713	1	

Ordering data			
Type	Order No.	Pcs./Pkt.	
CBMC E4 24DC/1-10A NO-C	2908716	1	

**Order key for the device circuit breaker:
CBMC E4 24DC/1-4A NO-C**

Order No.	Adjustability	Channel 1	Channel 2	Channel 3	Channel 4
2908713	ADJ	1	3	1	4
	ADJ – adjustable	Select the current value in amperes individually for each channel			
	FIX – not adjustable	1 ... 4			

**Order key for the device circuit breaker:
CBMC E4 24DC/1-10A NO-C**

Order No.	Adjustability	Channel 1	Channel 2	Channel 3	Channel 4
2908716	ADJ	1	5	8	10
	ADJ – adjustable	Select the current value in amperes individually for each channel			
	FIX – not adjustable	1 ... 10			

Device circuit breakers

Electronic circuit breakers

CBMC electronic circuit breakers

- For protection against voltage dips caused by overload and short circuit
- Adjustable in 1 A increments up to max. 10 A
- Compact design
- Various versions with electrical isolation or status output and reset input

Notes:
For additional technical data, drawings, and accessories, please visit phoenixcontact.net/products.

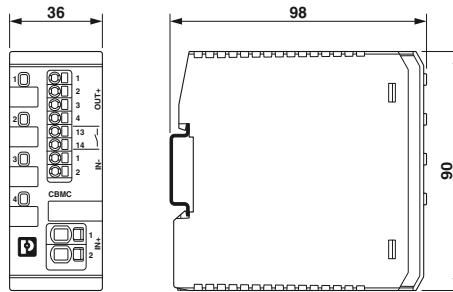

NEC Class 2
acc. to UL 1310



**DIN-rail-mountable,
4-channel, max. 4 A/channel**



Technical data

Electrical data

Rated voltage
Rated current I_N
Rated current I_N

Switch-on delay
Max. capacitive load

Internal output fuse
Active current limitation

Load circuit

Shutdown time

General data

Dimensions W/H/D
Ambient temperature (operation)
Standards/regulations

Remote indication contact

DC operating voltage
DC operating current

24 V DC
max. 16 A DC (I_{N+})
1 / 2 / 3 / 4 A DC (adjustable per output channel)
0.1 s (per output channel)
30000 μ F (depending on the current setting and the short-circuit current available)
4 A DC (per output channel)
-

≤ 10 ms (for short circuit $> 2.0 \times I_N$) /
1 s ($1.2 \dots 2.0 \times I_N$)

36 mm / 90 mm / 98 mm
-25°C ... 60°C
EN 61000-6-2/EN 61000-6-3/EN 60068-2-6/EN 60068-2-27/
EN 60068-2-78/EN 50178/UL 508/UL 2367/
UL 1310

0 V DC ... 30 V DC
100 mA DC

Ordering data

Description

Circuit breaker, four-channel
N/O contact remote signaling
Status and reset
Electrically isolating

Type	Order No.	Pcs./Pkt.
CBMC E4 24DC/1-4A NO	2906031	1
CBMC E4 24DC/1-4A S-R	1065727	1

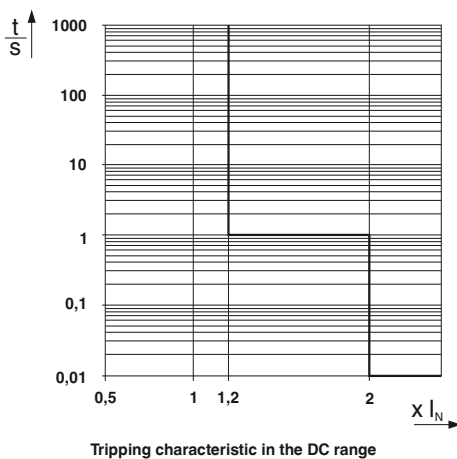



DIN-rail-mountable,
4-channel, max. 8 A/channel
Electrical isolation



DIN-rail-mountable,
4-channel, max. 10 A/channel



Technical data
24 V DC max. 32 A DC (IN+) 1 / 2 / 3 / 4 / 5 / 6 / 7 / 8 A DC (adjustable per output channel)
0.1 s (per output channel) 45000 µF (depending on the current setting and the short-circuit current available) 15 A DC (per output channel)
-
≤ 10 ms (for short circuit > 2.0 x I _N) / 1 s (1.2 ... 2.0 x I _N)
36 mm / 90 mm / 98 mm -25°C ... 60°C EN 61000-6-2/EN 61000-6-3/EN 60068-2-78/EN 50178
0 V DC ... 30 V DC 100 mA DC

Technical data
24 V DC max. 40 A DC (IN+) 1 / 2 / 3 / 4 / 5 / 6 / 7 / 8 / 9 / 10 A DC (adjustable per output channel)
0.1 s (per output channel) 45000 µF (depending on the current setting and the short-circuit current available) 15 A DC (per output channel)
-
≤ 10 ms (for short circuit > 2.0 x I _N) / 1 s (1.2 ... 2.0 x I _N)
36 mm / 90 mm / 98 mm -25°C ... 60°C EN 61000-6-2/EN 61000-6-3/EN 60068-2-6/EN 60068-2-27/ EN 60068-2-78/EN 50178/UL 2367/UL 508
0 V DC ... 30 V DC 100 mA DC

Ordering data		
Type	Order No.	Pcs./Pkt.
CBMC EG4 24DC/1-8A NO	1065730	1

Ordering data		
Type	Order No.	Pcs./Pkt.
CBMC E4 24DC/1-10A NO	2906032	1
CBMC E4 24DC/1-10A S-R	1065729	1

Device circuit breakers

Electronic circuit breakers

CBMC electronic circuit breakers, with IO-Link interface

- For protection against voltage dips caused by overload and short circuit
- Adjustable in 1 A increments up to max. 10 A
- Compact design
- Suitable for NEC Class 2 applications
- Comprehensive control and analysis options by means of IO-Link interface

Notes:
For additional technical data, drawings, and accessories, please visit phoenixcontact.net/products.

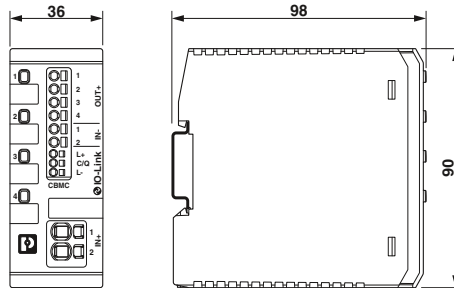

NEC Class 2
acc. to UL 1310



**DIN-rail-mountable,
4-channel, max. 4 A/channel**



Technical data

Electrical data

Rated voltage
Rated current I_N
Rated current I_N

Switch-on delay
Max. capacitive load

Internal output fuse
Active current limitation

Load circuit

Shutdown time

General data

Dimensions W/H/D
Ambient temperature (operation)
Standards/regulations

24 V DC
max. 16 A DC (I_{N+})
1 / 2 / 3 / 4 A DC (adjustable per output channel)
0.1 s (per output channel)
30000 μ F (depending on the current setting and the short-circuit current available)
15 A DC (per output channel)
-

≤ 10 ms (for short circuit $> 2.0 \times I_N$) /
1 s ($1.2 \dots 2.0 \times I_N$)

36 mm / 90 mm / 98 mm
-25°C ... 60°C
EN 61000-6-2/EN 61000-6-3/EN 60068-2-6/EN 60068-2-27/
EN 60068-2-78/EN 50178/UL 508/UL 2367/
UL 1310

Ordering data

Description

Circuit breaker, four-channel

Type

CBMC E4 24DC/1-4A+ IOL

Order No.

2910410

Pcs./Pkt.

1

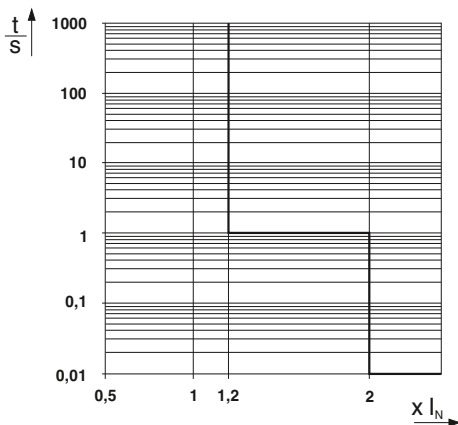

Tripping characteristic in the DC range



**DIN-rail-mountable,
4-channel, max. 10 A/channel**



Technical data

24 V DC
 max. 40 A DC (I_N+)
 1 / 2 / 3 / 4 / 5 / 6 / 7 / 8 / 9 / 10 A DC (adjustable per output channel)

0.1 s (per output channel)
 40000 µF (depending on the current setting and the short-circuit current available)
 15 A DC (per output channel)

≤ 10 ms (for short circuit > 2.0 x I_N) /
 1 s (1.2 ... 2.0 x I_N)

36 mm / 90 mm / 98 mm
 -25°C ... 60°C
 EN 61000-6-2/EN 61000-6-3/EN 60068-2-6/EN 60068-2-27/
 EN 60068-2-78/EN 50178/UL 2367/UL 508

Ordering data

Type	Order No.	Pcs./Pkt.
CBMC E4 24DC/1-10A IOL	2910411	1

Device circuit breakers

Electronic circuit breakers

PTCB electronic circuit breakers

new

- For protection against voltage dips caused by overload and short circuit
- Fixed nominal current values
- Narrow design, just 6 mm wide
- Suitable for NEC Class 2 applications
- Can be bridged to the CLIPLINE complete terminal block range

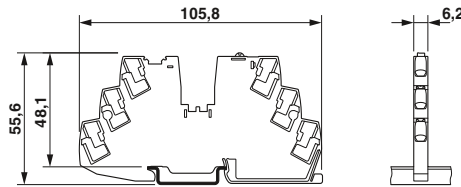

NEC Class 2
acc. to UL 1310



DIN-rail-mountable, 1-channel, fixed



Electrical data

Rated voltage
Rated current I_N
Rated current I_N

Switch-on delay
Max. capacitive load

Internal output fuse

Load circuit

Shutdown time

General data

Dimensions W/H/D
Ambient temperature (operation)
Standards/regulations

Remote indication contact

DC operating voltage
DC operating current

Technical data

...1A...	...2A...
24 V DC	
24 A DC (Total current input)	
1 A DC (Rated current output)	2 A DC (Rated current output)
-	
15000 μ F (depending on the available short-circuit current)	20000 μ F (depending on the available short-circuit current)
4 A DC	
≤ 10 ms (for short circuit $> 2.0 \times I_N$) / 1 s (1.2 ... $2.0 \times I_N$)	
6.2 mm / 105.8 mm / 55.6 mm -25°C ... 60°C	
EN 61000-6-2/EN 61000-6-3/EN 60068-2-78/EN 50178/ EN 60068-2-6/EN 60068-2-27/UL 508/UL 2367/ UL 1310	
0 V DC ... 30 V DC 100 mA DC	

Ordering data

Description	Nominal current	Type	Order No.	Pcs./Pkt.
Circuit breaker, single-channel	1 A	PTCB E1 24DC/1A NO	2909902	1
	2 A	PTCB E1 24DC/2A NO	2909903	1
	3 A			
	4 A			
	6 A			
	8 A			

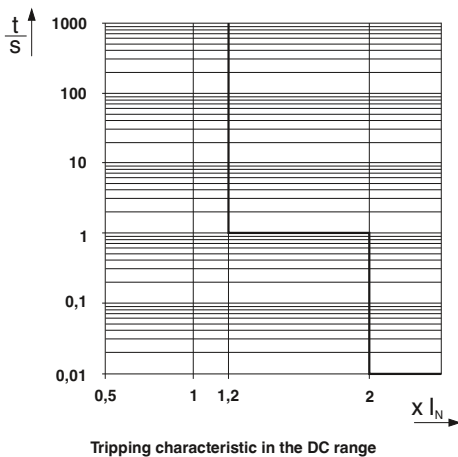

new

new

NEC Class 2
acc. to UL 1310



DIN-rail-mountable, 1-channel, fixed



DIN-rail-mountable, 1-channel, fixed



Technical data	
...3A...	...4A...
24 V DC	
24 A DC (Total current input)	
3 A DC (Rated current output)	4 A DC (Rated current output)
20000 µF (depending on the available short-circuit current)	20000 µF (depending on the available short-circuit current)
4 A DC	
≤ 10 ms (for short circuit > 2.0 x I _N) / 1 s (1.2 ... 2.0 x I _N)	
6.2 mm / 105.8 mm / 55.6 mm	
-25°C ... 60°C	
EN 61000-6-2/EN 61000-6-3/EN 60068-2-78/EN 50178/ EN 60068-2-6/EN 60068-2-27/UL 508/UL 2367/ UL 1310	
0 V DC ... 30 V DC	
100 mA DC	

Technical data	
...6A...	...8A...
24 V DC	
24 A DC (Total current input)	
6 A DC (Rated current output)	8 A DC (Rated current output)
30000 µF (depending on the available short-circuit current)	35000 µF (depending on the available short-circuit current)
15 A DC	
≤ 10 ms (for short circuit > 2.0 x I _N) / 1 s (1.2 ... 2.0 x I _N)	
6.2 mm / 105.8 mm / 55.6 mm	
-25°C ... 60°C	
EN 61000-6-2/EN 61000-6-3/EN 60068-2-78/EN 50178/ EN 60068-2-6/EN 60068-2-27/UL 508/UL 2367	
0 V DC ... 30 V DC	
100 mA DC	

Ordering data		
Type	Order No.	Pcs./Pkt.
PTCB E1 24DC/3A NO	2909904	1
PTCB E1 24DC/4A NO	2909906	1

Ordering data		
Type	Order No.	Pcs./Pkt.
PTCB E1 24DC/6A NO	2909908	1
PTCB E1 24DC/8A NO	2909910	1

Device circuit breakers

Electronic circuit breakers

PTCB electronic circuit breakers, adjustable

new

- For protection against voltage dips caused by overload and short circuit
- Adjustable in 1 A increments up to max. 8 A
- Narrow design, just 6 mm wide
- Suitable for NEC Class 2 applications
- Can be bridged to the CLIPLINE complete terminal block range

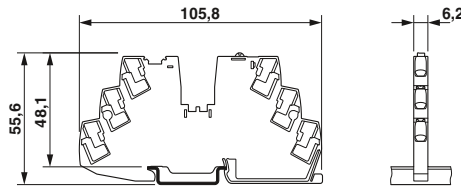

NEC Class 2
acc. to UL 1310



DIN-rail-mountable, 1-channel, adjustable up to max. 3 A



Electrical data

Rated voltage
Rated current I_N
Rated current I_N

Switch-on delay
Max. capacitive load

Internal output fuse
Active current limitation

Load circuit

Shutdown time

General data

Dimensions W/H/D
Ambient temperature (operation)
Standards/regulations

Remote indication contact

DC operating voltage
DC operating current

Technical data

24 V DC
24 A DC (Total current input)
1 / 2 / 3 A DC (adjustable)
-
20000 μ F (depending on the current setting and the short-circuit current available)
4 A DC
-
 ≤ 10 ms (for short circuit $> 2.0 \times I_N$) /
1 s ($1.2 \dots 2.0 \times I_N$)
6.2 mm / 105.8 mm / 55.6 mm
-25°C ... 60°C
EN 61000-6-2/EN 61000-6-3/EN 60068-2-78/EN 50178/
EN 60068-2-6/EN 60068-2-27/UL 508/UL 2367/
UL 1310

Ordering data

Description

Circuit breaker, single-channel

Type	Order No.	Pcs./Pkt.
PTCB E1 24DC/1-3A NO	2909909	1

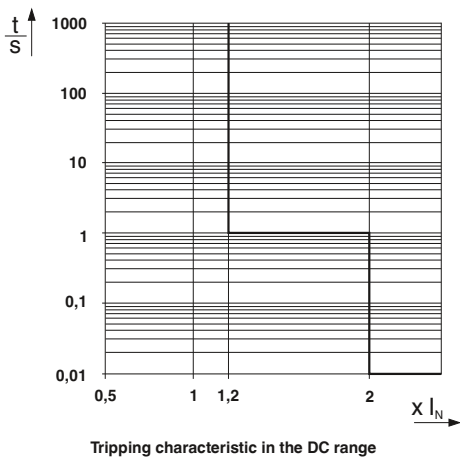

new



DIN-rail-mountable, 1-channel,
adjustable up to max. 4 A



Technical data	
24 V DC	
24 A DC (Total current input)	
1 / 2 / 3 / 4 A DC (adjustable)	
-	
20000 µF (depending on the current setting and the short-circuit current available)	
4 A DC	
-	
≤ 10 ms (for short circuit > 2.0 x I _N) / 1 s (1.2 ... 2.0 x I _N)	
6.2 mm / 105.8 mm / 55.6 mm	
-25°C ... 60°C	
EN 61000-6-2/EN 61000-6-3/EN 60068-2-78/EN 50178/EN 60068-2-6/EN 60068-2-27/UL 508/UL 2367	
0 V DC ... 30 V DC	
100 mA DC	

Ordering data		
Type	Order No.	Pcs./Pkt.
PTCB E1 24DC/1-4A NO	2908261	1

new



DIN-rail-mountable, 1-channel,
adjustable up to max. 8 A



Technical data	
24 V DC	
24 A DC (Total current input)	
1 / 2 / 3 / 4 / 5 / 6 / 7 / 8 A DC (adjustable)	
-	
35000 µF (depending on the current setting and the short-circuit current available)	
15 A DC	
-	
≤ 10 ms (for short circuit > 2.0 x I _N) / 1 s (1.2 ... 2.0 x I _N)	
6.2 mm / 105.8 mm / 55.6 mm	
-25°C ... 60°C	
EN 61000-6-2/EN 61000-6-3/EN 60068-2-78/EN 50178/EN 60068-2-6/EN 60068-2-27/UL 508/UL 2367	
0 V DC ... 30 V DC	
100 mA DC	

Ordering data		
Type	Order No.	Pcs./Pkt.
PTCB E1 24DC/1-8A NO	2908262	1

Device circuit breakers

Electronic circuit breakers

Pluggable electronic circuit breakers

- Device circuit breakers for protecting against voltage dips caused by overloads and short circuits
- Integrated active current limitation
- Remote control possible
- Maximum ease of maintenance, thanks to the two-piece design
- Snap-in function for secure hold and easy removal
- Plug coding possible
- Slim design

Notes:
 When used in combination with the base elements (Order No. 2800929 or 2801305), the products also satisfy UL 508.
 For additional technical data, drawings, and accessories, please visit phoenixcontact.net/products.

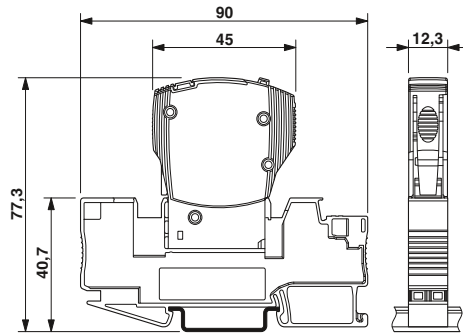

The figure shows the complete module consisting of a base element and plug



1 N/O contact

UL ENE A RL
 Total width 12.3 mm

Technical data

24 V DC
 Depends on the product variant selected

See tripping characteristic
 typ. 1.25 x I_N

-25°C ... 50°C (non-condensing)
 IP30 (Actuation area)
 UL 2367/UL 508/EN 61000-6-3/EN 61000-6-2

Ordering data

Description	Nominal current
Electronic circuit breaker, 1-pos.	
	1 A
	2 A
	3 A
	4 A
	6 A
	8 A
	10 A

Type	Order No.	Pcs./Pkt.
CB E1 24DC/1A NO P	2800901	1
CB E1 24DC/2A NO P	2800902	1
CB E1 24DC/3A NO P	2800903	1
CB E1 24DC/4A NO P	2800904	1
CB E1 24DC/6A NO P	2800905	1
CB E1 24DC/8A NO P	2800906	1
CB E1 24DC/10A NO P	2800907	1

Accessories

Bridge plug, 0 volt distribution
Base element
With Push-in connection technology
With screw connection technology
For the PCB

CB PT BRIDGE	2801014	1
CB 1/6-2/4 PT-BE	2800929	10
CB 1/10-1/10 UT-BE	2801305	10
CB S-BE	2905067	30

Plug-in bridge, for cross connections in the bridge shaft

For FBS ..., see page 396

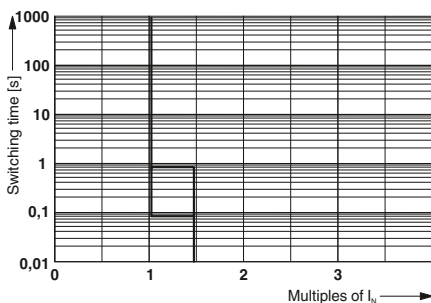

Tripping characteristic



1 N/C contact



1 x Status OUT + 1 x Reset IN



1 x Status OUT + 1 x Control IN

Total width 12.3 mm

Total width 12.3 mm

Total width 12.3 mm

Technical data
24 V DC Depends on the product variant selected
See tripping characteristic typ. 1.25 x I _N
-25°C ... 50°C (non-condensing) IP30 (Actuation area) UL 2367/UL 508/EN 61000-6-3/EN 61000-6-2

Technical data
24 V DC Depends on the product variant selected
See tripping characteristic typ. 1.25 x I _N
-25°C ... 50°C (non-condensing) IP30 (Actuation area) UL 2367/UL 508/EN 61000-6-3/EN 61000-6-2

Technical data
24 V DC Depends on the product variant selected
See tripping characteristic typ. 1.25 x I _N
-25°C ... 50°C (non-condensing) IP30 (Actuation area) UL 2367/UL 508/EN 61000-6-3/EN 61000-6-2

Ordering data		
Type	Order No.	Pcs./Pkt.
CB E1 24DC/1A NC P	2800915	1
CB E1 24DC/2A NC P	2800916	1
CB E1 24DC/3A NC P	2800917	1
CB E1 24DC/4A NC P	2800918	1
CB E1 24DC/6A NC P	2800919	1

Ordering data		
Type	Order No.	Pcs./Pkt.
CB E1 24DC/1A S-R P	2800908	1
CB E1 24DC/2A S-R P	2800909	1
CB E1 24DC/3A S-R P	2800910	1
CB E1 24DC/4A S-R P	2800911	1
CB E1 24DC/6A S-R P	2800912	1
CB E1 24DC/8A S-R P	2800913	1
CB E1 24DC/10A S-R P	2800914	1

Ordering data		
Type	Order No.	Pcs./Pkt.
CB E1 24DC/1A S-C P	2800922	1
CB E1 24DC/2A S-C P	2800923	1
CB E1 24DC/3A S-C P	2800924	1
CB E1 24DC/4A S-C P	2800925	1
CB E1 24DC/6A S-C P	2800926	1
CB E1 24DC/8A S-C P	2800927	1
CB E1 24DC/10A S-C P	2800928	1

Accessories		
Type	Order No.	Pcs./Pkt.
CB PT BRIDGE	2801014	1
CB 1/6-2/4 PT-BE	2800929	10
CB 1/10-1/10 UT-BE	2801305	10
CB S-BE	2905067	30

Accessories		
Type	Order No.	Pcs./Pkt.
CB PT BRIDGE	2801014	1
CB 1/6-2/4 PT-BE	2800929	10
CB 1/10-1/10 UT-BE	2801305	10
CB S-BE	2905067	30

Accessories		
Type	Order No.	Pcs./Pkt.
CB PT BRIDGE	2801014	1
CB 1/6-2/4 PT-BE	2800929	10
CB 1/10-1/10 UT-BE	2801305	10
CB S-BE	2905067	30

For FBS ..., see page 396

For FBS ..., see page 396

For FBS ..., see page 396

Device circuit breakers

Electronic circuit breakers

Pluggable electronic circuit breakers

- Device circuit breakers for protecting against voltage dips caused by overloads and short circuits
- Integrated active current limitation
- Remote control possible
- Maximum ease of maintenance, thanks to the two-piece design
- Snap-in function for secure hold and easy removal
- Plug coding possible
- Slim design

Notes:
For further technical data, drawings, and accessories, and a complete data sheet, please visit phoenixcontact.net/products.

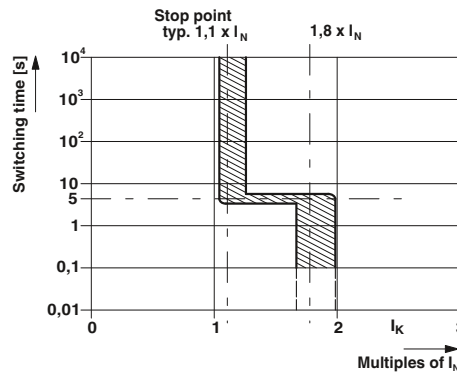

With reset input and status output

ERC
Ex:
Total width 12.5 mm

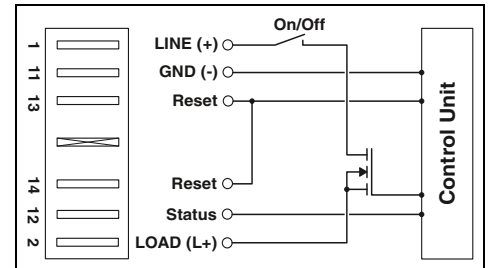

Electrical data	
Operating voltage	24 V DC
Nominal current I_N	Depends on the product variant selected
Disconnection	
Switch-off time	See tripping characteristic
Switch off	Typ. $1.8 \times I_N$
Active current limitation	active
General data	
Ambient temperature (operation)	$0^\circ\text{C} \dots 50^\circ\text{C}$ (non-condensing)
Degree of protection	IP30 (Actuation area)
Standards/regulations	UL 2367/UL 508/CSA 22.2

Technical data		
Operating voltage	24 V DC	
Nominal current I_N	Depends on the product variant selected	
Disconnection		
Switch-off time	See tripping characteristic	
Switch off	Typ. $1.8 \times I_N$	
Active current limitation	active	
General data		
Ambient temperature (operation)	$0^\circ\text{C} \dots 50^\circ\text{C}$ (non-condensing)	
Degree of protection	IP30 (Actuation area)	
Standards/regulations	UL 2367/UL 508/CSA 22.2	

Description	Nominal current
Electronic circuit breaker , can be plugged into TMCP base, signaling via LED	
	1 A
	2 A
	3 A
	4 A
	6 A
	8 A
	10 A
	12 A

Ordering data		
Type	Order No.	Pcs./Pkt.
ECP-E 1A	0900113	5
ECP-E 2A	0900210	5
ECP-E 3A	0900317	5
ECP-E 4A	0900414	5
ECP-E 6A	0900618	5
ECP-E 8A	0900812	5
ECP-E 10A	0901002	5
ECP-E-12A	0900126	5

Spring lock , for mechanical locking in the case of overhead mounting, 1-pos.
Modular socket , 2-position, for holding two circuit breakers, each with a single position
Socket termination elements , can be plugged in both left and right, contain the connections for the reset inputs/group request
Signal bridge , pluggable, for bridging group signaling when there is a free slot on the TMCP SOCKET M socket

Accessories		
Type	Order No.	Pcs./Pkt.
SPRING-LOCK	0713009	10
TMCP SOCKET M	0916589	10
TMCP CONNECT LR	0916592	3
TMCP SB	0916602	6



With control input and group request



With reset input and group request

ERC Ex: Total width 12.5 mm

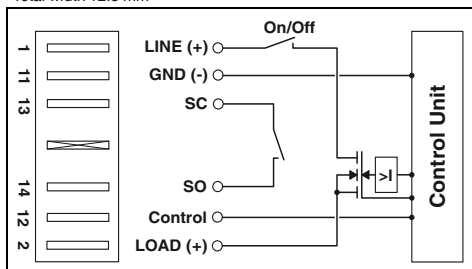

ERC Ex: Total width 12.5 mm

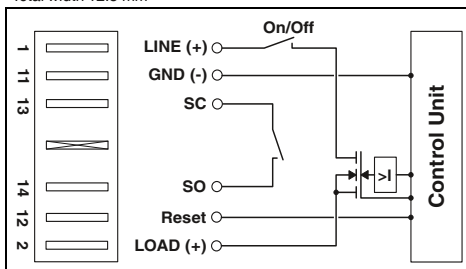

Technical data

24 V DC
Depends on the product variant selected

See tripping characteristic
Typ. $1.8 \times I_N$
active

0°C ... 50°C (non-condensing)
IP30 (Actuation area)
UL 2367/UL 508/CSA 22.2

Technical data

24 V DC
Depends on the product variant selected

See tripping characteristic
Typ. $1.8 \times I_N$
active

0°C ... 50°C (non-condensing)
IP30 (Actuation area)
UL 2367/UL 508/CSA 22.2

Ordering data

Type	Order No.	Pcs./Pkt.
ECP-E2-1A	0900139	5
ECP-E2-2A	0900236	5
ECP-E2-3A	0900333	5
ECP-E2-4A	0900430	5
ECP-E2-6A	0900634	5
ECP-E2-8A	0900838	5
ECP-E2-10A	0900100	5
ECP-E2-12A	0900207	5

Ordering data

Type	Order No.	Pcs./Pkt.
ECP-E3 1A	0912041	5
ECP-E3 2A	0912042	5
ECP-E3 3A	0912043	5
ECP-E3 4A	0912044	5
ECP-E3 6A	0912046	5
ECP-E3 8A	0912048	5
ECP-E3 10A	0912050	5
ECP-E3 12A	0912052	5

Accessories

Accessories	Order No.	Pcs./Pkt.
SPRING-LOCK	0713009	10
TMCP SOCKET M	0916589	10
TMCP CONNECT LR	0916592	3
TMCP SB	0916602	6

Accessories

Accessories	Order No.	Pcs./Pkt.
SPRING-LOCK	0713009	10
TMCP SOCKET M	0916589	10
TMCP CONNECT LR	0916592	3
TMCP SB	0916602	6

Device circuit breakers

Electronic circuit breakers

EC-E1 and EC-E4 electronic circuit breakers

- Selective protection of all load circuits at switched-mode power supply units
- A combination of active electronic current limitation in the event of short circuit and overload shutdown ensures that the circuit breaker can respond to overloads faster than the switched-mode power supply unit
- The residual current is always limited to 1.3 - 1.8 times the nominal current

Notes:
For further technical data, drawings, and accessories, and a complete data sheet, please visit phoenixcontact.net/products.

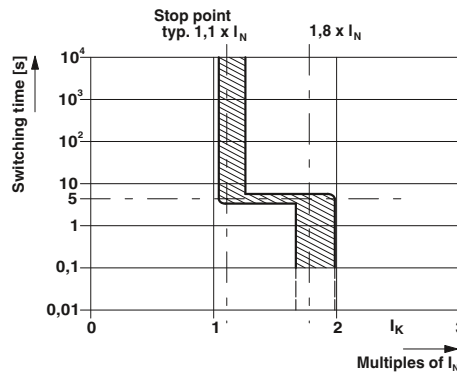

With signal contact as N/C contact or N/O contact

Ex: Total width 12.5 mm

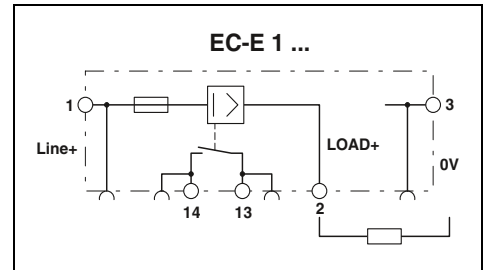

Electrical data	
Operating voltage	24 V DC
Nominal current I_N	Depends on the product variant selected
Disconnection	
Switch-off time	See tripping characteristic
Fuse type	electronic
General data	
Dimensions W/H/D	12.5 mm / 83 mm / 80 mm
Connection method	Screw connection
Connection data rigid / flexible / AWG	0.5 ... 16 mm ² / 0.5 ... 16 mm ² / 20 - 6
Flexible conductor cross section with ferrule	0.5 ... 10 mm ²
Ambient temperature (operation)	0°C ... 50°C (non-condensing)
Degree of protection	IP20 (Housing)
Flammability rating in accordance with UL 94	V0

Technical data		
Operating voltage	24 V DC	
Nominal current I_N	Depends on the product variant selected	
Disconnection		
Switch-off time	See tripping characteristic	
Fuse type	electronic	
General data		
Dimensions W/H/D	12.5 mm / 83 mm / 80 mm	
Connection method	Screw connection	
Connection data rigid / flexible / AWG	0.5 ... 16 mm ² / 0.5 ... 16 mm ² / 20 - 6	
Flexible conductor cross section with ferrule	0.5 ... 10 mm ²	
Ambient temperature (operation)	0°C ... 50°C (non-condensing)	
Degree of protection	IP20 (Housing)	
Flammability rating in accordance with UL 94	V0	

Description	Nominal current
Electronic circuit breaker, signal contact: 1 N/O contact	
	0.5 A
	1 A
	2 A
	3 A
	4 A
	6 A
	8 A
	10 A
	12 A
Electronic circuit breaker, signal contact: 1 N/C contact	
	0.5 A
	1 A
	2 A
	3 A
	4 A
	6 A
	8 A
	10 A
	12 A

Ordering data		
Type	Order No.	Pcs./Pkt.
EC-E1 0,5A	0903022	6
EC-E1 1A	0903023	6
EC-E1 2A	0903024	6
EC-E1 3A	0903025	6
EC-E1 4A	0903026	6
EC-E1 6A	0903028	6
EC-E1 8A	0903029	6
EC-E1 10A	0903030	6
EC-E1 12A	0903031	6
Electronic circuit breaker, signal contact: 1 N/C contact		
EC-E4 0,5A	0903040	6
EC-E4 1A	0903032	6
EC-E4 2A	0903033	6
EC-E4 3A	0903034	6
EC-E4 4A	0903035	6
EC-E4 6A	0903036	6
EC-E4 8A	0903037	6
EC-E4 10A	0903038	6
EC-E4 12A	0903039	6

Accessories	
Continuous plug-in bridge, 500 mm long, isolated, can be cut to length, for potential distribution	
Nominal current: 32 A	
Screwdriver	

FBST 500-PLC BU	2966692	20
FBST 500-PLC RD	2966786	20
FBST 500 TMC-N GY	0901028	10
SZS 0,6X3,5	1205053	10

EC-E electronic circuit breakers

- Selective protection of all 24 V DC load circuits at switched-mode power supply units
- A combination of active electronic current limitation in the event of short circuit and overload shutdown ensures that the circuit breaker can respond to overloads faster than the switched-mode power supply unit
- The residual current is always limited to 1.3 - 1.8 times the nominal current

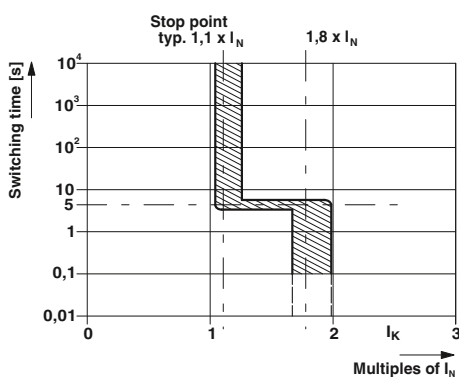

With reset input and status output

Notes:
For further technical data, drawings, and accessories, and a complete data sheet, please visit phoenixcontact.net/products.

ERC
Ex:
Total width 12.5 mm

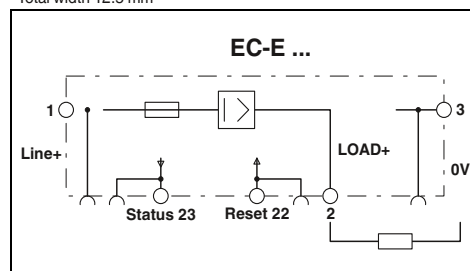

Electrical data	
Operating voltage	24 V DC
Nominal current I_N	Depends on the product variant selected
Disconnection	
Switch-off time	See tripping characteristic
Fuse type	electronic
General data	
Dimensions W/H/D	12.5 mm / 83 mm / 80 mm
Connection method	Screw connection
Connection data rigid / flexible / AWG	0.5 ... 16 mm ² / 0.5 ... 16 mm ² / 26 - 6
Flexible conductor cross section with ferrule	0.5 ... 10 mm ²
Ambient temperature (operation)	0°C ... 50°C (non-condensing)
Degree of protection	IP20 (Housing)
Flammability rating in accordance with UL 94	V0

Technical data

24 V DC
Depends on the product variant selected
See tripping characteristic
electronic
12.5 mm / 83 mm / 80 mm
Screw connection
0.5 ... 16 mm ² / 0.5 ... 16 mm ² / 26 - 6
0.5 ... 10 mm ²
0°C ... 50°C (non-condensing)
IP20 (Housing)
V0

Description	Nominal current
Electronic circuit breaker, with reset input	
	0.5 A
	1 A
	2 A
	3 A
	4 A
	6 A
	8 A
	10 A
	12 A

Ordering data

Type	Order No.	Pcs./Pkt.
EC-E 0,5A DC24V	0903041	6
EC-E 1A DC24V	0903042	6
EC-E 2A DC24V	0903043	6
EC-E 3A DC24V	0903044	6
EC-E 4A DC24V	0903045	6
EC-E 6A DC24V	0903046	6
EC-E 8A DC24V	0903047	6
EC-E 10A DC24V	0903048	6
EC-E 12A DC24V	0903049	6

Continuous plug-in bridge, 500 mm long, isolated, can be cut to length, for potential distribution
Nominal current: 32 A

Accessories

FBST 500-PLC BU	2966692	20
FBST 500-PLC RD	2966786	20
FBST 500 TMC-N GY	0901028	10



Branch out

The device circuit breakers provide reliable protection even in systems with long cable paths. Together with the SFB Technology* of the QUINT POWER power supplies, the special SFB tripping characteristic of the CB device circuit breakers ensures fast shutdown in the event of an error. This combination offers maximum protection against overload and short-circuit currents.

*) SFB - Selective Fuse Breaking, selective shutdown

Individually adjustable

The CB TM device circuit breakers reliably protect loads against overload currents and short-circuit currents. Thanks to numerous different protective plugs, a large range is available which enables you to configure the necessary protection according to your requirements.

Modular expansion possible

The UT6-TMC device circuit breakers provide optimum basic protection. Thanks to their thermomagnetic characteristic curve, which is available in various nominal currents, they reliably protect loads and cables against overload currents and short-circuit currents.

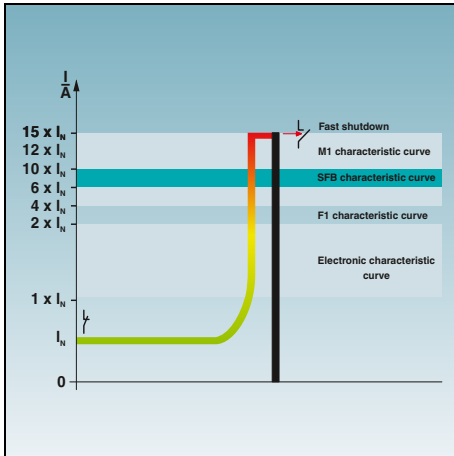

SFB tripping characteristic

Thermomagnetic device circuit breakers with the SFB tripping characteristic* provide maximum overcurrent protection – even in large systems with long cable paths.

*SFB = Selective Fuse Breaking, selective shutdown



Electrical isolation

Certain sectors of industry place more stringent requirements on safety. Thermomagnetic circuit breakers featuring electrical isolation enable you to satisfy these requirements. This is because the power path is physically isolated in the event of a fault. As a result, the application is reliably protected against unwanted currents.



Simple feed-in

Feed-in to the UT6-TMC is simple, thanks to the double bridge shaft. Systems can also be extended quickly and easily. You can use standard accessories from the CLIPLINE complete portfolio, and do not need to qualify new materials.

Device circuit breakers

Thermomagnetic device circuit breakers

Selection guide

CB TM



50 V DC
277 V AC
0.5 A ... 16 A
Page 391

UT 6-TMC



28 V DC
240 V AC
0.5 A ... 16 A
Page 394

TMC



65 V DC
250 V AC
0.2 A ... 16 A
Page 395

Applications

CB TM1 and UT 6

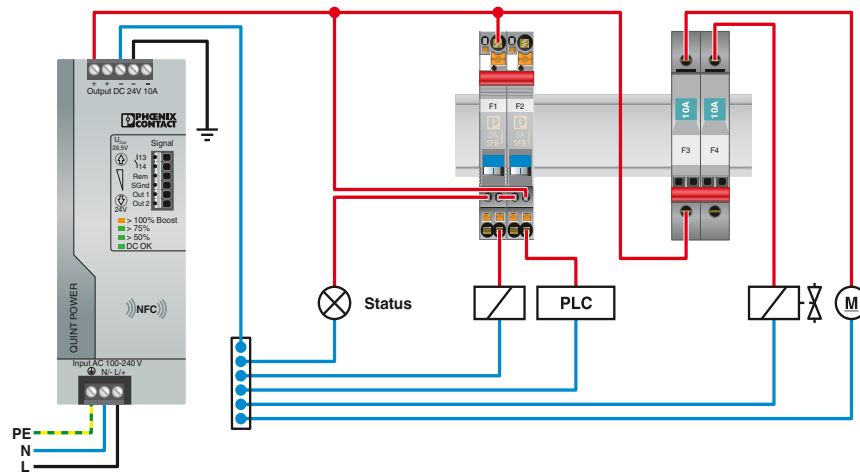

CB TM1

UT 6

Page 311

Page 394

Pluggable thermomagnetic circuit breakers

- Device circuit breakers for protecting against voltage dips caused by overloads and short circuits
- SFB characteristic curve enables longer cables and tripping times < 10 ms
- Maximum ease of maintenance, thanks to the two-piece design
- Snap-in function for secure hold and easy removal
- Plug coding possible
- Slim design



Pluggable, SFB characteristic curve, 1-pos.



Pluggable, SFB characteristic curve, 2-pos.

CE, UL, IEC, ENEC, VDE, TÜV, ENEC, CE, RoHS
Total width 12.3 mm

Technical data		
IEC	UL / CUL	CSA
50 V DC	50 V DC	-
Depends on the product variant selected		
See tripping characteristic		
SFB		
- / 600 A (50 V DC)		
6000 (at 1 x I _n)		
-30°C ... 60°C		
IP30 (Actuation area)		
EN 60934/UL 1077/UL 508/CSA 22.2		

CE, UL, IEC, ENEC, VDE, TÜV, ENEC, CE, RoHS
Total width 24.6 mm

Technical data		
IEC	UL / CUL	CSA
80 V DC	80 V DC	-
Depends on the product variant selected		
See tripping characteristic		
SFB		
- / 600 A (80 V DC)		
6000 (240 V AC/1 x I _n)		
-30°C ... 60°C		
IP30 (Actuation area)		
EN 60934/UL 1077/UL 508/CSA 22.2		

Electrical data	
Rated voltage	
Nominal current I _n	
Disconnection	
Switch-off time	
Fuse type	
Rated short-circuit switching capacity I _{cn}	
Switching cycles, max.	
General data	
Ambient temperature (operation)	
Degree of protection	
Standards/regulations	

Ordering data			
Type	Order No.	Pcs./Pkt.	
CB TM1 0.5A SFB P	2800835	1	
CB TM1 1A SFB P	2800836	1	
CB TM1 2A SFB P	2800837	1	
CB TM1 3A SFB P	2800838	1	
CB TM1 4A SFB P	2800839	1	
CB TM1 5A SFB P	2800840	1	
CB TM1 6A SFB P	2800841	1	
CB TM1 8A SFB P	2800842	1	
CB TM1 10A SFB P	2800843	1	
CB TM1 12A SFB P	2800844	1	
CB TM1 16A SFB P	2800845	1	

Ordering data			
Type	Order No.	Pcs./Pkt.	
CB TM2 0.5A SFB P	2800868	1	
CB TM2 1A SFB P	2800869	1	
CB TM2 2A SFB P	2800870	1	
CB TM2 3A SFB P	2800871	1	
CB TM2 4A SFB P	2800872	1	
CB TM2 5A SFB P	2800873	1	
CB TM2 6A SFB P	2800874	1	
CB TM2 8A SFB P	2800875	1	
CB TM2 10A SFB P	2800876	1	
CB TM2 12A SFB P	2800877	1	
CB TM2 16A SFB P	2800878	1	

Description	Nominal current
Thermomagnetic circuit breaker, pluggable, 1-pos., signal contact 1 PDT	
	0.5 A
	1 A
	2 A
	3 A
	4 A
	5 A
	6 A
	8 A
	10 A
	12 A
	16 A

Accessories			
Accessories	Order No.	Pcs./Pkt.	
CB PT BRIDGE	2801014	1	
CB 1/6-2/4 PT-BE	2800929	10	
CB 1/10-1/10 UT-BE	2801305	10	
CB S-BE	2905067	30	

Accessories			
Accessories	Order No.	Pcs./Pkt.	
CB PT BRIDGE	2801014	1	
CB 1/6-2/4 PT-BE	2800929	10	
CB 1/10-1/10 UT-BE	2801305	10	
CB S-BE	2905067	30	

Bridge plug, 0 volt distribution	
Base element	
With Push-in connection technology	
With screw connection technology	
For the PCB	

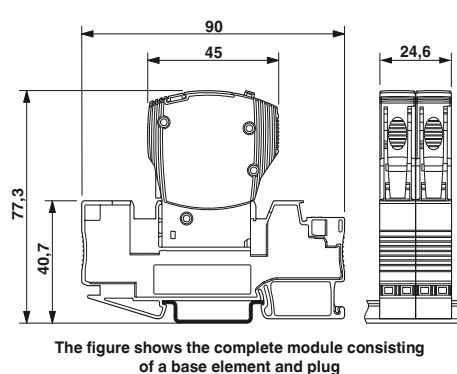
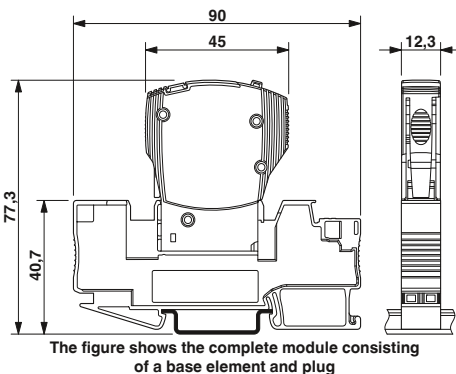
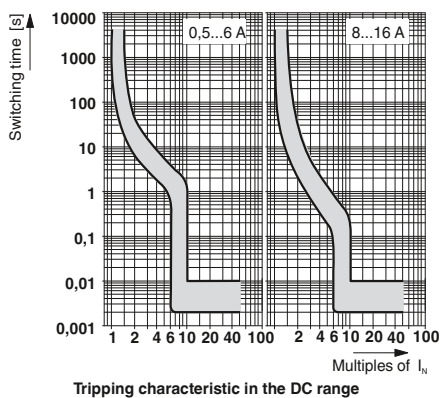

Device circuit breakers

Thermomagnetic device circuit breakers

Pluggable thermomagnetic circuit breakers

- Device circuit breakers for protecting against voltage dips caused by overloads and short circuits
- Medium-blow and fast-blow tripping characteristics
- 1- and 2-pos. circuit breakers
- Maximum ease of maintenance, thanks to the two-piece design
- Snap-in function for secure hold and easy removal
- Plug coding possible
- Slim design



Pluggable, M1 characteristic curve, 1-pos.



Pluggable, M1 characteristic curve, 2-pos.



Total width 12.3 mm

Technical data

IEC	UL / CUL	CSA
240 V AC	277 V AC	-
50 V DC	50 V DC	-
Depends on the product variant selected		

See tripping characteristic
normal blow
300 A (240 V AC) / 600 A (50 V DC)
6000 (at 1 x I_n)

-30°C ... 60°C
IP30 (Actuation area)
EN 60934/UL 1077/UL 508/CSA 22.2

Ordering data

Type	Order No.	Pcs./Pkt.
CB TM1 0.5A M1 P	2800846	1
CB TM1 1A M1 P	2800847	1
CB TM1 2A M1 P	2800848	1
CB TM1 3A M1 P	2800849	1
CB TM1 4A M1 P	2800850	1
CB TM1 5A M1 P	2800851	1
CB TM1 6A M1 P	2800852	1
CB TM1 8A M1 P	2800853	1
CB TM1 10A M1 P	2800854	1
CB TM1 12A M1 P	2800855	1
CB TM1 16A M1 P	2800856	1

Accessories

Accessories	Order No.	Pcs./Pkt.
CB PT BRIDGE	2801014	1
CB 1/6-2/4 PT-BE	2800929	10
CB 1/10-1/10 UT-BE	2801305	10
CB S-BE	2905067	30



Total width 24.6 mm

Technical data

IEC	UL / CUL	CSA
240 V AC	277 V AC	-
80 V DC	80 V DC	-
Depends on the product variant selected		

See tripping characteristic
normal blow
400 A (240 V AC) / 600 A (80 V DC)
6000 (240 V AC/1 x I_n)

-30°C ... 60°C
IP30 (Actuation area)
EN 60934/UL 1077/UL 508/CSA 22.2

Ordering data

Type	Order No.	Pcs./Pkt.
CB TM2 0.5A M1 P	2800879	1
CB TM2 1A M1 P	2800880	1
CB TM2 2A M1 P	2800881	1
CB TM2 3A M1 P	2800882	1
CB TM2 4A M1 P	2800883	1
CB TM2 5A M1 P	2800884	1
CB TM2 6A M1 P	2800885	1
CB TM2 8A M1 P	2800886	1
CB TM2 10A M1 P	2800887	1
CB TM2 12A M1 P	2800888	1
CB TM2 16A M1 P	2800889	1

Accessories

Accessories	Order No.	Pcs./Pkt.
CB PT BRIDGE	2801014	1
CB 1/6-2/4 PT-BE	2800929	10
CB 1/10-1/10 UT-BE	2801305	10
CB S-BE	2905067	30

Electrical data
Rated voltage
Rated voltage
Nominal current I _N
Disconnection
Switch-off time
Fuse type
Rated short-circuit switching capacity I _{cn}
Switching cycles, max.
General data
Ambient temperature (operation)
Degree of protection
Standards/regulations

Description	Nominal current
Thermomagnetic circuit breaker, pluggable, signal contact 1 PDT	0.5 A
	1 A
	2 A
	3 A
	4 A
	5 A
	6 A
	8 A
	10 A
	12 A
	16 A

Bridge plug, 0 volt distribution
Base element
With Push-in connection technology
With screw connection technology
For the PCB

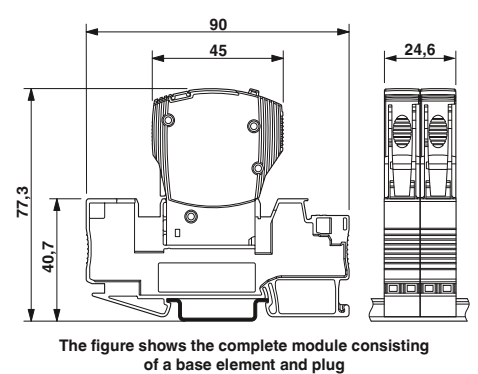
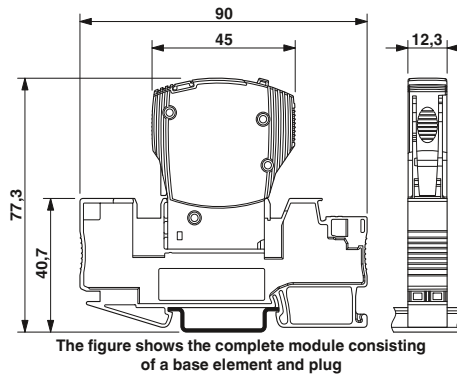
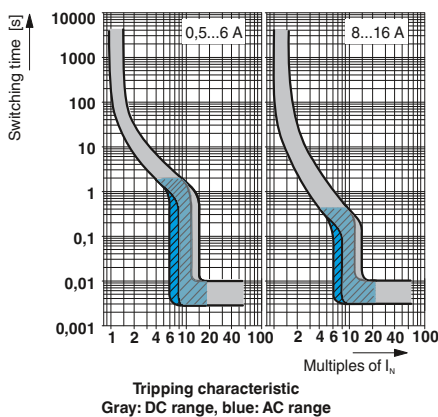

Pluggable thermomagnetic circuit breakers

- Device circuit breakers for protecting against voltage dips caused by overloads and short circuits
- Medium-blow and fast-blow tripping characteristics
- 1- and 2-pos. circuit breakers
- Maximum ease of maintenance, thanks to the two-piece design
- Snap-in function for secure hold and easy removal
- Plug coding possible
- Slim design



Pluggable, F1 characteristic curve, 1-pos.



Pluggable, F1 characteristic curve, 2-pos.



Electrical data	
Rated voltage	50 V DC
Nominal current I_n	0.5, 1, 2, 3, 4, 5, 6, 8, 10, 12, 16 A
Disconnection	
Switch-off time	See tripping characteristic
Fuse type	fast blow
Rated short-circuit switching capacity I_{cn}	- / 600 A (50 V DC)
Switching cycles, max.	6000 (at 1 x I_n)
General data	
Ambient temperature (operation)	-30°C ... 60°C
Degree of protection	IP30 (Actuation area)
Standards/regulations	EN 60934/UL 1077/UL 508/CSA 22.2

Technical data		
IEC	UL / CUL	CSA
50 V DC	50 V DC	-
Depends on the product variant selected		
See tripping characteristic		
fast blow		
- / 600 A (50 V DC)		
6000 (at 1 x I_n)		
-30°C ... 60°C		
IP30 (Actuation area)		
EN 60934/UL 1077/UL 508/CSA 22.2		

Technical data		
IEC	UL / CUL	CSA
80 V DC	80 V DC	-
Depends on the product variant selected		
See tripping characteristic		
fast blow		
- / 600 A (80 V DC)		
6000 (240 V AC/1 x I_n)		
-30°C ... 60°C		
IP30 (Actuation area)		
EN 60934/UL 1077/UL 508/CSA 22.2		

Description	Nominal current
Thermomagnetic circuit breaker, pluggable, signal contact 1 PDT	
	0.5 A
	1 A
	2 A
	3 A
	4 A
	5 A
	6 A
	8 A
	10 A
	12 A
	16 A

Ordering data			
Type	Order No.	Pcs./Pkt.	
CB TM1 0.5A F1 P	2800857	1	
CB TM1 1A F1 P	2800858	1	
CB TM1 2A F1 P	2800859	1	
CB TM1 3A F1 P	2800860	1	
CB TM1 4A F1 P	2800861	1	
CB TM1 5A F1 P	2800862	1	
CB TM1 6A F1 P	2800863	1	
CB TM1 8A F1 P	2800864	1	
CB TM1 10A F1 P	2800865	1	
CB TM1 12A F1 P	2800866	1	
CB TM1 16A F1 P	2800867	1	

Ordering data			
Type	Order No.	Pcs./Pkt.	
CB TM2 0.5A F1 P	2800890	1	
CB TM2 1A F1 P	2800891	1	
CB TM2 2A F1 P	2800892	1	
CB TM2 3A F1 P	2800893	1	
CB TM2 4A F1 P	2800894	1	
CB TM2 5A F1 P	2800895	1	
CB TM2 6A F1 P	2800896	1	
CB TM2 8A F1 P	2800897	1	
CB TM2 10A F1 P	2800898	1	
CB TM2 12A F1 P	2800899	1	
CB TM2 16A F1 P	2800900	1	

Bridge plug, 0 volt distribution
Base element
With Push-in connection technology
With screw connection technology
For the PCB

Accessories		
Accessories	Order No.	Pcs./Pkt.
CB PT BRIDGE	2801014	1
CB 1/6-2/4 PT-BE	2800929	10
CB 1/10-1/10 UT-BE	2801305	10
CB S-BE	2905067	30

Accessories		
Accessories	Order No.	Pcs./Pkt.
CB PT BRIDGE	2801014	1
CB 1/6-2/4 PT-BE	2800929	10
CB 1/10-1/10 UT-BE	2801305	10
CB S-BE	2905067	30

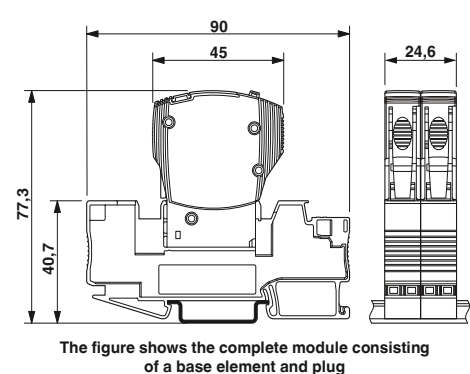
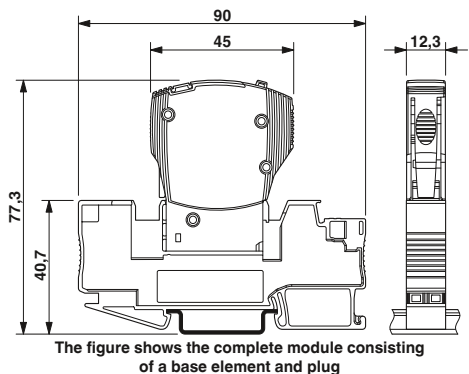
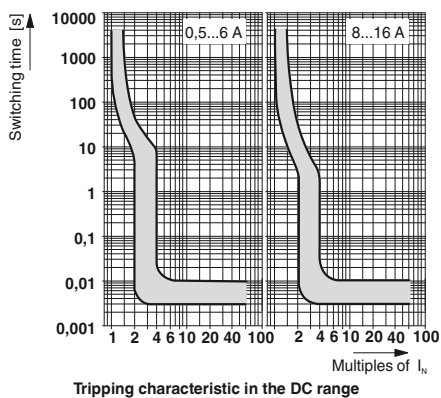

Device circuit breakers

Thermomagnetic device circuit breakers

Thermomagnetic circuit breakers UT 6-TMC ...

- Thermomagnetic circuit breakers feature a compact design, large-surface marking options, and a double plug-in bridge shaft
- With bridge shafts enabling them to be bridged together easily
- 12.3 mm compact design
- High level of system availability, thanks to their reclosure function and clear status display
- Eleven nominal current levels can be selected from 0.5 A to 16 A
- Clear assignment of the relevant circuit breaker, thanks to the large center marking area

Notes:
For further technical data, drawings, and accessories, and a complete data sheet, please visit phoenixcontact.net/products.



DIN-rail-mountable

Total width 12.3 mm

Electrical data	
Rated voltage	240 V AC
Rated voltage	28 V DC
Nominal current I_N	Depends on the product variant selected
Disconnection	
Switch-off time	See tripping characteristic
Fuse type	Normal blow (M1)
Rated short-circuit switching capacity I_{cs}	200 A (240 V AC) / 400 A (28 V DC)
Switching cycles, max.	6000 (at 1 x I_n)
General data	
Dimensions W/H/D	12.3 mm / 85.5 mm / 89.5 mm
Connection method	Screw connection
Connection data rigid / flexible / AWG	0.2 ... 10 mm ² / 0.2 ... 10 mm ² / 24 - 8
Flexible conductor cross section with ferrule	0.25 ... 6 mm ²
Ambient temperature (operation)	-30°C ... 60°C
Degree of protection	IP40 (Actuation area) / IP20 (Connection area)
Standards/regulations	EN 60934/UL 1077/CSA 22.2/EAC

Technical data		
IEC	UL / CUL	CSA
240 V AC	240 V AC	-
28 V DC	28 V DC	-
Depends on the product variant selected		

See tripping characteristic
Normal blow (M1)
200 A (240 V AC) / 400 A (28 V DC)
6000 (at 1 x I_n)

Dimensions W/H/D: 12.3 mm / 85.5 mm / 89.5 mm
Connection method: Screw connection
Connection data rigid / flexible / AWG: 0.2 ... 10 mm² / 0.2 ... 10 mm² / 24 - 8
Flexible conductor cross section with ferrule: 0.25 ... 6 mm²
Ambient temperature (operation): -30°C ... 60°C
Degree of protection: IP40 (Actuation area) / IP20 (Connection area)
Standards/regulations: EN 60934/UL 1077/CSA 22.2/EAC

Description	Nominal current
Thermomagnetic circuit breaker, for mounting on NS 35...	
	0.5 A
	1 A
	2 A
	4 A
	5 A
	6 A
	8 A
	10 A
	12 A
	15 A
	16 A

Ordering data		
Type	Order No.	Pcs./Pkt.
UT 6-TMC M 0,5A	0916603	6
UT 6-TMC M 1A	0916604	6
UT 6-TMC M 2A	0916605	6
UT 6-TMC M 4A	0916606	6
UT 6-TMC M 5A	0916607	6
UT 6-TMC M 6A	0916608	6
UT 6-TMC M 8A	0916609	6
UT 6-TMC M 10A	0916610	6
UT 6-TMC M 12A	0916611	6
UT 6-TMC M 15A	0916612	6
UT 6-TMC M 16A	0916613	6

Plug-in bridge, red	Number of positions
	2
	3
	4
	5
	10
	20

Accessories		
Accessories	Order No.	Pcs./Pkt.
FBS 2-6	3030336	50
FBS 3-6	3030242	50
FBS 4-6	3030255	50
FBS 5-6	3030349	50
FBS 10-6	3030271	10
FBS 20-6	3030365	10

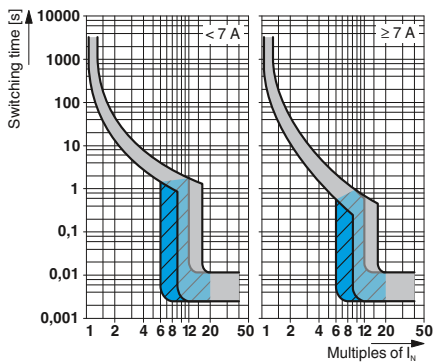

Tripping characteristic
Gray: DC range, blue: AC range

Thermomagnetic circuit breakers TMC

- Available with fast-blow and medium-blow characteristic curve for various nominal current strengths
- Single or two-pos. main current path



DIN-rail-mountable

Notes:
1) Main contact
For further technical data, drawings, and accessories, and a complete data sheet, please visit phoenixcontact.net/products .



Total width 12.5 mm

Technical data

Electrical data	IEC	UL / CUL	CSA
Rated voltage	-	-	-
Rated voltage	65 V DC	-	-
Nominal current I_N	Depends on the product variant selected		
Disconnection			
Switch-off time	See tripping characteristic		
Fuse type	Fast blow (F1)		
Rated short-circuit switching capacity I_{cn}	-/ 2500 A (32 V DC)		
General data			
Dimensions W/H/D	12.5 mm / 82.5 mm / 96 mm		
Connection method	Screw connection		
Connection data rigid / flexible / AWG	0.2 ... 6 mm ² / 0.2 ... 4 mm ² / 24 - 10		
Flexible conductor cross section with ferrule	0.25 ... 4 mm ²		
Ambient temperature (operation)	-30°C ... 60°C		
Degree of protection	IP30 (Actuation area) / IP20 (Connection area)		

Ordering data

Description	Nominal current	Type	Order No.	Pcs./Pkt.
Thermomagnetic circuit breaker , with universal foot for mounting on NS 32... or NS 35...		TMC 1 F1 100 0,2A	0914015	6

TMC type key

The type key indicates the unique structure of the product.

Type	Main current paths	Characteristic curve	Auxiliary contact versions	Nominal current
TMC	1 ≙ Single-pos. 2 ≙ Two-pos. 3 ≙ Three-pos.	F1 ≙ Therm. 1.05 - 1.4 I_N , mag. 2 - 4 I_N DC (fast-blow), Only for DC applications M1 ≙ Therm. 1.05 - 1.4 I_N , mag. 6 - 12 I_N AC, 7.8 - 15.6 I_N DC (medium-blow)	100 ≙ Single-pos.: 1 N/O contact 200 ≙ Single-pos.: 1 N/C contact 120 ≙ Two-pos.: 1 N/O contact, 1 N/C contact 122 ≙ Three-pos.: 1 N/O contact, 2 N/C contacts	0.2 A 2.5 A 0.3 A 3 A 0.4 A 4 A 0.5 A 5 A 0.6 A 6 A 0.8 A 8 A 1 A 10 A 1.5 A 12 A 2 A 16 A

Ordering example:

The ordering data for a TMC with 1-pos. main current path, medium-blow characteristic curve, one N/O contact, and a nominal current of 2 A is:

TMC	1	M1	100	2 A
-----	---	----	-----	-----

Device circuit breakers

Thermomagnetic device circuit breakers

Base element and plug-in bridges

Base elements

- For accommodating CB TM.../CB E... device circuit breakers
- DIN rail module
- With bridge shafts
- Systematic structure with 1-channel base elements possible

Notes:
Can be loaded with up to 41 A if two bridges are connected for the supply.



1-pos., with screw or Push-in connection technology



For the PCB

	Technical data			Technical data		
Electrical data	... PT-BE	... UT-BE				
Rated surge voltage	4 kV	2.5 kV				-
General data	12.3 mm / 90 mm / 46.7 mm			12.3 mm / 34.8 mm / 36.4 mm		
Dimensions W/H/D	Push-in connection	Screw connection		Solder connection		
Connection method	-30°C ... 60°C			-30°C ... 60°C		
Ambient temperature (operation)	IP30 (Actuation area)	IP30 (Actuation area)		IP30 (Plug-in area with plugged-in device) /		
Degree of protection	V0	V0		IP00 (Connection area)		
Flammability rating in accordance with UL 94	IEC 60947-7-1			V-0		
Standards/regulations				DIN EN 50155/IEC 60068-2		
	Ordering data			Ordering data		
Description	Type	Order No.	Pcs./Pkt.	Type	Order No.	Pcs./Pkt.
Base element						
With Push-in connection technology, 1 x 6 mm ² input/2 x 4 mm ² output	CB 1/6-2/4 PT-BE	2800929	10	CB S-BE	2905067	30
With screw connection technology, 1 x 10 mm ² input/1 x 10 mm ² output	CB 1/10-1/10 UT-BE	2801305	10			
	Accessories			Accessories		
Plug-in bridge, red	Number of positions					
	2	FBS 2-6	3030336	50		
	3	FBS 3-6	3030242	50		
	4	FBS 4-6	3030255	50		
	5	FBS 5-6	3030349	50		
	10	FBS 10-6	3030271	10		
	20	FBS 20-6	3030365	10		
	50	FBS 50-6	3032224	10		
Plug-in bridge, blue	Number of positions					
	2	FBS 2-6 BU	3036932	50		
	3	FBS 3-6 BU	3036945	50		
	4	FBS 4-6 BU	3036958	50		
	5	FBS 5-6 BU	3036961	50		
	10	FBS 10-6 BU	3032198	10		
	20	FBS 20-6 BU	3032208	10		
	50	FBS 50-6 BU	3032211	10		
Plug-in bridge, gray	Number of positions					
	2	FBS 2-6 GY	3032237	50		
	3	FBS 3-6 GY	3032240	50		
	4	FBS 4-6 GY	3032279	50		
	5	FBS 5-6 GY	3032266	50		
	10	FBS 10-6 GY	3032253	10		



Thermal overload protection

Thermal device circuit breakers provide optimum protection against overload for inductive loads in power distribution systems. The integrated switching function of the device circuit breakers enables them to be switched on again immediately, thereby minimizing downtimes in the system.

Function and design

Thermal device circuit breakers are normally tripped via a bimetal strip. In the event of a fault, the bimetal heats up and disconnects the circuit. As a rule: the higher the overload, the faster the thermal device circuit breaker trips. The devices can be switched on again at any time. Thermal device circuit breakers are available as pluggable versions.

Areas of application

Typical areas of application for thermal device circuit breakers are sensors and actuators in systems. These include: motors, heating elements and fans, and devices with a high starting current. Thermal device circuit breakers have a maximum voltage range of 250 V AC or 65 V DC.

Selection guide

TCP../DC

TCP



32 V DC

5 A ... 40 A
Page 400

65 V DC
250 V AC

0.25 A ... 10 A
Page 401

Applications

TCP

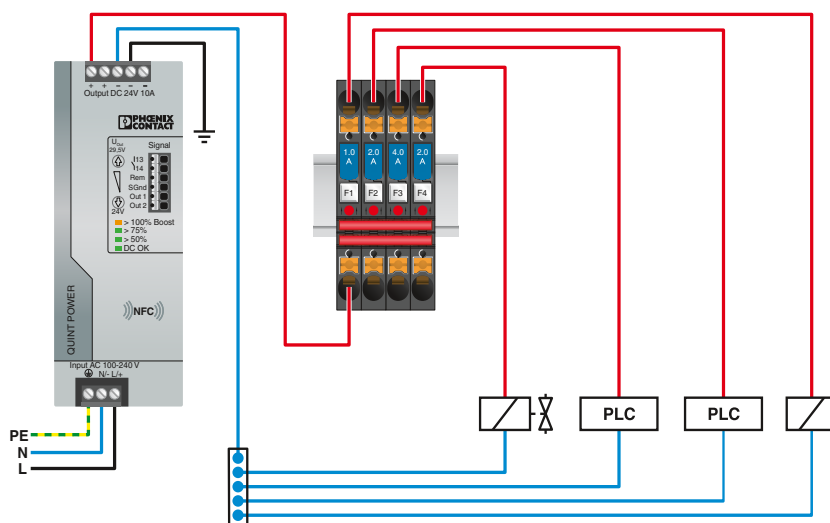

TCP

Device circuit breakers

Thermal device circuit breakers

TCP thermal circuit breakers

- The pluggable thermal miniature circuit breaker combines the protective mechanism of an automotive flat-type fuse with the advantages of a circuit breaker
- In the event of an error, the time-sensitive search for a suitable replacement fuse is eliminated, thanks to the reclosure function
- The area of application extends to the protection of integrated circuits in all battery and onboard systems with up to 32 V DC
- Fits in all fuse holders designed for flat-type fuse-links in accordance with ISO 8820-3 (DIN 72581-3)
- A version with screw or spring-cage connection is used as a basic terminal block

Notes:
1) If the fuse is faulty, the downstream circuit is not off load.
Attention: The reset button must not be obstructed. During installation, please leave enough room for using button.
For further technical data, drawings, and accessories, and a complete data sheet, please visit phoenixcontact.net/products .
You can find a wide selection of fuse terminal blocks in Catalog 1



For fuse holder

Electrical data
Rated voltage
Nominal current I_N
Disconnection
Switch-off time
Fuse type
Rated short-circuit switching capacity I_{sc}
General data
Dimensions W/H/D
Height
Ambient temperature (operation)
Degree of protection

ERC

Total width 6 mm

Technical data		
IEC	UL / CUL	CSA
32 V DC	-	-
Depends on the product variant selected		
See tripping characteristic		
Slow-blow		
≤ 50 A (300 switch-offs)		
6 mm / 20.3 mm / 24 mm		
17 mm		
-40°C ... 85°C		
IP30 (Actuation area)		

Description	Nominal current
Single-pos., thermal circuit breaker , for fuse holders in acc. with ISO 8820-3	
	5 A
	7.5 A
	10 A
	15 A
	20 A
	25 A
	30 A
	40 A

Ordering data		
Type	Order No.	Pcs./Pkt.
TCP 5/DC32V	0700005	50
TCP 7,5/DC32V	0700007	50
TCP 10/DC32V	0700010	50
TCP 15/DC32V	0700015	50
TCP 20/DC32V	0700020	50
TCP 25/DC32V	0700025	50
TCP 30/DC32V	0700030	50
TCP 40/DC32V	0700040	50

Fuse terminal block , with spring-cage connection, max. nominal current of 30 A, for mounting on NS 35...
with LED display for 12 V DC, 1.7 mA ¹⁾
with LED display for 24 V DC, 1.9 mA ¹⁾
Fuse terminal block , with screw connection, max. nominal current of 30 A, for mounting on NS 35...
with LED display for 12 V DC, 1.7 mA ¹⁾
with LED display for 24 V DC, 1.9 mA ¹⁾
Fuse terminal block , with Push-in connection, max. nominal current of 25 A, for mounting on NS 35...
with LED display for 6 - 12 V DC, 0.31 - 0.95 mA
with LED display for 12 - 30 V DC, 0.31 - 0.95 mA

Accessories		
ST 4-FSI/C	3036372	50
ST 4-FSI/C-LED 12	3036495	50
ST 4-FSI/C-LED 24	3036505	50
UK 6-FSI/C	3118203	50
UK 6-FSI/C-LED12	3001925	50
UK 6-FSI/C-LED24	3001938	50
PT 6-FSI/C	3212166	50
PT 6-FSI/C-LED 12	3212169	50
PT 6-FSI/C-LED 24	3212172	50

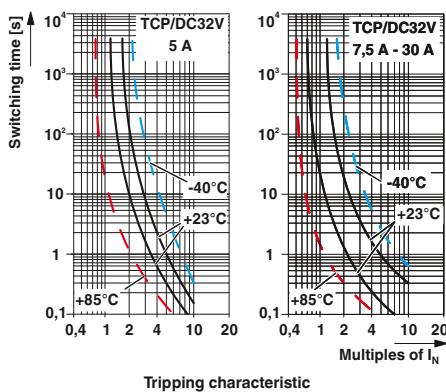

TCP thermal circuit breakers

- The reclosable thermal circuit breaker is available in nine nominal current levels ranging from 0.25 to 10 A
- The integrated switching function enables immediate reclosure and thus ensures the availability of the system
- Compact design
- A version with screw or spring-cage connection is used as a basic terminal block
- Potential distribution possible by means of bridges

Notes:
1) If the fuse is faulty, the downstream circuit is not off load.
When mounted in rows, the nominal device current can be limited to just 80% or must be oversized accordingly.
For further technical data, drawings, and accessories, and a complete data sheet, please visit phoenixcontact.net/products.



Can be plugged into a fuse terminal block

CE, RoHS, REACH, ENEC
Total width 8.2 mm

Electrical data
Rated voltage
Rated voltage
Nominal current I_N
Disconnection
Switch-off time
Fuse type
Rated short-circuit switching capacity I_{cn}
General data
Dimensions W/H/D
Ambient temperature (operation)
Degree of protection

Technical data		
IEC	UL / CUL	CSA
250 V AC	-	-
65 V DC	-	-
Depends on the product variant selected		
See tripping characteristic		
Slow-blow		
-		
8.2 mm / 64 mm / 88.5 mm		
-20°C ... 60°C		
IP40 (Actuation area)		

Description	Nominal current
Thermal miniature circuit breaker , can be plugged into UK 6-FSI/C or ST 4-FSI/C fuse terminal block	
	0.1 A
	0.25 A
	0.5 A
	1 A
	2 A
	3 A
	4 A
	6 A
	8 A
	10 A

Ordering data		
Type	Order No.	Pcs./Pkt.
TCP 0,1A	0712107	20
TCP 0,25A	0712123	20
TCP 0,5A	0712152	20
TCP 1A	0712194	20
TCP 2A	0712217	20
TCP 3A	0712233	20
TCP 4A	0712259	20
TCP 6A	0712275	20
TCP 8A	0712291	20
TCP 10A	0712314	20

Fuse terminal block , with spring-cage connection, max. nominal current of 30 A, for mounting on NS 35...
with LED display for 12 V DC, 1.7 mA ¹⁾
with LED display for 24 V DC, 1.9 mA ¹⁾
Fuse terminal block , with screw connection, max. nominal current of 30 A, for mounting on NS 35...
with LED display for 12 V DC, 1.7 mA ¹⁾
with LED display for 24 V DC, 1.9 mA ¹⁾
Fuse terminal block , with Push-in connection, max. nominal current of 25 A, for mounting on NS 35...
with LED display for 6 - 12 V DC, 0.31 - 0.95 mA
with LED display for 12 - 30 V DC, 0.31 - 0.95 mA
with LED display for 24 - 48 V DC, 0.31 - 0.95 mA

Accessories		
Type	Order No.	Pcs./Pkt.
ST 4-FSI/C	3036372	50
ST 4-FSI/C-LED 12	3036495	50
ST 4-FSI/C-LED 24	3036505	50
UK 6-FSI/C	3118203	50
UK 6-FSI/C-LED12	3001925	50
UK 6-FSI/C-LED24	3001938	50
PT 6-FSI/C	3212166	50
PT 6-FSI/C-LED 12	3212169	50
PT 6-FSI/C-LED 24	3212172	50
PT 6-FSI/C-LED 48	3212175	50

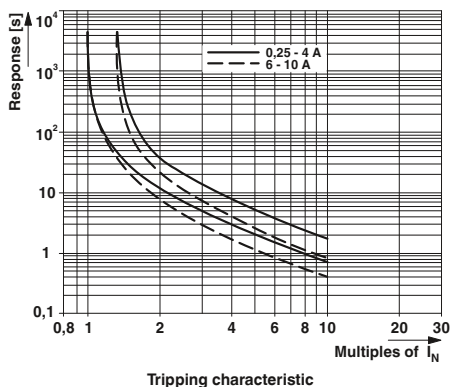

Installation notes for surge protective devices

General information

The “Installation notes for electricians” must be observed when installing and operating surge protective devices (SPDs). Installation, startup, and periodic inspections of surge protective devices may only be carried out by appropriately qualified specialist personnel. The relevant country-specific regulations must be observed.

Connecting surge protective devices

Some surge protective devices can be connected with the “branch wiring” connection method as well as the “V-wiring” connection method.

The required conductor cross section for the connection of surge protective devices depends on the selected connection method and the overcurrent protective devices. The installation notes for surge protective devices therefore contain detailed tables with cross section data for the conductors.

Detailed information regarding the maximum permissible backup fuse is provided for every surge protective device based on the connection method. The tables in the installation notes also contain information indicating whether additional F2 fuses are required.

All surge protective devices must be connected to the PE rail (or grounding rail) using at least one PE conductor. For surge protective devices to achieve an optimum level of protection, the connecting cables to the protected circuit and the corresponding PE rail (or grounding rail) should be as short as possible and have the lowest possible impedance.

The protective effect is further increased if the surge protective device is connected to metal conductive and grounded parts in the respective control cabinet via the shortest possible route using an additional PE conductor. Housing or structural parts

of low-voltage control cabinets (switchgear and controlgear assemblies) can also be used for this, which satisfy the requirements for protective conductors that are set out in DIN VDE 0100-540.

Grounding of equipment

Protection class I equipment has a PE connection. This equipment must be connected to the PE conductor of the protected circuit.

Some equipment for MCR technology, IT, and telecommunications has a PE connection or a connection for the functional ground conductor. This equipment is often connected to grounded metal parts. In addition, it must be connected to the PE connection of the associated surge protective device via the shortest possible route. For multi-stage surge protective devices, the PE connection on the side of the surge protective device marked “OUT” (protected) is used for this (see figure: ground connection).

For surge protective devices that only have a DIN rail contact, the grounding cable coming from the equipment is connected to the grounded DIN rail of the surge protective device.

Equipotential bonding

Overvoltages of any kind can cause dangerous voltage differences. The voltage differences within electrical systems and between conductive (accessible) parts should be as low as possible. This is why standards require equipotential bonding systems to be set up on a cross-plant basis and conductive (accessible) parts to be integrated into the equipotential bonding. Equipotential bonding systems that are set up incorrectly can reduce the protective effect of surge protective devices. Surge protective devices can only provide optimum protection in conjunction with an equipotential system that has been properly implemented in compliance with standards.

Cable routing

Cables on which transient surge currents or transient surge voltages can occur are referred to as “unprotected cables”. “Protected cables” are cables for which safety precautions have been taken against surge currents and surge voltages. To prevent capacitive or inductive interference, protected cables must not be laid directly parallel to unprotected cables. Interference from unprotected cables can be reduced effectively by maintaining an appropriate distance or implementing suitable shielding measures.

If the crossing of unprotected and protected cables is unavoidable, the cables should always cross at a right angle. When it comes to planning cabling systems, the professional installation of cables, and the physical separation and shielding between unprotected and protected cables, the relevant basic electrical engineering standards must be observed along with lightning protection and EMC standards.

Installation direction of surge protective devices

Some surge protective devices for MCR technology, IT, and telecommunications contain multi-stage protective circuits. These surge protective devices are marked “IN” (unprotected) and “OUT” (protected). To enable multi-stage surge protective devices to provide optimum protection, the installation direction must be observed. Unprotected cables (i.e., conductors where surge voltages or surge currents are expected) are connected to the “IN” (unprotected) side of a surge protective device. Those cables (and equipment) to be protected against surge voltages and surge currents are connected to the “OUT” (protected) side of a surge protective device. The shorter the distance between the surge protective device and the equipment to be protected, the better the protective effect.

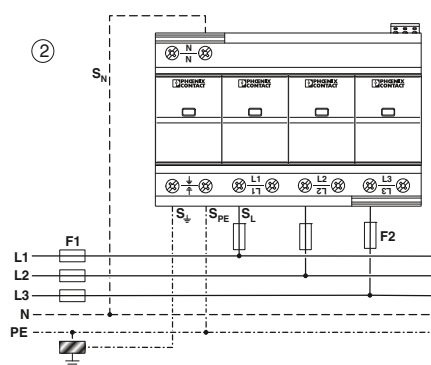

Application example ②
Type 1 surge protective device for protecting three-phase TN/TT systems with 5 conductors; connected in branch wiring

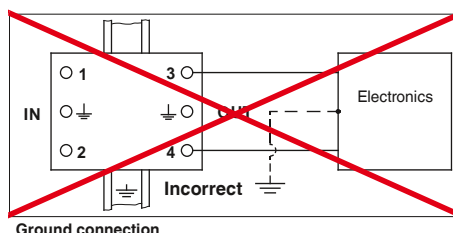
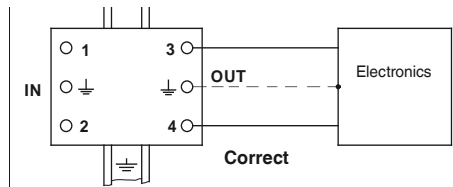

Ground connection

Follow current extinguishing capability

During normal operation of electrical systems, surge protective devices are in the high-impedance state (megaohm range). When overvoltages occur, surge protective devices switch to the low-impedance state (milliohm range). After an overvoltage abates or a surge current is transmitted, surge protective devices must automatically return to a high-impedance level. In addition, surge protective devices must automatically extinguish follow currents that occur – without the aid of upstream overcurrent protective devices (fuses, miniature circuit breakers). Surge protective devices must therefore be selected so that the follow current extinguishing capability is high enough for the intended installation location.

Various surge protection components are used in surge protective devices. Varistors and suppressor diodes are free of follow current. In the case of spark gaps and gas discharge tubes (GDTs), follow currents may form depending on the general technical conditions in question.

In energy systems, type 1 lightning current arresters with spark gaps are commonly used as the first protection stage. Further developments in the field of spark gap technology have made it possible to improve the operating characteristics of spark gaps to such an extent that follow-current-free spark gaps now represent state-of-the-art technology. Follow-current-free spark gaps can also be used in power supply systems with high prospective short-circuit currents, without any danger of follow currents forming after surge voltages or surge currents have been discharged.

Gas discharge tubes have a very limited capacity for extinguishing follow currents. This is why gas discharge tubes are predominantly used between conductors where the voltage difference is only very small. In low-impedance grounded energy circuits, gas discharge tubes are predominantly used between N and PE, but not on their own between L and N or L and PE. In circuits for MCR technology, IT, and telecommunications applications, voltages and short-circuit currents are often so low that gas discharge tubes can also be used between any conductors.

Maximum permissible backup fuses

Detailed information regarding the maximum permissible backup fuse is provided by the manufacturer for almost every surge protective device. The value of this fuse is based on the fuse that was used for the type testing of the surge protective device (in accordance with DIN EN 61643). In energy systems, fuses that have a nominal current value lower than the nominal current value for the “maximum permissible backup fuse” are usually selected. When it comes to the selection of backup fuses, the system planner should always be consulted. This means that – depending on the actual installation location – a fuse with sufficiently high impulse durability can be selected, whose tripping behavior is also selective in relation to upstream overcurrent protective devices. Based on the selected fuse, suitable conductor cross sections must be selected for the connection of surge protective devices.

Surge protective devices with integrated overcurrent protective device

Detailed information regarding the maximum permissible backup fuse is not provided for surge protective devices with integrated overcurrent protective device (fuse, miniature circuit breaker). Instead, the maximum permissible short-circuit current at the installation location is specified.

In addition, detailed information regarding suitable conductor cross sections for the connection of surge protective devices is provided.

Testing surge protective devices

Many surge protective devices from Phoenix Contact are pluggable and can be tested. They consist of a base element and a pluggable protective component. This enables convenient and informative electrical testing as part of regular maintenance activities. The protective component can also be replaced quickly in the event of a fault.

To achieve high system availability, system operators must regularly inspect and maintain their electrical system. Regular testing and maintenance is required by legislators, supervisory authorities, and professional associations based on the system type.

Lightning protection systems consist of external and internal lightning protection. Specialist knowledge is required in order to carry out professional testing of lightning protection systems. For this reason, various standards require this testing to be carried out by a lightning protection expert. The testing of lightning protection systems includes the testing of surge protective devices. Electrical testing is required in order to reliably assess whether surge protective devices are functioning properly. The CHECKMASTER 2 test device enables comprehensive and fully automated electrical testing of pluggable surge protective devices and standard-compliant documentation of the test results.

General installation notes

Surge protection components

General information

All surge protective devices (SPDs) contain surge protection components. A distinction is made between voltage-switching and voltage-limiting components. Spark gaps and gas discharge tubes (GDTs) are voltage-switching components. Varistors and suppressor diodes are voltage-limiting components.

Suppressor diodes

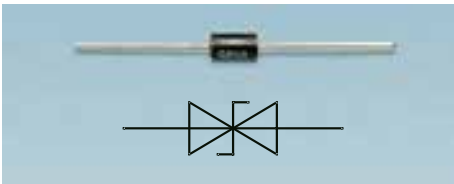

Suppressor diode

Suppressor diodes are semiconductor components with PN junctions that have a large cross-sectional area. Their operating behavior is also non-linear and dependent on the voltage. Suppressor diodes with bidirectional characteristic curves are commonly used in surge protective devices. However, suppressor diodes with a unidirectional characteristic curve are also used.

Suppressor diodes are predominantly used in surge protective devices for MCR technology, IT, and telecommunications. Due to their relatively low stray capacitance, suppressor diodes are also suitable for circuits with high-frequency signals (into the MHz range).

When it comes to the characteristic curves of suppressor diodes, a distinction is made between the following characteristics:

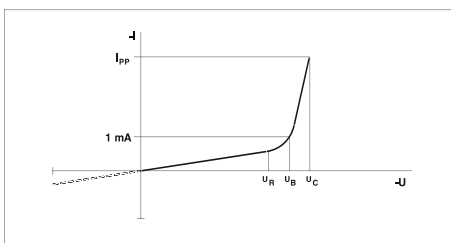

U/I characteristic curve of a suppressor diode

Explanation:

- U_R = Reverse voltage
- U_B = Breakdown voltage
- U_C = Clamping voltage
- I_{pp} = Surge current pulse
- I_R = Reverse current

- The reverse voltage U_R of a suppressor diode is the highest voltage that the diode can safely block.
- A current of 1 mA flows through the suppressor diode at the breakdown voltage U_B . Above the breakdown voltage U_B , the operating range starts in which the suppressor diode limits overvoltages effectively.
- The maximum clamping voltage U_C is the highest voltage which can occur at the suppressor diode in the event of a surge current pulse I_{pp} (10/1000) μ s.

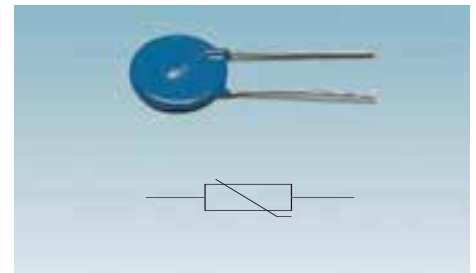

Disc varistor

Varistor-based surge protective devices can be used in type 1, type 2, and type 3 surge protective devices. Unlike suppressor diodes, varistors have a comparatively high stray capacitance. Due to their relatively high stray capacitance, varistors are not suitable for circuits with high-frequency signals. Varistors are mainly used to provide surge protection for (low-frequency) energy circuits.

If varistors encounter frequently reoccurring surge voltage or surge current pulses, they age faster. Temporary overvoltages can also cause premature aging. The effects of aging can cause varistors to allow leakage currents to flow through. Leakage currents can cause varistors to heat up. To prevent an impermissibly high temperature rise, varistor-based surge protective devices in energy circuits are equipped with thermal disconnect devices as a general rule. The disconnect device disconnects the varistor from the supply voltage when a defined limit temperature is exceeded.

Varistors

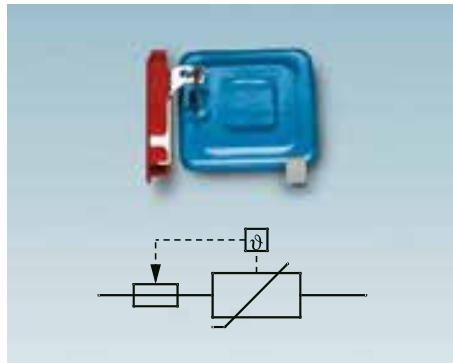

Block varistor with thermal disconnect device

Varistors (variable resistors) are voltage-dependent resistors with very non-linear operating behavior. The disc-shaped components are produced from powdery metal oxide granules in a sintering process. The PN junctions form during the sintering process on the surface of the metal oxide granules. The nominal voltage of a varistor disc depends on the thickness of the actual varistor disc. The surge current discharge capacity essentially depends on the surface area of the varistor disc. A high discharge capacity for surge currents is achieved by varistor discs with a large surface area or by varistor discs that are connected in parallel.

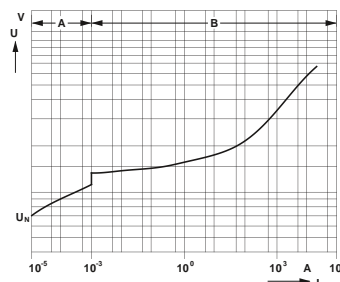

U/I characteristic curve of metal oxide varistors

Explanation:

- A = High-impedance operating range
- B = Low-impedance operating range/threshold range

Gas discharge tubes (GDTs)

Gas discharge tubes are voltage-switching components.

They usually have two or three electrodes. The electrodes are arranged in a hermetically encapsulated ceramic or glass tube. The space between the electrodes is filled with inert gas (e.g., argon, neon).

When the strike voltage is reached, a gas discharge tube immediately switches

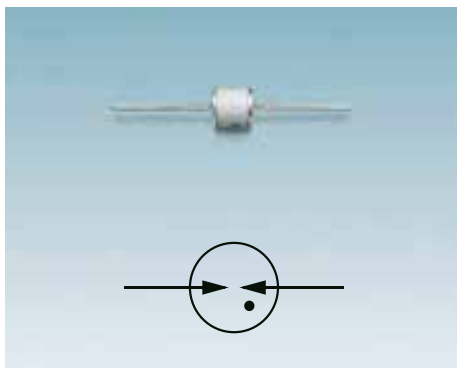

Gas discharge tube

from the high-impedance state to the low-impedance state. The strike voltage is not a constant voltage value. It depends on the rate of rise of the voltage at the electrodes of the gas discharge tube. The lowest strike voltages are reached at DC voltage and at voltages with a low rate of rise (static response behavior). Overvoltages with a fast rate of rise result in a delayed response and an increased strike voltage (dynamic response behavior).

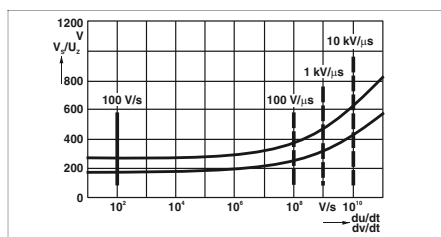

Ignition curve of a gas discharge tube
 — Static response behavior
 - - - Dynamic response behavior

Following “ignition”, an electric arc forms between the electrodes of the gas discharge tube. Most gas discharge tubes for protecting low-voltage systems have an electric arc voltage in the voltage range between 10 and 30 V DC. Due to the relatively low electric arc voltage, the follow current extinguishing capability of gas discharge tubes is relatively low. This is why they must not be used on their own between L-N or L-PE in AC power supply systems. The series connection of a gas discharge tube and a varistor is suitable for use between L-N and between L-PE.

The discharge capacity of gas discharge tubes is highly scalable and is based on the size of the electrode and housing. This is why gas discharge tubes are used in type 1 surge protective devices, as well as type 2 and type 3 surge protective devices.

Spark gaps

Spark gaps are voltage-switching components. They usually consist of an arrangement of two (main) electrodes or the series connection of several individual electrodes. Triggered spark gaps include additional trigger circuits and auxiliary electrodes, where appropriate. Unlike gas discharge tubes, spark gaps are not hermetically encapsulated, but are usually partially encapsulated. The space between the electrodes is filled with ambient air. When overvoltages are discharged or surge currents transmitted, hot ionized gases are produced inside spark gaps. The ionized gases are cooled down by the partial encapsulation of the spark gaps. Controlled pressure equalization with the ambient atmosphere is possible.

Spark gaps have a high or even very high discharge capacity for surge currents. They can transmit high-energy lightning currents in a non-destructive way. This is why spark gaps are predominantly used as type 1 lightning current arresters in energy circuits.

Modern spark gaps are usually equipped with a trigger circuit. By using trigger circuits, it is possible to achieve controlled response behavior and a low voltage protection level. The voltage protection level of modern triggered spark gaps is so low that effective protection can be provided for sensitive electronic equipment.

These days it is possible to influence the response behavior and operating behavior of spark gaps in a targeted manner. This allows varistor-based type 2 surge protective devices to be installed directly parallel to triggered type 1 spark gaps. An additional decoupling distance is not required.

When it comes to modern spark gaps, the electric arc voltage is so high that

follow currents are limited effectively or even prevented completely. Line-follow-current-free spark gaps can therefore be used in AC systems with follow currents of up to 100 kA (RMS), for example. This makes it easy to use spark gaps in power supply systems with high prospective short-circuit currents.



Spark gaps

Decoupling elements

Multi-stage surge protective devices for MCR technology, IT, and telecommunications often contain decoupling elements between the individual protection stages. As a rule, ohmic resistors are used as decoupling elements. The operating currents flowing through the resistors must not exceed the nominal current value for the maximum permissible backup fuse of the surge protective device. Where necessary, appropriate measures must be taken to protect surge protective devices with decoupling elements against overcurrents or short-circuit currents.

Explanation of terms

Arc voltage U_{bo}

The instantaneous value of the voltage on a discharge path (arc discharge) during an arcing process.

Arrester

Arrester is an old term, see "Surge protective device (SPD)"

Associated equipment

Electrical device that contains both intrinsically safe and non-intrinsically safe circuits and is designed in such a way that the non-intrinsically safe circuits cannot adversely affect the intrinsically safe circuits.

– Source: DIN EN 60079-11

Asymmetrical voltage, common mode voltage

The voltage between each conductor and a specified reference point, usually reference ground or reference frame.

– Source: IEC 161-04-09

Burst of pulses or oscillations

A sequence of a limited number of distinct pulses or an oscillation of limited duration.

– Source: DIN EN 61000-4-4

Combined surge

Pulse that is characterized by a specific peak voltage value (U_{OC}) and waveform in the off-load state, and by a specific peak current value (I_{CW}) and waveform in the short-circuit state.

Note 1: The peak voltage value, the peak current value, and the waveform with which a SPD is tested depend on the internal resistance of the hybrid generator Z_f and the impedance of the test object.

Note 2: The internal resistance of hybrid generators for testing type 2 SPDs is 2 ohms.

– Source: DIN EN 61643-11

Coupling

Interaction between circuits, in which energy is transferred from one circuit to the other.

– Source: DIN EN 61000-4-4

Degradation in performance

An undesired departure in the operational performance of any device, equipment or system from its intended performance.

Note: The term "degradation" can apply to temporary or permanent failure.

– Source: DIN EN 61000-4-4

Direct lightning strike

Lightning strike impacting directly a component of the network.

Note: Examples of components of the network are: conductor, tower, substation equipment, etc.

– Source: IEC 614-03-39

Discharge of static electricity, electrostatic discharge (ESD)

Transfer of electric charge between bodies of different electric potential in proximity or through direct contact.

Disturbance variable

Electromagnetic phenomenon that can degrade the performance of a device, equipment or system, or adversely affect living or inert matter.

– Source: IEC 161-01-05

Electrical fast transient/burst (EFT/B)

Fast transient electrical disturbance variable/burst.

– Source: DIN EN 61000-4-4

Electrically skilled person

An electrically skilled person is someone who, because of their professional training, skills, experience, and their knowledge of relevant standards, can assess any required operations and recognize any possible dangers.

Note 1: When considering a person's professional training, several years' experience in the relevant field can also be taken into account.

Note 2: The German legislature entrusts social security institutions (e.g., DGUV, German Social Accident Insurance Institutions) to provide mandatory regulations for "safe working".

– Source: DIN VDE 0100-200, DIN VDE 0105-100

Electromagnetic compatibility (EMC)

Ability of equipment or a system to function satisfactorily in its electromagnetic environment without introducing intolerable electromagnetic disturbances to anything in that environment.

– Source: DIN EN 61000-1-2

Electromagnetic disturbance

Any electromagnetic phenomenon which may degrade the performance of equipment, a transmission channel or system.

Electromagnetic environment

Totality of electromagnetic phenomena existing at a given location.

– Source: DIN EN 61000-1-2

Electromagnetic interference (EMI)

Degradation of the performance of equipment, a transmission channel or system caused by an electromagnetic disturbance; such as a malfunction or failure of an item of electrical or electronic equipment.

Emitter

Device, equipment or system which gives rise to voltages, currents or electromagnetic fields that can act as electromagnetic disturbances.

Note: An emitter can be natural or artificial in origin.

– Source: IEC 161-01-23

Equipment to be protected

All equipment within a physical structure or an area which requires surge protection/lightning protection.

Equipotential bonding

In order to achieve equipotentiality, electrical connections must be established between conductive parts.

– Source: DIN VDE 0100-200

Equipotential bonding conductor

Electrically conductive connections used to create equipotential bonding.

– Source: DIN VDE 0100-200

Equipotential bonding strip

Strip that is part of the equipotential bonding system, used for the electrical connection of a number of conductors for the purpose of equipotential bonding.

– Source: DIN VDE 0100-200

Equipotential bonding system

Interconnection of conductive parts providing equipotential bonding between those parts.

– Source: DIN VDE 0100-200

External lightning protection

External lightning protection is part of a lightning protection system consisting of an air termination system, a down conductor system, and a grounding arrangement.

– Source: DIN EN 62305-1

Follow current extinguishing capability I_{fi}

Prospective short-circuit current that can be independently interrupted by the SPD without resulting in disconnection.

Note:

According to installation standard HD 60364-5-534, I_{fi} must be equal to or greater than I_{SCCR} .

– Source: DIN EN 61643-11

Follow current I_f

Peak current value supplied by the electrical power system and flowing through the SPD after a discharge process.

– Source: DIN EN 61643-11

Ground conductor

Conductor which provides a conductive path, or part of the conductive path, between a given point in a network, system or equipment and a ground-electrode network.

– Source: DIN VDE 0100-200

Ground electrode

A ground electrode is a conductive part, which may be embedded in a specific conductive medium, e.g., concrete or coke, in electric contact with the Earth.

– Source: DIN VDE 0100-200

Conductive part or group of conductive parts in intimate contact with and providing an electrical connection to ground.

– Source: EN 61557-1

Ground flash

Electrical discharge originating from the atmosphere between a cloud and the ground, consisting of a single lightning stroke component or several lightning stroke components.

– Source: DIN EN 62305-1

Ground, local ground

Part of the Earth which is in electric contact with a ground electrode and the electric potential of which is not necessarily equal to zero.

– Source: DIN VDE 0100-200

Grounding

Making an electric connection between a given point in a network, system or in equipment and a local ground.

– Source: DIN VDE 0100-200

Grounding arrangement

Part of the external lightning protection system which discharges lightning current to ground and then distributes it from there.

– Source: DIN EN 62305-1

All the electrical connections and devices involved in the grounding of a network, system or equipment.

– Source: IEC 195-02-20

Grounding system

Overall system comprising the grounding arrangement and the equipotential bonding network.

– Source: DIN EN 62305-4

Immunity

The ability of a device, equipment or system to perform without degradation in the presence of an electromagnetic disturbance variable.

– Source: DIN EN 61000-4-4

Impulse withstand voltage

Highest peak value of impulse voltage of prescribed form and polarity which does not cause disruptive discharge of insulation under specified conditions.

Note 1:

The impulse withstand voltage is equal to or greater than the rated surge voltage.

Note 2:

A 1.2/50 μ s surge voltage pulse is used to test the surge withstand capability.

– Source: DIN EN 60664-1

Indirect lightning strike

Lightning strike that does not impact directly any part of the network but that induces an overvoltage in that network.

– Source: IEC 614-03-40

Insertion loss

Attenuation resulting from the insertion of the surge protective device into a transmission system. The attenuation is the ratio of the power delivered to that part of the system following the surge protective device, before insertion of the surge protective device, to the power delivered to that same part of the system after insertion of the surge protective device. The insertion loss is generally expressed in decibels (dB).

– Source: DIN EN 61643-21

Insulation coordination

Mutual correlation of insulation characteristics of electrical equipment taking into account the expected micro-environment and other influencing stresses.

– Source: DIN EN 60664-1

Interference suppression

Measure to reduce or avoid the electromagnetic disturbance variables that occur.

Interference voltage

Voltage produced between two points on two separate conductors by an electromagnetic disturbance variable, measured under specified conditions.

– Source: IEC 161-04-01

Internal lightning protection

Part of the lightning protection system consisting of lightning equipotential bonding and/or electrical insulation of external lightning protection.

– Source: DIN EN 62305-1

Intrinsically safe circuit

Circuit, in which any spark or any thermal effect produced in the conditions specified in this standard, including normal operation and specified fault conditions, is not capable of causing ignition of a given explosive gas atmosphere.

Intrinsically safe equipment

An electrical device in which all circuits are intrinsically safe.

– Source: DIN EN 60079-11

Lightning equipotential bonding (EB)

Equipotential bonding to the LPS of separated metal parts, by direct connection or connection via surge protective devices, to reduce potential differences caused by lightning current.

– Source: DIN EN 62305-1

Lightning overvoltage

Transient overvoltage at any point of the system due to a specific lightning discharge.

– Source: DIN EN 60664-1

Transient overvoltage at any point of the system due to a direct lightning strike or an indirect lightning strike.

– Source: IEC 442-09-12

Lightning protection (LP)

Complete system used to protect physical structures – including their internal systems and contents and any persons inside – against the effects of lightning. This generally consists of the lightning protection system (LPS) and safety precautions against LEMP (SPM).

– Source: DIN EN 62305-1

Lightning protection system (LPS)

Complete system used to reduce physical damage to a structure due to direct lightning strikes.

Note: A lightning protection system consists of both external and internal lightning protection.

– Source: DIN EN 62305-1

Lightning strike near a physical structure

Lightning that strikes so close to a physical structure that is to be protected that it can generate dangerous overvoltages.

– Source: DIN EN 62305-1

Lightning strike to a physical structure

Lightning that directly strikes a physical structure that is to be protected.

– Source: DIN EN 62305-1

Lightning surge current I_{imp}

Current peak value of a discharge surge current through a SPD with a specified charge Q and specified energy W/R in a specified time.

Note: Pulse shape 10/350

– Source: DIN EN 61643-11

Maximum continuous operating voltage U_C

Maximum r.m.s. value of the voltage that can continuously be applied to the mode of protection of the SPD.

Note: The value for U_C , which falls within the scope of this standard, can exceed 1000 V.

– Source: DIN EN 61643-11

Explanation of terms

Maximum discharge surge

current I_{\max}

Peak current value flowing through the SPD with pulse shape 8/20 and amplitude corresponding to the manufacturer's information. I_{\max} is equal to or greater than I_n .

– Source: DIN EN 61643-11

Mode of protection

Intended current path between the connection terminal blocks which includes one or more protective elements, e.g., between:

- The conductors
 - Conductor to ground
 - Conductor to neutral
 - Neutral to ground
- Source: DIN EN 61643-11

Nominal discharge current I_n

Peak current value flowing through the SPD with pulse shape 8/20 μs .

– Source: DIN EN 61643-11

Nominal load current I_L , nominal current I_N

Maximum r.m.s. value of the nominal current, which can flow to an ohmic load that is connected to the protected output of the SPD.

– Source: DIN EN 61643-11

Off-load voltage U_{oc}

Off-load voltage of the hybrid generator at the test object terminal point.

– Source: DIN EN 61643-11

Overvoltage

Any voltage having a peak value exceeding the corresponding peak value of maximum steady-state voltage at normal operating conditions.

– Source: DIN EN 60664-1

Overvoltage category

Numeral defining a transient overvoltage condition.

– Source: DIN EN 60664-1

Potentially susceptible equipment

Device, equipment or system whose performance can be degraded by an electromagnetic disturbance.

Note: Influence on function may be in the form of:

- Functional disturbance
- Reduction in function
- Malfunction
- Failure

– Source: IEC 161-01-24

Protected equipment

Equipment within a physical structure that is protected by lightning protection/surge protection measures.

– Source: DIN EN 62305-4

Pulse

An abrupt variation of short duration of a physical quantity followed by a rapid return to the initial value.

– Source: IEC 161-02-02

r.m.s. withstand voltage

Highest r.m.s. value of a voltage which does not cause disruptive discharge of insulation under specified conditions.

– Source: DIN EN 60664-1

Rated surge voltage, rated impulse withstand voltage U_w

Impulse withstand voltage value assigned by the manufacturer to the equipment or to a part of it, characterizing the specified withstand capability of its insulation against overvoltages.

Note: For the purposes of this standard, only the impulse withstand voltage between conductor and ground is considered.

– Source: DIN EN 62305-1,
DIN EN 60664-1

Residual current device (RCD)

A switching device or associated devices designed to disconnect from the electrical power system when the leakage current or residual current exceeds a given value under specified conditions.

– Source: DIN EN 61643-11

Residual voltage U_{res}

Peak voltage value that occurs while discharge surge current is flowing via the connection terminal blocks of the SPD.

– Source: DIN EN 61643-11

Separation distance

Distance between two conductive parts at which no dangerous sparking can occur.

– Source: DIN EN 62305-3

Short-circuit current I_{CW}

Prospective short-circuit current of the hybrid generator at the test object terminal point.

Note: When a SPD is connected to the hybrid generator, current lower than I_{CW} flows through the test object.

– Source: DIN EN 61643-11

Short-circuit current rating I_{SCCR}

Maximum prospective short-circuit current of the electrical network for which the SPD is rated in conjunction with its specified disconnect device.

– Source: DIN EN 61643-11

Sparkover voltage of a voltage-switching SPD

The sparkover voltage or the strike voltage is the highest voltage value at which the impedance of a voltage-switching SPD abruptly decreases.

– Source: DIN EN 61643-11

SPD disconnect device

Device for disconnecting a SPD or part of a SPD from the electrical power system in the event of a SPD failure.

Note: This device does not need to have insulating properties. It is supposed to prevent a permanent fault in the system and is used to indicate a SPD failure.

Disconnect devices can be implemented internally (integrated) or externally (in accordance with the manufacturer's specifications). More than one disconnect device can be used, e.g., an overcurrent disconnect device and a thermal disconnect device.

These functions can be performed in a single unit or in separate units.

– Source: DIN EN 61643-11

Spike

A unidirectional pulse of relatively short duration.

– Source: IEC 161-02-04

Status indicator

Device that indicates the operating state of a SPD or part of a SPD.

– Source: DIN EN 61643-11

Surge current (10/350) μs

Surge current pulse (lightning current pulse) with a virtual rise time of 10 μs and a decay time to half-value of 350 μs .

– Source: IEC 62305-1

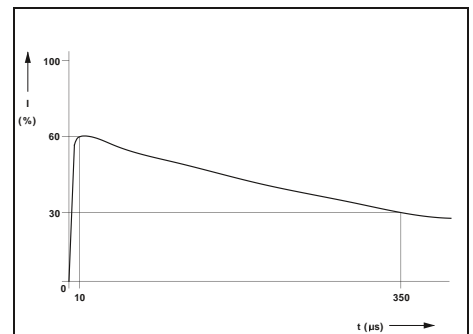

10/350 μs surge current pulse in acc. with IEC 60060-1

Surge current (8/20) μs

Surge current pulse with a virtual rise time of 8 μs and a decay time to half-value of 20 μs .

– Source: IEC 60060-1

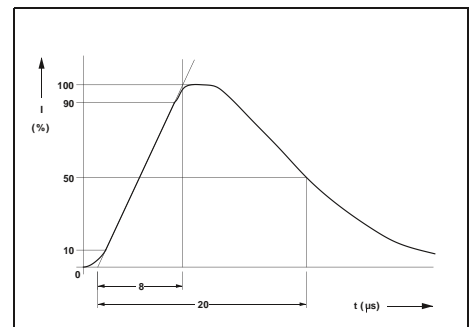

8/20 μs surge current pulse in acc. with IEC 60060-1

Surge protective device (SPD)

Device intended to limit transient overvoltages and divert surge currents. Contains at least one non-linear voltage-limiting component.

– Source: DIN EN 61643-11, DIN EN 62305-4

Safety equipment that contains at least one non-linear component and is intended to limit overvoltages and divert pulse currents.

– Source: DIN VDE 0100-534

Surge voltage (1.2/50) μ s

Surge voltage pulse with a virtual rise time of 1.2 μ s and a decay time to half-value of 50 μ s.

– Source: IEC 60060-1

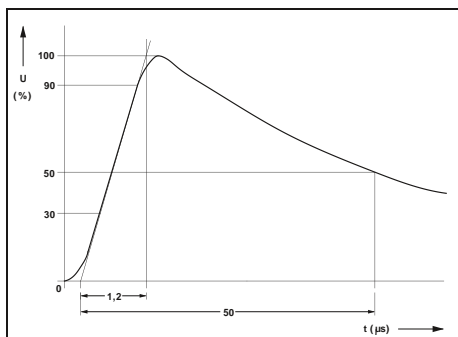

1.2/50 μ s surge voltage pulse in acc. with IEC 60060-1

Switching overvoltage

Transient overvoltage at any point of the system due to a specific switching operation or fault.

– Source: DIN EN 60664-1

Symmetrical voltage, differential mode voltage

The voltage between any two of a specified set of active conductors.

– Source: IEC 161-04-08

Temporary overvoltage (TOV)

Overvoltage at power frequency of relatively long duration.

– Source: DIN EN 60664-1

Total discharge surge current I_{total}

Current that flows through the ground connection of a multi-position SPD when testing the total discharge surge current.

Note 1: This test is performed to examine the total loads that occur when current simultaneously flows through several modes of protection of a multi-position SPD.

Note 2: I_{total} is of particular significance for test classification I SPD types which are used for the purpose of lightning equipotential bonding in accordance with the IEC 62305 series of standards.

– Source: DIN EN 61643-11

Total grounding resistance R_A

Resistance between the main grounding terminal or grounding rail and ground.

– Source: EN 61557-1

Transient overvoltage

Overvoltage with a duration of a few milliseconds or less, oscillatory or non-oscillatory, usually highly damped.

– Source: IEC 614-03-14

Transient

Irregular and relatively short positive and/or negative voltage or current changes between two steady states.

Transient

Pertaining to or designating a phenomenon or physical quantity which varies between two consecutive steady states during a time interval short compared to the timescale of interest.

– Source: DIN EN 61000-4-4

Voltage protection level U_p

Maximum voltage that can occur at the connection terminal blocks of the SPD while loaded with a pulse of specific voltage steepness and a discharge surge current of specified amplitude and waveform.

Note: The voltage protection level is part of the manufacturer's information. The voltage protection level must not be exceeded by:

- The measured clamping voltage determined from the front-of-wave impulse sparkover voltage (if applicable) and the measured clamping voltage determined from the residual voltage measurement up to I_n and/or up to I_{imp} in accordance with test classification II and/or test classification I
 - The measured clamping voltage up to U_{OC} , determined with a hybrid pulse for test classification III
- Source: DIN EN 61643-11

Quality in quantity

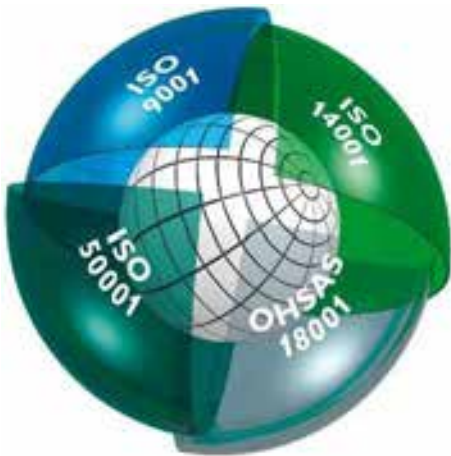

Integrated management system

The objective of the Phoenix Contact integrated management system is to integrate all requirements pertaining to products, processes, and the organization.

Statutory and regulatory requirements, as well as those of international standards and our customers, are met and, in some cases, even exceeded in all phases of the product lifecycle.

The Phoenix Contact management system is monitored by internationally recognized independent bodies each year to ensure that quality, environmental protection, energy efficiency, and occupational safety have been integrated in conformance with the relevant requirements. Certification in accordance with international standards ISO 9001, ISO 14001, ISO 50001, and BS OHSAS 18001 is the result of our corporate philosophy of meeting the needs of our customers, staff, and environment as best as possible. This serves as the basis for innovative products with the familiar high Phoenix Contact quality standard, actively practiced environmental protection through efficient production and products that conserve resources, and responsibility in the field of occupational health and safety. It goes without saying that we integrate all further requirements of standards, international approvals or special customer requirements into our company processes.

The result of this system is a building block for the success of the Phoenix Contact Group as well as its products and services.

CE marking

CE marking was introduced as an important instrument for the free movement of goods and services within the single European market. By applying the mark to a product, the manufacturer confirms its compliance with all EU directives applicable to this product. The EU directives describe the product characteristics with regard to device safety and the avoidance of risks. They have been incorporated in national legislation. Compliance with the requirements is a **condition for placing the product on the market within the EU.**

Where applicable, our products currently fall within the scope of the following directives in particular:

- 2014/35/EU Electrical equipment designed for use within certain voltage limits (Low Voltage Directive)
- 2014/30/EU Electromagnetic compatibility (EMC Directive)
- 2014/32/EU Measuring instruments
- 2006/42/EC Safety of machinery (Machinery Directive)
- 2014/34/EU Equipment and protective systems intended for use in potentially explosive atmospheres (ATEX Directive)
- 2014/53/EU Radio equipment (RED)
- 2011/65/EU Restriction of the use of certain hazardous substances (RoHS Directive)
- 2012/19/EU Waste electrical and electronic equipment (WEEE Directive)

The standards used as the basis for the aforementioned directives have been at the heart of our development standard for some time as a way of ensuring compliance with European directives. The numbers of the directives indicate their version at the time of publication. In the event of changes to directives and/or standards, our products will undergo conformity assessment again in good time and a new declaration of conformity will be issued promptly. The current declarations for each product can also be found in our download area.

Among the aforementioned European directives, the EMC Directive plays a particularly important role. It uses a directive enshrined in national legislation as the basis for defining electromagnetic compatibility as a fundamental device property. European legislation therefore places great emphasis

on the electromagnetic compatibility of devices and systems as a basic prerequisite for the error-free operation of machines and systems. As an international leader in the field of surge protection, Phoenix Contact has extensive expertise in EMC. This expertise and the experience gained over many years in the development and application of industrial interface and communication technology have resulted in an extremely high standard of quality for our products when it comes to electromagnetic compatibility. Our independent laboratory, Phoenix Testlab, was founded in order to share this expertise with other companies. Phoenix Testlab GmbH is an accredited service company, which carries out EMC testing in compliance with European standards. At Phoenix Testlab, devices are also tested with regard to their electrical safety, mechanical influences, and their behavior in relation to environmental influences. Phoenix Testlab is also a notified body in accordance with EMC Directive 2014/30/EU and Radio Equipment Directive (RED) 2014/53/EU. As a certification body (TCB, FCB, and RCB), Phoenix Testlab is also able to approve these products for the markets in the USA, Canada, and Japan.

Standards and regulations

All relevant standards and regulations are used as the basis for the development and maintenance of our products.

International standards are subject to continuous changes as a result of harmonization and new developments. In line with this process, the current version of all standards that are relevant to our products is documented in the product area on our website at phoenixcontact.net/products.

Online product information service on the world wide web

Phoenix Contact is continuously extending its product range.

Within the scope of our product monitoring obligation, all products are subject to an improvement process.

The Internet is an ideal platform to quickly communicate new product developments and improvements to the market.

You can quickly access the relevant Phoenix Contact website for your region via phoenixcontact.com. There you will always find an up-to-date overview of products, solutions, and services from Phoenix Contact. This includes technical documents such as data sheets and user manuals, current driver and demo software, and a direct link to the relevant contact person.

Touch protection

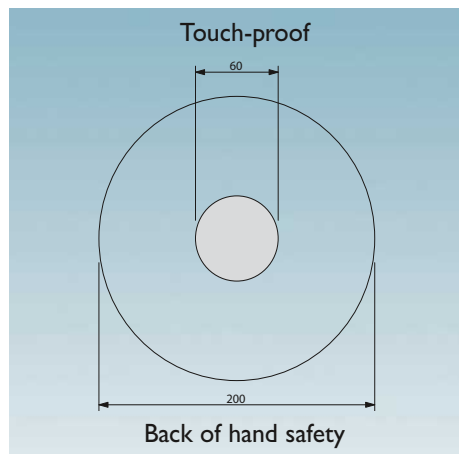

Example: pressure actuation



Touch-proof



Back of hand safety

The accident prevention regulations BGV A 2 issued by the German employer's liability insurance association for precision mechanics and electrical engineering apply to the operators of electrical systems and are aimed at the prevention of electrical accidents by means of special safety requirements.

These regulations contain specifications regarding the safety distances for work, operation, and occasional handling in the proximity of "live parts" in low-voltage systems up to 1000 V ~ or 1500 V –.

- Work with live parts is only permitted once they have been de-energized.

Operation in the proximity of live parts is only permitted if these parts are de-energized or are protected against direct contact (§ 6). The following safety measures apply when working in the proximity of live parts:

- Provision of the de-energized state for the duration of the work
- Ensure shock protection is in place in the form of covers or barriers during the work
- Assurance that proximity limits will not be violated (§ 7).

The term "occasional handling" has been introduced for the operation of elements such as pushbuttons, rocker arms or rotary buttons in the proximity of live parts.

According to VDE 0105-1, this is covered by "operation with partial protection against direct contact".

Detailed specifications for "occasional handling" can be found in DIN VDE 0106-100. This specifies to what degree live parts in the proximity of operating elements are to be protected against contact. The basis for this is the definition of a "protection area for occasional handling"; this is the area into which the user must reach in order to handle the machine.

The most important thing is that an area formed by an even envelope curve 30 mm in radius must surround the live parts. This area must be **touch-proof**, i.e., the live parts of the electrical device must not be within reach of the VDE test finger in accordance with IEC 60529/DIN VDE 0470-1 (test finger).

Back of hand safety is specified for the "rest of the area" up to 100 mm around the operating element. **Back of hand safety** means that when a force of 50 N is applied to a ball with a diameter of 50 mm, this does not come into contact with the live parts of the equipment. No special measures for ensuring contact safety are stipulated outside this area.

Note: systems and equipment that are operated with PELV up to 25 V ~ or 60 V – are considered to be protected against "direct contact".

According to § 5, Subsection 4 of the BGV A 2 regulations, there is no need to test the condition of the system prior to initial startup if the company has confirmation from the manufacturer or installer that the electrical systems and equipment conform to BGV A 2. The confirmation required relates to systems and equipment that have been installed and are ready for operation and can only be issued by the installer or installation company. The manufacturer of the electrical equipment can only issue a confirmation that products have been produced in accordance with the relevant electrotechnical DIN VDE regulations stipulated in BGV A 2. The installer must bear this in mind when selecting the equipment to be used.

In the field of connection technology, Phoenix Contact offers a wide range of products which are touch-proof or can be protected against contact by means of covers. Depending on the conditions, all of this must be taken into account when selecting the individual types of terminal blocks and accessories.

Quality features of insulating housings

Thermoplastics

The majority of our insulating housing is made from thermoplastic materials. Roughly speaking, these can be divided into amorphous and semi-crystalline substances. Thermoplastics are processed using the efficient and environmentally-friendly injection molding process. They have good recycling properties and can be re-used. We use many materials that are modified in different ways to meet the demanding requirements of electrical and electronic modules, devices, and systems with regard to their mechanical, thermal, and electrical properties.

Behavior of plastics under the influence of temperature (operating temperatures, mechanical influences)

Plastics undergo a process referred to as thermal aging when they are subjected to heat over long periods. This process causes changes in the mechanical and electrical properties of the material. External influences such as radiation and additional mechanical, chemical, and electrical stresses amplify this effect. Special tests on samples can yield characteristic data which provides a good means of drawing comparisons between different plastics. However, applying these characteristics to an evaluation of molded plastic parts is only possible to a limited extent, and can only give the designer a rough guide when it comes to selecting a plastic material. This catalog uses the following assessment criteria: the **RTI value** in accordance with UL746B/ANSI 746 B (elec. based on electric strength) and the **Ti value** in accordance with IEC 60216-1 (based on a 50% reduction in tensile strength after 20,000 hours).

IEC 60947-7-1/EN 60947-7-1 specifies a permissible temperature increase of 45 K for terminal blocks under nominal load. Phoenix Contact terminal blocks satisfy this requirement.

The properties of plastics are not only affected by the influence of heat as described above; they also undergo changes as a result of cold influences. When subjected to cold as well as low levels of humidity, plastics become increasingly brittle with the result that they are no longer capable of withstanding the same mechanical loads. As the table on the right shows, the plastics concerned can be used down to a temperature of -40°C, but only without a mechanical load. As far as the products presented in the catalog are concerned, it is the ambient temperature specified in each case that is to be regarded as definitive for operation. Regardless of the plastics used, this may be subject to further restrictions (e.g., limited to -20°C) as a result

of the components used or other restrictive parameters.

At very low temperatures, this means that any form of mechanical load on the plastic components must be avoided (e.g., mounting of products on/removal of products from the DIN rail, actuation of terminal points, locking/ejection of relays from bases, prizing out of plug-in bridges, bending of cables and lines, etc.), as there is always an associated risk of damage. Unless otherwise indicated, it is recommended that you carry out the specified mounting/operational tasks in a temperature range from -10°C to +40°C.

Flammability characteristics of plastics (UL 94)

The flammability tests for plastics have been defined by the Underwriters Laboratory (USA) in regulation UL 94. This applies to all areas of application, particularly in electrical engineering. A horizontal or vertical test is carried out at the test laboratory to determine the flammability of the plastic material with a naked flame. In order of increasing flame-retardant behavior, the evaluation classes are HB, V2, V1, V0, and 5V. Test results are recorded on "yellow cards" and are published annually in the **Recognized Component Directory**.

Thermoplastics: non-reinforced polyamide, PA

We use the modern, semi-crystalline insulation material, polyamide, which is now an essential component in electrical engineering and electronics. It has long occupied a leading position and is authorized for use by the relevant approval authorities such as the CSA, NEMKO, KEMA, PTB, SEV, UL, VDE, etc.

Polyamide has excellent electrical, mechanical, chemical, and other properties even at high operating temperatures. Brief peak temperatures of up to approximately 200°C are permitted as a result of heat aging stabilization. Depending on the type (PA 4.6, 6.6, 6.10, etc.), its melting point is in the region of 215°C to 295°C.

Polyamide absorbs moisture from its surroundings, on average 2.8%. However, this moisture is not crystallization water in the plastic itself, but chemically bonded H₂O groups in the molecular structure. This makes the plastic flexible and resistant to breakage, even at temperatures as low as -40°C. As per UL 94, PA has a flammability rating of V2 to V0.

Thermoplastics: polyester, PBT

We use the semi-crystalline thermoplastic polyester in non-reinforced and fiberglass-reinforced variants for special applications which require increased dimensional and form stability.

In addition to the high operating temperature, the material is characterized by excellent mechanical strength and hardness. Polyester does not absorb moisture from its surroundings. Therefore, PBT is particularly suitable for strips, for example, that are soldered onto PCBs and are subsequently required to pass a burn-in test where they are subjected to the influence of heat. As per UL 94, PBT has a flammability rating of V2 to V0.

Thermoplastics: polycarbonate, PC

Polycarbonate combines many advantages such as rigidity, impact strength, transparency, dimensional stability, good insulation properties, and resistance to heat.

The amorphous material only absorbs moisture to a very limited degree, and is used for items such as large, rigid electronic component housings.

In its transparent form, polycarbonate is particularly suitable for use as a material for cover profiles or marking materials.

PC has good resistance properties against mineral acids, saturated aliphatic hydrocarbons, gasoline, greases, and oils.

This material is not very resistant to solvents, benzene, alkalis, acetone, and ammonia. Strain cracks may result from contact with certain chemicals.

As per UL 94, PC has a flammability rating of V2 to V0.

Thermoplastics: polycarbonate fiber-reinforced, PC-F

Compared to non-reinforced materials, fiber-reinforced polycarbonates feature greater rigidity and impact strength, and have a higher operating temperature. Otherwise, their properties are largely the same as those of non-reinforced polycarbonate.

Thermoplastics: ABS

We use the thermoplastic molding compound ABS for products which must have good impact and notched impact properties in addition to high mechanical stability and rigidity. The products are characterized by their resistance to chemicals and stress cracking due to their special surface quality and hardness.

The characteristic thermal properties provide good dimensional stability at both low and high temperatures. Products made from ABS can be coated with metallic surfaces, e.g., nickel.

As per UL 94, the molding compound used has a flammability rating of HB to V0.

Properties	Unit/level	Polyamide PA	Polyester PBT	Polycarbonate PC	Polycarbonate PC-F	ABS
Operating temperature RTI */**	°C	≤ 105	≤ 105	≤ 125	≤ 120	≤ 80
Minimum temperature (without mechanical load)	°C	-40	-40	-40	-40	-40
Electric strength IEC 60243-1/DIN VDE 0303-21	kV/cm	600	400	> 300		850
Resistance to creepage IEC 60112/DIN VDE 0303-1	CTI...M	550	225	175		200
	CTI...	600	225	175	175	600
Tropical and termite resistance		Good	Good	Good		
Specific contact resistance IEC 60093/VDE 0303 Part 30; IEC 60167/VDE 0303 Part 31	Ω cm	10 ¹²	10 ¹⁶	> 10 ¹⁶	> 10 ¹⁴	10 ¹⁴
Surface resistance IEC 60093/VDE 0303 Part 30; IEC 60167/VDE 0303 Part 31	Ω	10 ¹⁰	10 ¹³	> 10 ¹⁴		10 ¹³
Flammability rating UL 94		V2-V0	V0	V2-V0	V0	HB-V0

* As per UL 746 B/ANSI 746 B (elec.)

** Minimum value

Dimensions

Dimensions: Width/Height/Depth



The dimensions “**Width/Height/Depth**” are defined as follows for all DIN-rail-mountable products:

- **Width**: measurement taken along the DIN rail
- **Height**: measurement taken across the DIN rail
- **Depth**: measurement taken starting from the mounting plate and including the NS 35/7,5 DIN rail (EN 60715)

The width, height, and depth never change, even if the products shown in this catalog happen to be photographed from two different perspectives (horizontal or vertical).

To make things easier for you, one of the two symbols shown above has been included next to each product photo:

EMC: Class A product:

In accordance with statutory regulations, our products are indicated with this footnote if they are intended for use in industrial environments. This means that the permitted limit values for residential applications may be exceeded in the event of conducted and emitted disturbance variables. In such cases, the operator may have to take additional safety measures in order to ensure electromagnetic compatibility in residential applications.

Note:

Subject to changes that serve the purpose of technical progress.

Connection cross section

The rated cross section of terminal blocks must be specified by the manufacturer in accordance with IEC 60947-7-1. The rated cross section is the maximum conductor cross section that can be connected in solid, multi-stranded or fine-stranded versions subject to specific thermal, mechanical, and electrical requirements.

The manufacturer must also specify the **rated connection capacity**, i.e., the area of connectable conductors as well as the number of conductors which can be connected simultaneously and the necessary preparation of the conductor ends. The conductors can be **rigid (solid or multi-stranded)** or

flexible (fine-stranded).

These values can be found in the product-specific technical data.

The rated connection capacity of Phoenix Contact terminal blocks usually exceeds standard requirements, which specify that it must only be possible to connect one conductor with one of the two next smallest cross sections, excluding the rated cross section (standardized for the cross section range from 0.2 to 35 mm²).

In addition, conductors with a rated cross section can usually be wired with ferrules with plastic sleeve.

Phoenix Contact terminal blocks are

designed to allow copper wires to be connected to them untreated. "Special treatment" or the use of ferrules – both permitted in accordance with IEC 60947-7-1 – is not required. If ferrules are nevertheless used to protect flexible conductors against splicing, the connection capacity of the flexible conductor is generally reduced by one level.

Structure and dimensions of connecting cables

Cross section [mm ²]	Solid		Multi-stranded		Fine-stranded		Gauge no. AWG	American Wire Gauge [AWG]					
	Diameter max. dimension	Number of wires	Diameter max. dimension	Number of wires (minimum number)	Diameter max. dimension	Number of wires (guide value)		Rigid wires			Flexible wires		
								[Ø mm]	[circ. mils]	[mm ²]	[Ø mm]	[circ. mils]	[mm ²]
0.2	0.5	1	–	–	–	–	24	0.51	404	0.21	–	–	–
0.5	0.9	1	1.1	7	1.1	16	20	0.81	1022	0.52	0.97	1111	0.56
0.75	1.0	1	1.2	7	1.3	24	18	1.02	1620	0.82	1.16	1600	0.82
1	1.2	1	1.4	7	1.5	32	(17)	1.15	2050	1.04	–	–	–
–	–	–	–	–	–	–	16	1.29	2580	1.31	1.50	2580	1.32
1.5	1.5	1	1.7	7	1.8	30	(15)	1.45	3260	1.65	–	–	–
–	–	–	–	–	–	–	14	1.63	4110	2.08	1.85	4100	2.09
2.5	1.9	1	2.2	7	2.3	50	(13)	1.83	5180	2.63	–	–	–
–	–	–	–	–	–	–	12	2.05	6530	3.31	2.41	6500	3.32
4	2.4	1	2.7	7	2.9	56	(11)	2.30	8230	4.17	–	–	–
–	–	–	–	–	–	–	10	2.59	10380	5.26	2.95	10530	5.37
6	2.9	1	3.3	7	3.9	84	(9)	2.91	13100	6.63	–	–	–
–	–	–	–	–	–	–	8	3.26	16510	8.37	3.73	16625	8.48

Tightening torque of terminal block screws

IEC 60947-1/EN 60947-1, modified, Table 4 specifies tightening torques for screw connections based on the screw size for electrical and mechanical type tests.

Extract from IEC 60947-1/EN 60947-1, Table 4

The IEC torque and the recommended torque for Phoenix Contact terminal blocks are specified

Thread	Head screw with slot	
	Torque [Nm]	Recommended tightening torque [Nm]
M2.5 (M2.6)	0.4	0.4 - 0.5
M3	0.5	0.5 - 0.6
M3.5	0.8	0.8 - 1.0
M4	1.2	1.2 - 1.5















































Current carrying capacity

Standard IEC 60947-7-1/EN 60947-7-1/ DIN VDE 0611-1 specifies the test currents for the individual conductor cross sections listed in the adjacent table. The corresponding currents are listed with the connection data for the individual terminal blocks. The type tests of terminal blocks are based on this data.

Test currents in accordance with IEC 60947-7-1/EN 60947-7-1, Table 5

Rated cross section	[mm ²]	0.2	0.5	0.75	1.0	1.5	2.5	4	6	10	16
Test current	[A]	4	6	9	13.5	17.5	24	32	41	57	76

Certification authorities and marks

Certification authorities and approvals	Country code	Explosion protection	Country code	Marine classification societies	Country code
 IECEx CB Scheme (in combination with certifying body)	International	 International Electrotechnical Commission	International	 DNV GL - MARITIME	DE
 CENELEC Certification Agreement (CCA inspection report) (in combination with certifying body)	EU	 ATEX Directive	EU	 Bureau Veritas	FR
 Canadian Standards Association (CSA)	CA	 Canadian Standards Association (CSA)	CA	 Lloyd's Register of Shipping	GB
 Canadian Standards Association (CSA) - CSA approval for the USA -	US	 Canadian Standards Association (CSA) - CSA approval for the USA -	US	 Nippon Kaiji Kyokai	JP
 Canadian Standards Association (CSA) combined logo - CSA approval for Canada and the USA -	CA US	 Canadian Standards Association (CSA) combined logo - CSA approval for Canada and the USA -	CA US	 Polski Rejestr Statków	PL
 Underwriters Laboratories Inc. (UL)	US	 Underwriters Laboratories Inc. (UL)	US	 Russian Maritime Register of Shipping	RU
 Underwriters Laboratories Inc. (UL) - UL approval for Canada -	CA	 Underwriters Laboratories Inc. (UL) - UL approval for Canada -	CA	 Korean Register of Shipping	KR
 Underwriters Laboratories Inc. (UL) combined logo - UL approval for the USA and Canada -	US CA	 Underwriters Laboratories Inc. (UL) combined logo - UL approval for the USA and Canada -	US CA	 American Bureau of Shipping	US
 INSIEME PER LA QUALITA'E LA SICUREZZA	IT	 FM Approvals	US	 Registro Italiano Navale	IT
 Eurasian Conformity	EAEU	 FM Approvals - FM approval for Canada -	CA		
 DEKRA Certification B.V.	NL	 FM Approvals - FM approval for the USA and Canada -	US CA		
 Österreichischer Verband für Elektrotechnik	AT	 Eurasian Conformity for Ex-products	EAEU		
 Eurofins Electrosuisse Product Testing AG SEV certification scheme	CH	 Korean Certification Mark for Ex-products	KR		
 Verband Deutscher Elektrotechniker e.V. (VDE) - Approval of drawings - Reports with production monitoring	DE	 National Institute of Metrology, Standardization and Industrial Quality	BR		
 Berufsgenossenschaft (BG) GS - Geprüfte Sicherheit (tested safety)	DE	 National Supervision and Inspection Center for Explosion Protection and Safety of Instrumentation	CN		
 Intertek ETL Listed - Approval for the USA -	US	 Corp. Centro de Investigación y Desarrollo Tecnológico del Sector Eléctrico	CO		
 Intertek ETL Listed - Approval for Canada -	CA				
 Intertek ETL Listed - Approval for the USA and Canada -	US CA				
 TÜV Rheinland Industrie Service GmbH	DE				
 China Compulsory Certification	CN				
 Korean Certification Mark	KR				

Dimensioning of clearances

Schematic for determining clearances

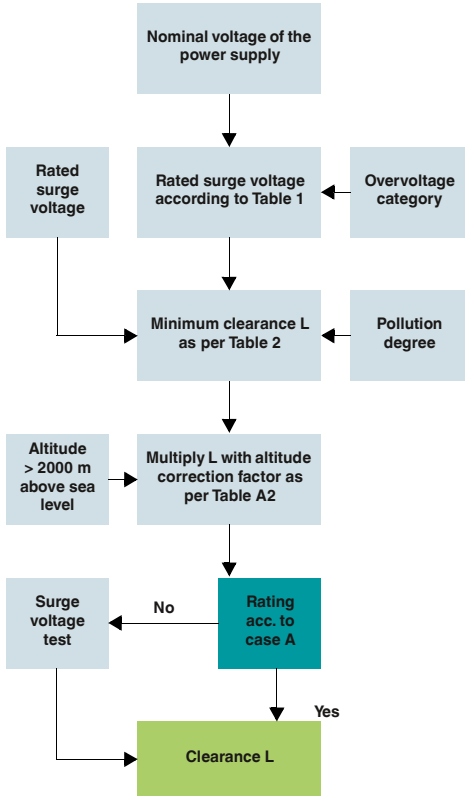

Rated surge voltages for equipment that is directly supplied by the low-voltage network (extract from Table 1)

Nominal voltage of the power supply system ¹⁾ (mains) as per IEC 60038 ³⁾		Conductor-neutral conductor voltage derived from the total nominal AC voltage or nominal DC voltage	Rated surge voltage ²⁾ [V]			
Three-phase [V]	Single-phase [V]		Overvoltage category ⁴⁾			
		[V]	I	II	III	IV
		50	330	500	800	1500
		100	500	800	1500	2500
		150	800	1500	2500	4000
230/400	277/480	300	1500	2500	4000	6000
		600	2500	4000	6000	8000
		1000	4000	6000	8000	12000

¹⁾ Refer to Annex B for application in existing deviating low-voltage networks and their nominal voltages.

²⁾ Equipment with this rated surge voltage may be used in systems according to IEC 60364-4-443.

³⁾ The slash, i.e., /, indicates a three-phase four-conductor system. The lower value is the conductor-to-neutral-conductor voltage, whereas the higher value is the conductor-to-conductor voltage. When only one value is specified, it refers to a three-phase three-conductor system, and indicates the conductor-to-conductor voltage.

⁴⁾ Refer to 2.2.2.1.1 for an explanation of overvoltage categories.

Minimum clearances for transient overvoltages (extract from Table 2)

Required impulse withstand voltage ¹⁾ ⁵⁾ [kV]	Condition A Non-homogeneous field (refer to 3.15)			Condition B Homogeneous field (refer to 3.14)		
	Pollution degree ⁶⁾			Pollution degree ⁶⁾		
	1 [mm]	2 [mm]	3 [mm]	1 [mm]	2 [mm]	3 [mm]
0.33 ²⁾	0.01	0.2 ³⁾ ⁴⁾	0.8 ⁴⁾	0.01	0.2 ³⁾ ⁴⁾	0.8 ⁴⁾
0.40	0.02			0.02		
0.5 ²⁾	0.04			0.04		
0.60	0.06			0.06		
0.80 ²⁾	0.10			0.10		
1.0	0.15			0.15		
1.2	0.25	0.25		0.2		
1.5 ²⁾	0.5	0.5		0.3	0.3	
2.0	1.0	1.0	1.0	0.45	0.45	
2.5 ²⁾	1.5	1.5	1.5	0.6	0.6	
3.0	2.0	2.0	2.0	0.8	0.8	
4.0 ²⁾	3	3	3	1.2	1.2	1.2
5.0	4	4	4	1.5	1.5	1.5
6.0 ²⁾	5.5	5.5	5.5	2	2	2
8.0 ²⁾	8	8	8	3	3	3
10	11	11	11	3.5	3.5	3.5
12 ²⁾	14	14	14	4.5	4.5	4.5
15	18	18	18	5.5	5.5	5.5
20	25	25	25	8	8	8
25	33	33	33	10	10	10
30	40	40	40	12.5	12.5	12.5
40	60	60	60	17	17	17
50	75	75	75	22	22	22
60	90	90	90	27	27	27
80	130	130	130	35	35	35
100	170	170	170	45	45	45

¹⁾ This voltage is:

- For function insulation: the highest surge voltage expected for the clearance
- For basic insulation, if influenced directly or considerably by transient overvoltages from the low-voltage network: the rated surge voltage of the equipment
- For a different basic insulation: the highest surge voltage possible in the circuit.

²⁾ Preferred values

³⁾ For PCBs, the values of pollution degree 1 are applicable, except that no deviation below the value of 0.04 mm is permitted, as specified in Table 4.

⁴⁾ Minimum clearances for pollution degrees 2 and 3 are based on the corresponding creepage distances.

This resistance is reduced due to the effects of humidity.

⁵⁾ Values can be interpolated for parts or circuits within equipment that are subjected to surge voltages.

⁶⁾ The distances for pollution degree 4 are equal to those for pollution degree 3, except that the minimum clearance is 1.6 mm.

Altitude correction factors (extract from Table A.2)

Altitude [m]	Normal air pressure [kPa]	Multiplication factor for distances
2000	80.0	1.00
3000	70.0	1.14
4000	62.0	1.29
5000	54.0	1.48
6000	47.0	1.70
7000	41.0	1.95
8000	35.5	2.25
9000	30.5	2.62
10000	26.5	3.02
15000	12.0	6.67
20000	5.5	14.50

Dimensioning of creepage distances

Schematic for determining creepage distances

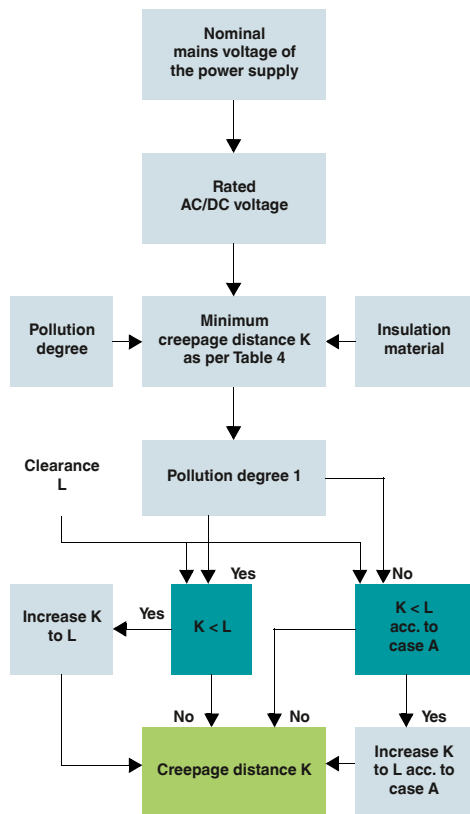

Nominal voltage of the power supply system (mains) *)	Voltages for Table 4	
	For conductor-to-conductor insulation 1)	For conductor-to-ground insulation 1)
	All systems	Three-conductor systems center point grounded
[V]	[V]	[V]
12.5	12.5	-
24	25	-
25	-	-
30	32	-
42	50	-
48	-	-
50 **)	-	-
60	63	-
30-60	63	32
100 **)	100	-
110	125	-
120	-	-
150 **)	160	-
220	250	-
110-220	250	125
220-240	-	-
300 **)	320	-
220-440	500	250
600 **)	630	-
480-960	1000	500
1000 **)	1000	-

1) Conductor-to-ground insulation levels for non-grounded systems or those grounded through impedance correspond to conductor-to-conductor insulation levels as the operating voltage of every conductor to ground can, in practice, reach the conductor-to-conductor voltage. This is based on the fact that the actual voltage to ground is determined by the insulation resistance and capacitive reactance of each conductor to ground. Therefore, a low (but permissible) insulation resistance of a conductor can practically ground this and raise the two others to conductor-to-conductor voltage to ground.

*) Refer to 2.2.1 for correlation with the rated voltage.

**) These values correspond to the values in Table 1.

Nominal voltage of the power supply system (mains) *)	Voltages for Table 4		
	For conductor-to-conductor insulation	Insulation for conductor to ground	
		All systems	Three-phase four-conductor systems with grounded neutral conductor 2)
[V]	[V]	[V]	[V]
60	63	32	63
110/120/127	125	80	125
150 **)	160	-	160
208	200	125	200
220/230/240	250	160	250
300 **)	320	-	320
380/400/415	400	250	400
440	500	250	400
480/500	500	320	500
575	630	400	630
600 **)	630	-	630
660/690	630	400	630
720/830	800	500	800
960	1000	630	1000
1000 **)	1000	-	1000

1) Conductor-to-ground insulation levels for non-grounded systems or those grounded through impedance correspond to conductor-to-conductor insulation levels as the operating voltage of every conductor to ground can, in practice, reach the conductor-to-conductor voltage. This is based on the fact that the actual voltage to ground is determined by the insulation resistance and capacitive reactance of each conductor to ground. Therefore, a low (but permissible) insulation resistance of a conductor can practically ground this and raise the two others to conductor-to-conductor voltage to ground.

2) For equipment designed for use in three-phase four-conductor and three-phase three-conductor systems, grounded as well as non-grounded, only the values for three-conductor systems may be used.

*) Refer to 2.2.1 for correlation with the rated voltage.

***) These values correspond to the values in Table 1.

Creepage distances to prevent failures occurring due to creepage (extract from Table 4)

Voltage 1) r.m.s. value	Minimum creepage distances											
	Printed circuits			Pollution degree								
	Pollution degree			1			2			3		
	All insulation material groups	All insulation material groups except III b		All insulation material groups	Insulation material group			Insulation material group				
[V]	[mm]	[mm]	[mm]	I [mm]	II [mm]	III [mm]	I [mm]	II [mm]	III 2) [mm]			
10	0.025	0.04	0.08	0.4	0.4	0.4	1.00	1.00	1.00			
12.5	0.025	0.04	0.09	0.42	0.42	0.42	1.05	1.05	1.05			
16	0.025	0.04	0.10	0.45	0.45	0.45	1.10	1.10	1.10			
20	0.025	0.04	0.110	0.48	0.48	0.48	1.20	1.20	1.20			
25	0.025	0.04	0.125	0.5	0.5	0.5	1.25	1.25	1.25			
32	0.025	0.04	0.140	0.53	0.53	0.53	1.30	1.30	1.30			
40	0.025	0.04	0.16	0.56	0.8	1.1	1.4	1.6	1.8			
50	0.025	0.04	0.18	0.6	0.85	1.2	1.5	1.7	1.9			
63	0.040	0.63	0.20	0.63	0.9	1.25	1.6	1.8	2.0			
80	0.063	0.10	0.22	0.67	0.95	1.3	1.7	1.9	2.1			
100	0.10	0.16	0.25	0.71	1.0	1.4	1.8	2.0	2.2			
125	0.16	0.25	0.28	0.75	1.05	1.5	1.9	2.1	2.4			
160	0.25	0.4	0.32	0.8	1.1	1.6	2.0	2.2	2.5			
200	0.40	0.63	0.42	1.0	1.4	2.0	2.5	2.8	3.2			
250	0.56	1.0	0.56	1.25	1.8	2.5	3.2	3.6	4.0			
320	0.75	1.6	0.75	1.6	2.2	3.2	4.0	4.5	5.0			
400	1.0	2.0	1.00	2.0	2.8	4.0	5.0	5.6	6.3			
500	1.3	2.5	1.30	2.5	3.6	5.0	6.3	7.1	8.0			
630	1.8	3.2	1.80	3.2	4.5	6.3	8.0	9	10.0			
800	2.4	4.0	2.40	4.0	5.6	8.0	10.0	11	12.5			
1000	3.2	5.0	3.20	5.0	7.1	10	12.5	14	16.0			
1250			4.20	6.3	9	12.5	16	18	20			
1600			5.60	8	11	16	20	22	25			
2000			7.50	10	14	20	25	28	32			
2500			10	12.5	18	25	32	36	40			
3200			12.5	16	22	32	40	45	50			
4000			16	20	28	40	50	56	63			
5000			20	25	36	50	63	71	80			
6300			25	32	45	63	80	90	100			
8000			32	40	56	80	100	110	125			
10000			40	50	71	100	125	140	160			

1) This voltage is:
a) For function insulation: the working voltage.
b) For basic and additional insulation of a circuit supplied directly by the low-voltage network: either the voltage selected from Table 3 a or 3 b on the basis of the rated voltage of the equipment or the rated insulation voltage.
c) For basic and additional insulation of systems, equipment, and internal circuits which are not supplied directly from the mains: the highest r.m.s. value of the voltage that, within the bounds of the rated data, can occur in the system, the equipment or the internal circuit, when supplied with rated voltage and in the case of the most unfavorable combination of operating conditions.

2) With pollution degree 3, insulation material group III b is not recommended for use if voltages are greater than 630 V.

Index

Alphabetical

Type	Order No.	Page	Type	Order No.	Page	Type	Order No.	Page	Type	Order No.	Page
			CB TM1 4A SFB P	2800839	311	CT 10-2/2-GS	2765398	192	ECP-E2-12A	0900207	385
			CB TM1 5A F1 P	2800862	393	CT 10-2/2-GS/3E	2765408	192	ECP-E2-1A	0900139	385
			CB TM1 5A M1 P	2800851	392	CT 10-2/2-GS/3E-110AC	2920829	192	ECP-E2-2A	0900236	385
			CB TM1 5A SFB P	2800840	311	CT 10-TL	2765356	193	ECP-E2-3A	0900333	385
A											
ADAPTER KOAX TYP F	2880972	204	CB TM1 6A F1 P	2800863	393	CT-TERMBLOCK 10 DA	0441711	193	ECP-E2-4A	0900430	385
			CB TM1 6A M1 P	2800852	392	CTM 10-MAG	2838610	193	ECP-E2-6A	0900634	385
			CB TM1 6A SFB P	2800841	311	CTM 1X2- 12DC	2838597	126	ECP-E2-8A	0900838	385
			CB TM1 8A F1 P	2800864	393	CTM 1X2- 24DC	2838513	126	ECP-E3 10A	0912050	385
B											
BATTERY MOUNTING CASE	2320458	339	CB TM1 8A M1 P	2800853	392	CTM 1X2- 60DC	2838568	126	ECP-E3 12A	0912052	385
BATTERY MOUNTING KIT	2320788	339	CB TM1 8A SFB P	2800842	391	CTM 1X2-110AC	2838539	190	ECP-E3 1A	0912041	385
BLT-SKT-230-A	1038842	86	CB TM2 0.5A F1 P	2800890	393	CTM 2X1- 12DC	2838584	142	ECP-E3 2A	0912042	385
BLT-T2-1S-305-UT	1078433	76	CB TM2 0.5A M1 P	2800879	392	CTM 2X1- 24DC	2838500	142	ECP-E3 3A	0912043	385
BLT-T2-1S-320-UT	2906101	77	CB TM2 0.5A SFB P	2800868	391	CTM 2X1- 60DC	2838542	142	ECP-E3 4A	0912044	385
BLT-T2-320-UT	2906100	76	CB TM2 10A F1 P	2800898	393	CTM 2X1-110AC	2838526	190	ECP-E3 6A	0912046	385
BLT-T3-230-A	1038841	86	CB TM2 10A M1 P	2800887	392	CTM 2X1-180DC-GS	2838636	191	ECP-E3 8A	0912048	385
BT-1S-230AC/A	2803409	87	CB TM2 10A SFB P	2800876	391	CTM 2X1-180DC-GS-P	2838623	191	EM-CPS-PS/3AC/24DC/5	1064922	262
BT-1S-230AC/O	2800625	87	CB TM2 12A F1 P	2800899	393	CTM EST	2838649	126	EML (20XE)R	0803452	101
			CB TM2 12A M1 P	2800888	392	CTM ISDN	2838555	191	EML (20XE)R YE	0803453	101
			CB TM2 12A SFB P	2800877	391						
			CB TM2 16A F1 P	2800900	393						
C											
C-SAT-BOX	2880561	204	CB TM2 16A M1 P	2800889	392						
C-TV-SAT	2856993	205	CB TM2 16A SFB P	2800878	391						
C-TV/HIFI	2857002	205	CB TM2 1A F1 P	2800891	393						
C-UB/E	2763701	201	CB TM2 1A M1 P	2800880	392						
C-UB- 5DC/E	2782300	201	CB TM2 1A SFB P	2800869	391	D-LAN-19"-12	2880150	167	F-MS 1100 ST	2909844	64
C-UB- 5DC/E 75	2763604	201	CB TM2 2A F1 P	2800892	393	D-LAN-19"-16	2880147	167	F-MS 12 ST	2817990	71
C-UB-24DC/E	2782313	201	CB TM2 2A M1 P	2800881	392	D-LAN-19"-20	2880134	167	F-MS 12-UD ST	2858328	71
CB 1/10-1/10 UT-BE	2801305	396	CB TM2 2A SFB P	2800870	391	D-LAN-19"-24	2838791	167	F-MS 2200/30 ST	2805392	65
CB 1/6-2/4 PT-BE	2800929	396	CB TM2 3A F1 P	2800893	393	D-LAN-19"-4	2880176	167	F-MS-T1/T2 50 ST	2800191	46
CB E1 24DC/10A NO P	2800907	382	CB TM2 3A M1 P	2800882	392	D-LAN-19"-8	2880163	167	FBS 2-6	3030336	394
CB E1 24DC/10A S-C P	2800928	383	CB TM2 3A SFB P	2800871	391	D-LAN-19"-D-P	2880192	167	FBS 2-6 BU	3036932	396
CB E1 24DC/10A S-R P	2800914	383	CB TM2 4A F1 P	2800894	393	D-LAN-CAT.5-FP	2800723	167	FBS 2-6 GY	3032237	396
CB E1 24DC/1A NC P	2800915	383	CB TM2 4A M1 P	2800883	392	D-UB-FB	2880642	179	FBS 3-6	3030242	394
CB E1 24DC/1A NO P	2800901	382	CB TM2 4A SFB P	2800872	391	DK-BIC-35	2749880	100	FBS 3-6 BU	3036945	396
CB E1 24DC/1A S-C P	2800922	383	CB TM2 5A F1 P	2800895	393	DT-LAN-CAT.6+	2881007	166	FBS 3-6 GY	3032240	396
CB E1 24DC/1A S-R P	2800908	383	CB TM2 5A M1 P	2800884	392	DT-TELE-RJ45	2882925	186	FBS 4-6	3030255	394
CB E1 24DC/2A NC P	2800916	383	CB TM2 5A SFB P	2800873	391	DT-TELE-SHDLS	2801593	186	FBS 4-6 BU	3036958	396
CB E1 24DC/2A NO P	2800902	382	CB TM2 6A F1 P	2800896	393	DT-UB-FB-485/BS	2920612	173	FBS 4-6 GY	3032279	396
CB E1 24DC/2A S-C P	2800923	383	CB TM2 6A M1 P	2800885	392	DT-UB-FB-IB-RBO	2800056	183	FBS 4-6 BU	3030349	394
CB E1 24DC/2A S-R P	2800909	383	CB TM2 6A SFB P	2800874	391	DT-UB-FB-IB-RBI	2800055	183	FBS 5-6 BU	3036961	396
CB E1 24DC/3A NC P	2800917	383	CB TM2 8A F1 P	2800897	393	DT-UB-FB-V24/S-9-SB	2803069	168	FBS 5-6 GY	3032266	396
CB E1 24DC/3A NO P	2800903	382	CB TM2 8A M1 P	2800886	392				FBS 10-6	3030271	394
CB E1 24DC/3A S-C P	2800924	383	CB TM2 8A SFB P	2800875	391				FBS 10-6 BU	3032198	396
CB E1 24DC/3A S-R P	2800910	383	CBM E4 24DC/0.5-10A NO-R	2905743	372				FBS 10-6 GY	3032253	396
CB E1 24DC/4A NC P	2800918	383	CBM E8 24DC/0.5-10A NO-R	2905744	372	EC-E 0.5A DC24V	0903041	387	FBS 20-6	3030365	394
CB E1 24DC/4A NO P	2800904	382	CBMC E4 24DC/1-10A IOL	2910411	377	EC-E 1A DC24V	0903042	387	FBS 20-6 BU	3032208	396
CB E1 24DC/4A S-C P	2800925	383	CBMC E4 24DC/1-10A NO	2906032	375	EC-E 2A DC24V	0903043	387	FBS 50-6	3032224	396
CB E1 24DC/4A S-R P	2800911	383	CBMC E4 24DC/1-10A NO-C	2908716	373	EC-E 3A DC24V	0903044	387	FBS 50-6 BU	3032211	396
CB E1 24DC/6A NC P	2800919	383	CBMC E4 24DC/1-10A S-R	1065729	375	EC-E 4A DC24V	0903045	387	FBST 500 TMC-N GY	0901028	386
CB E1 24DC/6A NO P	2800905	382	CBMC E4 24DC/1-4A NO	2906031	374	EC-E 6A DC24V	0903046	387	FBST 500-PLC BU	2966692	386
CB E1 24DC/6A S-C P	2800926	383	CBMC E4 24DC/1-4A NO-C	2908713	373	EC-E 8A DC24V	0903047	387	FBST 500-PLC RD	2966786	386
CB E1 24DC/6A S-R P	2800912	383	CBMC E4 24DC/1-4A S-R	1065727	374	EC-E 10A DC24V	0903048	387	FLT-IG-100-EX	2905579	102
CB E1 24DC/8A NO P	2800906	382	CBMC E4 24DC/1-4A+ IOL	2910410	376	EC-E 12A DC24V	0903049	387	FLT-IG-BR-11	2905580	103
CB E1 24DC/8A S-C P	2800927	383	CBMC EG4 24DC/1-8A NO	1065730	375	EC-E1 0.5A	0903022	386	FLT-IG-BR-14	2905581	103
CB E1 24DC/8A S-R P	2800913	383	CHECKMASTER 2	2905256	221	EC-E1 10A	0903030	386	FLT-IG-BR-18	2905582	103
CB PT BRIDGE	2801014	382	CM 2-PA-CTM	2905282	221	EC-E1 12A	0903031	386	FLT-IG-BR-22	2905583	103
CB S-BE	2905067	396	CM 2-PA-FLT/VAL-CP/SEC	2905283	221	EC-E1 1A	0903023	386	FLT-IG-BR-26	2905757	103
CB TM1 0.5A F1 P	2800857	393	CM 2-PA-PLT-UT/PT	1027866	221	EC-E1 2A	0903024	386	FLT-IG-BR-30	2905758	103
CB TM1 0.5A M1 P	2800846	392	CM 2-PA-PT/A	2907891	221	EC-E1 3A	0903025	386	FLT-IG-BR-33	2905759	103
CB TM1 0.5A SFB P	2800835	311	CM 2-PA-PT/PLT	2905284	221	EC-E1 4A	0903026	386	FLT-IG-BR-36	2905760	103
CB TM1 10A F1 P	2800865	393	CM 2-PA-PT4/PLT3S	2907019	221	EC-E1 6A	0903028	386	FLT-IG-BR-39	2905761	103
CB TM1 10A M1 P	2800854	392	CM 2-PA-SEC-HYBRID	2907889	221	EC-E1 8A	0903029	386	FLT-IG-BR-42	2905762	103
CB TM1 10A SFB P	2800843	391	CM 2-PA-TTC	2908707	221	EC-E4 0.5A	0903040	386	FLT-IG-BR-48	2905763	103
CB TM1 12A F1 P	2800866	393	CM 2-PA-VAL-MS	2905265	221	EC-E4 10A	0903038	386	FLT-IG-BR-56	2905764	103
CB TM1 12A M1 P	2800855	392	CN-LAMBDA/4-0.47-BB	2800021	202	EC-E4 12A	0903039	386	FLT-IG-BR-62	2905765	103
CB TM1 12A SFB P	2800844	391	CN-LAMBDA/4-0.47-SB	2800022	202	EC-E4 1A	0903032	386	FLT-IG-CA-100	2905589	103
CB TM1 16A F1 P	2800867	393	CN-LAMBDA/4-2.25-BB	2801057	202	EC-E4 2A	0903033	386	FLT-IG-CA-200	2905590	103
CB TM1 16A M1 P	2800856	392	CN-LAMBDA/4-2.25-SB	2801056	202	EC-E4 3A	0903034	386	FLT-IG-CA-300	2905591	103
CB TM1 16A SFB P	2800845	391	CN-LAMBDA/4-5.9-BB	2838490	203	EC-E4 4A	0903035	386	FLT-IG-PL-11	2905584	103
CB TM1 1A F1 P	2800858	393	CN-LAMBDA/4-5.9-SB	2800023	203	EC-E4 6A	0903036	386	FLT-IG-PL-14	2905586	103
CB TM1 1A M1 P	2800847	392	CN-UB-280DC-3-BB	2801050	200	EC-E4 8A	0903037	386	FLT-IG-PL-18	2905587	103
CB TM1 1A SFB P	2800836	311	CN-UB-280DC-3-SB	2801051	200	ECP-E 1A	0900113	384	FLT-IG-PL-22	2905588	103
CB TM1 2A F1 P	2800859	393	CN-UB-70DC-6-BB	2803166	200	ECP-E 2A	0900210	384	FLT-IG-PL-26	2905745	103
CB TM1 2A M1 P	2800848	392	CN-UB-70DC-6-SB	2803153	200	ECP-E 3A	0900317	384	FLT-IG-PL-30	2905746	

Index

Alphabetical

Type	Order No.	Page	Type	Order No.	Page	Type	Order No.	Page	Type	Order No.	Page
QUINT-PS/48DC/48DC/5	2905008	293				TCP 25/DC32V	0700025	400	TTC-6-MOV-C-120AC-UT-I	2906840	150
QUINT-PS/60-72DC/24DC/10	2905009	294				TCP 30/DC32V	0700030	400	TTC-6-MOV-C-24DC-PT-I	2906854	150
QUINT-PS/60-72DC/24DC/10/CO	2905011	297				TCP 40/DC32V	0700040	400	TTC-6-MOV-C-24DC-UT-I	2906837	150
QUINT-PS/96-110DC/24DC/10	2905010	295				TMC 1 F1 100 0,2A	0914015	395	TTC-6-MOV-C-48DC-PT-I	2906855	150
			S								
QUINT-PS/96-110DC/24DC/10/CO	2905012	297	S-PT-1X2-24DC	2880668	125	TMCP CONNECT LR	0916592	384	TTC-6-MOV-C-48DC-UT-I	2906838	150
QUINT-PS/FAN/4	2320076	310	S-PT-1X2-24DC-1/2"	2882569	125	TMCP SB	0916602	384	TTC-6-MOV-C-60DC-PT-I	2906857	150
QUINT-UPS/ 1AC/ 1AC/500VA	2320270	330	S-PT-1X2-24DC-3/4"	2882598	125	TMCP SOCKET M	0916589	384	TTC-6-MOV-C-60DC-UT-I	2906839	150
QUINT-UPS/24DC/24DC/5/1.3AH	2320254	344	S-PT-2XEX-24DC	2800040	155	TRIO-PS-2G/1AC/12DC/10	2903158	261	TTC-6-MOV-D-24DC-PT-I	2906859	150
QUINT-UPS/24DC/24DC/10/3.4AH	2320267	344	S-PT-2XEX-24DC-1/2"	2800041	155	TRIO-PS-2G/1AC/12DC/5/C2LPS	2903157	260	TTC-6-MOV-D-24DC-UT-I	2906841	150
QUINT-UPS/24DC/12DC/2.5/24DC/10	2320461	326	S-PT-2XEX-48DC	2800038	155	TRIO-PS-2G/1AC/24DC/10	2903149	256	TTC-6-TVSD-C-24DC-PT-I	2906847	148
QUINT4-BUFFER/24DC/20	2907913	345	S-PT-2XEX-48DC-1/2"	2800039	155	TRIO-PS-2G/1AC/24DC/10/B+D	2903145	257	TTC-6-TVSD-C-12DC-UT-I	2906829	148
QUINT4-BUFFER/24DC/40	2908283	345	S-PT-4-EX-24DC	2800036	141	TRIO-PS-2G/1AC/24DC/20	2903151	257	TTC-6-TVSD-C-24DC-PT-I	2906848	148
QUINT4-CAP/24DC/10/8KJ	2320571	347	S-PT-4-EX-24DC-1/2"	2800037	141	TRIO-PS-2G/1AC/24DC/3/C2LPS	2903147	254	TTC-6-TVSD-C-24DC-UT-I	2906831	148
QUINT4-CAP/24DC/5/4KJ	2320539	346	S-PT-EX(I)-24DC	2880671	154	TRIO-PS-2G/1AC/24DC/5	2903148	255	TTC-6-TVSD-C-48DC-PT-I	2906849	148
QUINT4-DIODE/12-24DC/2X20/1X40	2907719	306	S-PT-EX(II)-24DC-1/2"	2882572	154	TRIO-PS-2G/1AC/24DC/5/B+D	2903144	255	TTC-6-TVSD-C-48DC-UT-I	2906832	148
QUINT4-DIODE/48DC/2X20/1X40	2907720	307	S-PT-EX(II)-24DC-3/4"	2882585	154	TRIO-PS-2G/1AC/48DC/10	2903160	261	TTC-6-TVSD-C-60DC-PT-I	2906850	148
QUINT4-PS/1AC/12DC/15	2904608	240	S-PT-EX-24DC	2800034	154	TRIO-PS-2G/1AC/48DC/5	2903159	261	TTC-6-TVSD-C-60DC-UT-I	2906833	148
QUINT4-PS/1AC/12DC/2.5/PT	2904605	252	S-PT-EX-24DC-1/2"	2800035	154	TRIO-PS-2G/3AC/24DC/10	2903154	258	TTC-6-TVSD-D-24DC-PT-I	2906851	149
QUINT4-PS/1AC/12DC/7.5/PT	2904607	253	S-PT-EX-48DC	2800053	154	TRIO-PS-2G/3AC/24DC/20	2903155	259	TTC-6-TVSD-D-24DC-UT-I	2906834	149
QUINT4-PS/1AC/24DC/1.3/PT	2909575	248	S-PT-EX-48DC-1/2"	2800054	154	TRIO-PS-2G/3AC/24DC/40	2903156	259	TTC-6-TVSD-D-48DC-PT-I	2906852	149
QUINT4-PS/1AC/24DC/1.3/SC	2904597	250	SFP 1-10/120AC	2920670	209	TRIO-PS-2G/3AC/24DC/5	2903153	258	TTC-6-TVSD-D-48DC-UT-I	2906835	149
QUINT4-PS/1AC/24DC/10	2904601	235	SFP 1-15/120AC	2920683	209	TRIO-PS-IP67/1AC/24DC/20	1039830	264	TTC-6-TVSD-D-60DC-PT-I	2906853	149
QUINT4-PS/1AC/24DC/2.5/PT	2909576	249	SFP 1-20/120AC	2856702	208	TRIO-PS-IP67/3AC/24DC/20	1039829	265	TTC-6-TVSD-D-60DC-UT-I	2906836	149
QUINT4-PS/1AC/24DC/2.5/SC	2904598	251	SFP 1-20/230AC	2859987	208	TRIO-PS/600DC/24DC/20	2866530	245	TTC-6P-1X2-12DC-I-P	2907839	116
QUINT4-PS/1AC/24DC/20	2904602	235	SFP 1-5/120AC	2920667	209	TRIO-UPS-2G/1AC/1AC/120V/750VA	2905908	332	TTC-6P-1X2-12DC-PT-I	2908193	116
QUINT4-PS/1AC/24DC/20/+	2904617	238	SPRING-LOCK	0713009	384	TRIO-UPS-2G/1AC/1AC/230V/750VA	2905909	332	TTC-6P-1X2-12DC-UT-I	2908192	116
QUINT4-PS/1AC/24DC/3.8/PT	2909577	249	SSA 3-6	2839295	223	TRIO-UPS-2G/1AC/24DC/10	2907161	354	TTC-6P-1X2-24DC-I-P	2907840	116
QUINT4-PS/1AC/24DC/3.8/SC	2904599	251	SSA 5-10	2839512	223	TRIO-UPS-2G/1AC/24DC/5	2907160	354	TTC-6P-1X2-24DC-PT-I	2906815	116
QUINT4-PS/1AC/24DC/40	2904603	235	ST 4-FSI/C	3036372	400	TRIO-UPS-2G/3AC/24DC/20	2906367	355	TTC-6P-1X2-24DC-UT-I	2906809	116
QUINT4-PS/1AC/24DC/5	2904600	234	ST 4-FSI/C-LED 12	3036495	400	TRIO2-DIODE/12-24DC/2X10/1X20	2907380	308	TTC-6P-1X2-48DC-I-P	2907841	116
QUINT4-PS/1AC/48DC/10	2904611	241	ST 4-FSI/C-LED 24	3036505	400	TRIO2-DIODE/12-24DC/2X20/1X40	2907379	309	TTC-6P-1X2-48DC-PT-I	2908195	116
QUINT4-PS/1AC/48DC/5	2904610	241	STEP-BAT/LHION/18.5DC/46WH	1081355	348	TT-D-STTCCO-BK	2858894	210	TTC-6P-1X2-48DC-UT-I	2908194	116
QUINT4-PS/1AC/5DC/5/PT	2904595	253	STEP-BAT/LIPO/18.5DC/1.4AH	2320364	348	TT-ST-M-SFP-24AC	2858946	210	TTC-6P-1X2-EX-24DC-I-P	2907831	152
QUINT4-PS/24DC/12DC/8/PT	2910122	289	STEP-DIODE/5-24DC/2X5/1X10	2888806	309	TTC-3-1X2-24DC-PT	2907325	119	TTC-6P-1X2-EX-24DC-UT-I	1065312	152
QUINT4-PS/24DC/24DC/10/PT	2910120	289	STEP-PS/ 1AC/ 5DC/2	2320513	282	TTC-3-2X1-24DC-PT	2907326	131	TTC-6P-1X2-F-12DC-PT-I	2908198	117
QUINT4-PS/24DC/24DC/10/SC	1046803	291	STEP-PS/ 1AC/ 5DC/6.5	2868541	283	TTC-3-LCP	2908843	119	TTC-6P-1X2-F-12DC-UT-I	2908196	117
QUINT4-PS/24DC/24DC/5/PT	2910119	288	STEP-PS/ 1AC/12DC/1	2888538	284	TTC-6-1X2-24DC-PT	2906804	118	TTC-6P-1X2-F-24DC-PT-I	1065318	117
QUINT4-PS/24DC/24DC/5/SC	1046800	290	STEP-PS/ 1AC/12DC/1.5	2888567	285	TTC-6-1X2-24DC-UT	2906798	118	TTC-6P-1X2-F-24DC-UT-I	1065317	117
QUINT4-PS/3AC/24DC/10	2904621	237	STEP-PS/ 1AC/12DC/1.5/FL	2888554	284	TTC-6-1X2-F-M-24DC-PT-I	2906772	118	TTC-6P-1X2-F-48DC-PT-I	2908200	117
QUINT4-PS/3AC/24DC/20	2904622	237	STEP-PS/ 1AC/12DC/3	2888570	285	TTC-6-1X2-F-M-24DC-UT-I	2906764	118	TTC-6P-1X2-F-48DC-UT-I	2908199	117
QUINT4-PS/3AC/24DC/40	2904623	237	STEP-PS/ 1AC/12DC/5	2888583	285	TTC-6-1X2-M-24DC-PT-I	2906726	118	TTC-6P-1X2-F-M-24DC-PT-I	2906790	117
QUINT4-PS/3AC/24DC/5	2904620	236	STEP-PS/ 1AC/15DC/4	2888619	283	TTC-6-1X2-M-24DC-UT-I	2906713	118	TTC-6P-1X2-F-M-24DC-UT-I	2906781	117
QUINT4-PS/48DC/24DC/5/PT	2910125	289	STEP-PS/ 1AC/24DC/0.5	2888596	278	TTC-6-1X2-M-EX-24DC-UT-I	2906820	152	TTC-6P-1X2-M-24DC-PT-I	2906750	116
QUINT4-S-ORING/12-24DC/1X40	2907752	304	STEP-PS/ 1AC/24DC/0.75	2888635	279	TTC-6-2-24DC-PT	2906806	143	TTC-6P-1X2-M-24DC-UT-I	2906738	116
QUINT4-S-ORING/12-24DC/1X40/+	2907753	305	STEP-PS/ 1AC/24DC/0.75/FL	2888622	279	TTC-6-2-24DC-UT	2906800	143	TTC-6P-1X2-M-EX-24DC-UT-I	2906824	152
QUINT4-S-ORING/12-24DC/1X40/VP	1043418	305	STEP-PS/ 1AC/24DC/1.75	2888648	280	TTC-6-2-HC-24DC-PT-I	2908439	137	TTC-6P-2-HC-24DC-I-P	2907845	136
QUINT4-UPS/1AC/1AC/1KVA	2320283	331	STEP-PS/ 1AC/24DC/2.5	2888651	280	TTC-6-2-HC-24DC-UT-I	2908438	137	TTC-6P-2-HC-24DC-PT-I	2906817	136
QUINT4-UPS/24DC/24DC/10	2907066	325	STEP-PS/ 1AC/24DC/3.8/C2LPS	2888677	281	TTC-6-2-HC-M-24DC-PT-I	2906731	137	TTC-6P-2-HC-24DC-UT-I	2906811	136
QUINT4-UPS/24DC/24DC/10/EC	2907070	321	STEP-PS/ 1AC/24DC/4.2	2888664	281	TTC-6-2-HC-M-24DC-UT-I	2906719	137	TTC-6P-2-HC-M-24DC-PT-I	2906755	136
QUINT4-UPS/24DC/24DC/10/EIP	2907069	319	STEP-PS/ 1AC/48DC/2	2888680	283	TTC-6-2X1-24DC-PT	2906805	130	TTC-6P-2-HC-M-24DC-UT-I	2906743	136
QUINT4-UPS/24DC/24DC/10/PN	2907074	317	STEP-PS/277AC/24DC/3.5	2904945	281	TTC-6-2X1-24DC-UT	2906799	130	TTC-6P-2X1-12DC-I-P	2907842	128
QUINT4-UPS/24DC/24DC/10/USB	2907067	323	STEP-PS/48AC/24DC/0.5	2888716	279	TTC-6-2X1-F-M-24DC-PT-I	2906776	130	TTC-6P-2X1-12DC-PT-I	2908202	128
QUINT4-UPS/24DC/24DC/20	2907071	325	STEP-UPS/12DC/12DC/4/46WH	1082548	348	TTC-6-2X1-F-M-24DC-UT-I	2906767	130	TTC-6P-2X1-12DC-UT-I	2908201	128
QUINT4-UPS/24DC/24DC/20/EC	2907076	321	STEP-UPS/24DC/24DC/3/46WH	1081430	348	TTC-6-2X1-M-24DC-PT-I	2906729	130	TTC-6P-2X1-24DC-I-P	2907843	128
QUINT4-UPS/24DC/24DC/10/PN	2907074	319	SVP 2E-48AC	2788919	192	TTC-6-2X1-M-24DC-UT	2906716	130	TTC-6P-2X1-24DC-PT-I	2906816	128
QUINT4-UPS/24DC/24DC/20/PN	2907073	317	SVP 2E-110AC	2765534	192	TTC-6-2X1-M-EX-24DC-UT-I	2906821	157	TTC-6P-2X1-24DC-UT-I	2906810	128
QUINT4-UPS/24DC/24DC/20/USB	2907072	323	SVP 3E-110AC	2765521	192	TTC-6-2XTVSD-12DC-PT	2906807	148	TTC-6P-2X1-48DC-I-P	2907844	128
QUINT4-UPS/24DC/24DC/40	2907077	325	SZS 0,6X3,5	1205053	386	TTC-6-2XTVSD-24DC-PT	2906808	148	TTC-6P-2X1-48DC-PT-I	2908204	128
QUINT4-UPS/24DC/24DC/40/EC	2907081	321				TTC-6-3-HF-12DC-PT	1065316	170	TTC-6P-2X1-48DC-UT-I	2908203	128
QUINT4-UPS/24DC/24DC/40/EIP	2907080	319				TTC-6-3-HF-F-M-12DC-PT-I	2906778	171	TTC-6P-2X1-EX-24DC-I-P	2907832	157
QUINT4-UPS/24DC/24DC/40/PN	2907079	317				TTC-6-3-HF-F-M-12DC-UT-I	2906769	171	TTC-6P-2X1-F-12DC-PT-I	2908206	129
QUINT4-UPS/24DC/24DC/40/USB	2907078	323				TTC-6-3-HF-F-M-24DC-PT-I	2906779	171	TTC-6P-2X1-F-12DC-UT-I	2908205	129
QUINT4-UPS/24DC/24DC/5	2906990	324				TTC-6-3-HF-F-M-24DC-UT-I	2906770	171	TTC-6P-2X1-F-24DC-PT-I	1065319	129
QUINT4-UPS/24DC/24DC/5/EC	2906996	320				TTC-6-3-HF-F-M-EX-12DC-UT-I	2906822	180	TTC-6P-2X1-F-48DC-PT-I	2908209	129

Type	Order No.	Page	Type	Order No.	Page	Type	Order No.	Page	Type	Order No.	Page
TTC-6P-3-HF-F-M-12DC-PT-I	2906796	169	VAL-MB-T1/T2 600DC-PV/2+V-FM	2906292	51	VAL-MS-T1/T2 600DC-PV/2+V-FM	2801164	50	VAL-US-277/40-P	2910338	92
TTC-6P-3-HF-F-M-12DC-UT-I	2906786	171	VAL-MB-T2 1500DC-PV/2+V	2905647	72	VAL-MS-T1/T2 BE/O	2905650	49	VAL-US-277/40/1+0-FM	2910372	92
TTC-6P-3-HF-F-M-24DC-PT-I	2906797	171	VAL-MB-T2 1500DC-PV/2+V-FM	2905646	72	VAL-MS-T1/T2 BE/O-FM	2905652	49	VAL-US-277/40/1+1-FM	2910373	93
TTC-6P-3-HF-F-M-24DC-UT-I	2906787	171	VAL-MS 60 ST	2807573	66	VAL-MS/1+1-BE	2920528	66	VAL-US-277/40/3+1-FM	2910374	96
TTC-6P-3-HF-F-M-EX-12DC-UT-I	2906826	181	VAL-MS 1000DC-PV-ST	2800624	73	VAL-MS/1+1-BE/FM	2920531	66	VAL-US-277/40/4+0-FM	2910375	97
TTC-6P-3-HF-F-M-EX-24DC-UT-I	2906828	181	VAL-MS 1000DC-PV/2+V	2800628	73	VAL-MS/2+0-BE	2804584	66	VAL-US-277/80-P	2910331	93
TTC-6P-3-HF-F-M-24DC-PT-I	2906756	171	VAL-MS 1000DC-PV/2+V-FM	2800627	73	VAL-MS/2+0-BE/FM	2805321	66	VAL-US-277/80/1+0-FM	2910377	92
TTC-6P-3-HF-F-M-12DC-UT-I	2906744	171	VAL-MS 120 ST	2807586	66	VAL-MS/3+0-BE	2881816	67	VAL-US-277/80/1+1V-FM	2910378	93
TTC-6P-T3-24DC+P	1027591	85	VAL-MS 1500DC-PV-ST	1033727	73	VAL-MS/3+0-BE/FM	2881803	67	VAL-US-277/80/3+0-FM	1075896	95
TTC-6P-T3-24DC-PT-I	1027586	85	VAL-MS 1500DC-PV/2+V	1033708	73	VAL-MS/3+1-BE	2838885	66	VAL-US-277/80/3+1V-FM	2910379	97
TTC-6P-T3-24DC-UT-I	1027584	85	VAL-MS 1500DC-PV/2+V-FM	1033725	73	VAL-MS/3+1-BE/FM	2838898	66	VAL-US-277/80/4+0-FM	2910380	97
TTC-EX-PP	1011977	152	VAL-MS 230 IT ST	2807599	67	VAL-MS/3+1-BE/FM-UD	2858674	67	VAL-US-347/30-P	2910339	93
			VAL-MS 230 ST	2798844	67	VAL-MS/4+0-BE/FM RN.	2906484	67	VAL-US-347/30/1+0-FM	2910381	92
			VAL-MS 230-UD-ST	2858962	67	VAL-SEC-T2-120DC-P	2907878	58	VAL-US-347/30/1+1V-FM	2910382	93
			VAL-MS 230/1+1	2804429	61	VAL-SEC-T2-175-P	2905355	56	VAL-US-347/30/3+0-FM	2910383	95
			VAL-MS 230/1+1-FM	2804432	61	VAL-SEC-T2-1S-175-FM	2905348	57	VAL-US-347/30/3+1V-FM	1079099	97
UC-TM 6 GN	0818360	223	VAL-MS 230/3+1	2838209	60	VAL-SEC-T2-1S-350	2905341	55	VAL-US-48/40-P	2910333	90
UK 6-FSI/C	3118203	400	VAL-MS 230/3+1 FM	2858199	60	VAL-SEC-T2-1S-350-FM	2905333	55	VAL-US-48/40/1+0-FM	2910343	90
UK 6-FSI/C-LED12	3001925	400	VAL-MS 320 RW ST	1050283	63	VAL-SEC-T2-1S-350VF-FM	2909592	55	VAL-US-48/40/1+1V-FM	2910344	90
UK 6-FSI/C-LED24	3001938	400	VAL-MS 320 RW/1+1-FM/60	1050286	63	VAL-SEC-T2-2+0-120DC-FM	2907874	58	VAL-US-48/65-P	2910328	90
UNO-DIODE/5-24DC/2X10/1X20	2905489	309	VAL-MS 320 ST	2838843	68	VAL-SEC-T2-2+0-220DC-FM	2907875	58	VAL-US-48/65/1+0-FM	2910345	90
UNO-PS/1AC/5DC/25W	2904374	271	VAL-MS 320-UD ST	2858315	69	VAL-SEC-T2-2+0-380DC-FM	2907876	58	VAL-US-48/65/1+1V-FM	2910346	90
UNO-PS/1AC/5DC/40W	2904375	271	VAL-MS 320/1+1	2804380	61	VAL-SEC-T2-2+0-48DC-FM	2907865	58	VAL-US-480D/30-P	2910340	98
UNO-PS/1AC/12DC/30W	2902998	270	VAL-MS 320/1+1-FM	2804393	61	VAL-SEC-T2-2+0-120DC-FM	1033788	59	VAL-US-480D/30/1+0-FM	2910384	98
UNO-PS/1AC/12DC/55W	2902999	270	VAL-MS 320/3+0	2920230	61	VAL-SEC-T2-2+0-220DC-FM	1033789	59	VAL-US-480D/30/2+0-FM	2910385	98
UNO-PS/1AC/12DC/100W	2902997	271	VAL-MS 320/3+0-FM	2920243	61	VAL-SEC-T2-2+0-380DC-FM	1033790	59	VAL-US-480D/30/3+0-FM	2910386	99
UNO-PS/1AC/15DC/55W	2903001	272	VAL-MS 320/3+1	2859178	60	VAL-SEC-T2-2+0-48DC-FM	1033786	59	VAL-US-480HLD/30/3+1V-FM	2910387	99
UNO-PS/1AC/15DC/100W	2903002	273	VAL-MS 320/3+1/FM	2859181	60	VAL-SEC-T2-220DC-P	2907879	58	VAL-US-600D/30-P	2910341	98
UNO-PS/1AC/15DC/30W	2903000	272	VAL-MS 320/3+1/FM-UD	2856689	60	VAL-SEC-T2-2C-175-FM	2905350	57	VAL-US-600D/30/1+0-FM	2910388	98
UNO-PS/1AC/24DC/30W	2902991	266	VAL-MS 350 VF ST	2856595	71	VAL-SEC-T2-2C-350	2905342	55	VAL-US-600D/30/2+0-FM	2910390	98
UNO-PS/1AC/24DC/60W	2902992	266	VAL-MS 350 VF-RW ST	1050280	63	VAL-SEC-T2-2C-350-FM	2905337	55	VAL-US-600D/30/3+0-FM	2910391	99
UNO-PS/1AC/24DC/100W	2902993	267	VAL-MS 350 VF-RW/3+0-FM/40	1050284	63	VAL-SEC-T2-2S-175-FM	2905351	57	VIP-2/SC/PDM-2/16	2315256	310
UNO-PS/1AC/24DC/150W	2904376	267	VAL-MS 350 VF/FM	2856579	62	VAL-SEC-T2-2S-350	2905343	55	VIP-2/SC/PDM-2/24	2315269	310
UNO-PS/1AC/24DC/240W	2904372	267	VAL-MS 350VF	2856582	62	VAL-SEC-T2-2S-350-FM	2905338	55	VIP-2/SC/PDM-2/32	2315272	310
UNO-PS/1AC/24DC/90W/C2LPS	2902994	269	VAL-MS 4+V/BE/FM	2908725	73	VAL-SEC-T2-350-P	2905346	42	VIP-2/SC/PDM-2/48	2903717	310
UNO-PS/1AC/48DC/60W	2902995	273	VAL-MS 400 ST	2816399	69	VAL-SEC-T2-380DC-P	2907880	58	VIP-CAB-FLK16/FR/FR/0,14/0,5M	2900154	124
UNO-PS/1AC/48DC/100W	2902996	273	VAL-MS 400/3+0/VF-FM	2910476	64	VAL-SEC-T2-3C-175-FM	2905353	56	VIP-CAB-FLK16/FR/FR/0,14/1,0M	2900155	124
UNO-PS/2AC/24DC/90W/C2LPS	2904371	269	VAL-MS 400/3+0/VF-FM/32	2909828	64	VAL-SEC-T2-3C-350	2905344	54	VIP-CAB-FLK16/FR/FR/0,14/2,0M	2900156	124
UNO-PS/350-900DC/24DC/60W	2906300	274	VAL-MS 500 ST	2807609	69	VAL-SEC-T2-3C-350-FM	2905339	54			
UNO-UPS/24DC/24DC/160W	2905907	349	VAL-MS 580-ST	2920434	70	VAL-SEC-T2-3C-350VF-FM	2909591	54			
UNO2-PS/1AC/24DC/480W	2910105	268	VAL-MS 600DC-PV-ST	2800623	73	VAL-SEC-T2-3C-440-FM	2909968	53	ZB 12:UNPRINTED	0812120	223
UPS-BAT/LH/ON/24DC/120WH	2320351	335	VAL-MS 600DC-PV/2+V	2800642	73	VAL-SEC-T2-3S-175-FM	2905354	56	ZBN 18 CUS	0825059	223
UPS-BAT/LH/ON/24DC/924WH	2908232	335	VAL-MS 600DC-PV/2+V-FM	2800641	73	VAL-SEC-T2-3S-350	2905345	54			
UPS-BAT/VRLA-WTR/24DC/13AH	2320416	338	VAL-MS 75 VF ST	2805318	70	VAL-SEC-T2-3S-350-FM	2905340	54			
UPS-BAT/VRLA-WTR/24DC/26AH	2320429	338	VAL-MS 750/30-ST	2920256	65	VAL-SEC-T2-3S-350/40	2909637	54			
UPS-BAT/VRLA/24DC/1.3AH	2320296	336	VAL-MS 750/30/3+0	2920269	65	VAL-SEC-T2-3S-350/40-FM	2909635	54			
UPS-BAT/VRLA/24DC/1.2AH	2320322	337	VAL-MS 750/30/3+0-FM	2920272	65	VAL-SEC-T2-3S-350VF-FM	2909590	54			
UPS-BAT/VRLA/24DC/3.4AH	2320306	336	VAL-MS 800/30 VF/FM	2805402	65	VAL-SEC-T2-4+0-440-FM	1076468	53			
UPS-BAT/VRLA/24DC/38AH	2320335	337	VAL-MS BE	2817741	66	VAL-SEC-T2-440-P	2909969	53			
UPS-BAT/VRLA/24DC/7.2AH	2320319	337	VAL-MS BE/1+1/U/FM	2909628	49	VAL-SEC-T2-48DC-P	2907877	58			
UPS-CAP/24DC/10A/10KJ	2320377	334	VAL-MS BE/2+0/1/U/FM	2907037	66	VAL-SEC-T2-GDT-400DC-P	1052632	58			
UPS-CAP/24DC/20A/20KJ	2320380	334	VAL-MS BE/FM	2817738	66	VAL-SEC-T2-GDT-800DC-P	1052649	58			
UPS-CONF	2320403	340	VAL-MS-BE-PCB-FM	1035864	81	VAL-SEC-T2-N/PE-175-P	2905356	56			
UT 6-TMC M 0,5A	0916603	394	VAL-MS-CN 1000DC-PV/4+V-FM	2907820	73	VAL-SEC-T2-N/PE-264/40-P	2909636	53			
UT 6-TMC M 10A	0916610	394	VAL-MS-T1/T2 1000DC-PV-V-ST	2801162	50	VAL-US-120/40-P	2910335	92			
UT 6-TMC M 12A	0916611	394	VAL-MS-T1/T2 1000DC-PV/2+V	2801160	50	VAL-US-120/40/1+0-FM	2910348	92			
UT 6-TMC M 15A	0916612	394	VAL-MS-T1/T2 1000DC-PV/2+V-FM	2801161	50	VAL-US-120/40/1+1-FM	2910349	93			
UT 6-TMC M 16A	0916613	394	VAL-MS-T1/T2 1000DC-PV/3+V-FM/32	1044182	50	VAL-US-120/40/2+0-FM	2910351	94			
UT 6-TMC M 1A	0916604	394	VAL-MS-T1/T2 1000DC-PV/3+V/32	1044183	50	VAL-US-120/40/2+1-FM	2910352	94			
UT 6-TMC M 2A	0916605	394	VAL-MS-T1/T2 335/12.5 ST	2800190	46	VAL-US-120/40/3+0-FM	2910353	95			
UT 6-TMC M 4A	0916606	394	VAL-MS-T1/T2 335/12.5/1+0	2801041	47	VAL-US-120/40/3+1-FM	2910354	96			
UT 6-TMC M 5A	0916607	394	VAL-MS-T1/T2 335/12.5/1+0-FM	2801042	47	VAL-US-120/65-P	2910330	92			
UT 6-TMC M 6A	0916608	394	VAL-MS-T1/T2 335/12.5/1+1	2800187	47	VAL-US-120/65/1+0-FM	2910355	92			
UT 6-TMC M 8A	0916609	394	VAL-MS-T1/T2 335/12.5/1+1-FM	2800186	47	VAL-US-120/65/1+1-FM	2910356	93			
UWA 130	2901664	311	VAL-MS-T1/T2 335/12.5/3+0	2800189	47	VAL-US-120/65/2+0-FM	2910357	94			
UWA 182/52	2938235	311	VAL-MS-T1/T2 335/12.5/3+0-FM	2800188	47	VAL-US-120/65/2+1-FM	2910358	94			
			VAL-MS-T1/T2 335/12.5/3+1	2800184	46	VAL-US-120/65/3+0-FM	2910359	95			
			VAL-MS-T1/T2 335/12.5/3+1-FM	2800183	46	VAL-US-120/65/3+1-FM	2910360	96			
VAL-CP-350-ST-GY	2882718	74	VAL-MS-T1/T2 335/12.5/4+0	2800645	46	VAL-US-240/40-P	2910336	93			
VAL-CP-MCB-1S-350/40/FM	2882763	74	VAL-MS-T1/T2 335/12.5/4+0-FM	2800644	46	VAL-US-240/40/1+0-FM	2910361	92			
VAL-CP-MCB-3C-350/40/FM	2882776	74	VAL-MS-T1/T2 48/12.5 ST	2801242	48	VAL-US-240/40/1+1-FM	2910362	93			
VAL-CP-MCB-3S-350/40/FM	2882750	74	VAL-MS-T1/T2 48/12.5/1+0	2801241	48	VAL-US-240/40/2+0-FM	2910364	94			
VAL-CP-MOSO 60-3C-FM	2804416	75	VAL-MS-T1/T2 48/12.5/1+0-FM	2801240	48	VAL-US-240/40/2+1-FM	2910365	94			
VAL-CP-MOSO 60-3S-FM	2804403	75	VAL-MS-T1/T2 48/12.5/1+1/U/FM	2909629	49	VAL-US-240/40/3+0-FM	2910366	95			
VAL-CP-N/PE-350-ST-GY	2882734	74	VAL-MS-T1/T2 48/12.5/1+1V	2801532	48	VAL-US-240/40/3+1-FM	2910367	96			
VAL-MB-T1/T2 1000DC-PV/2+V	2905639	51	VAL-MS-T1/T2 48/12.5/1+1V-FM	2801533	48	VAL-US-240D/40-P	2910337	98			
VAL-MB-T1/T2 1000DC-PV/2+V-FM	2905638	51	VAL-MS-T1/T2 48/12.5/O	2906281	49	VAL-US-240D/40/1+0-FM	2910368	98			
VAL-MB-T1/T2 1500DC-PV/2+V	2905641	51	VAL-MS-T1/T2 48/12.5								

For up-to-date modifications or supplements
to the catalog contents, please visit:
phoenixcontact.net/webcode/#0132

