

1

Terminal blocks

2019/2020

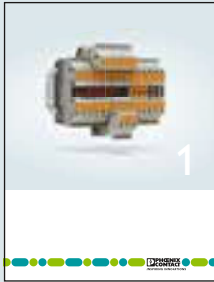

Terminal blocks

- Terminal blocks

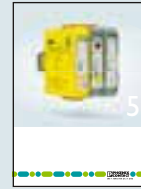

Interface technology and switching devices

- Electronic switching devices and motor control
- Measurement and control technology
- Monitoring
- Relay modules
- System cabling for controllers



Sensor/actuator cabling and connectors

- Sensor/actuator cabling
- Cables and lines
- Connectors

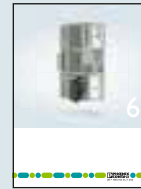

Automation

- PLCnext Technology
- Industrial cloud computing
- Software
- PLCs and I/O systems
- Functional safety
- Industrial communication technology
- HMIs and industrial PCs
- Lighting and signaling



Marking systems, tools, and mounting material

- Marking and labeling
- Tools
- Installation and mounting material



Charging technology for electromobility

- Charging technology for electromobility



Surge protection, power supplies, and device circuit breakers

- Surge protection and interference suppression filters
- Power supplies and UPS
- Protective devices

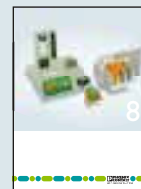

PCB terminal blocks and PCB connectors

Use our E-paper for quick product selection.

i Web code: #1517

Find out more with the web code

For detailed information, use the web codes provided in this brochure. Simply enter # and the four-digit number in the search field on our website.

i Web code: #1234 (example)

Or use the direct link:

phoenixcontact.net/webcode/#1234











You will find the latest information including all the new products directly in the product area of our website:

phoenixcontact.net/products

You can also use the Phoenix Contact catalog app interactively on your tablet.



Table of contents

Illustrated product range overview			4
COMPLETE line – The comprehensive solution for the control cabinet			16
CLIPLINE complete system features			18
Terminal blocks CLIPLINE complete	PT Push-in connection terminal blocks PTPOWER high-current terminal blocks		28
	UT screw connection terminal blocks		142
	ST spring-cage connection terminal blocks		200
	QT fast connection terminal blocks		250
	COMBI plug-in connection solutions		266
	RT, RBO bolt connection terminal blocks HV high-current connectors		374
	Accessories		398
Distribution blocks	PTFIX PT connection technology		424
Terminal blocks Classic	UK universal terminal blocks OTTA, RSC, UHV high-current terminal blocks UBAL universal terminal blocks SK shield connection clamps		454
Industry-specific solutions	Energy technology, process technology, photovoltaics, and building installation		606
Service	Planning and marking software, services for terminal strips, housings, and markings		662
Technical information and index			674

Illustrated product range overview

Access the right product more quickly from here

PT Push-in connection terminal blocks



Page 29



Feed-through and ground terminal blocks
1.5 mm² ... Page 38
2.5 mm² ... Page 70
4 mm² ... Page 98



6 mm² ... Page 110
10 mm² ... Page 120
16 mm² ... Page 124



Three-conductor terminal blocks
1.5 mm² ... Page 39
2.5 mm² ... Page 71
4 mm² ... Page 99
6 mm² ... Page 111

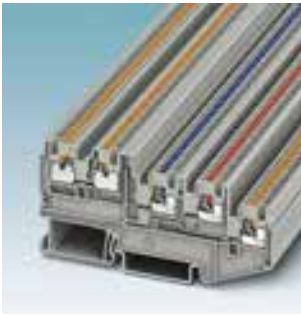

Initiator/actuator terminal blocks
1.5 mm² ... Page 41



Fuse terminal blocks
4 mm² ... Page 101
6 mm² ... Page 112
10 mm² ... Page 121



Disconnect and knife disconnect terminal blocks
1.5 mm² ... Page 42
2.5 mm² ... Page 74
4 mm² ... Page 103
6 mm² ... Page 113



Diode terminal blocks
2.5 mm² ... Page 81
4 mm² ... Page 104
6 mm² ... Page 115



Double-level terminal blocks, desk design
1.5 mm² ... Page 45
2.5 mm² ... Page 85
4 mm² ... Page 107



Feed-through, multi-conductor, and ground terminal blocks
2.5 mm² ... Page 87

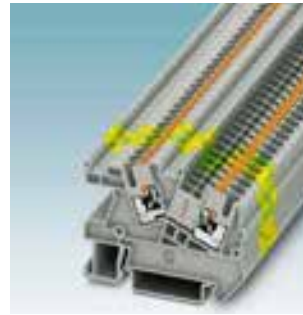

Installation terminal blocks
2.5 mm² ... Page 90
4 mm² ... Page 108
6 mm² ... Page 118
16 mm² ... Page 126



Multi-level installation terminal blocks
2.5 mm² ... Page 91
4 mm² ... Page 109

PTPOWER



High-current terminal blocks and high-current terminal block bases
35 mm² ... Page 132
50 mm² ... Page 137
95 mm² ... Page 139
185 mm² ... Page 141



10 mm² ... Page 121
16 mm² ... Page 125



Four-conductor terminal blocks
1.5 mm² ... Page 39
2.5 mm² ... Page 71
4 mm² ... Page 99
6 mm² ... Page 111



Double-level terminal blocks
1.5 mm² ... Page 39
2.5 mm² ... Page 72
4 mm² ... Page 99



Three-level terminal blocks
1.5 mm² ... Page 40
2.5 mm² ... Page 73
4 mm² ... Page 100



Test disconnect terminal blocks
4 mm² ... Page 105
6 mm² ... Page 116



Hybrid terminal blocks with single-sided screw connection
2.5 mm² ... Page 84
4 mm² ... Page 106
6 mm² ... Page 117
35 mm² ... Page 128



Feed-through and ground terminal blocks, desk design
1.5 mm² ... Page 44
2.5 mm² ... Page 84
4 mm² ... Page 107



Three/four-conductor terminal blocks, desk design
1.5 mm² ... Page 44
2.5 mm² ... Page 84
4 mm² ... Page 107



Mini feed-through and ground terminal blocks
1.5 mm² ... Page 45
2.5 mm² ... Page 97



Marshalling terminals
2.5 mm² ... Page 46



Marshalling patchboards
2.5 mm² ... Page 57

Illustrated product range overview

Access the right product more quickly from here

UT screw connection terminal blocks



Page 143

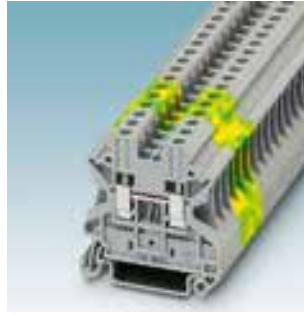

Feed-through and ground terminal blocks
 2.5 mm² ... Page 148
 4 mm² ... Page 158
 6 mm² ... Page 172



10 mm² ... Page 182
 16 mm² ... Page 184
 35 mm² ... Page 186
 50 mm² ... 240 mm² Page 188



Three-conductor terminal blocks
 2.5 mm² ... Page 149
 4 mm² ... Page 159



Disconnect terminal blocks
 2.5 mm² ... Page 151
 4 mm² ... Page 163
 6 mm² ... Page 174



Knife disconnect terminal blocks
 2.5 mm² ... Page 152
 4 mm² ... Page 165
 6 mm² ... Page 175



Test disconnect terminal blocks
 4 mm² ... Page 169
 6 mm² ... Page 176



Diode terminal blocks
 2.5 mm² ... Page 153
 4 mm² ... Page 158

ST spring-cage connection terminal blocks



Page 201



Feed-through and ground terminal blocks
 1.5 mm² ... Page 206
 2.5 mm² ... Page 210
 4 mm² ... Page 228



6 mm² ... Page 236
 10 mm² ... Page 242
 16 mm² ... Page 246
 35 mm² ... Page 248



Three-conductor terminal blocks
 1.5 mm² ... Page 207
 2.5 mm² ... Page 211
 4 mm² ... Page 229
 6 mm² ... Page 237



Initiator/actuator terminal blocks
 2.5 mm² ... Page 214



Fuse terminal blocks
 4 mm² ... Page 231



Disconnect and knife disconnect terminal blocks
 2.5 mm² ... Page 216
 4 mm² ... Page 232



Test disconnect terminal blocks
 6 mm² ... Page 237

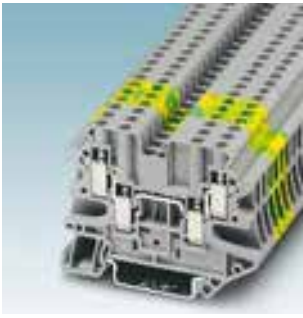

Four-conductor terminal blocks
2.5 mm² ... Page 149
4 mm² ... Page 159



Double-level terminal blocks
2.5 mm² ... Page 149
4 mm² ... Page 160



Three-level terminal blocks
2.5 mm² ... Page 150
4 mm² ... Page 160
6 mm² ... Page 173



Fuse terminal blocks
4 mm² ... Page 161
6 mm² ... Page 173



Installation terminal blocks
2.5 mm² ... Page 154
4 mm² ... Page 170
6 mm² ... Page 178
10 mm² ... Page 183



16 mm² ... Page 185
35 mm² ... Page 187



Mini feed-through and ground terminal blocks
2.5 mm² ... Page 157
4 mm² ... Page 171



10 mm² ... Page 243
16 mm² ... Page 247



Four-conductor terminal blocks
1.5 mm² ... Page 207
2.5 mm² ... Page 211
4 mm² ... Page 229



Double-level terminal blocks
1.5 mm² ... Page 208
2.5 mm² ... Page 212
4 mm² ... Page 230



Three-level terminal blocks
2.5 mm² ... Page 213



Diode terminal blocks
2.5 mm² ... Page 218
4 mm² ... Page 232
6 mm² ... Page 239



Double-level diode terminal blocks
2.5 mm² ... Page 219



Hybrid terminal blocks with single-sided screw connection
2.5 mm² ... Page 220
4 mm² ... Page 233
10 mm² ... Page 244
35 mm² ... Page 249



Feed-through and ground terminal blocks, desk design
2.5 mm² ... Page 221
4 mm² ... Page 233
6 mm² ... Page 239

Illustrated product range overview

Access the right product more quickly from here



Three-conductor terminal blocks, desk design
2.5 mm² ... Page 221
4 mm² ... Page 233
6 mm² ... Page 239



Four-conductor terminal blocks, desk design
2.5 mm² ... Page 221
4 mm² ... Page 234



Double-level terminal blocks, desk design
2.5 mm² ... Page 221
4 mm² ... Page 234



Disconnect and knife disconnect terminal blocks, desk design
2.5 mm² ... Page 222
4 mm² ... Page 235

QT fast connection terminal blocks



Page 251



Feed-through and ground terminal blocks
1.5 mm² ... Page 256
2.5 mm² ... Page 262



Three-conductor terminal blocks
1.5 mm² ... Page 257
2.5 mm² ... Page 263



Four-conductor terminal blocks
1.5 mm² ... Page 257
2.5 mm² ... Page 263



Hybrid terminal blocks with spring-cage connection on one side
1.5 mm² ... Page 261
2.5 mm² ... Page 265



Couplings with Push-in connection – assembled and for self-assembly
1.5 mm² ... Page 282
2.5 mm² ... Page 295
6 mm² ... Page 350



Headers
2.5 mm² ... Page 297
4 mm² ... Page 326



Connectors with Push-in connection – assembled and for self-assembly
1.5 mm² ... Page 284
2.5 mm² ... Page 298
4 mm² ... Page 327
6 mm² ... Page 352



Feed-through, multi-conductor, multi-level, and ground terminal blocks with screw connection
2.5 mm² ... Page 302
4 mm² ... Page 328
6 mm² ... Page 354



Mini feed-through and ground terminal blocks, with vertical conductor exit
2.5 mm² ... Page 222



Mini feed-through and ground terminal blocks, with horizontal conductor exit
2.5 mm² ... Page 225



Double-level terminal blocks
1.5 mm² ... Page 258



Fuse terminal blocks
2.5 mm² ... Page 264



Disconnect and knife disconnect terminal blocks
1.5 mm² ... Page 258



Hybrid terminal blocks with single-sided screw connection
1.5 mm² ... Page 260
2.5 mm² ... Page 264

COMBI plug-in connection solutions



Page 267



Feed-through, multi-conductor, multi-level, and ground terminal blocks with Push-in connection
1.5 mm² ... Page 276
2.5 mm² ... Page 290
4 mm² ... Page 324
6 mm² ... Page 346



Terminal blocks that can be connected on both sides
1.5 mm² ... Page 278
2.5 mm² ... Page 293
4 mm² ... Page 325



Plug-in measuring transducer disconnect terminal blocks
6 mm² ... Page 347



Terminal blocks that can be connected on both sides
2.5 mm² ... Page 304
4 mm² ... Page 330



Test disconnect terminal blocks
4 mm² ... Page 331



Headers
2.5 mm² ... Page 305
4 mm² ... Page 333



Connectors with screw connection - assembled and for self-assembly
2.5 mm² ... Page 306
4 mm² ... Page 335
6 mm² ... Page 356

Illustrated product range overview

Access the right product more quickly from here



Feed-through, multi-conductor, multi-level, and ground terminal blocks with spring-cage connection
 2.5 mm² ... Page 308
 4 mm² ... Page 338
 6 mm² ... Page 354



Terminal blocks that can be connected on both sides
 2.5 mm² ... Page 312
 4 mm² ... Page 338



Couplings with spring-cage connection – assembled and for self-assembly
 2.5 mm² ... Page 313
 4 mm² ... Page 341



Headers
 2.5 mm² ... Page 317
 4 mm² ... Page 344



Latching systems
 PR ..., UPR ... Page 363



Connector housings
 2.5 mm² ... Page 365



Cable housings for COMBI plugs
 PH ... Page 366



Self-locking flange covers
 DFS ... Page 371
 Screw flange and flange covers
 UP ...-F Page 372



Bolt connection terminal blocks for DIN rail and direct mounting
 RBO ... Page 386



Bolt connection terminal blocks with covering hood
 RBO ...-HC Page 392



High-current connectors
 HV M ... Page 395

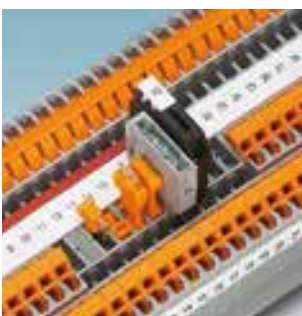

Isolating and component plugs
 P-... Page 415



Marker carriers/warning labels
 STP ... Page 418
 For end clamps and DIN rails, see Catalog 3



Connectors with spring-cage connection – assembled and for self-assembly
 2.5 mm² ... Page 318
 4 mm² ... Page 345
 6 mm² ... Page 356



Feed-through, multi-level, and ground terminal blocks with fast connection
 1.5 mm² ... Page 286



Connectors with fast connection – assembled and for self-assembly
 1.5 mm² ... Page 288



Latching and strain relief systems
 PR ..., PRZ ... Page 363

RT bolt connection terminal blocks



Page 375



Feed-through and ground terminal blocks
 2.5 mm² ... Page 378
 6 mm² ... Page 380
 35 mm² ... Page 384



Feed-through terminal blocks, open design
 2.5 mm² ... Page 379
 6 mm² ... Page 381
 35 mm² ... Page 385



Disconnect terminal blocks
 6 mm² ... Page 383

Accessories



Page 399



Plug-in bridges
 FBS ... Page 402
 FBSR ... Page 406



Test accessories
 PS ..., MPS ..., PAI ... Page 410

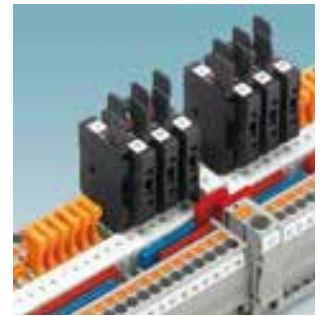

Fuse plugs
 P-FU...-5 Page 414

PTFIX distribution blocks



Page 425



Distribution blocks
 1.5 mm² ... Page 428
 2.5 mm² ... Page 438
 4 mm² ... Page 446

Illustrated product range overview

Access the right product more quickly from here

UK universal terminal blocks



Page 455



Feed-through and ground terminal blocks
UK ..., USLKG ... Page 458



Three and four-conductor terminal blocks
UK ...-TWIN Page 466
UDK ... Page 470



Double-level terminal blocks
UKK ... Page 472



Fuse, isolating, and component plugs
ST-BE, BES 6 Page 508



Knife disconnect terminal blocks
MTK ... Page 512
UK ...MTK Page 513



Double-level knife disconnect terminal blocks
UKK ...MTK Page 514



Cross connection terminal blocks
UGSK/S Page 517



Ground disconnect terminal blocks
GTF 76 Page 533



Terminal blocks with spade connection
UVKB 4-FS/FS ... Page 534



Ceramic terminal blocks
SSK ... Page 540



Spring-assisted screw terminal blocks
USST ... Page 544



Mini double-level terminal blocks
MBKKB ... Page 560



Bolt connection terminal blocks for DIN rail and direct mounting
OTTA ... Page 563



Bolt connection terminal blocks with disconnect function
OTTA 6-T Page 566



Bolt connection terminal blocks for DIN rail and direct mounting
RSC ... Page 569



Initiator/actuator terminal blocks
DIK ..., DOK ..., VIOK ...
Page 480



Lever-type fuse terminal blocks
UK 5-HESI N
Page 490



Screw cap fuse terminal blocks
UK ...-DREHSI
Page 496



Basic terminal blocks for isolating and
component plugs
UK ...-TG
Page 506



Test disconnect terminal blocks
URTK 6
Page 523



Test disconnect terminal blocks
URTK/SP
Page 525



Double-level diode terminal blocks
UKK ...-DIO
Page 528



Thermoelectric voltage terminal blocks
MTKD ...
Page 532



Spring-assisted test disconnect terminal
blocks
USST-T ...
Page 548



Micro/mini terminal blocks
MT 1,5 ...
Page 552

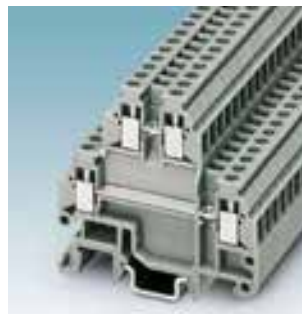

Micro/mini terminal blocks
MTTB 1,5 ...
Page 555



Mini strip terminal blocks
MBK ...
Page 558



High-current connectors
UHV ...
Page 574



Device terminal blocks
G ..., GE ...
Page 576



Trunk line branch terminals
UDB 2X...
Page 580



Universal terminal blocks for aluminum
conductors
UBAL ...
Page 583

Illustrated product range overview

Access the right product more quickly from here



Potential distributors
See Catalog 5, page 591

SK shield connection clamps



Shield connection clamps
SK ... Page 594



Shield connection clamps
SKS ... Page 597



Shielded support brackets for neutral
busbars
AB-SK ..., AB/SS ... Page 598



Double support brackets
AB-SK 65-D ... Page 600

Sector-specific solutions



FAME 1 test disconnect system with
operating plug and transformer short circuit
in the test disconnect socket Page 610

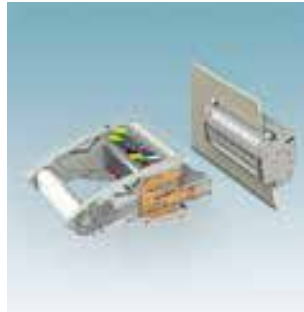

FAME 2 test disconnect system without
operating plug and transformer short circuit
in the test plug Page 618



FAME 3 test disconnect system without
operating plug and transformer short circuit
in the test disconnect socket Page 632



FAME SL plug-in test system Page 642

Planning and marking software, services for terminal strips, housings, and markings



Service Page 663



Planning and marking software
PROJECT complete Page 664



Terminal strip service Page 668



Junction box and empty enclosure service
Page 670

Accessories



Test plugs for UK series
PS ... Page 586



Test plugs for UK series
MPS ... Page 591
PS-UK ... Page 591



Warning labels
WS ... Page 593



Support brackets for direct mounting
AB ... Page 603



Modular 19" plug-in test system without
operating plug and transformer short circuit
in the plug-in test socket Page 646



Marking service Page 672

COMPLETE line

The comprehensive solution for the control cabinet

Easy planning, intuitive installation



COMPLETE line is a system comprising technologically leading and coordinated hardware and software products, consulting services, and system solutions that help you optimize your processes in control cabinet manufacturing. Engineering, purchasing, installation, and operation become significantly easier for you.

Your advantages at a glance:

- Intuitive handling, thanks to the uniform design, look, and function
- Time savings across the entire engineering process, thanks to consistent software support
- Reduced logistics costs with standardized accessories and reduced variety of parts
- Optimized processes in control cabinet manufacturing, thanks to custom services and innovative manufacturing solutions

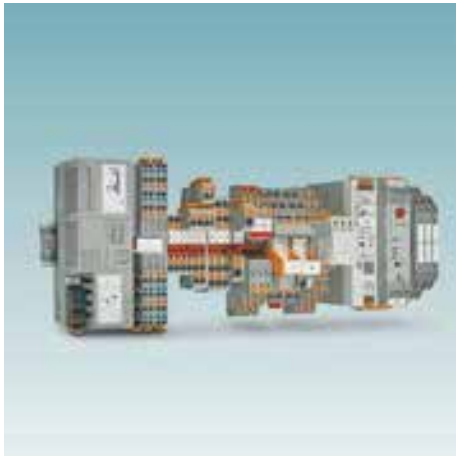

Comprehensive product portfolio

With COMPLETE line, we offer a complete product portfolio of technologically leading products. These include:

- Controllers and I/O modules
- Power supplies and device circuit breakers
- Terminal blocks and distribution blocks
- Relay modules and motor starters
- Signal conditioners
- Safety technology
- Surge protection
- Heavy-duty connectors



Intuitive handling

Thanks to the simple, intuitive handling of the coordinated hardware components, you will save time during installation, startup, and maintenance. Push-in connection technology enables you to wire applications quickly – without using tools. The broad, technologically leading product portfolio will always provide you with the right product for standard or special applications.



Time savings across the entire engineering process

The PROJECT complete planning and marking software supports the entire control cabinet manufacturing process. The program features an intuitive user interface and enables the individual planning, automatic checking, and direct ordering of terminal strips.



Reduced logistics costs

Reduced variety of parts, thanks to standardized marking, bridging, and testing accessories. The COMPLETE line system coordinates products, design, and accessories enabling you to benefit from maximum reusability, thus reducing your logistics costs.



Optimized processes in control cabinet manufacturing

From engineering through to manufacturing, COMPLETE line supports you in making your control cabinet production as efficient as possible, thus creating a customized concept for optimizing your processes in control cabinet manufacturing.

Our terminal strip production helps you to flexibly manage peak order times or to supply your control cabinet production with fully assembled DIN rails just-in-time.



Additional information

Find out more about COMPLETE line and your comprehensive solutions for the control cabinet. Visit our website:

phoenixcontact.com/completeline



CLIPLINE complete system features

With CLIPLINE complete, the unique terminal block system from Phoenix Contact, the choice of connection technology is yours. The following types of connection are available:

- Simple PT Push-in connection
- Universal UT screw connection
- Compact ST spring-cage connection
- Fast QT QUICKON connection
- COMBI plug-in connection solutions
- Robust RT bolt connection.

Irrespective of which connection technology you choose, they can all be freely combined, with the same accessories, thanks to the double function shaft.

In addition to the flexibility of the terminal block system, CLIPLINE complete also provides added value. The bridging, marking, and test accessories are standardized and can reduce your logistics and storage costs.

The CLIPLINE complete terminal block system has been tested and approved for a wide range of national and international approvals. The maximum level of safety in these standards is achieved by routine testing of the standard CLIPLINE complete terminal blocks in accordance with the ATEX Directive. These terminal blocks can be used in the Ex e area.

i Your web code: [#0567](#)

Product range overview

System features

20

CLIPLINE complete

All connection technologies, one system

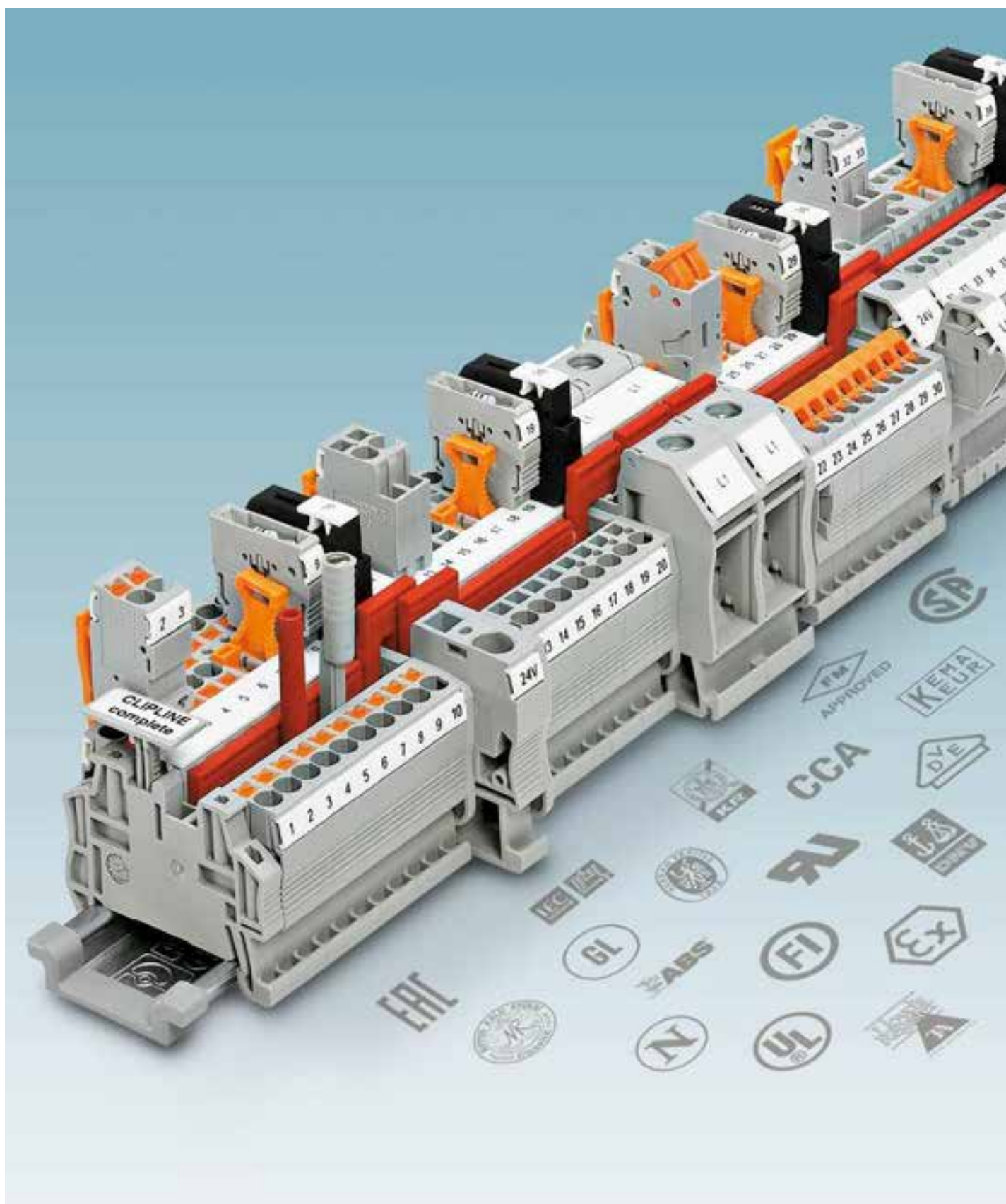

General information

The CLIPLINE complete system offers you a uniform range of accessories for all connection technologies. Marking and test accessories are standardized and reduce logistics costs. In addition, all terminal blocks of the CLIPLINE complete system can be freely combined with each other, thanks to the double function shaft. The standardized plug-in zone of the COMBI basic terminal blocks also allows the connection of modules via individually configurable connectors, regardless of the connection technology.

CLIPLINE complete terminal blocks with Push-in, spring-cage, fast connection, screw, plug-in, and bolt connection technology let you react flexibly to the demands of your customers anywhere in the world.

CLIP PROJECT enables you to configure terminal strips quickly, conveniently, and without errors. You benefit from a consistent process chain thanks to perfect interaction with CAE systems.

- The process chain covers data transfer, product selection, the correction function, and complete documentation
- In addition to terminal blocks, you can configure other products, e.g., those used in overcurrent and surge protection, power supply, signal conversion, and automation technology
- You can create markings quickly and easily and you can control all Phoenix Contact printing systems as well as standard printers

Flexible plug-in bridge system

The same plug-in bridge for all connection technologies. To allow fast and individual potential distribution, the terminal blocks in the CLIPLINE complete system have two function shafts. These are arranged in one line over all the terminal blocks, allowing for a combination of connection technologies. The 2- to 50-pos. plug-in bridges make it possible to implement all the tasks of potential bridging within a very short time. Reducing bridges connect, for example, UT screw terminal blocks and ST spring-cage terminal blocks.

The plug-in bridge bars make contact by being securely latched into the function shaft. They create a removable connection between neighboring terminal blocks.

Plug-in connection solutions

The COMBI plug-in system enables the time-saving and modular configuration of your application. As with the terminal blocks, COMBI connectors are available with Push-in, screw, spring-cage, and fast connection technologies.

The rated values of up to 41 A and 1000 V has made a connection system for signal and power wiring possible. The system meets the most stringent of vibration requirements. Both the terminal blocks and the connectors have a touch-proof design.

There is an extensive range of accessories, from the latching to the overall shielding braid.

Multifunctional disconnect zone

All disconnect terminal blocks in the CLIPLINE complete system have a standardized disconnect zone. Various function plugs are available for use in the disconnect terminal blocks. Isolating plugs are used for simple disconnection. Fuse plugs are designed for the use of cartridge fuse-links. The patented component connector allows you to mount components quickly, without the risk of polarity reversal, and without the need for soldering.

Large-surface marking

All the terminal points of the terminal blocks in the CLIPLINE complete system have large-surface marking options. This is a precondition for clear wiring and startup, and simplifies assignment during testing and maintenance work. Optional snap-on large marker carriers are available for group and terminal strip markings.

Standardized test system

The CLIPLINE complete system includes a comprehensive range of test accessories. All test plug contacts are made in the easily accessed function shaft. For individual measuring lines, a test plug with 2.3 mm diameter is available. More complex testing tasks can be implemented using alignable test plugs. The corresponding spacers can be used to assemble individual test adapters which are perfectly suited for use in test laboratories.

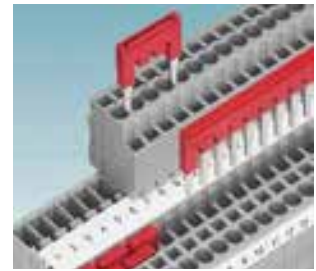

Bridge



Insert



Disconnect



Mark



Test

Push-in connection

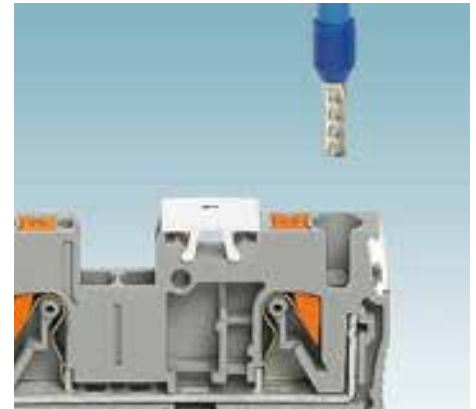

Material properties

All metal parts of the Push-in connection terminal blocks are made of corrosion-free materials. The conductive metals consist of high-grade copper alloys. A particular advantage is the low temperature rise due to good electrical conductivity. The surface of the metal parts is protected by lead-free, galvanic nickel or tin plating.

The contact force for the Push-in connection is applied by a leg spring of high-strength chromium-nickel spring steel.

The insulating housing of the terminal blocks is made from recyclable PA 6.6. This elastic plastic with high impact strength is halogen-free and UV-resistant. Further characteristics include the good tropical and termite resistance, high chemical resistance, and excellent aging characteristics. Polyamide 6.6 is used with operating temperatures up to 130°C and is certified for the flammability rating V0 in accordance with UL 94.

Connection principle

PT Push-in connection terminal blocks have been developed for direct conductor connection. This means that rigid conductors or conductors with ferrules can be inserted directly into the terminal block without tools.

The special spring profile enables the easy insertion of conductors with ferrules from 0.34 mm² and rigid conductors up to 185 mm². The contact spring is opened automatically when the conductor is pushed in. This provides the required pressure force against the current bar. The spring is opened by a push button either to release conductors or connect flexible conductors starting at 0.14 mm² without a ferrule easily and without direct contact with live parts. The button can be operated with all standard screwdrivers.

The PT connection technology has been tested and approved for a wide range of approvals. These include, for example, vibration resistance in accordance with railway standard EN 50155 and shock and corrosion resistance in accordance with current shipbuilding registers. The connection technology is also certified for process engineering in areas with increased safety (Ex e).

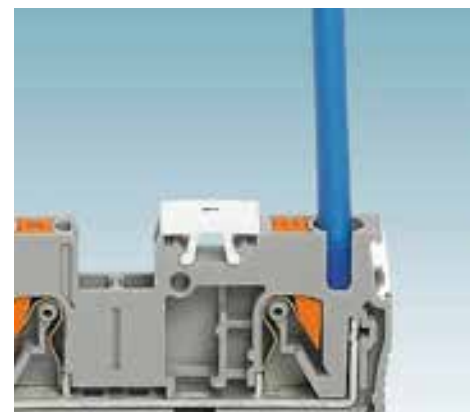

Screw connection

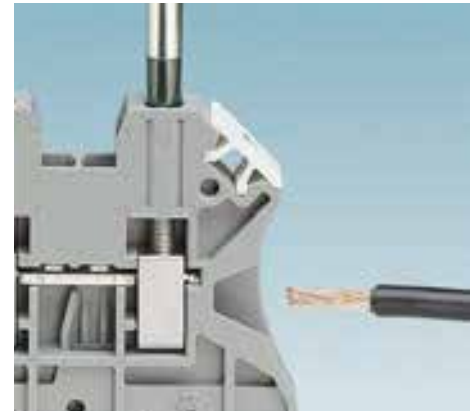

Material properties

The metal parts of the UT screw connection terminal blocks are made from high-grade, strain-crack-proof, and corrosion-proof copper alloys as a standard feature. This eliminates the possibility of electrolytic corrosion in the presence of moisture and the risk of rusting. The consequences, such as unreliable electrical contacts and/or jammed screws, are also prevented. Another advantage is the low temperature rise due to good electrical conductivity. The surface of the metal parts is protected by lead-free, galvanic nickel or tin plating.

The insulating housing of the UT screw connection terminal blocks is made from recyclable PA 6.6. This elastic plastic with high impact strength is halogen-free and UV-resistant. Further characteristics include the good tropical and termite resistance, high chemical resistance, and excellent aging characteristics. Polyamide 6.6 is used with operating temperatures up to 130°C and is certified for the flammability rating V0 in accordance with UL 94.

Connection principle

UT screw connection terminal blocks are designed for the most stringent requirements. For more than 80 years, they have proven themselves a billion times over in all applications. An important characteristic is the maintenance-free conductor connection. There is no need to retighten the terminal block screws. The screws are prevented from loosening by the Reakdyn principle, a screw locking technique developed and patented by Phoenix Contact.

Conductors for Phoenix Contact UT screw connection terminal blocks can be clamped without any pretreatment. Splicing protection can also be implemented in the form of ferrules. A special characteristic of the screw clamping body is the multi-conductor connection, which is often required.

Very large conductor cross sections up to 240 mm² can also be wired gas-tight and with long-term stability thanks to the high contact forces.



Spring-cage connection



Material properties

All metal parts of the spring-cage terminal blocks are made from corrosion-free materials. The conductive metals consist of high-grade copper alloys. A particular advantage is the low temperature rise due to good electrical conductivity. The surface of the metal parts is protected by lead-free, galvanic nickel or tin plating.

The contact force for the spring-cage connection is applied by a spring element made from high-strength chromium-nickel spring steel.

The insulating housing of the spring-cage terminal blocks is made from recyclable PA 6.6. This elastic plastic with high impact strength is halogen-free and UV-resistant. Further characteristics include the good tropical and termite resistance, high chemical resistance, and excellent aging characteristics. Polyamide 6.6 is used with operating temperatures up to 130°C and is certified for the flammability rating V0 in accordance with UL 94.

Connection principle

ST spring-cage terminal blocks have been developed for universal spring-loaded conductor contacting.

The contact force is independent of the user and creates a vibration-proof, gas-tight connection with long-term stability.

The terminal point is opened with a standard screwdriver. After the conductor has been inserted into the clamping space, the screwdriver is removed and the conductor automatically makes contact. The easy operation is a result of the front connection, i.e., the conductor and screwdriver are inserted in parallel from the same direction.

All types of copper wires up to 35 mm² can be clamped without any pretreatment. Splicing protection can also be implemented in the form of ferrules.

Spring-cage terminal blocks from Phoenix Contact provide a large amount of space. This makes it possible to wire conductors with ferrules and insulating collars with a nominal cross section.



Fast connection



Material properties

The patented contact metals of the QT fast connection terminal blocks are made from a special, high-grade copper alloy. This combines good electrical conductivity with excellent elastic characteristics.

The surface of the metal parts is protected by lead-free, galvanic nickel or tin plating.

The insulating housings of the fast-connection terminal blocks are made from recyclable PA 6.6. This elastic plastic with high impact strength is halogen-free and UV-resistant. Further characteristics include the good tropical and termite resistance, high chemical resistance, and excellent aging characteristics. Polyamide 6.6 is used with operating temperatures up to 130°C and is certified for the flammability rating V0 in accordance with UL 94.

Connection principle

QT QUICKON terminal blocks are designed for fast conductor connection. It is no longer necessary to strip or fit the splicing protection. The cables just need to be cut to length for contact to be made in a matter of seconds.

An important characteristic is the space-saving twist connection. Due to the simplicity of the connection, the wiring time is reduced by up to 60 percent. A standard screwdriver is used to operate the terminal blocks and the switching states are clearly signaled by engagement points in the start and end position.

Rigid and flexible conductors from 0.25 to 2.5 mm² can be wired without aids such as guide ferrules. When a conductor is connected, the conductor insulation is cut open, displaced, and the conductor is securely engaged in the end position where it makes a large-area, gas-tight contact.

The high quality of the QUICKON fast connection is verified by the fact that this connection is certified in accordance with the standard for Ex e applications, as are the screw and spring connections.

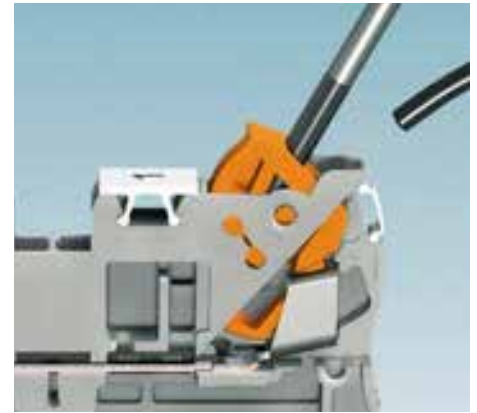

Plug-in connection

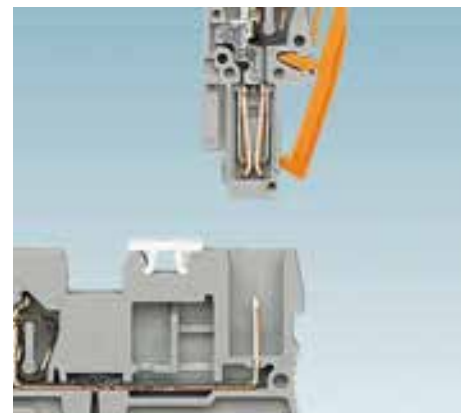

Material properties

All metal parts of the COMBI connectors are made from corrosion-free materials. The separation of the electrical and mechanical functions is a particular advantage. The conductive metals consist of high-grade copper alloys. The surface of the metal parts is protected by lead-free, galvanic nickel or tin plating. The high current carrying capacity of the contact is achieved by an integrated covering spring made of chromium-nickel spring steel.

The insulating housing of the COMBI connectors is made from recyclable PA 6.6. This elastic plastic with high impact strength is halogen-free and UV resistant. Further characteristics include the good tropical and termite resistance, high chemical resistance, and excellent aging characteristics.

Polyamide 6.6 is used with operating temperatures up to 130°C and is certified for the flammability rating V0 in accordance with UL 94.

Connection principle

COMBI plug-in connections are designed for the most stringent universal demands in terms of plug-in capability. The nominal current of the connected conductor is carried through the plug-in contact.

The uniform plug-in zone is an important characteristic. Connectors and basic terminal blocks with four connection technologies can be freely combined with each other, thanks to the uniform plug-in zone.

The modular structure also enables individual self-assembly of the plugs and the couplings.

Copper wires of all types can be connected without pretreatment. Splicing protection can also be implemented in the form of ferrules.

COMBI connectors with any type of connection technology provide a large amount of space. This makes it possible to wire conductors with ferrules and insulating collars with a nominal cross section.



Bolt connection

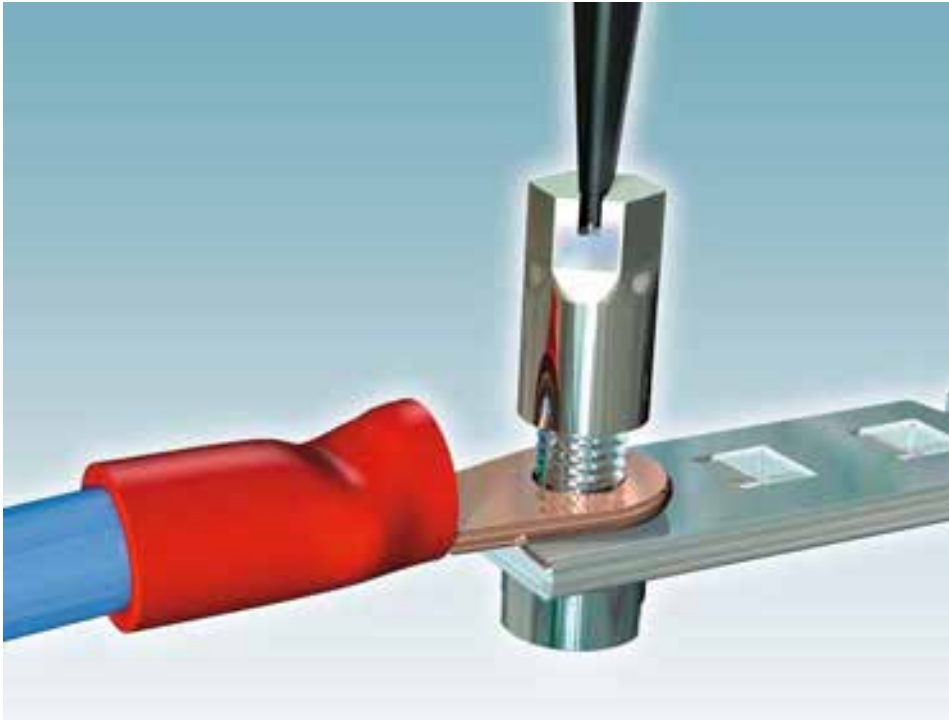

Material properties

All metal parts of the bolt connection terminal blocks are made from corrosion-free materials. The conductive metals consist of high-grade copper alloys. Due to their good electrical conductivity, they ensure a low temperature rise. The surface of the metal parts is protected by lead-free, galvanic nickel or tin plating.

The insulating housing of the bolt connection terminal blocks is made from recyclable PA 6.6. This elastic plastic with high impact strength is halogen-free and UV resistant. Further characteristics include the good tropical and termite resistance, high chemical resistance, and excellent aging characteristics.

Polyamide 6.6 is used with operating temperatures up to 130°C and is certified for the flammability rating V0 in accordance with UL 94.

Connection principle

RT bolt connection terminal blocks have been developed with a robust design and offer convenient wiring for ring cable lugs.

An important characteristic is the hinged cover which can be swiveled open and which features a captive cap nut. This ensures quick and easy ring cable lug wiring.

The integrated screw locking in the form of a spring retainer guarantees reliability, even in applications which are subject to shock and vibration.

All ring cable lugs can be connected in accordance with DIN 46234, DIN 46235 or DIN 46237.

A special characteristic of the bolt connection is the often required multi-conductor connection, on which up to four cable lugs can be connected per bolt.

All types of conductors up to 300 m² can be wired securely and with long-term stability.

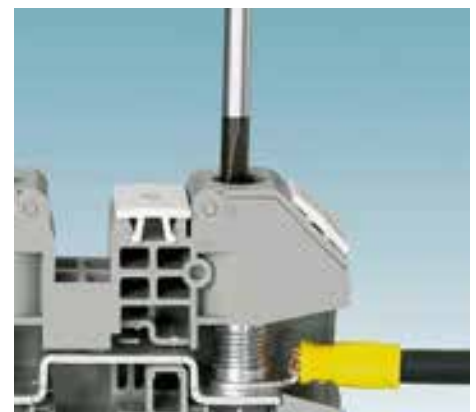
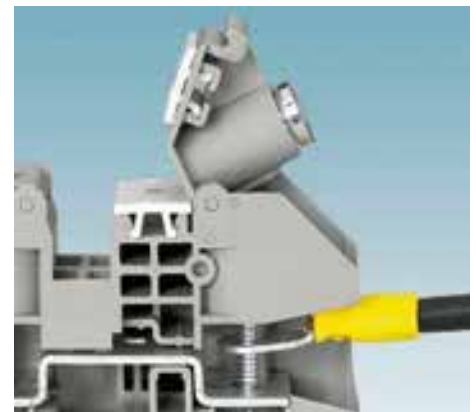



PT Push-in connection terminal blocks

The PT Push-in connection terminal blocks from the CLIPLINE complete system have been developed for direct conductor connection and offer a wide range of application options. Easy handling and direct, tool-free connection with up to 50 percent lower insertion forces are the key advantages of this terminal technology. When rigid conductors from 0.25 mm² or conductors with ferrules from 0.34 mm² are inserted, the contact spring is automatically opened. This provides the required pressure force against the current bar.

The integrated push button allows you to release conductors or to connect small conductor cross sections from 0.14 mm² with any type of tool easily and without direct contact with live parts.

The PT connection technology has been tested and approved for a range of approvals. These include, for example, vibration resistance in accordance with railway standard EN 50155 and shock and corrosion resistance in accordance with current shipbuilding registers. It is also certified for process engineering in areas with increased safety (Ex e).

 Your web code: #1126

Product range overview

1.5 mm²

Feed-through, multi-conductor, multi-level, and ground terminal blocks	39
Initiator/actuator terminal blocks	41
Knife disconnect terminal blocks	42
Desk-design terminal blocks	44
Mini feed-through and ground terminal blocks	45
Marshalling terminals	46
Marshalling patchboards	57

2.5 mm²

Feed-through, multi-conductor, multi-level, and ground terminal blocks	71
Disconnect and knife disconnect terminal blocks	74
Diode terminal blocks	81
Hybrid terminal blocks with screw connection on one side	84
Desk-design terminal blocks	84
Desk-design disconnect and knife disconnect terminal blocks	86
Terminal blocks with conductor connections on the side	88
Installation terminal blocks	90
Mini feed-through and ground terminal blocks	97

4 mm²

Feed-through, multi-conductor, multi-level, and ground terminal blocks	99
Fuse terminal blocks	101
Disconnect and knife disconnect terminal blocks	103
Diode terminal blocks	104
Test disconnect terminal blocks	105
Hybrid terminal blocks with screw connection on one side	106
Desk-design terminal blocks	107
Installation terminal blocks	108

6 mm²

Feed-through, multi-conductor, multi-level, and ground terminal blocks	111
Fuse terminal blocks	112
Disconnect and knife disconnect terminal blocks	113
Diode terminal blocks	115
Test disconnect terminal blocks	116
Hybrid terminal blocks with screw connection on one side	117
Installation terminal blocks	118

10 mm², 16 mm², and 35 mm²

Feed-through, multi-conductor, and ground terminal blocks	121
Fuse terminal blocks	121
Installation terminal blocks	126
Hybrid terminal blocks with screw connection on one side	128

PTPOWER Power-Turn high-current terminal blocks 35 mm ² - 185 mm ²	132
--	-----

Terminal blocks – CLIPLINE complete

PT Push-in connection terminal blocks

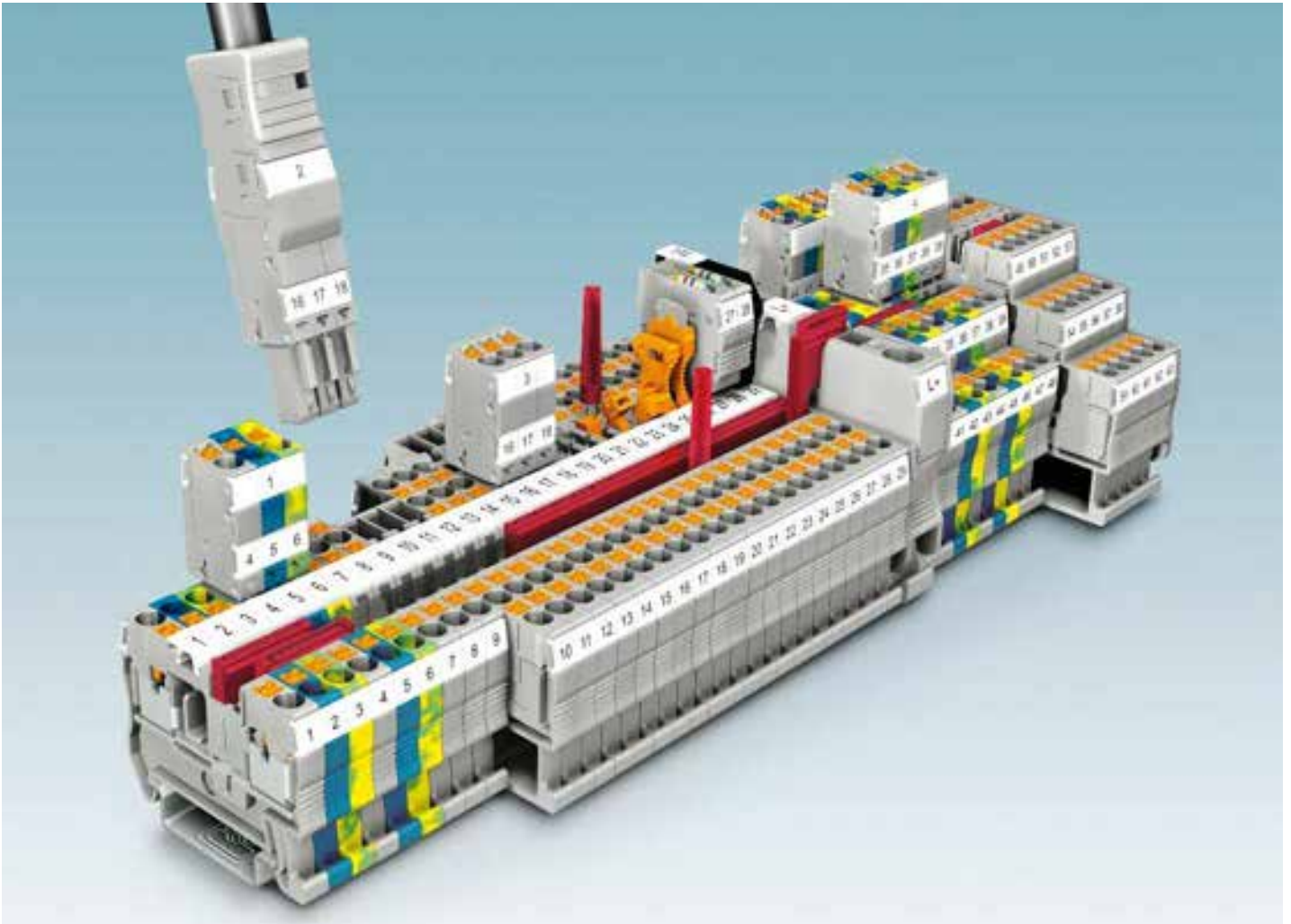

i Your web code: #1126



Push-in connection technology

The PT series is characterized by the easy, direct conductor connection and makes consistent use of the benefits of the CLIPLINE complete system.



Easy insertion

Up to 50% reduction in insertion forces permits easy and direct insertion of rigid and flexible conductors with ferrules with a cross section of 0.25 mm² or greater. Flexible conductors can be connected without ferrules using the push button.



Latch function

The integrated button allows connected conductors to be released using any type of tool easily and without direct contact with live parts.

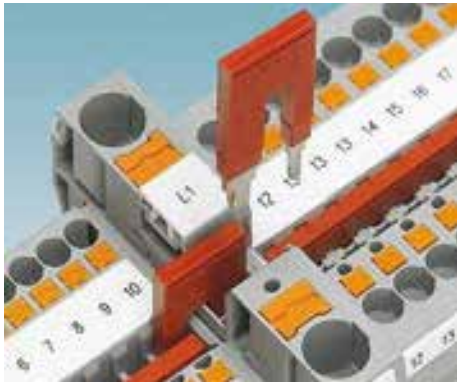

The reducing bridge enables terminal blocks with different nominal cross sections to be connected easily, e.g., a PT 10 Push-in terminal block to a PT 2.5. Power blocks can be created quickly using the reducing bridge.

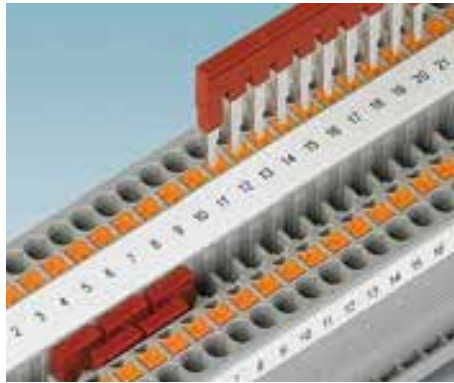

The double function shaft can be used to connect any number of terminal blocks with two-position bridges. The 2- to 50-pos. bridges allow up to 50 terminal blocks to be bridged in one step.

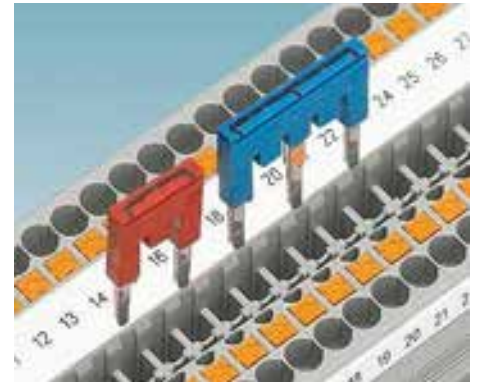

Bridging between non-adjacent terminal blocks is established by removing individual contact tabs from the standard bridge. Two potentials can then be routed in parallel through a terminal strip. The contact points can also be marked.

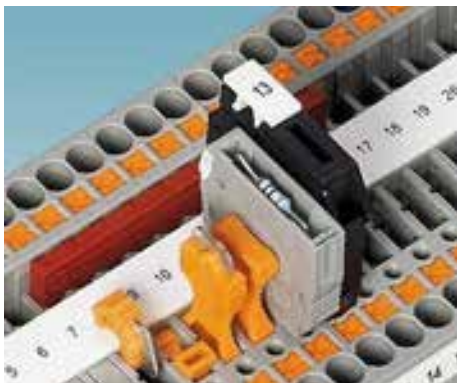

The isolated feed-through connector P-FIX, isolating connector P-DI, component connector P-CO and the cartridge fuse connector P-FU can be used in the universal plug-in zone of the disconnect terminal block.

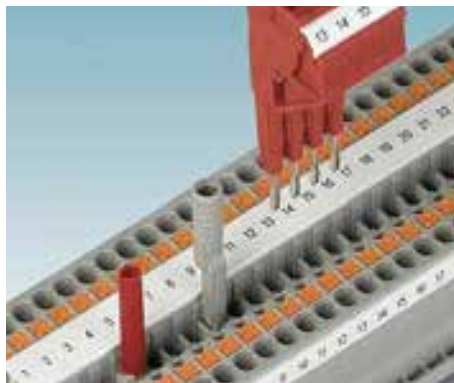

For measuring lines, a test plug with 2.3 mm diameter is available. All measurement and testing tasks can be carried out quickly using test adapters for 4 mm diameter test plugs and the alignable test plugs.

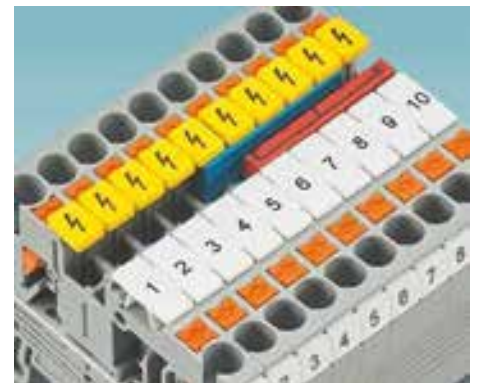

Warning labels are available for the clear marking of mains connections. These are plugged into the 2.3 mm wide test holes on the PT terminal blocks, latch reliably into place, and are also form-fitting.



Push-in COMBI terminal blocks are available for the plug-in configuration of signal wiring. The system is touch-proof and offers plugs for self-assembly with extensive accessories.



Automotive flat-type fuse terminal blocks with 4 mm² conductor connection are available in the same shape as the feed-through terminal blocks. All terminal blocks can be consistently bridged with one another with the double function shaft.



The compact lever-type fuse terminal blocks are the same shape as the feed-through terminal blocks. They can be consistently marked and bridged. A time-saving potential distribution is easily created using bridging between non-adjacent terminal blocks.

Terminal blocks – CLIPLINE complete

PT Push-in connection terminal blocks

PT ... feed-through and multi-conductor terminal blocks



- Optimum ergonomics for tool-free wiring thanks to the integrated actuation lever
- Easy insertion with pre-assembled conductors from 0.25 mm²
- Clear identification of terminal point and operating area provides optimum protection against wiring errors
- Universal handling using any suitable tool
- Double function shafts for potential distribution
- Individual testing facility for every current path

i Your web code: #0068

PTTB ... multi-level terminal blocks



- Space-saving with several individual potentials housed in a single terminal housing
- Easy potential distribution, whereby function shafts at each level and individually usable level bridges turn a multi-level terminal block into a potential distributor
- Versions with plug-in COMBI connections guarantee maximum modularity and flexibility
- For motor connections, versions are available with up to three phases and PE in just one housing
- Clear wiring, thanks to marking option on each terminal point

i Your web code: #1391

PTIO ... three-conductor initiator/actuator terminal blocks

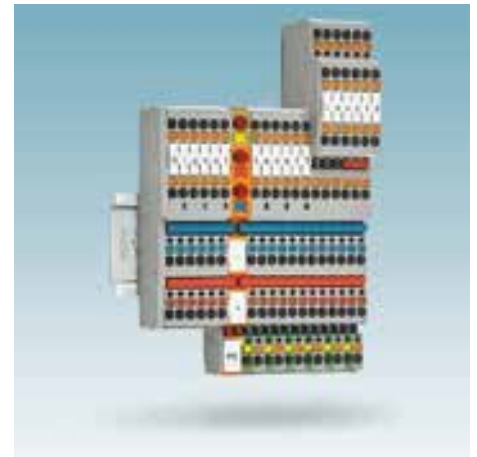

- Space-saving wiring of initiators and actuators with an overall width of just 3.5 mm
- Compact design for maximum signal density
- Power terminals enable individual distribution of the positive and negative potential via FBS ... bridges
- Versions with LED display indicate switching states
- Large-surface marking of the wiring levels

i Your web code: #0069

PTME ... test disconnect terminal blocks

- Convenient wiring of current transformer measuring circuits
- Safe longitudinal and perpendicular disconnection of the current paths
- The switch units are latched in the respective limit positions
- Unintentional switching is prevented by means of optional switching locks
- Up to six function shafts integrated per terminal block for potential distribution and testing

i Your web code: [#0071](#)

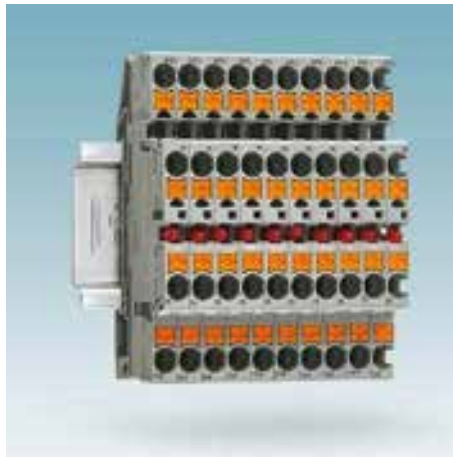
PTTB ...BE component terminal blocks

- Component terminal blocks can be used for complex switching tasks in all applications
- Individual and convenient integration of components such as diodes, resistors, LEDs, and fuses into circuits
- Huge product variety with selectable prefabricated or retrofittable versions
- Maximum flexibility and modularity with solder-free, self-assembled, and pre-assembled component connectors for basic terminal blocks with disconnect function
- Maximum safety requirements are taken into consideration. Printed circuit diagrams and symbols reduce the risk of faulty wiring considerably

i Your web code: [#1392](#)

PT ... and PTT ... knife disconnect terminal blocks

- Convenient disconnection of measuring and closed-loop control circuits by means of a disconnect knife
- Disconnect knife reliably snapped into the limit positions
- Flexible testing facilities on both sides of the disconnect point
- Optional snap-in switching lock effectively prevents unintentional switching
- Universal disconnect zone for also accommodating isolating plugs, feed-through connectors, component connectors, and fuse plugs

i Your web code: [#0070](#)

Terminal blocks – CLIPLINE complete

PT Push-in connection terminal blocks

PTU ... hybrid terminal blocks



- PT mixed connection with screw connection technology on one side
- Quick and easy Push-in connection for the internal control cabinet wiring
- Universal screw connection for external wiring by the end user
- Consistent double bridging possible and compatible with all standard terminal blocks
- Internal TWIN connection for compact potential distribution

i Your web code: [#0068](#)

Feed-through and multi-conductor terminal blocks in PTS ..., PTS ...-TWIN desk design

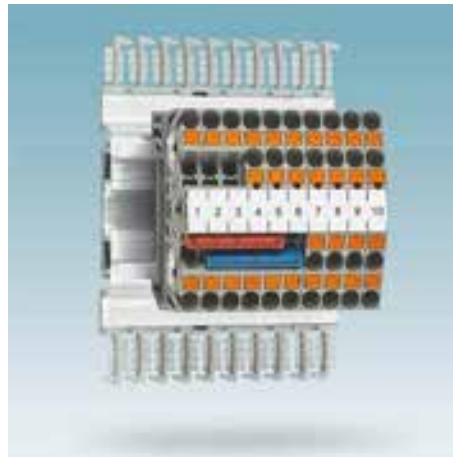

- Angled design enables minimized bending radii for better conductor routing
- Designed for use on wiring frames instead of typical channel wiring
- Compact design from 3.5 mm horizontal pitch
- Two, three, and four-conductor terminal blocks with the same contour

i Your web code: [#0072](#)

PT ...-HESI fuse terminal blocks



- Easy-access fuse-links are easy to replace
- Easy potential distribution thanks to comprehensive function shafts
- Convenient fuse testing thanks to test points on both sides
- Quick identification of faulty fuses, thanks to LED status indicator
- Versions for use in the Ex area with Ex-nA type of protection

i Your web code: [#1393](#)

PTRV ... marshalling terminals

- Marshalling terminals with a space-saving design
- Signal wiring on four or eight levels
- Color coding in up to 11 colors for clear identification of the wiring levels
- Patented double connection for reliable contacting
- Testing facility on every double connection

i Your web code: **#0160**

PTRVB ... potential distributors

- Space-saving potential distribution with up to 32 connections
- Potential distribution blocks can be individually adapted with plug-in bridges for assembly
- Versions with 6 mm² supply option and 32 A
- Versions are available in blue and red for clear assignment
- Large-surface marking options

i Your web code: **#0160**

PTMC ... marshalling patchboards

- Modular marshalling patchboards with stackable concept
- Front and rear wiring
- Individual color coding of the terminal points
- Easy and clear wiring, thanks to Push-in connection technology
- Convenient testing facility and marking option for the terminal points
- Various mounting methods on different carrier systems

i Your web code: **#0161**

Terminal blocks – CLIPLINE complete

PT Push-in connection terminal blocks

PTI ... installation terminal blocks



- Compact distribution board terminal blocks for single/three-phase applications
- Double function shafts for fast potential distribution on every level
- Fast and reliable neutral conductor disconnection with snap-lock mechanism in the limit positions
- Can be mounted and removed flexibly as a group without having to remove the busbar
- Large-surface marking and testing facility for every terminal point

i Your web code: **#0073**

MPT ... miniature terminal blocks



- Miniature terminal block for 15 mm DIN rail systems
- Extremely compact design for use in small control boxes
- Testing facility for every current path
- Can be bridged with the patented FBS ... bridge system
- Protective conductor terminal blocks of the same shape
- Plug-in version with COMBI plug-in connection on one side, e.g., for quick wiring of pre-assembled cables
- Powerful contact up to 24 A

i Your web code: **#0074**

Motor terminal blocks

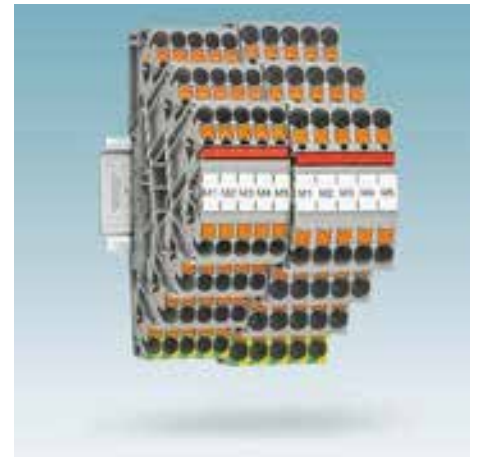

- Compact four-level terminal blocks for wiring three-phase loads
- Three phases and protective conductor connection in a single terminal block
- Bridging facility on each level for potential distribution or star-delta applications
- Testing facility on each level
- Large-surface marking for every terminal point
- Powerful contact up to 32 A

i Your web code: **#0159**

Hybrid potential collection terminal blocks with PTU ... Push-in and screw connection



- Simple potential collection or distribution
- Compact, space-saving design
- Can be bridged with standard plug-in bridges
- Easy to test with 2.3 mm standard test connection
- Large-surface marking options

i Your web code: [#1394](#)

PTPOWER Power-Turn high-current terminal blocks



- High-current spring terminal blocks with patented Power-Turn connection
- Quick and easy wiring of conductor cross sections up to 185 mm²
- Alternative direct plug-in of the conductor, e.g., in confined mounting positions
- Easy potential distribution by means of insertion bridges that can be locked
- Tap-off terminal blocks that can be snapped on from both sides enable voltage tap-off of up to 4 x 16 mm² per terminal block
- Installation on 35 mm DIN rail or as flange solution for direct mounting

i Your web code: [#0158](#)

PTV ... feed-through, TWIN, QUATTRO, and knife disconnect terminal blocks



- Clear wiring without bend radii, thanks to the conductors being inserted from the side
- Easily identifiable connection markings on the side of the terminal
- Wire markings easy to attach and read off, thanks to the conductors being inserted from the side
- The conductor connection does not require any additional space above the terminal
- The connection principle and conductor insertion are self-explanatory, thanks to the Push-in connection technology in combination with the wiring direction of the screw terminal blocks
- The spring connection does not require any subsequent testing of the terminal point
- Use of standard accessories from the CLIPLINE complete system

Terminal blocks – CLIPLINE complete

1.5 mm² PT Push-in connection terminal blocks

General technical data

Rated data		IEC 60947-7-1 / IEC 60947-7-2			
Rated cross section	[mm ²]	1.5			
Cross section range	AWG	26 - 14			
Connection capacity		Rigid	Flexible	Ferrule without/with plastic sleeve	
1 conductor	[mm ²]	0.14 - 1.5	0.14 - 1.5	0.14 - 1.5	0.14 - 1
2 flexible conductors with a TWIN ferrule	[mm ²]	-	-	-	-
Connection cross sections directly plug-in	[mm ²]	0.25 - 1.5	-	0.34 - 1.5	0.34 - 1
General data					
Stripping length	[mm]	8 - 10			
Insulating material		PA			
Flammability rating in accordance with UL 94		V0			

Note: Additional or deviating data is listed alongside the respective product.

Notes:

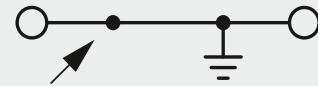

In addition to the product, the internal electrical wiring is provided as a circuit diagram. Free connection points for bridging are indicated by a black dot.

The specified technical data and approvals refer to the first product in each column. For information on the products below, please refer to phoenixcontact.net/products

For full details of UL and CSA use groups, file nos., and Internet links, please visit phoenixcontact.net/products

¹⁾ The bridge current is listed alongside the respective product. For additional colors, see page 402.

System accessories

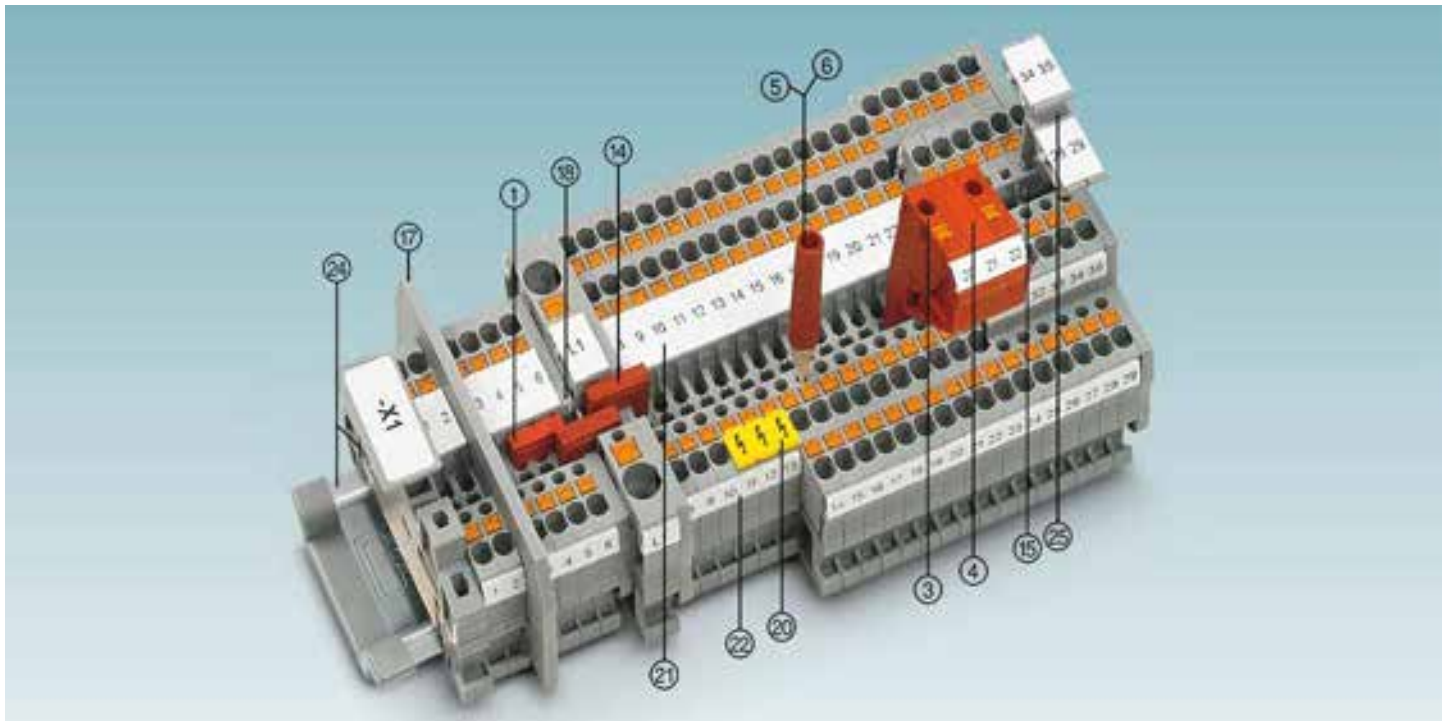

Description	No. of pos.	Color	Type	Order No.	Pcs./Pkt.	Type	Order No.	Pcs./Pkt.
① Bridge ¹⁾	2	red	FBS 2-3,5	3213014	50			
	3	red	FBS 3-3,5	3213027	50			
	4	red	FBS 4-3,5	3213030	50			
	5	red	FBS 5-3,5	3213043	50			
	10	red	FBS 10-3,5	3213056	50			
	20	red	FBS 20-3,5	3213069	50			
③ Modular test plug		red	PS-3,5	3031010	10			
④ Spacer plate		red	DP PS-3,5	3031011	10			
⑤ Test plug metal part		gray	MPS-MT	0201744	10			
⑥ Insulating sleeve, for MPS metal part		red	MPS-IH RD	0201676	10			
Screwdriver			SZF 0-0,4X2,5	1204504	10			

⑭ Reducing bridge
⑮ Vertical potential bridge
⑰ Partition plates/end cover segments
⑱ Cover
⑲ Center groove labeling
⑳ Center and side groove labeling
㉑ DIN rail and end bracket
㉒ Marker carrier
For full accessories, visit phoenixcontact.net/products

For RB ..., see page 408.
For FBS 1,5/S-PV ..., see page 404.
For ATP-... / DS-..., visit phoenixcontact.net/products
Listed alongside the respective product.
UCT-TM 3,5 or ZB 3,5. See also Catalog 3, selection tables, from page 60.
UCT-TMF 3,5 or ZBF 3,5. See also Catalog 3, selection tables, from page 60.
See Catalog 3
For STP ..., see page 418.
Note: Additional or deviating accessories are listed alongside the respective product.

1.5 mm² PT Push-in connection terminal blocks

Feed-through, multi-conductor, multi-level, and ground terminal blocks

Notes:
 1) For additional accessories and technical data, see page 38.
 For 1 mm² conductors with ferrule and plastic sleeve, using the AI-S 1-8 TQ ferrule is recommended, Order No. 1200293.
 For information on installation and using accessories for Ex applications, see page 678.

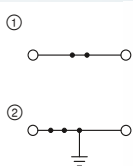

17.5 A, feed-through terminal block

ClassNK CB
 Ex: EAC Ex IEC IECEx
 SEV13ATEX0159U / IECEx SEV13.0005U

Technical data ¹⁾				
Width	Length	Height		
3.5	45	32 (NS 35/7,5)		
I _{max} [A]	U _{max} [V]	max. Ø [mm ²]	AWG (UL)	
17.5	500	0.14 - 1.5	26-14	
17.5				
Rated data				
IEC	UL / CUL	CSA	Ex	
500	600	600	352	
Nominal current / cross section	[A] / [mm ²]	15 / -	15 / 1.5	

Ordering data			
Type	Order No.	Pcs./Pkt.	
PT 1,5/S	① 3208100	50	
PT 1,5/S BU	① 3208126	50	
PT 1,5/S-PE	② 3208139	50	

Accessories ¹⁾			
Type	Order No.	Pcs./Pkt.	
D-PT 1,5/S	3208142	50	
D-PT 1,5/S-0,8 OG	1029569	50	

Dimensions	
	[mm]
Maximum electrical data	
Maximum bridge current	[A]
Rated voltage	[V]
Nominal current / cross section	[A] / [mm ²]

Description	Color
Terminal block	gray
	blue
Ground terminal	green-yellow

Cover, width: 2.2 mm	gray
Cover, 0.8 mm width	orange

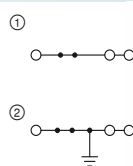

17.5 A, feed-through terminal block, 3 connections

ClassNK CB
 Ex: EAC Ex IEC IECEx
 SEV13ATEX0159U / IECEx SEV13.0005U

Technical data ¹⁾				
Width	Length	Height		
3.5	54	32 (NS 35/7,5)		
I _{max} [A]	U _{max} [V]	max. Ø [mm ²]	AWG (UL)	
17.5	500	0.14 - 1.5	26-14	
17.5				
Rated data				
IEC	UL / CUL	CSA	Ex	
500	600	600	352	
Nominal current / cross section	[A] / [mm ²]	15 / -	15 / 1.5	

Ordering data			
Type	Order No.	Pcs./Pkt.	
PT 1,5/S-TWIN	① 3208155	50	
PT 1,5/S-TWIN BU	① 3208168	50	
PT 1,5/S-TWIN-PE	② 3208171	50	

Accessories ¹⁾			
Type	Order No.	Pcs./Pkt.	
D-PT 1,5/S-TWIN	3208184	50	
D-PT 1,5/S-TWIN-0,8 OG	1029571	50	

Feed-through, multi-conductor, multi-level, and ground terminal blocks

Notes:
 1) For additional accessories and technical data, see page 38.
 For 1 mm² conductors with ferrule and plastic sleeve, using the AI-S 1-8 TQ ferrule is recommended, Order No. 1200293.
 For information on installation and using accessories for Ex applications, see page 678.

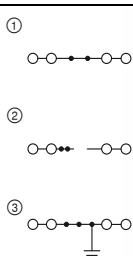

17.5 A, feed-through terminal block, 4 connections

ClassNK CB
 Ex: EAC Ex IEC IECEx
 SEV13ATEX0159U / IECEx SEV13.0005U

Technical data ¹⁾				
Width	Length	Height		
3.5	63.2	32 (NS 35/7,5)		
I _{max} [A]	U _{max} [V]	max. Ø [mm ²]	AWG (UL)	
17.5	500	0.14 - 1.5	26-14	
17.5				
Rated data				
IEC	UL / CUL	CSA	Ex	
500	600	600	352	
Nominal current / cross section	[A] / [mm ²]	15 / -	15 / 1.5	

Ordering data			
Type	Order No.	Pcs./Pkt.	
PT 1,5/S-QUATTRO	① 3208197	50	
PT 1,5/S-QUATTRO BU	① 3208208	50	
PT 1,5/S-QUATTRO-U	② 3208359	50	
PT 1,5/S-QUATTRO-PE	③ 3208333	50	

Accessories ¹⁾			
Type	Order No.	Pcs./Pkt.	
D-PT 1,5/S-QUATTRO	3208375	50	
D-PT 1,5/S-TWIN-0,8 OG	1029571	50	

Dimensions	
	[mm]
Maximum electrical data	
Maximum bridge current	[A]
Rated voltage	[V]
Nominal current / cross section	[A] / [mm ²]

Description	Color
Terminal block	gray
	blue
with interrupted current bar	gray
with potential distribution	gray
Ground terminal	green-yellow

Cover, width: 2.2 mm	gray
Cover, 0.8 mm width	orange

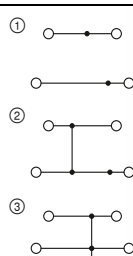

16 A, double-level terminal block, 4 connections

ClassNK
 Ex: EAC Ex IEC IECEx
 SEV13ATEX0159U / IECEx SEV13.0005U

Technical data ¹⁾				
Width	Length	Height		
3.5	65.4	42.6 (NS 35/7,5)		
I _{max} [A]	U _{max} [V]	max. Ø [mm ²]	AWG (UL)	
16	500	0.14 - 1.5	26-14	
16				
Rated data				
IEC	UL / CUL	CSA	Ex	
500	600	600	352	
Nominal current / cross section	[A] / [mm ²]	16 / 1.5	15 / -	

Ordering data			
Type	Order No.	Pcs./Pkt.	
PTTB 1,5/S	① 3208511	50	
PTTB 1,5/S BU	① 3208524	50	
PTTB 1,5/S-PV	② 3208540	50	
PTTB 1,5/S-PE	③ 3208537	50	

Accessories ¹⁾			
Type	Order No.	Pcs./Pkt.	
D-PTTB 1,5/S	3208579	50	
D-PTTB 1,5/S-0,8 OG	1029589	50	

Terminal blocks – CLIPLINE complete

1.5 mm² PT Push-in connection terminal blocks

Multi-level terminal blocks

Notes:
 1) For additional accessories and technical data, see page 38.
 For 1 mm² conductors with ferrule and plastic sleeve, using the AI-S 1-8 TQ ferrule is recommended, Order No. 1200293.
 For information on installation and using accessories for Ex applications, see page 678.

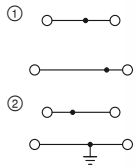

16 A, double-level terminal block, 4 connections



Technical data ¹⁾				
Width	Length	Height		
3.5	65.4	42.6 (NS 35/7,5)		
I_{max} [A]	U_{max} [V]	max. Ø [mm ²]	AWG (UL)	
16	500	0.14 - 1.5	26-14	
Maximum bridge current	[A]			
16				
Rated data	IEC	UL / CUL	CSA	Ex
Rated voltage	500	600	600	-
Nominal current / cross section	16 / 1.5	15 / -	15 / -	- / -

Ordering data			
Type	Order No.	Pcs./Pkt.	
PTTB 1,5/S-L/N	① 3208544	50	
PTTB 1,5/S-PE/L	② 3208553	50	
PTTB 1,5/S-PE/N	② 3208566	50	

Accessories ¹⁾			
D-PTTB 1,5/S	3208579	50	
D-PTTB 1,5/S-0,8 OG	1029589	50	

Dimensions		[mm]
Maximum electrical data		
Maximum bridge current	[A]	16
Rated data		
Rated voltage	[V]	500
Nominal current / cross section	[A] / [mm ²]	16 / 1.5

Description	Color
Terminal block	gray
upper level blue	gray
Terminal block	white
	white
	white

Cover, width: 2.2 mm	gray
Cover, 0.8 mm width	orange

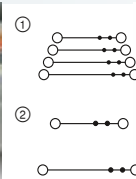

16 A, double-level terminal block, 4 connections, for KNX bus wiring

ERC
 Ex: IEC Ex
 SEV13ATEX0159U / IECEx SEV13.0005U

Technical data ¹⁾				
Width	Length	Height		
7	78.8	48.2 (NS 35/7,5)		
I_{max} [A]	U_{max} [V]	max. Ø [mm ²]	AWG (UL)	
16	500	0.14 - 1.5	-	
Maximum bridge current	[A]			
16				
Rated data	IEC	UL / CUL	CSA	Ex
Rated voltage	500	600	600	352
Nominal current / cross section	16 / 1.5	- / -	- / -	13.5 / 1.5

Ordering data			
Type	Order No.	Pcs./Pkt.	
PTTBS 1,5/S-KNX	① 3214663	50	
PTTBS 1,5/S WH/U-BK/O-RD	② 3214662	50	
PTTBS 1,5/S WH/U-YE/O-WH	② 3214661	50	

Accessories ¹⁾			
D-PTTBS 1,5/S-KNX	3214664	10	
D-PTTBS 1,5/S-0,8 OG	1029588	50	

Multi-level terminal blocks

Notes:
 1) For additional accessories and technical data, see page 38.
 For 1 mm² conductors with ferrule and plastic sleeve, using the AI-S 1-8 TQ ferrule is recommended, Order No. 1200293.

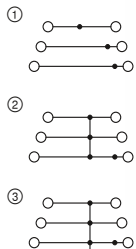

15 A, multi-level terminal block, 6 connections



Technical data ¹⁾				
Width	Length	Height		
3.5	97.2	53.2 (NS 35/7,5)		
I_{max} [A]	U_{max} [V]	max. Ø [mm ²]	AWG (UL)	
15	500	0.14 - 1.5	26-14	
Maximum bridge current	[A]			
15				
Rated data	IEC	UL / CUL	CSA	Ex
Rated voltage	500	600	600	-
Nominal current / cross section	15 / 1.5	15 / -	15 / -	- / -

Ordering data			
Type	Order No.	Pcs./Pkt.	
PT 1,5/S-3L	① 3213713	50	
PT 1,5/S-3L BU	① 3213726	50	
PT 1,5/S-3PV	② 3213742	50	
PT 1,5/S-3PE	③ 3213739	50	

Accessories ¹⁾			
D-PT 1,5/S-3L	3113771	50	
D-PT 1,5/S-3L-0,8 OG	1029590	50	

Dimensions		[mm]
Maximum electrical data		
Maximum bridge current	[A]	15
Rated data		
Rated voltage	[V]	500
Nominal current / cross section	[A] / [mm ²]	15 / 1.5

Description	Color
Terminal block	gray
blue	blue
upper level blue	gray
	gray
with potential distribution	gray
Ground terminal	green-yellow

Cover, width: 2.2 mm	gray
Cover, 0.8 mm width	orange

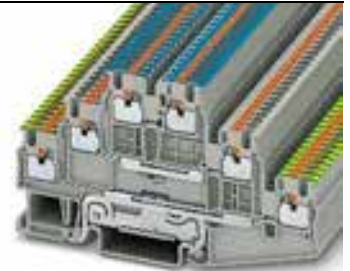
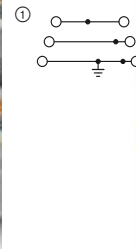

15 A, multi-level terminal block with PE foot



Technical data ¹⁾				
Width	Length	Height		
3.5	97.2	53.2 (NS 35/7,5)		
I_{max} [A]	U_{max} [V]	max. Ø [mm ²]	AWG (UL)	
15	500	0.14 - 1.5	26-14	
Maximum bridge current	[A]			
15				
Rated data	IEC	UL / CUL	CSA	Ex
Rated voltage	500	600	600	-
Nominal current / cross section	15 / 1.5	15 / -	15 / -	- / -

Ordering data			
Type	Order No.	Pcs./Pkt.	
PT 1,5/S-PE/L/N	① 3213755	50	
PT 1,5/S-PE/L/L	① 3213768	50	

Accessories ¹⁾			
D-PT 1,5/S-3L	3113771	50	
D-PT 1,5/S-3L-0,8 OG	1029590	50	

1.5 mm² PT Push-in connection terminal blocks

Initiator/actuator terminal blocks

Notes:
 1) For additional accessories and technical data, see page 38.
 For 1 mm² conductors with ferrule and plastic sleeve, using the AI-S 1-8 TQ ferrule is recommended, Order No. 1200293.

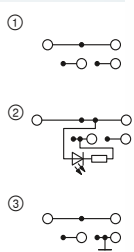

13.5 A, three-conductor initiator terminal block



Technical data ¹⁾				
Width	Length	Height		
3.5	74.4	41.5 (NS 35/7,5)		
<i>I</i> _{max} [A]	<i>U</i> _{max} [V]	max. Ø [mm ²]	AWG (UL)	
13.5	250	0.14 - 1.5	26-14	
Maximum bridge current	17.5			
Rated data	IEC	UL / CUL	CSA	Ex
Rated voltage	250	300	300	-
Nominal current / cross section	13.5 / 1.5	15 / -	15 / -	- / -

Ordering data				
Description	Color	Type	Order No.	Pcs./Pkt.
Terminal block	gray	PTIO 1,5/S/3	① 3244410	50
Red LED, 15 - 30 V DC, 0.31 - 0.95 mA, LED between upper and middle level	gray	PTIO 1,5/S/3-LED 24 RD	② 3244423	50
Green LED, 15 - 30 V DC, 0.31 - 0.95 mA, LED between upper and middle level	gray	PTIO 1,5/S/3-LED 24 GN	② 3244436	50
Terminal block, with PE connection	gray	PTIO 1,5/S/3-PE	③ 3244449	50

Accessories ¹⁾				
Cover, width: 2.2 mm	gray	D-PTIO 1,5/S/3	3244575	50

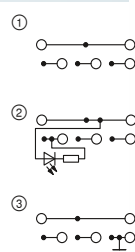

13.5 A, four-conductor actuator terminal block



Technical data ¹⁾				
Width	Length	Height		
3.5	90.8	41.5 (NS 35/7,5)		
<i>I</i> _{max} [A]	<i>U</i> _{max} [V]	max. Ø [mm ²]	AWG (UL)	
13.5	250	0.14 - 1.5	26-14	
Maximum bridge current	17.5			
Rated data	IEC	UL / CUL	CSA	Ex
Rated voltage	250	300	300	-
Nominal current / cross section	13.5 / 1.5	15 / -	15 / -	- / -

Ordering data				
Description	Color	Type	Order No.	Pcs./Pkt.
Terminal block	gray	PTIO 1,5/S/4	① 3244452	50
Red LED, 15 - 30 V DC, 0.31 - 0.95 mA, LED between upper and middle level	gray	PTIO 1,5/S/4-LED 24 RD	② 3244517	50
Green LED, 15 - 30 V DC, 0.31 - 0.95 mA, LED between upper and middle level	gray	PTIO 1,5/S/4-LED 24 GN	② 3244520	50
Terminal block, with PE connection	gray	PTIO 1,5/S/4-PE	③ 3244465	50

Accessories ¹⁾				
Cover, width: 2.2 mm	gray	D-PTIO 1,5/S/4	3244588	50

Power terminals

Notes:
 1) For additional accessories and technical data, see page 38.
 2) In the case of central power feed.

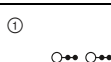

2.5 (4) mm², 20 A, power terminal block



Technical data ¹⁾				
Width	Length	Height		
7	74.4	41.5 (NS 35/7,5)		
<i>I</i> _{max} [A]	<i>U</i> _{max} [V]	max. Ø [mm ²]	AWG (UL)	
20 ²⁾	250	0.2 - 4	24-12	
Maximum bridge current	17.5			
Rated data	IEC	UL / CUL	CSA	Ex
Rated voltage	250	300	300	-
Nominal current / cross section	20 / 2.5	16 / -	16 / -	- / -
Rated cross section	2.5			
Cross section range	24 - 12			
Connection capacity	Rigid	Flexible	Ferrule without/with plastic sleeve	
1 conductor	0.2 - 4	0.2 - 2.5	0.2 - 2.5	0.2 - 2.5
2 flexible conductors with a TWIN ferrule	-	-	-	0.5
Connection cross sections directly plug-in	0.34 - 4	-	0.34 - 2.5	0.34 - 2.5

Ordering data				
Description	Color	Type	Order No.	Pcs./Pkt.
Power terminal block	orange	PTIO-IN 2,5/3 OG	① 3244559	50
Power terminal block, with PE connection	orange	D-PTIO 1,5/S/3	3244575	50

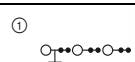

2.5 (4) mm², 20 A, feed-in terminal with PE connection



Technical data ¹⁾				
Width	Length	Height		
7	90.8	41.5 (NS 35/7,5)		
<i>I</i> _{max} [A]	<i>U</i> _{max} [V]	max. Ø [mm ²]	AWG (UL)	
20 ²⁾	250	0.2 - 4	24-12	
Maximum bridge current	17.5			
Rated data	IEC	UL / CUL	CSA	Ex
Rated voltage	250	- / -	300	-
Nominal current / cross section	20 / 2.5	- / -	16 / -	- / -
Rated cross section	2.5			
Cross section range	24 - 12			
Connection capacity	Rigid	Flexible	Ferrule without/with plastic sleeve	
0.2 - 4	0.2 - 2.5	0.2 - 2.5	0.2 - 2.5	0.2 - 2.5
-	-	-	-	0.5
0.34 - 4	-	0.34 - 2.5	0.34 - 2.5	0.34 - 2.5

Ordering data				
Description	Color	Type	Order No.	Pcs./Pkt.
Power terminal block, with PE connection	orange	PTIO-IN 2,5/4-PE OG	① 3244481	50
Cover, width: 2.2 mm	gray	D-PTIO 1,5/S/4	3244588	50

Terminal blocks – CLIPLINE complete

1.5 mm² PT Push-in connection terminal blocks

Initiator/actuator terminal blocks

Notes:
 1) For additional accessories and technical data, see page 38.
 For 1 mm² conductors with ferrule and plastic sleeve, using the Al-S 1-8 TQ ferrule is recommended, Order No. 1200293.

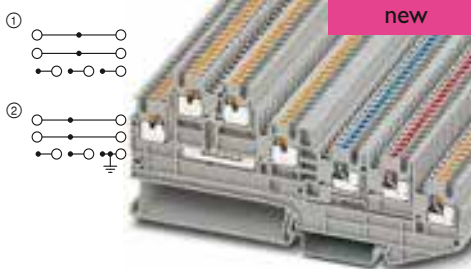

13.5 A, five-conductor actuator terminal block

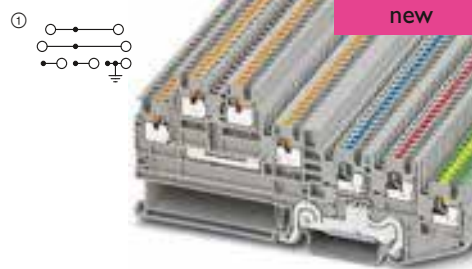

13.5 A, five-conductor actuator terminal block, with PE foot



Technical data ¹⁾	
Dimensions	[mm]
Width	3.5
Length	121.65
Height	52.1 (NS 35/7,5)
Maximum electrical data	
I_{max} [A]	13.5
U_{max} [V]	250
max. Ø [mm ²]	0.14 - 1.5
AWG (UL)	26-14
Maximum bridge current	17.5 [A]
Rated data	
Rated voltage	250 [V]
Nominal current / cross section	13.5 / 1.5 [A] / [mm ²]
Ordering data	
Description	Color
Terminal block	gray
Terminal block, with PE connection	gray gray
Accessories¹⁾	
Cover, width: 2.2 mm	gray
End cover segment	gray

Technical data ¹⁾			
Width	Length	Height	
3.5	121.65	52.1 (NS 35/7,5)	
I_{max} [A]	U_{max} [V]	max. Ø [mm ²]	AWG (UL)
13.5	250	0.14 - 1.5	26-14
17.5			
IEC	UL / CUL	CSA	Ex
250	500	600	-
13.5 / 1.5	15 / -	15 / -	- / -
Ordering data			
Type	Order No.	Pcs./Pkt.	
PTIO 1,5/S/5	① 3244470	50	
PTIO 1,5/S/5/U-BK/O-WH	② 3244472	50	
Accessories ¹⁾			
D-PTIO 1,5/S/5	3244589	50	
DS-PTIO 1,5/S	1045987	50	

Technical data ¹⁾			
Width	Length	Height	
3.5	121.65	52.1 (NS 35/7,5)	
I_{max} [A]	U_{max} [V]	max. Ø [mm ²]	AWG (UL)
13.5	250	0.14 - 1.5	26-14
17.5			
IEC	UL / CUL	CSA	Ex
250	500	600	-
13.5 / 1.5	15 / -	15 / -	- / -
Ordering data			
Type	Order No.	Pcs./Pkt.	
PTIO 1,5/S/5-PE	① 3244473	50	
PTIO 1,5/S/5-PE/U-BK/O-WH	① 3244471	50	
Accessories ¹⁾			
D-PTIO 1,5/S/5	3244589	50	
DS-PTIO 1,5/S	1045987	50	

Knife disconnect terminal blocks

Notes:
 1) For additional accessories and technical data, see page 38.
 The nominal current for PT ...MTD.. terminal blocks is 17.5 A.
 For 1 mm² conductors with ferrule and plastic sleeve, using the Al-S 1-8 TQ ferrule is recommended, Order No. 1200293.

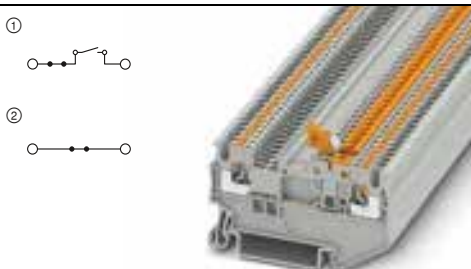

10 A, knife disconnect terminal block

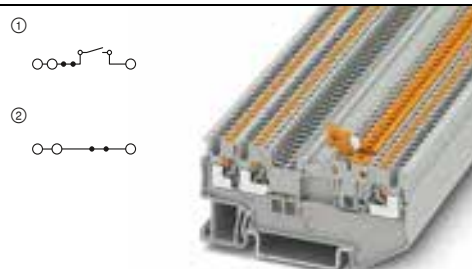

10 A, knife disconnect terminal block, 3 connections



Technical data ¹⁾	
Dimensions	[mm]
Width	3.5
Length	58.9
Height	32 (NS 35/7,5)
Maximum electrical data	
I_{max} [A]	10
U_{max} [V]	400
max. Ø [mm ²]	0.14 - 1.5
AWG (UL)	26-16
Maximum bridge current	10 [A]
Rated data	
Rated voltage	400 [V]
Nominal current / cross section	10 / 1.5 [A] / [mm ²]
Ordering data	
Description	Color
Knife disconnect terminal block	gray blue
Feed-through terminal block, same shape	gray blue
Accessories¹⁾	
Cover, 0.8 mm width	gray orange

Technical data ¹⁾			
Width	Length	Height	
3.5	58.9	32 (NS 35/7,5)	
I_{max} [A]	U_{max} [V]	max. Ø [mm ²]	AWG (UL)
10	400	0.14 - 1.5	26-16
10			
IEC	UL / CUL	CSA	Ex
400	300	300	-
10 / 1.5	10 / -	10 / -	- / -
Ordering data			
Type	Order No.	Pcs./Pkt.	
PT 1,5/S-MT	① 3210301	50	
PT 1,5/S-MT BU	① 3210302	50	
PT 1,5/S-MTD	② 3210308	50	
PT 1,5/S-MTD BU	② 3210309	50	
Accessories ¹⁾			
D-PT 1,5/S-MT-0,8	3210303	50	
D-PT 1,5/S-MT-0,8 OG	3210304	50	

Technical data ¹⁾			
Width	Length	Height	
3.5	67.8	32 (NS 35/7,5)	
I_{max} [A]	U_{max} [V]	max. Ø [mm ²]	AWG (UL)
10	400	0.14 - 1.5	26-16
10			
IEC	UL / CUL	CSA	Ex
400	300	300	-
10 / 1.5	10 / -	10 / -	- / -
Ordering data			
Type	Order No.	Pcs./Pkt.	
PT 1,5/S-TWIN-MT	① 3210311	50	
PT 1,5/S-TWIN-MT BU	① 3210312	50	
PT 1,5/S-TWIN-MTD	② 3210317	50	
PT 1,5/S-TWIN-MTD BU	② 3210319	50	
Accessories ¹⁾			
D-PT 1,5/S-TWIN-MT-0,8	3210313	50	
D-PT 1,5/S-TWIN-MT-0,8 OG	3210314	50	

1.5 mm² PT Push-in connection terminal blocks

Knife disconnect terminal blocks

Notes:

1) For additional accessories and technical data, see page 38.

For 1 mm² conductors with ferrule and plastic sleeve, using the AI-S 1-8 TQ ferrule is recommended, Order No. [1200293](#).

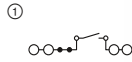

10 A, knife disconnect terminal block, 4 connections



Technical data¹⁾

Width	Length	Height		
3.5	76.9	32 (NS 35/7,5)		
I_{max} [A]	U_{max} [V]	max. Ø [mm ²]	AWG (UL)	
10	400	0.14 - 1.5	26-16	
Rated data				
IEC	UL / CUL	CSA	Ex	
400	300	300	-	
Nominal current / cross section [A] / [mm ²]				
10 / 1.5	10 / -	10 / -	- / -	

Ordering data

Type	Order No.	Pcs./Pkt.
PT 1,5/S-QUATTRO-MT	3210321	50
PT 1,5/S-QUATTRO-MT BU	3210322	50

Accessories¹⁾

Type	Order No.	Pcs./Pkt.
D-PT 1,5/S-QUATTRO-MT-0,8	3210333	50
D-PT 1,5/S-QUATTRO-MT-0,8 OG	3210334	50

Dimensions	[mm]
Width	3.5
Length	76.9
Height	32 (NS 35/7,5)
Maximum electrical data	
I_{max} [A]	10
U_{max} [V]	400
Maximum bridge current [A]	10
Rated data	
Rated voltage [V]	400
Nominal current / cross section [A] / [mm ²]	10 / 1.5

Description	Color
Knife disconnect terminal block	gray blue
Feed-through terminal block, same shape	gray blue

Cover, 0.8 mm width	Color
	gray orange

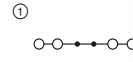

17.5 A, feed-through terminal block, 4 connections, same shape



Technical data¹⁾

Width	Length	Height		
3.5	76.9	32 (NS 35/7,5)		
I_{max} [A]	U_{max} [V]	max. Ø [mm ²]	AWG (UL)	
17.5	400	0.14 - 1.5	26-16	
Rated data				
IEC	UL / CUL	CSA	Ex	
400	300	300	-	
Nominal current / cross section [A] / [mm ²]				
17.5 / 1.5	10 / -	10 / -	- / -	

Ordering data

Type	Order No.	Pcs./Pkt.
PT 1,5/S-QUATTRO-MTD	3210328	50
PT 1,5/S-QUATTRO-MTD BU	3210329	50

Accessories¹⁾

Type	Order No.	Pcs./Pkt.
D-PT 1,5/S-QUATTRO-MT-0,8	3210333	50
D-PT 1,5/S-QUATTRO-MT-0,8 OG	3210334	50

Knife disconnect terminal blocks

Notes:

1) For additional accessories and technical data, see page 38.

For 1 mm² conductors with ferrule and plastic sleeve, using the AI-S 1-8 TQ ferrule is recommended, Order No. [1200293](#).

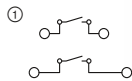

9 A, double-level terminal block with one disconnect knife per level



Technical data¹⁾

Width	Length	Height		
3.5	86	42.6 (NS 35/7,5)		
I_{max} [A]	U_{max} [V]	max. Ø [mm ²]	AWG (UL)	
9	400	0.14 - 1.5	26-16	
Rated data				
IEC	UL / CUL	CSA	Ex	
400	300	300	-	
Nominal current / cross section [A] / [mm ²]				
9 / 1.5	10 / -	10 / -	- / -	

Ordering data

Type	Order No.	Pcs./Pkt.
PTT 1,5/S-2MT	3210351	50
PTT 1,5/S-2MT BU	3210352	50

Accessories¹⁾

Type	Order No.	Pcs./Pkt.
D-PTT 1,5/S-2MT-0,8	3210353	50
D-PTT 1,5/S-2MT-0,8 OG	3210354	50

Dimensions	[mm]
Width	3.5
Length	86
Height	42.6 (NS 35/7,5)
Maximum electrical data	
I_{max} [A]	9
U_{max} [V]	400
Rated data	
Rated voltage [V]	400
Nominal current / cross section [A] / [mm ²]	9 / 1.5

Description	Color
Knife disconnect terminal block	gray blue

Cover, 0.8 mm width	Color
	gray orange

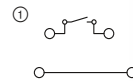

9 A, double-level terminal block with disconnect knife, upper level can be disconnected



Technical data¹⁾

Width	Length	Height		
3.5	86	42.6 (NS 35/7,5)		
I_{max} [A]	U_{max} [V]	max. Ø [mm ²]	AWG (UL)	
9	400	0.14 - 1.5	26-16	
Rated data				
IEC	UL / CUL	CSA	Ex	
400	300	300	-	
Nominal current / cross section [A] / [mm ²]				
9 / 1.5	10 / -	10 / -	- / -	

Ordering data

Type	Order No.	Pcs./Pkt.
PTT 1,5/S-L/MT	3210341	50
PTT 1,5/S-L/MT BU	3210342	50

Accessories¹⁾

Type	Order No.	Pcs./Pkt.
D-PTT 1,5/S-2MT-0,8	3210353	50
D-PTT 1,5/S-2MT-0,8 OG	3210354	50

Terminal blocks – CLIPLINE complete

1.5 mm² PT Push-in connection terminal blocks

Double-level terminal blocks, same shape

Notes:
 1) For additional accessories and technical data, see page 38.
 For 1 mm² conductors with ferrule and plastic sleeve, using the AI-S 1-8 TQ ferrule is recommended, Order No. 1200293.

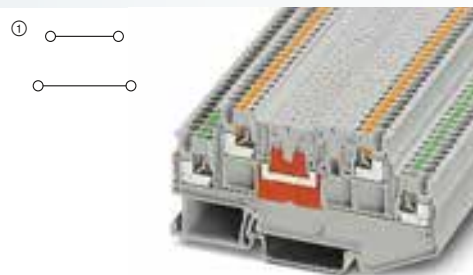

9 A, double-level terminal block, same shape



Dimensions		[mm]
Maximum electrical data		
Rated data		
Rated voltage	[V]	400
Nominal current / cross section	[A] / [mm ²]	9 / 1.5
Description		Color
Terminal block		gray blue
Cover, 0.8 mm width		gray orange

Technical data ¹⁾			
Width	Length	Height	
3.5	86	42.6 (NS 35/7,5)	
I _{max} [A]	U _{max} [V]	max. Ø [mm ²]	AWG (UL)
9	400	0.14 - 1.5	26-16
IEC	UL / CUL	CSA	Ex
400	300	300	-
9 / 1.5	10 / -	10 / -	- / -
Ordering data			
Type	Order No.	Pcs./Pkt.	
PTT 1,5/S-2L	① 3210356	50	
PTT 1,5/S-2L BU	① 3210357	50	
Accessories ¹⁾			
D-PTT 1,5/S-2MT-0,8	3210353	50	
D-PTT 1,5/S-2MT-0,8 OG	3210354	50	

Feed-through, multi-conductor, multi-level, and ground terminal blocks in desk design

Notes:
 1) For additional accessories and technical data, see page 38.
 For 1 mm² conductors with ferrule and plastic sleeve, using the AI-S 1-8 TQ ferrule is recommended, Order No. 1200293.
 For information on installation and using accessories for Ex applications, see page 678.

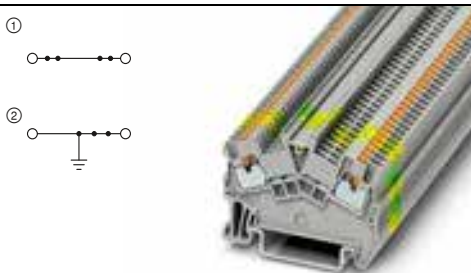

17.5 A, feed-through terminal block

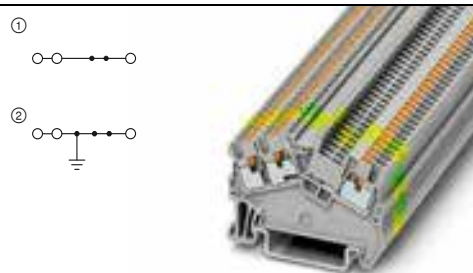

17.5 A, feed-through terminal block, 3 connections

Ex: IEC, IECEx
 SEV13ATEX0159U / IECEx SEV13.0005U

Technical data ¹⁾				
Width	Length	Height		
3.5	50.7	38.5 (NS 35/7,5)		
I _{max} [A]	U _{max} [V]	max. Ø [mm ²]	AWG (UL)	
17.5	500	0.14 - 1.5	26-14	
17.5				
IEC	UL / CUL	CSA	Ex	
500	600	600	352	
17.5 / 1.5	15 / -	15 / -	15 / 1.5	
Ordering data				
Type	Order No.	Pcs./Pkt.		
PTS 1,5/S	① 3214547	50		
PTS 1,5/S BU	① 3214550	50		
PTS 1,5/S-PE	② 3214563	50		
Accessories ¹⁾				
D-PTS 1,5/S	3214576	50		

Ex: IEC, IECEx
 SEV13ATEX0159U / IECEx SEV13.0005U

Technical data ¹⁾			
Width	Length	Height	
3.5	50.7	38.5 (NS 35/7,5)	
I _{max} [A]	U _{max} [V]	max. Ø [mm ²]	AWG (UL)
17.5	500	0.14 - 1.5	26-14
17.5			
IEC	UL / CUL	CSA	Ex
500	600	600	352
17.5 / 1.5	15 / -	15 / -	15 / 1.5
Ordering data			
Type	Order No.	Pcs./Pkt.	
PTS 1,5/S-TWIN	① 3214589	50	
PTS 1,5/S-TWIN BU	① 3214592	50	
PTS 1,5/S-TWIN-PE	② 3214602	50	
Accessories ¹⁾			
D-PTS 1,5/S	3214576	50	

1.5 mm² PT Push-in connection terminal blocks

Feed-through, multi-conductor, multi-level, and ground terminal blocks in desk design

Notes:
 1) For additional accessories and technical data, see page 38.
 For 1 mm² conductors with ferrule and plastic sleeve, using the AI-S 1-8 TQ ferrule is recommended, Order No. 1200293.
 For information on installation and using accessories for Ex applications, see page 678.

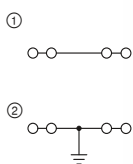

17.5 A, feed-through terminal block, 4 connections

ClassNK
 Ex: IEC IECEx
 SEV13ATEX0159U / IECEx SEV13.0005U

Technical data ¹⁾			
Width	Length	Height	
3.5	50.7	38.5 (NS 35/7,5)	
I _{max.} [A]	U _{max.} [V]	max. Ø [mm ²]	AWG (UL)
17.5	500	0.14 - 1.5	26-14
Maximum bridge current [A]			
-			
Rated data			
Rated voltage [V]	500	UL / CUL	600
Nominal current / cross section [A] / [mm ²]	17.5 / 1.5	15 / -	15 / -
IEC	500	UL / CUL	600
CSA	600	Ex	352
UL / CUL	15 / -	CSA	600
Ex	15 / -	UL / CUL	13.5 / 1.5

Ordering data			
Type	Order No.	Pcs./Pkt.	
PTS 1,5/S-QUATTRO	① 3214615	50	
PTS 1,5/S-QUATTRO BU	① 3214631	50	
PTS 1,5/S-QUATTRO-PE	② 3214644	50	

Accessories ¹⁾		
D-PTS 1,5/S	3214576	50

Dimensions	
	[mm]
Maximum electrical data	
Maximum bridge current	[A]
Rated data	
Rated voltage	[V]
Nominal current / cross section	[A] / [mm ²]
Description	
	Color
Terminal block	gray
With potential distribution	gray
Ground terminal	green-yellow
Cover, width: 2.2 mm	gray

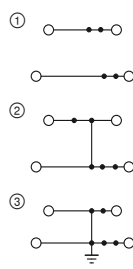

16 A, double-level terminal block

ClassNK
 Ex: IEC IECEx
 SEV13ATEX0159U / IECEx SEV13.0005U

Technical data ¹⁾			
Width	Length	Height	
3.5	78.8	48.2 (NS 35/7,5)	
I _{max.} [A]	U _{max.} [V]	max. Ø [mm ²]	AWG (UL)
16	500	0.14 - 1.5	26-14
Maximum bridge current [A]			
16			
Rated data			
Rated voltage [V]	500	UL / CUL	600
Nominal current / cross section [A] / [mm ²]	16 / 1.5	15 / -	15 / -
IEC	500	UL / CUL	600
CSA	600	Ex	352
UL / CUL	15 / -	CSA	600
Ex	15 / -	UL / CUL	13.5 / 1.5

Ordering data			
Type	Order No.	Pcs./Pkt.	
PTTBS 1,5/S	① 3214657	50	
PTTBS 1,5/S BU	① 3214660	50	
PTTBS 1,5/S-PV	② 3214686	50	
PTTBS 1,5/S-PE	③ 3214673	50	

Accessories ¹⁾		
D-PTTBS 1,5/S	3214699	50

Mini feed-through and ground terminal blocks

Notes:
 1) For additional accessories and technical data, see page 38.
 For 1 mm² conductors with ferrule and plastic sleeve, using the AI-S 1-8 TQ ferrule is recommended, Order No. 1200293.
 For more colors for MPT 1,5/S and MP 1,5, visit phoenixcontact.net/products
 For information on installation and using accessories for Ex applications, see page 678.

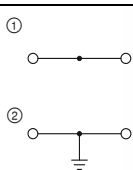

17.5 A, mini feed-through terminal block

ClassNK
 Ex: IEC IECEx
 SEV14ATEX0140U / IECEx SEV14.0010U

Technical data ¹⁾			
Width	Length	Height	
3.5	33.55	28.1 (NS 15)	
I _{max.} [A]	U _{max.} [V]	max. Ø [mm ²]	AWG (UL)
17.5	500	0.14 - 1.5	26-14
Maximum bridge current [A]			
17.5			
Rated data			
Rated voltage [V]	500	UL / CUL	600
Nominal current / cross section [A] / [mm ²]	17.5 / 1.5	15 / -	15 / -
IEC	500	UL / CUL	600
CSA	600	Ex	352
UL / CUL	15 / -	CSA	600
Ex	15 / -	UL / CUL	14.5 / 1.5
Connection capacity			
Rigid	Flexible	Ferrule without/with plastic sleeve	
0.14 - 1.5	0.14 - 1.5	0.14 - 1.5	0.14 - 1
0.25 - 1.5	-	0.34 - 1.5	0.34 - 1

Ordering data			
Type	Order No.	Pcs./Pkt.	
MPT 1,5/S	① 3248100	50	
MPT 1,5/S-PE	② 3248110	50	

Accessories ¹⁾		
D-MPT 1,5/S	3248120	50

Dimensions	
	[mm]
Maximum electrical data	
Maximum bridge current	[A]
Rated data	
Rated voltage	[V]
Nominal current / cross section	[A] / [mm ²]
Cross section range	AWG
Connection capacity	
1 conductor	[mm ²]
Connection cross sections directly plug-in	[mm ²]
Description	
	Color
Terminal block	gray
Ground terminal	green-yellow
Cover, width: 2.2 mm	gray



17.5 A, single terminal block

ClassNK
 Ex: IEC IECEx
 SEV14ATEX0140U / IECEx SEV14.0010U

Technical data ¹⁾			
Width	Length	Height	
4.2	21	27.2 (NS 15)	
I _{max.} [A]	U _{max.} [V]	max. Ø [mm ²]	AWG (UL)
17.5	500	0.14 - 1.5	26-14
Maximum bridge current [A]			
-			
Rated data			
Rated voltage [V]	500	UL / CUL	300
Nominal current / cross section [A] / [mm ²]	17.5	15 / -	15 / -
IEC	500	UL / CUL	300
CSA	300	Ex	-
UL / CUL	15 / -	CSA	600
Ex	15 / -	UL / CUL	0.25 - 1.5
Connection capacity			
Rigid	Flexible	Ferrule without/with plastic sleeve	
0.14 - 1.5	0.14 - 1.5	0.25 - 1.5	0.25 - 1.5
0.34 - 1.5	-	0.5 - 1.5	0.5 - 1.5

Ordering data			
Type	Order No.	Pcs./Pkt.	
MP 1,5	① 3248150	50	

Accessories ¹⁾		
---------------------------	--	--

Terminal blocks – CLIPLINE complete

1.5 mm² PT Push-in connection terminal blocks

Marshalling terminals, four levels



- Maximum signal density and up to 20% less space required, thanks to the compact design
- Easy and tool-free wiring thanks to Push-in connection
- Freely configurable color assignment for conductors and terminal points, enabling intuitive and safe installation
- Four conductors up to 2.5 mm² can be connected to one potential by means of the double connection
- Convenient testing by means of freely accessible 2.3 mm test connections centered between the connection points
- Large-surface, pitch-free marking for matrix identification
- Easy potential distribution with bridges and 6 mm² supply
- Blue marshalling terminals for use in Ex i safety circuits < 60 V
- Cabling duct combs can be snapped on as an option
- FTRV versions are available without actuation lever

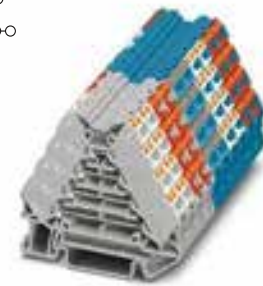
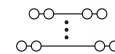

10 A, marshalling terminal, 16 connections



Dimensions	
	[mm]
Maximum electrical data	
Rated data	
Rated voltage	[V]
Nominal current / cross section	[A] / [mm ²]
Cross section range	AWG
Connection capacity	
1 conductor	[mm ²]
Connection cross sections directly plug-in	[mm ²]

Technical data				
Width	Length	Height NS 35/7,5		
8.3	64	55.5		
I _{max} [A]	U _{max} [V]	max. Ø [mm ²]	AWG (UL)	
10	250	0.14 - 2.5	26-14	
IEC 60947-7-1				
IEC	UL / CUL	CSA	IEC/EN 60079-7	
250	300	300	-	
10 / 1.5	10	10 / -	-	
26 - 14	26-14	26-14	-	
Connection capacity		Rigid	Flexible	Ferrule
				without/with plastic sleeve
1 conductor	[mm ²]	0.14 - 2.5	0.14 - 1.5	0.14 - 1.5 0.14 - 1.5
Connection cross sections directly plug-in	[mm ²]	0.34 - 2.5	-	0.34 - 1.5 0.34 - 1.5

Description	Color
Marshalling terminal, white chambers	gray
Chambers: red	gray
Chambers: gray	gray
Chambers: green	gray
Chambers: yellow	gray
Chambers: blue	blue
Chambers: white	blue
Chambers: red	blue
Marshalling terminal, without actuation lever, white chambers	gray
Chambers: red	gray
Chambers: blue	blue
Chambers: white	blue
Chambers: red	blue

Ordering data			
Type	Order No.	Pcs./Pkt.	
PTRV 4 /WH	3270115	10	
PTRV 4 /RD	3270121	10	
PTRV 4 /GY	3270117	10	
PTRV 4 /GN	3270122	10	
PTRV 4 /YE	3270123	10	
PTRV 4 BU/BU	3270118	10	
PTRV 4 BU/WH	3270119	10	
PTRV 4 BU/RD	3270120	10	
FTRV 4 /WH	3270169	10	
FTRV 4 /RD	3270175	10	
FTRV 4 BU/BU	3270172	10	
FTRV 4 BU/WH	3270173	10	
FTRV 4 BU/RD	3270174	10	

Spacer plate, width: 8.3 mm	gray
Cable duct comb, can be snapped on	gray
Zack marker strip, flat, for marking the DP-PTRV ... spacer plate, unprinted	white
printed horizontally , numbers 1-8	white
printed horizontally , letters A-H	white
printed vertically , numbers 1-8	white
printed vertically , letters A-H	white
labeled in accordance with customer specifications	white
Zack marker strip, for marking the PTRV terminal, unprinted	white
printed horizontally , with consecutive numbers, e.g., 1-10, 11-20	white
printed vertically , with consecutive numbers, e.g., 1-10, 11-20	white

Accessories			
	Order No.	Pcs./Pkt.	
DP-PTRV 4	3270163	10	
CDC-PTRV	3270167	10	
ZBF 6/9,2 S8:UNBEDRUCKT	0803447	10	
ZBF 6/9,2 S8,LGS:1-8	0803450	10	
ZBF 6/9,2 S8,LGS:A-H	0803451	10	
ZBF 6/9,2 S8,QR:1-8	0803448	10	
ZBF 6/9,2 S8,QR:A-H	0803449	10	
ZBF 6/9,2 S8 CUS	8191575	1	
ZB 8,3:UNBEDRUCKT	0803444	10	
ZB 8,3,LGS:FORTL.ZAHLEN	0803480	10	
ZB 8,3,QR:FORTL.ZAHLEN	0803479	10	

Potential distributors, four levels

- Potential distribution systems with up to 16 connections can be implemented with the PTRV ...-PV terminal block
- Blue marshalling terminals for use in Ex i safety circuits < 60 V
- Easy potential distribution with bridges and 6 mm² supply

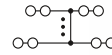

20 A, potential distributor,
16 connections



Dimensions	
	[mm]
Maximum electrical data	
Rated data	
Rated voltage	[V]
Nominal current / cross section	[A] / [mm ²]
Cross section range	AWG
Connection capacity	
1 conductor	[mm ²]
Connection cross sections directly plug-in	[mm ²]

Technical data				
Width	Length	Height NS 35/7,5		
8.3	64	55.5		
I _{max} [A]	U _{max} [V]	max. Ø [mm ²]	AWG (UL)	
20	250	0.14 - 2.5	26-14	
IEC	UL / CUL	CSA	IEC/EN 60079-7	
250	300	300	-	
17.5 / 1.5	10	10 / -	-	
26 - 14	26-14	26-14	-	
Connection capacity		Ferrule		
		without/with plastic sleeve		
0.14 - 2.5	0.14 - 1.5	0.14 - 1.5	0.14 - 1.5	
0.34 - 2.5	-	0.34 - 1.5	0.34 - 1.5	

Description	Color
Potential distributor , black chambers	gray
Chambers: red	gray
Chambers: blue	gray
Chambers: black	blue
Potential distributor , top two chambers yellow, bottom two chambers black	gray
top two chambers black, bottom two chambers yellow	gray
Potential distributor , without actuation lever, black chambers	gray
Chambers: black	blue
Potential distributor , without actuation lever, top two chambers yellow, bottom two chambers black	gray
top two chambers black, bottom two chambers yellow	gray

Ordering data			
Type	Order No.	Pcs./Pkt.	
PTRV 4-PV /BK	3270125	10	
PTRV 4-PV /RD	3270246	10	
PTRV 4-PV /BU	3270247	10	
PTRV 4-PV BU/BK	3270126	10	
PTRV 4-FE /YE BK	3270130	10	
PTRV 4-FE /BKYE	3270131	10	
FTRV 4-PV /BK	3270178	10	
FTRV 4-PV BU/BK	3270181	10	
FTRV 4-FE /YE BK	3270184	10	
FTRV 4-FE /BKYE	3270185	10	

Accessories				
Spacer plate , width: 8.3 mm	gray	DP-PTRV 4	3270163	10
Zack marker strip , flat, for marking the DP-PTRV ... spacer plate, unprinted	white	ZBF 6/9,2 S8:UNBEDRUCKT	0803447	10
printed horizontally , numbers 1-8	white	ZBF 6/9,2 S8,LGS:1-8	0803450	10
printed horizontally , letters A-H	white	ZBF 6/9,2 S8,LGS:A-H	0803451	10
printed vertically , numbers 1-8	white	ZBF 6/9,2 S8,QR:1-8	0803448	10
printed vertically , letters A-H	white	ZBF 6/9,2 S8,QR:A-H	0803449	10
labeled in accordance with customer specifications	white	ZBF 6/9,2 S8 CUS	8191575	1

Terminal blocks – CLIPLINE complete

1.5 mm² PT Push-in connection terminal blocks

Potential distributors, four levels



- Space-saving potential distribution with up to 32 connections
- Potential distribution blocks can be individually adapted with plug-in bridges for assembly
- Versions with 6 mm² supply option and 32 A
- PTRVB 4-PE ground terminal for the connection of shielding or protective conductors
- Versions are available in blue and red for clear assignment
- Large-surface marking options



Notes:
1) Nominal current of 17.5 A. 16 connections
2) The maximum current of a double connection is 24 A.

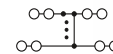

37 A, potential distributor, 13 connections, with supply, can be bridged



Dimensions	
	[mm]
Maximum electrical data	
Rated data	
Rated voltage	[V]
Nominal current / cross section	[A] / [mm ²]
Cross section range	AWG
Connection capacity	
1 conductor	[mm ²]
Connection cross sections directly plug-in	[mm ²]
Rated data, feed	
Nominal current / cross section	[A] / [mm ²]
Maximum current	[A]
Cross section range	AWG
Supply connection capacity	
1 conductor	[mm ²]
Connection cross sections directly plug-in	[mm ²]

Technical data				
Width	Length	Height NS 35/7,5		
8.3	64	55.5		
I _{max} [A]	U _{max} [V]	max. Ø [mm ²]	AWG (UL)	
24	250	0.14 - 2.5	12-10	
IEC 60947-7-1				
IEC	UL / CUL	CSA	IEC/EN 60079-7	
250	-	-	-	
17.5 ² / 1.5	-	-	-	
26 - 14	12-10	-	-	
Connection capacity	Rigid	Flexible	Ferrule without/with plastic sleeve	
1 conductor	0.14 - 2.5	0.14 - 1.5	0.14 - 1.5	0.14 - 1.5
Connection cross sections directly plug-in	0.34 - 2.5	-	0.34 - 1.5	0.34 - 1.5
Rated data, feed	IEC	UL / CUL	CSA	IEC/EN 60079-7
Nominal current / cross section	32 / 4	-	-	-
Maximum current	37	-	-	-
Cross section range	24 - 10	12-10	-	-
Supply connection capacity	Rigid	Flexible	Ferrule without/with plastic sleeve	
1 conductor	0.2 - 6	0.2 - 6	0.2 - 6	0.2 - 6
Connection cross sections directly plug-in	0.34 - 6	-	0.34 - 6	0.34 - 6

Description	Color
Potential distributor, with supply	gray
Chambers: blue	gray
Chambers: red	gray
Chambers: gray	gray
Potential distributor¹⁾	gray
Chambers: blue	gray
Chambers: red	gray
Ground terminal	
Potential distributor, with supply, without actuation lever	gray
Potential distributor, without actuation lever¹⁾	gray

Ordering data				
Type	I _{max}	Order No.	Pcs./Pkt.	
PTRVB 4-FI /BK		3270158	10	
PTRVB 4-FI /BU		3270221	10	
PTRVB 4-FI /RD		3270220	10	
PTRVB 4-FI /GY		3270138	10	
PTRVB 4-PV /BK		3270157	10	
PTRVB 4-PV /BU		3270223	10	
PTRVB 4-PV /RD		3270222	10	
PTRVB 4-PE		1070018	10	
FTRVB 4-FI /BK		3270208	10	
FTRVB 4-PV /BK		3270207	10	

Spacer plate, width: 8.3 mm	gray
Continuous plug-in bridge, 500 mm long, isolated, can be cut to length, for potential distribution	
Nominal current: 32 A	red
	gray
Zack marker strip, flat, for marking the DP-PTRV ... spacer plate, unprinted	white
printed horizontally, numbers 1-8	white
printed horizontally, letters A-H	white
printed vertically, numbers 1-8	white
printed vertically, letters A-H	white
labeled in accordance with customer specifications	white

Accessories				
DP-PTRV 4		3270163	10	
FBST 500-PLC RD	32 A	2966786	20	
FBST 500-PLC GY	32 A	2966838	20	
ZBF 6/9,2 S8:UNBEDRUCKT		0803447	10	
ZBF 6/9,2 S8,LGS:1-8		0803450	10	
ZBF 6/9,2 S8,LGS:A-H		0803451	10	
ZBF 6/9,2 S8,QR:1-8		0803448	10	
ZBF 6/9,2 S8,QR:A-H		0803449	10	
ZBF 6/9,2 S8 CUS		8191575	1	

Accessories

- Space-saving partition and end cover with isolating function
- Same shape as the PTRV ... marshalling panel



General data		Technical data			Technical data		
Material		PA			PA		
Description		Ordering data			Ordering data		
Description	Color	Type	Order No.	Pcs./Pkt.	Type	Order No.	Pcs./Pkt.
Cover, can be grouped, unprinted	white	D-PTRV 4 WH	3270151	10			
Vertically printed: numbers 1-4	white	D-PTRV 4 WH 1-4	3270152	10			
Horizontally printed: numbers 1-4	white	D-PTRV 4 WH 1-4 LGS	3270234	10			
Vertically printed: numbers 4-1	white	D-PTRV 4 WH 4-1	3270236	10			
Horizontally printed: numbers 4-1	white	D-PTRV 4 WH 4-1 LGS	3270238	10			
Vertically printed: letters A-D	white	D-PTRV 4 WH A-D	3270153	10			
Horizontally printed: letters A-D	white	D-PTRV 4 WH A-D LGS	3270235	10			
Vertically printed: letters D-A	white	D-PTRV 4 WH D-A	3270237	10			
Horizontally printed: letters D-A	white	D-PTRV 4 WH D-A LGS	3270239	10			
Marking strips, no loss of pitch, vertically printed, numbers 1-4	white				TM-PTRV 4,QR:1-4	0803464	10
Vertically printed, numbers 4-1	white				TM-PTRV 4,QR:4-1	0803465	10
Vertically printed, letters A-D	white				TM-PTRV 4,QR:A-D	0803466	10
Vertically printed, letters D-A	white				TM-PTRV 4,QR:D-A	0803467	10

Terminal blocks – CLIPLINE complete

1.5 mm² PT Push-in connection terminal blocks

Marshalling terminals, eight levels

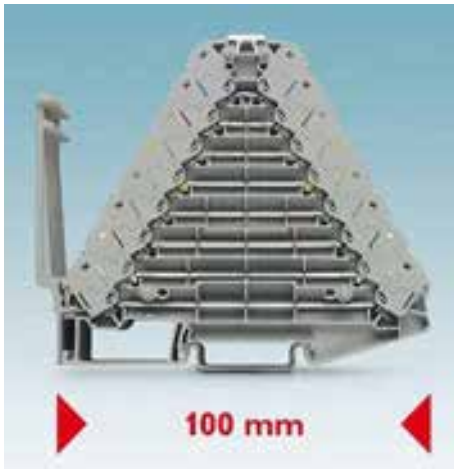

- Maximum signal density and up to 20% less space required, thanks to the compact design
- Easy and tool-free wiring, thanks to Push-in connection
- Freely configurable color assignment for conductors and terminal points, enabling intuitive and safe installation
- Four conductors up to 2.5 mm² can be connected to one potential by means of the double connection
- Convenient testing by means of freely accessible 2.3 mm test connections centered between the connection points
- Large-surface, pitch-free marking for matrix identification
- Easy potential distribution with bridges and 6 mm² supply
- Blue marshalling terminals for use in Ex i safety circuits < 60 V
- Cabling duct combs can be snapped on as an option
- FTRV versions are available without actuation lever

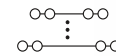

8 A, marshalling terminal, 32 connections



Dimensions	
	[mm]
Maximum electrical data	
Rated data	
Rated voltage	[V]
Nominal current / cross section	[A] / [mm ²]
Cross section range	AWG
Connection capacity	
1 conductor	[mm ²]
Connection cross sections directly plug-in	[mm ²]

Technical data				
Width	Length	Height NS 35/7,5		
8.3	100	87.5		
I _{max} [A]	U _{max} [V]	max. Ø [mm ²]	AWG (UL)	
8	250	0.14 - 2.5	26-14	
IEC 60947-7-1				
IEC	UL / CUL	CSA	IEC/EN 60079-7	
Rated voltage	300	300	-	
8 / 1.5	10	10 / -	-	
26 - 14	26-14	26-14	-	
Connection capacity		Rigid	Flexible	Ferrule
				without/with plastic sleeve
1 conductor	[mm ²]	0.14 - 2.5	0.14 - 1.5	0.14 - 1.5 0.14 - 1.5
Connection cross sections directly plug-in	[mm ²]	0.34 - 2.5	-	0.34 - 1.5 0.34 - 1.5

Description	Color
Marshalling terminal , top four chambers white, bottom four chambers red	gray
top four chambers red, bottom four chambers white	gray
Chambers: blue	gray
Chambers: green	gray
Chambers: red	gray
Chambers: colors in accordance with VDE 0815 color code	gray
Chambers: blue	blue
top four chambers white, bottom four chambers red	blue
top four chambers red, bottom four chambers white	blue
Marshalling terminal , without actuation lever, top four chambers white, bottom four chambers red	gray
top four chambers red, bottom four chambers white	gray
Chambers: blue	blue
top four chambers white, bottom four chambers red	blue
top four chambers red, bottom four chambers white	blue

Ordering data			
Type	Order No.	Pcs./Pkt.	
PTRV 8 /WHRD	3270133	10	
PTRV 8 /RDWH	3270137	10	
PTRV 8 /BU	3270233	10	
PTRV 8 /GN	3270232	10	
PTRV 8 /RD	3270231	10	
PTRV 8 /VDE 0815	3270230	10	
PTRV 8 BU/BU	3270136	10	
PTRV 8 BU/WHRD	3270134	10	
PTRV 8 BU/RDWH	3270135	10	
FTRV 8 /WHRD	3270187	10	
FTRV 8 /RDWH	3270193	10	
FTRV 8 BU/BU	3270190	10	
FTRV 8 BU/WHRD	3270191	10	
FTRV 8 BU/RDWH	3270192	10	

Spacer plate , width: 8.3 mm	gray
Cable duct comb , can be snapped on	gray
Zack marker strip, flat , for marking the DP-PTRV ... spacer plate, unprinted	white
printed horizontally , numbers 1-8	white
printed horizontally , letters A-H	white
printed vertically , numbers 1-8	white
printed vertically , letters A-H	white
labeled in accordance with customer specifications	white
Zack marker strip , for marking the PTRV terminal, unprinted	white
printed horizontally , with consecutive numbers, e.g., 1-10, 11-20	white
printed vertically , with consecutive numbers, e.g., 1-10, 11-20	white

Accessories			
DP-PTRV 8	3270166	10	
CDC-PTRV	3270167	10	
ZBF 6/9,2 S8:UNBEDRUCKT	0803447	10	
ZBF 6/9,2 S8,LGS:1-8	0803450	10	
ZBF 6/9,2 S8,LGS:A-H	0803451	10	
ZBF 6/9,2 S8,QR:1-8	0803448	10	
ZBF 6/9,2 S8,QR:A-H	0803449	10	
ZBF 6/9,2 S8 CUS	8191575	1	
ZB 8,3:UNBEDRUCKT	0803444	10	
ZB 8,3,LGS:FORTL.ZAHLEN	0803480	10	
ZB 8,3,QR:FORTL.ZAHLEN	0803479	10	

Potential distributors, eight levels

- Potential distribution systems with up to 32 connections can be implemented with the PTRV ...-PV terminal block
- Blue marshalling terminals for use in Ex i safety circuits < 60 V
- Easy potential distribution with bridges and 6 mm² supply

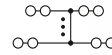

20 A, potential distributor,
32 connections



Dimensions	
	[mm]
Maximum electrical data	
Rated data	
Rated voltage	[V]
Nominal current / cross section	[A] / [mm ²]
Cross section range	AWG
Connection capacity	
1 conductor	[mm ²]
Connection cross sections directly plug-in	[mm ²]

Technical data				
Width	Length	Height NS 35/7,5		
8.3	100	87.5		
I_{max} [A]	U_{max} [V]	max. \varnothing [mm ²]	AWG (UL)	
20	250	0.14 - 2.5	26-14	
IEC	UL / CUL	CSA	IEC/ EN 60079-7	
Rated voltage	250	300	300	
Nominal current / cross section	17.5 / 1.5	10	10 / -	
Cross section range	26 - 14	26-14	26-14	
Connection capacity		Rigid	Flexible	Ferrule
		without/with plastic sleeve		
1 conductor	0.14 - 2.5	0.14 - 1.5	0.14 - 1.5	0.14 - 1.5
Connection cross sections directly plug-in	0.34 - 2.5	-	0.34 - 1.5	0.34 - 1.5

Description	Color
Potential distributor , black chambers	gray
Chambers: blue	gray
Chambers: red	gray
Chambers: black	blue
Potential distributor , top four chambers yellow, bottom four chambers black	gray
top four chambers black, bottom four chambers yellow	gray
Potential distributor , without actuation lever, black chambers	gray
Chambers: black	blue
Potential distributor , without actuation lever, top four chambers yellow, bottom four chambers black	gray
top four chambers black, bottom four chambers yellow	gray

Ordering data			
Type	Order No.	Pcs./Pkt.	
PTRV 8-PV /BK	3270142	10	
PTRV 8-PV /BU	3270249	10	
PTRV 8-PV /RD	3270248	10	
PTRV 8-PV BU/BK	3270145	10	
PTRV 8-FE /YE BK	3270148	10	
PTRV 8-FE /BKYE	3270149	10	
FTRV 8-PV /BK	3270194	10	
FTRV 8-PV BU/BK	3270196	10	
FTRV 8-FE /YE BK	3270202	10	
FTRV 8-FE /BKYE	3270204	10	

Spacer plate , width: 8.3 mm	gray
Cable duct comb , can be snapped on	gray
Zack marker strip , flat, for marking the DP-PTRV ... spacer plate, unprinted	white
printed horizontally , numbers 1-8	white
printed horizontally , letters A-H	white
printed vertically , numbers 1-8	white
printed vertically , letters A-H	white
labeled in accordance with customer specifications	white

Accessories		
DP-PTRV 8	3270166	10
CDC-PTRV	3270167	10
ZBF 6/9,2 S8:UNBEDRUCKT	0803447	10
ZBF 6/9,2 S8,LGS:1-8	0803450	10
ZBF 6/9,2 S8,LGS:A-H	0803451	10
ZBF 6/9,2 S8,QR:1-8	0803448	10
ZBF 6/9,2 S8,QR:A-H	0803449	10
ZBF 6/9,2 S8 CUS	8191575	1

Terminal blocks – CLIPLINE complete

1.5 mm² PT Push-in connection terminal blocks

Potential distributors, eight levels



- Space-saving potential distribution with up to 32 connections
- Potential distribution blocks can be individually adapted with plug-in bridges for assembly
- Versions with 6 mm² supply option and 32 A
- Versions are available in blue and red for clear assignment
- Large-surface marking options

Notes:
1) Nominal current of 17.5 A. 32 connections
2) The maximum current of a double connection is 24 A.

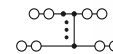

37 A, potential distributor, 29 connections, with supply, can be bridged



Dimensions	
	[mm]
Maximum electrical data	
Rated data	
Rated voltage	[V]
Nominal current / cross section	[A] / [mm ²]
Cross section range	AWG
Connection capacity	
1 conductor	[mm ²]
Connection cross sections directly plug-in	[mm ²]
Rated data, feed	
Nominal current / cross section	[A] / [mm ²]
Maximum current	[A]
Cross section range	AWG
Supply connection capacity	
1 conductor	[mm ²]
Connection cross sections directly plug-in	[mm ²]

Technical data				
Width	Length	Height NS 35/7,5		
8.3	100	87.5		
I _{max} [A]	U _{max} [V]	max. Ø [mm ²]	AWG (UL)	
24	250	0.14 - 2.5	12-10	
IEC 60947-7-1				
IEC	UL / CUL	CSA	IEC/EN 60079-7	
250	-	-	-	
17.5 ² / 1.5	-	-	-	
26 - 14	12-10	-	-	
Connection capacity	Rigid	Flexible	Ferrule without/with plastic sleeve	
1 conductor	0.14 - 2.5	0.14 - 1.5	0.14 - 1.5	0.14 - 1.5
Connection cross sections directly plug-in	0.34 - 2.5	-	0.34 - 1.5	0.34 - 1.5
Rated data, feed	IEC	UL / CUL	CSA	IEC/EN 60079-7
Nominal current / cross section	32 / 4	-	-	-
Maximum current	37	-	-	-
Cross section range	24 - 10	12-10	-	-
Supply connection capacity	Rigid	Flexible	Ferrule without/with plastic sleeve	
1 conductor	0.2 - 6	0.2 - 6	0.2 - 6	0.2 - 6
Connection cross sections directly plug-in	0.34 - 6	-	0.34 - 6	0.34 - 6

Description	Color
Potential distributor, with supply	gray
Chambers: blue	gray
Chambers: red	gray
Potential distributor¹⁾	gray
Chambers: blue	gray
Chambers: red	gray
Potential distributor, with supply, without actuation lever	gray
Potential distributor, without actuation lever¹⁾	gray

Ordering data			
Type	I _{max}	Order No.	Pcs./Pkt.
PTRVB 8-FI /BK		3270160	10
PTRVB 8-FI /BU		3270225	10
PTRVB 8-FI /RD		3270224	10
PTRVB 8-PV /BK		3270159	10
PTRVB 8-PV /BU		3270227	10
PTRVB 8-PV /RD		3270226	10
FTRVB 8-FI /BK		3270210	10
FTRVB 8-PV /BK		3270209	10

Spacer plate, width: 8.3 mm	gray
Continuous plug-in bridge, 500 mm long, isolated, can be cut to length, for potential distribution	
Nominal current: 32 A	red gray
Zack marker strip, flat, for marking the DP-PTRV ... spacer plate, unprinted	white
printed horizontally, numbers 1-8	white
printed horizontally, letters A-H	white
printed vertically, numbers 1-8	white
printed vertically, letters A-H	white
labeled in accordance with customer specifications	white

Accessories			
Type	I _{max}	Order No.	Pcs./Pkt.
DP-PTRV 8		3270166	10
FBST 500-PLC RD	32 A	2966786	20
FBST 500-PLC GY	32 A	2966838	20
ZBF 6/9,2 S8:UNBEDRUCKT		0803447	10
ZBF 6/9,2 S8,LGS:1-8		0803450	10
ZBF 6/9,2 S8,LGS:A-H		0803451	10
ZBF 6/9,2 S8,QR:1-8		0803448	10
ZBF 6/9,2 S8,QR:A-H		0803449	10
ZBF 6/9,2 S8 CUS		8191575	1

Accessories

- Space-saving partition and end cover with isolating function
- Same shape as the PTRV ... marshalling panel



General data		Technical data			Technical data		
Material		PA			PA		
Description		Ordering data			Ordering data		
Description	Color	Type	Order No.	Pcs./Pkt.	Type	Order No.	Pcs./Pkt.
Cover, can be grouped, unprinted							
printed vertically, numbers 1-8	white	D-PTRV 8 WH	3270154	10			
printed horizontally, numbers 1-8	white	D-PTRV 8 WH 1-8	3270155	10			
printed vertically, numbers 8-1	white	D-PTRV 8 WH 8-1	3270240	10			
printed horizontally, numbers 8-1	white	D-PTRV 8 WH 8-1 LGS	3270242	10			
printed vertically, numbers 1-16	white	D-PTRV 8 WH 1-16	3270228	10			
printed horizontally, numbers 1-16	white	D-PTRV 8 WH 1-16 LGS	3270229	10			
printed vertically, numbers 9-16	white	D-PTRV 8 WH 9-16	3270211	10			
printed horizontally, numbers 9-16	white	D-PTRV 8 WH 9-16 LGS	3270212	10			
printed vertically, numbers 17-24	white	D-PTRV 8 WH 17-24	3270213	10			
printed horizontally, numbers 17-24	white	D-PTRV 8 WH 17-24 LGS	3270214	10			
printed vertically, numbers 25-32	white	D-PTRV 8 WH 25-32	3270215	10			
printed horizontally, numbers 25-32	white	D-PTRV 8 WH 25-32 LGS	3270216	10			
printed vertically, letters A-H	white	D-PTRV 8 WH A-H	3270156	10			
printed horizontally, letters A-H	white	D-PTRV 8 WH A-H LGS	3270241	10			
printed vertically, letters H-A	white	D-PTRV 8 WH H-A	3270243	10			
printed horizontally, letters H-A	white	D-PTRV 8 WH H-A LGS	3270245	10			
printed vertically, letters A-P	white	D-PTRV 8 WH A-P	3270217	10			
printed horizontally, letters A-P	white	D-PTRV 8 WH A-P LGS	3270218	10			
Marking strips, no loss of pitch,							
printed vertically, numbers 1-8	white				TM-PTRV 8,QR:1-8	0803468	10
printed vertically, numbers 8-1	white				TM-PTRV 8,QR:8-1	0803470	10
printed vertically, letters A-H	white				TM-PTRV 8,QR:A-H	0803471	10
printed vertically, letters H-A	white				TM-PTRV 8,QR:H-A	0803473	10

Marshalling terminals for free assembly

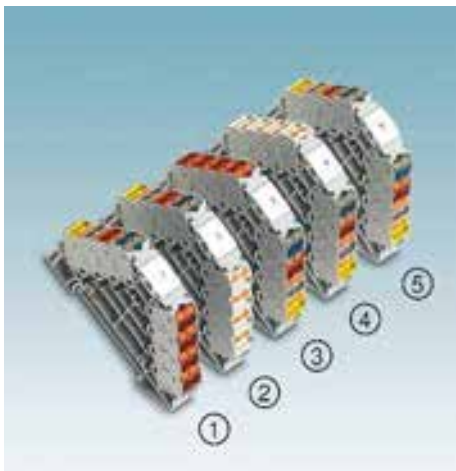

- The marshalling terminals can be easily configured and ordered with just a click of the mouse in the product area on our website at phoenixcontact.net/products
- To order via fax or e-mail, please use the ordering data as shown in the ordering example on the following page
- Freely configurable marshalling terminal with 11 colors to choose from
- Level-based color configuration
- Various combinations possible for creating a marshalling pitch

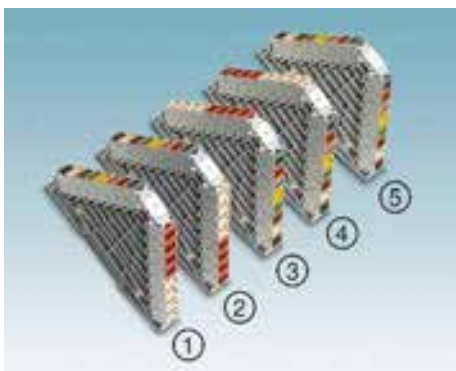

Notes:
For technical data and accessories, see page 46.

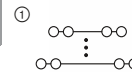

Marshalling terminal, color configuration in accordance with customer specifications



Ordering data

Description	Color	Type	Order No.	Pcs./Pkt.
① Marshalling terminal, 4-pos., left side color can be freely configured, right side color: red	gray	PTRV 4 /COL-RD	① 3001754	10
② Left side color can be freely configured, right side color: white	gray	PTRV 4 /COL-WH	① 3001871	10
③ Left side color: red, right side color can be freely configured	gray	PTRV 4 /RD-COL	① 3001872	10
④ Left side color: white, right side color can be freely configured	gray	PTRV 4 /WH-COL	① 3001874	10
⑤ Left and right side colors can be freely configured, same colors on each level	gray	PTRV 4 /COL-COL	① 3001875	10
① Marshalling terminal, 8-pos., left side color can be freely configured, right: upper 4 chambers: red, lower 4 chambers white	gray	PTRV 8 /COL-RDWH	① 3001851	10
② Left side color can be freely configured, right: upper 4 chambers: white, lower 4 chambers: red	gray	PTRV 8 /COL-WHRD	① 3001876	10
③ Left: upper 4 chambers: red, lower 4 chambers: white, right side color can be freely configured	gray	PTRV 8 /RDWH-COL	① 3001877	10
④ Left: upper 4 chambers: white, lower 4 chambers: red, right side color can be freely configured	gray	PTRV 8 /WHRD-COL	① 3001878	10
⑤ Left and right side colors can be freely configured, same colors on each level	gray	PTRV 8 /COL-COL	① 3001879	10
① Marshalling terminal, without actuation lever, 4-pos., left side color can be freely configured, right side color: red	gray	FTRV 4 /COL-RD	① 3001760	10
② Left side color can be freely configured, right side color: white	gray	FTRV 4 /COL-WH	① 3001880	10
③ Left side color: red, right side color can be freely configured	gray	FTRV 4 /RD-COL	① 3001881	10
④ Left side color: white, right side color can be freely configured	gray	FTRV 4 /WH-COL	① 3001882	10
⑤ Left and right side colors can be freely configured, same colors on each level	gray	FTRV 4 /COL-COL	① 3001883	10
① Marshalling terminal, without actuation lever, 8-pos., left side color can be freely configured, right: upper 4 chambers: red, lower 4 chambers: white	gray	FTRV 8 /COL-RDWH	① 3001852	10
② Left side color can be freely configured, right: upper 4 chambers: white, lower 4 chambers: red	gray	FTRV 8 /COL-WHRD	① 3001884	10
③ Left: upper 4 chambers: red, lower 4 chambers: white, right side color can be freely configured	gray	FTRV 8 /RDWH-COL	① 3001885	10
④ Left: upper 4 chambers: white, lower 4 chambers: red, right side color can be freely configured	gray	FTRV 8 /WHRD-COL	① 3001887	10
⑤ Left and right side colors can be freely configured, same colors on each level	gray	FTRV 8 /COL-COL	① 3001888	10

Ordering example: Configured marshaling terminal

Ordering example:

A marshaling terminal with eight levels should be configured as follows in accordance with DIN VDE 0815:

The right side is marked red in the upper levels 1 - 4, and the lower levels 5 - 8 are marked white.

Please select order number **3001851** from the configurable items.

The levels on the left side should be colored.

- Level 1: blue
- Level 2: red
- Level 3: gray
- Level 4: yellow
- Level 5: green
- Level 6: brown
- Level 7: white
- Level 8: black

Available colors:

- BU Blue
- RD Red
- GY Gray
- YE Yellow
- GN Green
- BN Brown
- WH White
- BK Black
- VT Purple
- OG Orange
- PK Pink



Specify the color sequence when ordering, as illustrated below in the ordering example.

The order data for this ordering example is therefore:

Order No.	Level 1	Level 2	Level 3	Level 4	Level 5	Level 6	Level 7	Level 8
3001851	BU	RD	GY	YE	GN	BN	WH	BK

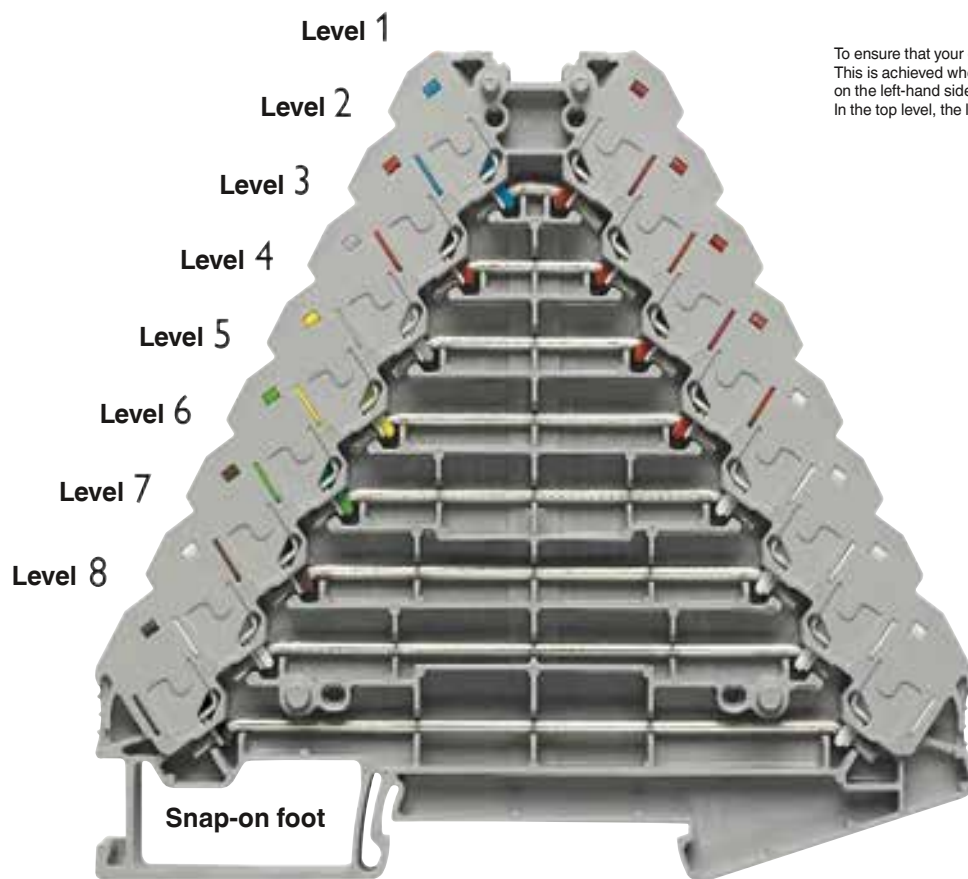

To ensure that your order is correct, you need a defined view. This is achieved when the snap-on foot in the top view is located on the left-hand side. In the top level, the letter L is visible on the left-hand side.



Terminal blocks – CLIPLINE complete

1.5 mm² PT Push-in connection terminal blocks

Marshalling patchboards, for self-assembly



The modular design allows the exact number of positions to be configured for a specific application. Up to 20% increase in signal density due to the compact design.

- The elements snap in easily and securely
- The construction is made up of blocks, making it extremely stable and warp resistant



Freely configurable color assignment for conductors and terminal points, enabling intuitive and safe installation. Terminal point coding with 11 colors to choose from.



Optional snap-on adapters enable easy mounting on standard DIN rails. Adapters can be directly mounted on panel cutouts or 19" racks.



DF-PTMC-3 -ZB snap-on marker adapters for side mounting are available for matrix marking.

Notes:

¹⁾ Derating curve available on request.

Dimensions

[mm]

Maximum electrical data

Rated data

Rated voltage [V]

Nominal current / cross section [A] / [mm²]

Cross section range AWG

Connection capacity

1 conductor [mm²]

Connection cross sections directly plug-in [mm²]

Description	Color
Marshalling patchboard, single element, gray chamber	gray
Chambers: white	gray
Chambers: blue	gray
Chambers: red	gray
Chambers: green	gray
Chambers: brown	gray
Chambers: black	gray
Chambers: violet	gray
Chambers: orange	gray
Chambers: yellow	gray
Chambers: pink	gray
Marshalling patchboard, without actuation lever, single element, gray chamber	gray
Chambers: white	gray
Chambers: blue	gray
Chambers: red	gray
Chambers: green	gray
Chambers: brown	gray
Chambers: black	gray
Chambers: violet	gray
Chambers: orange	gray
Chambers: yellow	gray
Chambers: pink	gray

Cover flange, for direct mounting above gray

Cover flange, for direct mounting below gray

Adapter, for mounting on a DIN rail gray

Marker adapter, for direct mounting above and to hold marking gray

Marker adapter, for holding the marking, width 12.2 mm gray

width 8.5 mm gray

Test plug metal part, 2.3 mm Ø gray

Insulating sleeve, for MPS metal part red

Marking

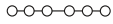

24 A, single element, 6 connections



24 A, single element, 4 connections



Technical data			
Width	Length	Height	
11	12.2	30	
I_{max} [A]	U_{max} [V]	max. Ø [mm ²]	AWG (UL)
24 ¹⁾	500	0.14 - 2.5	24-16
IEC 60947-7-1			
IEC	UL / CUL	CSA	IEC/ EN 60079-7
500	300	300	-
17.5 ¹⁾ / -	10	10 / -	-
26 - 14	24-16	24-16	-
Rigid	Flexible	Ferrule without/with plastic sleeve	
0.14 - 2.5	0.14 - 1.5	0.14 - 1.5	0.14 - 1.5
0.34 - 2.5	-	0.34 - 1.5	0.34 - 1.5

Technical data			
Width	Length	Height	
11	8.6	30	
I_{max} [A]	U_{max} [V]	max. Ø [mm ²]	AWG (UL)
24 ¹⁾	500	0.14 - 2.5	24-16
IEC 60947-7-1			
IEC	UL / CUL	CSA	IEC/ EN 60079-7
500	300	300	-
17.5 ¹⁾ / -	10	10 / -	-
26 - 14	24-16	24-16	-
Rigid	Flexible	Ferrule without/with plastic sleeve	
0.14 - 2.5	0.14 - 1.5	0.14 - 1.5	0.14 - 1.5
0.34 - 2.5	-	0.34 - 1.5	0.34 - 1.5

Ordering data		
Type	Order No.	Pcs./Pkt.
PTMC 1,5-3 /GY	3270300	10
PTMC 1,5-3 /WH	3270301	10
PTMC 1,5-3 /BU	3270420	10
PTMC 1,5-3 /RD	3270421	10
PTMC 1,5-3 /GN	3270422	10
PTMC 1,5-3 /BN	3270423	10
PTMC 1,5-3 /BK	3270424	10
PTMC 1,5-3 /VT	3270425	10
PTMC 1,5-3 /OG	3270426	10
PTMC 1,5-3 /YE	3270427	10
PTMC 1,5-3 /PK	3270428	10
FTMC 1,5-3 /GY	3270340	10
FTMC 1,5-3 /WH	3270341	10
FTMC 1,5-3 /BU	3270440	10
FTMC 1,5-3 /RD	3270441	10
FTMC 1,5-3 /GN	3270442	10
FTMC 1,5-3 /BN	3270443	10
FTMC 1,5-3 /BK	3270444	10
FTMC 1,5-3 /VT	3270445	10
FTMC 1,5-3 /OG	3270446	10
FTMC 1,5-3 /YE	3270447	10
FTMC 1,5-3 /PK	3270448	10

Ordering data		
Type	Order No.	Pcs./Pkt.
PTMC 1,5-2 /GY	3270302	10
PTMC 1,5-2 /WH	3270303	10
PTMC 1,5-2 /BU	3270430	10
PTMC 1,5-2 /RD	3270431	10
PTMC 1,5-2 /GN	3270432	10
PTMC 1,5-2 /BN	3270433	10
PTMC 1,5-2 /BK	3270434	10
PTMC 1,5-2 /VT	3270435	10
PTMC 1,5-2 /OG	3270436	10
PTMC 1,5-2 /YE	3270437	10
PTMC 1,5-2 /PK	3270438	10
FTMC 1,5-2 /GY	3270342	10
FTMC 1,5-2 /WH	3270343	10
FTMC 1,5-2 /BU	3270450	10
FTMC 1,5-2 /RD	3270451	10
FTMC 1,5-2 /GN	3270452	10
FTMC 1,5-2 /BN	3270453	10
FTMC 1,5-2 /BK	3270454	10
FTMC 1,5-2 /VT	3270455	10
FTMC 1,5-2 /OG	3270456	10
FTMC 1,5-2 /YE	3270457	10
FTMC 1,5-2 /PK	3270458	10

Accessories		
DF-PTMC-O	3270400	10
DF-PTMC-U	3270401	10
DF-PTMC-NS	3270403	10
DF-PTMC-ZB	3270410	10
DF-PTMC-3-ZB	3270405	10
MPS-MT	0201744	10
MPS-IH RD	0201676	10

Accessories		
DF-PTMC-O	3270400	10
DF-PTMC-U	3270401	10
DF-PTMC-NS	3270403	10
DF-PTMC-ZB	3270410	10
DF-PTMC-2-ZB	3270406	10
MPS-MT	0201744	10
MPS-IH RD	0201676	10

UC-TM 10, UCT-TM 10 or ZB 10
(see Catalog 3)

UC-TM 10, UCT-TM 10 or ZB 10
(see Catalog 3)

Terminal blocks – CLIPLINE complete

1.5 mm² PT Push-in connection terminal blocks

Marshalling patchboards, pre-assembled with six connections per element



- Compact design that requires less space than 19" standard versions
- Easy and tool-free wiring, thanks to Push-in connection
- Six conductors up to 2.5 mm² can be connected to one potential by means of the three conductor connections
- Large-surface marking options
- Convenient testing by means of freely accessible 2.3 mm test connections
- Optimum overview thanks to numbered marshalling patchboard elements
- Blue marshalling patchboards for use in Ex i safety circuits
- FTMC versions are available without actuation lever

Notes:
1) Derating curve available on request.

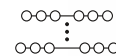

24 A, 32-pos., 192 connections



Dimensions	
	[mm]
Maximum electrical data	
Rated data	
Rated voltage	[V]
Nominal current / cross section	[A] / [mm ²]
Cross section range	AWG
Connection capacity	
1 conductor	[mm ²]
Connection cross sections directly plug-in	[mm ²]

Technical data				
Width	Length	Height		
44	102	30		
I _{max} [A]	U _{max} [V]	max. Ø [mm ²]	AWG (UL)	
24 ¹⁾	500	0.14 - 2.5	24-16	
IEC 60947-7-1				
IEC	UL / CUL	CSA	IEC/EN 60079-7	
Rated voltage	300	300	-	
Nominal current / cross section	10	10 / -	-	
Cross section range	24-16	24-16	-	
Connection capacity		Rigid	Flexible	Ferrule
				without/with plastic sleeve
1 conductor	0.14 - 2.5	0.14 - 1.5	0.14 - 1.5	0.14 - 1.5
Connection cross sections directly plug-in	0.34 - 2.5	-	0.34 - 1.5	0.34 - 1.5

Description	Color
Marshalling patchboard, 32-pos., chambers: gray/white	gray
Chambers: blue	gray
Marshalling patchboard, 48-pos., chambers: gray/white	gray
Chambers: blue	gray
Marshalling patchboard, 80-pos., chambers: gray/white	gray
Chambers: blue	gray
Marshalling patchboard, without actuation lever, 32-pos., chambers: gray/white	gray
Chambers: blue	gray
Marshalling patchboard, without actuation lever, 48-pos., chambers: gray/white	gray
Chambers: blue	gray
Marshalling patchboard, without actuation lever, 80-pos., chambers: gray/white	gray
Chambers: blue	gray

Ordering data			
Type	Order No.	Pcs./Pkt.	
PTMC 1,5/32-3	3270310	18	
PTMC 1,5/32-3 /BU	3270312	18	
FTMC 1,5/32-3	3270350	18	
FTMC 1,5/32-3 /BU	3270352	18	

Cover flange, for direct mounting above	gray
Cover flange, for direct mounting below	gray
Adapter, for mounting on a DIN rail	gray
Marker adapter, for direct mounting above and to hold marking	gray
Marker adapter, for holding the marking, width 12.2 mm	gray
Test plug metal part, 2.3 mm Ø	gray
Insulating sleeve, for MPS metal part	red

Accessories			
DF-PTMC-O	3270400	10	
DF-PTMC-U	3270401	10	
DF-PTMC-NS	3270403	10	
DF-PTMC-ZB	3270410	10	
DF-PTMC-3-ZB	3270405	10	
MPS-MT	0201744	10	
MPS-IH RD	0201676	10	

Marking
UC-TM 10, UCT-TM 10 or ZB 10 (see Catalog 3)



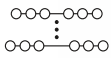

24 A, 48-pos., 288 connections

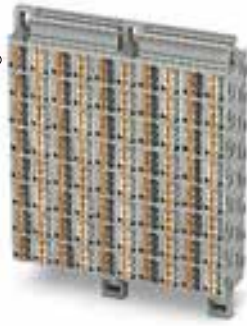
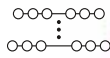

24 A, 80-pos., 480 connections



Technical data			
Width	Length	Height	
66	102	30	
I_{max} [A]	U_{max} [V]	max. Ø [mm ²]	AWG (UL)
24 ¹⁾	500	0.14 - 2.5	24-16
IEC 60947-7-1			
IEC	UL / CUL	CSA	IEC / EN 60079-7
500	300	300	-
17.5 ¹⁾ / -	10	10 / -	-
26 - 14	24-16	24-16	-
Rigid	Flexible	Ferrule without/with plastic sleeve	
0.14 - 2.5	0.14 - 1.5	0.14 - 1.5	0.14 - 1.5
0.34 - 2.5	-	0.34 - 1.5	0.34 - 1.5

Technical data			
Width	Length	Height	
110	102	30	
I_{max} [A]	U_{max} [V]	max. Ø [mm ²]	AWG (UL)
24 ¹⁾	500	0.14 - 2.5	24-16
IEC 60947-7-1			
IEC	UL / CUL	CSA	IEC / EN 60079-7
500	300	300	-
17.5 ¹⁾ / -	10	10 / -	-
26 - 14	24-16	24-16	-
Rigid	Flexible	Ferrule without/with plastic sleeve	
0.14 - 2.5	0.14 - 1.5	0.14 - 1.5	0.14 - 1.5
0.34 - 2.5	-	0.34 - 1.5	0.34 - 1.5

Ordering data		
Type	Order No.	Pcs./Pkt.
PTMC 1,5/48-3	3270318	10
PTMC 1,5/48-3 /BU	3270320	10
FTMC 1,5/48-3	3270358	10
FTMC 1,5/48-3 /BU	3270360	10

Ordering data		
Type	Order No.	Pcs./Pkt.
PTMC 1,5/80-3	3270324	6
PTMC 1,5/80-3 /BU	3270326	6
FTMC 1,5/80-3	3270364	6
FTMC 1,5/80-3 /BU	3270366	6

Accessories		
DF-PTMC-O	3270400	10
DF-PTMC-U	3270401	10
DF-PTMC-NS	3270403	10
DF-PTMC-ZB	3270410	10
DF-PTMC-3-ZB	3270405	10
MPS-MT	0201744	10
MPS-IH RD	0201676	10

Accessories		
DF-PTMC-O	3270400	10
DF-PTMC-U	3270401	10
DF-PTMC-NS	3270403	10
DF-PTMC-ZB	3270410	10
DF-PTMC-3-ZB	3270405	10
MPS-MT	0201744	10
MPS-IH RD	0201676	10

UC-TM 10, UCT-TM 10 or ZB 10
(see Catalog 3)

UC-TM 10, UCT-TM 10 or ZB 10
(see Catalog 3)

Terminal blocks – CLIPLINE complete

1.5 mm² PT Push-in connection terminal blocks

Marshalling patchboards, pre-assembled with four connections per element

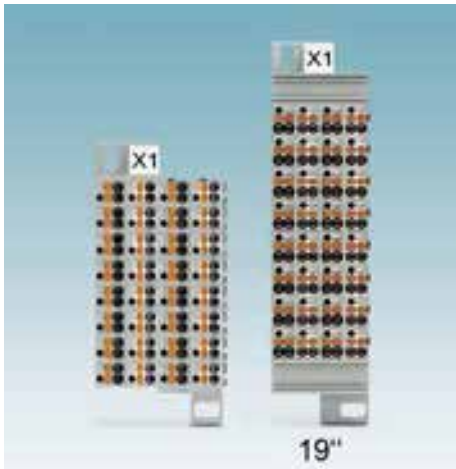

- Maximum signal density with 20% less space required than 19" standard versions
- Easy and tool-free wiring thanks to Push-in connection
- Six conductors up to 2.5 mm² can be connected to one potential by means of the three conductor connections
- Large-surface marking options
- Convenient testing by means of freely accessible 2.3 mm test connections
- Optimum overview thanks to numbered marshalling patchboard elements
- Blue marshalling patchboards for use in Ex i safety circuits
- FTMC versions are available without actuation lever

Notes:
1) Derating curve available on request.

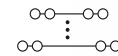

24 A, 32-pos., 128 connections



Dimensions	
	[mm]
Maximum electrical data	
Rated voltage	[V]
Nominal current / cross section	[A] / [mm ²]
Cross section range	AWG
Connection capacity	
1 conductor	[mm ²]
Connection cross sections directly plug-in	[mm ²]

Technical data				
Width	Length	Height		
44	73.2	30		
I _{max} [A]	U _{max} [V]	max. Ø [mm ²]	AWG (UL)	
24 ¹⁾	500	0.14 - 2.5	24-16	
IEC 60947-7-1				
IEC	UL / CUL	CSA	IEC/EN 60079-7	
Rated voltage	500	300	300	
Nominal current / cross section	17.5 ¹⁾ / -	10	10 / -	
Cross section range	26 - 14	24-16	24-16	
Connection capacity		Rigid	Flexible	Ferrule
				without/with plastic sleeve
1 conductor	0.14 - 2.5	0.14 - 1.5	0.14 - 1.5	0.14 - 1.5
Connection cross sections directly plug-in	0.34 - 2.5	-	0.34 - 1.5	0.34 - 1.5

Description	Color
Marshalling patchboard , 32-pos., chambers: gray/white	gray
Chambers: blue	gray
Marshalling patchboard , 48-pos., chambers: gray/white	gray
Chambers: blue	gray
Marshalling patchboard , 80-pos., chambers: gray/white	gray
Chambers: blue	gray
Marshalling patchboard , without actuation lever, 32-pos., chambers: gray/white	gray
Chambers: blue	gray
Marshalling patchboard , without actuation lever, 48-pos., chambers: gray/white	gray
Chambers: blue	gray
Marshalling patchboard , without actuation lever, 80-pos., chambers: gray/white	gray
Chambers: blue	gray

Ordering data			
Type	Order No.	Pcs./Pkt.	
PTMC 1,5/32-2	3270314	18	
PTMC 1,5/32-2 /BU	3270315	18	
FTMC 1,5/32-2	3270354	18	
FTMC 1,5/32-2 /BU	3270355	18	

Cover flange , for direct mounting above	gray
Cover flange , for direct mounting below	gray
Adapter , for mounting on a DIN rail	gray
Marker adapter , for direct mounting above and to hold marking	gray
Marker adapter , for holding the marking, width 8.5 mm	gray
Test plug metal part , 2.3 mm Ø	gray
Insulating sleeve , for MPS metal part	red

Accessories			
DF-PTMC-O	3270400	10	
DF-PTMC-U	3270401	10	
DF-PTMC-NS	3270403	10	
DF-PTMC-ZB	3270410	10	
DF-PTMC-2-ZB	3270406	10	
MPS-MT	0201744	10	
MPS-IH RD	0201676	10	

Marking
UC-TM 10, UCT-TM 10 or ZB 10 (see Catalog 3)

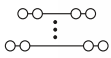

24 A, 48-pos., 192 connections

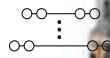

24 A, 80-pos., 320 connections



Technical data			
Width	Length	Height	
66	73.2	30	
I_{max} [A]	U_{max} [V]	max. Ø [mm ²]	AWG (UL)
24 ¹⁾	500	0.14 - 2.5	24-16
IEC 60947-7-1			
IEC	UL / CUL	CSA	IEC/ EN 60079-7
500	300	300	-
17.5 ¹⁾ / -	10	10 / -	-
26 - 14	24-16	24-16	-
Rigid	Flexible	Ferrule without/with plastic sleeve	
0.14 - 2.5	0.14 - 1.5	0.14 - 1.5	0.14 - 1.5
0.34 - 2.5	-	0.34 - 1.5	0.34 - 1.5

Technical data			
Width	Length	Height	
110	73.2	30	
I_{max} [A]	U_{max} [V]	max. Ø [mm ²]	AWG (UL)
24 ¹⁾	500	0.14 - 2.5	24-16
IEC 60947-7-1			
IEC	UL / CUL	CSA	IEC/ EN 60079-7
500	300	300	-
17.5 ¹⁾ / -	10	10 / -	-
26 - 14	24-16	24-16	-
Rigid	Flexible	Ferrule without/with plastic sleeve	
0.14 - 2.5	0.14 - 1.5	0.14 - 1.5	0.14 - 1.5
0.34 - 2.5	-	0.34 - 1.5	0.34 - 1.5

Ordering data		
Type	Order No.	Pcs./Pkt.
PTMC 1,5/48-2	3270322	10
PTMC 1,5/48-2 /BU	3270323	10
FTMC 1,5/48-2	3270362	10
FTMC 1,5/48-2 /BU	3270363	10

Ordering data		
Type	Order No.	Pcs./Pkt.
PTMC 1,5/80-2	3270329	6
PTMC 1,5/80-2 /BU	3270330	6
FTMC 1,5/80-2	3270368	6
FTMC 1,5/80-2 /BU	3270369	6

Accessories		
DF-PTMC-O	3270400	10
DF-PTMC-U	3270401	10
DF-PTMC-NS	3270403	10
DF-PTMC-ZB	3270410	10
DF-PTMC-2-ZB	3270406	10
MPS-MT	0201744	10
MPS-IH RD	0201676	10

Accessories		
DF-PTMC-O	3270400	10
DF-PTMC-U	3270401	10
DF-PTMC-NS	3270403	10
DF-PTMC-ZB	3270410	10
DF-PTMC-2-ZB	3270406	10
MPS-MT	0201744	10
MPS-IH RD	0201676	10

UC-TM 10, UCT-TM 10 or ZB 10
(see Catalog 3)

UC-TM 10, UCT-TM 10 or ZB 10
(see Catalog 3)

Terminal blocks – CLIPLINE complete

1.5 mm² PT Push-in connection terminal blocks

Marshalling patchboards for 19", six connections per element

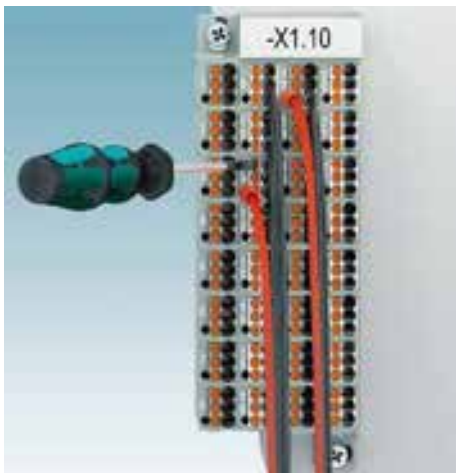

- Size in accordance with standard DIN EN 60297-3-101 for 19" housing
- Easy and tool-free wiring thanks to Push-in connection
- Six conductors up to 2.5 mm² can be connected to one potential by means of the three conductor connections
- Large-surface marking options
- Convenient testing by means of freely accessible 2.3 mm test connections
- Optimum overview thanks to numbered marshalling patchboard elements
- Blue marshalling patchboards for use in Ex i safety circuits
- FTMC versions are available without actuation lever

Notes:
1) Derating curve available on request.

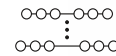

24 A, 32-pos., 192 connections, 6 connections per element



Dimensions	
	[mm]
Maximum electrical data	
Rated data	
Rated voltage	[V]
Nominal current / cross section	[A] / [mm ²]
Cross section range	AWG
Connection capacity	
1 conductor	[mm ²]
Connection cross sections directly plug-in	[mm ²]

Technical data				
Width	Length	Height		
44	111	30		
I _{max} [A]	U _{max} [V]	max. Ø [mm ²]	AWG (UL)	
24 ¹⁾	500	0.14 - 2.5	24-16	
IEC 60947-7-1				
IEC	UL / CUL	CSA	IEC/EN 60079-7	
500	300	300	-	
17.5 ¹⁾ / -	10	10 / -	-	
26 - 14	24-16	24-16	-	
Connection capacity		Rigid	Flexible	Ferrule
				without/with plastic sleeve
1 conductor	[mm ²]	0.14 - 2.5	0.14 - 1.5	0.14 - 1.5 0.14 - 1.5
Connection cross sections directly plug-in	[mm ²]	0.34 - 2.5	-	0.34 - 1.5 0.34 - 1.5

Description	Color
Marshalling patchboard, 32-pos., chambers: gray/white	gray
Chambers: blue	gray
Marshalling patchboard, 32-pos., colors of individual elements comply with color code VDE 0815	gray
Marshalling patchboard, 48-pos., chambers: gray/white	gray
Chambers: blue	gray
Marshalling patchboard, 80-pos., chambers: gray/white	gray
Chambers: blue	gray
Marshalling patchboard, without actuation lever, 32-pos., chambers: gray/white	gray
Chambers: blue	gray
Marshalling patchboard, without actuation lever, 48-pos., chambers: gray/white	gray
Chambers: blue	gray
Marshalling patchboard, without actuation lever, 80-pos., chambers: gray/white	gray

Ordering data			
Type	Order No.	Pcs./Pkt.	
PTMC 1,5/32-3 19Z	3270311	18	
PTMC 1,5/32-3 /BU 19Z	3270313	18	
FTMC 1,5/32-3 19Z	3270351	18	
FTMC 1,5/32-3 /BU 19Z	3270353	18	

Cover flange, for direct mounting above	gray
Cover flange, for direct mounting below	gray
Adapter, for mounting on a DIN rail	gray
Marker adapter, for direct mounting above and to hold marking	gray

Accessories		
DF-PTMC-O	3270400	10
DF-PTMC-U	3270401	10
DF-PTMC-NS	3270403	10
DF-PTMC-ZB	3270410	10

Marking

UC-TM 10, UCT-TM 10 or ZB 10 (see Catalog 3)

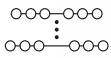

**24 A, 32-pos., 192 connections,
6 connections per element**

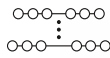

**24 A, 48-pos., 288 connections,
6 connections per element**

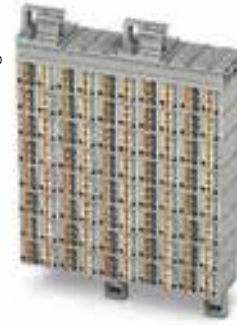
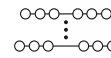

**24 A, 80-pos., 480 connections,
6 connections per element**

ERC

UL US ERC

UL US ERC

Technical data			
Width	Length	Height	
44	111	30	
I_{max} [A]	U_{max} [V]	max. Ø [mm ²]	AWG (UL)
24	500	0.14 - 2.5	-
IEC 60947-7-1			
IEC	UL / CUL	CSA	IEC/ EN 60079-7
500	-	-	-
17.5 / -	-	-	-
26 - 14	-	-	-
Rigid	Flexible	Ferrule without/with plastic sleeve	
0.14 - 2.5	0.14 - 1.5	0.14 - 1.5	0.14 - 1.5
0.34 - 2.5	-	0.34 - 1.5	0.34 - 1.5

Technical data			
Width	Length	Height	
66	111	30	
I_{max} [A]	U_{max} [V]	max. Ø [mm ²]	AWG (UL)
24 ¹⁾	500	0.14 - 2.5	24-16
IEC 60947-7-1			
IEC	UL / CUL	CSA	IEC/ EN 60079-7
500	300	300	-
17.5 ¹⁾ / -	10	10 / -	-
26 - 14	24-16	24-16	-
Rigid	Flexible	Ferrule without/with plastic sleeve	
0.14 - 2.5	0.14 - 1.5	0.14 - 1.5	0.14 - 1.5
0.34 - 2.5	-	0.34 - 1.5	0.34 - 1.5

Technical data			
Width	Length	Height	
110	111	30	
I_{max} [A]	U_{max} [V]	max. Ø [mm ²]	AWG (UL)
24 ¹⁾	500	0.14 - 2.5	24-16
IEC 60947-7-1			
IEC	UL / CUL	CSA	IEC/ EN 60079-7
500	300	300	-
17.5 ¹⁾ / -	10	10 / -	-
26 - 14	24-16	24-16	-
Rigid	Flexible	Ferrule without/with plastic sleeve	
0.14 - 2.5	0.14 - 1.5	0.14 - 1.5	0.14 - 1.5
0.34 - 2.5	-	0.34 - 1.5	0.34 - 1.5

Ordering data		
Type	Order No.	Pcs./Pkt.
PTMC 1,5/32-3 VDE0815 19Z	3270394	18

Ordering data		
Type	Order No.	Pcs./Pkt.
PTMC 1,5/48-3 19Z	3270319	10
PTMC 1,5/48-3 /BU 19Z	3270321	10
FTMC 1,5/48-3 19Z	3270359	10
FTMC 1,5/48-3 /BU 19Z	3270361	10

Ordering data		
Type	Order No.	Pcs./Pkt.
PTMC 1,5/80-3 19Z	3270325	6
PTMC 1,5/80-3 /BU 19Z	3270327	6
FTMC 1,5/80-3 19Z	3270365	6
FTMC 1,5/80-3 /BU 19Z	3270367	6

Accessories		
DF-PTMC-O	3270400	10
DF-PTMC-U	3270401	10
DF-PTMC-NS	3270403	10
DF-PTMC-ZB	3270410	10

Accessories		
DF-PTMC-O	3270400	10
DF-PTMC-U	3270401	10
DF-PTMC-NS	3270403	10
DF-PTMC-ZB	3270410	10

Accessories		
DF-PTMC-O	3270400	10
DF-PTMC-U	3270401	10
DF-PTMC-NS	3270403	10
DF-PTMC-ZB	3270410	10

UC-TM 10, UCT-TM 10 or ZB 10
(see Catalog 3)

UC-TM 10, UCT-TM 10 or ZB 10
(see Catalog 3)

UC-TM 10, UCT-TM 10 or ZB 10
(see Catalog 3)

Terminal blocks – CLIPLINE complete

1.5 mm² PT Push-in connection terminal blocks

Marshalling patchboards for 19", six connections per element

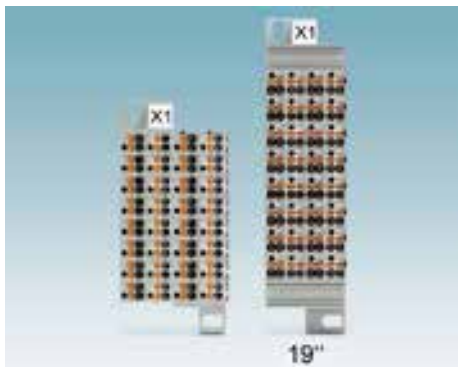

- PTMC 1,5/32-2H 19Z version with compact overall width of 34.4 mm and four connections per element
- Easy and tool-free wiring thanks to Push-in connection
 - Convenient testing by means of freely accessible 2.3 mm test connections
 - Optimum overview thanks to numbered marshalling patchboard elements
 - Blue marshalling patchboards for use in Ex i safety circuits
 - FTMC versions are available without actuation lever

Notes:
1) Derating curve available on request.

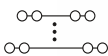

24 A, 32-pos., 128 connections



Dimensions	
	[mm]
Maximum electrical data	
Rated data	
Rated voltage	[V]
Nominal current / cross section	[A] / [mm ²]
Cross section range	AWG
Connection capacity	
1 conductor	[mm ²]
Connection cross sections directly plug-in	[mm ²]

Technical data				
Width	Length	Height		
34.4	111	30		
I_{max} [A]	U_{max} [V]	max. \varnothing [mm ²]	AWG (UL)	
24 ¹⁾	500	0.14 - 2.5	24-16	
IEC 60947-7-1				
IEC	UL / CUL	CSA	IEC/EN 60079-7	
500	300	300	-	
17.5 ¹⁾ / -	10	10 / -	-	
26 - 14	24-16	24-16	-	
Connection capacity		Rigid	Flexible	Ferrule
		without/with plastic sleeve		
1 conductor	[mm ²]	0.14 - 2.5	0.14 - 1.5	0.14 - 1.5 0.14 - 1.5
Connection cross sections directly plug-in	[mm ²]	0.34 - 2.5	-	0.34 - 1.5 0.34 - 1.5

Description	Color
Marshalling patchboard , 32-pos., four connections per chamber, chambers: gray/white	gray
Chambers: blue	gray
marked A - H	gray
Marshalling patchboard , 32-pos., four connections per chamber, marking 1 - 32, chambers: colors of individual elements comply with color code VDE 0815	gray
Marshalling patchboard , 32-pos., four connections per chamber, marking A - H, chambers: colors of individual elements comply with color code VDE 0815	gray
Marshalling patchboard , 32-pos., four connections per chamber, without actuation lever, chambers: gray/white	gray
Chambers: blue	gray
Cover flange , for direct mounting above	gray
Cover flange , for direct mounting below	gray
Adapter , for mounting on a DIN rail	gray
Marker adapter , for direct mounting above and to hold marking	gray

Ordering data			
Type	Order No.	Pcs./Pkt.	
PTMC 1,5/32-2H 19Z	3270316	24	
PTMC 1,5/32-2H /BU 19Z	3270317	24	
PTMC 1,5/32-2H 19Z A-H	3270392	24	
FTMC 1,5/32-2H 19Z	3270356	24	
FTMC 1,5/32-2H /BU 19Z	3270357	24	

Accessories			
Type	Order No.	Pcs./Pkt.	
DF-PTMC-O	3270400	10	
DF-PTMC-U	3270401	10	
DF-PTMC-NS	3270403	10	
DF-PTMC-ZB	3270410	10	

Marking	UC-TM 10, UCT-TM 10 or ZB 10 (see Catalog 3)
----------------	--

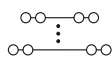

24 A, 32-pos., 128 connections

ERIC

Technical data

Width	Length	Height	
34.4	111	30	
I_{max} [A]	U_{max} [V]	max. \varnothing [mm ²]	AWG (UL)
24 ¹⁾	500	0.14 - 2.5	-
IEC 60947-7-1			
IEC	UL / CUL	CSA	IEC/ EN 60079-7
500	-	-	-
17.5 ¹⁾ / -	-	-	-
26 - 14	-	-	-
Rigid	Flexible	Ferrule without/with plastic sleeve	
0.14 - 2.5	0.14 - 1.5	0.14 - 1.5	0.14 - 1.5
0.34 - 2.5	-	0.34 - 1.5	0.34 - 1.5

Ordering data

Type	Order No.	Pcs./Pkt.
PTMC 1,5/32-2H VDE0815 19Z	3270395	24
PTMC 1,5/32-2H VDE0815 19Z A-H	3270393	24

Accessories

DF-PTMC-O	3270400	10
DF-PTMC-U	3270401	10
DF-PTMC-NS	3270403	10
DF-PTMC-ZB	3270410	10

UC-TM 10, UCT-TM 10 or ZB 10
(see Catalog 3)

Marshalling patchboards

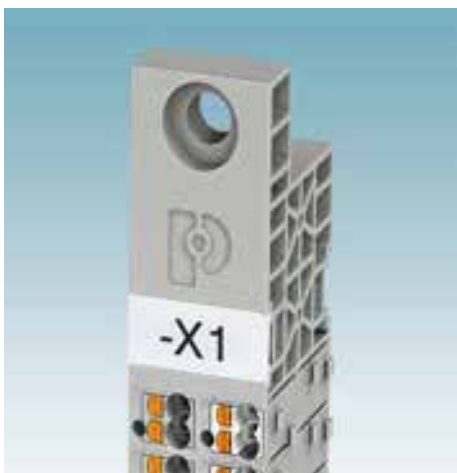

Special 18-bit marshalling patchboard for transportation technology

- Compact overall width of just 22 mm and four connections per element
- Special fastening adapter for easy wall mounting
- Easy and tool-free wiring thanks to Push-in connection
- Convenient testing by means of freely accessible 2.3 mm test connections
- Optimum overview thanks to numbered marshalling patchboard elements



24 A, 18-pos., 72 connections, 2 connections per element



Dimensions	
	[mm]
Maximum electrical data	
Rated data	
Rated voltage	[V]
Nominal current / cross section	[A] / [mm ²]
Cross section range	AWG
Connection capacity	
1 conductor	[mm ²]
Connection cross sections directly plug-in	[mm ²]
Description	
	Color
Marshalling patchboard, 18-pos., chambers: gray/white	gray
Cover flange, for direct mounting above	gray
Cover flange, for direct mounting below	gray
Adapter, for mounting on a DIN rail	gray
Marker adapter, for direct mounting above and to hold marking	gray
Marking	

Technical data			
Width	Length	Height	
22	131	30	
I_{max} [A]	U_{max} [V]	max. Ø [mm ²]	AWG (UL)
24	500	0.14 - 2.5	24-16
IEC 60947-7-1			
IEC	UL / CUL	CSA	IEC/ EN 60079-7
500	300	300	-
17.5 / -	10	10 / -	-
26 - 14	24-16	24-16	-
Connection capacity		Rigid	Flexible
		Ferrule without/with plastic sleeve	
1 conductor	[mm ²]	0.14 - 2.5	0.14 - 1.5
Connection cross sections directly plug-in	[mm ²]	0.34 - 2.5	-

Ordering data		
Type	Order No.	Pcs./Pkt.
PTMC 1,5/18	3270390	8

Accessories		
DF-PTMC-O	3270400	10
DF-PTMC-U	3270401	10
DF-PTMC-NS	3270403	10
DF-PTMC-ZB	3270410	10

UC-TM 10, UCT-TM 10 or ZB 10 (see Catalog 3)

Marshalling patchboards



Special 54-bit marshalling patchboard for transportation technology

- Compact overall width of just 33 mm and four connections per element
- Special fastening adapter for bolt mounting
- Easy and tool-free wiring thanks to Push-in connection
- Convenient testing by means of freely accessible 2.3 mm test connections
- Optimum overview thanks to numbered marshalling patchboard elements



24 A, 54-pos., 204 connections,
2 connections per element



Dimensions	
	[mm]

Maximum electrical data	

Rated data	

Rated voltage	[V]	500	300	300	-
Nominal current / cross section	[A] / [mm ²]	17.5 / -	10	10 / -	-
Cross section range	AWG	26 - 14	24-16	24-16	-

Connection capacity	

1 conductor	[mm ²]	0.14 - 2.5	0.14 - 1.5	0.14 - 1.5	0.14 - 1.5
Connection cross sections directly plug-in	[mm ²]	0.34 - 2.5	-	-	-

Description	Color
Marshalling patchboard , 54-pos., chambers: gray/white	gray

Cover flange , for direct mounting above	gray
---	------

Cover flange , for direct mounting below	gray
---	------

Adapter , for mounting on a DIN rail	gray
---	------

Marker adapter , for direct mounting above and to hold marking	gray
---	------

Marking

Technical data			
Width	Length	Height	
33	157.4	30	
I_{max} [A]	U_{max} [V]	max. \emptyset [mm ²]	AWG (UL)
24	500	0.14 - 2.5	24-16
IEC 60947-7-1			
IEC	UL / CUL	CSA	IEC / EN 60079-7
Rigid	Flexible	Ferrule without/with plastic sleeve	
0.14 - 2.5	0.14 - 1.5	0.14 - 1.5	0.14 - 1.5
0.34 - 2.5	-	-	-

Ordering data		
Type	Order No.	Pcs./Pkt.
PTMC 1,5/54	3270391	15

Accessories		
DF-PTMC-O	3270400	10
DF-PTMC-U	3270401	10
DF-PTMC-NS	3270403	10
DF-PTMC-ZB	3270410	10

Terminal blocks – CLIPLINE complete

1.5 mm² PT Push-in connection terminal blocks

Marshalling patchboards for free assembly

- The marshalling patchboards can be easily configured and ordered with just a click of the mouse in the product area on our website at phoenixcontact.net/products
- To order via fax or e-mail, please use the ordering data as shown in the ordering example on the following page

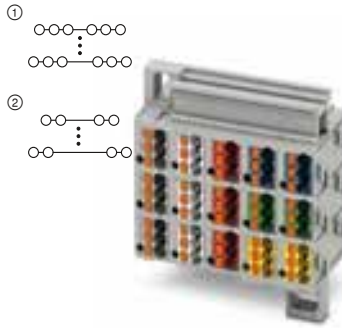

22 A, direct mounting

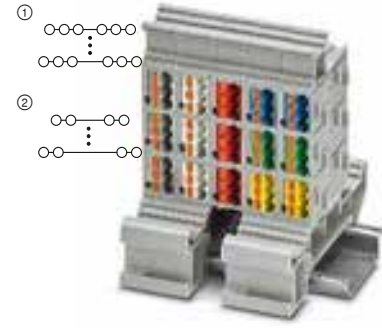

22 A, DIN rail mounting

Notes:

¹⁾ For additional accessories and technical data, see page 38.

²⁾ Derating curve available on request.



Dimensions		[mm]
Maximum electrical data		
Rated data		
Rated voltage	[V]	22 ²⁾
Nominal current / cross section	[A] / [mm ²]	500 / 1.5
Connection capacity		
1 conductor	[mm ²]	0.14 - 2.5
Connection cross sections directly plug-in		[mm ²]
		0.34 - 2.5

Technical data ¹⁾				
Width	Length	Height		
-	30	16.6		
I_{max} [A]	U_{max} [V]	max. \varnothing [mm ²]	AWG (UL)	
500	500	0.14 - 2.5	24-16	
IEC	UL / CUL	CSA	Ex	
500	300	300	-	
10^3 / 1.5	10 / -	10 / -	- / -	
Rigid	Flexible	Ferrule without/with plastic sleeve		
0.14 - 2.5	0.14 - 1.5	0.14 - 1.5	0.14 - 1.5	
0.34 - 2.5	0.34 - 1.5	0.34 - 1.5	0.34 - 1.5	

Technical data ¹⁾				
Width	Length	Height		
-	63	26.2 (NS 35/7,5)		
I_{max} [A]	U_{max} [V]	max. \varnothing [mm ²]	AWG (UL)	
500	500	0.14 - 2.5	24-16	
IEC	UL / CUL	CSA	Ex	
500	300	300	-	
10^3 / 1.5	10 / -	10 / -	- / -	
Rigid	Flexible	Ferrule without/with plastic sleeve		
0.14 - 2.5	0.14 - 1.5	0.14 - 1.5	0.14 - 1.5	
0.34 - 2.5	0.34 - 1.5	0.34 - 1.5	0.34 - 1.5	

Description	Color
Marshalling patchboard, 3 connections, 1-row	gray
2-row	gray
3-row	gray
4-row	gray
5-row	gray
6-row	gray
7-row	gray
8-row	gray
Marshalling patchboard, 2 connections, 1-row	gray
2-row	gray
3-row	gray
4-row	gray
5-row	gray
6-row	gray
7-row	gray
8-row	gray
Marshalling patchboard, without actuation lever, 3 connections, 1-row	gray
2-row	gray
3-row	gray
4-row	gray
5-row	gray
6-row	gray
7-row	gray
8-row	gray
Marshalling patchboard, without actuation lever, 2 connections, 1-row	gray
2-row	gray
3-row	gray
4-row	gray
5-row	gray
6-row	gray
7-row	gray
8-row	gray

Ordering data				
Type	Order No.	Pcs./Pkt.		
PTMC 1,5 /1-3 -DF	3001929	1	①	
PTMC 1,5 /2-3 -DF	3001930	1	①	
PTMC 1,5 /3-3 -DF	3001931	1	①	
PTMC 1,5 /4-3 -DF	3001932	1	①	
PTMC 1,5 /5-3 -DF	3001933	1	①	
PTMC 1,5 /6-3 -DF	3001934	1	①	
PTMC 1,5 /7-3 -DF	3001935	1	①	
PTMC 1,5 /8-3 -DF	3001936	1	①	
PTMC 1,5 /1-2 -DF	3001937	1	②	
PTMC 1,5 /2-2 -DF	3001940	1	②	
PTMC 1,5 /3-2 -DF	3001942	1	②	
PTMC 1,5 /4-2 -DF	3001943	1	②	
PTMC 1,5 /5-2 -DF	3001944	1	②	
PTMC 1,5 /6-2 -DF	3001945	1	②	
PTMC 1,5 /7-2 -DF	3001946	1	②	
PTMC 1,5 /8-2 -DF	3001947	1	②	
FTMC 1,5 /1-3 -DF	3001975	1	①	
FTMC 1,5 /2-3 -DF	3001976	1	①	
FTMC 1,5 /3-3 -DF	3001977	1	①	
FTMC 1,5 /4-3 -DF	3001978	1	①	
FTMC 1,5 /5-3 -DF	3001979	1	①	
FTMC 1,5 /6-3 -DF	3001980	1	①	
FTMC 1,5 /7-3 -DF	3001981	1	①	
FTMC 1,5 /8-3 -DF	3001982	1	①	
FTMC 1,5 /1-2 -DF	3001984	1	②	
FTMC 1,5 /2-2 -DF	3001985	1	②	
FTMC 1,5 /3-2 -DF	3001986	1	②	
FTMC 1,5 /4-2 -DF	3001987	1	②	
FTMC 1,5 /5-2 -DF	3001988	1	②	
FTMC 1,5 /6-2 -DF	3001989	1	②	
FTMC 1,5 /7-2 -DF	3001990	1	②	
FTMC 1,5 /8-2 -DF	3001991	1	②	

Ordering data				
Type	Order No.	Pcs./Pkt.		
PTMC 1,5 /1-3 -NS	3001905	1	①	
PTMC 1,5 /2-3 -NS	3001906	1	①	
PTMC 1,5 /3-3 -NS	3001907	1	①	
PTMC 1,5 /4-3 -NS	3001908	1	①	
PTMC 1,5 /5-3 -NS	3001910	1	①	
PTMC 1,5 /6-3 -NS	3001911	1	①	
PTMC 1,5 /7-3 -NS	3001913	1	①	
PTMC 1,5 /8-3 -NS	3001914	1	①	
PTMC 1,5 /1-2 -NS	3001915	1	②	
PTMC 1,5 /2-2 -NS	3001916	1	②	
PTMC 1,5 /3-2 -NS	3001917	1	②	
PTMC 1,5 /4-2 -NS	3001918	1	②	
PTMC 1,5 /5-2 -NS	3001919	1	②	
PTMC 1,5 /6-2 -NS	3001920	1	②	
PTMC 1,5 /7-2 -NS	3001921	1	②	
PTMC 1,5 /8-2 -NS	3001922	1	②	
FTMC 1,5 /1-3 -NS	3001957	1	①	
FTMC 1,5 /2-3 -NS	3001958	1	①	
FTMC 1,5 /3-3 -NS	3001959	1	①	
FTMC 1,5 /4-3 -NS	3001960	1	①	
FTMC 1,5 /5-3 -NS	3001961	1	①	
FTMC 1,5 /6-3 -NS	3001962	1	①	
FTMC 1,5 /7-3 -NS	3001963	1	①	
FTMC 1,5 /8-3 -NS	3001964	1	①	
FTMC 1,5 /1-2 -NS	3001965	1	②	
FTMC 1,5 /2-2 -NS	3001966	1	②	
FTMC 1,5 /3-2 -NS	3001968	1	②	
FTMC 1,5 /4-2 -NS	3001969	1	②	
FTMC 1,5 /5-2 -NS	3001971	1	②	
FTMC 1,5 /6-2 -NS	3001972	1	②	
FTMC 1,5 /7-2 -NS	3001973	1	②	
FTMC 1,5 /8-2 -NS	3001974	1	②	

Accessories ¹⁾	
Cover flange, for direct mounting above	gray
Cover flange, for direct mounting below	gray
Adapter, for mounting on a DIN rail	gray
Marker adapter, for direct mounting above and to hold marking	gray
Marker adapter, for holding the marking, width 12.2 mm	gray
Marker adapter, for holding the marking, width 8.5 mm	gray

Accessories ¹⁾				
DF-PTMC-O	3270400	10		
DF-PTMC-U	3270401	10		
DF-PTMC-NS	3270403	10		
DF-PTMC-ZB	3270410	10		
DF-PTMC-3-ZB	3270405	10		
DF-PTMC-2-ZB	3270406	10		

Accessories ¹⁾				
DF-PTMC-O	3270400	10		
DF-PTMC-U	3270401	10		
DF-PTMC-NS	3270403	10		
DF-PTMC-ZB	3270410	10		
DF-PTMC-3-ZB	3270405	10		
DF-PTMC-2-ZB	3270406	10		

Marking	
UC-TM 10, UCT-TM 10 or ZB 10 (see Catalog 3)	

Marking				
UC-TM 10, UCT-TM 10 or ZB 10 (see Catalog 3)				

Marking				
UC-TM 10, UCT-TM 10 or ZB 10 (see Catalog 3)				

Ordering example: Configurable marshaling patchboard

Ordering example:

A marshaling patchboard should be configured as follows:

Push button, screw fixing of marshaling patchboard, three connections per individual element.
Four rows in the X direction and ten columns in the Y direction.

Please select order number **3001932** from the configurable items.
In the order designation, the 4 means -> four rows in the X direction
In the order designation, the 3 means -> three connections

- Row 1: blue
- Row 2: red
- Row 3: gray
- Row 4: yellow

Only rows of the same color are viable in the X direction.
Please state the number of columns when ordering. A minimum of 2 columns and a maximum of 20 columns can be ordered.

Please order marker adapter, DF-PTMC-ZB Order No. **3270410**, as an accessory.

Available colors:

- BU Blue
- RD Red
- GY Gray
- YE Yellow
- GN Green
- BN Brown
- WH White
- BK Black
- VT Purple
- OG Orange
- PK Pink

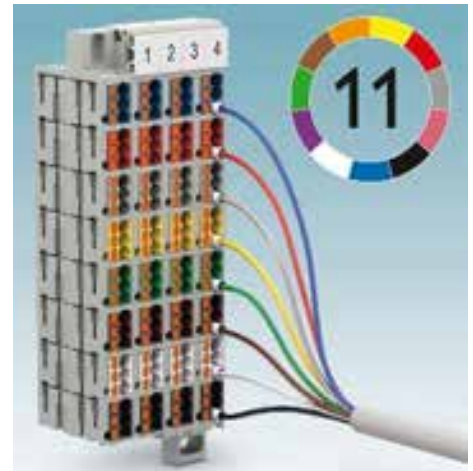

The order data for this ordering example is therefore:

Order No.	Columns	Row 1	Row 2	Row 3	Row 4
3001932	10	BU	RD	GY	YE

Fixing material for panel or DIN rail mounting will be supplied in sufficient quantities.

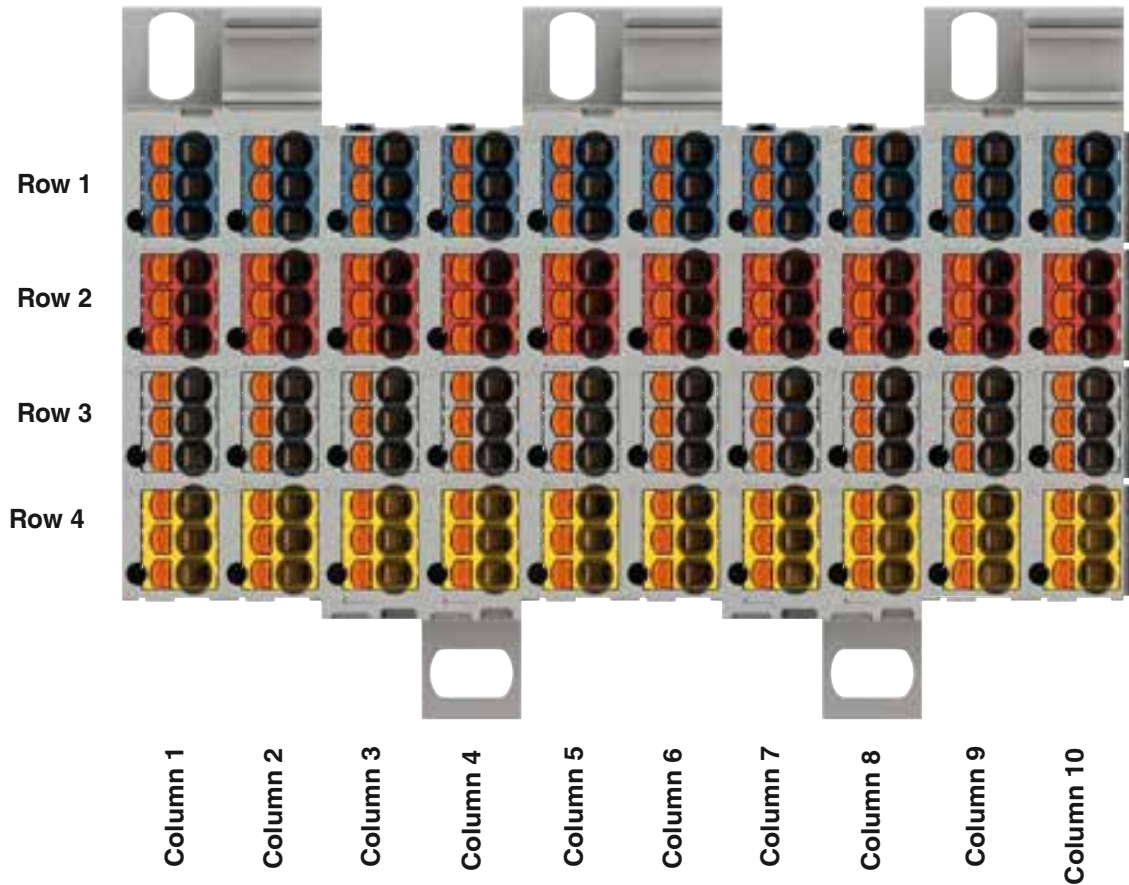

Terminal blocks – CLIPLINE complete

2.5 mm² PT Push-in connection terminal blocks

General technical data

Rated data		IEC 60947-7-1 / IEC 60947-7-2			
Rated cross section	[mm ²]	2.5			
Cross section range	AWG	26 - 12			
Connection capacity		Rigid	Flexible	Ferrule without/with plastic sleeve	
1 conductor	[mm ²]	0.14 - 4	0.14 - 2.5	0.14 - 2.5	0.14 - 2.5
2 flexible conductors with a TWIN ferrule	[mm ²]	-	-	-	0.5
Connection cross sections directly plug-in	[mm ²]	0.34 - 4	-	0.34 - 2.5	0.34 - 2.5
General data					
Stripping length	[mm]	8 - 10			
Insulating material		PA			
Flammability rating in accordance with UL 94		V0			

Note: Additional or deviating data is listed alongside the respective product.

Notes:



In addition to the product, the internal electrical wiring is provided as a circuit diagram. Free connection points for bridging are indicated by a black dot.

The specified technical data and approvals refer to the first product in each column. For information on the products below, please refer to phoenixcontact.net/products

For full details of UL and CSA use groups, file nos., and Internet links, please visit phoenixcontact.net/products

¹⁾ The bridge current is listed alongside the respective product. For additional colors, see page 402.

System accessories

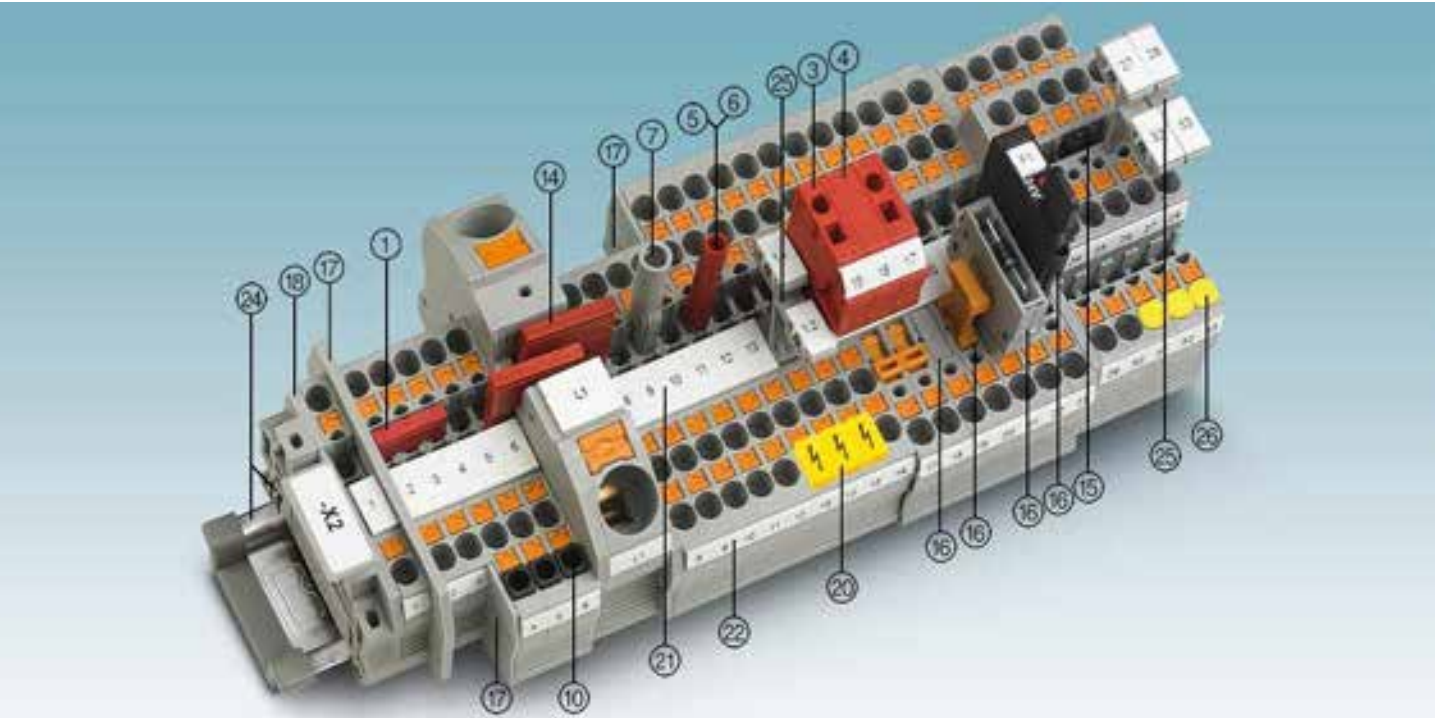

Description	No. of pos.	Color	Type	Order No.	Pcs./Pkt.	Type	Order No.	Pcs./Pkt.
① Bridge ¹⁾	2	red	FBS 2-5	3030161	50	FBSR 2-5	3033702	50
	3	red	FBS 3-5	3030174	50	FBSR 3-5	3001591	50
	4	red	FBS 4-5	3030187	50	FBSR 4-5	3001592	50
	5	red	FBS 5-5	3030190	50	FBSR 5-5	3001593	50
	10	red	FBS 10-5	3030213	10	FBSR 10-5	3033710	10
	20	red	FBS 20-5	3030226	10			
③ Modular test plug		red	PS-5	3030983	10			
④ Spacer plate		red	DP PS-5	3036725	10			
⑤ Test plug metal part		gray	MPS-MT	0201744	10			
⑥ Insulating sleeve, for MPS metal part		red	MPS-IH RD	0201676	10			
⑦ Test adapter, 4 mm socket hole		gray	PAI-4-N GY	3032871	10			
⑩ Insulating sleeve		white	ISH 2,5/0,2	3002843	50			
	0.25 - 0.5 mm ²	gray	ISH 2,5/0,5	3002856	50			
	0.75 - 1 mm ²	black	ISH 2,5/1,0	3002869	50			
Screwdriver			SZF 1-0,6X3,5	1204517	10			

⑭ Reducing bridge	For RB ..., see page 408.
⑮ Vertical potential bridge	For FBS-PV ..., see page 404.
⑯ Fuse and function plugs for disconnect terminal blocks	For P-FU ... / P-DI / P-FIX / P-CO ..., see from page 414.
⑰ Partition plates/end cover segments	For ATP-... / DS-..., visit phoenixcontact.net/products
⑱ Cover	Listed alongside the respective product.
⑲ Warning labels	For WS ..., see page 420.
⑳ Center groove labeling	UC-TM 5, UCT-TM 5 or ZB 5. See also Catalog 3, selection tables, from page 60.
㉑ Center and side groove labeling	UC-TMF 5, UCT-TMF 5 or ZBF 5. See also Catalog 3, selection tables, from page 60.
㉒ DIN rail and end bracket	See Catalog 3
㉓ Marker carrier	For STP ..., see page 418.
㉔ Cover for conductor shaft	For CEC ..., see page 421.
For full accessories, visit phoenixcontact.net/products	Note: Additional or deviating accessories are listed alongside the respective product.

2.5 mm² PT Push-in connection terminal blocks

Feed-through, multi-conductor, multi-level, and ground terminal blocks

Notes:
 1) For additional accessories and technical data, see page 70.
 For information on installation and using accessories for Ex applications, see page 678.

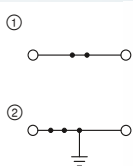

28 A, feed-through terminal block

UL, IEC, EAC, ENEC, ClassNK, CB
 Ex: IEC, EAC, ENEC
 PTB 09ATEX1111U / IECEx PTB 10.0021U

Technical data ¹⁾				
Width	Length	Height		
5.2	48.5	36.5 (NS 35/7,5)		
I _{max} [A]	U _{max} [V]	max. Ø [mm ²]	AWG (UL)	
28	800	0.14 - 4	26-12	
24 (FBS) / 17.5 (FBSR)				
IEC	UL / CUL	CSA	Ex	
800	600	600	550	
24 / 2.5	20 / -	20 / -	19 / 2.5	

Ordering data			
Type	Order No.	Pcs./Pkt.	
PT 2,5	3209510	50	
PT 2,5 BU	3209523	50	
PT 2,5-PE	3209536	50	

Accessories ¹⁾			
D-ST 2,5	3030417	50	
D-ST 2,5-0,8 OG	3030511	50	

Dimensions	[mm]
Maximum electrical data	
Maximum bridge current	[A]
Rated data	
Rated voltage	[V]
Nominal current / cross section	[A] / [mm ²]

Description	Color
Terminal block	gray blue
Ground terminal	green-yellow

Cover, width: 2.2 mm	gray
Cover, 0.8 mm width	orange

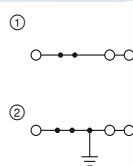

28 A, feed-through terminal block, 3 connections

UL, IEC, EAC, ENEC, ClassNK, CB
 Ex: IEC, EAC, ENEC
 PTB 09ATEX1111U / IECEx PTB 10.0021U

Technical data ¹⁾				
Width	Length	Height		
5.2	60.5	36.5 (NS 35/7,5)		
I _{max} [A]	U _{max} [V]	max. Ø [mm ²]	AWG (UL)	
28	800	0.14 - 4	26-12	
24 (FBS) / 17.5 (FBSR)				
IEC	UL / CUL	CSA	Ex	
800	600	600	550	
24 / 2.5	20 / -	20 / -	19 / 2.5	

Ordering data			
Type	Order No.	Pcs./Pkt.	
PT 2,5-TWIN	3209549	50	
PT 2,5-TWIN BU	3209552	50	
PT 2,5-TWIN-PE	3209565	50	

Accessories ¹⁾			
D-ST 2,5-TWIN	3030488	50	
D-ST 2,5-TWIN-0,8 OG	3030512	50	

Feed-through, multi-conductor, multi-level, and ground terminal blocks

Notes:
 1) For additional accessories and technical data, see page 70.
 2) The max. load current must not be exceeded by the total current of all connected conductors.
 For information on installation and using accessories for Ex applications, see page 678.

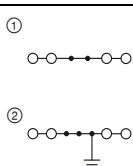

28 A, feed-through terminal block, 4 connections

UL, IEC, EAC, ENEC, ClassNK, CB
 Ex: IEC, EAC, ENEC
 PTB 09ATEX1111U / IECEx PTB 10.0021U

Technical data ¹⁾				
Width	Length	Height		
5.2	72.2	36.8 (NS 35/7,5)		
I _{max} [A]	U _{max} [V]	max. Ø [mm ²]	AWG (UL)	
28 ²⁾	800	0.14 - 4	26-12	
24 (FBS) / 17.5 (FBSR)				
IEC	UL / CUL	CSA	Ex	
800	600	600	550	
24 / 2.5	20 / -	20 / -	19 / 2.5	
Rigid	Flexible	Ferrule without/with plastic sleeve		
0.14 - 4	0.14 - 2.5	0.14 - 2.5	0.14 - 2.5	
0.34 - 4	-	0.34 - 2.5	0.34 - 2.5	

Ordering data			
Type	Order No.	Pcs./Pkt.	
PT 2,5-QUATTRO	3209578	50	
PT 2,5-QUATTRO BU	3209581	50	
PT 2,5-QUATTRO-PE	3209594	50	

Accessories ¹⁾			
D-ST 2,5-QUATTRO	3030514	50	
D-ST 2,5-QUATTRO-0,8 OG	3030513	50	

Dimensions	[mm]
Maximum electrical data	
Maximum bridge current	[A]
Rated data	
Rated voltage	[V]
Nominal current / cross section	[A] / [mm ²]
Connection capacity	
1 conductor	[mm ²]
Connection cross sections directly plug-in	[mm ²]

Description	Color
Terminal block	gray blue
Ground terminal	green-yellow

Cover, width: 2.2 mm	gray
Cover, 0.8 mm width	orange

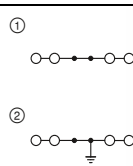

24 A, feed-through terminal block, 4 connections

UL, IEC, EAC

Technical data ¹⁾				
Width	Length	Height		
5.2	48.6	36.7 (NS 35/7,5)		
I _{max} [A]	U _{max} [V]	max. Ø [mm ²]	AWG (UL)	
24	500	0.14 - 2.5	28-12	
22 (FBS) / 17.5 (FBSR)				
IEC	UL / CUL	CSA	Ex	
500	600	600	-	
17.5 / 2.5	20 / -	20 / -	- / -	
Rigid	Flexible	Ferrule without/with plastic sleeve		
0.14 - 2.5	0.14 - 1.5	0.14 - 1.5	0.14 - 1.5	
0.34 - 2.5	-	0.34 - 1.5	0.34 - 1.5	

Ordering data			
Type	Order No.	Pcs./Pkt.	
PT 2,5/S-QUATTRO	3211019	50	
PT 2,5/S-QUATTRO BU	3211022	50	
PT 2,5/S-QUATTRO-PE	3211025	50	

Accessories ¹⁾			
D-ST 2,5	3030417	50	

Terminal blocks – CLIPLINE complete

2.5 mm² PT Push-in connection terminal blocks

Feed-through, multi-conductor, multi-level, and ground terminal blocks

Notes:
 1) For additional accessories and technical data, see page 70.
 For information on installation and using accessories for Ex applications, see page 678.

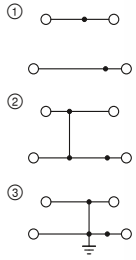

26 A, double-level terminal block, 4 connections

UL, CE, ENEC, EAC, IEC, Ex, ClassNK, CB, PTB 09ATEX1111U / IECEx PTB 10.0021U

Technical data ¹⁾				
Width	Length	Height		
5.2	68	47.5 (NS 35/7,5)		
I _{max.} [A]	U _{max.} [V]	max. Ø [mm ²]	AWG (UL)	
26	500	0.14 - 4	26-12	
22 (FBS) / 17.5 (FBSR)				
Rated data	IEC	UL / CUL	CSA	Ex
Rated voltage [V]	500	600	600	440
Nominal current / cross section [A] / [mm ²]	22 / 2.5	20 / -	20 / -	18 / 2.5

Ordering data			
Type	Order No.	Pcs./Pkt.	
PTTB 2,5	① 3210567	50	
PTTB 2,5 BU	① 3210570	50	
PTTB 2,5-PV	② 3210583	50	
PTTB 2,5-PE	③ 3210596	50	

Accessories ¹⁾		
D-PTTB 2,5	Order No.	Pcs./Pkt.
D-PTTB 2,5	3211634	50

Dimensions		[mm]
Maximum electrical data		
Maximum bridge current	[A]	
Rated data		
Rated voltage	[V]	
Nominal current / cross section	[A] / [mm ²]	

Description	Color
Terminal block	gray
With potential distribution	blue
upper level blue	gray
upper level blue	gray
Ground terminal	green-yellow

Cover, width: 2.2 mm		gray

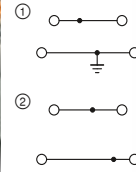

30 A, double-level terminal block with PE foot

UL, CE, ENEC, EAC, IEC, Ex, ClassNK

Technical data ¹⁾				
Width	Length	Height		
5.2	68	47.5 (NS 35/7,5)		
I _{max.} [A]	U _{max.} [V]	max. Ø [mm ²]	AWG (UL)	
30	500	0.14 - 4	26-12	
20 (FBS) / 16 (FBSR)				
Rated data	IEC	UL / CUL	CSA	Ex
Rated voltage [V]	500	600	300	-
Nominal current / cross section [A] / [mm ²]	24 / 2.5	20 / -	20 / -	- / -

Ordering data			
Type	Order No.	Pcs./Pkt.	
PTTB 2,5-PE/L	① 3210978	50	
PTTB 2,5-PE/N	① 3210981	50	
PTTB 2,5-L/N	② 3210994	50	

Accessories ¹⁾		
D-PTTB 2,5	Order No.	Pcs./Pkt.
D-PTTB 2,5	3211634	50

Feed-through, multi-conductor, multi-level, and ground terminal blocks

Notes:
 1) For additional accessories and technical data, see page 70.

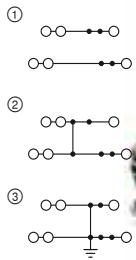

24 A, double-level terminal block, 3 connections per level

UL, CE, ENEC, EAC, IEC, Ex, ClassNK

Technical data ¹⁾				
Width	Length	Height		
5.2	111.8	55 (NS 35/7,5)		
I _{max.} [A]	U _{max.} [V]	max. Ø [mm ²]	AWG (UL)	
24	800	0.14 - 4	26-12	
20 (FBS) / 16 (FBSR)				
Rated data	IEC	UL / CUL	CSA	Ex
Rated voltage [V]	800	600	600	-
Nominal current / cross section [A] / [mm ²]	20 / 2.5	20 / -	20 / -	- / -

Ordering data			
Type	Order No.	Pcs./Pkt.	
PTTBS 2,5-TWIN	① 3210600	50	
PTTBS 2,5-TWIN BU	① 3210601	50	
PTTBS 2,5-TWIN-PV	② 3210603	50	
PTTBS 2,5-TWIN-PE	③ 3210602	50	

Accessories ¹⁾		
D-PTTBS 2,5-TWIN	Order No.	Pcs./Pkt.
D-PTTBS 2,5-TWIN	3210608	50

Dimensions		[mm]
Maximum electrical data		
Maximum bridge current	[A]	
Rated data		
Rated voltage	[V]	
Nominal current / cross section	[A] / [mm ²]	

Description	Color
Terminal block	gray
With potential distribution	blue
upper level blue	gray
Ground terminal	green-yellow

Cover, width: 2.2 mm		gray

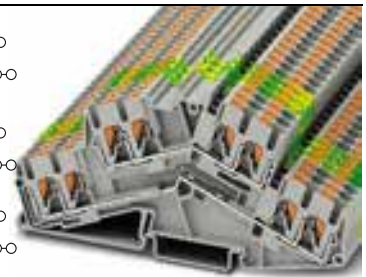
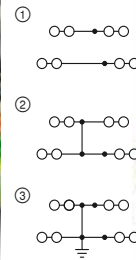

24 A, double-level terminal block, 4 connections per level

UL, CE, ENEC, EAC, IEC, Ex, ClassNK

Technical data ¹⁾				
Width	Length	Height		
5.2	115.2	55 (NS 35/7,5)		
I _{max.} [A]	U _{max.} [V]	max. Ø [mm ²]	AWG (UL)	
24	800	0.14 - 4	26-12	
20 (FBS) / 16 (FBSR)				
Rated data	IEC	UL / CUL	CSA	Ex
Rated voltage [V]	800	600	300	-
Nominal current / cross section [A] / [mm ²]	20 / 2.5	20 / -	20 / -	- / -

Ordering data			
Type	Order No.	Pcs./Pkt.	
PTTBS 2,5-QUATTRO	① 3210609	50	
PTTBS 2,5-QUATTRO BU	① 3210610	50	
PTTBS 2,5-QUATTRO-PV	② 3210612	50	
PTTBS 2,5-QUATTRO-PE	③ 3210611	50	

Accessories ¹⁾		
D-PTTBS 2,5-QUATTRO	Order No.	Pcs./Pkt.
D-PTTBS 2,5-QUATTRO	3210613	50

Feed-through, multi-conductor, multi-level, and ground terminal blocks

Notes:

¹⁾ For additional accessories and technical data, see page 70.

For information on installation and using accessories for Ex applications, see page 678.

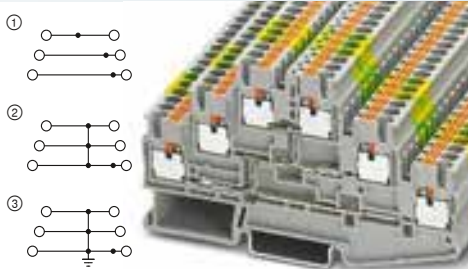

24 A, multi-level terminal block

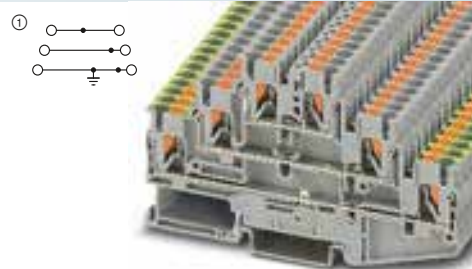

24 A, three-level terminal block with PE foot



Ex: EAC Ex IEC Ex
SEV13ATEX0159U / IECEx SEV13.0005U

Technical data¹⁾

Width	Length	Height		
5.2	102	58 (NS 35/7,5)		
I _{max} [A]	U _{max} [V]	max. Ø [mm ²]	AWG (UL)	
24	500	0.14 - 4	26-12	
20 (FBS) / 16 (FBSR)				
IEC	UL / CUL	CSA	Ex	
500	300	600	440	
Nominal current / cross section [A] / [mm ²]		20 / 2.5	20 / -	17 / 2.5

Dimensions	[mm]
Maximum electrical data	
Maximum bridge current	[A]
Rated data	
Rated voltage	[V]
Nominal current / cross section	[A] / [mm ²]

Description	Color
Terminal block	gray
With potential distribution	blue
	gray
	gray
Ground terminal	green-yellow

Cover, width: 2.2 mm	gray
----------------------	------

Ordering data

Type	Order No.	Pcs./Pkt.
PT 2,5-3L	① 3210499	50
PT 2,5-3L BU	① 3210509	50
PT 2,5-3PV	② 3210512	50
PT 2,5-3PE	③ 3210525	50

Accessories¹⁾

D-PT 2,5-3L	3211647	50
-------------	---------	----



Technical data¹⁾

Width	Length	Height		
5.2	102	58 (NS 35/7,5)		
I _{max} [A]	U _{max} [V]	max. Ø [mm ²]	AWG (UL)	
24	500	0.14 - 4	26-12	
20 (FBS) / 16 (FBSR)				
IEC	UL / CUL	CSA	Ex	
500	300	600	-	
Nominal current / cross section [A] / [mm ²]		20 / 2.5	20 / -	- / -

Ordering data

Type	Order No.	Pcs./Pkt.
PT 2,5-PE/L/L	① 3210541	50
PT 2,5-PE/L/N	① 3210538	50

Accessories¹⁾

D-PT 2,5-3L	3211647	50
-------------	---------	----

Feed-through, multi-conductor, multi-level, and ground terminal blocks

Notes:

¹⁾ For additional accessories and technical data, see page 70.

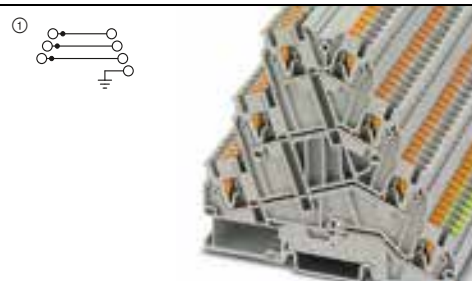

25 A, four-level terminal block with PE foot



Technical data¹⁾

Dimensions	[mm]
Maximum electrical data	
Maximum bridge current	[A]
Rated data	
Rated voltage	[V]
Nominal current / cross section	[A] / [mm ²]

Width	Length	Height		
5.2	99.5	92.6 (NS 35/7,5)		
I _{max} [A]	U _{max} [V]	max. Ø [mm ²]	AWG (UL)	
25	800	0.14 - 4	26-12	
19 (FBS) / 17.5 (FBSR)				
IEC	UL / CUL	CSA	Ex	
800	600	-	-	
Nominal current / cross section [A] / [mm ²]		20 / 2.5	20 / -	- / -

Description	Color
Terminal block	gray

Cover, width: 2.2 mm	gray
----------------------	------

Ordering data

Type	Order No.	Pcs./Pkt.
PT 2,5-PE/3L	① 3210542	50

Accessories¹⁾

D-PT 2,5-PE/3L	3210543	50
----------------	---------	----

Terminal blocks – CLIPLINE complete

2.5 mm² PT Push-in connection terminal blocks

Disconnect terminal blocks

Notes:
1) For additional accessories and technical data, see page 70.
2) Current and voltage are determined by the plug used.

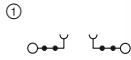

16 A, disconnect terminal block, with 4 function shafts



Technical data ¹⁾				
Dimensions	Width	Length	Height	
[mm]	5.2	70.1	36.8 (NS 35/7,5)	
Maximum electrical data	I _{max.} [A]	U _{max.} [V]	max. Ø [mm ²]	AWG (UL)
	16	400 ²⁾	0.14 - 4	26-12
Maximum bridge current	16 (FBS) / 16 (FBSR) [A]			
Rated data	IEC	UL / CUL	CSA	Ex
Rated voltage	400 ²⁾	600	600	-
Nominal current / cross section	16 / 2.5 [A] / [mm ²]	16 / -	20 / -	- / -

Ordering data			
Type	Order No.	Pcs./Pkt.	
PT 2,5-TGB	3210192	50	

Accessories ¹⁾			
Type	Order No.	Pcs./Pkt.	
D-PT 2,5-MTB	3210196	50	

Description	Color
Disconnect terminal block	gray
Cover, width: 2.2 mm	gray

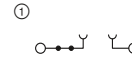

20 A, disconnect terminal block, with 2 function shafts



Technical data ¹⁾				
Dimensions	Width	Length	Height	
[mm]	5.2	62	36.5 (NS 35/7,5)	
Maximum electrical data	I _{max.} [A]	U _{max.} [V]	max. Ø [mm ²]	AWG (UL)
	20	400 ²⁾	0.14 - 4	26-12
Maximum bridge current	20 (FBS) / 17.5 (FBSR) [A]			
Rated data	IEC	UL / CUL	CSA	Ex
Rated voltage	400 ²⁾	300	300	-
Nominal current / cross section	20 / 2.5 [A] / [mm ²]	20 / -	20 / -	- / -

Ordering data			
Type	Order No.	Pcs./Pkt.	
PT 2,5-TG	3210185	50	

Accessories ¹⁾			
Type	Order No.	Pcs./Pkt.	
D-PT 2,5-MT	3211003	50	

Disconnect terminal blocks

Notes:
1) For additional accessories and technical data, see page 70.
2) Current and voltage are determined by the plug used.

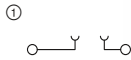

20 A, disconnect terminal block



Technical data ¹⁾				
Dimensions	Width	Length	Height	
[mm]	5.2	56	36.5 (NS 35/7,5)	
Maximum electrical data	I _{max.} [A]	U _{max.} [V]	max. Ø [mm ²]	AWG (UL)
	20	400 ²⁾	0.14 - 4	24-12
Rated data	IEC	UL / CUL	CSA	Ex
Rated voltage	400 ²⁾	300	300	-
Nominal current / cross section	20 / 2.5 [A] / [mm ²]	10 / -	10 / -	- / -

Ordering data			
Type	Order No.	Pcs./Pkt.	
PTC 2,5-TG	3270088	50	

Accessories ¹⁾			
Type	Order No.	Pcs./Pkt.	
D-PTC 2,5-MT	3270097	50	

Description	Color
Disconnect terminal block	gray
Feed-through terminal block, same shape	gray blue
Cover, width: 2.2 mm	gray

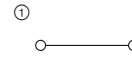

28 A, feed-through terminal block, same shape



Technical data ¹⁾				
Dimensions	Width	Length	Height	
[mm]	5.2	56	36.5 (NS 35/7,5)	
Maximum electrical data	I _{max.} [A]	U _{max.} [V]	max. Ø [mm ²]	AWG (UL)
	28	400	0.14 - 4	24-12
Rated data	IEC	UL / CUL	CSA	Ex
Rated voltage	400	300	300	-
Nominal current / cross section	24 / 2.5 [A] / [mm ²]	10 / -	10 / -	- / -

Ordering data			
Type	Order No.	Pcs./Pkt.	
PTC 2,5-MTD	3270106	50	
PTC 2,5-MTD BU	3270109	50	

Accessories ¹⁾			
Type	Order No.	Pcs./Pkt.	
D-PTC 2,5-MT	3270097	50	

Disconnect terminal blocks

Notes:
 1) For additional accessories and technical data, see page 70.
 2) Current and voltage are determined by the plug used.



16 A, disconnect terminal block, 3 connections, 4 function shafts



Technical data ¹⁾				
Dimensions	Width	Length	Height	
	5.2	81.9	36.7 (NS 35/7,5)	
Maximum electrical data	I _{max.} [A]	U _{max.} [V]	max. Ø [mm ²]	AWG (UL)
	16	400 ²⁾	0.14 - 4	26-12
Maximum bridge current	16 (FBS) / 16 (FBSR)			
Rated data	IEC	UL / CUL	CSA	Ex
Rated voltage	400 ²⁾	600	-	-
Nominal current / cross section	16 / 2.5	16 / -	- / -	- / -

Ordering data		
Type	Order No.	Pcs./Pkt.
PT 2,5-TWIN-TGB	3210193	50

Accessories ¹⁾		
D-PT 2,5-TWIN-MTB	3210202	50

Description	Color
Disconnect terminal block	gray
Cover, width: 2.2 mm	gray

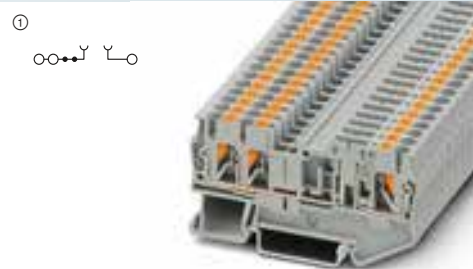

20 A, disconnect terminal block, 3 connections, 2 function shafts



Technical data ¹⁾			
Dimensions	Width	Length	Height
	5.2	74	36.5 (NS 35/7,5)
Maximum electrical data	I _{max.} [A]	U _{max.} [V]	max. Ø [mm ²]
	20	400 ²⁾	0.14 - 4
Maximum bridge current	20 (FBS) / 17.5 (FBSR)		
Rated data	IEC	UL / CUL	CSA
Rated voltage	400 ²⁾	300	300
Nominal current / cross section	20 / 2.5	20 / -	20 / -

Ordering data		
Type	Order No.	Pcs./Pkt.
PT 2,5-TWIN-TG	3210198	50

Accessories ¹⁾		
D-PT 2,5-TWIN-MT	3211317	50

Description	Color
Disconnect terminal block	gray
Cover, width: 2.2 mm	gray

Disconnect terminal blocks

Notes:
 1) For additional accessories and technical data, see page 70.
 2) Current and voltage are determined by the plug used.



20 A, disconnect terminal block, 3 connections



Technical data ¹⁾				
Dimensions	Width	Length	Height	
	5.2	67.8	36.5 (NS 35/7,5)	
Maximum electrical data	I _{max.} [A]	U _{max.} [V]	max. Ø [mm ²]	AWG (UL)
	20	400 ²⁾	0.14 - 4	24-12
Rated data	IEC	UL / CUL	CSA	Ex
Rated voltage	400 ²⁾	300	300	-
Nominal current / cross section	20 / 2.5	10 / -	10 / -	- / -

Ordering data		
Type	Order No.	Pcs./Pkt.
PTC 2,5-TWIN-TG	3270091	50

Accessories ¹⁾		
D-PTC 2,5-TWIN-MT	3270100	50

Description	Color
Disconnect terminal block	gray
Feed-through terminal block, same shape	gray
	blue
Cover, width: 2.2 mm	gray

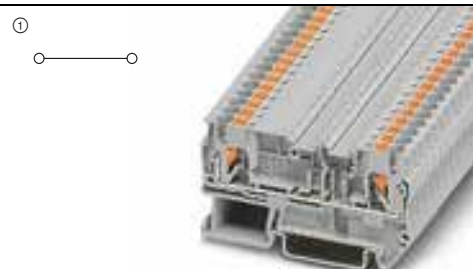

28 A, feed-through terminal block, same shape



Technical data ¹⁾			
Dimensions	Width	Length	Height
	5.2	67.8	36.5 (NS 35/7,5)
Maximum electrical data	I _{max.} [A]	U _{max.} [V]	max. Ø [mm ²]
	28	400	0.14 - 4
Rated data	IEC	UL / CUL	CSA
Rated voltage	400	300	300
Nominal current / cross section	24 / 2.5	10 / -	10 / -

Ordering data		
Type	Order No.	Pcs./Pkt.
PTC 2,5-TWIN-MTD	3270110	50
PTC 2,5-TWIN-MTD BU	3270111	50

Accessories ¹⁾		
D-PTC 2,5-TWIN-MT	3270100	50

Terminal blocks – CLIPLINE complete

2.5 mm² PT Push-in connection terminal blocks

Disconnect terminal blocks

Notes:
 1) For additional accessories and technical data, see page 70.
 2) Current and voltage are determined by the plug used.



16 A, disconnect terminal block, 4 connections, 4 function shafts



Technical data ¹⁾				
Dimensions	Width	Length	Height	
	5.2	92.2	36.7 (NS 35/7,5)	
Maximum electrical data	I _{max.} [A]	U _{max.} [V]	max. Ø [mm ²]	AWG (UL)
	16	400 ²⁾	0.14 - 4	26-12
Maximum bridge current	16 (FBS) / 16 (FBSR)			
Rated data	IEC	UL / CUL	CSA	Ex
Rated voltage	400 ²⁾	600	-	-
Nominal current / cross section	16 / 2.5	16 / -	- / -	- / -

Dimensions	
	[mm]

Description	Color
Disconnect terminal block	gray

Cover, width: 2.2 mm	gray
----------------------	------

Ordering data

Type	Order No.	Pcs./Pkt.
PT 2,5-QUATTRO-TGB	3210194	50

Accessories¹⁾

D-PT 2,5-QUATTRO-MTB	3210209	50
----------------------	---------	----



20 A, disconnect terminal block, 4 connections, 2 function shafts



Technical data ¹⁾				
Dimensions	Width	Length	Height	
	5.2	84	36.5 (NS 35/7,5)	
Maximum electrical data	I _{max.} [A]	U _{max.} [V]	max. Ø [mm ²]	AWG (UL)
	20	400 ²⁾	0.14 - 4	26-12
Maximum bridge current	20 (FBS) / 17.5 (FBSR)			
Rated data	IEC	UL / CUL	CSA	Ex
Rated voltage	400 ²⁾	300	300	-
Nominal current / cross section	20 / 2.5	20 / -	20 / -	- / -

Dimensions	
	[mm]

Description	Color
Disconnect terminal block	gray

Cover, width: 2.2 mm	gray
----------------------	------

Ordering data

Type	Order No.	Pcs./Pkt.
PT 2,5-QUATTRO-TG	3210208	50

Accessories¹⁾

D-ST 2,5-QUATTRO-MT	3038590	50
---------------------	---------	----

Disconnect terminal blocks

Notes:
 1) For additional accessories and technical data, see page 70.
 2) Current and voltage are determined by the plug used.



20 A, disconnect terminal block, 4 connections



Dimensions	
	[mm]

Description	Color
Disconnect terminal block	gray

Cover, width: 2.2 mm	gray
----------------------	------

Technical data ¹⁾				
Dimensions	Width	Length	Height	
	5.2	79.6	36.5 (NS 35/7,5)	
Maximum electrical data	I _{max.} [A]	U _{max.} [V]	max. Ø [mm ²]	AWG (UL)
	20	400 ²⁾	0.14 - 4	24-12
Maximum bridge current	20 (FBS) / 17.5 (FBSR)			
Rated data	IEC	UL / CUL	CSA	Ex
Rated voltage	400 ²⁾	300	300	-
Nominal current / cross section	20 / 2.5	10 / -	10 / -	- / -

Ordering data

Type	Order No.	Pcs./Pkt.
PTC 2,5-QUATTRO-TG	3270094	50

Accessories¹⁾

D-PTC 2,5-QUATTRO-MT	3270103	50
----------------------	---------	----

2.5 mm² PT Push-in connection terminal blocks

Disconnect terminal blocks

Notes:
1) For additional accessories and technical data, see page 70.
2) Current and voltage are determined by the plug used.

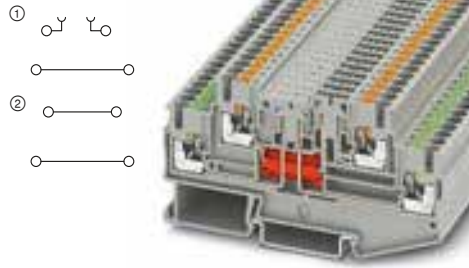

16 A, double-level terminal block, one disconnect zone



Technical data ¹⁾				
Dimensions	Width	Length	Height	
[mm]	5.2	92.4	47.4 (NS 35/7,5)	
Maximum electrical data	I _{max} [A]	U _{max} [V]	max. Ø [mm ²]	AWG (UL)
	16 ²⁾	400	0.14 - 4	26-12
Maximum bridge current	-			
[A]				
Rated data	IEC	UL / CUL	CSA	Ex
Rated voltage	400	300	300	-
Nominal current / cross section	16 ²⁾ / 2.5	16 / -	16 / -	- / -

Ordering data			
Type	Order No.	Pcs./Pkt.	
PTT 2,5-L/TG	① 3210230	50	
PTT 2,5-L/TG BU	① 3210270	50	
PTT 2,5-2L	② 3210267	50	
PTT 2,5-2L BU	② 3210268	50	

Accessories ¹⁾		
Type	Order No.	Pcs.
D-PTT 2,5-2MT-0,8	3210300	50
D-PTT 2,5-2MT-0,8 OG	3210299	50

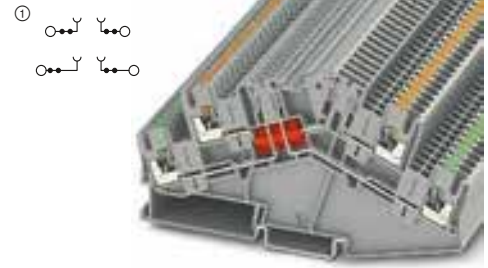

16 A, double-level terminal block, two disconnect zones



Technical data ¹⁾				
Dimensions	Width	Length	Height	
[mm]	5.2	127.5	64.3 (NS 35/7,5)	
Maximum electrical data	I _{max} [A]	U _{max} [V]	max. Ø [mm ²]	AWG (UL)
	16 ²⁾	400 ²⁾	0.14 - 4	26-12
Maximum bridge current	16 (FBS) / 16 (FBSR)			
[A]				
Rated data	IEC	UL / CUL	CSA	Ex
Rated voltage	400 ²⁾	300	300	-
Nominal current / cross section	16 ²⁾ / 2.5	16 / -	10 / -	- / -

Ordering data		
Type	Order No.	Pcs./Pkt.
PTTBS 2,5-2TGB	① 3210402	50

Accessories ¹⁾		
Type	Order No.	Pcs.
D-PTTBS 2,5-2MTB	3210404	50

Disconnect terminal blocks

Notes:
1) For additional accessories and technical data, see page 70.
2) Current and voltage are determined by the plug used.
3) 3-pos. termination block.

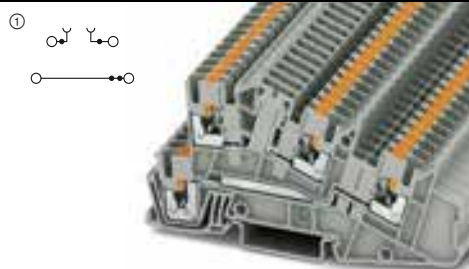

30 A, three-level terminal block, 1 x L outer conductor, 1 x disconnect zone



Technical data ¹⁾				
Dimensions	Width	Length	Height	
[mm]	5.2	101	50.5 (NS 35/7,5)	
Maximum electrical data	I _{max} [A]	U _{max} [V]	max. Ø [mm ²]	AWG (UL)
	30 ³⁾	400 ²⁾	0.14 - 4	26-12
Maximum bridge current	24 (FBS) / 17.5 (FBSR)			
[A]				
Rated data	IEC	UL / CUL	CSA	Ex
Rated voltage	400 ²⁾	300	300	-
Nominal current / cross section	24 / 4	20 / -	20 / -	- / -
Rated cross section	4			
[mm ²]				
Nominal current / cross section	16 / 1.5 (disconnect level)			
[A] / [mm ²]				
Connection capacity	Rigid	Flexible	Ferrule without/with plastic sleeve	
1 conductor	0.14 - 4	0.14 - 4	0.14 - 2.5	0.14 - 2.5

Ordering data			
Type	Order No.	Pcs./Pkt.	
PTI 2,5-L/TG	① 3213961	50	

Accessories ¹⁾		
Type	Order No.	Pcs.
D-PTI/3B	3213976	50

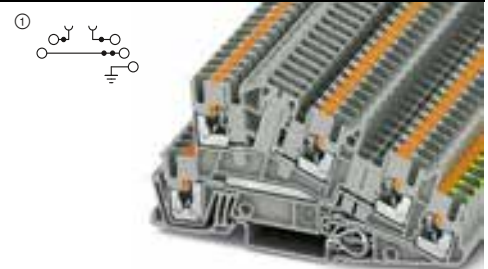

30 A, three-level terminal block, 1 x L outer conductor, 1 x PE, 1 x disconnect zone



Technical data ¹⁾				
Dimensions	Width	Length	Height	
[mm]	5.2	101	50.5 (NS 35/7,5)	
Maximum electrical data	I _{max} [A]	U _{max} [V]	max. Ø [mm ²]	AWG (UL)
	30 ³⁾	400 ²⁾	0.14 - 4	26-12
Maximum bridge current	24 (FBS) / 17.5 (FBSR)			
[A]				
Rated data	IEC	UL / CUL	CSA	Ex
Rated voltage	400 ²⁾	300	300	-
Nominal current / cross section	24 / 4	20 / -	20 / -	- / -
Rated cross section	4			
[mm ²]				
Nominal current / cross section	16 / 1.5 (disconnect level)			
[A] / [mm ²]				
Connection capacity	Rigid	Flexible	Ferrule without/with plastic sleeve	
1 conductor	0.14 - 4	0.14 - 4	0.14 - 2.5	0.14 - 2.5

Ordering data			
Type	Order No.	Pcs./Pkt.	
PTI 2,5-PE/LTG	① 3213960	50	

Accessories ¹⁾		
Type	Order No.	Pcs.
D-PTI/3B	3213976	50

Terminal blocks – CLIPLINE complete

2.5 mm² PT Push-in connection terminal blocks

Knife disconnect terminal blocks

Notes:
 1) For additional accessories and technical data, see page 70.

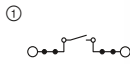

16 A, knife disconnect terminal block, 4 function shafts



Technical data ¹⁾				
Dimensions	Width	Length	Height	
[mm]	5.2	70.1	36.7 (NS 35/7,5)	
Maximum electrical data	I _{max.} [A]	U _{max.} [V]	max. Ø [mm ²]	AWG (UL)
	16	400	0.14 - 4	26-12
Maximum bridge current	16 (FBS) / 16 (FBSR) [A]			
Rated data	IEC	UL / CUL	CSA	Ex
Rated voltage	400	600	600	-
Nominal current / cross section	16 / 2.5	20 / -	20 / -	- / -

Ordering data			
Type	Order No.	Pcs./Pkt.	
PT 2,5-MTB	3210157	50	
PT 2,5-MTB BU	3210163	50	

Accessories ¹⁾			
Type	Order No.	Pcs./Pkt.	
D-PT 2,5-MTB	3210196	50	

Technical data ¹⁾				
Dimensions	Width	Length	Height	
[mm]	5.2	62	36.5 (NS 35/7,5)	
Maximum electrical data	I _{max.} [A]	U _{max.} [V]	max. Ø [mm ²]	AWG (UL)
	20	400	0.14 - 4	26-12
Maximum bridge current	20 (FBS) / 17.5 (FBSR) [A]			
Rated data	IEC	UL / CUL	CSA	Ex
Rated voltage	400	300	300	-
Nominal current / cross section	20 / 2.5	20 / -	20 / -	- / -

Ordering data	
Description	Color
Knife disconnect terminal block	gray blue
Cover, width: 2.2 mm	gray

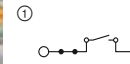

20 A, knife disconnect terminal block, 2 function shafts



Technical data ¹⁾				
Dimensions	Width	Length	Height	
[mm]	5.2	62	36.5 (NS 35/7,5)	
Maximum electrical data	I _{max.} [A]	U _{max.} [V]	max. Ø [mm ²]	AWG (UL)
	20	400	0.14 - 4	26-12
Maximum bridge current	20 (FBS) / 17.5 (FBSR) [A]			
Rated data	IEC	UL / CUL	CSA	Ex
Rated voltage	400	300	300	-
Nominal current / cross section	20 / 2.5	20 / -	20 / -	- / -

Ordering data			
Type	Order No.	Pcs./Pkt.	
PT 2,5-MT	3210156	50	
PT 2,5-MT BU	3210160	50	

Accessories ¹⁾			
Type	Order No.	Pcs./Pkt.	
D-PT 2,5-MT	3211003	50	

Knife disconnect terminal blocks

Notes:
 1) For additional accessories and technical data, see page 70.
 2) The max. load current must not be exceeded by the total current of all connected conductors.

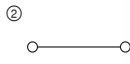
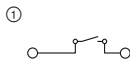

20 A, knife disconnect terminal block



Technical data ¹⁾				
Dimensions	Width	Length	Height	
[mm]	5.2	56	36.5 (NS 35/7,5)	
Maximum electrical data	I _{max.} [A]	U _{max.} [V]	max. Ø [mm ²]	AWG (UL)
	20	400	0.14 - 4	24-12
Rated data	IEC	UL / CUL	CSA	Ex
Rated voltage	400	300	300	-
Nominal current / cross section	20 / 2.5	10 / -	10 / -	- / -

Ordering data			
Type	Order No.	Pcs./Pkt.	
PTC 2,5-MT	3270079	50	
PTC 2,5-MTD	3270106	50	
PTC 2,5-MTD BU	3270109	50	

Accessories ¹⁾			
Type	Order No.	Pcs./Pkt.	
D-PTC 2,5-MT	3270097	50	

Ordering data	
Description	Color
Knife disconnect terminal block	gray
Feed-through terminal block, same shape	gray blue
Cover, width: 2.2 mm	gray

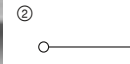
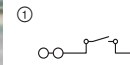

20 A, knife disconnect terminal block, 3 connections



Technical data ¹⁾				
Dimensions	Width	Length	Height	
[mm]	5.2	67.8	36.5 (NS 35/7,5)	
Maximum electrical data	I _{max.} [A]	U _{max.} [V]	max. Ø [mm ²]	AWG (UL)
	20 ²⁾	400	0.14 - 4	24-12
Rated data	IEC	UL / CUL	CSA	Ex
Rated voltage	400	300	300	-
Nominal current / cross section	20 ²⁾ / 2.5	10 / -	10 / -	- / -

Ordering data			
Type	Order No.	Pcs./Pkt.	
PTC 2,5-TWIN-MT	3270082	50	
PTC 2,5-TWIN-MTD	3270110	50	
PTC 2,5-TWIN-MTD BU	3270111	50	

Accessories ¹⁾			
Type	Order No.	Pcs./Pkt.	
D-PT 2,5-TWIN-MT	3211317	50	

Knife disconnect terminal blocks

Notes:
 1) For additional accessories and technical data, see page 70.

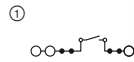

**16 A, knife disconnect terminal block,
3 connections, 4 function shafts**



Technical data ¹⁾				
Dimensions	Width	Length	Height	
	5.2	81.9	36.7 (NS 35/7,5)	
Maximum electrical data	I_{max} [A]	U_{max} [V]	max. Ø [mm ²]	AWG (UL)
	16	400	0.14 - 4	26-12
	16 (FBS) / 16 (FBSR)			
Rated data	IEC	UL / CUL	CSA	Ex
Maximum bridge current	400	600	-	-
Rated voltage	16 / 2.5	600	- / -	- / -
Nominal current / cross section	[A] / [mm ²]			

Ordering data				
Description	Color	Type	Order No.	Pcs./Pkt.
Knife disconnect terminal block	gray blue	PT 2,5-TWIN-MTB PT 2,5-TWIN-MTB BU	3210170 3210177	50 50

Accessories ¹⁾				
Cover, width: 2.2 mm	gray	D-PT 2,5-TWIN-MTB	3210202	50

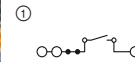

**20 A, knife disconnect terminal block,
3 connections, 2 function shafts**



Technical data ¹⁾				
Dimensions	Width	Length	Height	
	5.2	74	36.5 (NS 35/7,5)	
Maximum electrical data	I_{max} [A]	U_{max} [V]	max. Ø [mm ²]	AWG (UL)
	20	400	0.14 - 4	26-12
	20 (FBS) / 17.5 (FBSR)			
Rated data	IEC	UL / CUL	CSA	Ex
Maximum bridge current	400	300	300	-
Rated voltage	20 / 2.5	20 / -	20 / -	- / -
Nominal current / cross section	[A] / [mm ²]			

Ordering data				
Description	Color	Type	Order No.	Pcs./Pkt.
Knife disconnect terminal block	gray blue	PT 2,5-TWIN-MT PT 2,5-TWIN-MT BU	3210169 3211663	50 50

Accessories ¹⁾				
Cover, width: 2.2 mm	gray	D-PT 2,5-TWIN-MT	3211317	50

Knife disconnect terminal blocks

Notes:
 1) For additional accessories and technical data, see page 70.

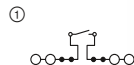

**16 A, knife disconnect terminal block,
4 connections, 4 function shafts**



Technical data ¹⁾				
Dimensions	Width	Length	Height	
	5.2	92.2	36.7 (NS 35/7,5)	
Maximum electrical data	I_{max} [A]	U_{max} [V]	max. Ø [mm ²]	AWG (UL)
	16	400	0.14 - 4	26-12
	20 (FBS) / 17.5 (FBSR)			
Rated data	IEC	UL / CUL	CSA	Ex
Maximum bridge current	400	600	-	-
Rated voltage	16 / 2.5	600	- / -	- / -
Nominal current / cross section	[A] / [mm ²]			

Ordering data				
Description	Color	Type	Order No.	Pcs./Pkt.
Knife disconnect terminal block	gray blue	PT 2,5-QUATTRO-MTB PT 2,5-QUATTRO-MTB BU	3210184 3210191	50 50

Accessories ¹⁾				
Cover, width: 2.2 mm	gray	D-PT 2,5-QUATTRO-MTB	3210209	50

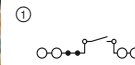

**20 A, knife disconnect terminal block,
4 connections, 2 function shafts**



Technical data ¹⁾				
Dimensions	Width	Length	Height	
	5.2	84	36.5 (NS 35/7,5)	
Maximum electrical data	I_{max} [A]	U_{max} [V]	max. Ø [mm ²]	AWG (UL)
	20	400	0.14 - 4	26-12
	20 (FBS) / 17.5 (FBSR)			
Rated data	IEC	UL / CUL	CSA	Ex
Maximum bridge current	400	300	300	-
Rated voltage	20 / 2.5	20 / -	20 / -	- / -
Nominal current / cross section	[A] / [mm ²]			

Ordering data				
Description	Color	Type	Order No.	Pcs./Pkt.
Knife disconnect terminal block	gray blue	PT 2,5-QUATTRO-MT PT 2,5-QUATTRO-MT BU	3210172 3211676	50 50

Accessories ¹⁾				
Cover, width: 2.2 mm	gray	D-ST 2,5-QUATTRO-MT	3038590	50

Terminal blocks – CLIPLINE complete

2.5 mm² PT Push-in connection terminal blocks

Knife disconnect terminal blocks

Notes:
 1) For additional accessories and technical data, see page 70.

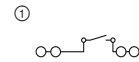

20 A, knife disconnect terminal block, 4 connections



Dimensions		[mm]
Maximum electrical data		
Rated data		
Rated voltage	[V]	400
Nominal current / cross section	[A] / [mm ²]	20 / 2.5

Description	Color
Knife disconnect terminal block	gray

Cover, width: 2.2 mm	Color
	gray

Technical data ¹⁾			
Width	Length	Height	
5.2	79.6	36.5 (NS 35/7,5)	
I _{max.} [A]	U _{max.} [V]	max. Ø [mm ²]	AWG (UL)
20	400	0.14 - 4	24-12
IEC	UL / CUL	CSA	Ex
400	300	300	-
20 / 2.5	10 / -	10 / -	- / -

Ordering data		
Type	Order No.	Pcs./Pkt.
PTC 2,5-QUATTRO-MT	3270085	50

Accessories ¹⁾		
D-PTC 2,5-QUATTRO-MT	3270103	50

Knife disconnect terminal blocks

Notes:
 1) For additional accessories and technical data, see page 70.

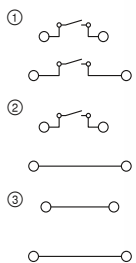

16 A, double-level terminal block with one disconnect knife per level



Dimensions		[mm]
Maximum electrical data		
Rated data		
Rated voltage	[V]	400
Nominal current / cross section	[A] / [mm ²]	16 / 2.5

Description	Color
Knife disconnect terminal block	gray
Disconnection only in the upper level	blue
	gray
	blue
Feed-through terminal block, same shape	gray
	blue

Cover, 0.8 mm width	Color
	gray
	orange

Technical data ¹⁾			
Width	Length	Height	
5.2	92.4	47.4 (NS 35/7,5)	
I _{max.} [A]	U _{max.} [V]	max. Ø [mm ²]	AWG (UL)
16	400	0.14 - 4	26-12
IEC	UL / CUL	CSA	Ex
400	300	300	-
16 / 2.5	16 / -	16 / -	- / -

Ordering data		
Type	Order No.	Pcs./Pkt.
PTT 2,5-2MT	3210258	50
PTT 2,5-2MT BU	3210265	50
PTT 2,5-L/MT	3210251	50
PTT 2,5-L/MT BU	3210257	50
PTT 2,5-2L	3210267	50
PTT 2,5-2L BU	3210268	50

Accessories ¹⁾		
D-PTT 2,5-2MT-0,8	3210300	50
D-PTT 2,5-2MT-0,8 OG	3210299	50

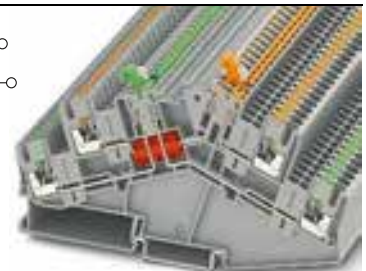

16 A, double-level terminal block with one disconnect knife per level, desk design



Technical data ¹⁾			
Width	Length	Height	
5.2	127.5	64.3 (NS 35/7,5)	
I _{max.} [A]	U _{max.} [V]	max. Ø [mm ²]	AWG (UL)
16	400	0.14 - 4	26-12
16 (FBS) / 16 (FBSR)			
IEC	UL / CUL	CSA	Ex
400	300	300	-
16 / 2.5	16 / -	10 / -	- / -

Ordering data		
Type	Order No.	Pcs./Pkt.
PTTBS 2,5-2MTB	3210400	50
PTTBS 2,5-2MTB BU	3210401	50

Accessories ¹⁾		
D-PTTBS 2,5-2MTB	3210404	50

2.5 mm² PT Push-in connection terminal blocks

Diode terminal blocks

Notes:
 1) For additional accessories and technical data, see page 70.

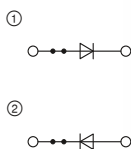

0.5 A, diode terminal block,
1N 4007 (1300 V/0.5 A)



Technical data ¹⁾				
Dimensions	Width	Length	Height	
[mm]	5.2	48.5	36.5 (NS 35/7,5)	
Maximum electrical data	I_{max} [A]	U_{max} [V]	max. Ø [mm ²]	AWG (UL)
	0.5	800	0.14 - 4	26-12
Maximum bridge current	24 (FBS) / 17.5 (FBSR)			
Rated data	IEC	UL / CUL	CSA	Ex
Rated voltage	800	300	300	-
Nominal current / cross section	0.5 / 1	20 / -	0.5 / -	- / -

Ordering data			
Type	Order No.	Pcs./Pkt.	
PT 2,5-DIO/L-R	① 3210224	50	
PT 2,5-DIO/R-L	② 3210237	50	

Accessories ¹⁾		
D-ST 2,5	3030417	50

Description	Color
Terminal block, for conducting direction see circuit diagram	gray gray
Cover, width: 2.2 mm	gray

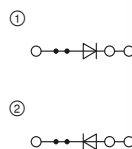

0.5 A, diode terminal block,
1N 4007 (1300 V/0.5 A), 3 connections



Technical data ¹⁾				
Dimensions	Width	Length	Height	
[mm]	5.2	60.5	36.5 (NS 35/7,5)	
Maximum electrical data	I_{max} [A]	U_{max} [V]	max. Ø [mm ²]	AWG (UL)
	0.5	800	0.14 - 4	26-12
Maximum bridge current	24 (FBS) / 17.5 (FBSR)			
Rated data	IEC	UL / CUL	CSA	Ex
Rated voltage	800	300	300	-
Nominal current / cross section	0.5 / 1	20 / -	0.5 / -	- / -

Ordering data			
Type	Order No.	Pcs./Pkt.	
PT 2,5-TWIN-DIO/L-R	① 3210240	50	
PT 2,5-TWIN-DIO/R-L	② 3210253	50	

Accessories ¹⁾		
D-ST 2,5-TWIN	3030488	50

Diode terminal blocks

Notes:
 1) For additional accessories and technical data, see page 70.

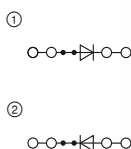

0.5 A, diode terminal block,
1N 4007 (1300 V/0.5 A), 4 connections



Technical data ¹⁾				
Dimensions	Width	Length	Height	
[mm]	5.2	72	36.5 (NS 35/7,5)	
Maximum electrical data	I_{max} [A]	U_{max} [V]	max. Ø [mm ²]	AWG (UL)
	0.5	800	0.14 - 4	26-12
Maximum bridge current	24 (FBS) / 17.5 (FBSR)			
Rated data	IEC	UL / CUL	CSA	Ex
Rated voltage	800	300	300	-
Nominal current / cross section	0.5 / 1	20 / -	0.5 / -	- / -

Ordering data			
Type	Order No.	Pcs./Pkt.	
PT 2,5-QUATTRO-DIO/L-R	① 3210266	50	
PT 2,5-QUATTRO-DIO/R-L	② 3210279	50	

Accessories ¹⁾		
D-ST 2,5-QUATTRO	3030514	50

Description	Color
Terminal block, for conducting direction see circuit diagram	gray gray gray
Cover, width: 2.2 mm	gray

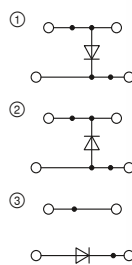

0.5 A, diode double-level terminal block,
1N 4007 (1300 V/0.5 A)



Technical data ¹⁾				
Dimensions	Width	Length	Height	
[mm]	5.2	68	47.5 (NS 35/7,5)	
Maximum electrical data	I_{max} [A]	U_{max} [V]	max. Ø [mm ²]	AWG (UL)
	0.5	500	0.14 - 4	26-12
Maximum bridge current	16 (FBS) / 16 (FBSR)			
Rated data	IEC	UL / CUL	CSA	Ex
Rated voltage	500	300	300	-
Nominal current / cross section	0.5 / 2.5	20 / -	0.5 / -	- / -

Ordering data			
Type	Order No.	Pcs./Pkt.	
PTTB 2,5-DIO/O-U	① 3210923	50	
PTTB 2,5-DIO/U-O	② 3210936	50	
PTTB 2,5-DIO/UL-UR	③ 3211427	50	

Accessories ¹⁾		
D-PTTB 2,5	3211634	50

Terminal blocks – CLIPLINE complete

2.5 mm² PT Push-in connection terminal blocks

Diode and component terminal blocks

Notes:
 1) For additional accessories and technical data, see page 70.

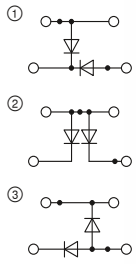

0.5 A, diode double-level terminal block, 1N 4007 (1300 V/0.5 A)



Technical data ¹⁾				
Width	Length	Height		
5.2	68	47.5 (NS 35/7,5)		
I_{max} [A]	U_{max} [V]	max. Ø [mm ²]	AWG (UL)	
0.5	500	0.14 - 4	26-12	
20 (FBS) / 17.5 (FBSR)				
IEC	UL / CUL	CSA	Ex	
500	300	300	-	
0.5 / 2.5 20 / - 0.5 / - - / -				

Ordering data			
Type	Order No.	Pcs./Pkt.	
PTTB 2,5-2DIO/O-UL/UR-UL	① 3211430	50	
PTTB 2,5-2DIO/O-UL/O-UR	② 3211443	50	
PTTB 2,5-2DIO/UR-O/UR-UL	③ 3211433	50	

Accessories ¹⁾			
D-PTTB 2,5	Order No.	Pcs./Pkt.	
D-PTTB 2,5	3211634	50	

Dimensions	
	[mm]
Maximum electrical data	
Maximum bridge current	[A]
Rated data	
Rated voltage	[V]
Nominal current / cross section	[A] / [mm ²]

Description	Color
Terminal block, for conducting direction see circuit diagram	gray
	gray
	gray
	gray
	gray

Cover, width: 2.2 mm	gray
----------------------	------

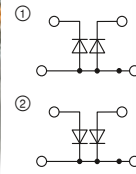

0.5 A, diode double-level terminal block, 1N 4007 (1300 V/0.5 A)



Technical data ¹⁾				
Width	Length	Height		
5.2	68	47.5 (NS 35/7,5)		
I_{max} [A]	U_{max} [V]	max. Ø [mm ²]	AWG (UL)	
0.5	500	0.14 - 4	26-12	
20 (FBS) / 17.5 (FBSR)				
IEC	UL / CUL	CSA	Ex	
500	300	-	-	
0.5 / 2.5 20 / - - / -				

Ordering data			
Type	Order No.	Pcs./Pkt.	
PTTB 2,5-2DIO/U-OL/U-OR	① 3211445	50	
PTTB 2,5-2DIO/OL-U/OR-U	② 3211447	50	

Accessories ¹⁾			
D-PTTB 2,5	Order No.	Pcs./Pkt.	
D-PTTB 2,5	3211634	50	

Double-level terminal blocks with resistor or LED display

Notes:
 1) For additional accessories and technical data, see page 70.
 2) The operating voltage is determined by the LED version.

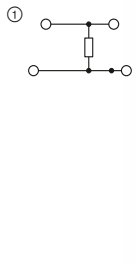

20 A, double-level terminal block with resistor



Technical data ¹⁾				
Width	Length	Height		
5.2	68	47.5 (NS 35/7,5)		
I_{max} [A]	U_{max} [V]	max. Ø [mm ²]	AWG (UL)	
20	500	0.14 - 4	-	
20 (FBS) / 17.5 (FBSR)				
IEC	UL / CUL	CSA	Ex	
500	-	-	-	
20 / 2.5 - / - - / -				

Ordering data			
Type	Order No.	Pcs./Pkt.	
PTTB 2,5-R499/O-U	① 3210925	50	

Accessories ¹⁾			
D-PTTB 2,5	Order No.	Pcs./Pkt.	
D-PTTB 2,5	3211634	50	

Dimensions	
	[mm]
Maximum electrical data	
Maximum bridge current	[A]
Rated data	
Rated voltage	[V]
Nominal current / cross section	[A] / [mm ²]

Description	Color
Terminal block, with built-in resistor, 499 ohms, 0.4 W power dissipation	gray
Terminal block, with LED for 12-30 V DC, 0.7 - 2.4 mA	gray
for 30 - 60 V DC, 0.8 - 1.8 mA	gray
for 110 - 250 V AC/DC, 0.1 - 0.5 mA	gray

Cover, width: 2.2 mm	gray
----------------------	------

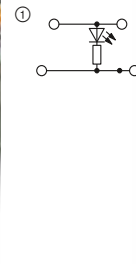

24 A, double-level terminal block with LED display



Technical data ¹⁾				
Width	Length	Height		
5.2	68	47.5 (NS 35/7,5)		
I_{max} [A]	U_{max} [V]	max. Ø [mm ²]	AWG (UL)	
24	500 ²⁾	0.14 - 4	24-12	
20 (FBS) / 17.5 (FBSR)				
IEC	UL / CUL	CSA	Ex	
500 ²⁾	300	30	-	
20 / 2.5 20 / - 20 / - - / -				

Ordering data			
Type	Order No.	Pcs./Pkt.	
PTTB 2,5-LA 24 RD	① 3211456	50	
PTTB 2,5-LA 60 RD	① 3211469	50	
PTTB 2,5-LA 230	① 3211472	50	

Accessories ¹⁾			
D-PTTB 2,5	Order No.	Pcs./Pkt.	
D-PTTB 2,5	3211634	50	

Component terminal blocks for self-soldering-in of components

Notes:

¹⁾ For additional accessories and technical data, see page 70.

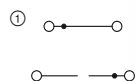

ERC

Dimensions	[mm]
Maximum electrical data	
Maximum bridge current	[A]
Rated data	
Rated voltage	[V]
Nominal current / cross section	[A] / [mm ²]

Technical data ¹⁾			
Width	Length	Height	
5.2	68	47.5 (NS 35/7,5)	
I_{max} [A]	U_{max} [V]	max. Ø [mm ²]	AWG (UL)
26	500	0.14 - 4	-
20 (FBS) / 17.5 (FBSR)			
IEC	UL / CUL	CSA	Ex
500	-	-	-
22 / 2.5	- / -	- / -	- / -

Description	Color
Terminal block , component can be soldered in	gray
Cover , width: 2.2 mm	gray

Ordering data		
Type	Order No.	Pcs./Pkt.
PTTB 2,5-2BE	3211480	50

Accessories ¹⁾		
D-PTTB 2,5	Order No.	Pcs./Pkt.
D-PTTB 2,5	3211634	50

Double-level current indicator terminal blocks

Notes:

¹⁾ For additional accessories and technical data, see page 70.

- Clearly indicates the operating status of a circuit
- Faults and line interruptions are reliably displayed as the current is monitored
- The voltage drop via the Zener diode in the blocking direction (2.4 V) powers the LED
- Compatible with DC and AC current

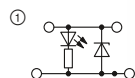

ERC

Dimensions	[mm]
Maximum electrical data	
Maximum bridge current	[A]
Rated data	
Rated voltage	[V]
Nominal current / cross section	[A] / [mm ²]

Technical data ¹⁾			
Width	Length	Height	
5.2	68	47.5 (NS 35/7,5)	
I_{max} [A]	U_{max} [V]	max. Ø [mm ²]	AWG (UL)
0.1	500	0.14 - 4	-
20 (FBS) / 17.5 (FBSR)			
IEC	UL / CUL	CSA	Ex
500	-	-	-
0.1 / 2.5	- / -	- / -	- / -

Description	Color
Terminal block	gray
Cover , width: 2.2 mm	gray

Ordering data		
Type	Order No.	Pcs./Pkt.
PTTB 2,5-ILA 100	3215042	50

Accessories ¹⁾		
D-PTTB 2,5	Order No.	Pcs./Pkt.
D-PTTB 2,5	3211634	50

Terminal blocks – CLIPLINE complete

2.5 mm² PT Push-in connection terminal blocks

Hybrid terminal blocks with screw connection on one side, 2.5 (4) mm²

- Notes:**
 1) For additional accessories and technical data, see page 70.
 2) For screw connection rated data, see page 148.

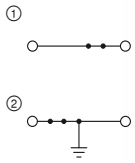

24 A, feed-through terminal block



Technical data ¹⁾				
Width	Length	Height		
5.2	53.5	42.8 (NS 35/7,5)		
I _{max.} [A]	U _{max.} [V]	max. Ø [mm ²]	AWG (UL)	
24	800	0.14 - 4	26-12	
24 (FBS) / 17.5 (FBSR)				
IEC	UL / CUL	CSA	Ex	
800	600	600	-	
24 / 2.5				
	20 / -	20 / -	- / -	

Ordering data			
Type	Order No.	Pcs./Pkt.	
PTU 2,5	① 3209519	50	
PTU 2,5 BU	① 3209520	50	
PTU 2,5-PE	② 3209521	50	

Accessories ¹⁾			
D-PTU 2,5	Order No.	Pcs./Pkt.	
D-PTU 2,5	3209522	50	

Dimensions	[mm]
Maximum electrical data	
Maximum bridge current	[A]
Rated data²⁾	
Rated voltage	[V]
Nominal current / cross section	[A] / [mm ²]

Description	Color
Terminal block	gray
	blue
Ground terminal	green-yellow

Cover, width: 2.2 mm	gray
-----------------------------	------

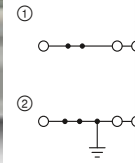

24 A, feed-through terminal block, 3 connections



Technical data ¹⁾				
Width	Length	Height		
5.2	65.3	42.8 (NS 35/7,5)		
I _{max.} [A]	U _{max.} [V]	max. Ø [mm ²]	AWG (UL)	
24	800	0.14 - 4	-	
24 (FBS) / 17.5 (FBSR)				
IEC	UL / CUL	CSA	Ex	
800	-	600	-	
24 / 2.5				
	- / -	20 / -	- / -	

Ordering data			
Type	Order No.	Pcs./Pkt.	
PTU 2,5-TWIN	① 3209515	50	
PTU 2,5-TWIN BU	① 3209516	50	
PTU 2,5-TWIN-PE	② 3209517	50	

Accessories ¹⁾			
D-STU 2,5-TWIN	Order No.	Pcs./Pkt.	
D-STU 2,5-TWIN	3033045	50	

Feed-through, multi-conductor, multi-level, and ground terminal blocks in desk design

- Notes:**
 1) For additional accessories and technical data, see page 70.
 For information on installation and using accessories for Ex applications, see page 678.

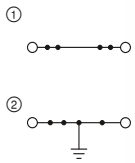

30 A, feed-through terminal block



Ex: IEC, IECEx
 SEV13ATEX0159U / IECEx SEV13.0005U

Technical data ¹⁾				
Width	Length	Height		
5.2	49	43 (NS 35/7,5)		
I _{max.} [A]	U _{max.} [V]	max. Ø [mm ²]	AWG (UL)	
30	800	0.14 - 4	26-12	
24 (FBS) / 17.5 (FBSR)				
IEC	UL / CUL	CSA	Ex	
800	600	600	550	
24 / 2.5				
	20 / -	20 / -	21 / 2.5	

Ordering data			
Type	Order No.	Pcs./Pkt.	
PTS 2,5	① 3211799	50	
PTS 2,5 BU	① 3211812	50	
PTS 2,5-PE	② 3211867	50	

Accessories ¹⁾			
D-STs 2,5	Order No.	Pcs./Pkt.	
D-STs 2,5	3031762	50	

Dimensions	[mm]
Maximum electrical data	
Maximum bridge current	[A]
Rated data	
Rated voltage	[V]
Nominal current / cross section	[A] / [mm ²]

Description	Color
Terminal block	gray
	blue
Ground terminal	green-yellow

Cover, width: 2.2 mm	gray
-----------------------------	------



28 A, feed-through terminal block, 3 connections



Ex: IEC, IECEx
 SEV13ATEX0159U / IECEx SEV13.0005U

Technical data ¹⁾				
Width	Length	Height		
5.2	49	43 (NS 35/7,5)		
I _{max.} [A]	U _{max.} [V]	max. Ø [mm ²]	AWG (UL)	
28	800	0.14 - 4	26-12	
24 (FBS) / 17.5 (FBSR)				
IEC	UL / CUL	CSA	Ex	
800	600	600	550	
24 / 2.5				
	20 / -	20 / -	21 / 2.5	

Ordering data			
Type	Order No.	Pcs./Pkt.	
PTS 2,5-TWIN	① 3211896	50	
PTS 2,5-TWIN BU	① 3211906	50	
PTS 2,5-TWIN-PE	② 3211935	50	

Accessories ¹⁾			
D-STs 2,5	Order No.	Pcs./Pkt.	
D-STs 2,5	3031762	50	

2.5 mm² PT Push-in connection terminal blocks

Feed-through, multi-conductor, multi-level, and ground terminal blocks in desk design

Notes:
 1) For additional accessories and technical data, see page 70.
 For information on installation and using accessories for Ex applications, see page 678.

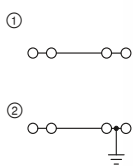

28 A, feed-through terminal block, 4 connections

UL, IEC, ENEC, EAC, CE, ClassNK, CB
 Ex: IEC, Ex
 SEV13ATEX0159U / IECEx SEV13.0005U

Technical data ¹⁾				
Width	Length	Height		
5.2	49	43 (NS 35/7,5)		
I _{max} [A]	U _{max} [V]	max. Ø [mm ²]	AWG (UL)	
28	800	0.14 - 4	26-12	
20 (FBS) / 17.5 (FBSR)				
Rated data				
Rated voltage [V]	IEC	UL / CUL	CSA	Ex
800	600	600	600	550
Nominal current / cross section [A] / [mm ²]	24 / 2.5	20 / -	20 / -	21 / 2.5

Ordering data			
Type	Order No.	Pcs./Pkt.	
PTS 2,5-QUATTRO	① 3211993	50	
PTS 2,5-QUATTRO BU	① 3212002	50	
PTS 2,5-QUATTRO-PE	② 3212011	50	

Accessories ¹⁾		
D-STs 2,5	Order No.	Pcs./Pkt.
D-STs 2,5	3031762	50

Dimensions	
Width	[mm]
5.2	
Maximum electrical data	
Maximum bridge current [A]	-
Rated data	
Rated voltage [V]	800
Nominal current / cross section [A] / [mm ²]	24 / 2.5

Description	Color
Terminal block	gray
With potential distribution	gray
Ground terminal	green-yellow

Cover, width: 2.2 mm gray

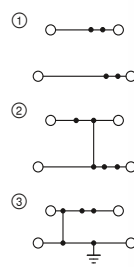

24 A, double-level terminal block

UL, IEC, ENEC, EAC, CE, ClassNK, CB
 Ex: IEC, Ex
 SEV13ATEX0159U / IECEx SEV13.0005U

Technical data ¹⁾				
Width	Length	Height		
5.2	78	55 (NS 35/7,5)		
I _{max} [A]	U _{max} [V]	max. Ø [mm ²]	AWG (UL)	
24	500	0.14 - 4	24-12	
20 (FBS) / 17.5 (FBSR)				
Rated data				
Rated voltage [V]	IEC	UL / CUL	CSA	Ex
500	600	600	600	440
Nominal current / cross section [A] / [mm ²]	22 / 2.5	20 / -	20 / -	19 / 2.5

Ordering data			
Type	Order No.	Pcs./Pkt.	
PTTBS 2,5	① 3209604	50	
PTTBS 2,5 BU	① 3209617	50	
PTTBS 2,5-PV	② 3210211	50	
PTTBS 2,5-PE	③ 3209620	50	

Accessories ¹⁾		
D-STTBS 2,5	Order No.	Pcs./Pkt.
D-STTBS 2,5	3038503	50

Feed-through, multi-conductor, multi-level, and ground terminal blocks in desk design

Notes:
 1) For additional accessories and technical data, see page 70.

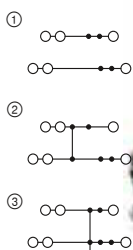

24 A, double-level terminal block, 3 connections per level

UL, IEC, ENEC, EAC, CE, ClassNK, CB

Technical data ¹⁾				
Width	Length	Height		
5.2	111.8	55 (NS 35/7,5)		
I _{max} [A]	U _{max} [V]	max. Ø [mm ²]	AWG (UL)	
24	800	0.14 - 4	26-12	
20 (FBS) / 16 (FBSR)				
Rated data				
Rated voltage [V]	IEC	UL / CUL	CSA	Ex
800	600	600	600	-
Nominal current / cross section [A] / [mm ²]	20 / 2.5	20 / -	20 / -	- / -

Ordering data			
Type	Order No.	Pcs./Pkt.	
PTTBS 2,5-TWIN	① 3210600	50	
PTTBS 2,5-TWIN BU	① 3210601	50	
PTTBS 2,5-TWIN-PV	② 3210603	50	
PTTBS 2,5-TWIN-PE	③ 3210602	50	

Accessories ¹⁾		
D-PTTBS 2,5-TWIN	Order No.	Pcs./Pkt.
D-PTTBS 2,5-TWIN	3210608	50

Dimensions	
Width	[mm]
5.2	
Maximum electrical data	
Maximum bridge current [A]	24
Rated data	
Rated voltage [V]	800
Nominal current / cross section [A] / [mm ²]	20 / 2.5

Description	Color
Terminal block	gray
With potential distribution	gray
Ground terminal	green-yellow

Cover, width: 2.2 mm gray

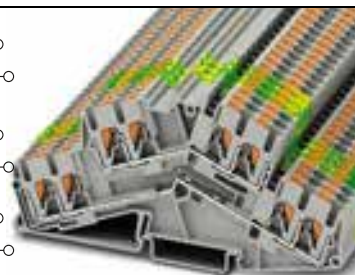
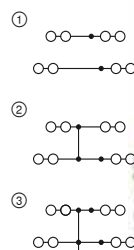

24 A, double-level terminal block, 4 connections per level

UL, IEC, ENEC, EAC, CE, ClassNK, CB

Technical data ¹⁾				
Width	Length	Height		
5.2	115.2	55 (NS 35/7,5)		
I _{max} [A]	U _{max} [V]	max. Ø [mm ²]	AWG (UL)	
24	800	0.14 - 4	26-12	
20 (FBS) / 16 (FBSR)				
Rated data				
Rated voltage [V]	IEC	UL / CUL	CSA	Ex
800	600	600	300	-
Nominal current / cross section [A] / [mm ²]	20 / 2.5	20 / -	20 / -	- / -

Ordering data			
Type	Order No.	Pcs./Pkt.	
PTTBS 2,5-QUATTRO	① 3210609	50	
PTTBS 2,5-QUATTRO BU	① 3210610	50	
PTTBS 2,5-QUATTRO-PV	② 3210612	50	
PTTBS 2,5-QUATTRO-PE	③ 3210611	50	

Accessories ¹⁾		
D-PTTBS 2,5-QUATTRO	Order No.	Pcs./Pkt.
D-PTTBS 2,5-QUATTRO	3210613	50

Terminal blocks – CLIPLINE complete

2.5 mm² PT Push-in connection terminal blocks

Desk-design disconnect and knife disconnect terminal blocks

Notes:

- 1) For additional accessories and technical data, see page 70.
- 2) Current and voltage are determined by the plug used.

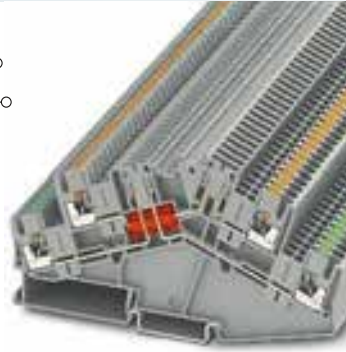
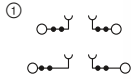

16 A, double-level terminal block, two disconnect zones

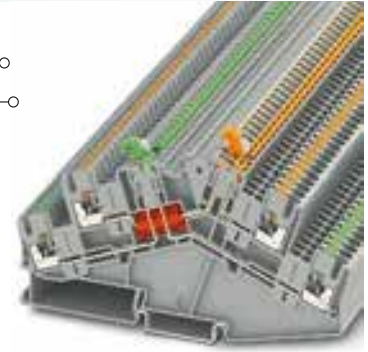
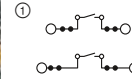

16 A, double-level terminal block with one disconnect knife per level, desk design



		Technical data ¹⁾			
Dimensions		Width	Length	Height	
	[mm]	5.2	127.5	64.3 (NS 35/7,5)	
Maximum electrical data		I_{max} [A]	U_{max} [V]	max. Ø [mm ²]	AWG (UL)
		16 ²⁾	400 ²⁾	0.14 - 4	26-12
Maximum bridge current		16 (FBS) / 16 (FBSR)			
Rated data		IEC	UL / CUL	CSA	Ex
Rated voltage		400 ²⁾	300	300	-
Nominal current / cross section		16 ²⁾ / 2.5	16 / -	10 / -	- / -

		Technical data ¹⁾			
Dimensions		Width	Length	Height	
	[mm]	5.2	127.5	64.3 (NS 35/7,5)	
Maximum electrical data		I_{max} [A]	U_{max} [V]	max. Ø [mm ²]	AWG (UL)
		16	400	0.14 - 4	26-12
Maximum bridge current		16 (FBS) / 16 (FBSR)			
Rated data		IEC	UL / CUL	CSA	Ex
Rated voltage		400	300	300	-
Nominal current / cross section		16 / 2.5	16 / -	10 / -	- / -

		Ordering data		
Description	Color	Type	Order No.	Pcs./Pkt.
Disconnect terminal block	gray blue	PTTBS 2,5-2TGB	3210402	50

		Ordering data		
Description	Color	Type	Order No.	Pcs./Pkt.
Disconnect terminal block	gray blue	PTTBS 2,5-2MTB	3210400	50
		PTTBS 2,5-2MTB BU	3210401	50

		Accessories ¹⁾		
Cover, 0.8 mm width	gray	D-PTTBS 2,5-2MTB	3210404	50

		Accessories ¹⁾		
Cover, 0.8 mm width	gray	D-PTTBS 2,5-2MTB	3210404	50

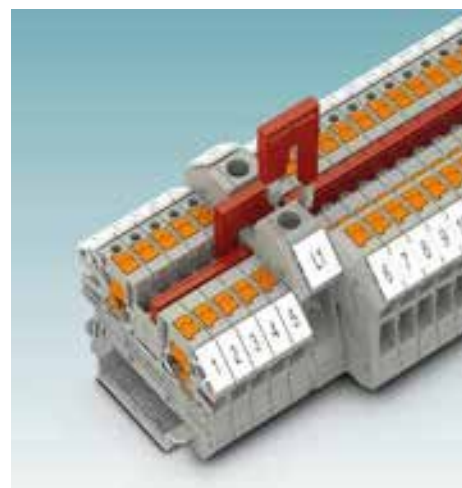
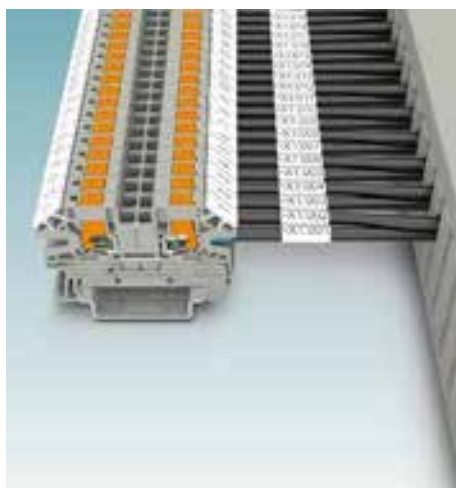
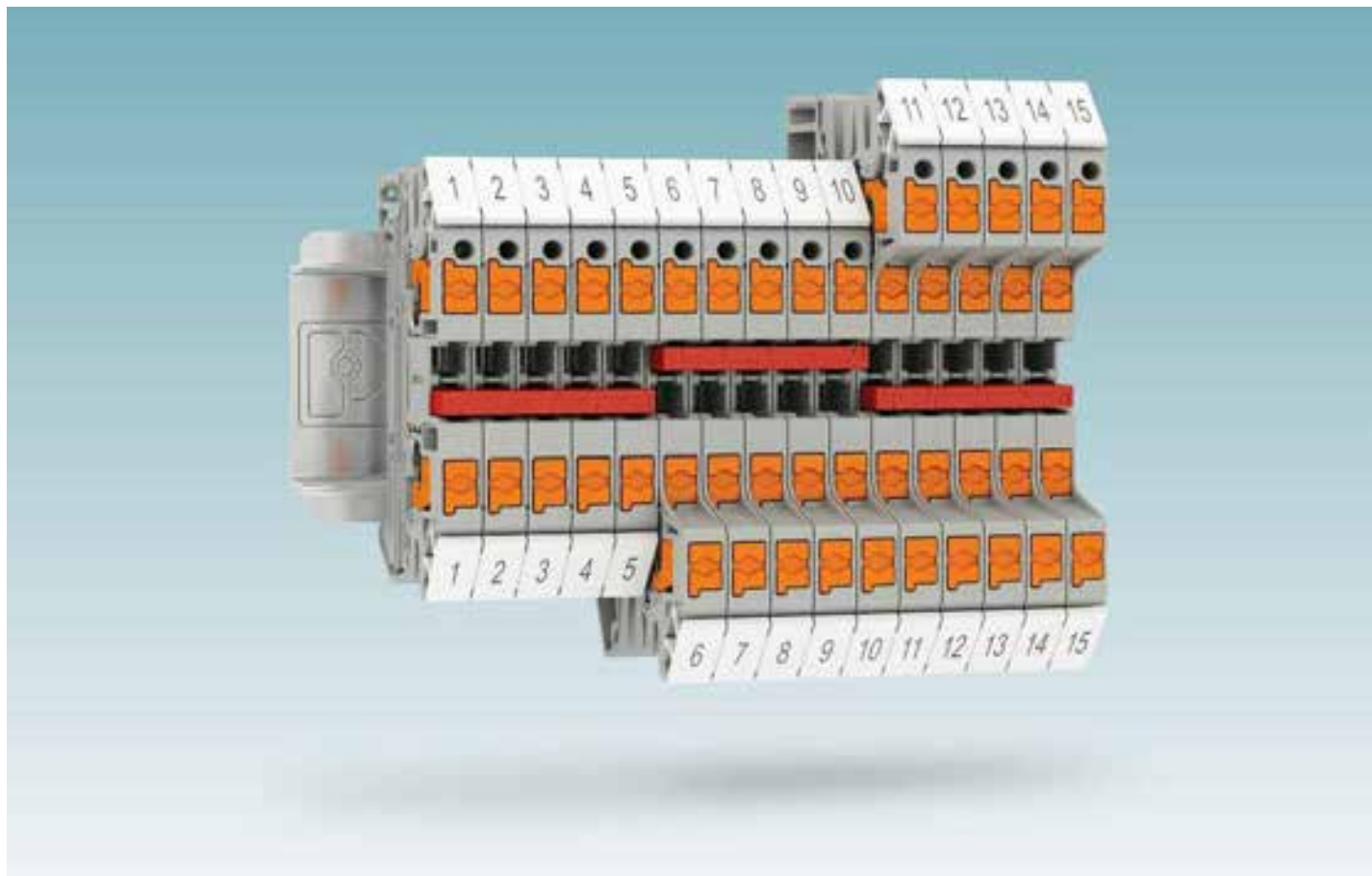

The PTV series features a combination of the Push-in connection with the vertical wiring direction of the screw terminal block. This combination ensures an easier, more direct, and self-explanatory connection.

The wiring direction of the PTV terminal blocks enables clear wiring without bend radii. This ensures that the connection markings are clear to see. Furthermore, no additional space is required above the terminal blocks which is an advantage in flat control boxes.

As with the PT 2,5, the PTV terminal blocks use accessories from the CLIPLINE complete system. Therefore, the standard bridges FBS ... and reducing bridge RB ... can be used for potential distribution.

Terminal blocks – CLIPLINE complete

2.5 mm² PT Push-in connection terminal blocks

Feed-through, multi-conductor, and ground terminal blocks

Notes:
 1) For additional accessories and technical data, see page 70.

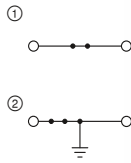

28 A, feed-through terminal block



28 A, feed-through terminal block, 3 connections

		Technical data ¹⁾			
Dimensions		Width	Length	Height	
	[mm]	5.2	50.8	36.5 (NS 35/7,5)	
Maximum electrical data		I_{max} [A]	U_{max} [V]	max. \varnothing [mm ²]	AWG (UL)
		28	800	0.14 - 4	-
Rated data		IEC	UL / CUL	CSA	Ex
Rated voltage	[V]	800	-	-	-
Nominal current / cross section	[A] / [mm ²]	24 / 2.5	- / -	- / -	- / -
		Ordering data			
Description	Color	Type	Order No.	Pcs./Pkt.	
Terminal block	gray	PTV 2,5	① 1078960	50	
	blue	PTV 2,5 BU	① 1078962	50	
Ground terminal	green-yellow	PTV 2,5-PE	② 1078963	50	
		Accessories ¹⁾			
Cover, width: 2.2 mm	gray	D-PTV 2,5	1079914	50	

		Technical data ¹⁾			
Dimensions		Width	Length	Height	
	[mm]	5.2	60	46.9 (NS 35/7,5)	
Maximum electrical data		I_{max} [A]	U_{max} [V]	max. \varnothing [mm ²]	AWG (UL)
		28	800	0.14 - 4	-
Rated data		IEC	UL / CUL	CSA	Ex
Rated voltage	[V]	800	-	-	-
Nominal current / cross section	[A] / [mm ²]	24 / 2.5	- / -	- / -	- / -
		Ordering data			
Description	Color	Type	Order No.	Pcs./Pkt.	
Terminal block	gray	PTV 2,5-TWIN	① 1078966	50	
	blue	PTV 2,5-TWIN BU	① 1078971	50	
Ground terminal	green-yellow	PTV 2,5-TWIN-PE	② 1078991	50	
		Accessories ¹⁾			
Cover, width: 2.2 mm	gray	D-PTV 2,5-TWIN	1079916	50	

Feed-through, multi-conductor, and ground terminal blocks

Notes:
 1) For additional accessories and technical data, see page 70.
 2) The max. load current must not be exceeded by the total current of all connected conductors.

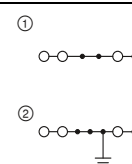

28 A, feed-through terminal block, 4 connections

		Technical data ¹⁾			
Dimensions		Width	Length	Height	
	[mm]	5.2	69.2	46.9 (NS 35/7,5)	
Maximum electrical data		I_{max} [A]	U_{max} [V]	max. \varnothing [mm ²]	AWG (UL)
		28 ²⁾	800	0.14 - 4	-
Rated data		IEC	UL / CUL	CSA	Ex
Rated voltage	[V]	800	-	-	-
Nominal current / cross section	[A] / [mm ²]	24 / 2.5	- / -	- / -	- / -
		Ordering data			
Description	Color	Type	Order No.	Pcs./Pkt.	
Terminal block	gray	PTV 2,5-QUATTRO	① 1078999	50	
	blue	PTV 2,5-QUATTRO BU	① 1079006	50	
Ground terminal	green-yellow	PTV 2,5-QUATTRO-PE	② 1079012	50	
		Accessories ¹⁾			
Cover, width: 2.2 mm	gray	D-PTV 2,5-QUATTRO	1079917	50	

		Technical data ¹⁾			
Dimensions		Width	Length	Height	
	[mm]	5.2	69.2	46.9 (NS 35/7,5)	
Maximum electrical data		I_{max} [A]	U_{max} [V]	max. \varnothing [mm ²]	AWG (UL)
		28 ²⁾	800	0.14 - 4	-
Rated data		IEC	UL / CUL	CSA	Ex
Rated voltage	[V]	800	-	-	-
Nominal current / cross section	[A] / [mm ²]	24 / 2.5	- / -	- / -	- / -
		Ordering data			
Description	Color	Type	Order No.	Pcs./Pkt.	
Terminal block	gray	PTV 2,5-QUATTRO	① 1078999	50	
	blue	PTV 2,5-QUATTRO BU	① 1079006	50	
Ground terminal	green-yellow	PTV 2,5-QUATTRO-PE	② 1079012	50	
		Accessories ¹⁾			
Cover, width: 2.2 mm	gray	D-PTV 2,5-QUATTRO	1079917	50	

Disconnect terminal blocks and knife disconnect terminal blocks

Notes:
¹⁾ For additional accessories and technical data, see page 70.
²⁾ Current and voltage are determined by the plug used.

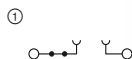

20 A, disconnect terminal block

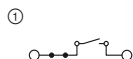

20 A, knife disconnect terminal block

		Technical data ¹⁾				Technical data ¹⁾				
Dimensions		Width	Length	Height		Width	Length	Height		
	[mm]	5.2	62	36.5 (NS 35/7,5)		5.2	62	36.5 (NS 35/7,5)		
Maximum electrical data		I_{max} [A]	U_{max} [V]	max. Ø [mm ²]	AWG (UL)	I_{max} [A]	U_{max} [V]	max. Ø [mm ²]	AWG (UL)	
		20	400 ²⁾	0.14 - 4	-	20	400	0.14 - 4	-	
Rated data		IEC	UL / CUL	CSA	Ex	IEC	UL / CUL	CSA	Ex	
Rated voltage	[V]	400 ²⁾	-	-	-	400	-	-	-	
Nominal current / cross section	[A] / [mm ²]	20 / 2.5	- / -	- / -	- / -	20 / 2.5	- / -	- / -	- / -	
		Ordering data			Ordering data			Ordering data		
Description	Color	Type	Order No.	Pcs./Pkt.	Type	Order No.	Pcs./Pkt.	Type	Order No.	Pcs./Pkt.
Disconnect terminal block	gray	PTVC 2,5-TG	1079061	50	PTVC 2,5-MT	1079059	50	PTVC 2,5-MT BU	1079060	50
Knife disconnect terminal block	gray blue									
		Accessories ¹⁾			Accessories ¹⁾			Accessories ¹⁾		
Cover, width: 2.2 mm	gray	D-PTV 2,5	1079914	50	D-PTV 2,5	1079914	50	D-PTV 2,5	1079914	50

Terminal blocks – CLIPLINE complete

2.5 mm² PT Push-in connection terminal blocks

Installation terminal blocks

Notes:

1) For additional accessories and technical data, see page 70.

Assembly instruction:

In order to securely fix the neutral busbar in place, support brackets must be placed at the beginning and end of each terminal strip as well as every 20 cm on longer terminal strips. The corresponding support brackets can be found at phoenixcontact.net/products

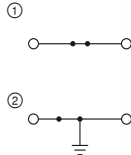

24 A, feed-through terminal block

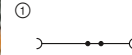

24 A, neutral disconnect terminal block



Dimensions	Technical data ¹⁾			
	Width	Length	Height	
	5.2	59.5	44 (NS 35/7,5)	
Maximum electrical data	I_{max} [A]	U_{max} [V]	max. Ø [mm ²]	AWG (UL)
	24	800	0.14 - 4	26-12
Rated data	24 (FBS) / 17.5 (FBSR)			
Maximum bridge current [A]	IEC	UL / CUL	CSA	Ex
Rated voltage [V]	800	600	600	-
Nominal current / cross section [A] / [mm ²]	24 / 4	20 / -	20 / -	- / -
Rated cross section [mm ²]	4			
Connection capacity	Rigid	Flexible	Ferrule without/with plastic sleeve	
1 conductor [mm ²]	0.14 - 4	0.14 - 4	0.14 - 2.5	0.14 - 2.5
2 conductors (of the same type) [mm ²]	-	-	-	-

Dimensions	Technical data ¹⁾			
	Width	Length	Height	
	5.2	59	46.3 (NS 35/7,5)	
Maximum electrical data	I_{max} [A]	U_{max} [V]	max. Ø [mm ²]	AWG (UL)
	24	250	0.14 - 4	26-12
Rated data	24 (FBS) / 17.5 (FBSR)			
Maximum bridge current [A]	IEC	UL / CUL	CSA	Ex
Rated voltage [V]	250	600	-	-
Nominal current / cross section [A] / [mm ²]	24 / 2.5	20 / -	- / -	- / -
Rated cross section [mm ²]	4			
Connection capacity	Rigid	Flexible	Ferrule without/with plastic sleeve	
1 conductor [mm ²]	0.14 - 4	0.14 - 4	0.14 - 2.5	0.14 - 2.5
2 conductors (of the same type) [mm ²]	0.2 - 1.5	-	-	-

Description	Color	Ordering data		
		Type	Order No.	Pcs./Pkt.
Terminal block	gray	PTI 2,5	3213968	50
	blue	PTI 2,5 BU	3213969	50
Ground terminal	green-yellow	PTI 2,5-PE	3213962	50
Neutral disconnect terminal block	blue			

Description	Color	Ordering data		
		Type	Order No.	Pcs./Pkt.
Terminal block	gray	PTN 2,5	3213963	50
Ground terminal	green-yellow			
Neutral disconnect terminal block	blue			

Accessories ¹⁾				
Cover, width: 2.2 mm	gray	D-PTI 2,5	1016672	50
Support bracket, to hold the neutral busbar, set every 20 cm, 2 mm wide	blue	AB-PTI	3214006	50

Accessories ¹⁾				
Cover, width: 2.2 mm	gray	D-PTN 2,5	3213977	50
Support bracket, to hold the neutral busbar, set every 20 cm, 2 mm wide	blue	AB-PTI	3214006	50

Installation terminal blocks

Notes:

1) For additional accessories and technical data, see page 70.

2) 3-pos. termination block.

Assembly instruction:
In order to securely fix the neutral busbar in place, support brackets must be placed at the beginning and end of each terminal strip as well as every 20 cm on longer terminal strips. The corresponding support brackets can be found at phoenixcontact.net/products

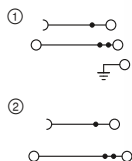
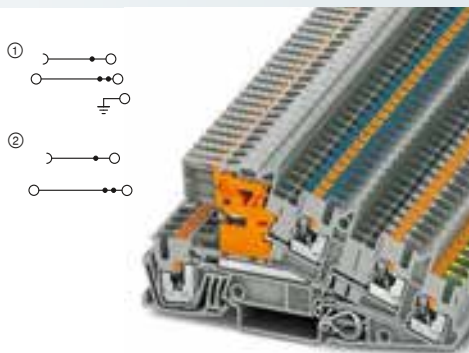

**30 A, three-level terminal block,
1 x L outer conductor, 1 x N conductor
can be disconnected, 1 x PE**

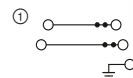
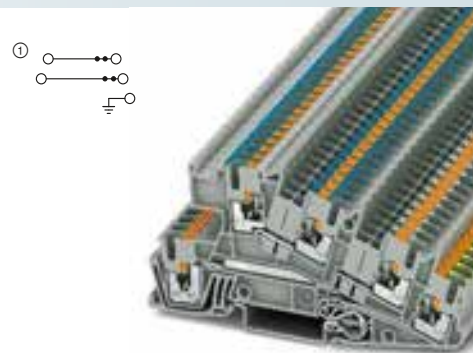

**30 A, three-level terminal block,
1 x L outer conductor, 1 x N conductor,
1 x PE**



Technical data ¹⁾				
Width	Length	Height		
5.2	101	50.5 (NS 35/7,5)		
I _{max.} [A]	U _{max.} [V]	max. Ø [mm ²]	AWG (UL)	
30 ²⁾	400	0.14 - 4	26-12	
24 (FBS) / 17.5 (FBSR)				
Rated data	IEC	UL / CUL	CSA	Ex
Rated voltage	400	300	300	-
Nominal current / cross section	24 / 4	20 / -	20 / -	- / -
Rated cross section	4	4		
Connection capacity	Rigid	Flexible	Ferrule without/with plastic sleeve	
1 conductor	0.14 - 4	0.14 - 4	0.14 - 2.5	0.14 - 2.5

Ordering data			
Description	Type	Order No.	Pcs./Pkt.
Terminal block, upper level blue	PTI 2,5-PE/L/NT	① 3213946	50
upper level gray	PTI 2,5-L/NT	② 3213947	50
	PTI 2,5-L/LT	② 3213948	50

Accessories ¹⁾		
Description	Type	Order No.
Cover, width: 2.2 mm	D-PTI/3	3213975
Support bracket, to hold the neutral busbar, set every 20 cm, 2 mm wide	AB-PTI/3	3213974

Technical data ¹⁾				
Width	Length	Height		
5.2	101	50.5 (NS 35/7,5)		
I _{max.} [A]	U _{max.} [V]	max. Ø [mm ²]	AWG (UL)	
30 ²⁾	400	0.14 - 4	26-12	
24 (FBS) / 17.5 (FBSR)				
Rated data	IEC	UL / CUL	CSA	Ex
Rated voltage	400	300	300	-
Nominal current / cross section	24 / 4	20 / -	20 / -	- / -
Rated cross section	4	4		
Connection capacity	Rigid	Flexible	Ferrule without/with plastic sleeve	
1 conductor	0.14 - 4	0.14 - 4	0.14 - 2.5	0.14 - 2.5

Ordering data			
Description	Type	Order No.	Pcs./Pkt.
Terminal block, upper level blue	PTI 2,5-PE/L/N	① 3213950	50
upper level gray	PTI 2,5-PE/L/L	① 3213949	50

Accessories ¹⁾		
Description	Type	Order No.
Cover, width: 2.2 mm	D-PTI/3	3213975
Support bracket, to hold the neutral busbar, set every 20 cm, 2 mm wide	AB-PTI/3	3213974

Terminal blocks – CLIPLINE complete

2.5 mm² PT Push-in connection terminal blocks

Installation terminal blocks

Notes:

1) For additional accessories and technical data, see page 70.

2) 3-pos. termination block.

Assembly instruction:

In order to securely fix the neutral busbar in place, support brackets must be placed at the beginning and end of each terminal strip as well as every 20 cm on longer terminal strips. The corresponding support brackets can be found at phoenixcontact.net/products

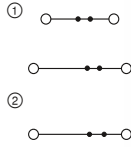

**30 A, three-level terminal block,
1 x L outer conductor, 1 x N conductor**



Technical data¹⁾

Dimensions	Width	Length	Height	
	5.2	101	50.5 (NS 35/7,5)	
Maximum electrical data	I_{max} [A]	U_{max} [V]	max. Ø [mm ²]	AWG (UL)
	30²⁾	400	0.14 - 4	26-12
Rated data	24 (FBS) / 17.5 (FBBSR)			
Maximum bridge current [A]	IEC	UL / CUL	CSA	Ex
Rated voltage [V]	400	300	300	-
Nominal current / cross section [A] / [mm ²]	24 / 2.5	20 / -	20 / -	- / -
Nominal current / cross section [A] / [mm ²]	-	-	-	-
Connection capacity	Rigid	Flexible	Ferrule without/with plastic sleeve	
1 conductor [mm ²]	0.14 - 4	0.14 - 4	0.14 - 2.5	0.14 - 2.5

Ordering data

Description	Color	Type	Order No.	Pcs./Pkt.
Terminal block, upper level blue	gray	PTI 2,5-L/N	① 3213954	50
	gray	PTI 2,5-L/L	① 3213953	50
	gray/blue	PTI 2,5-N	② 3213952	50
	gray	PTI 2,5-L	② 3213951	50

Accessories¹⁾

Accessories	Order No.	Pcs./Pkt.
Cover, width: 2.2 mm	3213975	50
Support bracket, to hold the neutral busbar, set every 20 cm, 2 mm wide	3213974	50

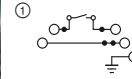

**30 A, three-level terminal block,
1 x L outer conductor, 1 x N conductor
can be disconnected, 1 x PE**



Technical data¹⁾

Dimensions	Width	Length	Height	
	5.2	101	50.5 (NS 35/7,5)	
Maximum electrical data	I_{max} [A]	U_{max} [V]	max. Ø [mm ²]	AWG (UL)
	30²⁾	400	0.14 - 4	26-12
Rated data	24 (FBS) / 17.5 (FBBSR)			
Maximum bridge current [A]	IEC	UL / CUL	CSA	Ex
Rated voltage [V]	400	300	300	-
Nominal current / cross section [A] / [mm ²]	24 / 2.5	20 / -	20 / -	- / -
Nominal current / cross section [A] / [mm ²]	-	-	-	-
Connection capacity	Rigid	Flexible	Ferrule without/with plastic sleeve	
1 conductor [mm ²]	0.14 - 4	0.14 - 4	0.14 - 2.5	0.14 - 2.5

Ordering data

Description	Color	Type	Order No.	Pcs./Pkt.
Terminal block, upper level blue	gray	PTI 2,5-PE/L/NTB	① 3213955	50
	gray/blue	PTI 2,5-PE/L/LTB	① 3213957	50

Accessories¹⁾

Accessories	Order No.	Pcs./Pkt.
D-PTI/3B	3213976	50

Installation terminal blocks

Notes:
1) For additional accessories and technical data, see page 70.
2) 3-pos. termination block.

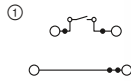

**30 A, three-level terminal block,
1 x L outer conductor, 1 x N conductor
can be disconnected**



Technical data ¹⁾				
Dimensions	Width	Length	Height	
	5.2	101	50.5 (NS 35/7,5)	
Maximum electrical data	I_{max} [A]	U_{max} [V]	max. \emptyset [mm ²]	AWG (UL)
	30 ²⁾	400	0.14 - 4	-
Maximum bridge current	24 (FBS) / 17.5 (FBSR)			
Rated data	IEC	UL / CUL	CSA	Ex
Rated voltage	400	-	300	-
Nominal current / cross section	24 / 2.5	- / -	20 / -	- / -
Nominal current / cross section	16 / 1.5 (disconnect level)			
Connection capacity	Rigid	Flexible	Ferrule without/with plastic sleeve	
1 conductor	0.14 - 4	0.14 - 4	0.14 - 2.5	0.14 - 2.5

Ordering data			
Description	Type	Order No.	Pcs./Pkt.
Terminal block, upper level blue	PTI 2,5-L/NTB	3213956	50
upper level gray	PTI 2,5-L/LTB	3213958	50

Accessories ¹⁾		
Cover, width: 2.2 mm	D-PTI/3B	Pcs./Pkt.
gray	3213976	50

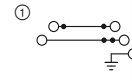

**30 A, three-level terminal block,
2 x L outer conductor, 1 x PE**



Technical data ¹⁾				
Dimensions	Width	Length	Height	
	5.2	101	50.5 (NS 35/7,5)	
Maximum electrical data	I_{max} [A]	U_{max} [V]	max. \emptyset [mm ²]	AWG (UL)
	30 ²⁾	400	0.14 - 4	26-12
Maximum bridge current	24 (FBS) / 17.5 (FBSR)			
Rated data	IEC	UL / CUL	CSA	Ex
Rated voltage	400	300	300	-
Nominal current / cross section	24 / 2.5	20 / -	20 / -	- / -
Nominal current / cross section	-			
Connection capacity	Rigid	Flexible	Ferrule without/with plastic sleeve	
1 conductor	0.14 - 4	0.14 - 4	0.14 - 2.5	0.14 - 2.5

Ordering data			
Description	Type	Order No.	Pcs./Pkt.
Terminal block, upper level blue	PTI 2,5-PE/L/LB	3213959	50

Accessories ¹⁾		
Cover, width: 2.2 mm	D-PTI/3B	Pcs./Pkt.
gray	3213976	50

Terminal blocks – CLIPLINE complete

2.5 mm² PT Push-in connection terminal blocks

Installation terminal blocks

Notes:

1) For additional accessories and technical data, see page 70.

2) 3-pos. termination block.

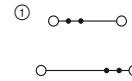

**30 A, three-level terminal block,
2 x L outer conductors**

ERC

Dimensions	
	[mm]
Maximum electrical data	
Maximum bridge current	[A]
Rated data	
Rated voltage	[V]
Nominal current / cross section	[A] / [mm ²]
Rated cross section	[mm ²]
Connection capacity	
1 conductor	[mm ²]
General data	
Stripping length	[mm]

Technical data ¹⁾			
Width	Length	Height	
5.2	101	50.5 (NS 35/7,5)	
I _{max.} [A]	U _{max.} [V]	max. Ø [mm ²]	AWG (UL)
30 ²⁾	400	0.14 - 4	-
24 (FBS) / 17.5 (FBSR)			
IEC	UL / CUL	CSA	Ex
400	-	-	-
24 / 4	- / -	- / -	- / -
4			
Rigid	Flexible	Ferrule without/with plastic sleeve	
0.14 - 4	0.14 - 4	0.14 - 2.5	0.14 - 2.5
10			

Description	Color
Terminal block	gray
Cover, width: 2.2 mm	gray

Ordering data		
Type	Order No.	Pcs./Pkt.
PTI 2,5-L/LB	3213945	50

Accessories ¹⁾		
D-PTI/3B	3213976	50

Installation terminal blocks

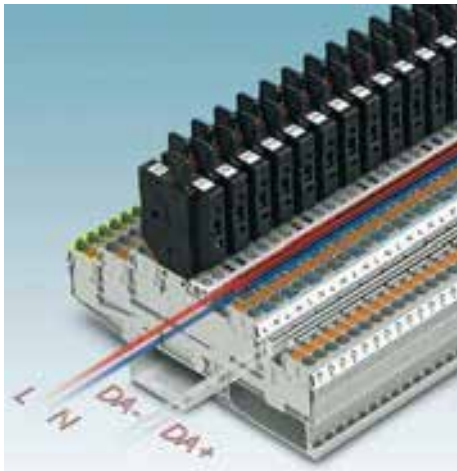

- The three-level installation terminal blocks have been specially developed for the building installation sector
- DALI-controlled emergency lighting systems can be conveniently fused and wired when space is at a premium
- Two function shafts can be used on each level on the inside of the control cabinet
- Quick and easy potential distribution, e.g., from the DALI bus system

Notes:
1) For additional accessories and technical data, see page 70.
2) Current and voltage are determined by the plug used.
3) 3-pos. termination block.

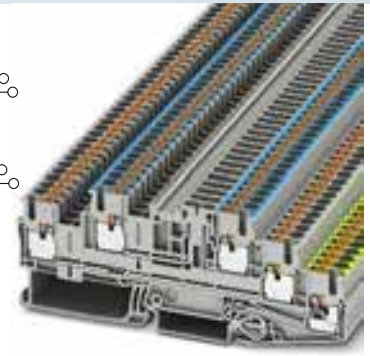
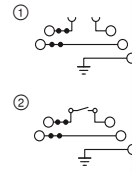

30 A, three-level terminal block, with disconnect zone and PE foot

ERIC

Dimensions	
	[mm]
Maximum electrical data	
Maximum bridge current	[A]
Rated data	
Rated voltage	[V]
Nominal current / cross section	[A] / [mm ²]
Nominal current / cross section	[A] / [mm ²]
Connection capacity	
1 conductor	[mm ²]

Description	Color
Terminal block	gray
	gray
with disconnect knife	gray

Cover, width: 2.2 mm	gray
-----------------------------	------

Technical data ¹⁾					
Width	Length	Height			
5.2	118	42.3 (NS 35/7,5)			
I_{max} [A]	U_{max} [V]	max. Ø [mm ²]	AWG (UL)		
30²⁾	400²⁾	0.14 - 4	-		
Maximum bridge current	24 (FBS) / 17.5 (FBSR)				
Rated data		IEC	UL / CUL	CSA	Ex
Rated voltage	400 ²⁾	-	-	-	-
Nominal current / cross section	22 / 2.5	- / -	- / -	- / -	- / -
Nominal current / cross section	16 / 2.5 (disconnect level)				
Connection capacity		Rigid	Flexible	Ferrule	
				without/with plastic sleeve	
0.14 - 4	0.14 - 4			0.14 - 2.5	0.14 - 2.5

Ordering data				
Type	Order No.	Pcs./Pkt.		
PTB 2,5-PE/L/NTG	① 3210545	50		
PTB 2,5-PE/L/TG	① 3210539	50		
PTB 2,5-PE/L/MT	② 3210549	50		

Accessories ¹⁾		
D-PTB 2,5/3	3210552	50

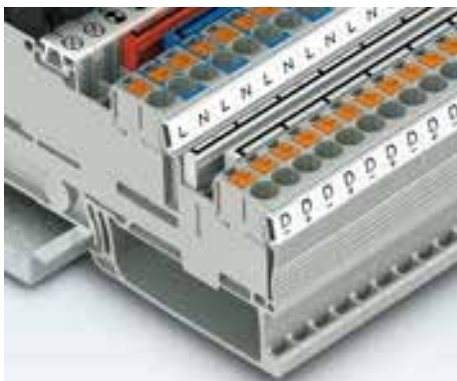

Terminal blocks – CLIPLINE complete

2.5 mm² PT Push-in connection terminal blocks

Installation Terminal Blocks



- The ...KNX terminal blocks (see page 40) make installation even easier
- Clear, color-coded assignment of the conductors and the terminal point marking
- Easy to use in sub-distribution units thanks to low height

Notes:
1) For additional accessories and technical data, see page 70.
2) 3-pos. termination block.

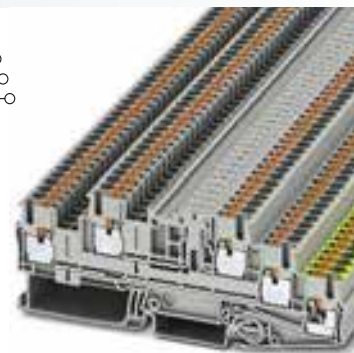
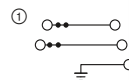

24 A, three-level terminal block, with PE foot

ERC

Dimensions	
	[mm]
Maximum electrical data	
Maximum bridge current	[A]
Rated data	
Rated voltage	[V]
Nominal current / cross section	[A] / [mm ²]
Nominal current / cross section	[A] / [mm ²]
Connection capacity	
1 conductor	[mm ²]

Technical data ¹⁾				
Width	Length	Height		
5.2	118	42.3 (NS 35/7,5)		
I _{max.} [A]	U _{max.} [V]	max. Ø [mm ²]	AWG (UL)	
24 ²⁾	400	0.14 - 4	-	
24 (FBS) / 17.5 (FBSR)				
IEC	UL / CUL	CSA	Ex	
400	-	-	-	
Nominal current / cross section	[A] / [mm ²]	- / -	- / -	
Nominal current / cross section	[A] / [mm ²]	16 / 2.5 (disconnect level)	-	
Connection capacity		Ferrule		
Rigid	Flexible	without/with plastic sleeve		
0.14 - 4	0.14 - 4	0.14 - 2.5	0.14 - 2.5	

Description	Color
Terminal block	gray
Cover, width: 2.2 mm	gray

Ordering data		
Type	Order No.	Pcs./Pkt.
PTB 2,5-PE/L/L	3210547	50

Accessories ¹⁾		
Type	Order No.	Pcs./Pkt.
D-PTB 2,5-PE/L/L	3210553	50

Mini feed-through and ground terminal blocks

Notes:

¹⁾ For additional accessories and technical data, see page 70.

For information on installation and using accessories for Ex applications, see page 678.

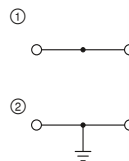

27 A, mini feed-through terminal block



Ex: SEV14ATEX0140U / IECEx SEV14.0010U

Dimensions	[mm]
Maximum electrical data	
Maximum bridge current	[A]
Rated data	
Rated voltage	[V]
Nominal current / cross section	[A] / [mm ²]

Technical data ¹⁾			
Width	Length	Height	
5.2	36	34.8 (NS 15)	
I_{max} [A]	U_{max} [V]	max. \varnothing [mm ²]	AWG (UL)
27	500	0.14 - 4	26-12
24 (FBS) / 17.5 (FBSR)			
IEC	UL / CUL	CSA	Ex
500	600	600	440
24 / 2.5	20 / -	20 / -	20.5 / 4

Description	Color
Terminal block	gray blue
Ground terminal	green-yellow
Cover, width: 2.2 mm	gray

Ordering data			
Type	Order No.	Pcs./Pkt.	
MPT 2,5	① 3248125	50	
MPT 2,5 BU	① 3248126	50	
MPT 2,5-PE	② 3248130	50	

Accessories ¹⁾		
D-MPT 2,5	3248140	50

Terminal blocks – CLIPLINE complete

4 mm² PT Push-in connection terminal blocks

General technical data

Rated data	IEC 60947-7-1 / IEC 60947-7-2 / IEC 60947-7-3			
Rated cross section	[mm ²]	4		
Cross section range	AWG	24 - 10		
Connection capacity		Rigid	Flexible	Ferrule without/with plastic sleeve
1 conductor	[mm ²]	0.2 - 6	0.2 - 4	0.25 - 4 / 0.25 - 4
2 flexible conductors with a TWIN ferrule	[mm ²]	-	-	- / 0.5 - 1
Connection cross sections directly plug-in	[mm ²]	0.5 - 6	-	0.5 - 4 / 0.5 - 4
General data				
Stripping length	[mm]	10 - 12		
Insulating material		PA		
Flammability rating in accordance with UL 94		V0		

Note: Additional or deviating data is listed alongside the respective product.

Notes:



In addition to the product, the internal electrical wiring is provided as a circuit diagram. Free connection points for bridging are indicated by a black dot.

The specified technical data and approvals refer to the first product in each column. For information on the products below, please refer to phoenixcontact.net/products

For full details of UL and CSA use groups, file nos., and Internet links, please visit phoenixcontact.net/products

¹⁾ The bridge current is listed alongside the respective product. For additional colors, see page 402.

System accessories

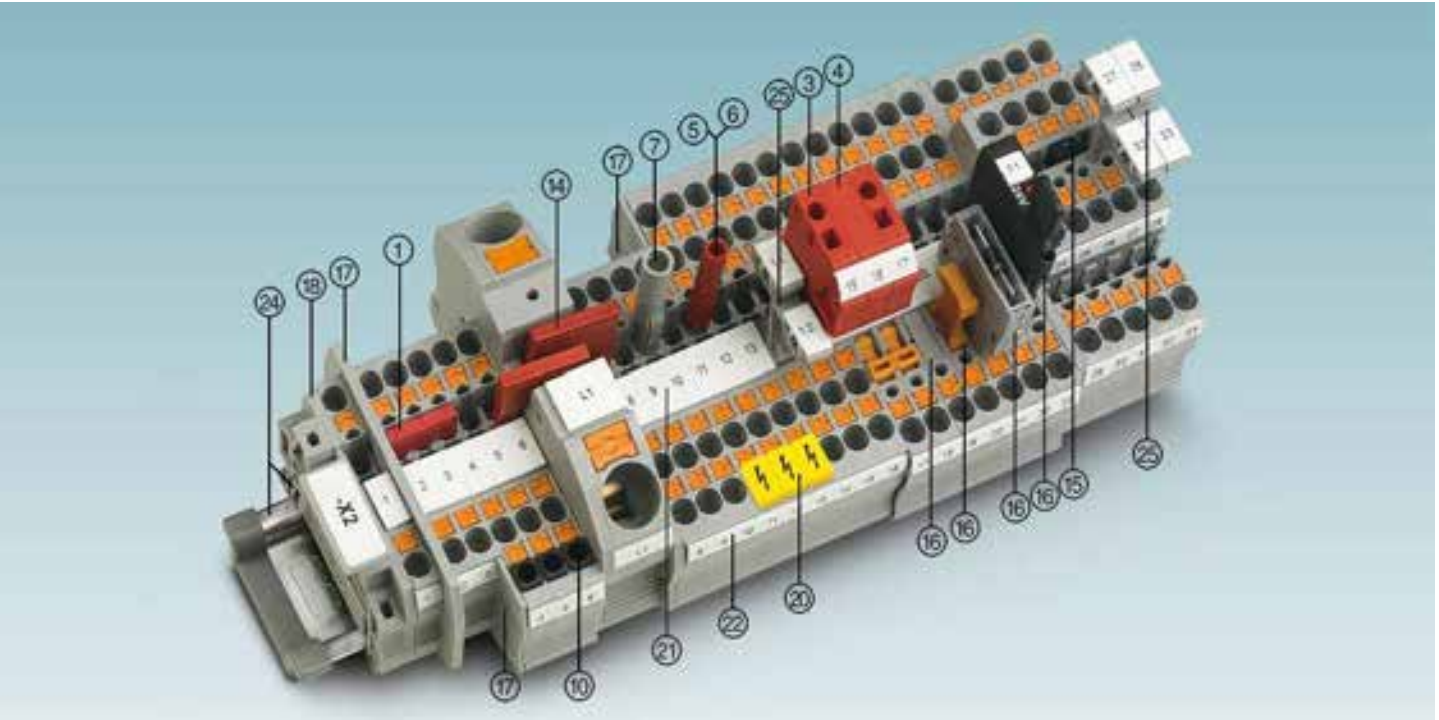

Description	No. of pos.	Color	Type	Order No.	Pcs./Pkt.	Type	Order No.	Pcs./Pkt.
① Bridge ¹⁾	2	red	FBS 2-6	3030336	50	FBSR 2-6	3033715	50
	3	red	FBS 3-6	3030242	50	FBSR 3-6	3001594	50
	4	red	FBS 4-6	3030255	50	FBSR 4-6	3001595	50
	5	red	FBS 5-6	3030349	50	FBSR 5-6	3001596	50
	10	red	FBS 10-6	3030271	10	FBSR 10-6	3033716	10
	20	red	FBS 20-6	3030365	10			
③ Modular test plug		red	PS-6	3030996	10			
④ Spacer plate		red	DP PS-6	3036738	10			
⑤ Test plug metal part		gray	MPS-MT	0201744	10			
⑥ Insulating sleeve, for MPS metal part		red	MPS-IH RD	0201676	10			
⑦ Test adapter, 4 mm socket hole		gray	PAI-4-N GY	3032871	10			
⑩ Insulating sleeve, 0.25 - 0.5 mm ² 0.75 - 1 mm ²		gray	ISH 4/0,5	3002885	50			
		black	ISH 4/1,0	3002898	50			
Screwdriver			SZF 1-0,6X3,5	1204517	10			

⑭ Reducing bridge	For RB ..., see page 408.
⑮ Vertical potential bridge	For FBS-PV ..., see page 404.
⑯ Fuse and function plugs for disconnect terminal blocks	For P-FU ... / P-DI / P-FIX / P-CO ..., see from page 414.
⑰ Partition plates/end cover segments	For ATP-... / DS-..., visit phoenixcontact.net/products
⑱ Cover	Listed alongside the respective product.
⑳ Warning labels	For WS ..., see page 420.
㉑ Center groove labeling	UC-TM 6, UCT-TM 6 or ZB 6. See also Catalog 3, selection tables, from page 60.
㉒ Center and side groove labeling	UC-TMF 6, UCT-TMF 6 or ZBF 6. See also Catalog 3, selection tables, from page 60.
㉓ DIN rail and end bracket	See Catalog 3
㉔ Marker carrier	For STP ..., see page 418.
For full accessories, visit phoenixcontact.net/products	Note: Additional or deviating accessories are listed alongside the respective product.

Feed-through, multi-conductor, multi-level, and ground terminal blocks

Notes:
 1) For additional accessories and technical data, see page 98.
 For information on installation and using accessories for Ex applications, see page 678.

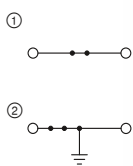

36 A, feed-through terminal block

Ex: EAC Ex IEC

 PTB 09ATEX1112U / IECEx PTB 10.0046U

Technical data ¹⁾				
Width	Length	Height		
6.2	56	36.5 (NS 35/7,5)		
<i>I</i> _{max} [A]	<i>U</i> _{max} [V]	max. Ø [mm ²]	AWG (UL)	
36	800	0.2 - 6	24-10	
32 (FBS) / 24 (FBSR)				
IEC	UL / CUL	CSA	Ex	
800	600	600	550	
32 / 4	30 / -	30 / -	26 / 4	

Ordering data			
Type	Order No.	Pcs./Pkt.	
PT 4	① 3211757	50	
PT 4 BU	① 3211760	50	
PT 4-PE	② 3211766	50	

Accessories ¹⁾		
D-ST 4	3030420	50

Dimensions	[mm]
Maximum electrical data	
Maximum bridge current	[A]
Rated data	
Rated voltage	[V]
Nominal current / cross section	[A] / [mm ²]

Description	Color
Terminal block	gray
Ground terminal	green-yellow

Cover, width: 2.2 mm gray

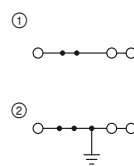

36 A, feed-through terminal block, 3 connections

Ex: EAC Ex IEC

 PTB 09ATEX1112U / IECEx PTB 10.0046U

Technical data ¹⁾				
Width	Length	Height		
6.2	66.5	36.5 (NS 35/7,5)		
<i>I</i> _{max} [A]	<i>U</i> _{max} [V]	max. Ø [mm ²]	AWG (UL)	
36	800	0.2 - 6	24-10	
32 (FBS) / 24 (FBSR)				
IEC	UL / CUL	CSA	Ex	
800	600	600	550	
32 / 4	30 / -	30 / -	26 / 4	

Ordering data			
Type	Order No.	Pcs./Pkt.	
PT 4-TWIN	① 3211771	50	
PT 4-TWIN BU	① 3211775	50	
PT 4-TWIN-PE	② 3211780	50	

Accessories ¹⁾		
D-PT 4-TWIN	3208977	50

Feed-through, multi-conductor, multi-level, and ground terminal blocks

Notes:
 1) For additional accessories and technical data, see page 98.
 For information on installation and using accessories for Ex applications, see page 678.

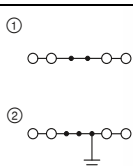

38 A, feed-through terminal block, 4 connections

Ex: EAC Ex IEC

 PTB 09ATEX1112U / IECEx PTB 10.0046U

Technical data ¹⁾				
Width	Length	Height		
6.2	77	36.5 (NS 35/7,5)		
<i>I</i> _{max} [A]	<i>U</i> _{max} [V]	max. Ø [mm ²]	AWG (UL)	
38	800	0.2 - 6	24-10	
32 (FBS) / 24 (FBSR)				
IEC	UL / CUL	CSA	Ex	
800	600	600	550	
32 / 4	30 / -	30 / -	26 / 4	

Ordering data			
Type	Order No.	Pcs./Pkt.	
PT 4-QUATTRO	① 3211797	50	
PT 4-QUATTRO BU	① 3211802	50	
PT 4-QUATTRO-PE	② 3211809	50	

Accessories ¹⁾		
D-PT 4-QUATTRO	3208979	50

Dimensions	[mm]
Maximum electrical data	
Maximum bridge current	[A]
Rated data	
Rated voltage	[V]
Nominal current / cross section	[A] / [mm ²]

Description	Color
Terminal block	gray
With potential distribution	gray
Ground terminal	green-yellow

Cover, width: 2.2 mm gray

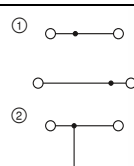

32 A, double-level terminal block, 4 connections

Ex: EAC Ex IEC

 PTB 09ATEX1112U / IECEx PTB 10.0046U

Technical data ¹⁾				
Width	Length	Height		
6.2	83.5	47.5 (NS 35/7,5)		
<i>I</i> _{max} [A]	<i>U</i> _{max} [V]	max. Ø [mm ²]	AWG (UL)	
32	500	0.2 - 6	24-10	
26 (FBS) / 20 (FBSR)				
IEC	UL / CUL	CSA	Ex	
500	600	600	440	
28 / 4	28 / -	30 / -	23 / 4	

Ordering data			
Type	Order No.	Pcs./Pkt.	
PTTB 4	① 3211786	50	
PTTB 4 BU	① 3211793	50	
PTTB 4-PV	② 3211825	50	
PTTB 4-PE	③ 3211854	50	

Accessories ¹⁾		
D-STTB 4	3030462	50

Terminal blocks – CLIPLINE complete

4 mm² PT Push-in connection terminal blocks

Feed-through and multi-level terminal blocks

Notes:
 1) For additional accessories and technical data, see page 98.



38 A, 1000 V, feed-through terminal block, incl. cover



Technical data ¹⁾					
Width	Length	Height			
8.2	83.5	47.5 (NS 35/7,5)			
I _{max.} [A]	U _{max.} [V]	max. Ø [mm ²]	AWG (UL)		
38	1000	0.2 - 6	24-10		
Maximum bridge current	[A]	-			
Rated data		IEC	UL / CUL	CSA	Ex
Rated voltage	[V]	1000	1000	1000	-
Nominal current / cross section	[A] / [mm ²]	32 / 4	30 / -	30 / -	- / -

Ordering data			
Type	Order No.	Pcs./Pkt.	
PTTB 4-L 1000V	3062744	50	

Accessories ¹⁾			

Dimensions	[mm]
Maximum electrical data	
Maximum bridge current	[A]
Rated data	
Rated voltage	[V]
Nominal current / cross section	[A] / [mm ²]
Description	Color
Terminal block	gray
Cover, width: 2.2 mm	gray

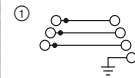

32 A, four-level terminal block with PE foot



Technical data ¹⁾					
Width	Length	Height			
6.2	104.4	96.9 (NS 35/7,5)			
I _{max.} [A]	U _{max.} [V]	max. Ø [mm ²]	AWG (UL)		
32	800	0.2 - 6	24-10		
Maximum bridge current	[A]	22 (FBS) / 20 (FBSR)			
Rated data		IEC	UL / CUL	CSA	Ex
Rated voltage	[V]	800	600	-	-
Nominal current / cross section	[A] / [mm ²]	26 / 4	28 / -	- / -	- / -

Ordering data			
Type	Order No.	Pcs./Pkt.	
PT 4-PE/3L	3210442	50	

Accessories ¹⁾			
D-PT 4-PE/3L	3210443	50	

Multi-level terminal blocks

– Same shape as three-level fuse terminal blocks

Notes:
 1) For additional accessories and technical data, see page 98.

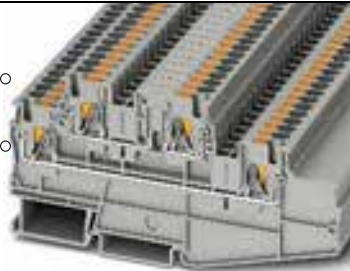
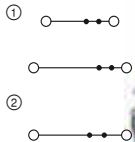

32 A, multi-level terminal block



Technical data ¹⁾					
Width	Length	Height			
6.2	118.5	56 (NS 35/7,5)			
I _{max.} [A]	U _{max.} [V]	max. Ø [mm ²]	AWG (UL)		
32	500	0.2 - 6	24-10		
Maximum bridge current	[A]	32 (FBS) / 24 (FBSR)			
Rated data		IEC	UL / CUL	CSA	Ex
Rated voltage	[V]	500	600	600	-
Nominal current / cross section	[A] / [mm ²]	30 / 4	16 / -	16 / -	- / -
Connection capacity		Rigid	Flexible	Ferrule without/with plastic sleeve	
2 flexible conductors with a TWIN ferrule	[mm ²]	-	-	-	

Ordering data			
Type	Order No.	Pcs./Pkt.	
PT 4-L/L	3002615	50	
PT 4-L	3002616	50	

Accessories ¹⁾			
D-PT 4-PE/L/HESI	3002619	50	

Dimensions	[mm]
Maximum electrical data	
Maximum bridge current	[A]
Rated data	
Rated voltage	[V]
Nominal current / cross section	[A] / [mm ²]
Connection capacity	
2 flexible conductors with a TWIN ferrule	[mm ²]
Description	Color
Terminal block	gray
upper level blue	gray
Cover, width: 2.2 mm	gray

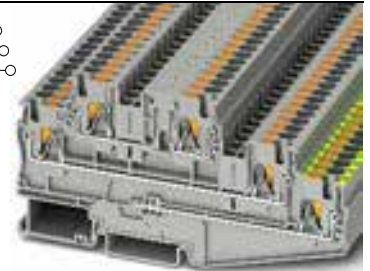
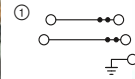

32 A, multi-level terminal block with PE foot



Technical data ¹⁾					
Width	Length	Height			
6.2	119.5	56 (NS 35/7,5)			
I _{max.} [A]	U _{max.} [V]	max. Ø [mm ²]	AWG (UL)		
32	500	0.2 - 6	24-10		
Maximum bridge current	[A]	32 (FBS) / 24 (FBSR)			
Rated data		IEC	UL / CUL	CSA	Ex
Rated voltage	[V]	500	600	600	-
Nominal current / cross section	[A] / [mm ²]	30 / 4	16 / -	16 / -	- / -
Connection capacity		Rigid	Flexible	Ferrule without/with plastic sleeve	
		-	-	-	

Ordering data			
Type	Order No.	Pcs./Pkt.	
PT 4-PE/L/L	3002613	50	
PT 4-PE/L/N	3002614	50	

Accessories ¹⁾			
D-PT 4-PE/L/HESI	3002619	50	

Fuse terminal blocks

Notes:
 1) For additional accessories and technical data, see page 98.
 2) The current is determined by the fuse used, the voltage by the selected LED display. Observe the maximum power dissipation, see phoenixcontact.net/products.

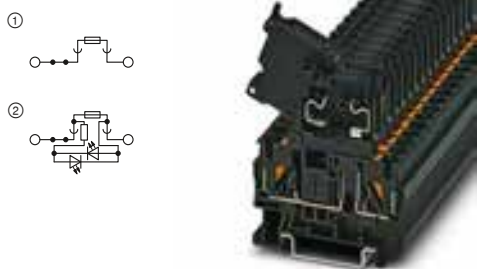

6.3 A, lever-type fuse terminal block for 5 x 20 mm cartridge fuses, 2 function shafts



Technical data ¹⁾				
Dimensions	Width	Length	Height	
[mm]	6.2	56	64.8 (NS 35/7,5)	
Maximum electrical data	I_{max} [A]	U_{max} [V]	max. Ø [mm ²]	AWG (UL)
	6.3 ²⁾	500 ²⁾	0.2 - 6	24-10
Maximum bridge current	32 (FBS) / 24 (FBSR)			
Rated data	IEC	UL / CUL	CSA	Ex
Rated voltage	500 ²⁾	300	300	-
Nominal current / cross section	6.3 / 4	6.3 / -	6.3 / -	- / -

Ordering data			
Type	Order No.	Pcs./Pkt.	
PT 4-HESI (5X20)	3211861	50	
PT 4-HESILED 24 (5X20)	3211903	50	
PT 4-HESILED 60 (5X20)	3207908	50	
PT 4-HESILA 250 (5X20)	3211907	50	

Accessories ¹⁾		
D-ST 4	3030420	50

Dimensions		Width	Length	Height
[mm]		6.2	56	64.8 (NS 35/7,5)
Maximum electrical data	I_{max} [A]	U_{max} [V]	max. Ø [mm ²]	AWG (UL)
	6.3 ²⁾	500 ²⁾	0.2 - 6	24-10
Maximum bridge current	32 (FBS) / 24 (FBSR)			
Rated data	IEC	UL / CUL	CSA	Ex
Rated voltage	500 ²⁾	300	300	-
Nominal current / cross section	6.3 / 4	6.3 / -	6.3 / -	- / -

Description	Color
Fuse terminal block	black
With LED display 12 ... 30 V AC/DC, 0.31 ... 0.95 mA	black
30 ... 60 V AC/DC, 0.40 ... 0.86 mA	black
110 ... 250 V AC/DC, 0.41 ... 0.96 mA	black

Cover, width: 2.2 mm	gray
----------------------	------

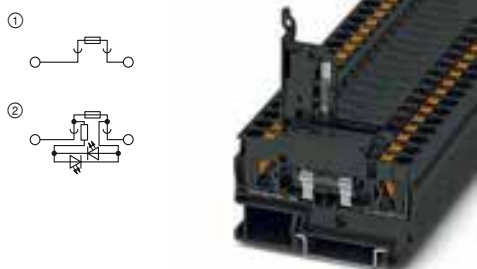

6.3 A, lever-type fuse terminal block for 5 x 20 mm cartridge fuses



Technical data ¹⁾			
Dimensions	Width	Length	Height
[mm]	8.2	67.8	42.8 (NS 35/7,5)
Maximum electrical data	I_{max} [A]	U_{max} [V]	max. Ø [mm ²]
	6.3 ²⁾	500 ²⁾	0.2 - 6
Maximum bridge current	-		
Rated data	IEC	UL / CUL	CSA
Rated voltage	500 ²⁾	300	-
Nominal current / cross section	6.3 / 1	6.3 / -	- / -

Ordering data		
Type	Order No.	Pcs./Pkt.
PTC 4-HESI (5X20)	3270200	50
PTC 4-HESILED 24 (5X20)	3270203	50
PTC 4-HESILED 60 (5X20)	3270205	50
PTC 4-HESILA 250 (5X20)	3270197	50

Accessories ¹⁾		
D-PTC 2,5-TWIN-MT	3270100	50

Fuse terminal blocks

Notes:
 1) For additional accessories and technical data, see page 98.

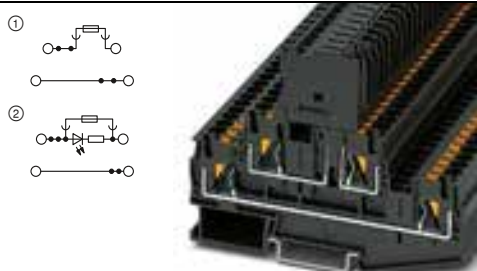

Technical data ¹⁾				
Dimensions	Width	Length	Height	
[mm]	6.2	102.9	75.5 (NS 35/7,5)	
Maximum electrical data	I_{max} [A]	U_{max} [V]	max. Ø [mm ²]	AWG (UL)
	32	500	0.2 - 6	24-10
Maximum bridge current	22 (FBS) / 22 (FBSR)			
Rated data	IEC	UL / CUL	CSA	Ex
Rated voltage	500	600	600	-
Nominal current / cross section	28 / 4	6.3 / -	6.3 / -	- / -

Ordering data			
Type	Order No.	Pcs./Pkt.	
PTTB 4-HESI (5X20)	3211886	50	
PTTB 4-HESILED 24 (5X20)	3211888	50	
PTTB 4-HESILED 60 (5X20)	3211890	50	
PTTB 4-HESILED 250 (5X20)	3211892	50	

Accessories ¹⁾		
D-PTTB 4-TG	3211918	50

Description	Color
Fuse terminal block	black
With LED display 12 ... 30 V AC/DC, 0.31 ... 0.95 mA	black
30 ... 60 V AC/DC, 0.40 ... 0.86 mA	black
110 ... 250 V AC/DC, 0.41 ... 0.96 mA	black

Cover, width: 2.2 mm	gray
----------------------	------

Terminal blocks – CLIPLINE complete

4 mm² PT Push-in connection terminal blocks

Fuse terminal blocks

Notes:
 1) For additional accessories and technical data, see page 98.
 2) The current is determined by the fuse used.

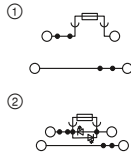

32 A, fuse terminal block for 5 x 20 mm cartridge fuses



Technical data ¹⁾				
Width	Length	Height		
6.2	118.5	83.9 (NS 35/7,5)		
I _{max.} [A]	U _{max.} [V]	max. Ø [mm ²]	AWG (UL)	
32	500	0.2 - 6	24-10	
32 (FBS) / 24 (FBSR)				
IEC	UL / CUL	CSA	Ex	
500	600	600	-	
28 / 4	6.3 / -	6.3 / -	- / -	
6.3 ²⁾ / 4 (disconnect level)				

Ordering data			
Type	Order No.	Pcs./Pkt.	
PT 4-L/HESI (5X20)	① 3002608	50	
PT 4-L/HESILED 24 (5X20)	② 3002609	50	
PT 4-L/HESILED 60 (5X20)	② 3002611	50	
PT 4-L/HESILED 250 (5X20)	② 3002612	50	

Accessories ¹⁾		
D-PT 4-PE/L/HESI	Order No.	Pcs./Pkt.
D-PT 4-PE/L/HESI	3002619	50

Dimensions	[mm]
Maximum electrical data	
Maximum bridge current	[A]
Rated data	
Rated voltage	[V]
Nominal current / cross section	[A] / [mm ²]
Nominal current / cross section	[A] / [mm ²]

Description	Color
Fuse terminal block with LED for 12 ... 30 V DC, 0.31 ... 0.95 mA	black black
30 ... 60 V AC/DC, 0.40 ... 0.86 mA	black
110 ... 250 V AC/DC, 0.41 ... 0.96 mA	black

Cover, width: 2.2 mm	gray
----------------------	------

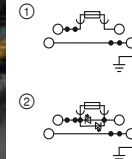

32 A, fuse terminal block for 5 x 20 mm cartridge fuses, PE foot



Technical data ¹⁾				
Width	Length	Height		
6.2	118.5	83.9 (NS 35/7,5)		
I _{max.} [A]	U _{max.} [V]	max. Ø [mm ²]	AWG (UL)	
32	500	0.2 - 6	24-10	
32 (FBS) / 24 (FBSR)				
IEC	UL / CUL	CSA	Ex	
500	600	600	-	
28 / 4	6.3 / -	6.3 / -	- / -	
6.3 ²⁾ / 4 (disconnect level)				

Ordering data			
Type	Order No.	Pcs./Pkt.	
PT 4-PE/L/HESI (5X20)	① 3002602	50	
PT 4-PE/L/HESILED 24 (5X20)	② 3002603	50	
PT 4-PE/L/HESILED 60 (5X20)	② 3002604	50	
PT 4-PE/L/HESILED 250 (5X20)	② 3002605	50	

Accessories ¹⁾		
D-PT 4-PE/L/HESI	Order No.	Pcs./Pkt.
D-PT 4-PE/L/HESI	3002619	50

Fuse terminal blocks

Notes:
 1) For additional accessories and technical data, see page 98.
 2) The current is determined by the fuse used, the voltage by the LED display.
 3) 15 A for single arrangement, 10 A for group arrangement. For the derating curve, see phoenixcontact.net/products. The recommended continuous load capacity of fuse inserts in accordance with DIN 72581/Part 3 is a maximum of 80% of their nominal current (at an ambient temperature of 23°C).

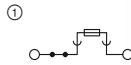

15 A, fuse terminal block, for type F flat-type fuses



Technical data ¹⁾				
Width	Length	Height		
6.2	56	36.5 (NS 35/7,5)		
I _{max.} [A]	U _{max.} [V]	max. Ø [mm ²]	AWG (UL)	
15 ³⁾	400 ²⁾	0.2 - 6	24-10	
32 (FBS) / 24 (FBSR)				
IEC	UL / CUL	CSA	Ex	
400 ²⁾	300	300	-	
10 ²⁾ / 4	7.5 / -	15 / -	- / -	

Ordering data			
Type	Order No.	Pcs./Pkt.	
PT 4-FSI/F	① 3208943	50	

Accessories ¹⁾		
D-ST 4	Order No.	Pcs./Pkt.
D-ST 4	3030420	50

Description	Color
Fuse terminal block with LED display for 12 V DC, 1.7 mA	black black
for 24 V DC, 1.9 mA	black

Cover, width: 2.2 mm	gray
----------------------	------

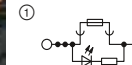

15 A, fuse terminal block with LED display, for type F flat-type fuses



Technical data ¹⁾				
Width	Length	Height		
6.2	56	36.5 (NS 35/7,5)		
I _{max.} [A]	U _{max.} [V]	max. Ø [mm ²]	AWG (UL)	
15 ³⁾	12 ²⁾	0.2 - 6	24-10	
32 (FBS) / 24 (FBSR)				
IEC	UL / CUL	CSA	Ex	
12 ²⁾	300	12	-	
10 ²⁾ / 4	7.5 / -	15 / -	- / -	

Ordering data			
Type	Order No.	Pcs./Pkt.	
PT 4-FSI/F-LED 12	① 3208951	50	
PT 4-FSI/F-LED 24	① 3208964	50	

Accessories ¹⁾		
D-ST 4	Order No.	Pcs./Pkt.
D-ST 4	3030420	50

Disconnect and knife disconnect terminal blocks

Notes:
 1) For additional accessories and technical data, see page 98.
 2) Current and voltage are determined by the plug used.



20 A, disconnect terminal block

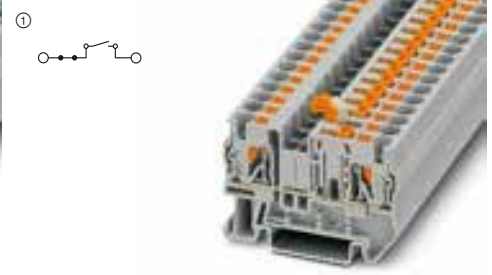

20 A, knife disconnect terminal block



Dimensions	
Width	[mm] 6.2
Maximum electrical data	
Maximum bridge current	[A] 20
Rated data	
Rated voltage	[V] 500 ²⁾
Nominal current / cross section	[A] / [mm ²] 20 ²⁾ / 2.5
Description	
Description	Color
Disconnect terminal block	gray
Knife disconnect terminal block	gray blue
Cover, width: 2.2 mm	gray

Technical data ¹⁾				
Width	Length	Height		
6.2	56	36.5 (NS 35/7,5)		
I_{max} [A]	U_{max} [V]	max. Ø [mm ²]	AWG (UL)	
20 ²⁾	500 ²⁾	0.2 - 6	24-10	
20 (FBS) / 20 (FBSR) / 20 (FBSR)				
IEC	UL / CUL	CSA	Ex	
500 ²⁾	300	300	-	
20 ²⁾ / 2.5	20 / -	20 / -	- / -	

Technical data ¹⁾				
Width	Length	Height		
6.2	56	36.5 (NS 35/7,5)		
I_{max} [A]	U_{max} [V]	max. Ø [mm ²]	AWG (UL)	
20	500	0.2 - 6	24-10	
20 (FBS) / 20 (FBSR)				
IEC	UL / CUL	CSA	Ex	
500	300	300	-	
20 / 2.5	20 / -	20 / -	- / -	

Ordering data			
Type	Order No.	Pcs./Pkt.	
PT 4-TG	3211922	50	

Ordering data			
Type	Order No.	Pcs./Pkt.	
PT 4-MT	3211933	50	
PT 4-MT BU	3211934	50	

Accessories ¹⁾			
D-ST 4	Order No.	Pcs./Pkt.	
D-ST 4	3030420	50	

Accessories ¹⁾			
D-ST 4	Order No.	Pcs./Pkt.	
D-ST 4	3030420	50	

Disconnect and knife disconnect terminal blocks

Notes:
 1) For additional accessories and technical data, see page 98.
 2) Current and voltage are determined by the plug used.

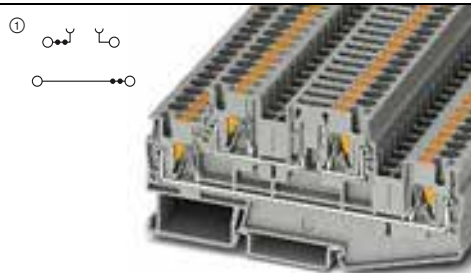

32 A, double-level terminal block, one disconnect zone

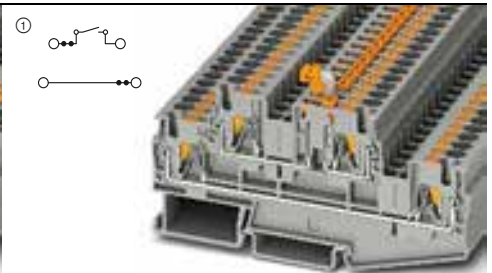

32 A, double-level knife disconnect terminal block, one disconnect zone



Dimensions	
Width	[mm] 6.2
Maximum electrical data	
Maximum bridge current	[A] 32
Rated data	
Rated voltage	[V] 500 ²⁾
Nominal current / cross section	[A] / [mm ²] 28 ²⁾ / 4
Nominal current / cross section	[A] / [mm ²] 20 / 4 (disconnect level)
Description	
Description	Color
Disconnect terminal block	gray blue
Knife disconnect terminal block	gray blue
Cover, width: 2.2 mm	gray

Technical data ¹⁾				
Width	Length	Height		
6.2	102.9	47.4 (NS 35/7,5)		
I_{max} [A]	U_{max} [V]	max. Ø [mm ²]	AWG (UL)	
32 ²⁾	500 ²⁾	0.2 - 6	24-10	
32 (FBS) / 24 (FBSR)				
IEC	UL / CUL	CSA	Ex	
500 ²⁾	600	600	-	
28 ²⁾ / 4	16 / -	16 / -	- / -	

Technical data ¹⁾				
Width	Length	Height		
6.2	102.9	49 (NS 35/7,5)		
I_{max} [A]	U_{max} [V]	max. Ø [mm ²]	AWG (UL)	
32	500	0.2 - 6	24-10	
32 (FBS) / 24 (FBSR)				
IEC	UL / CUL	CSA	Ex	
500	600	600	-	
28 ²⁾ / 4	16 / -	16 / -	- / -	

Ordering data			
Type	Order No.	Pcs./Pkt.	
PTTB 4-TG	3211909	50	
PTTB 4-TG BU	3211911	50	

Ordering data			
Type	Order No.	Pcs./Pkt.	
PTTB 4-MT	3211913	50	
PTTB 4-MT BU	3211915	50	

Accessories ¹⁾			
D-PTTB 4-TG	Order No.	Pcs./Pkt.	
D-PTTB 4-TG	3211918	50	

Accessories ¹⁾			
D-PTTB 4-TG	Order No.	Pcs./Pkt.	
D-PTTB 4-TG	3211918	50	

Terminal blocks – CLIPLINE complete

4 mm² PT Push-in connection terminal blocks

Disconnect and knife disconnect terminal blocks

– Same shape as three-level fuse terminal blocks

Notes:

¹⁾ For additional accessories and technical data, see page 98.

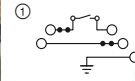
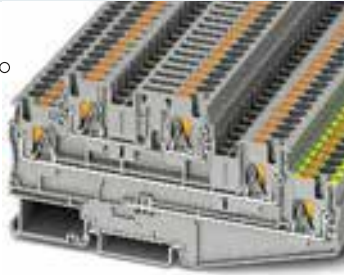
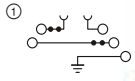

Technical data ¹⁾				
Width	Length	Height		
6.2	119.5	56 (NS 35/7,5)		
I_{max} [A]	U_{max} [V]	max. Ø [mm ²]	AWG (UL)	
32	500	0.2 - 6	24-10	
32 (FBS) / 24 (FBSR)				
IEC	UL / CUL	CSA	Ex	
500	600	600	-	
Nominal current / cross section	[A] / [mm ²]	30 / 4	16 / -	- / -
Nominal current / cross section	[A] / [mm ²]	20 / 4 (disconnect level)		



Technical data ¹⁾				
Width	Length	Height		
6.2	119.5	57.6 (NS 35/7,5)		
I_{max} [A]	U_{max} [V]	max. Ø [mm ²]	AWG (UL)	
32	500	0.2 - 6	24-10	
20 (FBS) / 20 (FBSR)				
IEC	UL / CUL	CSA	Ex	
500	600	600	-	
Nominal current / cross section	[A] / [mm ²]	30 / 4	16 / -	- / -
Nominal current / cross section	[A] / [mm ²]	20 / 4 (disconnect level)		

Ordering data

Description	Color
Disconnect terminal block	gray
Knife disconnect terminal block	gray

Type	Order No.	Pcs./Pkt.
PT 4-PE/L/TG	3002618	50

Accessories¹⁾

Cover, width: 2.2 mm	gray
----------------------	------

Type	Order No.	Pcs./Pkt.
D-PT 4-PE/L/HESI	3002619	50

Ordering data

Type	Order No.	Pcs./Pkt.
PT 4-PE/L/MT	3002617	50

Accessories¹⁾

Type	Order No.	Pcs./Pkt.
D-PT 4-PE/L/HESI	3002619	50

Diode terminal blocks

Notes:

¹⁾ For additional accessories and technical data, see page 98.

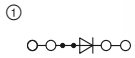

1.5 A, diode terminal block, 1N 5408 (1000 V/1.5 A)

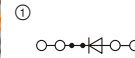

1.5 A, diode terminal block, 1N 5408 (1000 V/1.5 A)



Technical data ¹⁾				
Width	Length	Height		
6.2	77	36.5 (NS 35/7,5)		
I_{max} [A]	U_{max} [V]	max. Ø [mm ²]	AWG (UL)	
1.5	800	0.2 - 6	24-10	
32 (FBS) / 24 (FBSR)				
IEC	UL / CUL	CSA	Ex	
800	600	600	-	
Nominal current / cross section	[A] / [mm ²]	1.5 / 1	1.5 / -	1.5 / -

Ordering data

Description	Color
Terminal block, for conducting direction see circuit diagram	gray

Type	Order No.	Pcs./Pkt.
PT 4-QUATTRO-DIO 1N 5408/L-R	3211919	50

Accessories¹⁾

Cover, width: 2.2 mm	gray
----------------------	------

Type	Order No.	Pcs./Pkt.
D-PT 4-QUATTRO	3208979	50



Technical data ¹⁾				
Width	Length	Height		
6.2	77	36.5 (NS 35/7,5)		
I_{max} [A]	U_{max} [V]	max. Ø [mm ²]	AWG (UL)	
1.5	800	0.2 - 6	24-10	
32 (FBS) / 24 (FBSR)				
IEC	UL / CUL	CSA	Ex	
800	600	600	-	
Nominal current / cross section	[A] / [mm ²]	1.5 / 1	1.5 / -	1.5 / -

Ordering data

Type	Order No.	Pcs./Pkt.
PT 4-QUATTRO-DIO 1N 5408/R-L	3211921	50

Accessories¹⁾

Type	Order No.	Pcs./Pkt.
D-PT 4-QUATTRO	3208979	50

Test disconnect terminal blocks

Notes:

1) For additional accessories and technical data, see page 98.

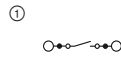

24 A, test disconnect terminal block

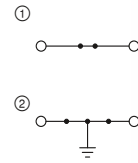

32 A, feed-through terminal block, same shape



Technical data ¹⁾			
Width	Length	Height	
6.2	70.5	49.5 (NS 35/7,5)	
I _{max} [A]	U _{max} [V]	max. Ø [mm ²]	AWG (UL)
24	500	0.2 - 6	24-10
24 (FBS) / 24 (FBSR)			
IEC	UL / CUL	CSA	Ex
500	300	300	-
Nominal current / cross section [A] / [mm ²]			
24 / 4	26 / -	26 / -	- / -

Ordering data		
Type	Order No.	Pcs./Pkt.
PTME 4	3212139	50

Accessories ¹⁾		
Type	Order No.	Pcs./Pkt.
D-PTME 4	3212167	10



Technical data ¹⁾			
Width	Length	Height	
6.2	70.5	49.5 (NS 35/7,5)	
I _{max} [A]	U _{max} [V]	max. Ø [mm ²]	AWG (UL)
32	500	0.2 - 6	24-10
28 (FBS) / 24 (FBSR)			
IEC	UL / CUL	CSA	Ex
500	300	300	-
Nominal current / cross section [A] / [mm ²]			
32 / 4	26 / -	26 / -	- / -

Ordering data		
Type	Order No.	Pcs./Pkt.
PTMED 4	3212141	50
PTMED 4-PE	3212154	50

Accessories ¹⁾		
Type	Order No.	Pcs./Pkt.
D-PTME 4	3212167	10

Dimensions	[mm]
Maximum electrical data	
Maximum bridge current	[A]
Rated data	
Rated voltage	[V]
Nominal current / cross section	[A] / [mm ²]
Description	Color
Terminal block	gray
Ground terminal	green-yellow
Cover, width: 2.2 mm	gray

Supplementary accessories for PTME 4 test disconnect terminal blocks



- A current transformer measuring circuit can be created using just two PTME 4
- Less space required compared to creating circuits with slide-type terminal blocks
- ① FBS... plug-in bridge for cross connection
- ② 4 mm Ø PAI-4-FIX... test plug adapter
- ③ S-ME 4 switching lock
- ④ SB-ME... bridge bar
- ⑤ C-ME 4/2 operating lever

			Ordering data		
Description	No. of pos.	Color	Type	Order No.	Pcs./Pkt.
Test adapter, for 4 mm Ø safety test plugs, latches into the bridge shaft	1	orange	PAI-4-FIX-5/6 OG	3035974	10
	1	yellow	PAI-4-FIX-5/6 YE	3035977	10
	1	green	PAI-4-FIX-5/6 GN	3035978	10
	1	violet	PAI-4-FIX-5/6 VT	3035979	10
	1	black	PAI-4-FIX-5/6 BK	3035980	10
	1	blue	PAI-4-FIX-5/6 BU	3035975	10
	1	red	PAI-4-FIX-5/6 RD	3035976	10
	1	gray	PAI-4-FIX-5/6 GY	3035982	10
	1	brown	PAI-4-FIX-5/6 BN	3035981	10
	1	white	PAI-4-FIX-5/6 WH	3035983	10
Switching lock, plug-in		white	S-ME 4	3035758	10
Switching bridge, plug-in	2	gray/orange	SB-ME 2-6	3035755	10
	3	gray/orange	SB-ME 3-6	3035756	10
	4	gray/orange	SB-ME 4-6	3035757	10
Operating lever, for actuating 2 test disconnect terminal blocks	2	orange	C-ME 4/2	3035759	10
	3	orange	C-ME 4/3	3035760	10

Terminal blocks – CLIPLINE complete

4 mm² PT Push-in connection terminal blocks

Hybrid terminal blocks with screw connection on one side, 4 (6) mm²

Notes:
1) For additional accessories and technical data, see page 98.
2) For screw connection rated data, see page 158.

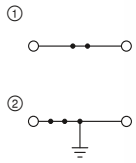

38 A, feed-through terminal block



Technical data ¹⁾				
Width	Length	Height		
6.2	58.8	42.8 (NS 35/7,5)		
I _{max.} [A]	U _{max.} [V]	max. Ø [mm ²]	AWG (UL)	
38	800	0.2 - 6	24-10	
32 (FBS) / 24 (FBSR)				
IEC	UL / CUL	CSA	Ex	
800	600	-	-	
Nominal current / cross section	[A] / [mm ²]			
32 / 4	30 / - / - / -			

Ordering data			
Type	Order No.	Pcs./Pkt.	
PTU 4	① 3211855	50	
PTU 4 BU	① 3211856	50	
PTU 4-PE	② 3211857	50	

Accessories ¹⁾		
D-PTU 4	Order No.	Pcs./Pkt.
D-PTU 4	3211858	50

Dimensions	[mm]
Maximum electrical data	
Maximum bridge current	[A]
Rated data²⁾	
Rated voltage	[V]
Nominal current / cross section	[A] / [mm ²]
32 / 4	30 / - / - / -
Description	Color
Terminal block	gray
	blue
Ground terminal	green-yellow
Cover, width: 2.2 mm	gray

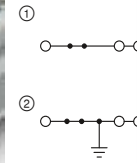

38 A, feed-through terminal block, 3 connections



Technical data ¹⁾				
Width	Length	Height		
6.2	69.3	42.8 (NS 35/7,5)		
I _{max.} [A]	U _{max.} [V]	max. Ø [mm ²]	AWG (UL)	
38	800	0.2 - 6	24-10	
32 (FBS) / 24 (FBSR)				
IEC	UL / CUL	CSA	Ex	
800	600	-	-	
Nominal current / cross section	[A] / [mm ²]			
32 / 4	30 / - / - / -			

Ordering data			
Type	Order No.	Pcs./Pkt.	
PTU 4-TWIN	① 3211859	50	
PTU 4-TWIN BU	① 3211860	50	
PTU 4-TWIN-PE	② 3211862	50	

Accessories ¹⁾		
D-PTU 4-TWIN	Order No.	Pcs./Pkt.
D-PTU 4-TWIN	3211863	50

Hybrid terminal blocks with screw connection on one side, 4 (6) mm²

Notes:
1) For additional accessories and technical data, see page 98.
2) For screw connection rated data, see page 158.

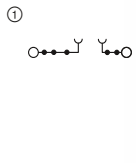

20 A, disconnect terminal block, 3 function shafts and two 4 mm test sockets



Technical data ¹⁾				
Width	Length	Height		
6.2	71	42.8 (NS 35/7,5)		
I _{max.} [A]	U _{max.} [V]	max. Ø [mm ²]	AWG (UL)	
20	400	0.2 - 6	-	
20 (FBS) / 20 (FBSR)				
IEC	UL / CUL	CSA	Ex	
400	-	-	-	
Nominal current / cross section	[A] / [mm ²]			
20 / 4	- / - / - / -			

Ordering data			
Type	Order No.	Pcs./Pkt.	
PTU 4-TG	① 3209542	50	
PTU 4-TG-P	① 3209541	50	

Accessories ¹⁾		
D-PTU 4-MT	Order No.	Pcs./Pkt.
D-PTU 4-MT	3209534	50

Dimensions	[mm]
Maximum electrical data	
Maximum bridge current	[A]
Rated data²⁾	
Rated voltage	[V]
Nominal current / cross section	[A] / [mm ²]
20 / 4	- / - / - / -
Description	Color
Terminal block	gray
With test socket screws	gray
Feed-through terminal block, same shape	gray
With test socket screws	gray
Cover, width: 2.2 mm	gray

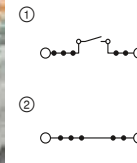

20 A, knife disconnect terminal block, 3 function shafts and two 4 mm test sockets



Technical data ¹⁾				
Width	Length	Height		
6.2	71	42.8 (NS 35/7,5)		
I _{max.} [A]	U _{max.} [V]	max. Ø [mm ²]	AWG (UL)	
20	400	0.2 - 6	-	
20 (FBS) / 20 (FBSR)				
IEC	UL / CUL	CSA	Ex	
400	-	-	-	
Nominal current / cross section	[A] / [mm ²]			
20 / 4	- / - / - / -			

Ordering data			
Type	Order No.	Pcs./Pkt.	
PTU 4-MT	① 3209538	50	
PTU 4-MT-P	① 3209532	50	
PTU 4-MTD	② 3209539	50	
PTU 4-MTD-P	② 3209540	50	

Accessories ¹⁾		
D-PTU 4-MT	Order No.	Pcs./Pkt.
D-PTU 4-MT	3209534	50

Feed-through terminal blocks, multi-conductor terminal blocks, and ground terminals in desk design

Notes:

1) For additional accessories and technical data, see page 98.

For information on installation and using accessories for Ex applications, see page 678.

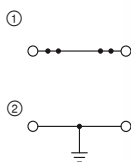

38 A, feed-through terminal block



Ex: Ex IEC Ex IEC Ex IEC
KIWA17ATEX0048U / IECEX KIWA17.0026U

Technical data¹⁾

Width	Length	Height		
6.2	62.4	43 (NS 35/7,5)		
I _{max} [A]	U _{max} [V]	max. Ø [mm ²]	AWG (UL)	
38	800	0.2 - 6	24-10	
32 (FBS) / 24 (FBSR)				
IEC	UL / CUL	CSA	Ex	
800	600	600	550	
32 / 4	30 / -	30 / -	28 / 4	

Ordering data

Type	Order No.	Pcs./Pkt.
PTS 4	① 3213601	50
PTS 4 BU	① 3213602	50
PTS 4-PE	② 3213603	50

Accessories¹⁾

D-PTS 4	3213600	10
---------	---------	----

Dimensions	[mm]
Maximum electrical data	
Maximum bridge current	[A]
Rated data	
Rated voltage	[V]
Nominal current / cross section	[A] / [mm ²]

Description	Color
Terminal block	gray blue
Ground terminal	green-yellow

Cover, width: 2.2 mm	gray
----------------------	------

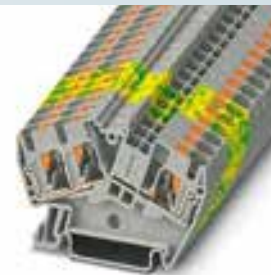
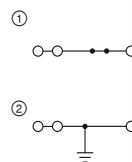

38 A, feed-through terminal block, 3 connections



Ex: Ex IEC Ex IEC Ex IEC
KIWA17ATEX0048U / IECEX KIWA17.0026U

Technical data¹⁾

Width	Length	Height		
6.2	62.4	43 (NS 35/7,5)		
I _{max} [A]	U _{max} [V]	max. Ø [mm ²]	AWG (UL)	
38	800	0.2 - 6	24-10	
32 (FBS) / 24 (FBSR)				
IEC	UL / CUL	CSA	Ex	
800	600	600	550	
32 / 4	30 / -	30 / -	28 / 4	

Ordering data

Type	Order No.	Pcs./Pkt.
PTS 4-TWIN	① 3213604	50
PTS 4-TWIN BU	① 3213605	50
PTS 4-TWIN-PE	② 3213606	50

Accessories¹⁾

D-PTS 4	3213600	10
---------	---------	----

Multi-conductor terminal blocks, multi-level terminal blocks, and ground terminals in desk design

Notes:

1) For additional accessories and technical data, see page 98.

For information on installation and using accessories for Ex applications, see page 678.

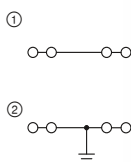

38 A, feed-through terminal block, 4 connections



Ex: Ex IEC Ex IEC Ex IEC
KIWA17ATEX0048U / IECEX KIWA17.0026U

Technical data¹⁾

Width	Length	Height		
6.2	62.4	43 (NS 35/7,5)		
I _{max} [A]	U _{max} [V]	max. Ø [mm ²]	AWG (UL)	
38	800	0.2 - 6	24-10	
-				
IEC	UL / CUL	CSA	Ex	
800	600	600	550	
32 / 4	30 / -	30 / -	27 / 4	

Ordering data

Type	Order No.	Pcs./Pkt.
PTS 4-QUATTRO	① 3213607	50
PTS 4-QUATTRO BU	① 3213608	50
PTS 4-QUATTRO-PE	② 3213609	50

Accessories¹⁾

D-PTS 4	3213600	10
---------	---------	----

Dimensions	[mm]
Maximum electrical data	
Maximum bridge current	[A]
Rated data	
Rated voltage	[V]
Nominal current / cross section	[A] / [mm ²]

Description	Color
Terminal block	gray blue
With potential distribution	gray
Ground terminal	green-yellow

Cover, width: 2.2 mm	gray
----------------------	------

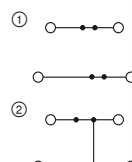

Ex: Ex IEC Ex IEC Ex IEC
KIWA17ATEX0048U / IECEX KIWA17.0026U

Technical data¹⁾

Width	Length	Height		
6.2	96	54.5 (NS 35/7,5)		
I _{max} [A]	U _{max} [V]	max. Ø [mm ²]	AWG (UL)	
32	800	0.2 - 6	24-10	
26 (FBS) / 22 (FBSR)				
IEC	UL / CUL	CSA	Ex	
800	600	600	440	
28	24 / -	24 / -	23 / 4	

Ordering data

Type	Order No.	Pcs./Pkt.
PTTBS 4	① 3211832	50
PTTBS 4 BU	① 3211838	50
PTTBS 4-PV	② 3211848	50
PTTBS 4-PE	③ 3211841	50

Accessories¹⁾

D-PTTBS 4	3211849	50
-----------	---------	----

Terminal blocks – CLIPLINE complete

4 mm² PT Push-in connection terminal blocks

Installation terminal blocks

Notes:

¹⁾ For additional accessories and technical data, see page 98.

Assembly instruction:

In order to securely fix the neutral busbar in place, support brackets must be placed at the beginning and end of each terminal strip as well as every 20 cm on longer terminal strips. The corresponding support brackets can be found at phoenixcontact.net/products

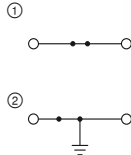

32 A, feed-through terminal block

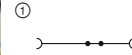

32 A, neutral disconnect terminal block



Technical data¹⁾

Dimensions	Width	Length	Height	
	6.2	66	44 (NS 35/7,5)	
Maximum electrical data				
	I_{max} [A]	U_{max} [V]	max. \emptyset [mm ²]	AWG (UL)
	32	800	0.2 - 6	-
Maximum bridge current	32 (FBS) / 24 (FBSR)			
Rated data	IEC	UL / CUL	CSA	Ex
Rated voltage	800	-	-	-
Nominal current / cross section	32 / 4	- / -	- / -	- / -
Connection capacity	Rigid	Flexible	Ferrule without/with plastic sleeve	
1 conductor	0.2 - 6	0.2 - 6	0.25 - 4	0.25 - 4
2 conductors (of the same type)	-	-	-	-

Technical data¹⁾

Dimensions	Width	Length	Height	
	6.2	66	46.3 (NS 35/7,5)	
Maximum electrical data				
	I_{max} [A]	U_{max} [V]	max. \emptyset [mm ²]	AWG (UL)
	32	250	0.2 - 6	-
Maximum bridge current	32 (FBS) / 24 (FBSR)			
Rated data	IEC	UL / CUL	CSA	Ex
Rated voltage	250	-	-	-
Nominal current / cross section	32 / 4	- / -	- / -	- / -
Connection capacity	Rigid	Flexible	Ferrule without/with plastic sleeve	
1 conductor	0.2 - 6	0.2 - 4	0.25 - 4	0.25 - 4
2 conductors (of the same type)	0.2 - 2	-	-	-

Ordering data

Description	Color	Type	Order No.	Pcs./Pkt.
Terminal block	gray	PTI 4	① 3213970	50
	blue	PTI 4 BU	① 3213971	50
Ground terminal	green-yellow	PTI 4-PE	② 3213964	50

Ordering data

Description	Color	Type	Order No.	Pcs./Pkt.
Neutral disconnect terminal block	blue	PTN 4	① 3213965	50

Accessories¹⁾

Accessories	Order No.	Pcs./Pkt.
Cover, width: 2.2 mm	1016697	50
Support bracket, to hold the neutral busbar, set every 20 cm, 2 mm wide	3214006	50

Accessories¹⁾

Accessories	Order No.	Pcs./Pkt.
Cover, width: 2.2 mm	3213978	50
Support bracket, to hold the neutral busbar, set every 20 cm, 2 mm wide	3214006	50

Installation terminal blocks

Notes:

1) For additional accessories and technical data, see page 98.

2) Max. load current 32 A with a 6 mm² conductor cross section

Assembly instruction:
In order to securely fix the neutral busbar in place, support brackets must be placed at the beginning and end of each terminal strip as well as every 20 cm on longer terminal strips. The corresponding support brackets can be found at phoenixcontact.net/products

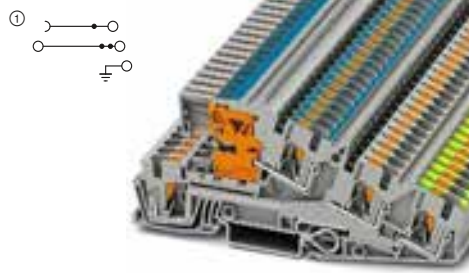

32 A, three-level terminal block, 1 x L outer conductor, 1 x N conductor can be disconnected, 1 x PE



Technical data ¹⁾			
Width	Length	Height	
6.2	114	50.5 (NS 35/7,5)	
I _{max} [A]	U _{max} [V]	max. Ø [mm ²]	AWG (UL)
32 ²⁾	400	0.2 - 6	20-8
32 (FBS) / 24 (FBSR)			
IEC	UL / CUL	CSA	Ex
400	300	600	-
28 / 4			
Rigid		Flexible	
		without/with plastic sleeve	
1 conductor	0.2 - 6	0.25 - 4	0.25 - 4

Ordering data			
Type	Order No.	Pcs./Pkt.	
PTI 4-PE/L/NT	3214047	50	
PTI 4-PE/L/LT	3214048	50	

Accessories ¹⁾			
Type	Order No.	Pcs./Pkt.	
D-PTI 4/3	3214054	50	
AB-PTI 4/3	3214053	50	

Dimensions	
	[mm]
Maximum electrical data	
Maximum bridge current	[A]
Rated data	
Rated voltage	[V]
Nominal current / cross section	[A] / [mm ²]
Connection capacity	
1 conductor	[mm ²]

Description	Color
Terminal block, upper level blue	gray
	gray

Cover, width: 2.2 mm	gray
Support bracket, to hold the neutral busbar, set every 20 cm, 2 mm wide	blue

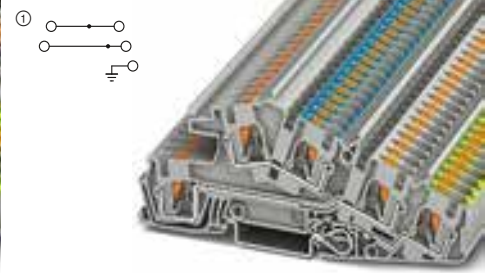

32 A, three-level terminal block, 2 x L outer conductor, 1 x PE



Technical data ¹⁾			
Width	Length	Height	
6.2	114	50.5 (NS 35/7,5)	
I _{max} [A]	U _{max} [V]	max. Ø [mm ²]	AWG (UL)
32 ²⁾	400	0.2 - 6	20-8
32 (FBS) / 24 (FBSR)			
IEC	UL / CUL	CSA	Ex
400	300	600	-
28 / 4			
Rigid		Flexible	
		without/with plastic sleeve	
0.2 - 6	0.2 - 6	0.25 - 4	0.25 - 4

Ordering data			
Type	Order No.	Pcs./Pkt.	
PTI 4-PE/L/N	3214049	50	
PTI 4-PE/L/L	3214050	50	

Accessories ¹⁾			
Type	Order No.	Pcs./Pkt.	
D-PTI 4/3	3214054	50	
AB-PTI 4/3	3214053	50	

Installation terminal blocks

Notes:

1) For additional accessories and technical data, see page 98.

2) Max. load current 32 A with a 6 mm² conductor cross section

Assembly instruction:
In order to securely fix the neutral busbar in place, support brackets must be placed at the beginning and end of each terminal strip as well as every 20 cm on longer terminal strips. The corresponding support brackets can be found at phoenixcontact.net/products

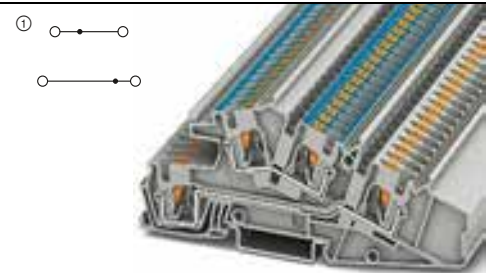

32 A, three-level terminal block, 1 x L outer conductor, 1 x N conductor



Dimensions	
	[mm]
Maximum electrical data	
Maximum bridge current	[A]
Rated data	
Rated voltage	[V]
Nominal current / cross section	[A] / [mm ²]
Connection capacity	
1 conductor	[mm ²]

Ordering data			
Type	Order No.	Pcs./Pkt.	
PTI 4-L/N	3214051	50	
PTI 4-L/L	3214052	50	

Accessories ¹⁾			
Type	Order No.	Pcs./Pkt.	
D-PTI 4/3	3214054	50	
AB-PTI 4/3	3214053	50	

Technical data ¹⁾			
Width	Length	Height	
6.2	114	50.5 (NS 35/7,5)	
I _{max} [A]	U _{max} [V]	max. Ø [mm ²]	AWG (UL)
32 ²⁾	400	0.2 - 6	20-8
32 (FBS) / 24 (FBSR)			
IEC	UL / CUL	CSA	Ex
400	300	600	-
28 / 4			
Rigid		Flexible	
		without/with plastic sleeve	
0.2 - 6	0.2 - 6	0.25 - 4	0.25 - 4

Ordering data			
Type	Order No.	Pcs./Pkt.	
PTI 4-L/N	3214051	50	
PTI 4-L/L	3214052	50	

Accessories ¹⁾			
Type	Order No.	Pcs./Pkt.	
D-PTI 4/3	3214054	50	
AB-PTI 4/3	3214053	50	

Terminal blocks – CLIPLINE complete

6 mm² PT Push-in connection terminal blocks

General technical data

Rated data		IEC 60947-7-1 / IEC 60947-7-2 / IEC 60947-7-3			
Rated cross section	[mm ²]	6			
Cross section range	AWG	20 - 8			
Connection capacity		Rigid	Flexible	Ferrule without/with plastic sleeve	
1 conductor	[mm ²]	0.5 - 10	0.5 - 6	0.5 - 6	0.5 - 6
2 flexible conductors with a TWIN ferrule	[mm ²]	-	-	-	0.5 - 1.5
Connection cross sections directly plug-in	[mm ²]	1 - 10	-	1 - 6	1 - 6
General data					
Stripping length	[mm]	10 - 12			
Insulating material		PA			
Flammability rating in accordance with UL 94		V0			

Note: Additional or deviating data is listed alongside the respective product.

Notes:



In addition to the product, the internal electrical wiring is provided as a circuit diagram. Free connection points for bridging are indicated by a black dot.

The specified technical data and approvals refer to the first product in each column. For information on the products below, please refer to phoenixcontact.net/products

For full details of UL and CSA use groups, file nos., and Internet links, please visit phoenixcontact.net/products

¹⁾ The bridge current is listed alongside the respective product. For additional colors, see page 402.

System accessories

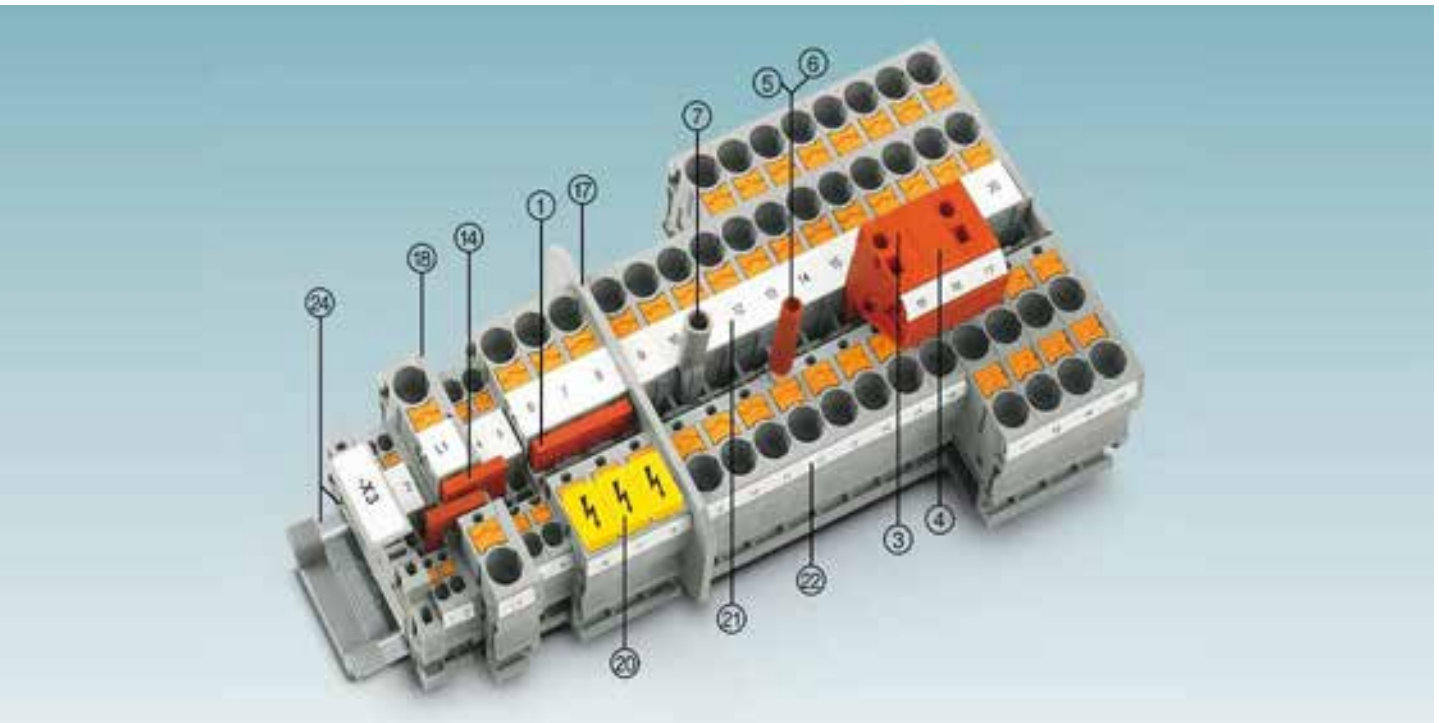

Description	No. of pos.	Color	Type	Order No.	Pcs./Pkt.	Type	Order No.	Pcs./Pkt.
① Bridge ¹⁾	2	red	FBS 2-8	3030284	10	FBSR 2-8	3033808	10
	3	red	FBS 3-8	3030297	10	FBSR 3-8	3001597	10
	4	red	FBS 4-8	3030307	10	FBSR 4-8	3000585	10
	5	red	FBS 5-8	3030310	10	FBSR 5-8	3033809	10
	10	red	FBS 10-8	3030323	10	FBSR 10-8	3001599	10
	16	red	FBS 16-8			FBSR 16-8	3033816	10
③ Modular test plug		red	PS-8	3031005	10			
④ Spacer plate		red	DP PS-8	3036741	10			
⑤ Test plug metal part		gray	MPS-MT	0201744	10			
⑥ Insulating sleeve, for MPS metal part		red	MPS-IH RD	0201676	10			
⑦ Test adapter, 4 mm socket hole		gray	PAI-4-N GY	3032871	10			
Screwdriver			SZF 2-0,8X4,0	1204520	10			

⑭ Reducing bridge	For RB ..., see page 408.
⑰ Partition plates/end cover segments	For ATP-... / DS-..., visit phoenixcontact.net/products
⑱ Cover	Listed alongside the respective product.
⑳ Warning labels	For WS ..., see page 420.
㉑ Center groove labeling	UC-TM 8, UCT-TM 8 or ZB 8. See also Catalog 3, selection tables, from page 60.
㉒ Center and side groove labeling	UC-TMF 8, UCT-TMF 8 or ZBF 8. See also Catalog 3, selection tables, from page 60.
㉓ DIN rail and end bracket	See Catalog 3
For full accessories, visit phoenixcontact.net/products	Note: Additional or deviating accessories are listed alongside the respective product.

Feed-through, multi-conductor, multi-level, and ground terminal blocks

Notes:
 1) For additional accessories and technical data, see page 110.
 For information on installation and using accessories for Ex applications, see page 678.

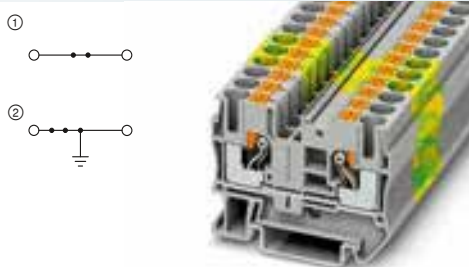

52 A, feed-through terminal block

Ex: EAC Ex IEC CB

 SEV13ATEX0159U / IECEx SEV13.0005U

Technical data ¹⁾			
Width	Length	Height	
8.2	57.7	43.5 (NS 35/7,5)	
I _{max} [A]	U _{max} [V]	max. Ø [mm ²]	AWG (UL)
52	1000	0.5 - 10	20-8
41 (FBS) / 32 (FBSR)			
Rated data	UL / CUL	CSA	Ex
1000	600	600	550
Nominal current / cross section	[A] / [mm ²]	41 / 6	40 / -

Ordering data			
Type	Order No.	Pcs./Pkt.	
PT 6	① 3211813	50	
PT 6 BU	① 3211819	50	
PT 6-PE	② 3211822	50	

Accessories ¹⁾		
D-PT 6	Order No.	Pcs./Pkt.
D-PT 6	3212044	50

Dimensions	[mm]
Maximum electrical data	
Maximum bridge current	[A]
Rated data	
Rated voltage	[V]
Nominal current / cross section	[A] / [mm ²]

Description	Color
Terminal block	gray
Ground terminal	green-yellow

Cover, width: 2.2 mm	Color
Cover, width: 2.2 mm	gray

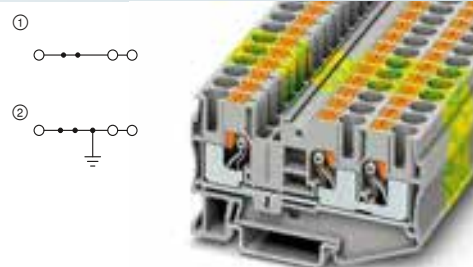

52 A, feed-through terminal block, 3 connections

Ex: EAC Ex IEC CB

 SEV13ATEX0159U / IECEx SEV13.0005U

Technical data ¹⁾			
Width	Length	Height	
8.2	74.2	43.5 (NS 35/7,5)	
I _{max} [A]	U _{max} [V]	max. Ø [mm ²]	AWG (UL)
52	1000	0.5 - 10	20-8
41 (FBS) / 32 (FBSR)			
Rated data	UL / CUL	CSA	Ex
1000	600	600	550
Nominal current / cross section	[A] / [mm ²]	41 / 6	40 / -

Ordering data		
Type	Order No.	Pcs./Pkt.
PT 6-TWIN	① 3211929	50
PT 6-TWIN BU	① 3211485	50
PT 6-TWIN-PE	② 3211498	50

Accessories ¹⁾		
D-PT 6-TWIN	Order No.	Pcs./Pkt.
D-PT 6-TWIN	3211508	50

Feed-through, multi-conductor, multi-level, and ground terminal blocks

Notes:
 1) For additional accessories and technical data, see page 110.
 For information on installation and using accessories for Ex applications, see page 678.

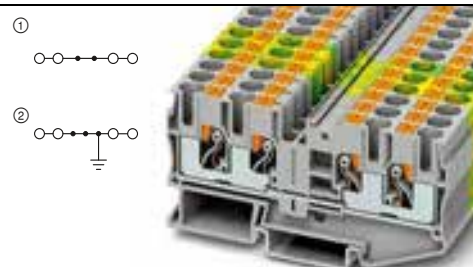

52 A, feed-through terminal block, 4 connections

Ex: EAC Ex IEC CB

 SEV13ATEX0159U / IECEx SEV13.0005U

Technical data ¹⁾			
Width	Length	Height	
8.2	90.5	43.5 (NS 35/7,5)	
I _{max} [A]	U _{max} [V]	max. Ø [mm ²]	AWG (UL)
52	1000	0.5 - 10	20-8
41 (FBS) / 32 (FBSR)			
Rated data	UL / CUL	CSA	Ex
1000	600	600	550
Nominal current / cross section	[A] / [mm ²]	41 / 6	40 / -

Ordering data		
Type	Order No.	Pcs./Pkt.
PT 6-QUATTRO	① 3212934	50
PT 6-QUATTRO BU	① 3212947	50
PT 6-QUATTRO-PE	② 3212950	50

Accessories ¹⁾		
D-PT 6-QUATTRO	Order No.	Pcs./Pkt.
D-PT 6-QUATTRO	3212963	50

Dimensions	[mm]
Maximum electrical data	
Maximum bridge current	[A]
Rated data	
Rated voltage	[V]
Nominal current / cross section	[A] / [mm ²]

Description	Color
Terminal block	gray
Ground terminal	green-yellow

Cover, width: 2.2 mm	Color
Cover, width: 2.2 mm	gray

Terminal blocks – CLIPLINE complete

6 mm² PT Push-in connection terminal blocks

Fuse terminal blocks

Notes:
 1) For additional accessories and technical data, see page 110.
 2) The current is determined by the fuse used, the voltage by the selected LED display. Observe the maximum power dissipation, see phoenixcontact.net/products.

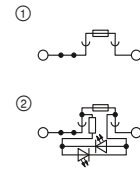

10 A, lever-type fuse terminal block for 6.3 x 32 mm cartridge fuses, 2 function shafts



Dimensions	
	[mm]
Maximum electrical data	
Maximum bridge current	[A]
Rated data	
Rated voltage	[V]
Nominal current / cross section	[A] / [mm ²]

Technical data ¹⁾			
Width	Length	Height	
8.2	74.5	69 (NS 35/7,5)	
I _{max} [A]	U _{max} [V]	max. Ø [mm ²]	AWG (UL)
10 ²⁾	630 ²⁾	0.5 - 10	20-8
30 (FBS) / 30 (FBSR)			
IEC	UL / CUL	CSA	Ex
630 ²⁾	600	600	-
10 / 6	10 / -	10 / -	- / -

Description	Color
Fuse terminal block	black
With LED display 12 ... 30 V AC/DC, 0.31 ... 0.95 mA	black
30 ... 60 V AC/DC, 0.40 ... 0.86 mA	black
110 ... 250 V AC/DC, 0.41 ... 0.96 mA	black

Ordering data			
Type	Order No.	Pcs./Pkt.	
PT 6-HESI (6,3X32)	① 3211870	50	
PT 6-HESILED 24 (6,3X32)	② 3211874	50	
PT 6-HESILED 60 (6,3X32)	② 3211868	50	
PT 6-HESILED 250 (6,3X32)	② 3212133	50	

Fuse terminal blocks

Notes:
 1) For additional accessories and technical data, see page 110.
 You can find a selection of matching thermal TCP circuit breakers in Catalog 4.

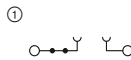

30 A, fuse terminal block for type C flat-type fuses



Technical data ¹⁾			
Width	Length	Height	
8.2	74.1	45.5 (NS 35/7,5)	
I _{max} [A]	U _{max} [V]	max. Ø [mm ²]	AWG (UL)
30	400	0.5 - 10	20-8
30 (FBS) / 30 (FBSR)			
IEC	UL / CUL	CSA	Ex
400	600	600	-
25 / 6	25 / -	25 / -	- / -

Ordering data			
Type	Order No.	Pcs./Pkt.	
PT 6-FSI/C	① 3212166	50	

Description	Color
Fuse terminal block	black
with LED display for 6 - 12 V DC, 0.31 - 0.95 mA	black
for 12 - 30 V DC, 0.31 - 0.95 mA	black
for 24 - 48 V DC, 0.31 - 0.95 mA	black

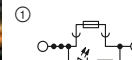

30 A, fuse terminal block with LED display for type C flat-type fuses



Technical data ¹⁾			
Width	Length	Height	
8.2	74.1	45.5 (NS 35/7,5)	
I _{max} [A]	U _{max} [V]	max. Ø [mm ²]	AWG (UL)
30	12	0.5 - 10	20-8
30 (FBS) / 30 (FBSR)			
IEC	UL / CUL	CSA	Ex
12	600	600	-
25 / 6	25 / -	25 / -	- / -

Ordering data			
Type	Order No.	Pcs./Pkt.	
PT 6-FSI/C-LED 12	① 3212169	50	
PT 6-FSI/C-LED 24	① 3212172	50	
PT 6-FSI/C-LED 48	① 3212175	50	

Fuse terminal blocks

Notes:
 1) For additional accessories and technical data, see page 110.

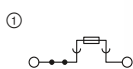

10 A, fuse terminal block for 5 x 20 mm cartridge fuses



Technical data ¹⁾				
Dimensions	Width	Length	Height	
	12.3	77.7	51.2 (NS 35/7,5)	
Maximum electrical data	I_{max} [A]	U_{max} [V]	max. Ø [mm ²]	AWG (UL)
	10	1000	0.5 - 10	20-8
Maximum bridge current	32 (FBS)			
Rated data	IEC	UL / CUL	CSA	Ex
Rated voltage	1000	600	-	-
Nominal current / cross section	10 / 6	10 / -	- / -	- / -

Ordering data		
Type	Order No.	Pcs./Pkt.
PT 6-DREHSI (5X20)	3025042	25



10 A, fuse terminal block for 5 x 20 mm cartridge fuses, with LED



Technical data ¹⁾			
Dimensions	Width	Length	Height
	12.3	77.7	51.2 (NS 35/7,5)
Maximum electrical data	I_{max} [A]	U_{max} [V]	max. Ø [mm ²]
	10	1000	0.5 - 10
Maximum bridge current	30 (FBS)		
Rated data	IEC	UL / CUL	CSA
Rated voltage	1000	600	-
Nominal current / cross section	10 / 6	10 / -	- / -

Ordering data		
Type	Order No.	Pcs./Pkt.
PT 6-DREHSILED 24 (5X20)	3025046	25
PT 6-DREHSILA 250 (5X20)	3025044	25

Disconnect and knife disconnect terminal blocks

Notes:
 1) For additional accessories and technical data, see page 110.

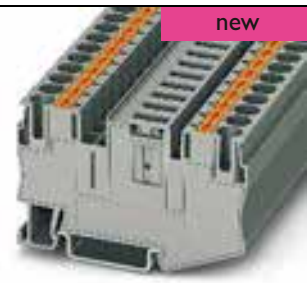
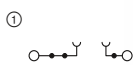

20 A, disconnect terminal block



Technical data ¹⁾				
Dimensions	Width	Length	Height	
	8.2	74.1	45.3 (NS 35/7,5)	
Maximum electrical data	I_{max} [A]	U_{max} [V]	max. Ø [mm ²]	AWG (UL)
	20	500	0.5 - 10	20-8
Maximum bridge current	20 (FBS) / 20 (FBSR)			
Rated data	IEC	UL / CUL	CSA	Ex
Rated voltage	500	600	600	-
Nominal current / cross section	20 / 6	20 / -	20 / -	- / -

Ordering data		
Type	Order No.	Pcs./Pkt.
PT 6-TG	3212163	50

Description	Color
Disconnect terminal block	gray
Knife disconnect terminal block	gray

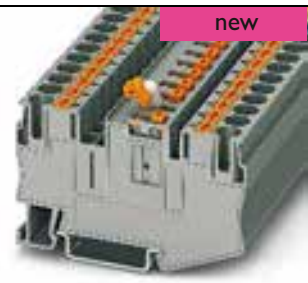
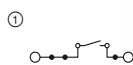

20 A, knife disconnect terminal block



Technical data ¹⁾			
Dimensions	Width	Length	Height
	8.2	74.1	43.7 (NS 35/7,5)
Maximum electrical data	I_{max} [A]	U_{max} [V]	max. Ø [mm ²]
	20	500	0.5 - 10
Maximum bridge current	20 (FBS) / 20 (FBSR)		
Rated data	IEC	UL / CUL	CSA
Rated voltage	500	600	600
Nominal current / cross section	20 / 6	20 / -	20 / -

Ordering data		
Type	Order No.	Pcs./Pkt.
PT 6-MT	3212160	50

Terminal blocks – CLIPLINE complete

6 mm² PT Push-in connection terminal blocks

Disconnect and knife disconnect terminal blocks

Notes:

¹⁾ For additional accessories and technical data, see page 110.

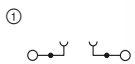

32 A, measurement-disconnect terminal block, with isolating plug

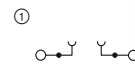

32 A, measurement-disconnect terminal block, with disconnect lever

Dimensions	
	[mm]
Maximum electrical data	
Maximum bridge current	[A]
Rated data	
Rated voltage	[V]
Nominal current / cross section	[A] / [mm ²]
Connection capacity	
1 conductor	[mm ²]
2 flexible conductors with a TWIN ferrule	[mm ²]
Connection cross sections directly plug-in	[mm ²]

Technical data ¹⁾				
Width	Length	Height		
10.2	91	64.3 (NS 35/7,5) / 69.3 (NS 32)		
<i>I</i> _{max.} [A]	<i>U</i> _{max.} [V]	max. Ø [mm ²]	AWG (UL)	
32	1000	0.5 - 10	-	
IEC	UL / CUL	CSA	Ex	
1000	-	-	-	
32 / 6	- / -	- / -	- / -	
Rigid	Flexible	Ferrule without/with plastic sleeve		
0.5 - 10	0.5 - 6	0.5 - 10	0.5 - 10	
-	-	-	0.5 - 2.5	
1 - 10	-	1.5 - 6	1.5 - 6	

Technical data ¹⁾				
Width	Length	Height		
10.2	91	64.3 (NS 35/7,5) / 69.3 (NS 32)		
<i>I</i> _{max.} [A]	<i>U</i> _{max.} [V]	max. Ø [mm ²]	AWG (UL)	
32	1000	0.5 - 10	-	
IEC	UL / CUL	CSA	Ex	
1000	-	-	-	
32 / 6	- / -	- / -	- / -	
Rigid	Flexible	Ferrule without/with plastic sleeve		
0.5 - 10	0.5 - 6	0.5 - 10	0.5 - 10	
-	-	-	0.5 - 2.5	
1 - 10	-	1.5 - 6	1.5 - 6	

Description	Color
Measurement-disconnect terminal block	gray
	gray

Ordering data			
Type	Order No.	Pcs./Pkt.	
PT 6-T P/P HV	1028589	50	

Ordering data			
Type	Order No.	Pcs./Pkt.	
PT 6-MT P/P HV	1028591	50	

Accessories ¹⁾	
Spacer plate, width: 1.8 mm	gray
Isolating plug	gray
Isolating plug, disconnect function only	blue

Accessories ¹⁾			
Type	Order No.	Pcs./Pkt.	
DP-PT 6-T P/P HV-1,8	1028592	10	
P-DI HV	1028594	10	
P-DI-MP HV	1028600	10	

Accessories ¹⁾			
Type	Order No.	Pcs./Pkt.	
DP-PT 6-T P/P HV-1,8	1028592	10	

Diode terminal blocks

Notes:
1) For additional accessories and technical data, see page 110.
2) If the diode is loaded to 5 A, the surface reaches a temperature of +140°C.
3) 1000 V reverse voltage
If several diode terminal blocks need adding to the DIN rail, a spacer plate must be placed between them.

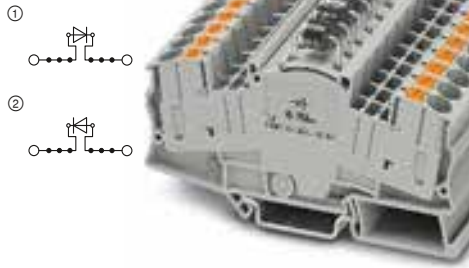

5 A, 1000 V, diode terminal block, same shape



Spacer plate, same shape



Dimensions	
Width	[mm] 8.2
Maximum electrical data	
Maximum bridge current	[A] 30 (FBS) / 30 (FBSR)
Rated data	
Rated voltage	[V] 1000 ³⁾
Nominal current / cross section	[A] / [mm ²] 5 ²⁾ / 6
General data	
Stripping length	[mm] 12
Description	
Terminal block, for conducting direction see circuit diagram	Color gray
Spacer plate	Color gray
Cover, width: 2.2 mm	Color gray

Technical data ¹⁾				
Width	Length	Height		
8.2	100.8	60 (NS 35/7,5)		
I _{max.} [A]	U _{max.} [V]	max. Ø [mm ²]	AWG (UL)	
5 ²⁾	1000 ³⁾	0.5 - 10	20-8	
30 (FBS) / 30 (FBSR)				
IEC	UL / CUL	CSA	Ex	
1000 ³⁾	600	600	-	
5 ²⁾ / 6	10 / -	10 / -	- / -	
Ordering data				
Type	Order No.	Pcs./Pkt.		
PTME 6-DIO/L-R HV	① 3035697	50		
PTME 6-DIO/R-L HV	② 3035698	50		
Accessories ¹⁾				
D-DTME 6	3034426	10		

Technical data ¹⁾				
Width	Length	Height		
8.2	100.8	49.6 (NS 35/7,5)		
		max. Ø [mm ²]	AWG (UL)	
		-	-	
IEC	UL / CUL	CSA	Ex	
-	-	-	-	
-	- / -	- / -	- / -	
Ordering data				
Type	Order No.	Pcs./Pkt.		
DP-STMED 6	3035690	50		
Accessories ¹⁾				

Component terminal blocks for customer-side component soldering

Notes:
1) For additional accessories and technical data, see page 110.

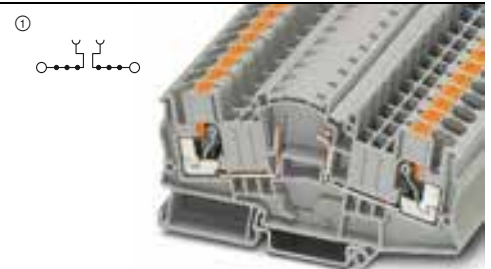

Terminal block, for soldering a component



Dimensions	
Width	[mm] 8.2
Maximum electrical data	
Maximum bridge current	[A] 32
Rated data	
Rated voltage	[V] 500
Nominal current / cross section	[A] / [mm ²] 30 / 6
General data	
Stripping length	[mm] 12
Description	
Terminal block, component can be soldered in	Color gray
Cover, width: 2.2 mm	Color gray

Technical data ¹⁾				
Width	Length	Height		
8.2	100.8	60 (NS 35/7,5)		
	U _{max.} [V]	max. Ø [mm ²]	AWG (UL)	
	500	0.5 - 10	-	
IEC	UL / CUL	CSA	Ex	
500	-	-	-	
30 / 6	- / -	- / -	- / -	
Ordering data				
Type	Order No.	Pcs./Pkt.		
PTME 6-BE	① 3035687	50		
Accessories ¹⁾				
D-DTME 6	3034426	10		

Technical data ¹⁾				
Width	Length	Height		
8.2	100.8	60 (NS 35/7,5)		
	U _{max.} [V]	max. Ø [mm ²]	AWG (UL)	
	500	0.5 - 10	-	
IEC	UL / CUL	CSA	Ex	
500	-	-	-	
30 / 6	- / -	- / -	- / -	
Ordering data				
Type	Order No.	Pcs./Pkt.		
PTME 6-BE	① 3035687	50		
Accessories ¹⁾				
D-DTME 6	3034426	10		

Terminal blocks – CLIPLINE complete

6 mm² PT Push-in connection terminal blocks

Test disconnect terminal blocks

Notes:
1) For additional accessories and technical data, see page 110.
The PTME 6 HV versions have a rated voltage of 1000 V.
For COMBI plug-in test disconnect terminal blocks, see page 348.



30 A, test disconnect terminal block

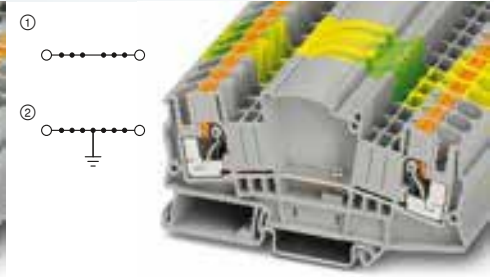

41 A, feed-through terminal block, same shape



Dimensions	
	[mm]
Maximum electrical data	
Maximum bridge current	[A]
Rated data	
Rated voltage	[V]
Nominal current / cross section	[A] / [mm ²]
General data	
Stripping length	[mm]

Technical data ¹⁾				
Width	Length	Height		
8.2	100.8	49.6 (NS 35/7,5)		
I _{max.} [A]	U _{max.} [V]	max. Ø [mm ²]	AWG (UL)	
30	500	0.5 - 10	20-8	
30 (FBS) / 30 (FBSR)				
IEC	UL / CUL	CSA	Ex	
500	600	600	-	
30 / 6	30 / -	30 / -	- / -	
12				

Technical data ¹⁾				
Width	Length	Height		
8.2	100.8	49.6 (NS 35/7,5)		
I _{max.} [A]	U _{max.} [V]	max. Ø [mm ²]	AWG (UL)	
41	1000	0.5 - 10	20-8	
41 (FBS)				
IEC	UL / CUL	CSA	Ex	
1000	600	600	-	
41 / 6	30 / -	30 / -	- / -	
12				

Description	Color
Test disconnect terminal block	gray
	gray
	blue
Feed-through terminal block	gray
Ground terminal	green-yellow

Ordering data			
Type	Order No.	Pcs./Pkt.	
PTME 6	3212170	50	
PTME 6 HV	3035696	50	
PTME 6 HV BU	3035695	50	

Ordering data			
Type	Order No.	Pcs./Pkt.	
PTMED 6	3212183	50	
PTMED 6-PE	3212196	50	

Cover, width: 2.2 mm	gray
----------------------	------

Accessories ¹⁾			
D-DTME 6	Order No.	Pcs./Pkt.	
D-DTME 6	3034426	10	

Accessories ¹⁾			
D-DTME 6	Order No.	Pcs./Pkt.	
D-DTME 6	3034426	10	

Supplementary accessories for PTME 6 test disconnect terminal blocks



- A current transformer measuring circuit can be created using just two PTME 6
- Less space required compared to creating circuits with slide-type terminal blocks
- ① FBS... plug-in bridge for cross connection
- ② 4 mm Ø PAI-4-FIX... test plug adapter
- ③ S-ME 6 switching lock
- ④ SB-ME... bridge bar
- ⑤ C-ME 6/2 operating lever

Description	No. of pos.	Color
Test adapter, for 4-mm-Ø safety test connector, snapped into bridge shaft	1	orange
	1	yellow
	1	green
	1	violet
	1	black
	1	blue
	1	red
	1	gray
	1	brown
	1	white
Switching lock, plug-in		white
Switching bridge, plug-in	2	gray/orange
	3	gray/orange
	4	gray/orange
Operating lever, for actuating test disconnect terminal blocks	1	orange
	2	orange
	3	orange

Ordering data			
Type	Order No.	Pcs./Pkt.	
PAI-4-FIX OG	3034455	10	
PAI-4-FIX YE	3032745	10	
PAI-4-FIX GN	3032758	10	
PAI-4-FIX VT	3032761	10	
PAI-4-FIX BK	3032774	10	
PAI-4-FIX BU	3032729	10	
PAI-4-FIX RD	3032732	10	
PAI-4-FIX GY	3032790	10	
PAI-4-FIX BN	3032787	10	
PAI-4-FIX WH	3032797	10	
S-ME 6	3034439	10	
SB-ME 2-8	3034468	10	
SB-ME 3-8	3032800	10	
SB-ME 4-8	3034484	10	
C-ME 6/1	3034441	10	
C-ME 6/2	3034442	10	
C-ME 6/3	3034390	50	

Hybrid terminal blocks with screw connection on one side, 6 (10) mm²

Notes:

¹⁾ For additional accessories and technical data, see page 110.

²⁾ For screw connection rated data, see page 172.

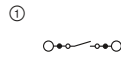

41 A, test disconnect terminal block

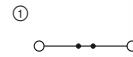

52 A, feed-through terminal block, same shape

ERC

Technical data ¹⁾			
Width	Length	Height	
8.2	73.9	48 (NS 35/7,5)	
I _{max.} [A]	U _{max.} [V]	max. Ø [mm ²]	AWG (UL)
41	500	0.5 - 10	-
IEC	UL / CUL	CSA	Ex
500	-	-	-
Nominal current / cross section	[A] / [mm ²]	- / -	- / -
41 / 6	- / -	- / -	- / -
Stripping length	[mm]	12	

Ordering data		
Type	Order No.	Pcs./Pkt.
PTU 6-T	3209535	50
PTU 6-T-P	3209530	50

Accessories ¹⁾		
D-PTU 6-T	3209533	50
SZS 1,0X4,0 VDE	1205066	10

ERC

Technical data ¹⁾			
Width	Length	Height	
8.2	73.9	48 (NS 35/7,5)	
I _{max.} [A]	U _{max.} [V]	max. Ø [mm ²]	AWG (UL)
52	800	0.5 - 10	-
IEC	UL / CUL	CSA	Ex
800	-	-	-
Nominal current / cross section	[A] / [mm ²]	- / -	- / -
41 / 6	- / -	- / -	- / -
Stripping length	[mm]	12	

Ordering data		
Type	Order No.	Pcs./Pkt.
PTUD 6	3209531	50
PTUD 6-P	3209537	50

Accessories ¹⁾		
D-PTU 6-T	3209533	50
SZS 1,0X4,0 VDE	1205066	10

Dimensions	[mm]
Maximum electrical data	
Rated data ²⁾	
Rated voltage	[V]
Nominal current / cross section	[A] / [mm ²]
General data	
Stripping length	[mm]
Description	Color
Test disconnect terminal block with test sockets	gray
Feed-through terminal block with test sockets	gray
Cover, width: 2.2 mm	gray
Screwdriver	

Supplementary accessories for PTU 6-T test disconnect terminal blocks



- Efficient wiring using Push-in connection on the inside of the control cabinet
- Universal screw connection on the end customer side
- The following accessories are included for transformer short circuit and potential distribution:

- ① KSSI... insulated short-circuit plug
- ② PSBJ 6-T... test socket
- ③ SCBI 10-8,15... isolator bridge bar
- ④ KSS... short-circuit plug

Description	No. of pos.	Color
Insertion bridge, fully insulated	2	gray
	3	gray
	4	gray
	10	gray
Fixed bridge, 10-pos.	10	silver
Isolator bridge bar, 10-pos.	10	silver
Test socket	1	silver
Partition plate, 2 mm width		gray
Short-circuit plug, for short circuiting neighboring terminal blocks, fully insulated, 2-pos.	2	black
Short-circuit plug, for short circuiting neighboring terminal blocks, fully insulated, 2-pos., I _{max.} 20 A	2	black
Test socket, insulated	1	orange

Ordering data		
Type	Order No.	Pcs./Pkt.
EB 2-8	0202154	100
EB 3-8	0202141	100
EB 4-8	0202142	100
EB 10-8	0202138	10
SCBI 10-8,15	3245134	10
SCBI 10-8,15 ISO	3000417	10
TPS 3/20/5	3246586	10
ATP-URTK/SP	0311139	10
KSSI 2-8	3000722	10
KSS 8	0311540	10
PSBJ 6-T OG	3070320	10

Terminal blocks – CLIPLINE complete

6 mm² PT Push-in connection terminal blocks

Installation terminal blocks

Notes:

¹⁾ For additional accessories and technical data, see page 110.

Assembly instruction:

In order to securely fix the neutral busbar in place, support brackets must be placed at the beginning and end of each terminal strip as well as every 20 cm on longer terminal strips. The corresponding support brackets can be found at phoenixcontact.net/products

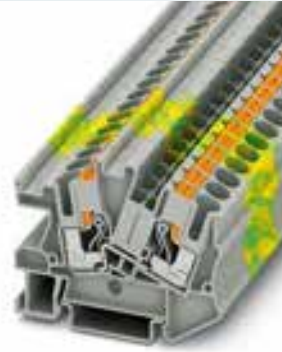
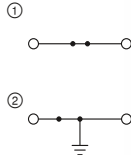

51 A, feed-through terminal block

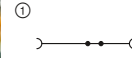

51 A, neutral disconnect terminal block



Technical data ¹⁾			
Dimensions	Width	Length	Height
	8.2	66	50 (NS 35/7,5)
Maximum electrical data	I_{max} [A]	U_{max} [V]	max. \emptyset [mm ²] AWG (UL)
	51	800	0.5 - 10
Rated data	41 (FBS) / 32 (FBSR)		
Maximum bridge current [A]	IEC	UL / CUL	CSA Ex
Rated voltage [V]	800	-	-
Nominal current / cross section [A] / [mm ²]	41 / 6	- / -	- / -
Connection capacity	Rigid	Flexible	Ferrule without/with plastic sleeve
2 conductors (of the same type) [mm ²]	-	-	-
General data	Stripping length [mm]		
	12		

Ordering data			
Type	Order No.	Pcs./Pkt.	
PTI 6	3213972	50	
PTI 6 BU	3213973	50	
PTI 6-PE	3213966	50	

Accessories ¹⁾		
Type	Order No.	Pcs./Pkt.
D-PTI 6	1016703	50
AB-PTI 6	3214008	50



Technical data ¹⁾			
Dimensions	Width	Length	Height
	8.2	66.3	50 (NS 35/7,5)
Maximum electrical data	I_{max} [A]	U_{max} [V]	max. \emptyset [mm ²] AWG (UL)
	51	400	0.5 - 10
Rated data	41 (FBS) / 32 (FBSR)		
Maximum bridge current [A]	IEC	UL / CUL	CSA Ex
Rated voltage [V]	400	-	-
Nominal current / cross section [A] / [mm ²]	41 / 6	- / -	- / -
Connection capacity	Rigid	Flexible	Ferrule without/with plastic sleeve
2 conductors (of the same type) [mm ²]	0.5 - 4	-	-
General data	Stripping length [mm]		
	12		

Ordering data		
Type	Order No.	Pcs./Pkt.
PTN 6	3213967	50

Accessories ¹⁾		
Type	Order No.	Pcs./Pkt.
D-PTN 6	3213979	50
AB-PTI 6	3214008	50

Description	Color
Terminal block	gray blue
Ground terminal	green-yellow
Neutral disconnect terminal block	blue

Cover, width: 2.2 mm	gray
Support bracket, to hold the neutral busbar, set every 20 cm, 2 mm wide	blue

Pick-off terminal blocks

new

new

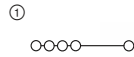

Notes:
 1) For additional accessories and technical data, see page 110.



38 A, pick-off terminal block, 4-pos.



38 A, pick-off terminal block, 8-pos.



Technical data ¹⁾				
Dimensions	Width	Length	Height	
	31	57.4	32.3	
Maximum electrical data	I_{max} [A]	U_{max} [V]	max. Ø [mm ²]	AWG (UL)
	57	1000	0.5 - 10	-
Rated data	IEC	UL / CUL	CSA	Ex
Rated voltage [V]	1000	1000	-	-
Nominal current / cross section [A] / [mm ²]	41 / 6	- / -	- / -	- / -

Ordering data			
Description	Type	Order No.	Pcs./Pkt.
Pick-off terminal block, M10 drill hole	AGK PT 4X6/M10	1017448	10
	AGK PT 4X6/M10 BU	1083237	10
	AGK PT 4X6/M10 GNYE	1083238	10
M12 drill hole	AGK PT 4X6/M12	1017454	10



Technical data ¹⁾				
Dimensions	Width	Length	Height	
	31	72.6	32.3	
Maximum electrical data	I_{max} [A]	U_{max} [V]	max. Ø [mm ²]	AWG (UL)
	57	1000	0.5 - 10	-
Rated data	IEC	UL / CUL	CSA	Ex
Rated voltage [V]	1000	1000	-	-
Nominal current / cross section [A] / [mm ²]	41 / 6	- / -	- / -	- / -

Ordering data			
Description	Type	Order No.	Pcs./Pkt.
Pick-off terminal block, M10 drill hole	AGK PT 8X6/M10	1017450	10
	AGK PT 8X6/M10 BU	1083235	10
	AGK PT 8X6/M10 GNYE	1083236	10

Terminal blocks – CLIPLINE complete

10 mm² PT Push-in connection terminal blocks

General technical data

Rated data		IEC 60947-7-1 / IEC 60947-7-2 / IEC 60947-7-3			
Rated cross section	[mm ²]	10			
Cross section range	AWG	20 - 6			
Connection capacity		Rigid	Flexible	Ferrule without/with plastic sleeve	
1 conductor	[mm ²]	0.5 - 16	0.5 - 10	0.5 - 10	0.5 - 10
2 flexible conductors with a TWIN ferrule	[mm ²]	-	-	-	1.5 - 4
Connection cross sections directly plug-in	[mm ²]	1 - 16	-	4 - 10	2.5 - 10
General data					
Stripping length	[mm]	18			
Insulating material		PA			
Flammability rating in accordance with UL 94		V0			

Note: Additional or deviating data is listed alongside the respective product.

Notes:



In addition to the product, the internal electrical wiring is provided as a circuit diagram. Free connection points for bridging are indicated by a black dot.

The specified technical data and approvals refer to the first product in each column. For information on the products below, please refer to phoenixcontact.net/products

For full details of UL and CSA use groups, file nos., and Internet links, please visit phoenixcontact.net/products

¹⁾ The bridge current is listed alongside the respective product. For additional colors, see page 402.

System accessories

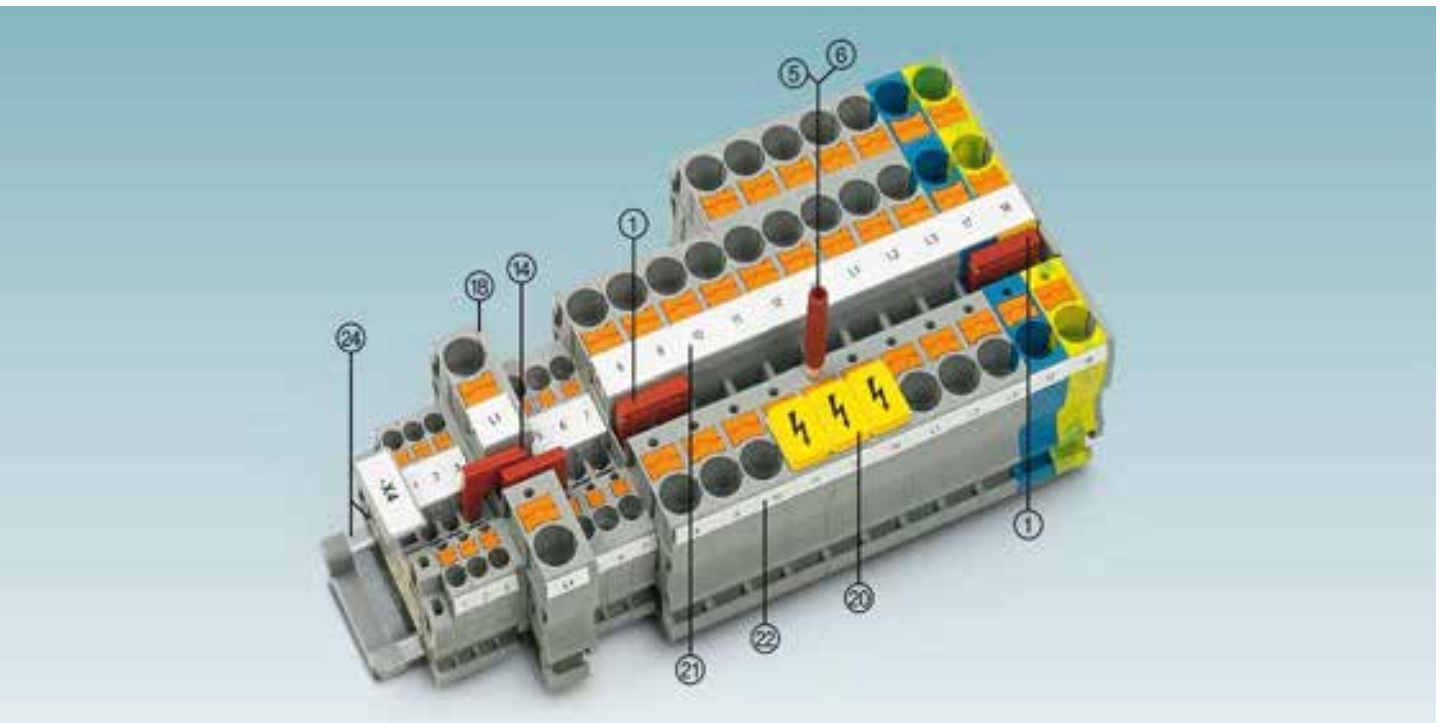

Description	No. of pos.	Color	Type	Order No.	Pcs./Pkt.	Type	Order No.	Pcs./Pkt.
① Bridge ¹⁾	2	red	FBS 2-10	3005947	10			
	5	red	FBS 5-10	3005948	10			
⑤ Test plug metal part		gray	MPS-MT	0201744	10			
⑥ Insulating sleeve, for MPS metal part		red	MPS-IH RD	0201676	10			
Screwdriver			SZF 3-1.0X5,5	1206612	10			

④ Reducing bridge
⑧ Cover
⑩ Warning labels
⑫ Center groove labeling
⑬ Center and side groove labeling
⑭ DIN rail and end bracket
For full accessories, visit phoenixcontact.net/products

For RB ..., see page 408.
Listed alongside the respective product.
WS
UC-TM 10, UCT-TM 10 or ZB 10. See also Catalog 3, selection tables, from page 60.
UC-TMF 10, UCT-TMF 10 or ZBF 10. See also Catalog 3, selection tables, from page 60.
See Catalog 3
Note: Additional or deviating accessories are listed alongside the respective product.

Feed-through, multi-conductor, and ground terminal blocks

Notes:
 1) For additional accessories and technical data, see page 120.
 For information on installation and using accessories for Ex applications, see page 678.

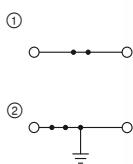

70 A, feed-through terminal block

UL, IEC, EAC, ClassNK, CB
 Ex: IEC, EAC, IEC, IEC
 SEV13ATEX0159U / IECEx SEV13.0005U

Technical data ¹⁾			
Width	Length	Height	
10.2	67.7	50.5 (NS 35/7,5)	
I _{max} [A]	U _{max} [V]	max. Ø [mm ²]	AWG (UL)
70	1000	0.5 - 16	20-6
Maximum bridge current	57		
Rated data	IEC	UL / CUL	CSA Ex
Rated voltage	1000	600	600 550
Nominal current / cross section	57 / 10	60 / -	55 / - 52.5 / 10

Ordering data			
Type	Order No.	Pcs./Pkt.	
PT 10	① 3212120	50	
PT 10 BU	① 3212123	50	
PT 10-PE	② 3212131	50	

Accessories ¹⁾		
D-PT 10	3212057	50

Dimensions	[mm]
Maximum electrical data	
Maximum bridge current	[A]
Rated data	
Rated voltage	[V]
Nominal current / cross section	[A] / [mm ²]
Description	Color
Terminal block	gray
	blue
Ground terminal	green-yellow
Cover, width: 2.2 mm	gray

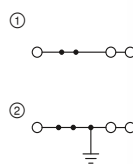

70 A, feed-through terminal block, 3 connections

UL, IEC, EAC, ClassNK, CB
 Ex: IEC, EAC, IEC, IEC
 SEV13ATEX0159U / IECEx SEV13.0005U

Technical data ¹⁾			
Width	Length	Height	
10.2	88.9	50.5 (NS 35/7,5)	
I _{max} [A]	U _{max} [V]	max. Ø [mm ²]	AWG (UL)
70	1000	0.5 - 16	20-6
Maximum bridge current	57		
Rated data	IEC	UL / CUL	CSA Ex
Rated voltage	1000	600	600 550
Nominal current / cross section	57 / 10	60 / -	55 / - 48.5 / 10

Ordering data		
Type	Order No.	Pcs./Pkt.
PT 10-TWIN	① 3208746	50
PT 10-TWIN BU	① 3208747	50
PT 10-TWIN-PE	② 3208745	50

Accessories ¹⁾		
D-PT 10-TWIN	3208748	50

PT 10,3–HESI 1000V lever-type fuse terminal blocks for photovoltaics

Notes:
 1) For additional accessories and technical data, see page 120.
 For tools for stripping and crimping solar cables and connectors, see Catalog 3.
 For disconnect terminal blocks with 1000 V and PTME ... HV diode terminal blocks, see from page 116.
 For detailed information on PV applications and power dissipation data, see phoenixcontact.net/products
 For matching fuse inserts, refer to page 503.
 For further fuse inserts with UL approval, see phoenixcontact.net/products

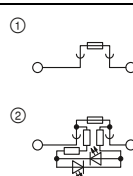

20 A, 1000 V, lever-type fuse terminal block for 10.3 x 38 mm midjet fuses

ERIC

Dimensions	[mm]
Maximum electrical data	
Rated data	
Rated voltage	[V]
Nominal current / cross section	[A] / [mm ²]
Cross section range	AWG
Connection capacity	
1 conductor	[mm ²]
Connection cross sections directly plug-in	[mm ²]

Description	Color
Fuse terminal block	black
with LED for 400 - 1000 V DC	black

Spacer for neighboring fuse terminal block	white
--	-------

Technical data ¹⁾			
Width	Length	Height	
17.6	87	63 (NS 35/7,5)	
I _{max} [A]	U _{max} [V]	max. Ø [mm ²]	AWG (UL)
20	1000	1.5 - 10	-
Rated data	IEC	UL / CUL	CSA Ex
Rated voltage	1000	-	-
Nominal current / cross section	20 / 10	- / -	- / - - / -
Cross section range	16 - 6	-	-
Connection capacity	Rigid	Flexible	Ferrule without/with plastic sleeve
1 conductor	1.5 - 10	1.5 - 10	1.5 - 10 1.5 - 10
Connection cross sections directly plug-in	1.5 - 10	-	4 - 10 2.5 - 10

Ordering data		
Type	Order No.	Pcs./Pkt.
PT 10,3-HESI 1000V	① 3062142	10
PT 10,3-HESILED 1000V	② 3062143	10

Accessories ¹⁾		
DP-PT 10,3-HESI	3062155	200

Terminal blocks – CLIPLINE complete

10 mm² PT Push-in connection terminal blocks

Potential collective terminal blocks

new

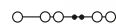

**57 A, potential collective terminal block,
2 inputs 10 mm², 9 inputs 4 mm²**

		Technical data				
Dimensions		Width	Length	Height NS 35/7,5		
		18.5	83.2	47.9		
Maximum electrical data		I_{max} [A]	U_{max} [V]	max. \varnothing [mm ²]	AWG (UL)	
		57	800	0.5 - 16	-	
Rated data, Push-in connection, 10 mm²		IEC 60947-7-1				
		IEC	UL / CUL	CSA	IEC/EN 60079-7	
Rated voltage	[V]	800	-	-	-	
Nominal current / cross section	[A] / [mm ²]	57 / 10	-	-	-	
Cross section range	AWG	20 - 6	-	-	-	
Connection capacity, Push-in connection, 10 mm²		Rigid	Flexible	Ferrule without/with plastic sleeve		
1 conductor	[mm ²]	0.5 - 16	0.5 - 10	0.5 - 10	0.5 - 10	
2 flexible conductors with a TWIN ferrule	[mm ²]	-	-	-	1.5 - 4	
Rated data, 9 Push-in connections, 4 mm²		IEC	UL / CUL	CSA	IEC/EN 60079-7	
Nominal current / cross section	[A] / [mm ²]	32 / 4	-	-	-	
Cross section range	AWG	24 - 10	-	-	-	
Connection capacity, 9 Push-in connections, 4 mm²		Rigid	Flexible	Ferrule without/with plastic sleeve		
1 conductor	[mm ²]	0.2 - 6	0.2 - 4	0.25 - 4	0.25 - 4	
Connection cross sections directly plug-in	[mm ²]	0.5 - 6	-	0.5 - 4	0.5 - 4	
General data						
Stripping length	[mm]	18				
Insulating material		PA				
Flammability rating in accordance with UL 94		PA 6.6				
		Ordering data				
Description	No. of pos.	Color	Type	I_{max}	Order No.	Pcs./Pkt.
Terminal block		gray blue	PT 2X10/9X4		3002369	50
		Accessories				
Plug-in bridge	2	red	FBS 2-6	32 A	3030336	50

new

○—○—○—○—○



**57 A, potential collective terminal block,
2 inputs 10 mm², 9 inputs 4 mm²**

Technical data

Width	Length	Height NS 35/7,5	
18.5	83.2	47.9	
I_{max} [A]	U_{max} [V]	max. Ø [mm ²]	AWG (UL)
57	800	0.5 - 16	-
IEC 60947-7-1			
IEC	UL / CUL	CSA	IEC/ EN 60079-7
800	-	-	-
57 / 10	-	-	-
20 - 6	-	-	-
Rigid	Flexible	Ferrule without/with plastic sleeve	
0.5 - 16	0.5 - 10	0.5 - 10	0.5 - 10
-	-	-	1.5 - 4
IEC	UL / CUL	CSA	IEC/ EN 60079-7
32 / 4	-	-	-
24 - 10	-	-	-
Rigid	Flexible	Ferrule without/with plastic sleeve	
0.2 - 6	0.2 - 4	0.25 - 4	0.25 - 4
0.5 - 6	-	0.5 - 4	0.5 - 4

18
PA
PA 6.6

Ordering data

Type	I_{max}	Order No.	Pcs./Pkt.
PT 2X10/9X4 BU		3002368	50

Accessories

FBS 2-6	32 A	3030336	50
---------	------	---------	----

Terminal blocks – CLIPLINE complete

16 mm² PT Push-in connection terminal blocks

General technical data

Rated data		IEC 60947-7-1 / IEC 60947-7-2			
Rated cross section	[mm ²]	16			
Cross section range	AWG	20 - 4			
Connection capacity		Rigid	Flexible	Ferrule without/with plastic sleeve	
1 conductor	[mm ²]	0.5 - 25	0.5 - 16	0.5 - 16	0.5 - 16
2 flexible conductors with a TWIN ferrule	[mm ²]	-	-	-	1.5 - 4
Connection cross sections directly plug-in	[mm ²]	2.5 - 25	-	2.5 - 16	2.5 - 16
General data					
Stripping length	[mm]	18			
Insulating material		PA			
Flammability rating in accordance with UL 94		V0			

Note: Additional or deviating data is listed alongside the respective product.

Notes:



In addition to the product, the internal electrical wiring is provided as a circuit diagram. Free connection points for bridging are indicated by a black dot.

The specified technical data and approvals refer to the first product in each column. For information on the products below, please refer to phoenixcontact.net/products

For full details of UL and CSA use groups, file nos., and Internet links, please visit phoenixcontact.net/products

¹⁾ The bridge current is listed alongside the respective product. For additional colors, see page 402.

System accessories

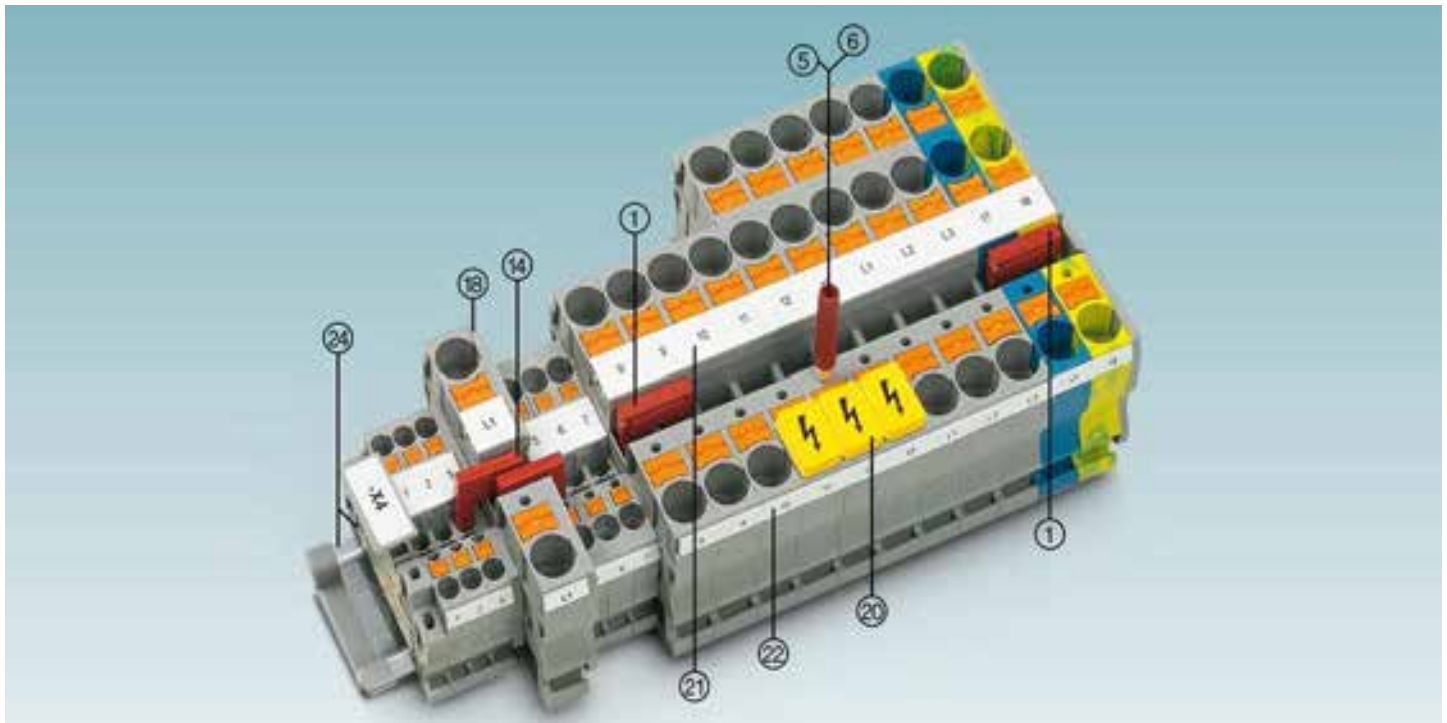

Description	No. of pos.	Color	Type	Order No.	Pcs./Pkt.	Type	Order No.	Pcs./Pkt.
① Bridge ¹⁾	2	red	FBS 2-12	3005950	10			
⑤ Test plug metal part		gray	MPS-MT	0201744	10			
⑥ Insulating sleeve, for MPS metal part		red	MPS-IH RD	0201676	10			
Screwdriver			SZF 3-1,0X5,5	1206612	10			
⑭ Reducing bridge			For RB ..., see page 408.					
⑮ Cover			Listed alongside the respective product.					
⑳ Warning labels			For WS ..., see page 420.					
㉑ Center groove labeling			UC-TM 12, UCT-TM 12 or ZB 12. See also Catalog 3, selection tables, from page 60.					
㉒ Center and side groove labeling			UC-TMF 12, UCT-TMF 12 or ZBF 12. See also Catalog 3, selection tables, from page 60.					
㉓ DIN rail and end bracket			See Catalog 3					
For full accessories, visit phoenixcontact.net/products			Note: Additional or deviating accessories are listed alongside the respective product.					

Feed-through, multi-conductor, and ground terminal blocks

Notes:
 1) For additional accessories and technical data, see page 124.
 For information on installation and using accessories for Ex applications, see page 678.

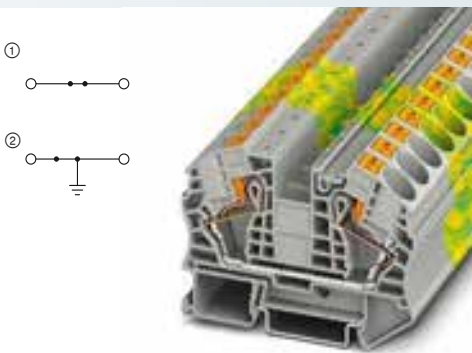

85 A, feed-through terminal block

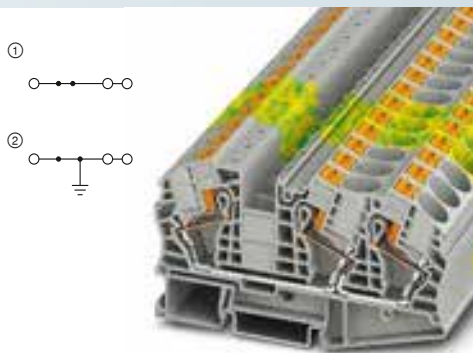

85 A, feed-through terminal block, 3 connections



Ex: EAC Ex IEC Ex
 SEV13ATEX0159U / IECEx SEV13.0005U

Technical data¹⁾

Dimensions	Width	Length	Height
	12.2	75.4	52.6 (NS 35/7,5)
Maximum electrical data	I_{max} [A]	U_{max} [V]	max. \varnothing [mm ²] AWG (UL)
	85	1000	0.5 - 25 20-4
Maximum bridge current	76		
Rated data	IEC	UL / CUL	CSA Ex
Rated voltage	1000	600	600 550
Nominal current / cross section	76 / 16	85 / -	70 / - 65.5 / 16

Ordering data

Type	Order No.	Pcs./Pkt.
PT 16 N	3212138	50
PT 16 N BU	3212142	50
PT 16 N-PE	3212147	50

Accessories¹⁾

D-PT 16 N	3212060	50
-----------	---------	----



Ex: EAC Ex IEC Ex
 SEV13ATEX0159U / IECEx SEV13.0005U

Technical data¹⁾

Dimensions	Width	Length	Height
	12.2	100.2	52.6 (NS 35/7,5)
Maximum electrical data	I_{max} [A]	U_{max} [V]	max. \varnothing [mm ²] AWG (UL)
	85	1000	0.5 - 25 20-4
Maximum bridge current	76		
Rated data	IEC	UL / CUL	CSA Ex
Rated voltage	1000	600	600 550
Nominal current / cross section	76 / 16	85 / -	70 / - 65.5 / 16

Ordering data

Type	Order No.	Pcs./Pkt.
PT 16-TWIN N	3208760	25
PT 16-TWIN N BU	3208773	25
PT 16-TWIN N-PE	3208786	25

Accessories¹⁾

D-PT 16-TWIN N	3208799	50
----------------	---------	----

Description	Color
Terminal block	gray blue
Ground terminal	green-yellow
Cover, width: 2.2 mm	gray

Terminal blocks – CLIPLINE complete

16 mm² PT Push-in connection terminal blocks

Installation terminal blocks

Notes:

1) For additional accessories and technical data, see page 124.

Assembly instruction:

In order to securely fix the neutral busbar in place, support brackets must be placed at the beginning and end of each terminal strip as well as every 20 cm on longer terminal strips. The corresponding support brackets can be found at phoenixcontact.net/products

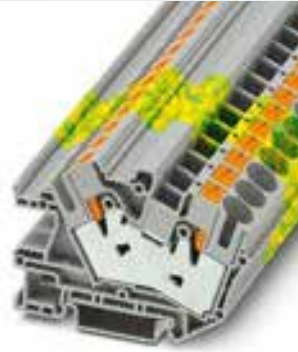
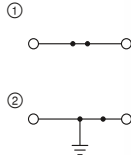

76 A, feed-through terminal block

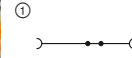

68 A, neutral disconnect terminal block



		Technical data ¹⁾			
Dimensions		Width	Length	Height	
	[mm]	10.2	77.7	51.1 (NS 35/7,5)	
Maximum electrical data		I_{max} [A]	U_{max} [V]	max. \emptyset [mm ²]	AWG (UL)
		76	500	0.5 - 16	24-4
Maximum bridge current	[A]	57			
Rated data		IEC	UL / CUL	CSA	Ex
Rated voltage	[V]	500	600	600	-
Nominal current / cross section	[A] / [mm ²]	76 / 10	10 / -	10 / -	- / -
Rated cross section	[mm ²]	10			
Cross section range	AWG	24 - 4			
Connection capacity		Rigid	Flexible	Ferrule without/with plastic sleeve	
1 conductor	[mm ²]	0.5 - 16	0.5 - 16	0.5 - 16	0.5 - 16
Connection cross sections directly plug-in	[mm ²]	1 - 16	-	4 - 16	2.5 - 16

		Technical data ¹⁾			
Dimensions		Width	Length	Height	
	[mm]	10.2	77.7	51.1 (NS 35/7,5)	
Maximum electrical data		I_{max} [A]	U_{max} [V]	max. \emptyset [mm ²]	AWG (UL)
		68	500	0.5 - 16	24-4
Maximum bridge current	[A]	57			
Rated data		IEC	UL / CUL	CSA	Ex
Rated voltage	[V]	500	600	600	-
Nominal current / cross section	[A] / [mm ²]	68 / 10	10 / -	10 / -	- / -
Rated cross section	[mm ²]	10			
Cross section range	AWG	24 - 4			
Connection capacity		Rigid	Flexible	Ferrule without/with plastic sleeve	
1 conductor	[mm ²]	0.5 - 16	0.5 - 16	0.5 - 16	0.5 - 16
Connection cross sections directly plug-in	[mm ²]	1 - 16	-	4 - 16	2.5 - 16

Description	No. of pos.	Color
Terminal block		gray
		blue
Ground terminal		green-yellow
Neutral disconnect terminal block		blue

Ordering data		
Type	Order No.	Pcs./Pkt.
PTI 16/S	① 3214029	50
PTI 16/S BU	① 3214023	50
PTI 16/S-PE	② 3214024	50

Ordering data		
Type	Order No.	Pcs./Pkt.
PTN 16/S	① 3214025	50

Cover, width: 2.2 mm		gray
Support bracket, to hold the neutral busbar, set every 20 cm, 2.2 mm wide		blue
Plug-in bridge	2	red
	5	red

Accessories ¹⁾		
Type	Order No.	Pcs./Pkt.
D-PTI 16/S	3214027	50
AB-PTI 16/S	3214022	50
FBS 2-10	3005947	10
FBS 5-10	3005948	10

Accessories ¹⁾		
Type	Order No.	Pcs./Pkt.
D-PTN 16/S	3214028	50
AB-PTI 16/S	3214022	50
FBS 2-10	3005947	10
FBS 5-10	3005948	10

Center and side groove labeling

UC-TM 10, UCT-TM 10 or ZB 10 (see Catalog 3)

UC-TM 10, UCT-TM 10 or ZB 10 (see Catalog 3)

Feed-in terminal blocks for N busbars

new

new

Notes:
 1) For additional accessories and technical data, see page 124.



76 A, power terminal block



Support bracket

ERC

Technical data¹⁾

Width	Length	Height	
12.2	81.9	48.5 (NS 35/7,5)	
I _{max.} [A]	U _{max.} [V]	max. Ø [mm ²] AWG (UL)	
76	1000	0.5 - 25 -	
IEC	UL / CUL	CSA	Ex
1000	-	-	-
Nominal current / cross section [A] / [mm ²]	70 / 16	- / -	- / -
General data			
Stripping length [mm]	18 - 20		

Technical data¹⁾

Width	Length	Height	
12.2	81.9	48.5 (NS 35/7,5)	
		max. Ø [mm ²] AWG (UL)	
		-	
IEC	UL / CUL	CSA	Ex
-	-	-	-
-	- / -	- / -	- / -

Ordering data

Type	Order No.	Pcs./Pkt.
PTI 16-NLS-FI	1030130	10
PTI 16-NLS-FI BU	1030131	10
PTI 16-NLS-FI RD	1030132	10
PTI 16-NLS-FI-FE	1030135	10

Ordering data

Type	Order No.	Pcs./Pkt.

Accessories¹⁾

Type	Order No.	Pcs./Pkt.

Accessories¹⁾

Type	Order No.	Pcs./Pkt.
AB-PTI 16-NLS	1030137	10
AB-PTI 16-NLS BU	1030138	10
AB-PTI 16-NLS RD	1030140	10
AB-PTI 16-NLS-FE	1030141	10

UC-TM 10, UCT-TM 10 or ZB 10 (see Catalog 3)

UC-TM 10, UCT-TM 10 or ZB 10 (see Catalog 3)

Description	Color
Terminal block	gray blue red black/yellow
Support bracket	gray blue red black/yellow
Center groove labeling	

35 mm² PTU hybrid terminal block

Hybrid terminal blocks with screw connection on one side



- Simple potential collection or distribution
- Compact, space-saving design
- Can be bridged with standard plug-in bridges
- Easy to test with 2.3 mm standard test connection
- Large-surface marking options

Notes:

In the end application, the applicable safety regulations for overload and short-circuit protection on the connected conductors must be considered.

1...4 1...6



**105 A, potential collective terminal block,
4 inputs 6 mm², 6 inputs 2.5 mm²**



Technical data

Dimensions		Width	Length	Height NS 35/7,5	
		16.3	110.4	48.8	
Maximum electrical data		I_{max} [A]	U_{max} [V]	max. \varnothing [mm ²]	AWG (UL)
		105	1000	1.5 - 50	14-2
Rated data, screw connection					
IEC 60947-7-1					
		IEC	UL / CUL	CSA	IEC/ EN 60079-7
Rated voltage	[V]	1000	-	-	-
Nominal current / cross section	[A] / [mm ²]	105	-	-	-
Cross section range	AWG	16 - 1/0	14-2	14-2	-
Connection capacity screw connection					
		Rigid	Flexible	Ferrule without/with plastic sleeve	
1 conductor	[mm ²]	1.5 - 50	1.5 - 50	1.5 - 35	1.5 - 35
2 conductors (of the same type)	[mm ²]	1.5 - 16	1.5 - 10	1.5 - 10	-
Rated data, 4 Push-in connections, 6 mm ²					
		IEC	UL / CUL	CSA	IEC/ EN 60079-7
Nominal current / cross section	[A] / [mm ²]	41 / 6	-	-	-
Cross section range	AWG	20 - 8	14-2	14-2	-
Connection capacity, 4 Push-in connections, 6 mm ²					
		Rigid	Flexible	Ferrule without/with plastic sleeve	
1 conductor	[mm ²]	0.5 - 10	0.5 - 6	0.5 - 6	0.5 - 6
Connection cross sections directly plug-in	[mm ²]	1 - 10	-	1 - 6	1 - 6
Rated data, 6 Push-in connections, 2.5 mm ²					
		IEC	UL / CUL	CSA	IEC/ EN 60079-7
Nominal current / cross section	[A] / [mm ²]	24 / 2.5	-	-	-
Cross section range	AWG	26 - 12	-	-	-
Connection capacity, 6 Push-in connections, 2.5 mm ²					
		Rigid	Flexible	Ferrule without/with plastic sleeve	
1 conductor	[mm ²]	0.14 - 4	0.14 - 2.5	0.14 - 2.5	0.14 - 2.5
Connection cross sections directly plug-in	[mm ²]	0.34 - 4	-	0.34 - 2.5	0.34 - 2.5
General data					
Stripping length	[mm]	18			
Screw thread		M6			
Tightening torque	[Nm]	3.2 - 3.7			
Insulating material		PA			
Flammability rating in accordance with UL 94		V0			

Ordering data

Description	No. of pos.	Color	Type	I_{max}	Order No.	Pcs./Pkt.
Terminal block		gray blue black/yellow	PTU 35/4X6/6X2,5		3214080	20

Accessories

Pick-off terminal block, for snapping into the lateral guide		gray	AGK 4-UT 35		3047138	50
Plug-in bridge	2	red	FBS 2-8	41 A	3030284	10
	3	red	FBS 3-8	41 A	3030297	10
	4	red	FBS 4-8	41 A	3030307	10
	5	red	FBS 5-8	41 A	3030310	10
	10	red	FBS 10-8	41 A	3030323	10
Test plug metal part, 2.3 mm \varnothing		gray	MPS-MT		0201744	10
Insulating sleeve, for MPS metal part		red	MPS-IH RD		0201676	10
Modular test plug, for the individual assembly of test pin strips		red	PS-6		3030996	10

Screwdriver

Center and side groove labeling

SZF 3-1,0X5,5

UC-TM 16, UCT-TM 16 or ZB 16,3
(see Catalog 3)

1...4 1...6
○-○-○-○-○-○105 A, potential collective terminal block,
4 inputs 6 mm², 6 inputs 2.5 mm²1...4 1...6
○-○-○-○-○-○105 A, potential collective terminal block,
4 inputs 6 mm², 6 inputs 2.5 mm²

Technical data			
Width	Length	Height NS 35/7,5	
16.3	110.4	48.8	
I_{max} [A]	U_{max} [V]	max. Ø [mm ²]	AWG (UL)
105	1000	1.5 - 50	14-2
IEC 60947-7-1			
IEC	UL / CUL	CSA	IEC/ EN 60079-7
1000	-	-	-
105	-	-	-
16 - 1/0	14-2	14-2	-
Rigid	Flexible	Ferrule without/with plastic sleeve	
1.5 - 50	1.5 - 50	1.5 - 35	1.5 - 35
1.5 - 16	1.5 - 10	1.5 - 10	-
IEC	UL / CUL	CSA	IEC/ EN 60079-7
41 / 6	-	-	-
20 - 8	14-2	14-2	-
Rigid	Flexible	Ferrule without/with plastic sleeve	
0.5 - 10	0.5 - 6	0.5 - 6	0.5 - 6
1 - 10	-	1 - 6	1 - 6
IEC	UL / CUL	CSA	IEC/ EN 60079-7
24 / 2.5	-	-	-
26 - 12	-	-	-
Rigid	Flexible	Ferrule without/with plastic sleeve	
0.14 - 4	0.14 - 2.5	0.14 - 2.5	0.14 - 2.5
0.34 - 4	-	0.34 - 2.5	0.34 - 2.5
18			
M6			
3.2 - 3.7			
PA			
V0			

Technical data			
Width	Length	Height NS 35/7,5	
16.3	110.4	48.8	
I_{max} [A]	U_{max} [V]	max. Ø [mm ²]	AWG (UL)
105	1000	1.5 - 50	14-2
IEC 60947-7-1			
IEC	UL / CUL	CSA	IEC/ EN 60079-7
1000	-	-	-
105	-	-	-
16 - 1/0	14-2	14-2	-
Rigid	Flexible	Ferrule without/with plastic sleeve	
1.5 - 50	1.5 - 50	1.5 - 35	1.5 - 35
1.5 - 16	1.5 - 10	1.5 - 10	-
IEC	UL / CUL	CSA	IEC/ EN 60079-7
41 / 6	-	-	-
20 - 8	14-2	14-2	-
Rigid	Flexible	Ferrule without/with plastic sleeve	
0.5 - 10	0.5 - 6	0.5 - 6	0.5 - 6
1 - 10	-	1 - 6	1 - 6
IEC	UL / CUL	CSA	IEC/ EN 60079-7
24 / 2.5	-	-	-
26 - 12	-	-	-
Rigid	Flexible	Ferrule without/with plastic sleeve	
0.14 - 4	0.14 - 2.5	0.14 - 2.5	0.14 - 2.5
0.34 - 4	-	0.34 - 2.5	0.34 - 2.5
18			
M6			
3.2 - 3.7			
PA			
V0			

Ordering data			
Type	I_{max}	Order No.	Pcs./Pkt.
PTU 35/4X6/6X2,5 BU		3214081	20

Ordering data			
Type	I_{max}	Order No.	Pcs./Pkt.
PTU 35/4X6/6X2,5-FE		3214082	20

Accessories			
AGK 4-UT 35		3047138	50
FBS 2-8	41 A	3030284	10
FBS 3-8	41 A	3030297	10
FBS 4-8	41 A	3030307	10
FBS 5-8	41 A	3030310	10
FBS 10-8	41 A	3030323	10
MPS-MT		0201744	10
MPS-IH RD		0201676	10
PS-6		3030996	10
SZF 3-1,0X5,5		1206612	10

Accessories			
AGK 4-UT 35		3047138	50
FBS 2-8	41 A	3030284	10
FBS 3-8	41 A	3030297	10
FBS 4-8	41 A	3030307	10
FBS 5-8	41 A	3030310	10
FBS 10-8	41 A	3030323	10
MPS-MT		0201744	10
MPS-IH RD		0201676	10
PS-6		3030996	10
SZF 3-1,0X5,5		1206612	10

UC-TM 16, UCT-TM 16 or ZB 16,3
(see Catalog 3)UC-TM 16, UCT-TM 16 or ZB 16,3
(see Catalog 3)

Terminal blocks – CLIPLINE complete

35 mm² PTU hybrid terminal block

Hybrid terminal blocks with screw connection on one side, 35 (35) mm²



– Ideal for combining photovoltaic strings

new



101 A, potential collective terminal block, 4 inputs 10 mm²



Dimensions		
		[mm]
Maximum electrical data		
Rated data, screw connection		
Rated voltage	[V]	1000
Nominal current / cross section	[A] / [mm ²]	101
Cross section range	AWG	8 - 2
Connection capacity screw connection		
1 conductor	[mm ²]	10 - 35
2 conductors (of the same type)	[mm ²]	1.5 - 16
Rated data, 4 Push-in connections, 10 mm ²		
Nominal current / cross section	[A] / [mm ²]	57 / 10
Cross section range	AWG	20 - 6
Connection capacity, 4 Push-in connections, 10 mm ²		
1 conductor	[mm ²]	2.5 - 16
Connection cross sections directly plug-in	[mm ²]	-
General data		
Stripping length	[mm]	18
Screw thread		M6
Tightening torque	[Nm]	3.2 - 3.7
Insulating material		PA
Flammability rating in accordance with UL 94		V0

Technical data				
Width	Length	Height NS 35/7,5		
19.4	79.9	50.3		
I _{max} [A]	U _{max} [V]	max. Ø [mm ²]	AWG (UL)	
101	1000	10 - 35	14-3	
IEC 60947-7-1				
IEC	UL / CUL	CSA	IEC/ EN 60079-7	
Rated data, screw connection				
Rated voltage	[V]	1000	-	-
Nominal current / cross section	[A] / [mm ²]	101	-	-
Cross section range	AWG	8 - 2	14-3	-
Connection capacity screw connection		Rigid	Flexible	Ferrule
				without/with plastic sleeve
1 conductor	[mm ²]	10 - 35	10 - 35	10 - 35
2 conductors (of the same type)	[mm ²]	1.5 - 16	1.5 - 10	1.5 - 10
Rated data, 4 Push-in connections, 10 mm ²		IEC	UL / CUL	CSA
Nominal current / cross section	[A] / [mm ²]	57 / 10	-	-
Cross section range	AWG	20 - 6	14-3	-
Connection capacity, 4 Push-in connections, 10 mm ²		Rigid	Flexible	Ferrule
				without/with plastic sleeve
1 conductor	[mm ²]	2.5 - 16	2.5 - 10	2.5 - 10
Connection cross sections directly plug-in	[mm ²]	-	-	-

Description	No. of pos.	Color
Terminal block		gray blue

Ordering data		
Type	Order No.	Pcs./Pkt.
PTU 35/4X10	3002371	25

Pick-off terminal block, for snapping into the lateral guide		gray
Plug-in bridge	2	red
	5	red
Test plug metal part, 2.3 mm Ø		gray
Insulating sleeve, for MPS metal part		red
Modular test plug, for the individual assembly of test pin strips		red

Accessories		
Type	Order No.	Pcs./Pkt.
AGK 4-UT 35	3047138	50
FBS 2-10	3005947	10
FBS 5-10	3005948	10
MPS-MT	0201744	10
MPS-IH RD	0201676	10
PS-6	3030996	10
SZF 3-1,0X5,5	1206612	10

Screwdriver	
Center and side groove labeling	UC-TM 16, UCT-TM 16 or ZB 16,3 (see Catalog 3)

new



**101 A, potential collective terminal block,
4 inputs 10 mm²**

ERC

Technical data

Width	Length	Height NS 35/7,5	
19.4	79.9	50.3	
I_{max} [A]	U_{max} [V]	max. Ø [mm ²]	AWG (UL)
101	1000	10 - 35	-
IEC 60947-7-1			
IEC	UL / CUL	CSA	IEC/ EN 60079-7
1000	-	-	-
101	-	-	-
8 - 2	-	-	-
Rigid	Flexible	Ferrule without/with plastic sleeve	
10 - 35	10 - 35	10 - 35	10 - 35
1.5 - 16	1.5 - 10	1.5 - 10	-
IEC	UL / CUL	CSA	IEC/ EN 60079-7
57 / 10	-	-	-
20 - 6	-	-	-
Rigid	Flexible	Ferrule without/with plastic sleeve	
2.5 - 16	2.5 - 10	2.5 - 10	2.5 - 10
-	-	-	-

18
M6
3.2 - 3.7
PA
V0

Ordering data

Type	Order No.	Pcs./Pkt.
PTU 35/4X10 BU	3002370	25

Accessories

AGK 4-UT 35	3047138	50
FBS 2-10	3005947	10
FBS 5-10	3005948	10
MPS-MT	0201744	10
MPS-IH RD	0201676	10
PS-6	3030996	10
SZF 3-1,0X5,5	1206612	10

UC-TM 16, UCT-TM 16 or ZB 16,3
(see Catalog 3)

Terminal blocks – CLIPLINE complete

PTPOWER Power-Turn high-current terminal blocks



i Your web code: #0158



Twist connection

The patented Power-Turn spring connection technology enables large conductors to be connected quickly and easily using a standard screwdriver and a single lever movement.



Reliable contact

Up to three high-quality spring steel pressure springs work with the prismatic terminal body base to create a vibration-resistant conductor connection that is stable in the long-term.

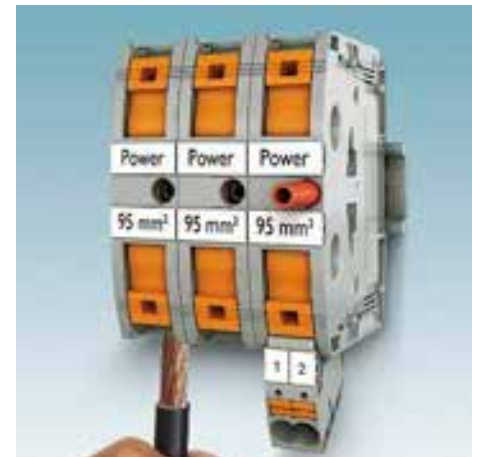

Direct connection

Quick and easy connection is now also possible for large conductors. Alternatively, conductors can also be quickly and easily inserted directly when the lever is closed by means of the Push-in method.



With PTPOWER 35, the reducing bridge enables terminal blocks with different nominal cross sections to be connected easily, e.g., to a PT 2,5 or PT 4 Push-in terminal block. Power blocks can be created quickly using the reducing bridge.

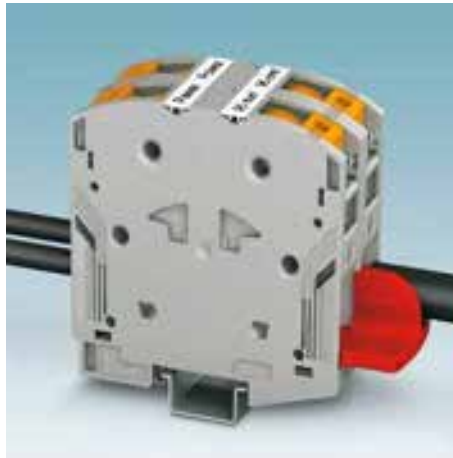

Distribute potentials with the isolated insertion bridges. They can be installed easily without any tools and latch securely in the clamping space. Thanks to their special design, they can also be easily identified following conductor connection.



The fully insulated and optional snap-on tap-off terminal block enables easy voltage tap-off for two conductors up to 16 mm². With large-surface marking option and integrated 2.3 mm test connection.



Test connection on both sides for standard test plugs with a diameter of 2.3 mm. High-current terminal block versions with 4 mm test connection in the terminal center are available for the use of 4 mm test plugs.

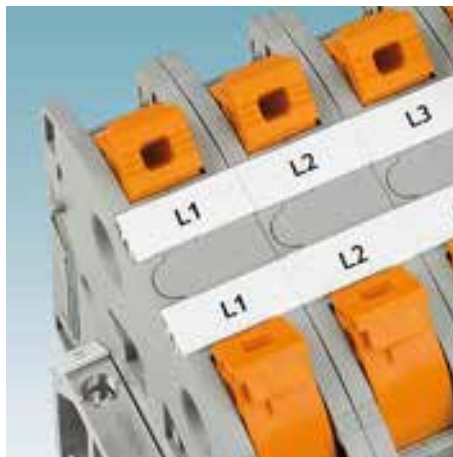

Large-surface, clear marking of the terminal points is essential for reliable and time-saving installation. Furthermore, it provides maximum overview in the control cabinet.



Pre-assembled terminal block bases reduce mounting and storage costs. The right terminal block base for DIN rail or direct mounting is available for every function.

i Your web code: #0158

Terminal blocks – CLIPLINE complete

35 mm² PTPOWER Power-Turn high-current terminal blocks

General technical data

Rated data	IEC 60947-7-1 / IEC 60947-7-2			
Rated cross section	[mm ²]	35		
Cross section range	AWG	12 - 2		
Connection capacity		Rigid	Flexible	Ferrule without/with plastic sleeve
1 conductor	[mm ²]	2.5 - 35	2.5 - 35	2.5 - 35 / 2.5 - 35
2 flexible conductors with a TWIN ferrule	[mm ²]	-	-	- / -
Connection cross sections directly plug-in	[mm ²]	2.5 - 35	-	2.5 - 35 / 2.5 - 35
General data				
Stripping length	[mm]	25		
Insulating material		PA		
Flammability rating in accordance with UL 94		V0		

Note: Additional or deviating data is listed alongside the respective product.

Notes:



In addition to the product, the internal electrical wiring is provided as a circuit diagram. Free connection points for bridging are indicated by a black dot.

The specified technical data and approvals refer to the first product in each column. For information on the products below, please refer to phoenixcontact.net/products

For full details of UL and CSA use groups, file nos., and Internet links, please visit phoenixcontact.net/products

¹⁾ The bridge current is listed alongside the respective product. For additional colors, see page 402.

System accessories

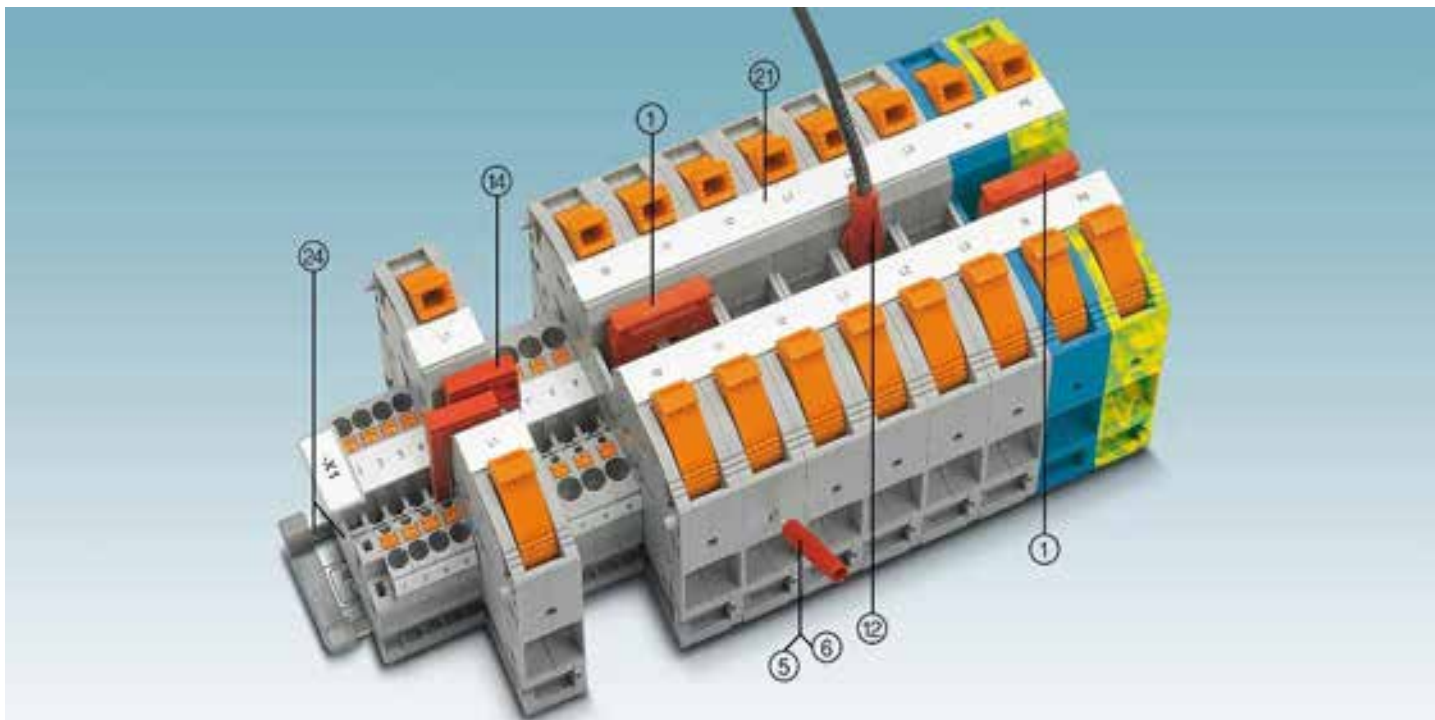

Description	No. of pos.	Color	Type	Order No.	Pcs./Pkt.	Type	Order No.	Pcs./Pkt.
① Bridge ¹⁾	2	red	FBS 2-16	3005963	10			
⑤ Test plug metal part		gray	MPS-MT	0201744	10			
⑥ Insulating sleeve, for MPS metal part		red	MPS-IH RD	0201676	10			
⑫ Test plug, with 2.5 mm ² conductor		red	PAI-ST 35/1000MM	3029994	20			
Screwdriver			SZF 3-1.0X5,5	1206612	10			
⑭ Reducing bridge			RB PTPOWER 35-ST(2,5/4) Order No. 3030900 for reduction bridging to ST 2,5 / PT 2,5 or ST 4 / PT 4 RB PTPOWER 35-ST 16 Order No. 3032170 for reduction bridging to ST 16 / PT 16 N					
⑳ Center groove labeling			UC-TM 16, UCT-TM 16 or ZB 16,3. See also Catalog 3, selection tables from page 60.					
㉔ DIN rail and end bracket			See Catalog 3					
For full accessories, visit phoenixcontact.net/products			Note: Additional or deviating accessories are listed alongside the respective product.					

35 mm² PTPOWER Power-Turn high-current terminal blocks

High-current terminal blocks

Notes:
 1) For additional accessories and technical data, see page 134.

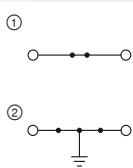

125 A, feed-through terminal block

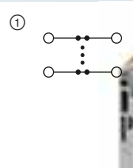

125 A, terminal block base



Technical data ¹⁾				
Dimensions	Width	Length	Height	
	16	91.6	69.8 (NS 35/7,5)	
Maximum electrical data	I _{max} [A]	U _{max} [V]	max. Ø [mm ²]	AWG (UL)
	125	1000	2.5 - 35	-
Maximum bridge current	101			
Rated data	IEC	UL / CUL	CSA	Ex
Rated voltage	1000	1000	1000	-
Nominal current / cross section	125	- / -	115 / -	- / -

Technical data ¹⁾				
Dimensions	Width	Length	Height	
	48	91.6	69.8 (NS 35/7,5)	
Maximum electrical data	I _{max} [A]	U _{max} [V]	max. Ø [mm ²]	AWG (UL)
	125	1000	2.5 - 35	-
Maximum bridge current	101			
Rated data	IEC	UL / CUL	CSA	Ex
Rated voltage	1000	1000	1000	-
Nominal current / cross section	125	- / -	115 / -	- / -

Ordering data			
Type	Order No.	Pcs./Pkt.	
PTPOWER 35	3212064	10	
PTPOWER 35 BU	3212065	10	
PTPOWER 35-FE	3212081	10	
PTPOWER 35-PE	3212066	10	

Ordering data			
Type	Order No.	Pcs./Pkt.	
PTPOWER 35-3L	3212068	3	
PTPOWER 35-3L/N	3212069	2	
PTPOWER 35-3L/FE	3212070	2	
PTPOWER 35-3L/N/FE	3212071	2	

High-current terminal blocks for direct mounting

Notes:
 1) For additional accessories and technical data, see page 134.

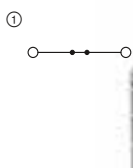

125 A, feed-through terminal block for direct mounting

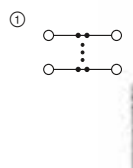

125 A, terminal block base for direct mounting



Technical data ¹⁾				
Dimensions	Width	Length	Height	
	16	120.2	68.3	
Maximum electrical data	I _{max} [A]	U _{max} [V]	max. Ø [mm ²]	AWG (UL)
	125	1000	2.5 - 35	-
Maximum bridge current	101			
Rated data	IEC	UL / CUL	CSA	Ex
Rated voltage	1000	1000	1000	-
Nominal current / cross section	125	- / -	115 / -	- / -

Technical data ¹⁾				
Dimensions	Width	Length	Height	
	48	120.2	68.3	
Maximum electrical data	I _{max} [A]	U _{max} [V]	max. Ø [mm ²]	AWG (UL)
	125	1000	2.5 - 35	-
Maximum bridge current	101			
Rated data	IEC	UL / CUL	CSA	Ex
Rated voltage	1000	1000	1000	-
Nominal current / cross section	125	- / -	115 / -	- / -

Ordering data			
Type	Order No.	Pcs./Pkt.	
PTPOWER 35-F	3212078	10	
PTPOWER 35-F BU	3212079	10	
PTPOWER 35-FE-F	3212082	10	

Ordering data			
Type	Order No.	Pcs./Pkt.	
PTPOWER 35-3L-F	3212072	3	
PTPOWER 35-3L/N-F	3212073	2	
PTPOWER 35-3L/FE-F	3212075	2	
PTPOWER 35-3L/N/FE-F	3212076	2	

Terminal blocks – CLIPLINE complete

50 mm² PTPOWER Power-Turn high-current terminal blocks

General technical data

Rated data		IEC 60947-7-1 / IEC 60947-7-2			
Rated cross section	[mm ²]	50			
Cross section range	AWG	8 - 2/0			
Connection capacity		Rigid	Flexible	Ferrule without/with plastic sleeve	
1 conductor	[mm ²]	10 - 70	10 - 70	10 - 50	10 - 50
2 flexible conductors with a TWIN ferrule	[mm ²]	-	-	-	-
Connection cross sections directly plug-in	[mm ²]	10 - 70	-	10 - 50	10 - 50
Max. cross section with insertion bridge	[mm ²]	50	50	-	-
General data					
Stripping length	[mm]	30 - 32			
Insulating material		PA			
Flammability rating in accordance with UL 94		V0			

Note: Additional or deviating data is listed alongside the respective product.

Notes:



In addition to the product, the internal electrical wiring is provided as a circuit diagram. Free connection points for bridging are indicated by a black dot.

The specified technical data and approvals refer to the first product in each column. For information on the products below, please refer to phoenixcontact.net/products

For full details of UL and CSA use groups, file nos., and Internet links, please visit phoenixcontact.net/products

¹⁾ The bridge current is listed alongside the respective product. For additional colors, see page 402.

System accessories

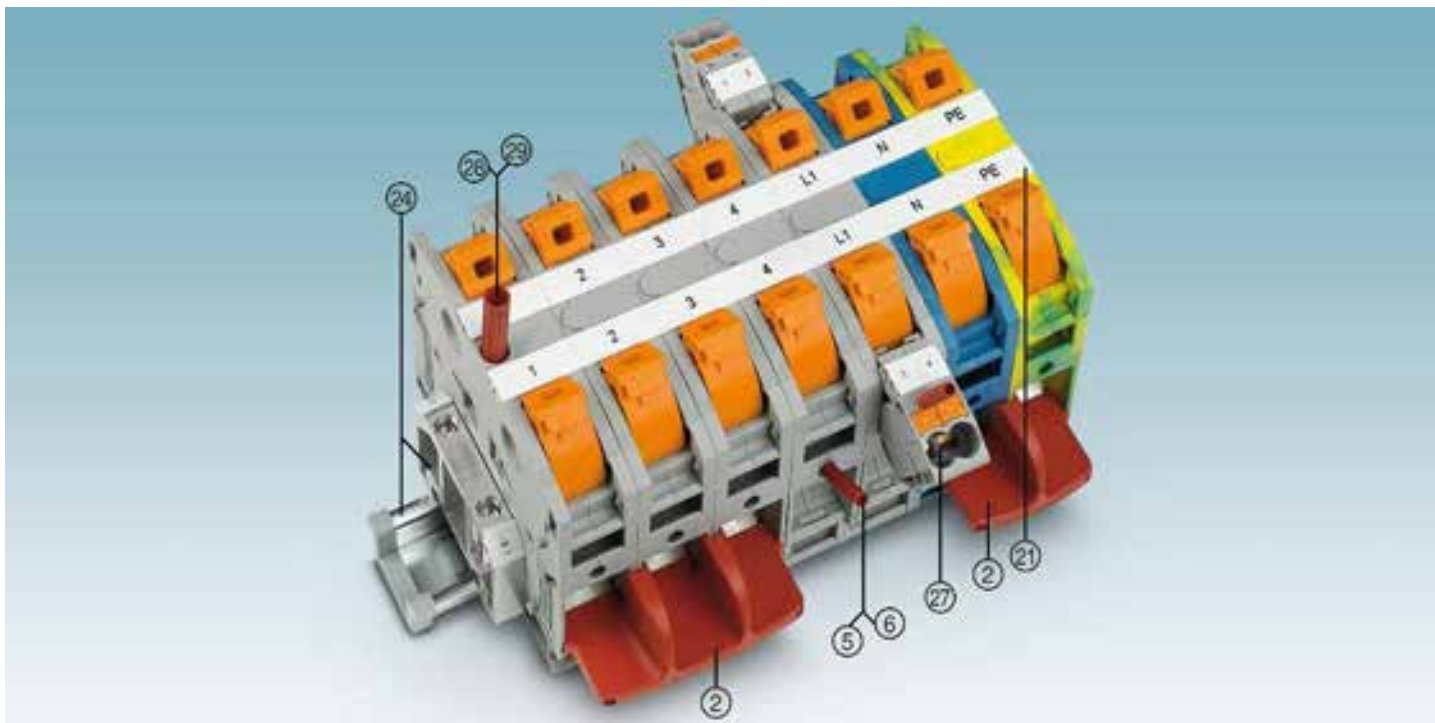

Description	No. of pos.	Color	Type	Order No.	Pcs./Pkt.	Type	Order No.	Pcs./Pkt.
② Insertion bridge ¹⁾	2	red	EB 2-20/PT	3260067	10			
	3	red	EB 3-20/PT	3260068	10			
⑤ Test plug metal part		gray	MPS-MT	0201744	10			
⑥ Insulating sleeve, for MPS metal part		red	MPS-IH RD	0201676	10			
⑦ Tap-off terminal block		gray	AGK 10-PTPOWER	3260145	10			
		blue	AGK 10-PTPOWER BU	3260148	10			
		green/yellow	AGK 10-PTPOWER GN/YE	3260151	10			
		black/yellow	AGK 10-PTPOWER BK/YE	3260154	10			
Screwdriver			SZF 3-1,0X5,5	1206612	10			

② Center groove labeling	UC-TM 16, UCT-TM 16 or ZB 16,3. See also Catalog 3, selection tables from page 60.
②④ DIN rail and end bracket	See Catalog 3
②②② Test plug	For MPS-MT/ 4MM and PS-IH RD, see page 410.
For full accessories, visit phoenixcontact.net/products	Note: Additional or deviating accessories are listed alongside the respective product.

50 mm² PTPOWER Power-Turn high-current terminal blocks

High-current terminal blocks

Notes:
 1) For additional accessories and technical data, see page 136.

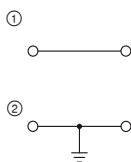

150 A, feed-through terminal block

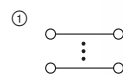

150 A, terminal block base



Technical data ¹⁾				
Dimensions	Width	Length	Height	
	20	101	105 (NS 35/15)	
Maximum electrical data	I_{max} [A]	U_{max} [V]	max. Ø [mm ²]	AWG (UL)
	150	1000	10 - 70	8
Maximum bridge current	150			
Rated data	IEC	UL / CUL	CSA	Ex
Rated voltage	1000	1000	1000	-
Nominal current / cross section	150	140 / -	140 / -	- / -

Technical data ¹⁾				
Dimensions	Width	Length	Height	
	60	101	105 (NS 35/15)	
Maximum electrical data	I_{max} [A]	U_{max} [V]	max. Ø [mm ²]	AWG (UL)
	150	1000	10 - 70	8
Maximum bridge current	150			
Rated data	IEC	UL / CUL	CSA	Ex
Rated voltage	1000	1000	1000	-
Nominal current / cross section	150	140 / -	140 / -	- / -

Ordering data				
Description	Type	Order No.	Pcs./Pkt.	
Terminal block	PTPOWER 50	3260050	10	
	PTPOWER 50 BU	3260051	10	
with 4 mm test connection	PTPOWER 50-FE	3260063	10	
Ground terminal	PTPOWER 50 P	3260065	10	
Terminal block base, 3 x gray	PTPOWER 50-PE	3260052	10	
3 x gray, 1 x blue				
3 x gray, 1 x black-yellow				
3 x gray, 1 x blue, 1 x black-yellow				

Ordering data				
Description	Type	Order No.	Pcs./Pkt.	
	PTPOWER 50-3L	3260053	3	
	PTPOWER 50-3L/N	3260054	3	
	PTPOWER 50-3L/FE	3260055	3	
	PTPOWER 50-3L/N/FE	3260056	2	

High-current terminal blocks for direct mounting

Notes:
 1) For additional accessories and technical data, see page 136.



150 A, feed-through terminal block for direct mounting

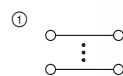

150 A, terminal block base for direct mounting



Technical data ¹⁾				
Dimensions	Width	Length	Height	
	20	101	96	
Maximum electrical data	I_{max} [A]	U_{max} [V]	max. Ø [mm ²]	AWG (UL)
	150	1000	10 - 70	8
Maximum bridge current	150			
Rated data	IEC	UL / CUL	CSA	Ex
Rated voltage	1000	1000	1000	-
Nominal current / cross section	150	140 / -	140 / -	- / -

Technical data ¹⁾				
Dimensions	Width	Length	Height	
	60	101	96	
Maximum electrical data	I_{max} [A]	U_{max} [V]	max. Ø [mm ²]	AWG (UL)
	150	1000	10 - 70	8
Maximum bridge current	150			
Rated data	IEC	UL / CUL	CSA	Ex
Rated voltage	1000	1000	1000	-
Nominal current / cross section	150	140 / -	140 / -	- / -

Ordering data				
Description	Type	Order No.	Pcs./Pkt.	
Terminal block, for direct mounting	PTPOWER 50-F	3260061	10	
	PTPOWER 50-F BU	3260062	10	
with three gray feed-through terminal blocks	PTPOWER 50-FE-F	3260064	10	
3 x gray, 1 x blue				
3 x gray, 1 x black-yellow				
3 x gray, 1 x blue, 1 x black-yellow				

Ordering data				
Description	Type	Order No.	Pcs./Pkt.	
	PTPOWER 50-3L-F	3260057	3	
	PTPOWER 50-3L/N-F	3260058	3	
	PTPOWER 50-3L/FE-F	3260059	3	
	PTPOWER 50-3L/N/FE-F	3260060	2	

Terminal blocks – CLIPLINE complete

95 mm² PTPOWER Power-Turn high-current terminal blocks

General technical data

Rated data		IEC 60947-7-1 / IEC 60947-7-2			
Rated cross section	[mm ²]	95			
Cross section range	AWG	4 - 4/0			
Connection capacity		Rigid	Flexible	Ferrule without/with plastic sleeve	
1 conductor	[mm ²]	25 - 95	25 - 95	25 - 95	25 - 95
2 flexible conductors with a TWIN ferrule	[mm ²]	-	-	-	-
Connection cross sections directly plug-in	[mm ²]	25 - 95	-	25 - 95	25 - 95
Max. cross section with insertion bridge	[mm ²]	70	70	-	-
General data					
Stripping length	[mm]	40			
Insulating material		PA			
Flammability rating in accordance with UL 94		V0			

Note: Additional or deviating data is listed alongside the respective product.

Notes:



In addition to the product, the internal electrical wiring is provided as a circuit diagram. Free connection points for bridging are indicated by a black dot.

The specified technical data and approvals refer to the first product in each column. For information on the products below, please refer to phoenixcontact.net/products

For full details of UL and CSA use groups, file nos., and Internet links, please visit phoenixcontact.net/products

¹⁾ The bridge current is listed alongside the respective product. For additional colors, see page 402.

System accessories

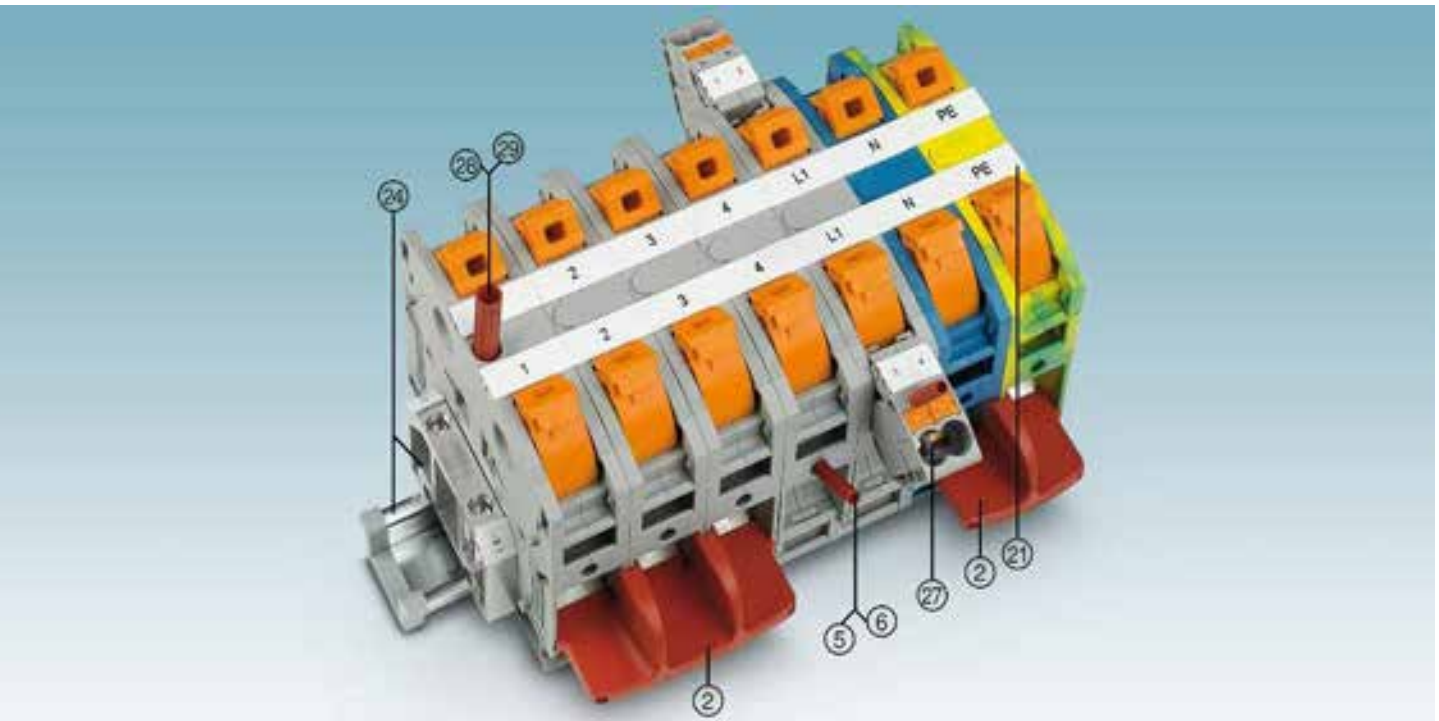

Description	No. of pos.	Color	Type	Order No.	Pcs./Pkt.	Type	Order No.	Pcs./Pkt.
② Insertion bridge ¹⁾	2	red	EB 2-25/PT	3260157	10			
	3	red	EB 3-25/PT	3260160	10			
	4	red	EB 4-25/PT	3260161	10			
⑤ Test plug metal part		gray	MPS-MT	0201744	10			
⑥ Insulating sleeve, for MPS metal part		red	MPS-IH RD	0201676	10			
⑦ Tap-off terminal block		gray	AGK 10-PTPOWER	3260145	10			
		blue	AGK 10-PTPOWER BU	3260148	10			
		green/yellow	AGK 10-PTPOWER GN/YE	3260151	10			
		black/yellow	AGK 10-PTPOWER BK/YE	3260154	10			
Screwdriver			SZF 3-1,0X5,5	1206612	10			
⑪ Center groove labeling			UC-TM 16, UCT-TM 16 or ZB 16,3. See also Catalog 3, selection tables from page 60.					
⑫ DIN rail and end bracket			See Catalog 3					
⑬ Test plug			For MPS-MT/ 4MM and PS-IH RD, see page 410.					
For full accessories, visit phoenixcontact.net/products			Note: Additional or deviating accessories are listed alongside the respective product.					

95 mm² PTPOWER Power-Turn high-current terminal blocks

High-current terminal blocks

Notes:
 1) For additional accessories and technical data, see page 138.
 For information on installation and using accessories for Ex applications, see page 678.

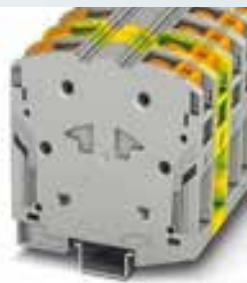
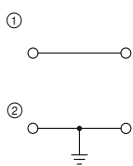

232 A, feed-through terminal block

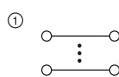

232 A, terminal block base



Ex: EAC Ex IEC
 SEV14ATEX0156U / IECExSEV14.0013U

Technical data ¹⁾			
Width	Length	Height	
25	105.5	108.7 (NS 35/15)	
I _{max} [A]	U _{max} [V]	max. Ø [mm ²]	AWG (UL)
232	1000	25 - 95	-
150			
Rated data	IEC	UL / CUL	CSA Ex
Rated voltage	1000	1000	1100
Nominal current / cross section	232	- / -	230 / - 215 / 95

Ordering data			
Type	Order No.	Pcs./Pkt.	
PTPOWER 95	3260100	3	
PTPOWER 95 BU	3260103	3	
PTPOWER 95-FE	3260139	3	
PTPOWER 95 P	3260163	3	
PTPOWER 95-PE	3260106	3	



Technical data ¹⁾			
Width	Length	Height	
75	105.5	108.7 (NS 35/15)	
I _{max} [A]	U _{max} [V]	max. Ø [mm ²]	AWG (UL)
232	1000	25 - 95	-
150			
Rated data	IEC	UL / CUL	CSA Ex
Rated voltage	1000	1000	1100
Nominal current / cross section	232	- / -	230 / - - / -

Ordering data			
Type	Order No.	Pcs./Pkt.	
PTPOWER 95-3L	3260109	3	
PTPOWER 95-3L/N	3260112	2	
PTPOWER 95-3L/FE	3260115	2	
PTPOWER 95-3L/N/FE	3260118	2	

High-current terminal blocks for direct mounting

Notes:
 1) For additional accessories and technical data, see page 138.
 For drilling diagram, see phoenixcontact.net/products
 For information on installation and using accessories for Ex applications, see page 678.

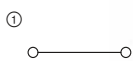

232 A, feed-through terminal block, for direct mounting

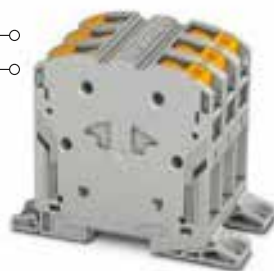
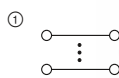

232 A, terminal block base for direct mounting



Ex: EAC Ex IEC
 SEV14ATEX0156U / IECExSEV14.0013U

Technical data ¹⁾			
Width	Length	Height	
25	139.1	99.8	
I _{max} [A]	U _{max} [V]	max. Ø [mm ²]	AWG (UL)
232	1000	25 - 95	-
150			
Rated data	IEC	UL / CUL	CSA Ex
Rated voltage	1000	1000	1100
Nominal current / cross section	232	- / -	230 / - 215 / 95

Ordering data			
Type	Order No.	Pcs./Pkt.	
PTPOWER 95-F	3260133	3	
PTPOWER 95-F BU	3260136	3	
PTPOWER 95-FE-F	3260142	3	



Technical data ¹⁾			
Width	Length	Height	
75	139.1	99.8	
I _{max} [A]	U _{max} [V]	max. Ø [mm ²]	AWG (UL)
232	1000	25 - 95	-
150			
Rated data	IEC	UL / CUL	CSA Ex
Rated voltage	1000	1000	1100
Nominal current / cross section	232	- / -	230 / - - / -

Ordering data			
Type	Order No.	Pcs./Pkt.	
PTPOWER 95-3L-F	3260121	3	
PTPOWER 95-3L/N-F	3260124	2	
PTPOWER 95-3L/FE-F	3260127	2	
PTPOWER 95-3L/N/FE-F	3260130	2	

Terminal blocks – CLIPLINE complete

185 mm² PTPOWER Power-Turn high-current terminal blocks

General technical data

Rated data		IEC 60947-7-1 / IEC 60947-7-2			
Rated cross section	[mm ²]	150			
Cross section range	AWG	3/0 - 350 kcmil			
Connection capacity		Rigid	Flexible	Ferrule without/with plastic sleeve	
1 conductor	[mm ²]	95 - 185	95 - 185	95 - 150	95 - 150
2 flexible conductors with a TWIN ferrule	[mm ²]	-	-	-	-
Connection cross sections directly plug-in	[mm ²]	95 - 185	-	95 - 150	95 - 150
Max. cross section with insertion bridge	[mm ²]	150	150	-	-
General data					
Stripping length	[mm]	40			
Insulating material		PA			
Flammability rating in accordance with UL 94		V0			

Note: Additional or deviating data is listed alongside the respective product.

Notes:



In addition to the product, the internal electrical wiring is provided as a circuit diagram. Free connection points for bridging are indicated by a black dot.

The specified technical data and approvals refer to the first product in each column. For information on the products below, please refer to phoenixcontact.net/products

For full details of UL and CSA use groups, file nos., and Internet links, please visit phoenixcontact.net/products

¹⁾ The bridge current is listed alongside the respective product. For additional colors, see page 402.

System accessories

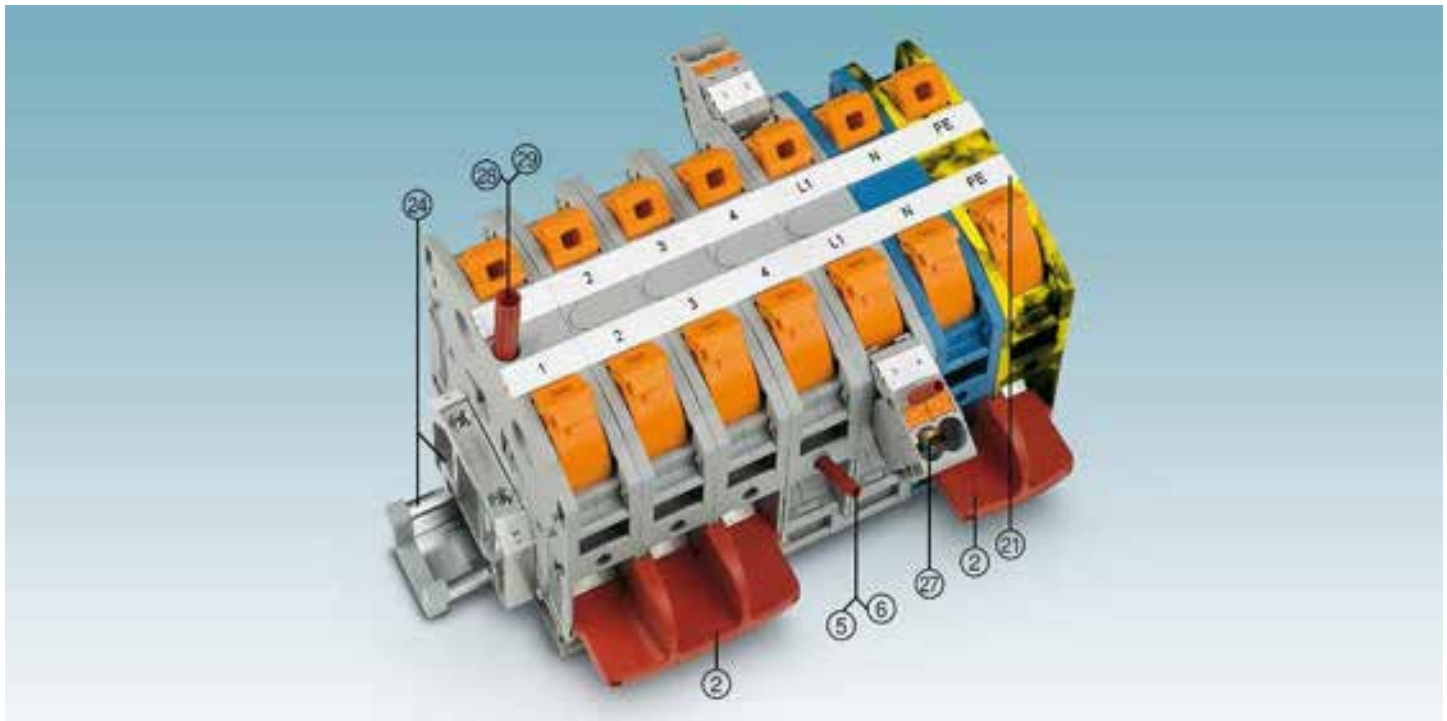

Description	No. of pos.	Color	Type	Order No.	Pcs./Pkt.	Type	Order No.	Pcs./Pkt.
② Insertion bridge ¹⁾	2	red	EB 2-31/PT	3215057	5			
	3	red	EB 3-31/PT	3215058	5			
⑤ Test plug metal part		gray	MPS-MT	0201744	10			
⑥ Insulating sleeve, for MPS metal part		red	MPS-IH RD	0201676	10			
⑦ Tap-off terminal block		gray	AGK 10-PTPOWER	3260145	10			
		blue	AGK 10-PTPOWER BU	3260148	10			
		green/yellow	AGK 10-PTPOWER GN/YE	3260151	10			
		black/yellow	AGK 10-PTPOWER BK/YE	3260154	10			
Screwdriver			SZF 3-1,0X5,5	1206612	10			

② Center groove labeling
②④ DIN rail and end bracket
②②② Test plug
For full accessories, visit phoenixcontact.net/products

UC-TM 16, UCT-TM 16 or ZB 16,3. See also Catalog 3, selection tables from page 60.
See Catalog 3
For MPS-MT/ 4MM and PS-IH RD, see page 410.
Note: Additional or deviating accessories are listed alongside the respective product.

185 mm² PTPOWER Power-Turn high-current terminal blocks

High-current terminal blocks

Notes:
 1) For additional accessories and technical data, see page 141.



309 A, feed-through terminal block

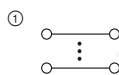

309 A, terminal block base



Technical data ¹⁾			
Width	Length	Height	
31	116.4	116.5 (NS 35/15)	
I_{max} [A]	U_{max} [V]	max. Ø [mm ²]	AWG (UL)
309	1500	95 - 185	-
232			
IEC	UL / CUL	CSA	Ex
1500	1000	1000	-
Nominal current / cross section	[A] / [mm ²]		
309	- / - 270 / - - / -		



Technical data ¹⁾			
Width	Length	Height	
93	116.4	108.7 (NS 35/15)	
I_{max} [A]	U_{max} [V]	max. Ø [mm ²]	AWG (UL)
309	1500	95 - 185	-
232			
IEC	UL / CUL	CSA	Ex
1500	1000	1000	-
Nominal current / cross section	[A] / [mm ²]		
309	- / - 270 / - - / -		

Ordering data			
Type	Order No.	Pcs./Pkt.	
PTPOWER 185	1054722	3	
PTPOWER 185 BU	1054723	3	
PTPOWER 185-FE	1054724	3	
PTPOWER 185 P	1054725	3	
PTPOWER 185 P BU	1054726	3	

Ordering data			
Type	Order No.	Pcs./Pkt.	
PTPOWER 185-3L	1054728	1	
PTPOWER 185-3L/N	1054729	1	
PTPOWER 185-3L/FE	1054730	1	
PTPOWER 185-3L/N/FE	1054731	1	

High-current terminal blocks for direct mounting

Notes:
 1) For additional accessories and technical data, see page 141.

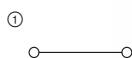

309 A, feed-through terminal block, for direct mounting

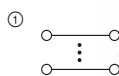

309 A, terminal block base for direct mounting



Technical data ¹⁾			
Width	Length	Height	
31	150	108.3	
I_{max} [A]	U_{max} [V]	max. Ø [mm ²]	AWG (UL)
309	1500	95 - 185	-
232			
IEC	UL / CUL	CSA	Ex
1500	1000	1000	-
Nominal current / cross section	[A] / [mm ²]		
309	- / - 270 / - - / -		



Technical data ¹⁾			
Width	Length	Height	
93	150	108.3	
I_{max} [A]	U_{max} [V]	max. Ø [mm ²]	AWG (UL)
309	1500	95 - 185	-
232			
IEC	UL / CUL	CSA	Ex
1500	1000	1000	-
Nominal current / cross section	[A] / [mm ²]		
309	- / - 270 / - - / -		

Ordering data			
Type	Order No.	Pcs./Pkt.	
PTPOWER 185 F	1054732	3	
PTPOWER 185 F BU	1054733	3	
PTPOWER 185 FE-F	1054734	3	
PTPOWER 185 P-F	1054739	3	

Ordering data			
Type	Order No.	Pcs./Pkt.	
PTPOWER 185 3L-F	1054735	1	
PTPOWER 185 3L/N-F	1054736	1	
PTPOWER 185 3L/FE-F	1054737	1	
PTPOWER 185 3L/N/FE-F	1054738	1	



UT screw connection terminal blocks

The UT screw connection terminal blocks from the CLIPLINE complete system satisfy the most stringent requirements and cover a wide area of application. The terminal blocks impress with their maintenance-free conductor connection and offer maximum flexibility with their multi-conductor connection. You can connect conductors with a nominal cross section either with or without ferrules. It is not necessary to tighten the terminal block screws, since they are prevented from loosening by the Reakdyn principle, a screw locking technique developed by Phoenix Contact. Very large conductor cross sections up to 240 mm² can also be wired gas-tight and with long-term stability thanks to the high contact forces.

i Your web code: #1397

Product range overview

2.5 mm²

Feed-through, multi-conductor, multi-level, and ground terminal blocks	149
Disconnect and knife disconnect terminal blocks	151
Diode and LED terminal blocks	153
Installation terminal blocks	154
Mini feed-through and ground terminal blocks	157

4 mm²

Feed-through, multi-conductor, multi-level, and ground terminal blocks	159
Fuse terminal blocks and lever-type disconnect terminal blocks of the same shape	161
Disconnect and knife disconnect terminal blocks	163
Diode terminal blocks	168
Test disconnect terminal blocks	169
Installation terminal blocks	170
Mini feed-through and ground terminal blocks	171

6 mm²

Feed-through, multi-level and ground terminal blocks	173
Fuse terminal blocks	173
Disconnect and knife disconnect terminal blocks	174
Test disconnect terminal blocks	176
Installation terminal blocks	178

10 mm²

Feed-through and ground terminal blocks	183
Installation terminal blocks	183

16 mm²

Feed-through and ground terminal blocks	185
Installation terminal blocks	185

35 mm²

Feed-through and ground terminal blocks	187
Installation terminal blocks	187

50 mm² - 240 mm²

High-current terminal blocks	189
------------------------------	-----

Terminal blocks – CLIPLINE complete

UT screw connection terminal blocks

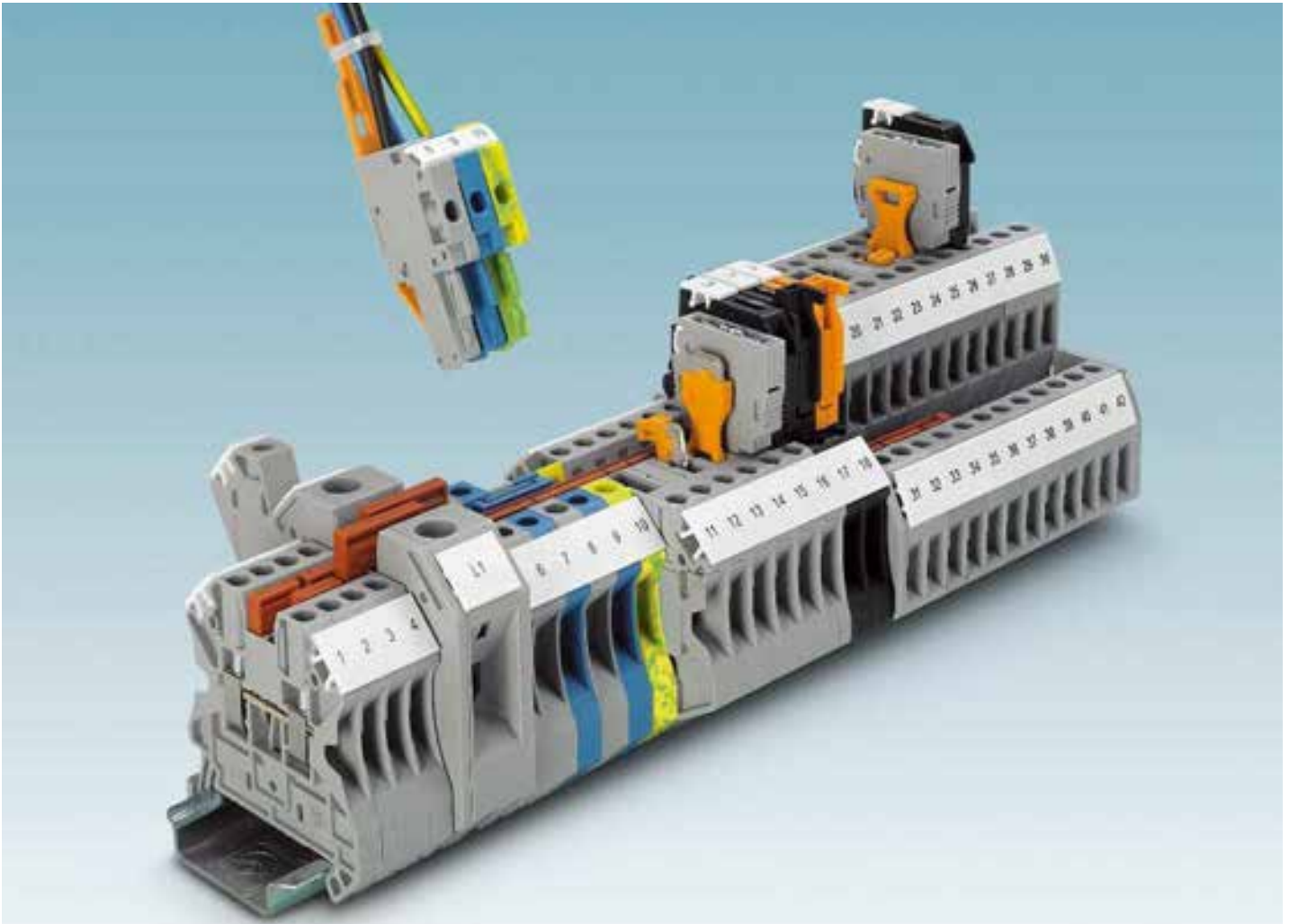

i Your web code: #1397

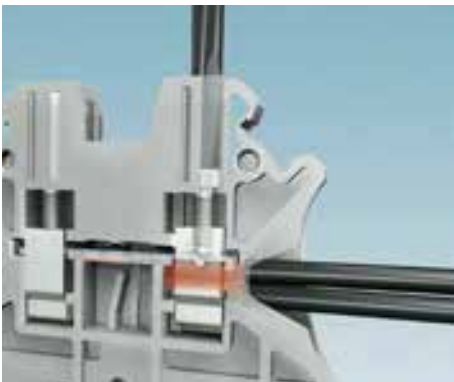

Universal and zero-maintenance

The screw connection is characterized by three main features.

- Global standard
- Multiple conductor connection
- Zero maintenance thanks to Reakdyn principle.



Snap-on PE foot

Ground terminal blocks of the same shape are simply snapped onto the DIN rail in order to make contact. This mechanically and electrically efficient contacting meets all the requirements of the IEC 60947-7-2 standard.



Flexible plug-in bridge system

Potential can be distributed quickly using standardized plug-in bridges. Using two bridge shafts in all terminal blocks makes flexible chain and level bridging and bridging between non-adjacent terminal blocks possible.



The reducing bridge enables terminal blocks with different nominal cross sections to be connected easily, e.g., a UT 10 terminal block to a UT 2,5. Power blocks can be created quickly using the reducing bridge.

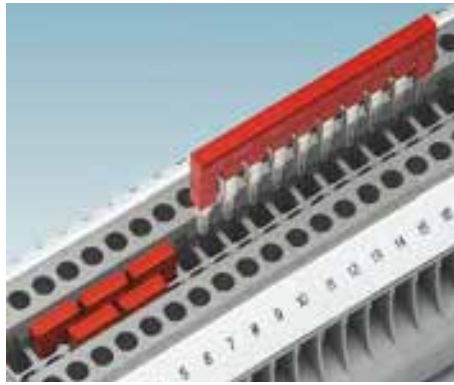

The double function shaft can be used to connect any number of terminal blocks with two-position bridges. The 2- to 50-pos. bridges allow up to 50 terminal blocks to be bridged in one step.



Bridging between non-adjacent terminal blocks is established by removing individual contact tabs from the standard bridge. Two potentials can then be routed in parallel through a terminal strip. The contact points can also be marked.



The isolated feed-through connector P-FIX, isolating connector P-DI, component connector P-CO and the cartridge fuse connector P-FU can be used in the universal plug-in zone of the disconnect terminal block.



For measuring lines, a test plug with 2.3 mm diameter is available. All measurement and testing tasks can be carried out quickly using test adapters for 4 mm diameter test plugs and the alignable test plugs.



Large-surface and clear marking of the terminal points is essential for reliable and quick installation. Each terminal point in the UT series can be marked separately.



Disconnect terminal blocks and feed-through terminal blocks UT 4-MTD are available in the same shape as the feed-through terminal blocks. All terminal blocks can be continuously bridged with one another with the double function shaft.



The offset levels of the double-level terminal blocks allow unhindered access to the lower connection levels even when already fully wired. They also provide a perfect view of the lower marking labels and conductor entry funnel.



UT-COMBI terminal blocks are available for creating plug-in signal and power wiring. The system has a touch-proof design and offers plugs for self-assembly with extensive accessories. See "COMBI" section, page 267

Terminal blocks – CLIPLINE complete

UT screw connection terminal blocks

UT ... feed-through, multi-conductor, and multi-level terminal blocks



- Multi-level terminal blocks with PE pick-off and function level
- Signal processing and protection in a confined space, thanks to safety/disconnect lever and universal function zone
- Double bridge shaft enables individual potential distribution and supply
- Suitable for process technology, thanks to Ex nA approval
- Feed-through terminal blocks of the same shape available

i Your web code: **#0056**

UT ... multifunctional terminal blocks



- A wide range of products, thanks to versions with PE function or LED display
- Optimum overview of signal connections thanks to a variety of marking options
- Modular expansion up to a maximum of 50 positions, as power terminals are the same shape
- Power fed-in or power-line extended via power terminals

i Your web code: **#0075**

UT ... function terminal blocks



- Convenient separation of circuits using lever-type disconnect knife, isolating plug or rotary contact
- User-friendly current measurement thanks to testing facility either side of the disconnect point
- Safe operation as the disconnect lever is locked in the end positions
- Clear identification of the disconnect point thanks to color highlighting
- Individual assembly with disconnect element, fuse plug, component connector, and feed-through connector

i Your web code: **#0057**

UTME ... test disconnect terminal blocks

- Easy and safe operation, thanks to clear indication of switching states
- Maximum functionality, up to six universal function shafts for potential distribution or for test purposes
- Modular expansion thanks to feed-through terminal blocks and ground terminals of the same shape
- Simple and individual configuration of measuring transducer terminal strips
- Ideal application possibilities in measuring and control engineering, from the counter right up to the secondary technology of switching devices and power stations

i Your web code: **#0058**

MUT ... miniature terminal blocks

- Space saving, thanks to compact design and mounting option on a 15 mm DIN rail
- Clear, as all terminal points are marked
- Easy potential distribution thanks to standardized bridges
- Ideal for installation in small control boxes or terminal boxes, e.g., for motor connection

i Your web code: **#0059**

UTI ... installation terminal blocks

- Space saving, thanks to compact three-level distributor terminal blocks of the same shape for single- and multi-phase circuits
- Complete flexibility – all installation terminal blocks with different connection technologies can be combined
- Dielectric test without disconnecting the neutral conductor – thanks to the disconnect slide
- Protection against unintentional actuation since the disconnect slide can be snapped into the limit positions
- Easy terminal block mounting without removing the neutral busbar

i Your web code: **#0060**

Terminal blocks – CLIPLINE complete

2.5 mm² UT screw connection terminal blocks

General technical data

Rated data		IEC 60947-7-1 / IEC 60947-7-2			
Rated cross section	[mm ²]	2.5			
Cross section range	AWG	26 - 12			
Connection capacity		Rigid	Flexible	Ferrule without/with plastic sleeve	
1 conductor	[mm ²]	0.14 - 4	0.14 - 4	0.14 - 2.5	0.14 - 2.5
2 conductors (of the same type)	[mm ²]	0.14 - 1.5	0.14 - 1.5	0.14 - 1.5	-
2 flexible conductors with a TWIN ferrule	[mm ²]	-	-	-	0.5 - 1.5
General data					
Stripping length	[mm]	9			
Screw thread		M3			
Tightening torque	[Nm]	0.5 - 0.6			
Insulating material		PA			
Flammability rating in accordance with UL 94		VO			

Note: Additional or deviating data is listed alongside the respective product.

Notes:



In addition to the product, the internal electrical wiring is provided as a circuit diagram. Free connection points for bridging are indicated by a black dot.

The specified technical data and approvals refer to the first product in each column. For information on the products below, please refer to phoenixcontact.net/products

For full details of UL and CSA use groups, file nos., and Internet links, please visit phoenixcontact.net/products

¹⁾ The bridge current is listed alongside the respective product. For additional colors, see page 402.

System accessories

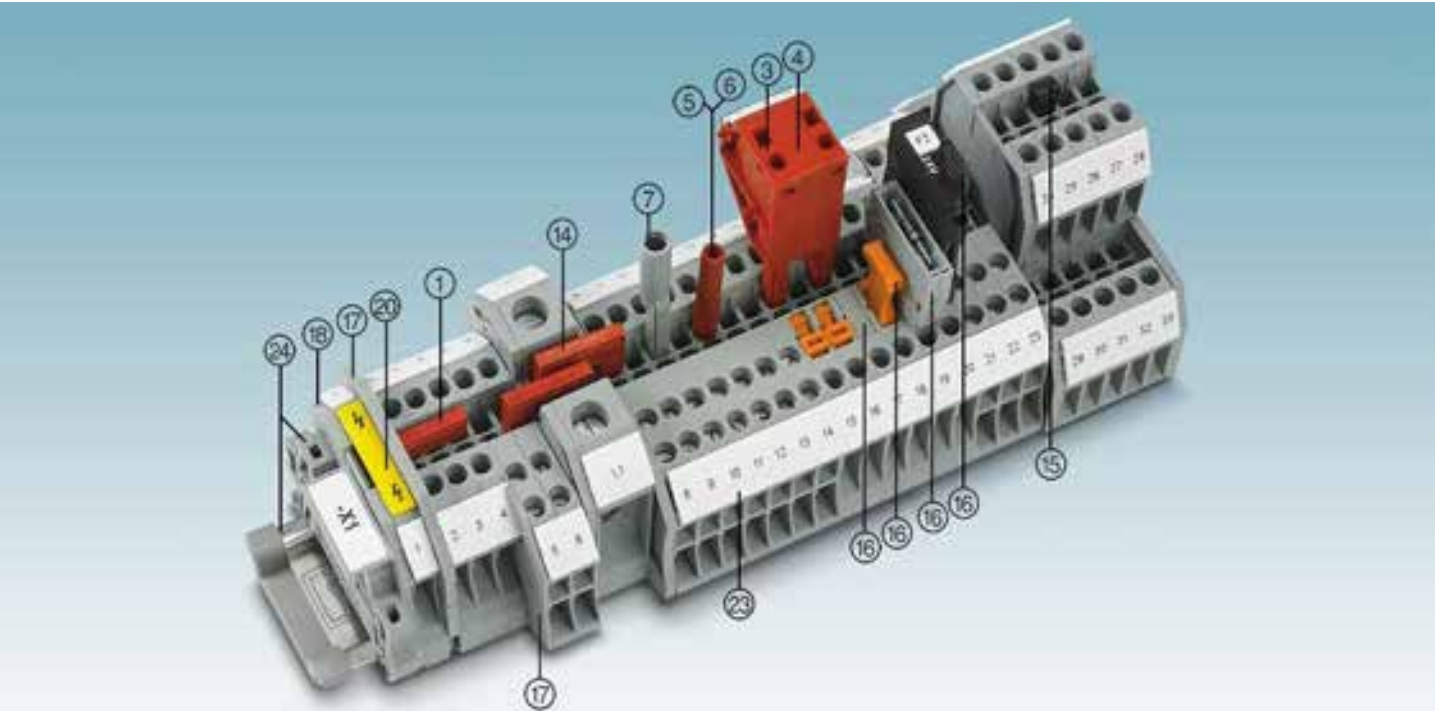

Description	No. of pos.	Color	Type	Order No.	Pcs./Pkt.	Type	Order No.	Pcs./Pkt.
① Bridge ¹⁾	2	red	FBS 2-5	3030161	50	FBSR 2-5	3033702	50
	3	red	FBS 3-5	3030174	50	FBSR 3-5	3001591	50
	4	red	FBS 4-5	3030187	50	FBSR 4-5	3001592	50
	5	red	FBS 5-5	3030190	50	FBSR 5-5	3001593	50
	10	red	FBS 10-5	3030213	10	FBSR 10-5	3033710	10
	20	red	FBS 20-5	3030226	10			
③ Modular test plug		red	PS-5	3030983	10			
④ Spacer plate		red	DP PS-5	3036725	10			
⑤ Test plug metal part		gray	MPS-MT	0201744	10			
⑥ Insulating sleeve, for MPS metal part		red	MPS-IH RD	0201676	10			
⑦ Test adapter, 4 mm socket hole		gray	PAI-4-N GY	3032871	10			
Screwdriver			SF-SL 0,6X3,5-100 S-VDE	1212587	10			

⑭ Reducing bridge	For RB ..., see page 408.
⑮ Vertical potential bridge	For FBS-PV ..., see page 404.
⑯ Fuse and function plugs for disconnect terminal blocks	For P-FU ... / P-DI / P-FIX / P-CO ..., see from page 414.
⑰ Partition plates/end cover segments	For ATP-... / DS-..., visit phoenixcontact.net/products
⑱ Cover	Listed alongside the respective product.
⑳ Warning labels	For WS ..., see page 420.
㉑ Lateral groove labeling	UC-TM 5, UCT-TM 5 or ZB 5. See also Catalog 3, selection tables, from page 60.
㉒ DIN rail and end bracket	See Catalog 3
For full accessories, visit phoenixcontact.net/products	Note: Additional or deviating accessories are listed alongside the respective product.

Feed-through, multi-conductor, multi-level, and ground terminal blocks

Notes:

¹⁾ For additional accessories and technical data, see page 148.

For information on installation and using accessories for Ex applications, see page 678.

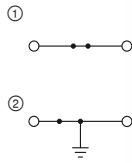

32 A, feed-through and ground terminal block



Ex: EAC Ex IEC KEMA 04ATEX2048 U / IECEx KEM 06.0027U

Technical data¹⁾

Width	Length	Height		
5.2	47.7	47.5 (NS 35/7,5)		
I_{max} [A]	U_{max} [V]	max. Ø [mm ²]	AWG (UL)	
32	1000	0.14 - 4	26-12	
24 (FBS) / 17.5 (FBSR)				
IEC	UL / CUL	CSA	Ex	
1000	600	600	690	
24 / 2.5	20 / -	20 / -	21 / 2.5	

Ordering data

Type	Order No.	Pcs./Pkt.
UT 2,5	^① 3044076	50
UT 2,5 BU	^① 3044089	50
UT 2,5-PE	^② 3044092	50

Accessories¹⁾

D-UT 2,5/10	Order No.	Pcs./Pkt.
	3047028	50

Dimensions	[mm]
Maximum electrical data	
Maximum bridge current	[A]
Rated data	
Rated voltage	[V]
Nominal current / cross section	[A] / [mm ²]

Description	Color
Terminal block	gray blue
Ground terminal	green-yellow

Cover, width: 2.2 mm	gray
----------------------	------

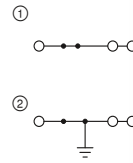

30 A, feed-through and ground terminal block, 3 connections



Ex: EAC Ex IEC KEMA 06ATEX0017 U / IECEx KEM 06.0013U

Technical data¹⁾

Width	Length	Height		
5.2	57.8	47.5 (NS 35/7,5)		
I_{max} [A]	U_{max} [V]	max. Ø [mm ²]	AWG (UL)	
30	500	0.14 - 4	26-12	
24 (FBS) / 17.5 (FBSR)				
IEC	UL / CUL	CSA	Ex	
500	150	150	352	
24 / 2.5	20 / -	20 / -	21 / 2.5	

Ordering data

Type	Order No.	Pcs./Pkt.
UT 2,5-TWIN	^① 3044513	50
UT 2,5-TWIN BU	^① 3044526	50
UT 2,5-TWIN-PE	^② 3044539	50

Accessories¹⁾

D-UT 2,5/4-TWIN	Order No.	Pcs./Pkt.
	3047141	50

Feed-through, multi-conductor, multi-level, and ground terminal blocks

Notes:

¹⁾ For additional accessories and technical data, see page 148.

For information on installation and using accessories for Ex applications, see page 678.

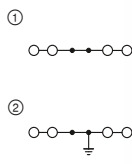

30 A, feed-through and ground terminal block, 4 connections



Ex: EAC Ex IEC KEMA 06ATEX0017 U / IECEx KEM 06.0013U

Technical data¹⁾

Width	Length	Height		
5.2	65.4	47.5 (NS 35/7,5)		
I_{max} [A]	U_{max} [V]	max. Ø [mm ²]	AWG (UL)	
30	500	0.14 - 4	26-12	
24 (FBS) / 17.5 (FBSR)				
IEC	UL / CUL	CSA	Ex	
500	150	150	352	
24 / 2.5	20 / -	20 / -	21 / 2.5	

Ordering data

Type	Order No.	Pcs./Pkt.
UT 2,5-QUATTRO	^① 3044542	50
UT 2,5-QUATTRO BU	^① 3044555	50
UT 2,5-QUATTRO-PE	^② 3044568	50

Accessories¹⁾

D-UT 2,5/4-QUATTRO	Order No.	Pcs./Pkt.
	3047170	50

Dimensions	[mm]
Maximum electrical data	
Maximum bridge current	[A]
Rated data	
Rated voltage	[V]
Nominal current / cross section	[A] / [mm ²]

Description	Color
Terminal block	gray blue
With potential distribution	gray
Ground terminal	green-yellow

Cover, width: 2.2 mm	gray
Spacer plate	gray

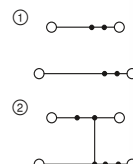

28 A, double-level terminal block and ground terminal



Ex: EAC Ex IEC KEMA 06ATEX0017 U / IECEx KEM 06.0013U

Technical data¹⁾

Width	Length	Height		
5.2	69.9	65 (NS 35/7,5)		
I_{max} [A]	U_{max} [V]	max. Ø [mm ²]	AWG (UL)	
28	500	0.14 - 4	26-12	
24 (FBS) / 17.5 (FBSR)				
IEC	UL / CUL	CSA	Ex	
500	600	600	352	
24 / 2.5	20 / -	20 / -	20 / 2.5	

Ordering data

Type	Order No.	Pcs./Pkt.
UTTB 2,5	^① 3044636	50
UTTB 2,5 BU	^① 3044649	50
UTTB 2,5-PV	^② 3044652	50
UTTB 2,5-PE	^③ 3044665	50

Accessories¹⁾

D-UTTB 2,5/4	Order No.	Pcs./Pkt.
	3047293	50
DP-UTTB 2,5/4	Order No.	Pcs./Pkt.
	3047303	50

Terminal blocks – CLIPLINE complete

2.5 mm² UT screw connection terminal blocks

Feed-through, multi-conductor, multi-level, and ground terminal blocks

Notes:

¹⁾ For additional accessories and technical data, see page 148.

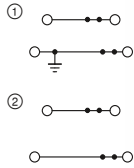

28 A, double-level terminal block with PE foot



Technical data ¹⁾				
Width	Length	Height		
5.2	69.9	65 (NS 35/7,5)		
I _{max.} [A]	U _{max.} [V]	max. Ø [mm ²]	AWG (UL)	
28	500	0.14 - 4	26-12	
24 (FBS) / 17.5 (FBSR)				
IEC	UL / CUL	CSA	Ex	
500	600	600	-	
Nominal current / cross section [A] / [mm ²]				
24 / 2.5 20 / - 20 / - - / -				

Ordering data			
Type	Order No.	Pcs./Pkt.	
UTTB 2,5-PE/L	① 3044678	50	
UTTB 2,5-PE/N	① 3046731	50	
UTTB 2,5-L/N	② 3044681	50	

Accessories ¹⁾			
Type	Order No.	Pcs./Pkt.	
D-UTTB 2,5/4	3047293	50	
DP-UTTB 2,5/4	3047303	50	

Dimensions	[mm]
Maximum electrical data	
Maximum bridge current	[A]
Rated data	
Rated voltage	[V]
Nominal current / cross section	[A] / [mm ²]

Description	Color
Terminal block	gray
upper level blue	blue
upper level blue	gray
with potential distribution	gray
Ground terminal	green-yellow

Cover, width: 2.2 mm	gray
Spacer plate	gray

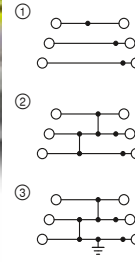

24 A, three-level terminal block and ground terminal



Technical data ¹⁾				
Width	Length	Height		
5.2	90	77.5 (NS 35/7,5)		
I _{max.} [A]	U _{max.} [V]	max. Ø [mm ²]	AWG (UL)	
24	500	0.14 - 4	26-12	
19 (FBS) / 17.5 (FBSR)				
IEC	UL / CUL	CSA	Ex	
500	600	600	-	
Nominal current / cross section [A] / [mm ²]				
19 / 2.5 20 / - 20 / - - / -				

Ordering data			
Type	Order No.	Pcs./Pkt.	
UT 2,5-3L	① 3214259	50	
UT 2,5-3L BU	① 3002389	50	
UT 2,5-3PV	② 3214262	50	
UT 2,5-3PE	③ 3214275	50	

Accessories ¹⁾			
Type	Order No.	Pcs./Pkt.	
D-UT 2,5-3L	3214314	50	

Multi-level terminal blocks

Notes:

¹⁾ For additional accessories and technical data, see page 148.

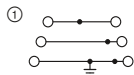

24 A, three-level terminal block with PE foot



Technical data ¹⁾				
Width	Length	Height		
5.2	90	77.5 (NS 35/7,5)		
I _{max.} [A]	U _{max.} [V]	max. Ø [mm ²]	AWG (UL)	
24	500	0.14 - 4	26-12	
19 (FBS) / 17.5 (FBSR)				
IEC	UL / CUL	CSA	Ex	
500	600	600	-	
Nominal current / cross section [A] / [mm ²]				
19 / 2.5 20 / - 20 / - - / -				

Ordering data			
Type	Order No.	Pcs./Pkt.	
UT 2,5-PE/L/L	① 3214301	50	
UT 2,5-PE/L/N	① 3214291	50	

Accessories ¹⁾			
Type	Order No.	Pcs./Pkt.	
D-UT 2,5-3L	3214314	50	

Description	Color
Terminal block	gray
upper level blue	gray
Terminal block, with LED for 12 - 30 V DC, 0.7 - 2.4 mA	gray

Cover, width: 2.2 mm	gray
----------------------	------

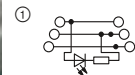

24 A, three-level terminal block with LED display



Technical data ¹⁾				
Width	Length	Height		
5.2	90	77.5 (NS 35/7,5)		
I _{max.} [A]	U _{max.} [V]	max. Ø [mm ²]	AWG (UL)	
24	500	0.14 - 4	26-12	
19 (FBS) / 17.5 (FBSR)				
IEC	UL / CUL	CSA	Ex	
500	600	24	-	
Nominal current / cross section [A] / [mm ²]				
19 / 2.5 20 / - 20 / - - / -				

Ordering data			
Type	Order No.	Pcs./Pkt.	
UT 2,5-3L-LA24RD/O-M	① 3214288	50	

Accessories ¹⁾			
Type	Order No.	Pcs./Pkt.	
D-UT 2,5-3L	3214314	50	

Disconnect terminal blocks

Notes:
 1) For additional accessories and technical data, see page 148.
 2) Current and voltage are determined by the plug used.

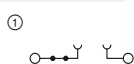

20 A, disconnect terminal block



Technical data ¹⁾				
Dimensions	Width	Length	Height	
	5.2	57.8	47.5 (NS 35/7,5)	
Maximum electrical data	I_{max} [A]	U_{max} [V]	max. Ø [mm ²]	AWG (UL)
	20 ²⁾	400 ²⁾	0.14 - 4	26-12
Maximum bridge current	20 (FBS) / 17.5 (FBSR)			
Rated data	IEC	UL / CUL	CSA	Ex
Rated voltage	400 ²⁾	300	300	-
Nominal current / cross section	20 ²⁾ / 2.5	20 / -	16 / -	- / -
Nominal current / cross section	-	-	-	-

Ordering data			
Description	Color	Type	Order No.
Disconnect terminal block	gray	UT 2,5-TG	3046388
	blue	UT 2,5-TG BU	3046579
With test socket screws	gray	UT 2,5-TG-P/P	3046391
	blue	UT 2,5-TG-P/P BU	3046582

Accessories ¹⁾		
Cover, width: 2.2 mm	gray	D-UT 2,5/4-TWIN
Spacer plate	gray	

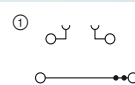

24 A, double-level terminal block with disconnect zone



Technical data ¹⁾			
Dimensions	Width	Length	Height
	5.2	69.9	65 (NS 35/7,5)
Maximum electrical data	I_{max} [A]	U_{max} [V]	max. Ø [mm ²]
	24	400	0.14 - 4
Maximum bridge current	22 (FBS) / 17.5 (FBSR)		
Rated data	IEC	UL / CUL	CSA
Rated voltage	400	300	300
Nominal current / cross section	22 / 2.5	16 / -	16 / -
Nominal current / cross section	16 ²⁾ / 2.5 (disconnect level)	-	-

Ordering data		
Type	Order No.	Pcs./Pkt.
UTT 2,5-TG-P/P	3044644	50

Accessories ¹⁾		
D-UTT 2,5/4	3047293	50
DP-UTT 2,5/4	3047303	50

Disconnect terminal blocks

Notes:
 1) For additional accessories and technical data, see page 148.

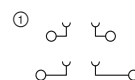

16 A, double-level terminal block with two disconnect zones



Technical data ¹⁾			
Dimensions	Width	Length	Height
	5.2	80.1	58.1 (NS 35/7,5)
Maximum electrical data	I_{max} [A]	U_{max} [V]	max. Ø [mm ²]
	16	400	0.14 - 4
Maximum bridge current	16 (FBS) / 17.5 (FBSR)		
Rated data	IEC	UL / CUL	CSA
Rated voltage	400	300	300
Nominal current / cross section	16 / 2.5	16 / -	16 / -

Ordering data		
Description	Color	Type
Terminal block	gray	UTT 2,5-2TG-P/P

Accessories ¹⁾		
Cover, width: 2.2 mm	gray	D-UTT 2,5/4
Spacer plate, compensates for level offsets, width 2.5 mm	gray	DP-UTT 2,5/4

Ordering data		
Type	Order No.	Pcs./Pkt.
UTT 2,5-2TG-P/P	3044674	50

Accessories ¹⁾		
D-UTT 2,5/4	3044676	50
DP-UTT 2,5/4	3044677	50

Terminal blocks – CLIPLINE complete

2.5 mm² UT screw connection terminal blocks

Knife disconnect terminal blocks

Notes:
 1) For additional accessories and technical data, see page 148.

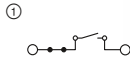

20 A, knife disconnect terminal block



Technical data ¹⁾				
Width	Length	Height		
5.2	57.8	49.1 (NS 35/7,5)		
I _{max.} [A]	U _{max.} [V]	max. Ø [mm ²]	AWG (UL)	
20	400	0.14 - 4	26-12	
20 (FBS) / 17.5 (FBSR)				
IEC	UL / CUL	CSA	Ex	
400	300	300	-	
20 / 2.5				
-				

Ordering data			
Type	Order No.	Pcs./Pkt.	
UT 2,5-MT	3046362	50	
UT 2,5-MT BU	3046553	50	
UT 2,5-MT-P/P	3046375	50	
UT 2,5-MT P/P BU	3046566	50	

Accessories ¹⁾		
	Order No.	Pcs./Pkt.
D-UT 2,5/4-TWIN	3047141	50

Dimensions	[mm]
Maximum electrical data	
Maximum bridge current	[A]
Rated data	
Rated voltage	[V]
Nominal current / cross section	[A] / [mm ²]
Nominal current / cross section	[A] / [mm ²]

Description	Color
Knife disconnect terminal block	gray blue
With test socket screws	gray blue

Cover, width: 2.2 mm	gray
Spacer plate	gray

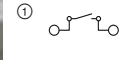

24 A, double-level terminal block with disconnect knife



Technical data ¹⁾				
Width	Length	Height		
5.2	69.9	65 (NS 35/7,5)		
I _{max.} [A]	U _{max.} [V]	max. Ø [mm ²]	AWG (UL)	
24	400	0.14 - 4	26-12	
22 (FBS) / 17.5 (FBSR)				
IEC	UL / CUL	CSA	Ex	
400	300	300	-	
22 / 2.5				
16 / 2.5 (disconnect level)				

Ordering data			
Type	Order No.	Pcs./Pkt.	
UTTB 2,5-MT-P/P	3044640	50	
UTTB 2,5-MT-P/P BU	3044641	50	

Accessories ¹⁾		
	Order No.	Pcs./Pkt.
D-UTTB 2,5/4	3047293	50
DP-UTTB 2,5/4	3047303	50

Knife disconnect terminal blocks

Notes:
 1) For additional accessories and technical data, see page 148.

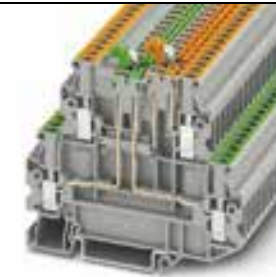
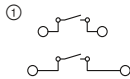

16 A, double-level terminal block with one disconnect knife per level



Technical data ¹⁾				
Width	Length	Height		
5.2	80.1	65 (NS 35/7,5)		
I _{max.} [A]	U _{max.} [V]	max. Ø [mm ²]	AWG (UL)	
16	400	0.14 - 4	-	
16 (FBS) / 17.5 (FBSR)				
IEC	UL / CUL	CSA	Ex	
400	-	-	-	
16 / 2.5				
- / -				

Ordering data			
Type	Order No.	Pcs./Pkt.	
UTT 2,5-2MT	3044679	50	
UTT 2,5-2MT BU	3044680	50	

Accessories ¹⁾		
	Order No.	Pcs./Pkt.
D-UTT 2,5/4	3044676	50
DP-UTT 2,5/4	3044677	50

Dimensions	[mm]
Maximum electrical data	
Rated data	
Rated voltage	[V]
Nominal current / cross section	[A] / [mm ²]

Description	Color
Knife disconnect terminal block	gray blue
With test socket screws	gray blue

Cover, width: 2.2 mm	gray
Spacer plate, compensates for level offsets, width 2.5 mm	gray

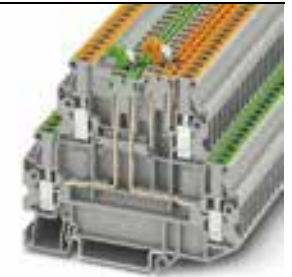
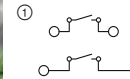

16 A, double-level terminal block with a disconnect knife per level, test socket screw



Technical data ¹⁾				
Width	Length	Height		
5.2	80.1	65 (NS 35/7,5)		
I _{max.} [A]	U _{max.} [V]	max. Ø [mm ²]	AWG (UL)	
16	400	0.14 - 4	26-12	
16 (FBS) / 17.5 (FBSR)				
IEC	UL / CUL	CSA	Ex	
400	300	300	-	
16 / 2.5				
16 / -				

Ordering data			
Type	Order No.	Pcs./Pkt.	
UTT 2,5-2MT-P/P	3044670	50	
UTT 2,5-2MT-P/P BU	3044671	50	

Accessories ¹⁾		
	Order No.	Pcs./Pkt.
D-UTT 2,5/4	3044676	50
DP-UTT 2,5/4	3044677	50

Diode and LED terminal blocks

Notes:
 1) For additional accessories and technical data, see page 148.

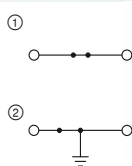

32 A, feed-through and ground terminal block, same shape



Technical data ¹⁾				
Dimensions	Width	Length	Height	
[mm]	5.2	57.8	47.5 (NS 35/7,5)	
Maximum electrical data	I_{max} [A]	U_{max} [V]	max. Ø [mm ²]	AWG (UL)
	32	800	0.14 - 4	26-12
Maximum bridge current	24 (FBS) / 17.5 (FBSR)			
Rated data	IEC	UL / CUL	CSA	Ex
Rated voltage	800	600	600	-
Nominal current / cross section	24 / 2.5	20 / -	20 / -	- / -

Ordering data			
Type	Order No.	Pcs./Pkt.	
UT 2,5-MTD	① 3064085	50	
UT 2,5-MTD BU	① 3064108	50	
UT 2,5-MTD P/P	① 3064098	50	
UT 2,5-MTD-PE	② 3064124	50	

Accessories ¹⁾		
D-UT 2,5/4-TWIN	Order No.	Pcs./Pkt.
D-UT 2,5/4-TWIN	3047141	50

Description	Color
Terminal block	gray
With test socket screws	gray
Ground terminal	green-yellow
Terminal block, for conducting direction see circuit diagram	gray
Cover, width: 2.2 mm	gray

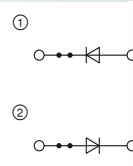

0.5 A, diode terminal block, 1N 4007 (1300 V/0.5 A)



Technical data ¹⁾				
Dimensions	Width	Length	Height	
[mm]	5.2	57.8	47.5 (NS 35/7,5)	
Maximum electrical data	I_{max} [A]	U_{max} [V]	max. Ø [mm ²]	AWG (UL)
	0.5	800	0.14 - 4	26-12
Maximum bridge current	0.5 (FBS) / 0.5 (FBSR)			
Rated data	IEC	UL / CUL	CSA	Ex
Rated voltage	800	600	600	-
Nominal current / cross section	0.5 / 1	0.5 / -	0.5 / -	- / -

Ordering data			
Type	Order No.	Pcs./Pkt.	
UT 2,5-MTD-DIO/R-L	① 3064140	50	
UT 2,5-MTD-DIO/L-R	② 3064137	50	

Accessories ¹⁾		
D-UT 2,5/4-TWIN	Order No.	Pcs./Pkt.
D-UT 2,5/4-TWIN	3047141	50

Diode and LED terminal blocks

Notes:
 1) For additional accessories and technical data, see page 148.

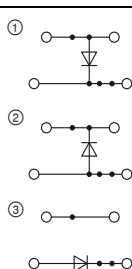

28 A, double-level diode terminal block, 1N 4007 (1300 V/0.5 A)



Technical data ¹⁾				
Dimensions	Width	Length	Height	
[mm]	5.2	69.9	65 (NS 35/7,5)	
Maximum electrical data	I_{max} [A]	U_{max} [V]	max. Ø [mm ²]	AWG (UL)
	28	500	0.14 - 4	26-12
Maximum bridge current	24 (FBS) / 17.5 (FBSR)			
Rated data	IEC	UL / CUL	CSA	Ex
Rated voltage	500	600	300	-
Nominal current / cross section	24 / 2.5	20 / -	1 / -	- / -

Ordering data			
Type	Order No.	Pcs./Pkt.	
UTTB 2,5-DIO/O-U	① 3046650	50	
UTTB 2,5-DIO/U-O	② 3046663	50	
UTTB 2,5-DIO/UL-UR	③ 3046728	50	

Accessories ¹⁾		
D-UTTB 2,5/4	Order No.	Pcs./Pkt.
D-UTTB 2,5/4	3047293	50
DP-UTTB 2,5/4	3047303	50

Description	Color
Terminal block, for conducting direction see circuit diagram	gray
	gray
	gray
	gray
	gray
Cover, width: 2.2 mm	gray
Spacer plate	gray

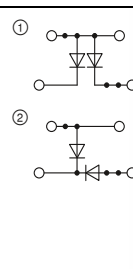

28 A, double-level terminal block with two 1N 4007 diodes (1300 V/0.5 A)



Technical data ¹⁾				
Dimensions	Width	Length	Height	
[mm]	5.2	69.9	65 (NS 35/7,5)	
Maximum electrical data	I_{max} [A]	U_{max} [V]	max. Ø [mm ²]	AWG (UL)
	28	500	0.14 - 4	26-12
Maximum bridge current	24 (FBS) / 17.5 (FBSR)			
Rated data	IEC	UL / CUL	CSA	Ex
Rated voltage	500	600	300	-
Nominal current / cross section	24 / 2.5	20 / -	1 / -	- / -

Ordering data			
Type	Order No.	Pcs./Pkt.	
UTTB 2,5-2DIO/O-UL/O-UR	① 3046689	50	
UTTB 2,5-2DIO/O-UL/UR-UL	② 3046676	50	

Accessories ¹⁾		
D-UTTB 2,5/4	Order No.	Pcs./Pkt.
D-UTTB 2,5/4	3047293	50
DP-UTTB 2,5/4	3047303	50

Terminal blocks – CLIPLINE complete

2.5 mm² UT screw connection terminal blocks

Diode and LED terminal blocks

Notes:
 1) For additional accessories and technical data, see page 148.
 2) The voltage is determined by the LED display version selected.

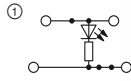

28 A, double-level terminal block with LED display



Technical data ¹⁾				
Width	Length	Height		
5.2	69.9	65 (NS 35/7,5)		
I _{max.} [A]	U _{max.} [V]	max. Ø [mm ²]	AWG (UL)	
28	24 ²⁾	0.14 - 4	26-12	
24 (FBS) / 17.5 (FBSR)				
IEC	UL / CUL	CSA	Ex	
24 ²⁾	600	24	-	
24 / 2.5	20 / -	20 / -	- / -	

Ordering data			
Type	Order No.	Pcs./Pkt.	
UTTB 2,5-LA 24 RD	3046692	50	
UTTB 2,5-LA 60 RD	3046702	50	
UTTB 2,5-LA 230	3046715	50	

Accessories ¹⁾			
Type	Order No.	Pcs./Pkt.	
D-UTTB 2,5/4	3047293	50	
DP-UTTB 2,5/4	3047303	50	

Dimensions	[mm]
Maximum electrical data	
Maximum bridge current	[A]
Rated data	
Rated voltage	[V]
Nominal current / cross section	[A] / [mm ²]

Description	Color
Terminal block, with LED for 12 - 30 V DC, 0.7 - 2.4 mA	gray
for 30 - 60 V DC, 0.8 - 1.8 mA	gray
for 110 - 250 V AC/DC, 0.1 - 0.5 mA	gray
Terminal block, component can be soldered in	gray

Cover, width: 2.2 mm	gray
Spacer plate	gray

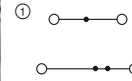

28 A, double-level terminal block for soldering in components



Technical data ¹⁾				
Width	Length	Height		
5.2	69.9	65 (NS 35/7,5)		
I _{max.} [A]	U _{max.} [V]	max. Ø [mm ²]	AWG (UL)	
28	500	0.14 - 4	26-12	
24 (FBS) / 17.5 (FBSR)				
IEC	UL / CUL	CSA	Ex	
500	600	600	-	
24 / 2.5	20 / -	20 / -	- / -	

Ordering data			
Type	Order No.	Pcs./Pkt.	
UTTB 2,5-BE	3046744	50	

Accessories ¹⁾			
Type	Order No.	Pcs./Pkt.	
D-UTTB 2,5/4	3047293	50	
DP-UTTB 2,5/4	3047303	50	

Installation terminal blocks

Notes:
 1) For additional accessories and technical data, see page 148.
 2) 3-pos. termination block.

Assembly instruction:
 In order to securely fix the neutral busbar in place, support brackets must be placed at the beginning and end of each terminal strip as well as every 20 cm on longer terminal strips. The corresponding support brackets can be found via web code #0060.

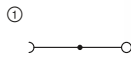

24 A, neutral disconnect terminal block



Technical data ¹⁾				
Width	Length	Height		
5.2	55	47.5 (NS 35/7,5)		
I _{max.} [A]	U _{max.} [V]	max. Ø [mm ²]	AWG (UL)	
24	250	0.14 - 4	-	
24 (FBS) / 17.5 (FBSR)				
IEC	UL / CUL	CSA	Ex	
250	-	-	-	
24 / 2.5	- / -	- / -	- / -	
Connection capacity				
	Rigid	Flexible	Ferrule without/with plastic sleeve	
1 conductor	0.14 - 4	0.14 - 4	0.25 - 2.5	0.25 - 2.5
2 conductors (of the same type)	0.14 - 1.5	0.14 - 1.5	0.25 - 1.5	-

Ordering data			
Type	Order No.	Pcs./Pkt.	
UTN 2,5	3245011	50	

Accessories ¹⁾			
Type	Order No.	Pcs./Pkt.	
D-UTN 2,5/10	3245079	50	

Dimensions	[mm]
Maximum electrical data	
Maximum bridge current	[A]
Rated data	
Rated voltage	[V]
Nominal current / cross section	[A] / [mm ²]
Rated cross section	[mm ²]
Cross section range	AWG
Connection capacity	
1 conductor	[mm ²]
2 conductors (of the same type)	[mm ²]

Description	Color
Terminal block	blue gray

Cover, width: 2.2 mm	blue
----------------------	------

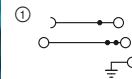

4 (4) mm², 30 A, three-level terminal block, 1 x L phase conductor, 1 x N conductor can be disconnected, 1 x PE



Technical data ¹⁾				
Width	Length	Height		
5.2	93.5	51.5 (NS 35/7,5)		
I _{max.} [A]	U _{max.} [V]	max. Ø [mm ²]	AWG (UL)	
30 ²⁾	400	0.2 - 4	26-12	
24 (FBS) / 17.5 (FBSR)				
IEC	UL / CUL	CSA	Ex	
400	300	300	-	
24 / 4	20 / -	- / -	- / -	
4	-	-	-	
24 - 12	-	-	-	
Connection capacity				
	Rigid	Flexible	Ferrule without/with plastic sleeve	
0.2 - 4	0.2 - 4	0.25 - 2.5	0.25 - 2.5	0.25 - 2.5
0.2 - 1.5	0.2 - 1.5	0.25 - 0.75	-	

Ordering data			
Type	Order No.	Pcs./Pkt.	
UTI 2,5-PE/L/NT	3076028	50	

Accessories ¹⁾			
Type	Order No.	Pcs./Pkt.	
D-UTI/3	3076036	50	

Installation terminal blocks

Notes:
 1) For additional accessories and technical data, see page 148.
 2) 3-pos. termination block.

Assembly instruction:
 In order to securely fix the neutral busbar in place, support brackets must be placed at the beginning and end of each terminal strip as well as every 20 cm on longer terminal strips. The corresponding support brackets can be found via web code #0060.

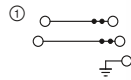

**4 (4) mm², 30 A, three-level terminal block,
2 x L phase conductor, 1 x PE**



Technical data ¹⁾				
Width	Length	Height		
5.2	93.5	51.5 (NS 35/7,5)		
I _{max} [A]	U _{max} [V]	max. Ø [mm ²]	AWG (UL)	
30 ²⁾	400	0.2 - 4	26-12	
24 (FBS) / 17.5 (FBSR)				
IEC	UL / CUL	CSA	Ex	
400	300	300	-	
Nominal current / cross section [A] / [mm ²]				
24 / 4	20 / -	- / -	- / -	
Rated cross section [mm ²]				
4				
Cross section range AWG				
24 - 12				
Rigid		Flexible	Ferrule without/with plastic sleeve	
0.2 - 4	0.2 - 4	0.25 - 2.5	0.25 - 2.5	
2 conductors (of the same type) [mm ²]				
0.2 - 1.5	0.2 - 1.5	0.25 - 0.75	-	

Ordering data			
Type	Order No.	Pcs./Pkt.	
UTI 2,5-PE/L/L	3076029	50	

Accessories ¹⁾			
D-UTI/3	3076036	50	

Dimensions	
	[mm]
Maximum electrical data	
Maximum bridge current	[A]
Rated data	
Rated voltage	[V]
Nominal current / cross section	[A] / [mm ²]
Rated cross section	[mm ²]
Cross section range	AWG
Connection capacity	
1 conductor	[mm ²]
2 conductors (of the same type)	[mm ²]
Description	Color
Terminal block	gray
Cover, width: 2.2 mm	gray

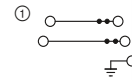

**4 (4) mm², 30 A, three-level terminal block,
1 x L phase conductor, 1 x N conductor, 1 x PE**



Technical data ¹⁾				
Width	Length	Height		
5.2	93.5	51.5 (NS 35/7,5)		
I _{max} [A]	U _{max} [V]	max. Ø [mm ²]	AWG (UL)	
30 ²⁾	400	0.2 - 4	26-12	
24 (FBS) / 17.5 (FBSR)				
IEC	UL / CUL	CSA	Ex	
400	300	300	-	
Nominal current / cross section [A] / [mm ²]				
24 / 4	20 / -	- / -	- / -	
Rated cross section [mm ²]				
4				
Cross section range AWG				
24 - 12				
Rigid		Flexible	Ferrule without/with plastic sleeve	
0.2 - 4	0.2 - 4	0.25 - 2.5	0.25 - 2.5	
2 conductors (of the same type) [mm ²]				
0.2 - 1.5	0.2 - 1.5	0.25 - 0.75	-	

Ordering data			
Type	Order No.	Pcs./Pkt.	
UTI 2,5-PE/L/N	3076030	50	

Accessories ¹⁾			
D-UTI/3	3076036	50	

Installation terminal blocks

Notes:
 1) For additional accessories and technical data, see page 148.
 2) 3-pos. termination block.

Assembly instruction:
 In order to securely fix the neutral busbar in place, support brackets must be placed at the beginning and end of each terminal strip as well as every 20 cm on longer terminal strips. The corresponding support brackets can be found via web code #0060.



**4 (4) mm², 30 A, three-level terminal block,
1 x L phase conductor, 1 x N conductor**



Technical data ¹⁾				
Width	Length	Height		
5.2	93.5	51.5 (NS 35/7,5)		
I _{max} [A]	U _{max} [V]	max. Ø [mm ²]	AWG (UL)	
30 ²⁾	400	0.2 - 4	26-12	
24 (FBS) / 17.5 (FBSR)				
IEC	UL / CUL	CSA	Ex	
400	300	300	-	
Nominal current / cross section [A] / [mm ²]				
24 / 4	20 / -	20 / -	- / -	
Rated cross section [mm ²]				
4				
Cross section range AWG				
24 - 12				
Rigid		Flexible	Ferrule without/with plastic sleeve	
0.2 - 4	0.2 - 4	0.25 - 2.5	0.25 - 2.5	
2 conductors (of the same type) [mm ²]				
0.2 - 1.5	0.2 - 1.5	0.25 - 0.75	-	

Ordering data			
Type	Order No.	Pcs./Pkt.	
UTI 2,5-L/N	3076035	50	
UTI 2,5-L/L	3076031	50	

Accessories ¹⁾			
D-UTI/3	3076036	50	

Dimensions	
	[mm]
Maximum electrical data	
Maximum bridge current	[A]
Rated data	
Rated voltage	[V]
Nominal current / cross section	[A] / [mm ²]
Rated cross section	[mm ²]
Cross section range	AWG
Connection capacity	
1 conductor	[mm ²]
2 conductors (of the same type)	[mm ²]
Description	Color
Terminal block, upper level blue	gray
	gray
Cover, width: 2.2 mm	gray

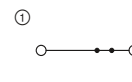

**4 (4) mm², 30 A, three-level terminal block,
1 x L phase conductor**



Technical data ¹⁾				
Width	Length	Height		
5.2	93.5	51.5 (NS 35/7,5)		
I _{max} [A]	U _{max} [V]	max. Ø [mm ²]	AWG (UL)	
30 ²⁾	400	0.2 - 4	26-12	
24 (FBS) / 17.5 (FBSR)				
IEC	UL / CUL	CSA	Ex	
400	300	300	-	
Nominal current / cross section [A] / [mm ²]				
24 / 4	20 / -	20 / -	- / -	
Rated cross section [mm ²]				
4				
Cross section range AWG				
24 - 12				
Rigid		Flexible	Ferrule without/with plastic sleeve	
0.2 - 4	0.2 - 4	0.25 - 2.5	0.25 - 2.5	
2 conductors (of the same type) [mm ²]				
0.2 - 1.5	0.2 - 1.5	0.25 - 0.75	-	

Ordering data			
Type	Order No.	Pcs./Pkt.	
UTI 2,5-L	3076034	50	

Accessories ¹⁾			
D-UTI/3	3076036	50	

Terminal blocks – CLIPLINE complete

2.5 mm² UT screw connection terminal blocks

Installation terminal blocks

Notes:

¹⁾ For additional accessories and technical data, see page 148.

²⁾ 3-pos. termination block.

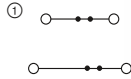

**4 (4) mm², 30 A, three-level terminal block,
2 x L phase conductor**

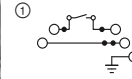

**4 (4) mm², 24 A, three-level terminal block,
1 x L phase conductor, 1 x N conductor
can be disconnected, 1 x PE**



	Technical data ¹⁾			
	Width	Length	Height	
Dimensions	5.2	93.5	51.5 (NS 35/7,5)	
	[mm]			
Maximum electrical data	I_{max.} [A]	U_{max.} [V]	max. Ø [mm²]	AWG (UL)
	30²⁾	400	0.2 - 4	26-12
Maximum bridge current	24 (FBS) / 17.5 (FBSR)			
Rated data	IEC	UL / CUL	CSA	Ex
Rated voltage	400	300	300	-
Nominal current / cross section	[A] / [mm ²]	24 / 4	20 / -	20 / -
Rated cross section	[mm ²]	4	-	-
Cross section range	AWG	24 - 12	-	-
Nominal current / cross section	[A] / [mm ²]	16 / 1.5 (disconnect level)		
Connection capacity	Rigid	Flexible	Ferrule without/with plastic sleeve	
1 conductor	[mm ²]	0.2 - 4	0.2 - 4	0.25 - 2.5 0.25 - 2.5
2 conductors (of the same type)	[mm ²]	0.2 - 1.5	0.2 - 1.5	0.25 - 0.75 -

	Technical data ¹⁾			
	Width	Length	Height	
Dimensions	5.2	93.5	51.5 (NS 35/7,5)	
	[mm]			
Maximum electrical data	I_{max.} [A]	U_{max.} [V]	max. Ø [mm²]	AWG (UL)
	24²⁾	400	0.2 - 4	26-12
Maximum bridge current	24 (FBS) / 17.5 (FBSR)			
Rated data	IEC	UL / CUL	CSA	Ex
Rated voltage	400	300	300	-
Nominal current / cross section	[A] / [mm ²]	21 / 4	20 / -	- / -
Rated cross section	[mm ²]	4	-	-
Cross section range	AWG	24 - 12	-	-
Nominal current / cross section	[A] / [mm ²]	16 / 4 (disconnect level)		
Connection capacity	Rigid	Flexible	Ferrule without/with plastic sleeve	
1 conductor	[mm ²]	0.2 - 4	0.25 - 2.5	0.25 - 2.5
2 conductors (of the same type)	[mm ²]	0.2 - 1.5	0.25 - 0.75	-

Ordering data			
Description	Color	Type	Order No.
Terminal block	gray	UTI 2,5-L/LB	3076033
			Pcs./Pkt. 50

Ordering data			
Description	Color	Type	Order No.
Terminal block	gray	UTI 2,5-PE/L/NTB	3076032
			Pcs./Pkt. 50

Accessories ¹⁾			
Accessories	Order No.	Pcs./Pkt.	
D-UTI/3	3076036	50	

Accessories ¹⁾			
Accessories	Order No.	Pcs./Pkt.	
D-UTI/3	3076036	50	

Mini feed-through and ground terminal blocks

Notes:

¹⁾ For additional accessories and technical data, see page 148.

For information on installation and using accessories for Ex applications, see page 678.

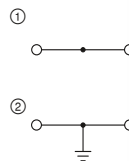

32 A, feed-through and ground terminal block



Ex: EAC Ex IEC Ex UL Ex
SEV13ATEX0178U / IECEx SEV13.0012U

Technical data¹⁾

Dimensions	Width	Length	Height	
	5.2	29.9	34 (NS 15)	
Maximum electrical data	I_{max} [A]	U_{max} [V]	max. \varnothing [mm ²]	AWG (UL)
	32	500	0.2 - 4	24-12
Maximum bridge current	21 (FBS) / 17.5 (FBSR) [A]			
Rated data	IEC	UL / CUL	CSA	Ex
Rated voltage	500	300	600	352
Nominal current / cross section	24 / 2.5 [A] / [mm ²]		20 / - 20.5 / 4	
Cross section range	24 - 12 AWG			
Connection capacity	Rigid	Flexible	Ferrule without/with plastic sleeve	
1 conductor	0.2 - 4 [mm ²]	0.2 - 4	0.25 - 2.5	0.25 - 2.5
2 conductors (of the same type)	0.2 - 1.5 [mm ²]	0.2 - 1.5	0.25 - 1.5	-

Ordering data

Description	Color	Type	Order No.	Pcs./Pkt.
Terminal block	gray	MUT 2,5	^① 3248030	50
	blue	MUT 2,5 BU	^① 3248031	50
Ground terminal	green-yellow	MUT 2,5-PE	^② 3248032	50

Accessories¹⁾

Description	Order No.	Pcs./Pkt.
Cover, width: 2.2 mm	D-MUT 2,5/4 3248033	50

Terminal blocks – CLIPLINE complete

4 mm² UT screw connection terminal blocks

General technical data

Rated data	IEC 60947-7-1 / IEC 60947-7-2 / IEC 60947-7-3			
Rated cross section	[mm ²]	4		
Cross section range	AWG	26 - 10		
Connection capacity		Rigid	Flexible	Ferrule without/with plastic sleeve
1 conductor	[mm ²]	0.14 - 6	0.14 - 6	0.14 - 4 0.14 - 4
2 conductors (of the same type)	[mm ²]	0.14 - 1.5	0.14 - 1.5	0.14 - 1.5 -
2 flexible conductors with a TWIN ferrule	[mm ²]	-	-	- 0.5 - 2.5
General data				
Stripping length	[mm]	9		
Screw thread		M3		
Tightening torque	[Nm]	0.6 - 0.8		
Insulating material		PA		
Flammability rating in accordance with UL 94		VO		

Note: Additional or deviating data is listed alongside the respective product.

Notes:



In addition to the product, the internal electrical wiring is provided as a circuit diagram. Free connection points for bridging are indicated by a black dot.

The specified technical data and approvals refer to the first product in each column. For information on the products below, please refer to phoenixcontact.net/products

For full details of UL and CSA use groups, file nos., and Internet links, please visit phoenixcontact.net/products

¹⁾ The bridge current is listed alongside the respective product. For additional colors, see page 402.

System accessories

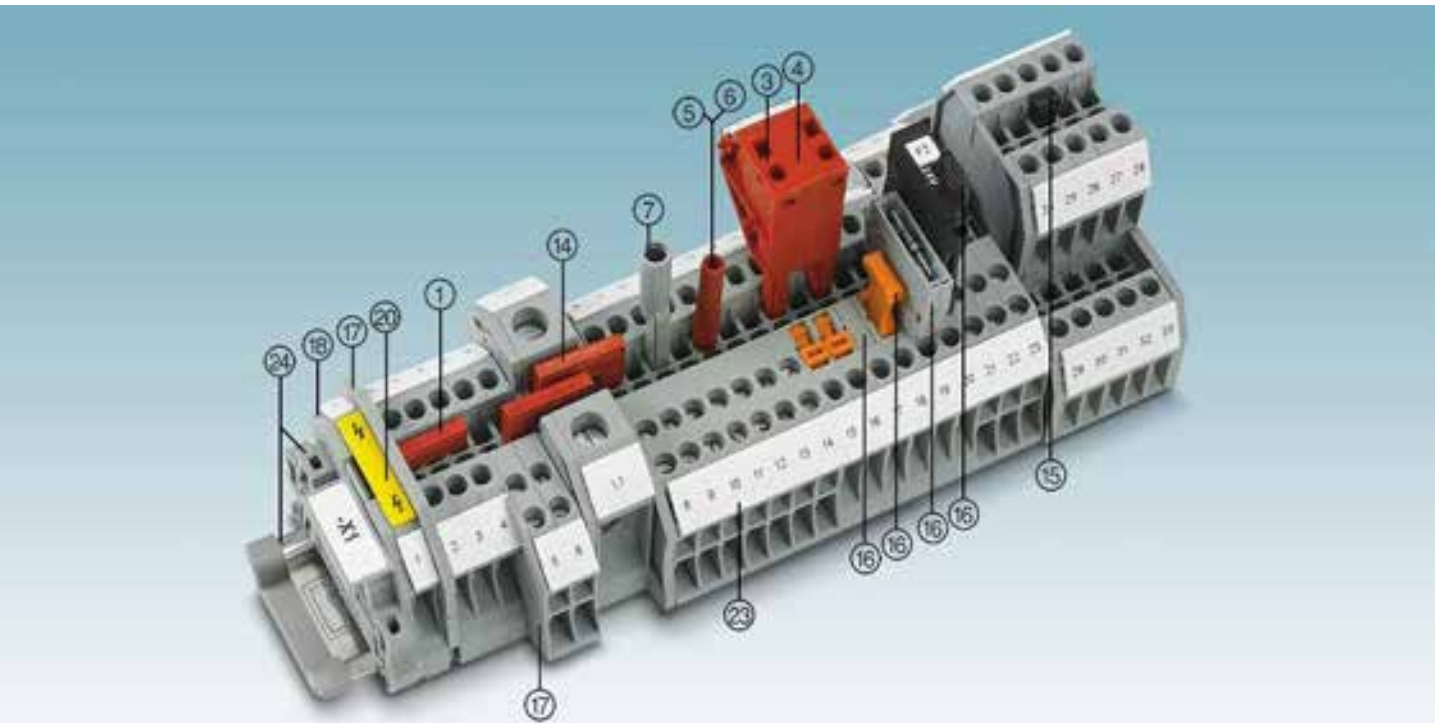

Description	No. of pos.	Color	Type	Order No.	Pcs./Pkt.	Type	Order No.	Pcs./Pkt.
① Bridge ¹⁾	2	red	FBS 2-6	3030336	50	FBSR 2-6	3033715	50
	3	red	FBS 3-6	3030242	50	FBSR 3-6	3001594	50
	4	red	FBS 4-6	3030255	50	FBSR 4-6	3001595	50
	5	red	FBS 5-6	3030349	50	FBSR 5-6	3001596	50
	10	red	FBS 10-6	3030271	10	FBSR 10-6	3033716	10
	20	red	FBS 20-6	3030365	10			
③ Modular test plug		red	PS-6	3030996	10			
④ Spacer plate		red	DP PS-6	3036738	10			
⑤ Test plug metal part		gray	MPS-MT	0201744	10			
⑥ Insulating sleeve, for MPS metal part		red	MPS-IH RD	0201676	10			
⑦ Test adapter, 4 mm socket hole		gray	PAI-4-N GY	3032871	10			
Screwdriver			SF-SL 0,6X3,5-100 S-VDE	1212587	10			

⑭ Reducing bridge	For RB ..., see page 408.
⑮ Vertical potential bridge	For FBS-PV ..., see page 404.
⑯ Fuse and function plugs for disconnect terminal blocks	For P-FU ... / P-DI / P-FIX / P-CO ..., see from page 414.
⑰ Partition plates/end cover segments	For ATP-... / DS-..., visit phoenixcontact.net/products
⑱ Cover	Listed alongside the respective product.
⑳ Warning labels	For WS ..., see page 420.
㉑ Lateral groove labeling	UC-TM 6, UCT-TM 6 or ZB 6. See also Catalog 3, selection tables, from page 60.
㉒ DIN rail and end bracket	See Catalog 3
For full accessories, visit phoenixcontact.net/products	Note: Additional or deviating accessories are listed alongside the respective product.

Feed-through, multi-conductor, multi-level, and ground terminal blocks

Notes:
 1) For additional accessories and technical data, see page 158.
 For information on installation and using accessories for Ex applications, see page 678.

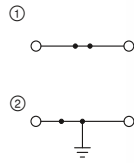

41 A, feed-through and ground terminal block



Ex: EAC Ex IEC CB
 KEMA 04ATEX2048 U / IECEx KEM 06.0027U

Technical data¹⁾

Width	Length	Height		
6.2	47.7	47.5 (NS 35/7,5)		
I_{max} [A]	U_{max} [V]	max. Ø [mm ²]	AWG (UL)	
41	1000	0.14 - 6	26-10	
32 (FBS) / 24 (FBSR)				
IEC	UL / CUL	CSA	Ex	
1000	600	600	690	
32 / 4	30 / -	30 / -	30 / 4	

Ordering data

Type	Order No.	Pcs./Pkt.
UT 4	① 3044102	50
UT 4 BU	① 3044115	50
UT 4-PE	② 3044128	50

Accessories¹⁾

D-UT 2,5/10	3047028	50
-------------	---------	----

Dimensions	[mm]
Maximum electrical data	
Maximum bridge current	[A]
Rated data	
Rated voltage	[V]
Nominal current / cross section	[A] / [mm ²]

Description	Color
Terminal block	gray blue
Ground terminal	green-yellow

Cover, width: 2.2 mm	gray
----------------------	------

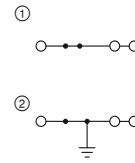

41 A, feed-through and ground terminal block, 3 connections



Ex: EAC Ex IEC CB
 KEMA 06ATEX0017 U / IECEx KEM 06.0013U

Technical data¹⁾

Width	Length	Height		
6.2	57.8	47.5 (NS 35/7,5)		
I_{max} [A]	U_{max} [V]	max. Ø [mm ²]	AWG (UL)	
41	500	0.14 - 6	26-10	
32 (FBS) / 24 (FBSR)				
IEC	UL / CUL	CSA	Ex	
500	150	150	352	
32 / 4	30 / -	30 / -	29 / 4	

Ordering data

Type	Order No.	Pcs./Pkt.
UT 4-TWIN	① 3044364	50
UT 4-TWIN BU	① 3044500	50
UT 4-TWIN-PE	② 3044380	50

Accessories¹⁾

D-UT 2,5/4-TWIN	3047141	50
-----------------	---------	----

Feed-through, multi-conductor, multi-level, and ground terminal blocks

Notes:
 1) For additional accessories and technical data, see page 158.
 For information on installation and using accessories for Ex applications, see page 678.

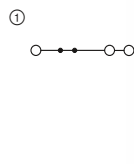

39 A, 1000 V, feed-through terminal block, 3 connections



Ex: EAC Ex IEC CB
 SEV13ATEX0133U / IECEx SEV13.0004U

Technical data¹⁾

Width	Length	Height		
6.2	57.8	50 (NS 35/7,5)		
I_{max} [A]	U_{max} [V]	max. Ø [mm ²]	AWG (UL)	
39	1000	0.14 - 6	26-10	
32 (FBS) / 24 (FBSR)				
IEC	UL / CUL	CSA	Ex	
1000	600	600	550	
32 / 4	30 / -	30 / -	27 / 4	

Ordering data

Type	Order No.	Pcs./Pkt.
UT 4-TWIN HV	① 3000608	50

Accessories¹⁾

D-UT 4-TWIN HV	3000710	50
----------------	---------	----

Dimensions	[mm]
Maximum electrical data	
Maximum bridge current	[A]
Rated data	
Rated voltage	[V]
Nominal current / cross section	[A] / [mm ²]

Description	Color
Terminal block	gray blue
Ground terminal	green-yellow

Cover, width: 2.2 mm	gray
----------------------	------

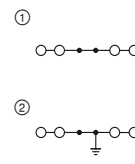

39 A, feed-through and ground terminal block, 4 connections



Ex: EAC Ex IEC CB
 KEMA 06ATEX0017 U / IECEx KEM 06.0013U

Technical data¹⁾

Width	Length	Height		
6.2	65.4	47.5 (NS 35/7,5)		
I_{max} [A]	U_{max} [V]	max. Ø [mm ²]	AWG (UL)	
39	500	0.14 - 6	26-10	
32 (FBS) / 24 (FBSR)				
IEC	UL / CUL	CSA	Ex	
500	150	150	352	
32 / 4	30 / -	30 / -	29 / 4	

Ordering data

Type	Order No.	Pcs./Pkt.
UT 4-QUATTRO	① 3044571	50
UT 4-QUATTRO BU	① 3044584	50
UT 4-QUATTRO-PE	② 3044597	50

Accessories¹⁾

D-UT 2,5/4-QUATTRO	3047170	50
--------------------	---------	----

Terminal blocks – CLIPLINE complete

4 mm² UT screw connection terminal blocks

Feed-through, multi-conductor, multi-level, and ground terminal blocks

Notes:
 1) For additional accessories and technical data, see page 158.
 For information on installation and using accessories for Ex applications, see page 678.

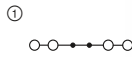

37 A, 1000 V, feed-through terminal block, 4 connections

Ex: EAC Ex IEC Ex
 SEV13ATEX0133U / IECEx SEV13.0004U

Technical data ¹⁾				
Width	Length	Height		
6.2	65.4	50 (NS 35/7,5)		
I _{max.} [A]	U _{max.} [V]	max. Ø [mm ²]	AWG (UL)	
37	1000	0.14 - 6	-	
32 (FBS) / 24 (FBSR)				
IEC	UL / CUL	CSA	Ex	
1000	-	-	550	
32 / 4	- / -	- / -	27 / 4	

Ordering data			
Type	Order No.	Pcs./Pkt.	
UT 4-QUATTRO HV	① 3048823	50	
UT 4-QUATTRO HV BU	① 3048836	50	

Accessories ¹⁾			
Type	Order No.	Pcs./Pkt.	
D-UT 4-QUATTRO HV	3048852	50	

Dimensions	[mm]
Maximum electrical data	
Maximum bridge current	[A]
Rated data	
Rated voltage	[V]
Nominal current / cross section	[A] / [mm ²]

Description	Color
Terminal block	gray
With potential distribution	blue
Ground terminal	gray
	green-yellow

Cover, width: 2.2 mm	gray
Spacer plate	gray

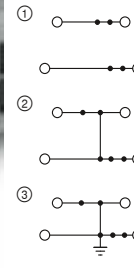

36 A, double-level terminal block and ground terminal

Ex: EAC Ex IEC Ex
 KEMA 06ATEX0017 U / IECEx KEM 06.0013U

Technical data ¹⁾				
Width	Length	Height		
6.2	69.9	65 (NS 35/7,5)		
I _{max.} [A]	U _{max.} [V]	max. Ø [mm ²]	AWG (UL)	
36	800	0.14 - 6	26-10	
30 (FBS) / 24 (FBSR)				
IEC	UL / CUL	CSA	Ex	
800	600	600	440	
30 / 4	30 / -	30 / -	25.5 / 4	

Ordering data			
Type	Order No.	Pcs./Pkt.	
UTTB 4	① 3044814	50	
UTTB 4 BU	① 3044791	50	
UTTB 4-PV	② 3044733	50	
UTTB 4-PE	③ 3044759	50	

Accessories ¹⁾			
Type	Order No.	Pcs./Pkt.	
D-UTTB 2,5/4	3047293	50	
DP-UTTB 2,5/4	3047303	50	

Feed-through, multi-conductor, multi-level, and ground terminal blocks

Notes:
 1) For additional accessories and technical data, see page 158.
 For information on installation and using accessories for Ex applications, see page 678.

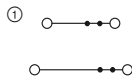

36 A, 1000 V, double-level terminal block, 2 connections top level

Ex: EAC Ex

Technical data ¹⁾				
Width	Length	Height		
6.2	75.6	65 (NS 35/7,5)		
I _{max.} [A]	U _{max.} [V]	max. Ø [mm ²]	AWG (UL)	
36	1000	0.14 - 6	26-10	
26 (FBS) / 24 (FBSR)				
IEC	UL / CUL	CSA	Ex	
1000	600	600	-	
30 / 4	30 / -	30 / -	- / -	

Ordering data			
Type	Order No.	Pcs./Pkt.	
UTTB 4 HV	① 3000610	50	

Accessories ¹⁾			
Type	Order No.	Pcs./Pkt.	
D-UTTB 4 HV	3000709	50	

Dimensions	[mm]
Maximum electrical data	
Maximum bridge current	[A]
Rated data	
Rated voltage	[V]
Nominal current / cross section	[A] / [mm ²]

Description	Color
Terminal block	gray
	gray
	gray
	gray

Cover, width: 2.2 mm	gray
----------------------	------

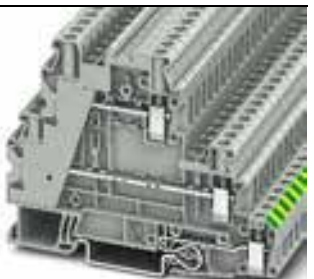
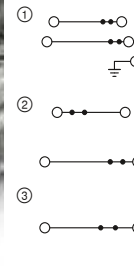

36 A, multi-level terminal block with PE foot

Ex: EAC Ex IEC Ex
 KIWA 14ATEX0025U / IECEx KIWA14.0014U

Technical data ¹⁾				
Width	Length	Height		
6.2	92.7	61.7 (NS 35/7,5)		
I _{max.} [A]	U _{max.} [V]	max. Ø [mm ²]	AWG (UL)	
36	500	0.14 - 6	26-10	
28 (FBS) / 24 (FBSR)				
IEC	UL / CUL	CSA	Ex	
500	300	300	500	
30 / 4	16 / -	16 / -	26 / 4	

Ordering data			
Type	Order No.	Pcs./Pkt.	
UT 4-PE/L/L	① 3214360	50	
UT 4-PE/L/N	① 3214361	50	
UT 4-L/L	② 3214362	50	
UT 4-L	③ 3214363	50	

Accessories ¹⁾			
Type	Order No.	Pcs./Pkt.	

Fuse terminal blocks and lever-type disconnect terminal blocks of the same shape

Notes:
¹⁾ For additional accessories and technical data, see page 158.
²⁾ If the fuse is faulty, the downstream circuit is not off load.
³⁾ For max. power dissipation, see page 694.
⁴⁾ The current is determined by the fuse used, the voltage by the LED display.
For lever marking, please use marking material with a 5.2 mm pitch.

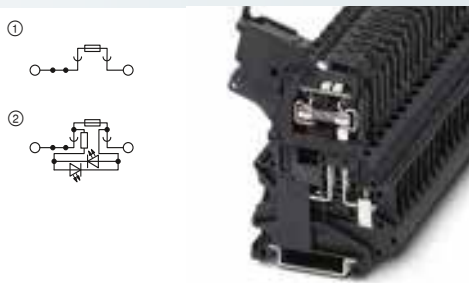

6.3 A, lever-type fuse terminal block for 5 x 20 mm cartridge fuses



Technical data ¹⁾				
Width	Length	Height		
6.2	57.8	73 (NS 35/7,5)		
I _{max.} [A]	U _{max.} [V]	max. Ø [mm ²]	AWG (UL)	
6.3 ³⁾	500 ⁴⁾	0.14 - 6	26-10	
32 (FBS) / 24 (FBSR)				
IEC	UL / CUL	CSA	Ex	
500 ⁴⁾	600	600	-	
Nominal current / cross section [A] / [mm ²]				
6.3 / 1 6.3 / - 6.3 / - - / -				

Ordering data			
Type	Order No.	Pcs./Pkt.	
UT 4-HESI (5X20)	① 3046032	50	
UT 4-HESILED 24 (5X20)	② 3046090	50	
UT 4-HESILED 24 (5X20) 120KOHM	② 3248005	50	
UT 4-HESILED 60 (5X20)	② 3046126	50	
UT 4-HESILA 250 (5X20)	② 3046100	50	

Dimensions	[mm]
Maximum electrical data	
Maximum bridge current	[A]
Rated data	
Rated voltage	[V]
Nominal current / cross section	[A] / [mm ²]
Description	Color
Terminal block	black
with LED display for 12 ... 30 V AC/DC ²⁾	black
for 12 ... 60 V AC/DC ²⁾	black
for 30 ... 60 V AC/DC ²⁾	black
for 110 ... 250 V AC/DC ²⁾	black

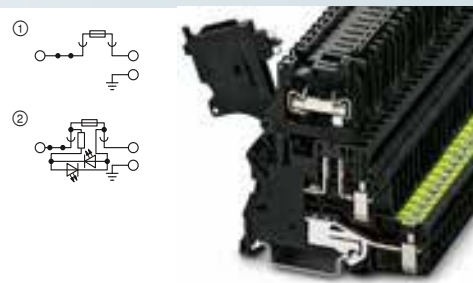

6.3 A, lever-type fuse terminal block for 5 x 20 mm cartridge fuses, with PE foot



Technical data ¹⁾			
Width	Length	Height	
6.2	70.8	73 (NS 35/7,5)	
I _{max.} [A]	U _{max.} [V]	max. Ø [mm ²]	AWG (UL)
6.3 ³⁾	500 ⁴⁾	0.14 - 6	26-10
32 (FBS) / 24 (FBSR)			
IEC	UL / CUL	CSA	Ex
500 ⁴⁾	600	600	-
Nominal current / cross section [A] / [mm ²]			
6.3 / 1 10 / - 10 / - - / -			

Ordering data		
Type	Order No.	Pcs./Pkt.
UT 4-PE/HESI (5X20)	① 3073995	50
UT 4-PE/HESI LED 24 (5X20)	② 3070053	50
UT 4-PE/HESILED 60 (5X20)	② 3070066	50
UT 4-PE/HESI LA 250 (5X20)	② 3070079	50

Fuse terminal blocks and lever-type disconnect terminal blocks of the same shape

– The lever-type disconnect terminal blocks are the same shape as the respective lever-type fuse terminal blocks

Notes:
¹⁾ For additional accessories and technical data, see page 158.
For lever marking, please use marking material with a 5.2 mm pitch.

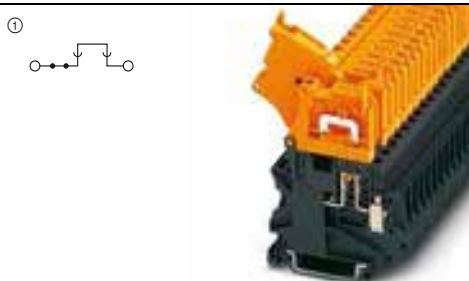

20 A, lever-type disconnect terminal block, same shape



Technical data ¹⁾				
Width	Length	Height		
6.2	57.8	73 (NS 35/7,5)		
I _{max.} [A]	U _{max.} [V]	max. Ø [mm ²]	AWG (UL)	
20	500	0.14 - 6	26-10	
32 (FBS) / 24 (FBSR)				
IEC	UL / CUL	CSA	Ex	
500	600	600	-	
Nominal current / cross section [A] / [mm ²]				
20 / 2.5 16 / - 16 / - - / -				

Ordering data			
Type	Order No.	Pcs./Pkt.	
UT 4-HEDI	① 3046249	50	
UT 4-HEDI-P/P	① 3046252	50	

Dimensions	[mm]
Maximum electrical data	
Maximum bridge current	[A]
Rated data	
Rated voltage	[V]
Nominal current / cross section	[A] / [mm ²]
Description	Color
Terminal block	black/orange
With test socket screws	black/orange

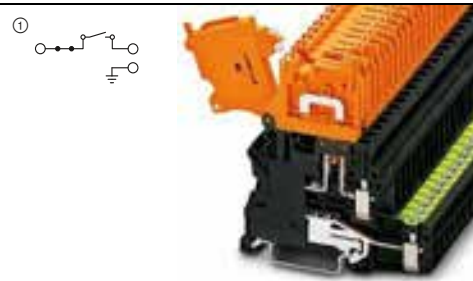

20 A, lever-type disconnect terminal block, same shape, with PE foot



Technical data ¹⁾			
Width	Length	Height	
6.2	70.8	73 (NS 35/7,5)	
I _{max.} [A]	U _{max.} [V]	max. Ø [mm ²]	AWG (UL)
20	500	0.14 - 6	26-10
32 (FBS) / 24 (FBSR)			
IEC	UL / CUL	CSA	Ex
500	600	600	-
Nominal current / cross section [A] / [mm ²]			
20 / 2.5 16 / - 16 / - - / -			

Ordering data		
Type	Order No.	Pcs./Pkt.
UT 4-PE/HEDI	① 3074004	50

Terminal blocks – CLIPLINE complete

4 mm² UT screw connection terminal blocks

Fuse terminal blocks and lever-type disconnect terminal blocks of the same shape

Notes:
1) For additional accessories and technical data, see page 158.
2) If the fuse is faulty, the downstream circuit is not off load.
3) For max. power dissipation, see page 694
4) The current is determined by the fuse used.
For lever marking, please use marking material with a 5.2 mm pitch.
For information on installation and using accessories for Ex applications, see page 678.

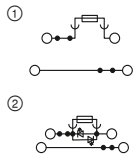

36 A, multi-level terminal block, safety lever



Ex:

KIWA 14ATEX0025U / IECEx KIWA14.0014U

Technical data¹⁾

Width	Length	Height		
6.2	92.7	88.9 (NS 35/7,5)		
I_{max} [A]	U_{max} [V]	max. Ø [mm ²]	AWG (UL)	
36³⁾	500³⁾	0.14 - 6	26-10	
28 (FBS) / 24 (FBSR)				
IEC	UL / CUL	CSA	Ex	
500 ³⁾	300	300	250	
28 / 4	16 / -	16 / -	6.3 / 4	
6.3 ⁴⁾ / 1 (disconnect level)				

Ordering data

Type	Order No.	Pcs./Pkt.
UT 4-L/HESI (5X20) ①	3214325	50
UT 4-L/HESILED 24 (5X20) ②	3214366	50
UT 4-L/HESILED 60 (5X20) ②	3214367	50
UT 4-L/HESILA 250 (5X20) ②	3214368	50

Dimensions	[mm]
Maximum electrical data	
Maximum bridge current	[A]
Rated data	
Rated voltage	[V]
Nominal current / cross section	[A] / [mm ²]
Nominal current / cross section	[A] / [mm ²]

Description	Color
Fuse terminal block	black
with LED display for 12 ... 30 V DC ²⁾	black
	black
for 30 ... 60 V AC/DC ²⁾	black
for 110 ... 250 V AC/DC ²⁾	black

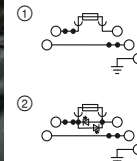

36 A, multi-level terminal block, safety lever with LED display, PE foot



Ex:

KIWA 14ATEX0025U / IECEx KIWA14.0014U

Technical data¹⁾

Width	Length	Height		
6.2	92.7	88.9 (NS 35/7,5)		
I_{max} [A]	U_{max} [V]	max. Ø [mm ²]	AWG (UL)	
36³⁾	500³⁾	0.14 - 6	26-10	
28 (FBS) / 24 (FBSR)				
IEC	UL / CUL	CSA	Ex	
500 ³⁾	300	300	250	
28 / 4	16 / -	16 / -	6.3 / 4	
6.3 ⁴⁾ / 1 (disconnect level)				

Ordering data

Type	Order No.	Pcs./Pkt.
UT 4-PE/L/HESI (5X20) ①	3214320	50
UT 4-PE/L/HESILED 24 (5X20) ②	3214321	50
UT 4-PE/L/HESILED 60 (5X20) ②	3214322	50
UT 4-PE/L/HESILED 250 (5X20) ②	3214323	50

Fuse terminal blocks and lever-type disconnect terminal blocks of the same shape

Notes:
1) For additional accessories and technical data, see page 158.
2) Current and voltage are determined by the plug used.
For lever marking, please use marking material with a 5.2 mm pitch.
For information on installation and using accessories for Ex applications, see page 678.

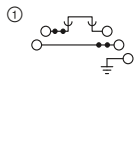

36 A, multi-level lever-type disconnect terminal block, PE foot, same shape



Ex:

KIWA 14ATEX0025U / IECEx KIWA14.0014U

Technical data¹⁾

Width	Length	Height		
6.2	92.7	88.9 (NS 35/7,5)		
I_{max} [A]	U_{max} [V]	max. Ø [mm ²]	AWG (UL)	
36	500	0.14 - 6	26-10	
28 (FBS) / 24 (FBSR)				
IEC	UL / CUL	CSA	Ex	
500	300	300	500	
28 / 4	16 / -	16 / -	16 / 4	
20 / 1 (disconnect level)				

Ordering data

Type	Order No.	Pcs./Pkt.
UT 4-PE/L/HEDI ①	3214324	50

Dimensions	[mm]
Maximum electrical data	
Maximum bridge current	[A]
Rated data	
Rated voltage	[V]
Nominal current / cross section	[A] / [mm ²]
Nominal current / cross section	[A] / [mm ²]

Description	Color
Terminal block	black
	gray
	gray

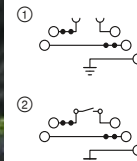

36 A, multi-level terminal block with disconnect zone, PE foot



Ex:

KIWA 14ATEX0025U / IECEx KIWA14.0014U

Technical data¹⁾

Width	Length	Height		
6.2	92.7	61.7 (NS 35/7,5)		
I_{max} [A]	U_{max} [V]	max. Ø [mm ²]	AWG (UL)	
36	500	0.14 - 6	26-10	
28 (FBS) / 24 (FBSR)				
IEC	UL / CUL	CSA	Ex	
500	300	-	250	
28 / 4	16 / -	- / -	6.3 / 4	
20 ²⁾ / 2.5 (disconnect level)				

Ordering data

Type	Order No.	Pcs./Pkt.
UT 4-PE/L/TG ①	3214365	50
UT 4-PE/L/MT ②	3214364	50

Disconnect terminal blocks

Notes:

¹⁾ For additional accessories and technical data, see page 158.

²⁾ If the fuse is faulty, the downstream circuit is not off load.

³⁾ Current and voltage are determined by the plug used.

Detailed information and data sheets regarding modular terminal blocks in the Ex area are available in the product area on our website at www.phoenixcontact.net/products and in IECEx Certificate of Conformity IECEx UL 13.0007U and in UL file E192998.

Only the fuse plugs listed may be used.

For information on installation and using accessories for Ex applications, see page 678.

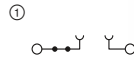

20 A, disconnect terminal block

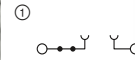
20 A, disconnect terminal block,
for Ex nATechnical data¹⁾

Width	Length	Height		
6.2	57.8	47.5 (NS 35/7,5)		
I_{max} [A]	U_{max} [V]	max. Ø [mm ²]	AWG (UL)	
20 ³⁾	500 ³⁾	0.14 - 6	26-10	
20 (FBS) / 20 (FBSR)				
IEC	UL / CUL	CSA	Ex	
500 ³⁾	600	600	-	
Nominal current / cross section	[A] / [mm ²]			
20 ³⁾ / 2.5	16 / -	16 / -	- / -	

Ordering data

Type	Order No.	Pcs./Pkt.
UT 4-TG	3046142	50
UT 4-TG BU	3073283	50
UT 4-TG-P/P	3046168	50
UT 4-TG-P/P BU	3073296	50

Accessories¹⁾

Type	Order No.	Pcs./Pkt.
P-FU 5X20-EX	3036807	10
P-FU 5X20 LED 24-EX	3036821	10
P-FU 5X20 LED 60-EX	3036823	10
P-FU 5X20 LA 250-EX	3036836	10

ERAC

Ex: IECEx UL 13.0007U

Technical data¹⁾

Width	Length	Height		
6.2	57.8	47.5 (NS 35/7,5)		
I_{max} [A]	U_{max} [V]	max. Ø [mm ²]	AWG (UL)	
20 ³⁾	500 ³⁾	0.14 - 6	-	
20 (FBS) / 20 (FBSR)				
IEC	UL / CUL	CSA	Ex	
500 ³⁾	-	-	250	
20 ³⁾ / 2.5	- / -	- / -	6.3 / 4	

Ordering data

Type	Order No.	Pcs./Pkt.
UT 4-TG-EX	3046143	50
UT 4-TG-P/P-EX	3046169	50

Accessories¹⁾

Type	Order No.	Pcs./Pkt.
P-FU 5X20-EX	3036807	10
P-FU 5X20 LED 24-EX	3036821	10
P-FU 5X20 LED 60-EX	3036823	10
P-FU 5X20 LA 250-EX	3036836	10

Dimensions	[mm]
Maximum electrical data	
Maximum bridge current	[A]
Rated data	
Rated voltage	[V]
Nominal current / cross section	[A] / [mm ²]

Description	Color
Terminal block	gray blue
With test socket screws	gray blue

Fuse connector, width: 6.2 mm ²	Color
with LED display for 12 ... 30 V DC	black
for 30 ... 60 V AC/DC	black
for 110 ... 250 V AC/DC	black

Terminal blocks – CLIPLINE complete

4 mm² UT screw connection terminal blocks

Disconnect terminal blocks

Notes:
1) For additional accessories and technical data, see page 158.
2) Current and voltage are determined by the plug used.

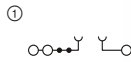

20 A, disconnect terminal block,
3 connections



Technical data ¹⁾				
Width	Length	Height		
6.2	65.4	47.5 (NS 35/7,5)		
I _{max.} [A]	U _{max.} [V]	max. Ø [mm ²]	AWG (UL)	
20	500 ²⁾	0.14 - 6	26-10	
20 (FBS) / 20 (FBSR)				
IEC	UL / CUL	CSA	Ex	
500 ²⁾	300	300	-	
Nominal current / cross section [A] / [mm ²]				
20 ²⁾ / 2.5	20 / -	16 / -	- / -	

Ordering data			
Type	Order No.	Pcs./Pkt.	
UT 4-TWIN-TG	① 3046595	50	
UT 4-TWIN-TG BU	① 3073034	50	
UT 4-TWIN-TG P/P	① 3046605	50	
UT 4-TWIN-TG P/P BU	① 3073047	50	

Accessories ¹⁾		
D-UT 2,5/4-QUATTRO	Order No.	Pcs./Pkt.
	3047170	50

Dimensions	[mm]
Maximum electrical data	
Maximum bridge current	[A]
Rated data	
Rated voltage	[V]
Nominal current / cross section	[A] / [mm ²]
Cover, width: 2.2 mm	gray
Description	Color
Terminal block	gray
	blue
With test socket screws	gray
	blue

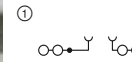

20 A, disconnect terminal block,
4 connections



Technical data ¹⁾				
Width	Length	Height		
6.2	65.4	47.5 (NS 35/7,5)		
I _{max.} [A]	U _{max.} [V]	max. Ø [mm ²]	AWG (UL)	
20	500 ²⁾	0.14 - 6	26-10	
20 (FBS) / 20 (FBSR)				
IEC	UL / CUL	CSA	Ex	
500 ²⁾	300	300	-	
Nominal current / cross section [A] / [mm ²]				
20 ²⁾ / 2.5	20 / -	16 / -	- / -	

Ordering data			
Type	Order No.	Pcs./Pkt.	
UT 4-QUATTRO-TG	① 3064027	50	
UT 4-QUATTRO-TG BU	① 3073076	50	
UT 4-QUATTRO-TG P/P	① 3064030	50	
UT 4-QUATTRO-TG P/P BU	① 3073089	50	

Accessories ¹⁾		
D-UT 2,5/4-QUATTRO	Order No.	Pcs./Pkt.
	3047170	50

Disconnect terminal blocks

Notes:
1) For additional accessories and technical data, see page 158.
2) Current and voltage are determined by the plug used.
3) Lower level

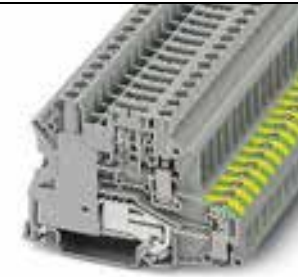
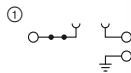

20 A, disconnect terminal block
with PE foot



Technical data ¹⁾				
Width	Length	Height		
6.2	70.8	47.5 (NS 35/7,5)		
I _{max.} [A]	U _{max.} [V]	max. Ø [mm ²]	AWG (UL)	
20	500	0.14 - 6	-	
20 (FBS) / 20 (FBSR)				
IEC	UL / CUL	CSA	Ex	
500	-	600	-	
Nominal current / cross section [A] / [mm ²]				
20 / 2.5	- / -	16 / -	- / -	
Connection capacity		Ferrule		
Rigid	Flexible	without/with plastic sleeve		
-	-	-		

Ordering data			
Type	Order No.	Pcs./Pkt.	
UT 4-PE/TG	① 3070024	50	
UT 4-PE/TG P/P	① 3070037	50	

Accessories ¹⁾		
	Order No.	Pcs./Pkt.

Dimensions	[mm]
Maximum electrical data	
Maximum bridge current	[A]
Rated data	
Rated voltage	[V]
Nominal current / cross section	[A] / [mm ²]
Nominal current / cross section	[A] / [mm ²]
Connection capacity	
2 conductors (of the same type)	[mm ²]
Description	Color
Terminal block	gray
With test socket screws	gray
Disconnect terminal block	gray
Cover, width: 2.2 mm	gray
Spacer plate	gray

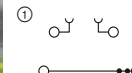

38 A, double-level terminal block
with disconnect zone



Technical data ¹⁾				
Width	Length	Height		
6.2	69.9	65 (NS 35/7,5)		
I _{max.} [A]	U _{max.} [V]	max. Ø [mm ²]	AWG (UL)	
38 ³⁾	500 ²⁾	0.14 - 6	26-10	
30 (FBS) / 24 (FBSR)				
IEC	UL / CUL	CSA	Ex	
500 ²⁾	600	600	-	
Nominal current / cross section [A] / [mm ²]				
30 / 4	16 / -	5 / -	- / -	
20 ²⁾ / 2.5 (disconnect level)				
Connection capacity		Ferrule		
Rigid	Flexible	without/with plastic sleeve		
0.14 - 1.5	0.14 - 1.5	0.14 - 1.5		

Ordering data			
Type	Order No.	Pcs./Pkt.	
UTTB 4-TG	① 3044720	50	

Accessories ¹⁾		
	Order No.	Pcs./Pkt.
D-UTTB 2,5/4	3047293	50
DP-UTTB 2,5/4	3047303	50

Disconnect terminal blocks

Notes:
1) For additional accessories and technical data, see page 158.
2) Current and voltage are determined by the plug used.
For information on installation and using accessories for Ex applications, see page 678.

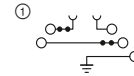

36 A, multi-level terminal block with disconnect zone, PE foot

Ex:

 KIWA 14ATEX0025U / IECEx KIWA14.0014U

Dimensions	[mm]
Maximum electrical data	
Maximum bridge current	[A]
Rated data	
Rated voltage	[V]
Nominal current / cross section	[A] / [mm ²]
Nominal current / cross section	[A] / [mm ²]

Technical data ¹⁾			
Width	Length	Height	
6.2	92.7	61.7 (NS 35/7,5)	
I _{max} [A]	U _{max} [V]	max. Ø [mm ²]	AWG (UL)
36	500	0.14 - 6	26-10
28 (FBS) / 24 (FBSR)			
IEC	UL / CUL	CSA	Ex
500	300	-	250
28 / 4	16 / -	- / -	6.3 / 4
20 ²⁾ / 2.5 (disconnect level)			

Description	Color
Terminal block	gray

Ordering data		
Type	Order No.	Pcs./Pkt.
UT 4-PE/L/TG	3214365	50

Knife disconnect terminal blocks

Notes:
1) For additional accessories and technical data, see page 158.
For additional technical data, drawings, and accessories, please visit phoenixcontact.net/products.
For information on installation and using accessories for Ex applications, see page 678.

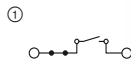

20 A, knife disconnect terminal block

Technical data ¹⁾			
Width	Length	Height	
6.2	57.8	49.1 (NS 35/7,5)	
I _{max} [A]	U _{max} [V]	max. Ø [mm ²]	AWG (UL)
20	500	0.14 - 6	26-10
20 (FBS) / 20 (FBSR)			
IEC	UL / CUL	CSA	Ex
500	600	600	-
20 / 2.5	16 / -	16 / -	- / -

Ordering data		
Type	Order No.	Pcs./Pkt.
UT 4-MT	3046139	50
UT 4-MT BU	3046278	50
UT 4-MT-P/P	3046171	50
UT 4-MT-P/P BU	3046265	50

Description	Color
Terminal block	gray
	blue
With test socket screws	gray
	blue

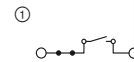

20 A, knife disconnect terminal block for Ex nA

Ex:

 IECEx UL 13.0007U

Technical data ¹⁾			
Width	Length	Height	
6.2	57.8	49.1 (NS 35/7,5)	
I _{max} [A]	U _{max} [V]	max. Ø [mm ²]	AWG (UL)
20	500	0.14 - 6	-
20 (FBS) / 20 (FBSR)			
IEC	UL / CUL	CSA	Ex
500	-	-	500
20 / 2.5	- / -	- / -	16 / 4

Ordering data		
Type	Order No.	Pcs./Pkt.
UT 4-MT-EX	3046141	50
UT 4-MT-P/P-EX	3046173	50

Terminal blocks – CLIPLINE complete

4 mm² UT screw connection terminal blocks

Knife disconnect terminal blocks

Notes:
 1) For additional accessories and technical data, see page 158.

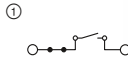

20 A, knife disconnect terminal block, with actuation lever



Technical data ¹⁾				
Width	Length	Height		
6.2	57.8	49.1 (NS 35/7,5)		
I _{max.} [A]	U _{max.} [V]	max. Ø [mm ²]	AWG (UL)	
20	500	0.14 - 6	26-10	
20 (FBS) / 20 (FBSR)				
IEC	UL / CUL	CSA	Ex	
500	600	600	-	
20 / 2.5				
	16 / -	16 / -	- / -	

Ordering data			
Type	Order No.	Pcs./Pkt.	
UT 4-MTL	① 3046144	50	
UT 4-MTL KNIFE-RD	① 3046152	50	
UT 4-MTL KNIFE-WH	① 3046148	50	

Dimensions	[mm]
Maximum electrical data	
Maximum bridge current	[A]
Rated data	
Rated voltage	[V]
Nominal current / cross section	[A] / [mm ²]

Description	Color
Terminal block	gray
red actuation lever	gray
white actuation lever	gray

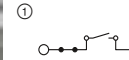

20 A, knife disconnect terminal block, with actuation lever, test socket screws



Technical data ¹⁾				
Width	Length	Height		
6.2	57.8	49.1 (NS 35/7,5)		
I _{max.} [A]	U _{max.} [V]	max. Ø [mm ²]	AWG (UL)	
20	500	0.14 - 6	26-10	
20 (FBS) / 20 (FBSR)				
IEC	UL / CUL	CSA	Ex	
500	300	600	-	
20 / 2.5				
	16 / -	16 / -	- / -	

Ordering data			
Type	Order No.	Pcs./Pkt.	
UT 4-MTL-P/P	① 3046146	50	
UT 4-MTL-P/P KNIFE-RD	① 3046154	50	
UT 4-MTL-P/P KNIFE-WH	① 3046150	50	

Knife disconnect terminal blocks

Notes:
 1) For additional accessories and technical data, see page 158.

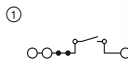

20 A, knife disconnect terminal block, 3 connections



Technical data ¹⁾				
Width	Length	Height		
6.2	65.4	49.1 (NS 35/7,5)		
I _{max.} [A]	U _{max.} [V]	max. Ø [mm ²]	AWG (UL)	
20	500	0.14 - 6	26-10	
20 (FBS) / 20 (FBSR)				
IEC	UL / CUL	CSA	Ex	
500	300	300	-	
20 / 2.5				
	20 / -	16 / -	- / -	

Ordering data			
Type	Order No.	Pcs./Pkt.	
UT 4-TWIN-MT	① 3046003	50	
UT 4-TWIN-MT BU	① 3073018	50	
UT 4-TWIN-MT P/P	① 3064014	50	
UT 4-TWIN-MT P/P BU	① 3073021	50	

Accessories ¹⁾		
D-UT 2,5/4-QUATTRO	3047170	50

Dimensions	[mm]
Maximum electrical data	
Maximum bridge current	[A]
Rated data	
Rated voltage	[V]
Nominal current / cross section	[A] / [mm ²]

Description	Color
Terminal block	gray
	blue
With test socket screws	gray
	blue

Cover, width: 2.2 mm	gray
-----------------------------	------

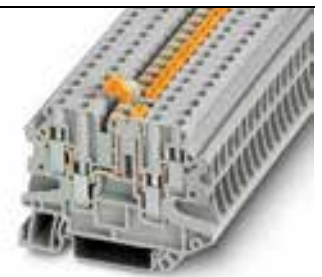
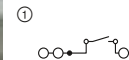

20 A, knife disconnect terminal block, 4 connections



Technical data ¹⁾				
Width	Length	Height		
6.2	65.4	49.1 (NS 35/7,5)		
I _{max.} [A]	U _{max.} [V]	max. Ø [mm ²]	AWG (UL)	
20	500	0.14 - 6	26-10	
20 (FBS) / 20 (FBSR)				
IEC	UL / CUL	CSA	Ex	
500	300	300	-	
20 / 2.5				
	16 / -	16 / -	- / -	

Ordering data			
Type	Order No.	Pcs./Pkt.	
UT 4-QUATTRO-MT	① 3064043	50	
UT 4-QUATTRO-MT BU	① 3073050	50	
UT 4-QUATTRO-MT P/P	① 3064056	50	
UT 4-QUATTRO-MT P/P BU	① 3073063	50	

Accessories ¹⁾		
D-UT 2,5/4-QUATTRO	3047170	50

Knife disconnect terminal blocks

Notes:
1) For additional accessories and technical data, see page 158.
2) Lower level

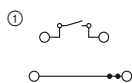

38 A, double-level terminal block with knife disconnect zone



Technical data ¹⁾				
Dimensions	Width	Length	Height	
	6.2	69.9	65 (NS 35/7,5)	
Maximum electrical data	I_{max} [A]	U_{max} [V]	max. Ø [mm ²]	AWG (UL)
	38 ²⁾	500	0.14 - 6	26-10
Maximum bridge current	36 (FBS) / 24 (FBSR)			
Rated data	IEC	UL / CUL	CSA	Ex
Rated voltage	500	600	600	-
Nominal current / cross section	30 / 4	16 / -	5 / -	- / -
Nominal current / cross section	20 / 2.5 (disconnect level)			

Ordering data			
Type	Order No.	Pcs./Pkt.	
UTT _B 4-MT	3044775	50	
UTT _B 4-MT P/P	3044762	50	

Accessories ¹⁾			
Type	Order No.	Pcs./Pkt.	
D-UTT _B 2,5/4	3047293	50	

Description	Color
Knife disconnect terminal block	gray
With test socket screws	gray
For 12 - 30 V DC, 0.7 - 2.4 mA	gray

Cover, width: 2.2 mm	gray
----------------------	------

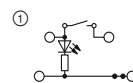

38 A, double-level terminal block with knife disconnect zone, with LED display



Technical data ¹⁾				
Dimensions	Width	Length	Height	
	6.2	69.9	65 (NS 35/7,5)	
Maximum electrical data	I_{max} [A]	U_{max} [V]	max. Ø [mm ²]	AWG (UL)
	38 ²⁾	24	0.14 - 6	26-10
Maximum bridge current	30 (FBS) / 24 (FBSR)			
Rated data	IEC	UL / CUL	CSA	Ex
Rated voltage	24	600	24	-
Nominal current / cross section	30 / 4	16 / -	30 / -	- / -
Nominal current / cross section	20 / 2.5 (disconnect level)			

Ordering data			
Type	Order No.	Pcs./Pkt.	
UTT _B 4-MT P/P LA 24 RD/O-U	3046773	50	

Accessories ¹⁾			
Type	Order No.	Pcs./Pkt.	
D-UTT _B 2,5/4	3047293	50	

Knife disconnect terminal blocks

Notes:
1) For additional accessories and technical data, see page 158.
2) Lower level
For additional technical data, drawings, and accessories, please visit phoenixcontact.net/products.
For information on installation and using accessories for Ex applications, see page 678.

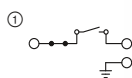

20 A, knife disconnect terminal block with PE foot



Technical data ¹⁾				
Dimensions	Width	Length	Height	
	6.2	70.8	49.1 (NS 35/7,5)	
Maximum electrical data	I_{max} [A]	U_{max} [V]	max. Ø [mm ²]	AWG (UL)
	20	500	0.14 - 6	26-10
Maximum bridge current	20 (FBS) / 20 (FBSR)			
Rated data	IEC	UL / CUL	CSA	Ex
Rated voltage	500	-	600	-
Nominal current / cross section	20 / 2.5	- / -	16 / -	- / -
Nominal current / cross section	-			

Ordering data			
Type	Order No.	Pcs./Pkt.	
UT 4-PE/MT	3070011	50	
UT 4-PE/MT P/P	3046140	50	

Description	Color
Knife disconnect terminal block	gray
With test socket screws	gray

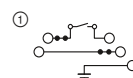

36 A, multi-level terminal block with knife disconnect zone, PE foot



Ex: KIWA 14ATEX0025U / IECEx KIWA14.0014U

Technical data ¹⁾				
Dimensions	Width	Length	Height	
	6.2	92.7	61.7 (NS 35/7,5)	
Maximum electrical data	I_{max} [A]	U_{max} [V]	max. Ø [mm ²]	AWG (UL)
	36 ²⁾	500	0.14 - 6	26-10
Maximum bridge current	28 (FBS) / 24 (FBSR)			
Rated data	IEC	UL / CUL	CSA	Ex
Rated voltage	500	300	-	500
Nominal current / cross section	28 / 4	16 / -	- / -	16 / 4
Nominal current / cross section	20 / 2.5 (disconnect level)			

Ordering data			
Type	Order No.	Pcs./Pkt.	
UT 4-PE/L/MT	3214364	50	

Terminal blocks – CLIPLINE complete

4 mm² UT screw connection terminal blocks

Diode terminal blocks

Notes:
 1) For additional accessories and technical data, see page 158.
 For information on installation and using accessories for Ex applications, see page 678.

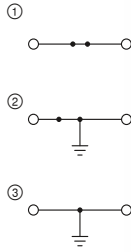

41 A, feed-through and ground terminal block, same shape

Ex: ENEC EAC Ex IEC CB
 KEMA 04ATEX2048 U / IECEx KEM 06.0027U

Technical data ¹⁾				
Width	Length	Height		
6.2	57.8	47.5 (NS 35/7,5)		
I _{max.} [A]	U _{max.} [V]	max. Ø [mm ²]	AWG (UL)	
41	800	0.14 - 6	26-10	
32 (FBS) / 24 (FBSR)				
IEC	UL / CUL	CSA	Ex	
800	600	600	690	
32 / 4	30 / -	30 / -	29 / 4	

Dimensions	
	[mm]
Maximum electrical data	
Maximum bridge current	[A]
Rated voltage	[V]
Nominal current / cross section	[A] / [mm ²]

Description	Color
Terminal block	gray
	blue
Ground terminal, with snap-on foot	green-yellow
With screw foot	green-yellow
Terminal block, for conducting direction see circuit diagram	gray
	gray

Cover, width: 2.2 mm gray

Ordering data			
Type	Order No.	Pcs./Pkt.	
UT 4-MTD	① 3046184	50	
UT 4-MTD BU	① 3046197	50	
UT 4-MTD-PE	② 3046223	50	
UT 4-MTD-PE/S	③ 3046207	50	

Accessories ¹⁾			
D-UT 2,5/4-TWIN	Order No.	Pcs./Pkt.	
	3047141	50	

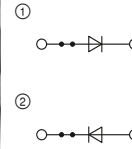

0.5 A, diode terminal block, 1N 4007 (1300 V/0.5 A)

Technical data ¹⁾				
Width	Length	Height		
6.2	57.8	47.5 (NS 35/7,5)		
I _{max.} [A]	U _{max.} [V]	max. Ø [mm ²]	AWG (UL)	
0.5	800	0.14 - 6	26-10	
32 (FBS) / 24 (FBSR)				
IEC	UL / CUL	CSA	Ex	
800	600	600	-	
0.5 / 1	0.5 / -	1 / -	- / -	

Ordering data			
Type	Order No.	Pcs./Pkt.	
UT 4-MTD-DIO/L-R	① 3046210	50	
UT 4-MTD-DIO/R-L	② 3046236	50	

Accessories ¹⁾			
D-UT 2,5/4-TWIN	Order No.	Pcs./Pkt.	
	3047141	50	

Diode terminal blocks

Notes:
 1) For additional accessories and technical data, see page 158.

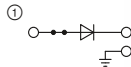

0.5 A, diode terminal block, 1N 4007 (1300 V/0.5 A), conducting direction: from left to right

Technical data ¹⁾				
Width	Length	Height		
6.2	70.8	47.5 (NS 35/7,5)		
I _{max.} [A]	U _{max.} [V]	max. Ø [mm ²]	AWG (UL)	
0.5	500	0.14 - 6	26-10	
32 (FBS) / 24 (FBSR)				
IEC	UL / CUL	CSA	Ex	
500	600	600	-	
0.5 / 1	0.5 / -	0.5 / -	- / -	

Dimensions	
	[mm]
Maximum electrical data	
Maximum bridge current	[A]
Rated voltage	[V]
Nominal current / cross section	[A] / [mm ²]

Description	Color
Terminal block, for conducting direction see circuit diagram	gray

Ordering data			
Type	Order No.	Pcs./Pkt.	
UT 4-PE/L-DIO/L-R P/P	① 3046834	50	

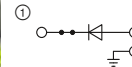

0.5 A, diode terminal block, 1N 4007 (1300 V/0.5 A), conducting direction: from right to left

Technical data ¹⁾				
Width	Length	Height		
6.2	70.8	47.5 (NS 35/7,5)		
I _{max.} [A]	U _{max.} [V]	max. Ø [mm ²]	AWG (UL)	
0.5	500	0.14 - 6	26-10	
32 (FBS) / 24 (FBSR)				
IEC	UL / CUL	CSA	Ex	
500	600	600	-	
0.5 / 1	0.5 / -	0.5 / -	- / -	

Ordering data			
Type	Order No.	Pcs./Pkt.	
UT 4-PE/L-DIO/R-L P/P	① 3046235	50	

Test disconnect terminal blocks

Notes:

¹⁾ For additional accessories and technical data, see page 158.

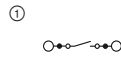

28 A, test disconnect terminal block

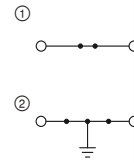

32 A, feed-through and ground terminal block, same shape



Technical data¹⁾

Width	Length	Height		
6.2	66	49.5 (NS 35/7,5)		
I_{max} [A]	U_{max} [V]	max. Ø [mm ²]	AWG (UL)	
28	500	0.14 - 6	26-10	
28 (FBS) / 28 (FBSR)				
IEC	UL / CUL	CSA	Ex	
500	600	600	-	
Nominal current / cross section [A] / [mm ²]				
28 / 4	25 / -	25 / -	- / -	

Technical data¹⁾

Width	Length	Height		
6.2	66	49.5 (NS 35/7,5)		
I_{max} [A]	U_{max} [V]	max. Ø [mm ²]	AWG (UL)	
32	500	0.14 - 6	26-10	
32 (FBS) / 24 (FBSR)				
IEC	UL / CUL	CSA	Ex	
500	600	600	-	
Nominal current / cross section [A] / [mm ²]				
32 / 4	25 / -	25 / -	- / -	

Ordering data

Type	Order No.	Pcs./Pkt.
UTME 4	3047452	50
UTME 4-P/P	3047453	50
UTME 4-P/P BU	3047454	50

Ordering data

Type	Order No.	Pcs./Pkt.
UTMED 4	3047465	50
UTMED 4-PE	3047478	50

Accessories¹⁾

Type	Order No.	Pcs./Pkt.
D-UTME 4	3047491	10

Accessories¹⁾

Type	Order No.	Pcs./Pkt.
D-UTME 4	3047491	10

Dimensions	[mm]
Maximum electrical data	
Maximum bridge current	[A]
Rated data	
Rated voltage	[V]
Nominal current / cross section	[A] / [mm ²]
Description	
Color	
Test disconnect terminal block	gray
With test socket screws	gray
	blue
Ground terminal	green-yellow
Cover, width: 2.2 mm	gray

Supplementary accessories for UTME 4 test disconnect terminal blocks



- Only two UTME 4 test disconnect terminal blocks are required for a current transformer measuring circuit
- Less space required compared to creating circuits with slide-type terminal blocks

- ① FBS... plug-in bridge for cross connection
- ② 4 mm Ø PAI-4-FIX... test plug adapter
- ③ S-ME 4 switching lock
- ④ SB-ME... bridge bar
- ⑤ C-ME 4/2 operating lever

Ordering data

Description	No. of pos.	Color	Type	Order No.	Pcs./Pkt.
Test adapter, for 4 mm Ø safety test plugs, latches into the bridge shaft	1	orange	PAI-4-FIX-5/6 OG	3035974	10
	1	yellow	PAI-4-FIX-5/6 YE	3035977	10
	1	green	PAI-4-FIX-5/6 GN	3035978	10
	1	violet	PAI-4-FIX-5/6 VT	3035979	10
	1	black	PAI-4-FIX-5/6 BK	3035980	10
	1	blue	PAI-4-FIX-5/6 BU	3035975	10
	1	red	PAI-4-FIX-5/6 RD	3035976	10
	1	gray	PAI-4-FIX-5/6 GY	3035982	10
	1	brown	PAI-4-FIX-5/6 BN	3035981	10
Switching lock, plug-in		white	S-ME 4	3035758	10
Switching bridge, plug-in	2	gray/orange	SB-ME 2-6	3035755	10
	3	gray/orange	SB-ME 3-6	3035756	10
	4	gray/orange	SB-ME 4-6	3035757	10
			C-ME 4/1	1062645	10
	2	orange	C-ME 4/2	3035759	10
	3	orange	C-ME 4/3	3035760	10

Installation terminal blocks

Notes:

¹⁾ For additional accessories and technical data, see page 158.

Assembly instruction:

In order to securely fix the neutral busbar in place, support brackets must be placed at the beginning and end of each terminal strip as well as every 20 cm on longer terminal strips. The corresponding support brackets can be found at phoenixcontact.net/products

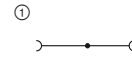

32 A, neutral disconnect terminal block

ERC

Dimensions	
	[mm]
Maximum electrical data	
Maximum bridge current	[A]
Rated data	
Rated voltage	[V]
Nominal current / cross section	[A] / [mm ²]
Connection capacity	
1 conductor	[mm ²]

Technical data ¹⁾				
Width	Length	Height		
6.2	55	47.5 (NS 35/7,5)		
I_{max} [A]	U_{max} [V]	max. \varnothing [mm ²]	AWG (UL)	
32	250	0.14 - 6	-	
32 (FBS) / 24 (FBSR)				
IEC	UL / CUL	CSA	Ex	
250	-	-	-	
Nominal current / cross section				
32 / 4	- / -	- / -	- / -	
Connection capacity		Rigid	Flexible	Ferrule
		without/with plastic sleeve		
0.14 - 6	0.14 - 6	0.25 - 4	0.25 - 4	

Description	Color
Neutral disconnect terminal block	blue

Ordering data		
Type	Order No.	Pcs./Pkt.
UTN 4 ^①	3245024	50

Cover, width: 2.2 mm	blue
Support bracket	blue

Accessories ¹⁾		
Type	Order No.	Pcs./Pkt.
D-UTN 2,5/10	3245079	50
AB-UTN 2,5/10	3245082	50

Mini feed-through and ground terminal blocks

Notes:

¹⁾ For additional accessories and technical data, see page 158.

For information on installation and using accessories for Ex applications, see page 678.

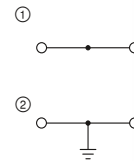

41 A, feed-through and ground terminal block



Ex: EAC Ex IEC Ex UL Ex
SEV13ATEX0178U / IECEx SEV13.0012U

Technical data¹⁾

Dimensions	Width	Length	Height	
	6.2	29.9	34 (NS 15)	
Maximum electrical data	I_{max} [A]	U_{max} [V]	max. \varnothing [mm ²]	AWG (UL)
	41	500	0.2 - 6	24-10
Maximum bridge current	28 (FBS) / 24 (FBSR) [A]			
Rated data	IEC	UL / CUL	CSA	Ex
Rated voltage	500	300	600	352
Nominal current / cross section	32 / 4	30 / -	30 / -	27.5 / 6
Cross section range	24 - 10	-	-	-
Connection capacity	Rigid	Flexible	Ferrule without/with plastic sleeve	
1 conductor	0.2 - 6	0.2 - 6	0.25 - 4	0.25 - 4
2 conductors (of the same type)	0.2 - 1.5	0.2 - 1.5	0.25 - 1.5	-

Ordering data

Description	Color	Type	Order No.	Pcs./Pkt.
Terminal block	gray	MUT 4	① 3248035	50
	blue	MUT 4 BU	① 3248036	50
Ground terminal	green-yellow	MUT 4-PE	② 3248037	50

Accessories¹⁾

Description	Order No.	Pcs./Pkt.
Cover, width: 2.2 mm	D-MUT 2,5/4 3248033	50

Terminal blocks – CLIPLINE complete

6 mm² UT screw connection terminal blocks

General technical data

Rated data		IEC 60947-7-1 / IEC 60947-7-2 / IEC 60947-7-3			
Rated cross section	[mm ²]	6			
Cross section range	AWG	24 - 8			
Connection capacity		Rigid	Flexible	Ferrule without/with plastic sleeve	
1 conductor	[mm ²]	0.2 - 10	0.2 - 10	0.25 - 6	0.25 - 6
2 conductors (of the same type)	[mm ²]	0.2 - 2.5	0.2 - 2.5	0.25 - 1.5	-
2 flexible conductors with a TWIN ferrule	[mm ²]	-	-	-	0.5 - 4
General data					
Stripping length	[mm]	10			
Screw thread		M4			
Tightening torque	[Nm]	1.5 - 1.8			
Insulating material		PA			
Flammability rating in accordance with UL 94		VO			

Note: Additional or deviating data is listed alongside the respective product.

Notes:



In addition to the product, the internal electrical wiring is provided as a circuit diagram. Free connection points for bridging are indicated by a black dot.

The specified technical data and approvals refer to the first product in each column. For information on the products below, please refer to phoenixcontact.net/products

For full details of UL and CSA use groups, file nos., and Internet links, please visit phoenixcontact.net/products

¹⁾ The bridge current is listed alongside the respective product. For additional colors, see page 402.

System accessories

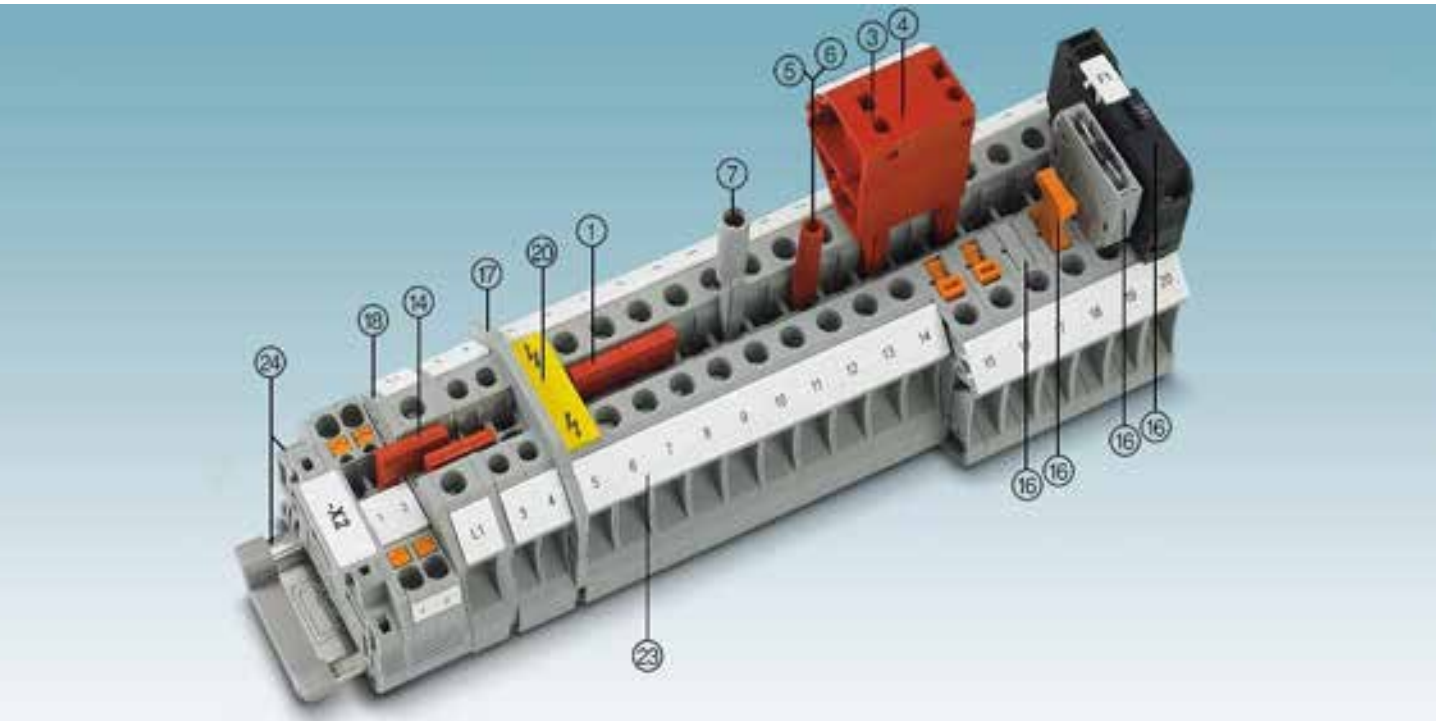

Description	No. of pos.	Color	Type	Order No.	Pcs./Pkt.	Type	Order No.	Pcs./Pkt.
① Bridge ¹⁾	2	red	FBS 2-8	3030284	10	FBSR 2-8	3033808	10
	3	red	FBS 3-8	3030297	10	FBSR 3-8	3001597	10
	4	red	FBS 4-8	3030307	10	FBSR 4-8	3000585	10
	5	red	FBS 5-8	3030310	10	FBSR 5-8	3033809	10
	10	red	FBS 10-8	3030323	10	FBSR 10-8	3001599	10
③ Modular test plug	16	red	PS-8	3031005	10	FBSR 16-8	3033816	10
④ Spacer plate		red	DP PS-8	3036741	10			
⑤ Test plug metal part		gray	MPS-MT	0201744	10			
⑥ Insulating sleeve, for MPS metal part		red	MPS-IH RD	0201676	10			
⑦ Test adapter, 4 mm socket hole		gray	PAI-4-N GY	3032871	10			
Screwdriver			SZS 1,0X4,0 VDE	1205066	10			

⑭ Reducing bridge	For RB ..., see page 408.
⑮ Fuse and function plugs for disconnect terminal blocks	For P-FU ... / P-DI / P-FIX / P-CO ..., see from page 414.
⑰ Partition plates/end cover segments	For ATP-... / DS-..., visit phoenixcontact.net/products
⑱ Cover	Listed alongside the respective product.
⑳ Warning labels	For WS ..., see page 420.
㉑ Lateral groove labeling	UC-TM 8, UCT-TM 8 or ZB 8. See also Catalog 3, selection tables, from page 60.
㉒ DIN rail and end bracket	See Catalog 3
For full accessories, visit phoenixcontact.net/products	Note: Additional or deviating accessories are listed alongside the respective product.

Feed-through and multi-level terminal blocks

Notes:

1) For additional accessories and technical data, see page 172.

For information on installation and using accessories for Ex applications, see page 678.

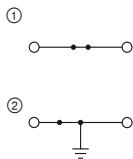

57 A, feed-through and ground terminal block

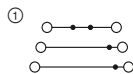

50 A, multi-level terminal block



Ex: ENEC, UL, EAC Ex, IEC, CB
KEMA 04ATEX2048 U / IECEx KEM 06.0027U

Technical data¹⁾

Width	Length	Height		
8.2	47.7	47.5 (NS 35/7,5)		
I_{max} [A]	U_{max} [V]	max. Ø [mm ²]	AWG (UL)	
57	1000	0.2 - 10	24-8	
41 (FBS) / 32 (FBSR)				
IEC	UL / CUL	CSA	Ex	
1000	600	600	690	
Nominal current / cross section	[A] / [mm ²]			
41 / 6	50 / -			

Ordering data

Type	Order No.	Pcs./Pkt.
UT 6	3044131	50
UT 6 BU	3044144	50
UT 6-PE	3044157	50

Accessories¹⁾

D-UT 2,5/10	Order No.	Pcs./Pkt.
	3047028	50



Technical data¹⁾

Width	Length	Height		
8.2	110	98.8 (NS 35/7,5)		
I_{max} [A]	U_{max} [V]	max. Ø [mm ²]	AWG (UL)	
50	1000	0.2 - 10	24-8	
36 (FBS)				
IEC	UL / CUL	CSA	Ex	
1000	600	600	-	
Nominal current / cross section	[A] / [mm ²]			
36 / 6	40 / -			

Ordering data

Type	Order No.	Pcs./Pkt.
UT 6-3L	3046703	50

Accessories¹⁾

D-UT 6-3L	Order No.	Pcs./Pkt.
	3046707	50

Dimensions	[mm]
Maximum electrical data	
Maximum bridge current	[A]
Rated data	
Rated voltage	[V]
Nominal current / cross section	[A] / [mm ²]
Cover, width: 2.2 mm	gray

Description	Color
Terminal block	gray
	blue
Ground terminal	green-yellow

Fuse terminal blocks

Notes:

1) For additional accessories and technical data, see page 172.

2) If the fuse is faulty, the downstream circuit is not off load.

3) For max. power dissipation, see page 694.

4) The current is determined by the fuse used, the voltage by the LED display. Observe max. power dissipation.

5) The current is determined by the fuse used, the voltage by the LED display.

As disconnect terminal block 500 V.

For lever marking, please use marking material with 6.2 mm pitch.

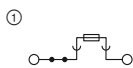

10 A, lever-type fuse terminal block for 6.3 x 32 mm cartridge fuses

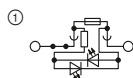

10 A, lever-type fuse terminal block for 6.3 x 32 mm cartridge fuses, with LED display



Technical data¹⁾

Width	Length	Height		
8.2	57.8	73 (NS 35/7,5)		
I_{max} [A]	U_{max} [V]	max. Ø [mm ²]	AWG (UL)	
10 ³⁾	630 ⁵⁾	0.2 - 10	24-8	
41 (FBS) / 32 (FBSR)				
IEC	UL / CUL	CSA	Ex	
630 ⁵⁾	600	600	-	
Nominal current / cross section	[A] / [mm ²]			
10 ⁵⁾ / 1.5	10 / -			

Ordering data

Type	Order No.	Pcs./Pkt.
UT 6-HESI (6,3X32)	3046401	50



Technical data¹⁾

Width	Length	Height		
8.2	57.8	73 (NS 35/7,5)		
I_{max} [A]	U_{max} [V]	max. Ø [mm ²]	AWG (UL)	
10 ³⁾	24 ⁴⁾	0.2 - 10	24-8	
41 (FBS) / 32 (FBSR)				
IEC	UL / CUL	CSA	Ex	
24 ⁴⁾	600	600	-	
Nominal current / cross section	[A] / [mm ²]			
10 ⁵⁾ / 1.5	10 / -			

Ordering data

Type	Order No.	Pcs./Pkt.
UT 6-HESILED 24 (6,3X32)	3046414	50
UT 6-HESILED 60 (6,3X32)	3046427	50
UT 6-HESILA 250 (6,3X32)	3046430	50

Dimensions	[mm]
Maximum electrical data	
Maximum bridge current	[A]
Rated data	
Rated voltage	[V]
Nominal current / cross section	[A] / [mm ²]

Description	Color
Terminal block	black
With LED display 12 ... 30 V AC/DC, 0.31 ... 0.95 mA ²⁾	black
30 ... 60 V AC/DC, 0.40 ... 0.86 mA ²⁾	black
110 ... 250 V AC/DC, 0.41 ... 0.96 mA ²⁾	black

Terminal blocks – CLIPLINE complete

6 mm² UT screw connection terminal blocks

Disconnect terminal blocks

Notes:
1) For additional accessories and technical data, see page 172.
2) If the fuse is faulty, the downstream circuit is not off load.
3) Current and voltage are determined by the plug used.
Detailed information and data sheets regarding modular terminal blocks in the Ex area are available in the product area on our website at www.phoenixcontact.net/products and in IECEx Certificate of Conformity IECEx UL 13.0007U and in UL file E192998.
Only the fuse plugs listed may be used.
For information on installation and using accessories for Ex applications, see page 678.

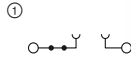

20 A, disconnect terminal block

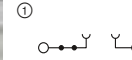

20 A, disconnect terminal block for Ex nA



Technical data ¹⁾			
Width	Length	Height	
8.2	57.8	47.5 (NS 35/7,5)	
I_{max} [A]	U_{max} [V]	max. Ø [mm ²]	AWG (UL)
20 ³⁾	500 ³⁾	0.2 - 10	24-8
20 (FBS) / 20 (FBSR)			
IEC	UL / CUL	CSA	Ex
500 ³⁾	600	600	-
Nominal current / cross section	[A] / [mm ²]		
20 ³⁾ / 2.5	16 / -	16 / -	- / -

Ordering data			
Type	Order No.	Pcs./Pkt.	
UT 6-TG	3046485	50	①
UT 6-TG BU	3073856	50	①
UT 6-TG P/P	3073869	50	①
UT 6-TG P/P BU	3073872	50	①

Accessories ¹⁾		



Technical data ¹⁾			
Width	Length	Height	
8.2	57.8	47.5 (NS 35/7,5)	
I_{max} [A]	U_{max} [V]	max. Ø [mm ²]	AWG (UL)
20 ³⁾	500 ³⁾	0.2 - 10	-
20 (FBS) / 20 (FBSR)			
IEC	UL / CUL	CSA	Ex
500 ³⁾	-	-	250
Nominal current / cross section	[A] / [mm ²]		
20 ³⁾ / 2.5	- / -	- / -	6.3 / 6

Ordering data			
Type	Order No.	Pcs./Pkt.	
UT 6-TG-EX	3046486	50	①
UT 6-TG P/P-EX	3073870	50	①

Accessories ¹⁾		
P-FU 6,3X32-EX	3046499	10
P-FU 6,3X32 LED 24-EX	3046509	10
P-FU 6,3X32 LED 60-EX	3046512	10
P-FU 6,3X32 LA 250-EX	3046525	10

Fuse connector, width: 8.2 mm ²⁾	black
with LED for 12 - 30 V DC, 0.35 - 0.95 mA	black
for 30 - 60 V AC/DC, 0.36 - 0.95 mA	black
for 110 - 250 V AC/DC, 0.4 - 0.95 mA	black

Knife disconnect terminal blocks

Notes:

¹⁾ For additional accessories and technical data, see page 172.

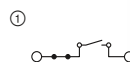

20 A, knife disconnect terminal block

Technical data¹⁾

Dimensions		Width	Length	Height		
	[mm]	8.2	57.8	49.1 (NS 35/7,5)		
Maximum electrical data		I_{max} [A]	U_{max} [V]	max. Ø [mm ²]	AWG (UL)	
Maximum bridge current		20	500	0.2 - 10	24-8	
		20 (FBS) / 20 (FBSR)				
Rated data		IEC	UL / CUL	CSA	Ex	
Rated voltage		500	600	600	-	
Nominal current / cross section		20 / 2.5	16 / -	16 / -	- / -	

Ordering data

Description	Color	Type	Order No.	Pcs./Pkt.
Terminal block	gray	UT 6-MT	① 3064069	50
	blue	UT 6-MT BU	① 3073267	50
With test socket screws	gray	UT 6-MT P/P	① 3064072	50
	blue	UT 6-MT P/P BU	① 3073270	50

Knife disconnect terminal blocks

Notes:

¹⁾ For additional accessories and technical data, see page 172.

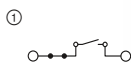

20 A, knife disconnect terminal block, with actuation lever

Technical data¹⁾

Dimensions		Width	Length	Height		
	[mm]	8.2	57.8	49.1 (NS 35/7,5)		
Maximum electrical data		I_{max} [A]	U_{max} [V]	max. Ø [mm ²]	AWG (UL)	
Maximum bridge current		20	500	0.2 - 10	24-8	
		20 (FBS) / 20 (FBSR)				
Rated data		IEC	UL / CUL	CSA	Ex	
Rated voltage		500	600	600	-	
Nominal current / cross section		20 / 2.5	16 / -	16 / -	- / -	

Ordering data

Description	Color	Type	Order No.	Pcs./Pkt.
Terminal block	gray	UT 6-MTL	① 3046145	50
Red actuation lever	gray	UT 6-MTL KNIFE-RD	① 3046153	50
White actuation lever	gray	UT 6-MTL KNIFE-WH	① 3046149	50

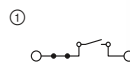

20 A, knife disconnect terminal block, with actuation lever, test socket screws

Technical data¹⁾

Dimensions		Width	Length	Height		
	[mm]	8.2	57.8	49.1 (NS 35/7,5)		
Maximum electrical data		I_{max} [A]	U_{max} [V]	max. Ø [mm ²]	AWG (UL)	
Maximum bridge current		20	500	0.2 - 10	-	
		20 (FBS) / 20 (FBSR)				
Rated data		IEC	UL / CUL	CSA	Ex	
Rated voltage		500	-	600	-	
Nominal current / cross section		20 / 2.5	- / -	16 / -	- / -	

Ordering data

Description	Color	Type	Order No.	Pcs./Pkt.
Terminal block	gray	UT 6-MTL P/P	① 3046147	50
Red actuation lever	gray	UT 6-MTL-P/P KNIFE-RD	① 3046155	50
White actuation lever	gray	UT 6-MTL P/P KNIFE-WH	① 3046151	50

Terminal blocks – CLIPLINE complete

6 mm² UT screw connection terminal blocks

Test disconnect terminal blocks

Notes:
For further plug-in bridges, see page 402.
For further test sockets, see page 587.
For corresponding AP-ME and AH-ME terminal strip covers, see Catalog 3.



57 A, 1000 V, test disconnect terminal block, 2 plug-in bridge shafts

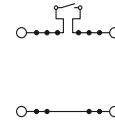

50 A, test disconnect terminal block, 4 plug-in bridge shafts, 2 screw bridge shafts



		Technical data			
Dimensions		Width	Length	Height NS 35/7,5	
	[mm]	8.2	72.6	54.3	
Dimensions		Width	Length	Height NS 32	
	[mm]	8.2	72.6	59.3	
Maximum electrical data		I_{max} [A]	U_{max} [V]	max. Ø [mm ²]	AWG (UL)
		57	1000	0.2 - 10	-
Rated data		IEC 60947-7-1			
		IEC	UL / CUL	CSA	IEC/ EN 60079-7
Rated voltage	[V]	1000	-	-	-
Nominal current / cross section	[A] / [mm ²]	41 / 6	-	-	-
General data					
Stripping length	[mm]	12			
Tightening torque	[Nm]	1.2 - 1.4			

		Technical data			
Dimensions		Width	Length	Height NS 35/7,5	
	[mm]	8.2	105.2	53	
Dimensions		Width	Length	Height NS 32	
	[mm]	8.2	105.2	58	
Maximum electrical data		I_{max} [A]	U_{max} [V]	max. Ø [mm ²]	AWG (UL)
		50	1000	0.2 - 10	20-8
Rated data		IEC 60947-7-1			
		IEC	UL / CUL	CSA	IEC/ EN 60079-7
Rated voltage	[V]	1000	600	-	-
Nominal current / cross section	[A] / [mm ²]	41 / 6	50	-	-
General data					
Stripping length	[mm]	12			
Tightening torque	[Nm]	1.5 - 1.8			

			Ordering data			
Description	No. of pos.	Color	Type	I_{max}	Order No.	Pcs./Pkt.
Terminal block		gray	UT 6-T-HV		3070134	50
With test socket screws		gray	UT 6-T-HV P/P		3070121	50
Feed-through terminal block		gray				

			Ordering data			
Description	No. of pos.	Color	Type	I_{max}	Order No.	Pcs./Pkt.
Terminal block		gray	UT 6-T/SP		3072815	50
Feed-through terminal block		gray	UTD 6/SP		3072817	50

			Accessories			
Description	No. of pos.	Color	Type	I_{max}	Order No.	Pcs./Pkt.
Cover, width: 2.2 mm		gray	D-UT 6-T-HV		3070147	50
Plug-in bridge						
	2	red	FBS 2-8	41 A	3030284	10
	3	red	FBS 3-8	41 A	3030297	10
	4	red	FBS 4-8	41 A	3030307	10
	5	red	FBS 5-8	41 A	3030310	10
	10	red	FBS 10-8	41 A	3030323	10
Pre-assembled bridge, labeled						
3-pos., positions 1, 3	3	red	FBS 1/3-8	24 A	3032363	10
4-pos., positions 1, 4	4	red	FBS 1/4-8	24 A	3032376	10
5-pos., positions 1, 5	5	red	FBS 1/5-8	24 A	3032381	10
5-pos., positions 1, 3, 5	5	red	FBS 1/3/5-8	24 A	3032389	10
10-pos., positions 1, 4, 7, 10	10	red	FBS 1/4/7/10-8	24 A	3032402	10
Fixed bridge						
	10	silver				
Isolator bridge bar						
	10	silver				
Switching bridge						
	2	orange				
	3	orange				
	4	orange				
Switching bridge, plug-in						
	2	gray/orange	SB-MER 2-8	30 A	3000587	10
	3	gray/orange	SB-MER 3-8	30 A	3000588	10
	4	gray/orange	SB-MER 4-8	30 A	3000589	10
Disconnect plate, 1 mm width		gray				
Test socket		silver				
Test adapter, plug-in		yellow	PAI-4-FIX YE		3032745	10
		green	PAI-4-FIX GN		3032758	10
		violet	PAI-4-FIX VT		3032761	10
		black	PAI-4-FIX BK		3032774	10
		blue	PAI-4-FIX BU		3032729	10
		violet	PAI-4-FIX VT		3032761	10
		black	PAI-4-FIX BK		3032774	10
		brown	PAI-4-FIX BN		3032787	10
		gray	PAI-4-FIX GY		3032790	10
Test adapter, screw-in		yellow				
		green				
		violet				
		black				

			Accessories			
Description	No. of pos.	Color	Type	I_{max}	Order No.	Pcs./Pkt.
Terminal block		gray	D-UT 6-T/SP		3072816	50
Plug-in bridge						
	2	red	FBS 2-8	41 A	3030284	10
	3	red	FBS 3-8	41 A	3030297	10
	4	red	FBS 4-8	41 A	3030307	10
	5	red	FBS 5-8	41 A	3030310	10
	10	red	FBS 10-8	41 A	3030323	10
Pre-assembled bridge, labeled						
3-pos., positions 1, 3	3	red	FBS 1/3-8	24 A	3032363	10
4-pos., positions 1, 4	4	red	FBS 1/4-8	24 A	3032376	10
5-pos., positions 1, 5	5	red	FBS 1/5-8	24 A	3032381	10
5-pos., positions 1, 3, 5	5	red	FBS 1/3/5-8	24 A	3032389	10
10-pos., positions 1, 4, 7, 10	10	red	FBS 1/4/7/10-8	24 A	3032402	10
Fixed bridge						
	10	silver	SCBI 10-8,15	24 A	3245134	10
Isolator bridge bar						
	10	silver	SCBI 10-8,15 ISO	24 A	3000417	10
Switching bridge						
	2	orange	SB 6-T 2-8	32 A	3075842	10
	3	orange	SB 6-T 3-8	32 A	3075843	10
	4	orange	SB 6-T 4-8	32 A	3075844	10
Switching bridge, plug-in						
	2	gray/orange	SB-MER 2-8	25 A	3000587	10
	3	gray/orange	SB-MER 3-8	25 A	3000588	10
	4	gray/orange	SB-MER 4-8	25 A	3000589	10
Disconnect plate, 1 mm width		gray	TS-UK 6-T		3072820	10
Test socket		silver	TPS 3/20/5		3246586	10
Test adapter, plug-in		yellow	PAI-4-FIX YE		3032745	10
		green	PAI-4-FIX GN		3032758	10
		violet	PAI-4-FIX VT		3032761	10
		black	PAI-4-FIX BK		3032774	10
		blue	PAI-4-FIX BU		3032729	10
		violet	PAI-4-FIX VT		3032761	10
		black	PAI-4-FIX BK		3032774	10
		brown	PAI-4-FIX BN		3032787	10
		gray	PAI-4-FIX GY		3032790	10
Test adapter, screw-in		yellow	PSBJ 6-T YE		3070326	10
		green	PSBJ 6-T GN		3070327	10
		violet	PSBJ 6-T VT		3070328	10
		black	PSBJ 6-T BK		3070318	10

Test disconnect terminal blocks

Notes:

- 1) For additional accessories and technical data, see page 172.
- For corresponding terminal strip covers, see Catalog 3.



30 A, test disconnect terminal block

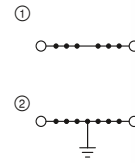

41 A, feed-through and ground terminal block, same shape



Technical data ¹⁾			
Width	Length	Height	
8.2	100.8	49.6 (NS 35/7,5)	
I _{max.} [A]	U _{max.} [V]	max. Ø [mm ²]	AWG (UL)
30	500	0.2 - 10	24-8
30 (FBS) / 30 (FBSR)			
IEC	UL / CUL	CSA	Ex
500	600	600	-
Nominal current / cross section [A] / [mm ²]			
30 / 6	30 / -	30 / -	- / -

Ordering data			
Type	Order No.	Pcs./Pkt.	
UTME 6	3047400	50	

Accessories ¹⁾			
Type	Order No.	Pcs./Pkt.	
D-UTME 6	3047426	10	



Technical data ¹⁾			
Width	Length	Height	
8.2	100.8	49.6 (NS 35/7,5)	
I _{max.} [A]	U _{max.} [V]	max. Ø [mm ²]	AWG (UL)
41	500	0.2 - 10	24-8
41 (FBS) / 32 (FBSR)			
IEC	UL / CUL	CSA	Ex
500	600	600	-
Nominal current / cross section [A] / [mm ²]			
41 / 6	30 / -	30 / -	- / -

Ordering data			
Type	Order No.	Pcs./Pkt.	
UTMED 6	3047413	50	
UTMED 6-PE	3047442	50	

Accessories ¹⁾			
Type	Order No.	Pcs./Pkt.	
D-UTME 6	3047426	10	

Dimensions	
	[mm]
Maximum electrical data	
Maximum bridge current	[A]
Rated data	
Rated voltage	[V]
Nominal current / cross section	[A] / [mm ²]
30 (FBS) / 30 (FBSR)	
500	
30 / 6	
Description	
Description	Color
Test disconnect terminal block	gray
Ground terminal	gray green-yellow
Cover, width: 2.2 mm	gray

Supplementary accessories for UTME 6 test disconnect terminal blocks



- Only two UTME 6 measuring transducer disconnect terminal blocks are required for a current transformer measuring circuit
- Less space required compared to creating circuits with slide-type terminal blocks
- ① FBS... plug-in bridge for cross connection
- ② 4 mm Ø PAI-4-FIX... test plug adapter
- ③ S-ME 6 switching lock
- ④ SB-ME... bridge bar
- ⑤ C-ME 6/2 operating lever

Description	No. of pos.	Color
Test adapter, for 4-mm-Ø safety test connector, snapped into bridge shaft	1	orange
	1	yellow
	1	green
	1	violet
	1	black
	1	blue
	1	red
	1	gray
	1	brown
Switching lock, plug-in		white
Switching bridge, plug-in	2	gray/orange
	3	gray/orange
	4	gray/orange
Operating lever, for actuating test disconnect terminal blocks	1	orange
	2	orange
	3	orange

Ordering data			
Type	Order No.	Pcs./Pkt.	
PAI-4-FIX OG	3034455	10	
PAI-4-FIX YE	3032745	10	
PAI-4-FIX GN	3032758	10	
PAI-4-FIX VT	3032761	10	
PAI-4-FIX BK	3032774	10	
PAI-4-FIX BU	3032729	10	
PAI-4-FIX RD	3032732	10	
PAI-4-FIX GY	3032790	10	
PAI-4-FIX BN	3032787	10	
S-ME 6	3034439	10	
SB-ME 2-8	3034468	10	
SB-ME 3-8	3032800	10	
SB-ME 4-8	3034484	10	
C-ME 6/1	3034441	10	
C-ME 6/2	3034442	10	
C-ME 6/3	3034390	50	

Terminal blocks – CLIPLINE complete

6 mm² UT screw connection terminal blocks

Installation terminal blocks

Notes:

¹⁾ For additional accessories and technical data, see page 172.

Assembly instruction:

In order to securely fix the neutral busbar in place, support brackets must be placed at the beginning and end of each terminal strip as well as every 20 cm on longer terminal strips. The corresponding support brackets can be found at phoenixcontact.net/products

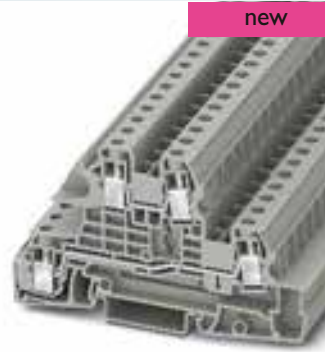
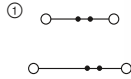

**47 A, three-level terminal block,
2 x L outer conductors**

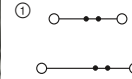

**47 A, three-level terminal block,
1 x L outer conductor L, 1 x N neutral conductor**

ERC

Technical data¹⁾

Dimensions	Width	Length	Height		
	[mm]	8.2	95	51.5 (NS 35/7,5)	
Maximum electrical data	I_{max} [A]	U_{max} [V]	max. \emptyset [mm ²]	AWG (UL)	
	47	400	0.2 - 10	-	
Rated data	34 (FBSL)	IEC	UL / CUL	CSA	Ex
	400	-	-	-	-
Nominal current / cross section	[A] / [mm ²]	38 / 6	- / -	- / -	- / -
	Connection capacity	Rigid	Flexible	Ferrule without/with plastic sleeve	
2 conductors (of the same type)	[mm ²]	0.2 - 2.5	0.2 - 2.5	-	-
General data					
Stripping length	[mm]	9			
Screw thread	M3				
Tightening torque	[Nm]	0.5 - 0.6			

Ordering data

Description	No. of pos.	Color	Type	I_{max}	Order No.	Pcs./Pkt.
Terminal block upper level blue		gray gray	UTI 6-L/L	①	3076042	50

Accessories¹⁾

Cover, width: 2.2 mm	gray	D-UTI 6/3		1025464	50	
Support bracket, to hold the neutral busbar, set every 20 cm, 2.2 mm wide	blue	AB-UTI 6/3		1037092	50	
Plug-in bridge	2	red	FBSL 2-8	34 A	3030324	10
	3	red	FBSL 3-8	34 A	3030325	10
	4	red	FBSL 4-8	34 A	3030326	10
	5	red	FBSL 5-8	34 A	3030327	10
	10	red	FBSL 10-8	34 A	3030328	10

ERC

Technical data¹⁾

Dimensions	Width	Length	Height		
	[mm]	8.2	95	51.5 (NS 35/7,5)	
Maximum electrical data	I_{max} [A]	U_{max} [V]	max. \emptyset [mm ²]	AWG (UL)	
	47	400	0.2 - 10	-	
Rated data	34 (FBSL)	IEC	UL / CUL	CSA	Ex
	400	-	-	-	-
Nominal current / cross section	[A] / [mm ²]	38 / 6	- / -	- / -	- / -
	Connection capacity	Rigid	Flexible	Ferrule without/with plastic sleeve	
2 conductors (of the same type)	[mm ²]	0.2 - 2.5	0.2 - 2.5	-	-
General data					
Stripping length	[mm]	9			
Screw thread	M3				
Tightening torque	[Nm]	0.5 - 0.6			

Ordering data

Description	No. of pos.	Color	Type	I_{max}	Order No.	Pcs./Pkt.
Terminal block upper level blue		gray gray	UTI 6-L/N	①	3076045	50

Accessories¹⁾

Cover, width: 2.2 mm	gray	D-UTI 6/3		1025464	50	
Support bracket, to hold the neutral busbar, set every 20 cm, 2.2 mm wide	blue	AB-UTI 6/3		1037092	50	
Plug-in bridge	2	red	FBSL 2-8	34 A	3030324	10
	3	red	FBSL 3-8	34 A	3030325	10
	4	red	FBSL 4-8	34 A	3030326	10
	5	red	FBSL 5-8	34 A	3030327	10
	10	red	FBSL 10-8	34 A	3030328	10

Installation terminal blocks

Notes:
 1) For additional accessories and technical data, see page 172.

Assembly instruction:
 In order to securely fix the neutral busbar in place, support brackets must be placed at the beginning and end of each terminal strip as well as every 20 cm on longer terminal strips. The corresponding support brackets can be found at phoenixcontact.net/products

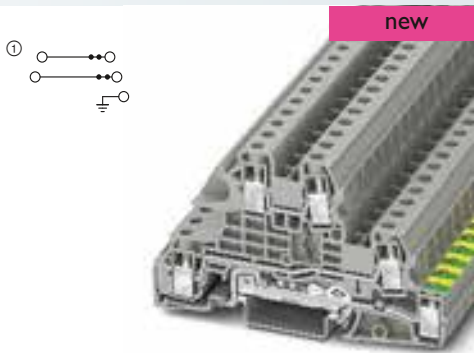

**47 A, three-level terminal block,
2 x L outer conductors, 1 x PE**

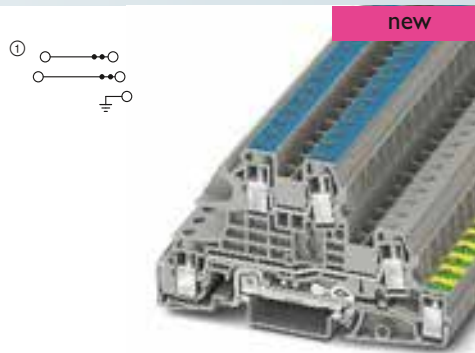

**47 A, three-level terminal block,
1 x L outer conductor, 1 x N conductor, 1 x PE**

ERC

Technical data ¹⁾				
Width	Length	Height		
8.2	95	51.5 (NS 35/7,5)		
I _{max} [A]	U _{max} [V]	max. Ø [mm ²]	AWG (UL)	
47	400	0.2 - 10	-	
34 (FBSSL)				
IEC	UL / CUL	CSA	Ex	
400	-	-	-	
Nominal current / cross section	Ferrule without/with plastic sleeve			
38 / 6	- / -	- / -	- / -	
Connection capacity	Ferrule without/with plastic sleeve			
Rigid	Flexible	-		
2 conductors (of the same type)	Ferrule without/with plastic sleeve			
0.2 - 2.5	0.2 - 2.5	-		
General data	Ferrule without/with plastic sleeve			
Stripping length	9			
Screw thread	M3			
Tightening torque	0.5 - 0.6			

Ordering data				
Type	I _{max}	Order No.	Pcs./Pkt.	
UTI 6-PE/L/L	①	3076040	50	

Accessories ¹⁾				
Type	I _{max}	Order No.	Pcs./Pkt.	
D-UTI 6/3		1025464	50	
AB-UTI 6/3		1037092	50	
FBSL 2-8	34 A	3030324	10	
FBSL 3-8	34 A	3030325	10	
FBSL 4-8	34 A	3030326	10	
FBSL 5-8	34 A	3030327	10	
FBSL 10-8	34 A	3030328	10	

ERC

Technical data ¹⁾				
Width	Length	Height		
8.2	95	51.5 (NS 35/7,5)		
I _{max} [A]	U _{max} [V]	max. Ø [mm ²]	AWG (UL)	
47	400	0.2 - 10	-	
34 (FBSSL)				
IEC	UL / CUL	CSA	Ex	
400	-	-	-	
Nominal current / cross section	Ferrule without/with plastic sleeve			
38 / 6	- / -	- / -	- / -	
Connection capacity	Ferrule without/with plastic sleeve			
Rigid	Flexible	-		
2 conductors (of the same type)	Ferrule without/with plastic sleeve			
0.2 - 2.5	0.2 - 2.5	-		
General data	Ferrule without/with plastic sleeve			
Stripping length	9			
Screw thread	M3			
Tightening torque	0.5 - 0.6			

Ordering data				
Type	I _{max}	Order No.	Pcs./Pkt.	
UTI 6-PE/L/N	①	3076041	50	

Accessories ¹⁾				
Type	I _{max}	Order No.	Pcs./Pkt.	
D-UTI 6/3		1025464	50	
AB-UTI 6/3		1037092	50	
FBSL 2-8	34 A	3030324	10	
FBSL 3-8	34 A	3030325	10	
FBSL 4-8	34 A	3030326	10	
FBSL 5-8	34 A	3030327	10	
FBSL 10-8	34 A	3030328	10	

Description	No. of pos.	Color
Terminal block upper level blue		gray gray
Cover, width: 2.2 mm		gray
Support bracket, to hold the neutral busbar, set every 20 cm, 2.2 mm wide		blue
Plug-in bridge		
	2	red
	3	red
	4	red
	5	red
	10	red

Terminal blocks – CLIPLINE complete

6 mm² UT screw connection terminal blocks

Installation terminal blocks

Notes:

¹⁾ For additional accessories and technical data, see page 172.

Assembly instruction:

In order to securely fix the neutral busbar in place, support brackets must be placed at the beginning and end of each terminal strip as well as every 20 cm on longer terminal strips. The corresponding support brackets can be found at phoenixcontact.net/products

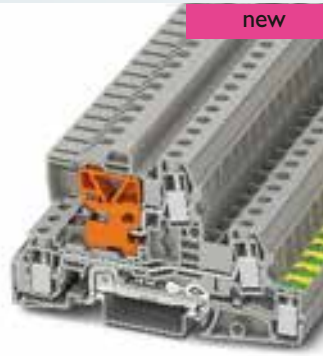
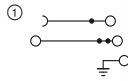

**47 A, three-level terminal block,
1 x L outer conductor, 1 x L conductor
which can be disconnected, 1 x PE**

ERC

Technical data¹⁾

Dimensions	Width	Length	Height		
	8.2	95	51.5 (NS 35/7,5)		
Maximum electrical data	I_{max} [A]	U_{max} [V]	max. Ø [mm ²]	AWG (UL)	
	47	400	0.2 - 10	-	
Rated data	34 (FBSL)	IEC	UL / CUL	CSA	Ex
Maximum bridge current [A]	400	-	-	-	-
Rated voltage [V]	400	-	-	-	-
Nominal current / cross section [A] / [mm ²]	38 / 6	- / -	- / -	- / -	- / -
Connection capacity	Rigid	Flexible	Ferrule without/with plastic sleeve		
2 conductors (of the same type) [mm ²]	0.2 - 2.5	0.2 - 2.5	-	-	
General data	Stripping length [mm]				
	9				
Screw thread				M3	
Tightening torque [Nm]				0.5 - 0.6	

Ordering data

Description	No. of pos.	Color	Type	I_{max}	Order No.	Pcs./Pkt.
Terminal block upper level blue		gray / gray	UTI 6-PE/L/LT	①	3076043	50

Accessories¹⁾

Cover, width: 2.2 mm	gray	D-UTI 6/3	1025464	50		
Support bracket, to hold the neutral busbar, set every 20 cm, 2.2 mm wide	blue	AB-UTI 6/3	1037092	50		
Plug-in bridge	2	red	FBSL 2-8	34 A	3030324	10
	3	red	FBSL 3-8	34 A	3030325	10
	4	red	FBSL 4-8	34 A	3030326	10
	5	red	FBSL 5-8	34 A	3030327	10
	10	red	FBSL 10-8	34 A	3030328	10

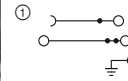

**47 A, three-level terminal block,
1 x L outer conductor, 1 x N conductor
which can be disconnected, 1 x PE**

ERC

Technical data¹⁾

Dimensions	Width	Length	Height		
	8.2	95	51.5 (NS 35/7,5)		
Maximum electrical data	I_{max} [A]	U_{max} [V]	max. Ø [mm ²]	AWG (UL)	
	47	400	0.2 - 10	-	
Rated data	34 (FBSL)	IEC	UL / CUL	CSA	Ex
Maximum bridge current [A]	400	-	-	-	-
Rated voltage [V]	400	-	-	-	-
Nominal current / cross section [A] / [mm ²]	38 / 6	- / -	- / -	- / -	- / -
Connection capacity	Rigid	Flexible	Ferrule without/with plastic sleeve		
2 conductors (of the same type) [mm ²]	0.2 - 2.5	0.2 - 2.5	-	-	
General data	Stripping length [mm]				
	9				
Screw thread				M3	
Tightening torque [Nm]				0.5 - 0.6	

Ordering data

Description	No. of pos.	Color	Type	I_{max}	Order No.	Pcs./Pkt.
Terminal block upper level blue		gray / gray	UTI 6-PE/L/NT	①	3076039	50

Accessories¹⁾

Cover, width: 2.2 mm	gray	D-UTI 6/3	1025464	50		
Support bracket, to hold the neutral busbar, set every 20 cm, 2.2 mm wide	blue	AB-UTI 6/3	1037092	50		
Plug-in bridge	2	red	FBSL 2-8	34 A	3030324	10
	3	red	FBSL 3-8	34 A	3030325	10
	4	red	FBSL 4-8	34 A	3030326	10
	5	red	FBSL 5-8	34 A	3030327	10
	10	red	FBSL 10-8	34 A	3030328	10

Installation terminal blocks

Notes:

¹⁾ For additional accessories and technical data, see page 172.

Assembly instruction:

In order to securely fix the neutral busbar in place, support brackets must be placed at the beginning and end of each terminal strip as well as every 20 cm on longer terminal strips. The corresponding support brackets can be found at phoenixcontact.net/products

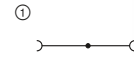

41 A, neutral disconnect terminal block

ERIC

Dimensions	
	[mm]
Maximum electrical data	
Rated data	
Maximum bridge current	[A]
Rated voltage	[V]
Nominal current / cross section	[A] / [mm ²]

Description	Color
Terminal block	blue

Cover, width: 2.2 mm	blue
Support bracket	blue

Technical data ¹⁾			
Width	Length	Height	
8.2	55	47.5 (NS 35/7,5)	
I_{max} [A]	U_{max} [V]	max. \varnothing [mm ²]	AWG (UL)
41	400	0.2 - 10	-
41 (FBS) / 32 (FBSR)			
	IEC	UL / CUL	CSA Ex
	400	-	-
	41 / 6	- / -	- / -

Ordering data		
Type	Order No.	Pcs./Pkt.
UTN 6	3245037	50

Accessories ¹⁾		
D-UTN 2,5/10	3245079	50
AB-UTN 2,5/10	3245082	50

Terminal blocks – CLIPLINE complete

10 mm² UT screw connection terminal blocks

General technical data

Rated data		IEC 60947-7-1 / IEC 60947-7-2			
Rated cross section	[mm ²]	10			
Cross section range	AWG	20 - 6			
Connection capacity		Rigid	Flexible	Ferrule without/with plastic sleeve	
1 conductor	[mm ²]	0.5 - 16	0.5 - 16	0.5 - 10	0.5 - 10
2 conductors (of the same type)	[mm ²]	0.5 - 4	0.5 - 4	0.5 - 2.5	-
2 flexible conductors with a TWIN ferrule	[mm ²]	-	-	-	0.5 - 6
General data					
Stripping length	[mm]	10			
Screw thread		M4			
Tightening torque	[Nm]	1.5 - 1.8			
Insulating material		PA			
Flammability rating in accordance with UL 94		VO			

Note: Additional or deviating data is listed alongside the respective product.

Notes:



In addition to the product, the internal electrical wiring is provided as a circuit diagram. Free connection points for bridging are indicated by a black dot.

The specified technical data and approvals refer to the first product in each column. For information on the products below, please refer to phoenixcontact.net/products

For full details of UL and CSA use groups, file nos., and Internet links, please visit phoenixcontact.net/products

¹⁾ The bridge current is listed alongside the respective product. For additional colors, see page 402.

System accessories

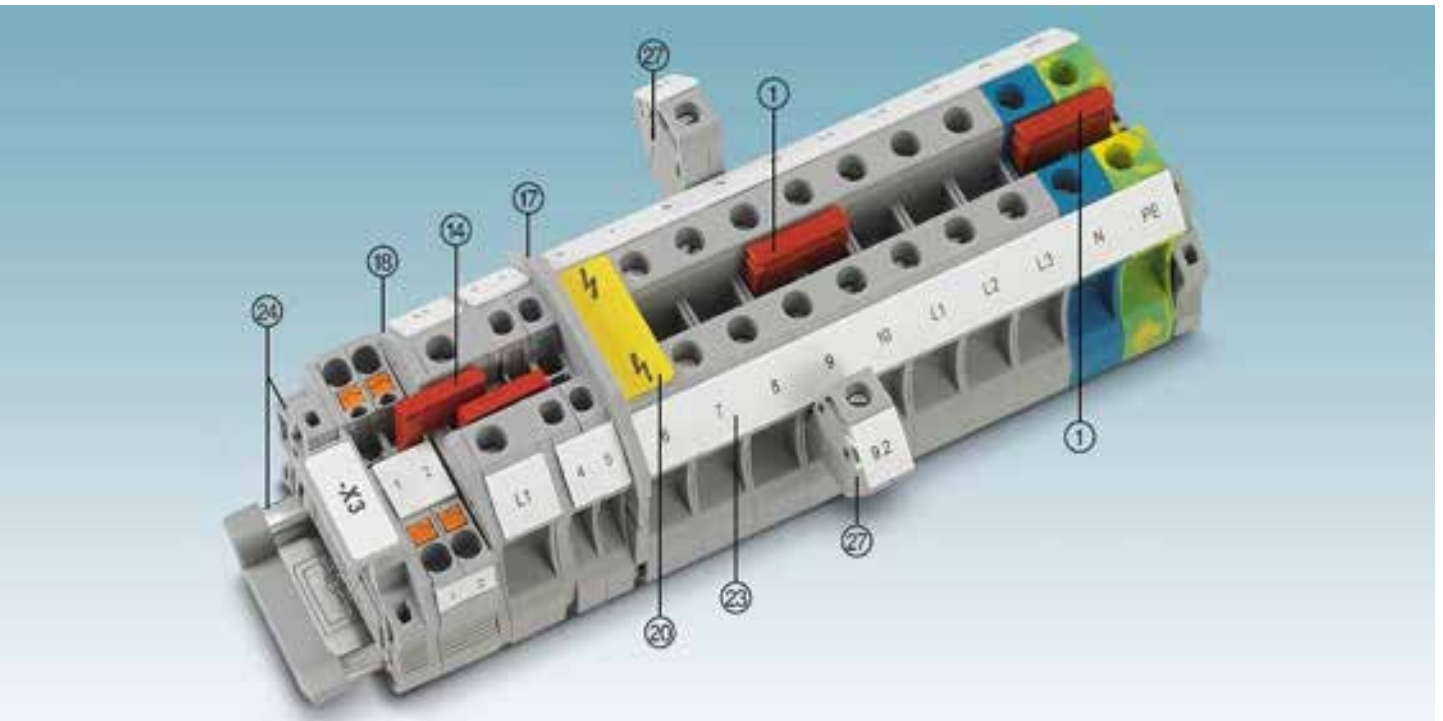

Description	No. of pos.	Color	Type	Order No.	Pcs./Pkt.	Type	Order No.	Pcs./Pkt.
① Bridge ¹⁾	2	red	FBS 2-10	3005947	10			
	5	red	FBS 5-10	3005948	10			
② Tap-off terminal block		gray	AGK 4-UT 10	3047112	50			
Screwdriver			SZS 1,0X4,0 VDE	1205066	10			
④ Reducing bridge			For RB ..., see page 408.					
⑦ Partition plates/end cover segments			For ATP-... / DS-..., visit phoenixcontact.net/products					
⑧ Cover			Listed alongside the respective product.					
⑨ Warning labels			For WS ..., see page 420.					
⑩ Lateral groove labeling			UC-TM 10, UCT-TM 10 or ZB 10. See also Catalog 3, selection tables, from page 60.					
⑫ DIN rail and end bracket			See Catalog 3					
For full accessories, visit phoenixcontact.net/products			Note: Additional or deviating accessories are listed alongside the respective product.					

Feed-through and ground terminal blocks

Notes:

¹⁾ For additional accessories and technical data, see page 182.

For information on installation and using accessories for Ex applications, see page 678.

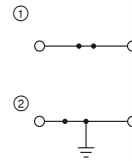

76 A, feed-through and ground terminal block



Ex:

KEMA 04ATEX2048 U / IECEx KEM 06.0027U

Technical data¹⁾

Dimensions	Width	Length	Height	
	10.2	47.7	47.5 (NS 35/7,5)	
Maximum electrical data	I_{max} [A]	U_{max} [V]	max. Ø [mm ²]	AWG (UL)
	76	1000	0.5 - 16	20-6
Maximum bridge current	57			
Rated data	IEC	UL / CUL	CSA	Ex
Rated voltage	1000	600	600	690
Nominal current / cross section	57 / 10	65 / -	65 / -	54 / 10

Ordering data

Description	Color	Type	Order No.	Pcs./Pkt.
Terminal block	gray	UT 10	^① 3044160	50
	blue	UT 10 BU	^① 3044188	50
Ground terminal	green-yellow	UT 10-PE	^② 3044173	50

Accessories¹⁾

Description	Color	Type	Order No.	Pcs./Pkt.
Cover, width: 2.2 mm	gray	D-UT 2,5/10	3047028	50

Installation terminal blocks

Notes:

¹⁾ For additional accessories and technical data, see page 182.

Assembly instruction:

In order to securely fix the neutral busbar in place, support brackets must be placed at the beginning and end of each terminal strip as well as every 20 cm on longer terminal strips. The corresponding support brackets can be found at phoenixcontact.net/products

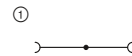

57 A, neutral disconnect terminal block

ERIC

Technical data¹⁾

Dimensions	Width	Length	Height	
	10.2	55	47.5 (NS 35/7,5)	
Maximum electrical data	I_{max} [A]	U_{max} [V]	max. Ø [mm ²]	AWG (UL)
	57	400	0.5 - 16	-
Maximum bridge current	57			
Rated data	IEC	UL / CUL	CSA	Ex
Rated voltage	400	-	-	-
Nominal current / cross section	57 / 10	- / -	- / -	- / -

Ordering data

Description	Color	Type	Order No.	Pcs./Pkt.
Terminal block	blue	UTN 10	^① 3245040	50

Accessories¹⁾

Description	Color	Type	Order No.	Pcs./Pkt.
Cover, width: 2.2 mm	blue	D-UTN 2,5/10	3245079	50
Support bracket	blue	AB-UTN 2,5/10	3245082	50

Terminal blocks – CLIPLINE complete

16 mm² UT screw connection terminal blocks

General technical data

Rated data		IEC 60947-7-1 / IEC 60947-7-2			
Rated cross section	[mm ²]	16			
Cross section range	AWG	16 - 4			
Connection capacity		Rigid	Flexible	Ferrule without/with plastic sleeve	
1 conductor	[mm ²]	1.5 - 25	1.5 - 25	1 - 16	1 - 16
2 conductors (of the same type)	[mm ²]	1 - 6	1 - 6	1 - 6	-
2 flexible conductors with a TWIN ferrule	[mm ²]	-	-	-	0.75 - 10
General data					
Stripping length	[mm]	14			
Screw thread		M5			
Tightening torque	[Nm]	2.5 - 3			
Insulating material		PA			
Flammability rating in accordance with UL 94		VO			

Note: Additional or deviating data is listed alongside the respective product.

Notes:



In addition to the product, the internal electrical wiring is provided as a circuit diagram. Free connection points for bridging are indicated by a black dot.

The specified technical data and approvals refer to the first product in each column. For information on the products below, please refer to phoenixcontact.net/products

For full details of UL and CSA use groups, file nos., and Internet links, please visit phoenixcontact.net/products

¹⁾ The bridge current is listed alongside the respective product. For additional colors, see page 402.

System accessories

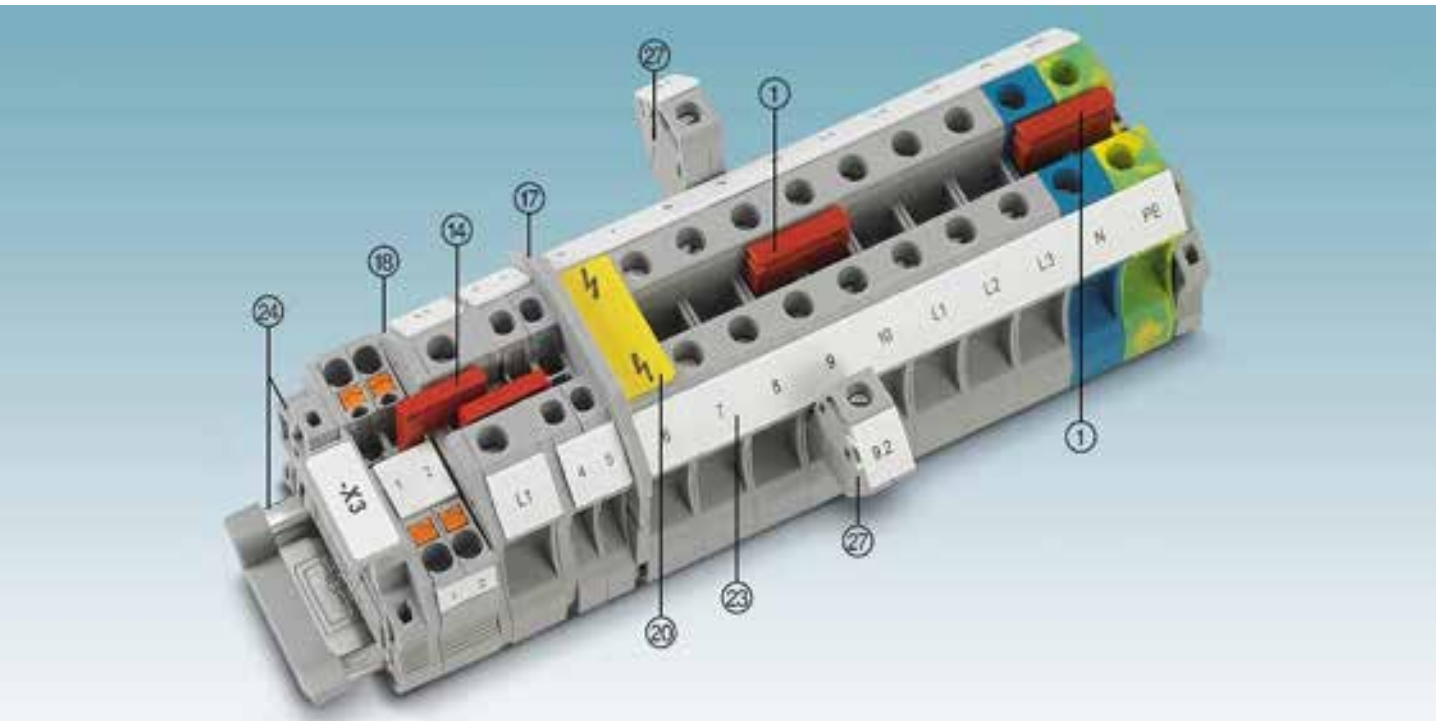

Description	No. of pos.	Color	Type	Order No.	Pcs./Pkt.	Type	Order No.	Pcs./Pkt.
① Bridge ¹⁾	2	red	FBS 2-12	3005950	10			
② Tap-off terminal block		gray	AGK 4-UT 16	3047125	50			
Screwdriver			SZS 1,0X6,5 VDE	1205079	10			
④ Reducing bridge			For RB ..., see page 408.					
⑦ Partition plates/end cover segments			For ATP-... / DS-..., visit phoenixcontact.net/products					
⑧ Cover			Listed alongside the respective product.					
⑫ Warning labels			For WS ..., see page 420.					
⑬ Lateral groove labeling			UC-TM 12, UCT-TM 12 or ZB 12. See also Catalog 3, selection tables, from page 60.					
⑭ DIN rail and end bracket			See Catalog 3					
For full accessories, visit phoenixcontact.net/products			Note: Additional or deviating accessories are listed alongside the respective product.					

Feed-through and ground terminal blocks

Notes:

¹⁾ For additional accessories and technical data, see page 184.

For information on installation and using accessories for Ex applications, see page 678.

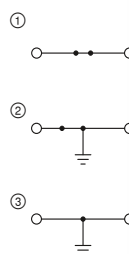

101 A, feed-through and ground terminal block



Ex: EAC Ex IEC CB
KEMA 04ATEX2048 U / IECEx KEM 06.0027U

Technical data¹⁾

Dimensions		Width	Length	Height
	[mm]	12.2	55.5	55 (NS 35/7,5)
Maximum electrical data		I_{max} [A]	U_{max} [V]	max. Ø [mm ²] AWG (UL)
		101	1000	1.5 - 25 16-4
Maximum bridge current	[A]	76		
Rated data		IEC	UL / CUL	CSA Ex
Rated voltage	[V]	1000	600	600 690
Nominal current / cross section	[A] / [mm ²]	76 / 16	85 / -	85 / - 73.5 / 16

Ordering data

Description	Color	Type	Order No.	Pcs./Pkt.
Terminal block	gray	UT 16	① 3044199	50
	blue	UT 16 BU	① 3044209	50
Ground terminal	green-yellow	UT 16-PE	② 3044212	50
With screw foot	green-yellow	UT 16-PE/S	③ 3215915	50

Accessories¹⁾

Description	Color	Type	Order No.	Pcs./Pkt.
Cover, width: 2.2 mm	gray	D-UT 16	3047206	50

Installation terminal blocks

Notes:

¹⁾ For additional accessories and technical data, see page 184.

Only the FBI 10-12 bridge (Order No. 0203454) can be used for UT1 16.

Assembly instruction:

In order to securely fix the neutral busbar in place, support brackets must be placed at the beginning and end of each terminal strip as well as every 20 cm on longer terminal strips. The corresponding support brackets can be found at phoenixcontact.net/products

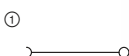

76 A, neutral disconnect terminal block

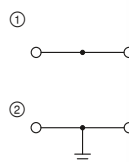

76 A, feed-through and ground terminal block

ERC

Technical data¹⁾

Dimensions		Width	Length	Height
	[mm]	12.2	55	50.5 (NS 35/7,5)
Maximum electrical data		I_{max} [A]	U_{max} [V]	max. Ø [mm ²] AWG (UL)
		76	400	6 - 25 -
Maximum bridge current	[A]	-		
Rated data		IEC	UL / CUL	CSA Ex
Rated voltage	[V]	400	-	- -
Nominal current / cross section	[A] / [mm ²]	76 / 16	- / -	- / - - / -
Cross section range	AWG	10 - 4	-	- -
Connection capacity		Rigid	Flexible	Ferrule without/with plastic sleeve
1 conductor	[mm ²]	6 - 25	6 - 16	6 - 16 6 - 16
2 conductors (of the same type)	[mm ²]	2.5 - 10	2.5 - 6	4 - 6 -
General data		Stripping length [mm]		
		12		
Flammability rating in accordance with UL 94		V2		

Ordering data

Description	Color	Type	Order No.	Pcs./Pkt.
Terminal block	gray	UTN 16	① 3245053	50
	blue			
Ground terminal	green-yellow			

ERC

Technical data¹⁾

Dimensions		Width	Length	Height
	[mm]	12.2	51	50.5 (NS 35/7,5)
Maximum electrical data		I_{max} [A]	U_{max} [V]	max. Ø [mm ²] AWG (UL)
		76	400	6 - 25 -
Maximum bridge current	[A]	101		
Rated data		IEC	UL / CUL	CSA Ex
Rated voltage	[V]	400	-	- -
Nominal current / cross section	[A] / [mm ²]	76 / 16	- / -	- / - - / -
Cross section range	AWG	10 - 4	-	- -
Connection capacity		Rigid	Flexible	Ferrule without/with plastic sleeve
1 conductor	[mm ²]	6 - 25	6 - 16	6 - 16 6 - 16
2 conductors (of the same type)	[mm ²]	2.5 - 10	2.5 - 6	4 - 6 -
General data		Stripping length [mm]		
		12		
Flammability rating in accordance with UL 94		V2		

Ordering data

Description	Color	Type	Order No.	Pcs./Pkt.
Terminal block	gray	UTI 16	① 3073827	50
	blue	UTI 16 BU	① 3075728	50
Ground terminal	green-yellow	UTI 16-PE	② 3073830	50

Terminal blocks – CLIPLINE complete

35 mm² UT screw connection terminal blocks

General technical data

Rated data		IEC 60947-7-1 / IEC 60947-7-2			
Rated cross section	[mm ²]	35			
Cross section range	AWG	16 - 1/0			
Connection capacity		Rigid	Flexible	Ferrule without/with plastic sleeve	
1 conductor	[mm ²]	1.5 - 50	1.5 - 50	1.5 - 35	1.5 - 35
2 conductors (of the same type)	[mm ²]	1.5 - 16	1.5 - 10	1.5 - 10	-
2 flexible conductors with a TWIN ferrule	[mm ²]	-	-	-	1.5 - 16
General data					
Stripping length	[mm]	18			
Screw thread		M6			
Tightening torque	[Nm]	3.2 - 3.7			
Insulating material		PA			
Flammability rating in accordance with UL 94		VO			

Note: Additional or deviating data is listed alongside the respective product.

Notes:



In addition to the product, the internal electrical wiring is provided as a circuit diagram. Free connection points for bridging are indicated by a black dot.

The specified technical data and approvals refer to the first product in each column. For information on the products below, please refer to phoenixcontact.net/products

For full details of UL and CSA use groups, file nos., and Internet links, please visit phoenixcontact.net/products

¹⁾ The bridge current is listed alongside the respective product. For additional colors, see page 402.

System accessories

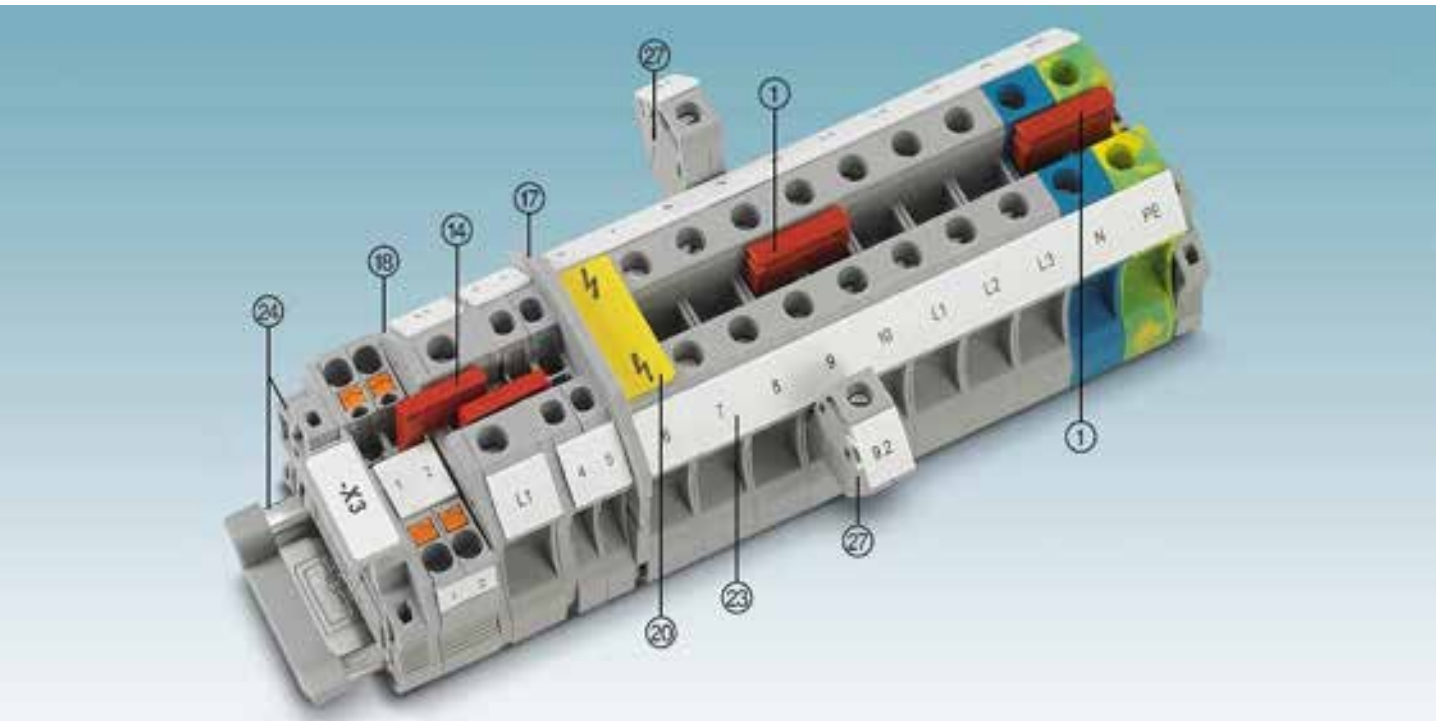

Description	No. of pos.	Color	Type	Order No.	Pcs./Pkt.	Type	Order No.	Pcs./Pkt.
① Bridge ¹⁾	2	red	FBS 2-16	3005963	10			
② Tap-off terminal block		gray	AGK 4-UT 35	3047138	50			
Screwdriver			SZS 1,0X6,5 VDE	1205079	10			
④ Reducing bridge			For RB ..., see page 408.					
⑦ Partition plates/end cover segments			For ATP-... / DS-..., visit phoenixcontact.net/products					
⑧ Cover			Listed alongside the respective product.					
⑨ Warning labels			For WS ..., see page 420.					
⑫ Lateral groove labeling			UC-TM 16, UCT-TM 16 or ZB 16,3. See also Catalog 3, selection tables from page 60.					
⑭ DIN rail and end bracket			See Catalog 3					
For full accessories, visit phoenixcontact.net/products			Note: Additional or deviating accessories are listed alongside the respective product.					

Feed-through and ground terminal blocks

Notes:
 1) For additional accessories and technical data, see page 186.
 For information on installation and using accessories for Ex applications, see page 678.

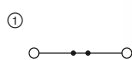

150 A, feed-through terminal block

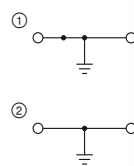

Ground terminal

Ex:

 KEMA 04ATEX2048 U / IECEx KEM 06.0027U

Technical data ¹⁾				
Width	Length	Height		
16	61.2	65.7 (NS 35/7,5)		
<i>I</i> _{max.} [A]	<i>U</i> _{max.} [V]	max. Ø [mm ²]	AWG (UL)	
150	1000	1.5 - 50	14	
Maximum bridge current	101			
Rated data	IEC	UL / CUL	CSA	Ex
Rated voltage	1000	1000	1000	690
Nominal current / cross section	125 / 35	150 / -	150 / -	123 / 35
Cross section range	AWG 16 - 1/0	-	-	-
Connection capacity	Rigid	Flexible	Ferrule without/with plastic sleeve	
1 conductor	1.5 - 50	1.5 - 50	1.5 - 35	1.5 - 35

Ordering data			
Type	Order No.	Pcs./Pkt.	
UT 35	3044225	50	
UT 35 BU	3044238	50	

Ex:

 KEMA 04ATEX2048 U / IECEx KEM 06.0027U

Technical data ¹⁾				
Width	Length	Height		
16	61.2	65.7 (NS 35/7,5)		
<i>I</i> _{max.} [A]	<i>U</i> _{max.} [V]	max. Ø [mm ²]	AWG (UL)	
150	1000	1.5 - 35	14-2	
Maximum bridge current	101			
Rated data	IEC	UL / CUL	CSA	Ex
Rated voltage	1000	1000	1000	690
Nominal current / cross section	125 / 35	150 / -	150 / -	123 / 35
Cross section range	AWG 16 - 2	-	-	- / 35
Connection capacity	Rigid	Flexible	Ferrule without/with plastic sleeve	
1 conductor	1.5 - 35	1.5 - 35	1.5 - 35	1.5 - 35

Ordering data			
Type	Order No.	Pcs./Pkt.	
UT 35-PE	3044241	50	
UT 35-PE/S	3215928	50	

Installation terminal blocks

Notes:
 1) For additional accessories and technical data, see page 186.
 Only FBI ...-15 bridges can be used for UTI 35.
Assembly instruction:
 In order to securely fix the neutral busbar in place, support brackets must be placed at the beginning and end of each terminal strip as well as every 20 cm on longer terminal strips. The corresponding support brackets can be found at phoenixcontact.net/products



110 A, neutral disconnect terminal block

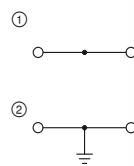

125 A, feed-through and ground terminal block

Technical data¹⁾

Technical data ¹⁾				
Width	Length	Height		
15	55	51 (NS 35/7,5) / 56 (NS 32)		
<i>I</i> _{max.} [A]	<i>U</i> _{max.} [V]	max. Ø [mm ²]	AWG (UL)	
110	400	0.75 - 35	-	
Maximum bridge current	-			
Rated data	IEC	UL / CUL	CSA	Ex
Rated voltage	400	-	-	-
Nominal current / cross section	110 / 35	- / -	- / -	- / -
Cross section range	AWG 18 - 2	-	-	-
Connection capacity	Rigid	Flexible	Ferrule without/with plastic sleeve	
1 conductor	0.75 - 35	0.75 - 35	0.75 - 35	0.75 - 35
2 conductors (of the same type)	0.75 - 10	0.75 - 10	0.75 - 10	-
General data	Stripping length [mm] 16			
Flammability rating in accordance with UL 94	V2			

Ordering data			
Type	Order No.	Pcs./Pkt.	
UTN 35	3245066	50	

Technical data¹⁾

Technical data ¹⁾				
Width	Length	Height		
15.2	55	51 (NS 35/7,5) / 56 (NS 32)		
<i>I</i> _{max.} [A]	<i>U</i> _{max.} [V]	max. Ø [mm ²]	AWG (UL)	
125	800	0.75 - 35	-	
Maximum bridge current	135			
Rated data	IEC	UL / CUL	CSA	Ex
Rated voltage	800	-	-	-
Nominal current / cross section	125 / 35	- / -	- / -	- / -
Cross section range	AWG 18 - 2	-	-	-
Connection capacity	Rigid	Flexible	Ferrule without/with plastic sleeve	
1 conductor	0.75 - 35	0.75 - 35	0.75 - 35	0.75 - 35
2 conductors (of the same type)	0.75 - 10	0.75 - 10	0.75 - 10	-
General data	Stripping length [mm] 16			
Flammability rating in accordance with UL 94	V2			

Ordering data			
Type	Order No.	Pcs./Pkt.	
UTI 35	3074088	50	
UTI 35 BU	3075731	50	
UTI 35-PE	3074091	50	

Terminal blocks – CLIPLINE complete

50 mm² UKH screw connection terminal blocks

General technical data

Rated data		IEC 60947-7-1 / IEC 60947-7-2			
Rated cross section	[mm ²]	50			
Cross section range	AWG	6 - 2/0			
Connection capacity		Rigid	Flexible	Ferrule without/with plastic sleeve	
1 conductor	[mm ²]	16 - 70	25 - 70	25 - 50	25 - 50
2 conductors (of the same type)	[mm ²]	10 - 16	10 - 16	10 - 16	-
2 flexible conductors with a TWIN ferrule	[mm ²]	-	-	-	-
General data					
Stripping length	[mm]	24			
Screw thread		M6			
Tightening torque	[Nm]	6 - 8			
Insulating material		PA			
Flammability rating in accordance with UL 94		VO			

Note: Additional or deviating data is listed alongside the respective product.

Notes:



In addition to the product, the internal electrical wiring is provided as a circuit diagram. Free connection points for bridging are indicated by a black dot.

The specified technical data and approvals refer to the first product in each column. For information on the products below, please refer to phoenixcontact.net/products

For full details of UL and CSA use groups, file nos., and Internet links, please visit phoenixcontact.net/products

¹⁾ The bridge current is listed alongside the respective product. For additional colors, see page 402.

System accessories

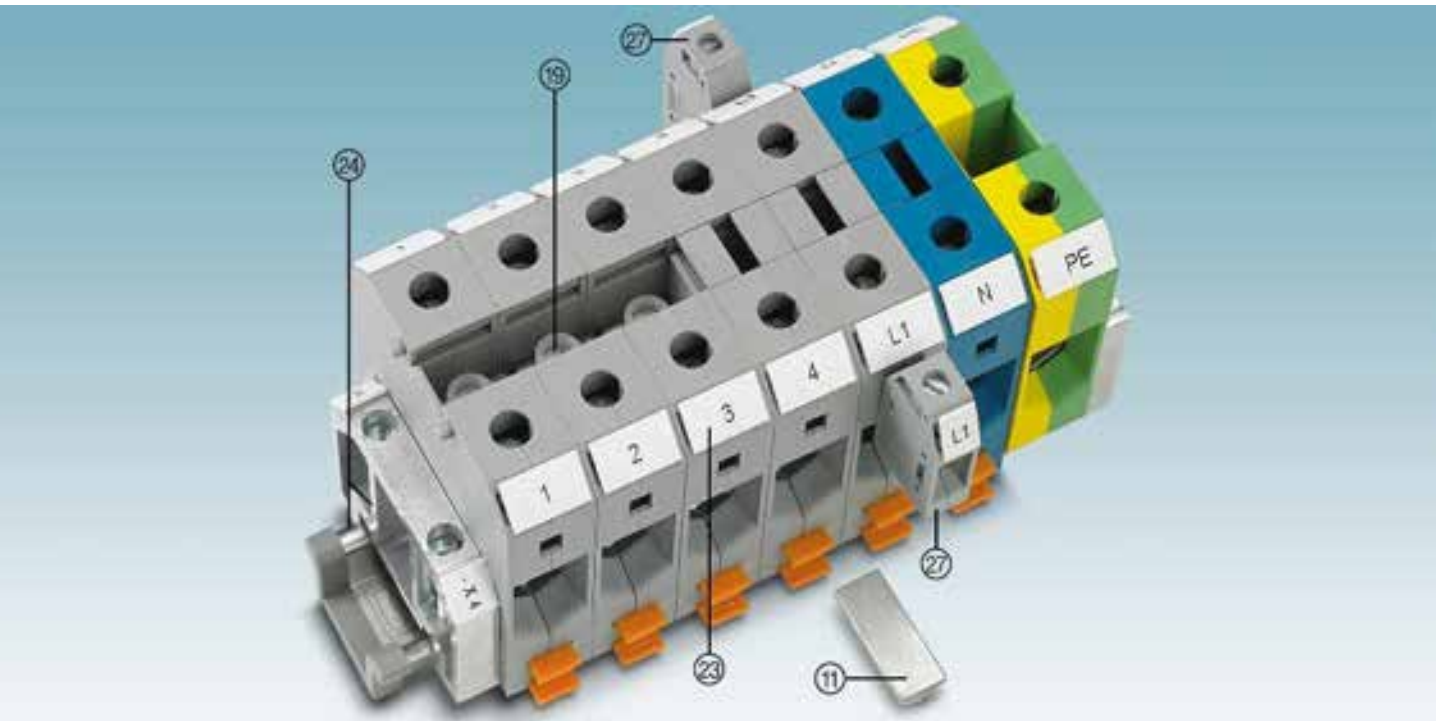

Description	No. of pos.	Color	Type	Order No.	Pcs./Pkt.	Type	Order No.	Pcs./Pkt.
Ⓣ Fixed bridge ¹⁾	2	silver	FBI 2-20	0201346	10			
	3	silver	FBI 3-20	0201317	10			
Ⓜ Insertion profile for flat conductor connection, see page 682		silver	UKH 50 EP	3009228	10			
Ⓡ Tap-off terminal block		gray	AGK 10-UKH 50	3001763	10			
Screwdriver			SZS 1,2X8,0 VDE	1205082	10			
Ⓢ Lateral groove labeling			UC-TM 10, UCT-TM 10 or ZB 10. See also Catalog 3, selection tables, from page 60.					
Ⓣ DIN rail and end bracket			See Catalog 3					
For full accessories, visit phoenixcontact.net/products			Note: Additional or deviating accessories are listed alongside the respective product.					

High-current terminal blocks

Notes:

¹⁾ For additional accessories and technical data, see page 188.

For information on installation and using accessories for Ex applications, see page 678.

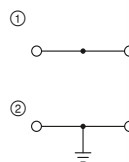

150 A, feed-through terminal block



Ex: EAC Ex IEC CB
KEMA 98ATEX1786U / IECEX KEM 06.0029U

Technical data¹⁾

Dimensions	Width	Length	Height	
	20	70.5	83.5 (NS 35/15) / 81 (NS 32)	
Maximum electrical data	I_{max} [A]	U_{max} [V]	max. Ø [mm ²]	AWG (UL)
	150	1000	16 - 70	6
Maximum bridge current	150			
Rated data	IEC	UL / CUL	CSA	Ex
Rated voltage	1000	600	600	690
Nominal current / cross section	150 / 50	150 / -	150 / -	133 / 50

Ordering data

Description	Color	Type	Order No.	Pcs./Pkt.
Terminal block	gray	UKH 50	① 3009118	10
	blue	UKH 50 BU	① 3009105	10
Terminal block, voltage 1500 V	gray	UKH 50 1500V	① 3247400	10
	blue	UKH 50 1500V BU	① 3247402	10
Ground terminal	green-yellow	USLKG 50	② 0443049	10

High-current terminal blocks for direct mounting

Notes:

¹⁾ For additional accessories and technical data, see page 188.

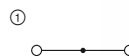

150 A, feed-through terminal block for direct mounting



Technical data¹⁾

Dimensions	Width	Length	Height	
	20	103.4	76	
Maximum electrical data	I_{max} [A]	U_{max} [V]	max. Ø [mm ²]	AWG (UL)
	150	1000	16 - 70	-
Maximum bridge current	150			
Rated data	IEC	UL / CUL	CSA	Ex
Rated voltage	1000	-	-	-
Nominal current / cross section	150 / 50	- / -	- / -	- / -

Ordering data

Description	Color	Type	Order No.	Pcs./Pkt.
Terminal block, for direct mounting	gray	UKH 50-F	① 3247019	10

Terminal blocks – CLIPLINE complete

70 mm² UKH screw connection terminal blocks

General technical data

Rated data		IEC 60947-7-1 / IEC 60947-7-2			
Rated cross section	[mm ²]	70			
Cross section range	AWG	4 - 3/0			
Connection capacity		Rigid	Flexible	Ferrule without/with plastic sleeve	
1 conductor	[mm ²]	16 - 95	25 - 70	16 - 70	16 - 70
2 conductors (of the same type)	[mm ²]	16 - 25	16 - 25	16 - 25	-
2 flexible conductors with a TWIN ferrule	[mm ²]	-	-	-	-
General data					
Stripping length	[mm]	24			
Screw thread		M8			
Tightening torque	[Nm]	8 - 10			
Insulating material		PA			
Flammability rating in accordance with UL 94		VO			

Note: Additional or deviating data is listed alongside the respective product.

Notes:



In addition to the product, the internal electrical wiring is provided as a circuit diagram. Free connection points for bridging are indicated by a black dot.

The specified technical data and approvals refer to the first product in each column. For information on the products below, please refer to phoenixcontact.net/products

For full details of UL and CSA use groups, file nos., and Internet links, please visit phoenixcontact.net/products

¹⁾ The bridge current is listed alongside the respective product. For additional colors, see page 402.

System accessories

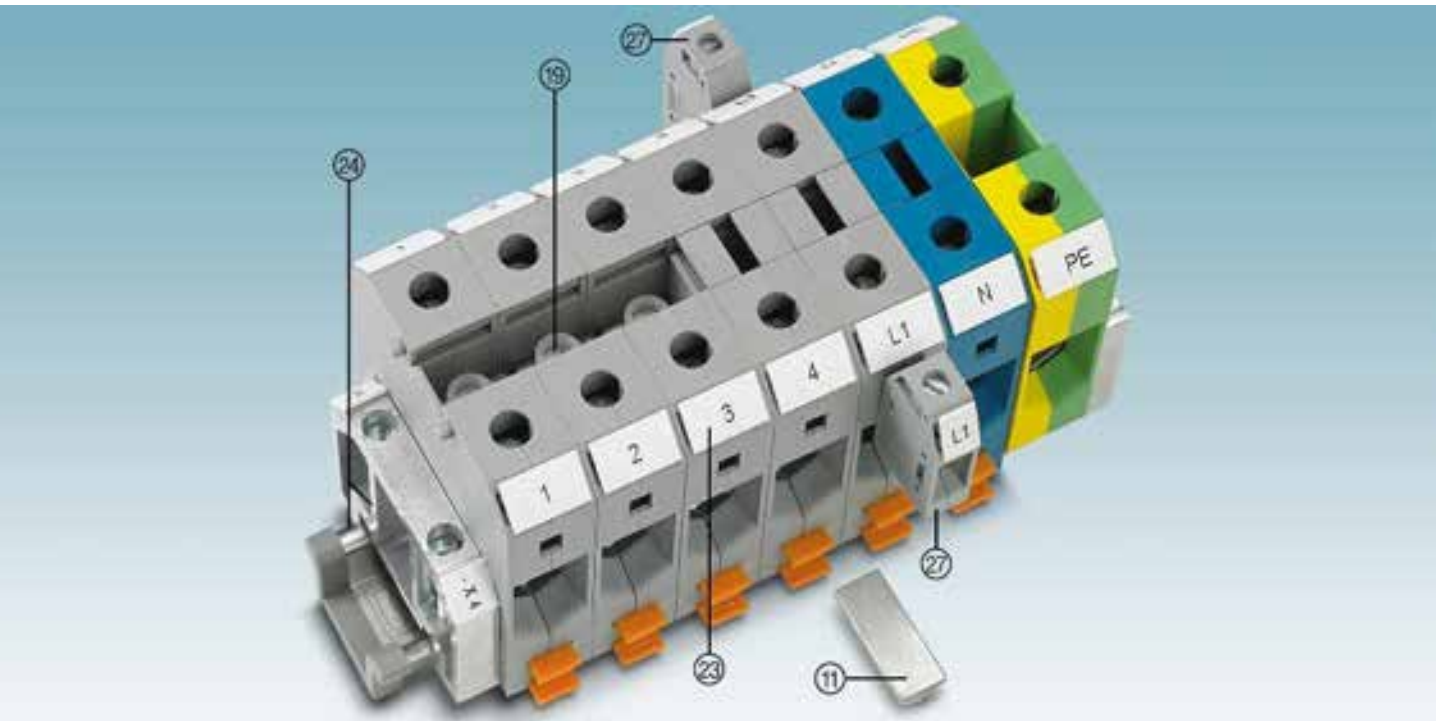

Description	No. of pos.	Color	Type	Order No.	Pcs./Pkt.	Type	Order No.	Pcs./Pkt.
Ⓣ Fixed bridge ¹⁾	2	silver	FBI 2-20 N	3213195	10			
	3	silver	FBI 3-20 N	3213205	10			
Ⓜ Insertion profile for flat conductor connection, see page 682		silver	UKH 50 EP	3009228	10			
Ⓢ Tap-off terminal block		gray	AGK 10-UKH 50	3001763	10			
Allen key			SF-THEX 6-200	1212642	5			
Ⓝ Lateral groove labeling			UC-TM 10, UCT-TM 10 or ZB 10. See also Catalog 3, selection tables, from page 60.					
Ⓞ DIN rail and end bracket			See Catalog 3					
For full accessories, visit phoenixcontact.net/products			Note: Additional or deviating accessories are listed alongside the respective product.					

High-current terminal blocks

Notes:
 1) For additional accessories and technical data, see page 190.
 For information on installation and using accessories for Ex applications, see page 678.

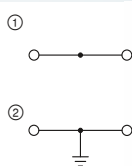

192 A, feed-through terminal block

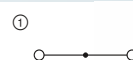

192 A, terminal block base

UL US EAC Ex IEC CB
 Ex: Ex UL US EAC Ex IEC CB
 SEV12ATEX0168U / IECEx SEV12.0008U

Technical data ¹⁾			
Width	Length	Height	
20.3	70.5	80 (NS 35/7,5) / 85 (NS 32)	
I _{max.} [A]	U _{max.} [V]	max. Ø [mm ²]	AWG (UL)
192	1000	16 - 95	6
192			
IEC	UL / CUL	CSA	Ex
1000	1000	1000	880
192 / 70	192 / -	192 / -	180 / 70

Ordering data			
Type	Order No.	Pcs./Pkt.	
UKH 70	3213140	10	
UKH 70 BU	3244601	10	
UKH 70 1500V	3247461	10	
UKH 70-PE/S	3213141	10	

UL US

Technical data ¹⁾			
Width	Length	Height	
60.9	70.5	87.5 (NS 35/15) / 85 (NS 32)	
I _{max.} [A]	U _{max.} [V]	max. Ø [mm ²]	AWG (UL)
192	1000	16 - 95	6
192			
IEC	UL / CUL	CSA	Ex
1000	1000	-	-
192 / 70	192 / -	- / -	- / -

Ordering data			
Type	Order No.	Pcs./Pkt.	
UKH 70-3L	3076329	4	
UKH 70-3L/N	3076361	3	
UKH 70-3L/FE	3076400	3	
UKH 70-3L/N/FE	3076442	2	

High-current terminal blocks for direct mounting

Notes:
 1) For additional accessories and technical data, see page 190.

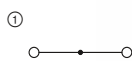

192 A, feed-through terminal block for direct mounting

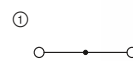

192 A, terminal block base for direct mounting

UL US

Technical data ¹⁾			
Width	Length	Height	
20.3	103.4	80	
I _{max.} [A]	U _{max.} [V]	max. Ø [mm ²]	AWG (UL)
192	1000	16 - 95	6
192			
IEC	UL / CUL	CSA	Ex
1000	1000	-	-
192 / 70	192 / -	- / -	- / -

Ordering data			
Type	Order No.	Pcs./Pkt.	
UKH 70-F	3247051	10	

UL US

Technical data ¹⁾			
Width	Length	Height	
60.9	103.4	80	
I _{max.} [A]	U _{max.} [V]	max. Ø [mm ²]	AWG (UL)
192	1000	16 - 95	6
192			
IEC	UL / CUL	CSA	Ex
1000	1000	-	-
192 / 70	192 / -	- / -	- / -

Ordering data			
Type	Order No.	Pcs./Pkt.	
UKH 70-3L-F	3076484	4	
UKH 70-3L/N-F	3076523	3	
UKH 70-3L/FE-F	3076565	3	
UKH 70-3L/N/FE-F	3076604	2	

Terminal blocks – CLIPLINE complete

70 mm² UKH screw connection terminal blocks

High-current terminal blocks

Notes:
For additional accessories and technical data, see page 190



- Compact high-current terminal blocks with 1500 V nominal voltage
- For use in renewable power generation – specifically in photovoltaics
- Four integrated pick-off terminal blocks with a 10 mm² cross section for a simple power supply or potential distribution
- Compact, space-saving design
- Bridgeable with screw-type bridges for easy potential distribution
- Large-surface marking options

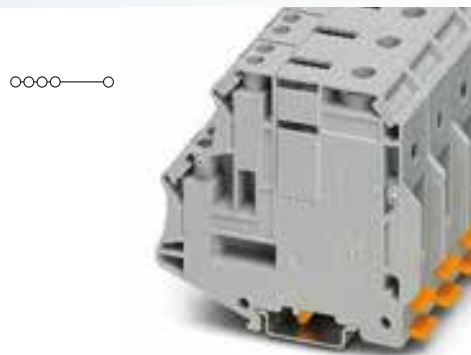

**192 A, potential collective terminal,
4 inputs 10 mm²**



Dimensions		[mm]	
Dimensions		Width	Length
		20.3	88.5
Dimensions		Width	Length
		20.3	88.5
Dimensions		Width	Length
		20.3	88.5
Maximum electrical data			
		I _{max} [A]	U _{max} [V]
		192	1500
Rated data			
		Rated voltage [V]	1500
		Nominal current / cross section [A] / [mm ²]	192 / -
		Rated cross section [mm ²]	70
		Cross section range AWG	4 - 3/0
Supply connection capacity			
		1 conductor [mm ²]	16 - 95
		2 conductors (of the same type) [mm ²]	16 - 25
Branch connection capacity			
		1 conductor [mm ²]	1.5 - 16
		2 conductors (of the same type) [mm ²]	1.5 - 2.5

Technical data			
Width	Length	Height NS 35/7,5	
20.3	88.5	80	
Width	Length	Height NS 35/15	
20.3	88.5	87.5	
Width	Length	Height NS 32	
20.3	88.5	85	
I _{max} [A]	U _{max} [V]	max. Ø [mm ²]	AWG (UL)
192	1500	16 - 95	-
IEC 60947-7-1			
IEC	UL	CSA	IEC/EN 60079-7
Rated voltage [V]	-	-	-
Nominal current / cross section [A] / [mm ²]	- / -	- / -	-
Rated cross section [mm ²]	-	-	-
Cross section range AWG	-	-	-
Supply connection capacity		Rigid	Flexible
		Ferrule	
		without/with plastic sleeve	
1 conductor [mm ²]	16 - 95	25 - 70	16 - 70
2 conductors (of the same type) [mm ²]	16 - 25	16 - 25	16 - 25
Branch connection capacity		Rigid	Flexible
		Ferrule	
		without/with plastic sleeve	
1 conductor [mm ²]	1.5 - 16	1.5 - 10	1.5 - 10
2 conductors (of the same type) [mm ²]	1.5 - 2.5	1.5 - 2.5	1.5 - 2.5

Description	Color
Terminal block	gray blue
Ground terminal	green-yellow

Ordering data		
Type	Order No.	Pcs./Pkt.
UKH 70/4X10	3213142	10
UKH 70/4X10 BU	3213143	10

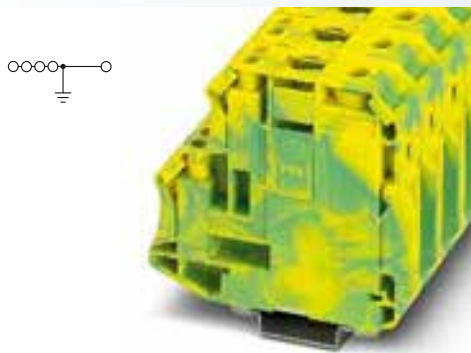

Technical data

Width	Length	Height NS 35/7,5	
20.3	88.5	80	
Width	Length	Height NS 35/15	
20.3	88.5	87.5	
Width	Length	Height NS 32	
20.3	88.5	85	
		max. Ø [mm ²]	AWG (UL)
		16 - 95	-
IEC 60947-7-2			
IEC	UL	CSA	IEC/ EN 60079-7
-	-	-	-
- / 70	- / -	- / -	-
70	-	-	-
4 - 3/0	-	-	-
Rigid	Flexible	Ferrule	
		without/with plastic sleeve	
16 - 95	25 - 70	16 - 70	16 - 70
-	-	-	-
Rigid	Flexible	Ferrule	
		without/with plastic sleeve	
1.5 - 16	1.5 - 10	1.5 - 10	1.5 - 6
-	-	-	-

Ordering data

Type	Order No.	Pcs./Pkt.
UKH 70/4X10-PE	3213144	10

Terminal blocks – CLIPLINE complete

95 mm² UKH screw connection terminal blocks

General technical data

Rated data		IEC 60947-7-1 / IEC 60947-7-2			
Rated cross section	[mm ²]	95			
Cross section range	AWG	4 - 3/0			
Connection capacity		Rigid	Flexible	Ferrule without/with plastic sleeve	
1 conductor	[mm ²]	25 - 95	35 - 95	35 - 95	35 - 95
2 conductors (of the same type)	[mm ²]	25 - 35	25 - 35	16 - 35	-
2 flexible conductors with a TWIN ferrule	[mm ²]	-	-	-	-
Max. cross section with insertion bridge	[mm ²]	95	70	-	-
General data					
Stripping length	[mm]	33			
Screw thread		M8			
Tightening torque	[Nm]	15 - 20			
Insulating material		PA			
Flammability rating in accordance with UL 94		V0			

Note: Additional or deviating data is listed alongside the respective product.

Notes:



In addition to the product, the internal electrical wiring is provided as a circuit diagram. Free connection points for bridging are indicated by a black dot.

The specified technical data and approvals refer to the first product in each column. For information on the products below, please refer to phoenixcontact.net/products

For full details of UL and CSA use groups, file nos., and Internet links, please visit phoenixcontact.net/products

¹⁾ The bridge current is listed alongside the respective product. For additional colors, see page 402.

System accessories

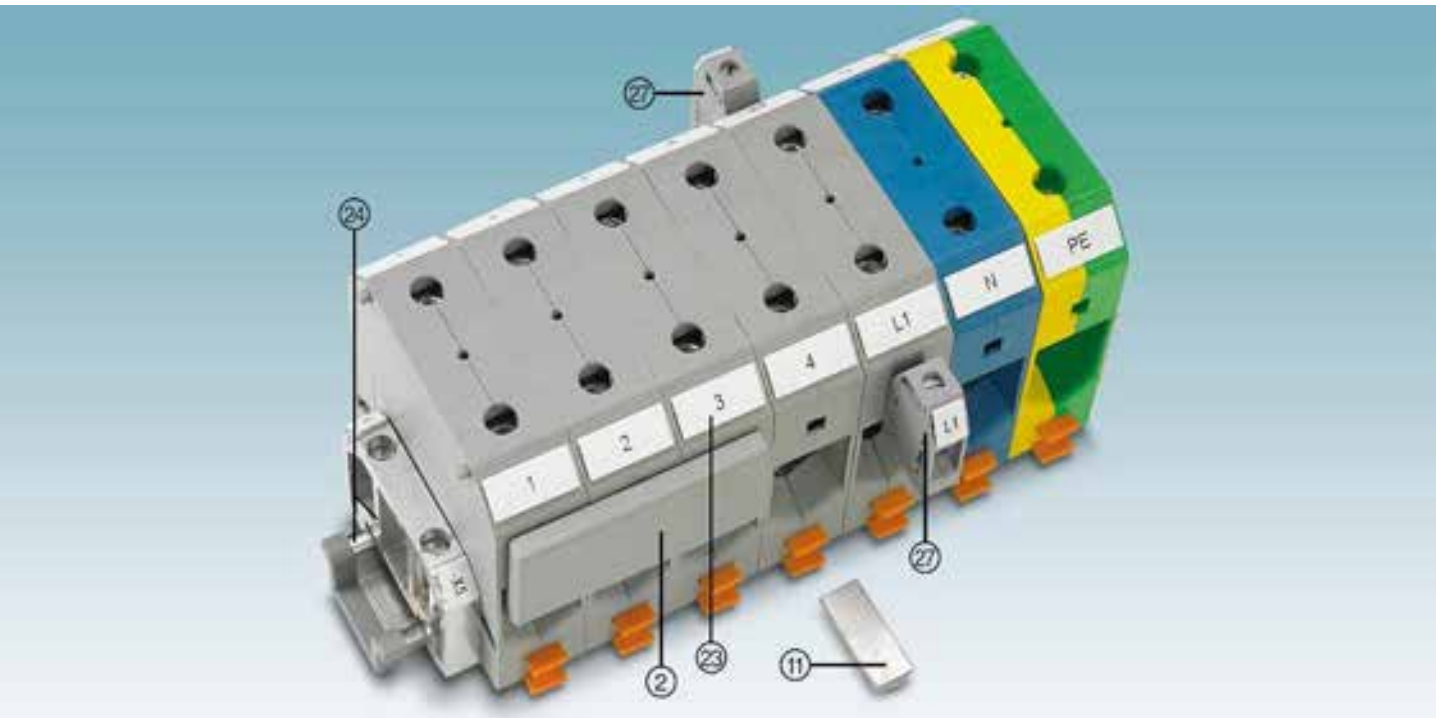

Description	No. of pos.	Color	Type	Order No.	Pcs./Pkt.	Type	Order No.	Pcs./Pkt.
② Insertion bridge ¹⁾	2	gray	EB 2-25/UKH	0201362	10			
	3	gray	EB 3-25/UKH	0201375	10			
		silver	UKH 95 EP	3009231	10			
⑪ Insertion profile for flat conductor connection, see page 682								
⑳ Tap-off terminal block		gray	AGK 10-UKH 95	3003541	10			
Allen key			SF-THEX 6-200	1212642	5			

㉔ Lateral groove labeling

㉕ DIN rail and end bracket

For full accessories, visit phoenixcontact.net/products

UC-TM 10, UCT-TM 10 or ZB 10. See also Catalog 3, selection tables, from page 60.

See Catalog 3

Note: Additional or deviating accessories are listed alongside the respective product.

High-current terminal blocks

Notes:

¹⁾ For additional accessories and technical data, see page 194.

For information on installation and using accessories for Ex applications, see page 678.

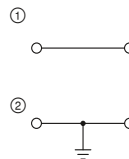

232 A, feed-through terminal block



Ex: EAC Ex IEC 60074
KEMA 98ATEX1786U / IECEX KEM 06.0029U

Technical data¹⁾

Dimensions	Width	Length	Height	
	25	83	97.5 (NS 35/15) / 95 (NS 32)	
Maximum electrical data	I_{max} [A]	U_{max} [V]	max. Ø [mm ²]	AWG (UL)
	232	1000	25 - 95	2
Maximum bridge current	[A]			
	232			
Rated data	IEC	UL / CUL	CSA	Ex
Rated voltage	1000	600	600	880
Nominal current / cross section	[A] / [mm ²]	232 / 95	230 / -	200 / - 216 / 95

Ordering data

Description	Color	Type	Order No.	Pcs./Pkt.
Terminal block	gray	UKH 95	① 3010013	3
	blue	UKH 95 BU	① 3010136	3
Terminal block, voltage 1500 V	gray	UKH 95 1500V	① 3247419	3
	blue	UKH 95 1500V BU	① 3247420	3
Ground terminal	green-yellow	USLKG 95	② 0441041	10

High-current terminal blocks for direct mounting

Notes:

¹⁾ For additional accessories and technical data, see page 194.



232 A, feed-through terminal block for direct mounting

Technical data¹⁾

Dimensions	Width	Length	Height	
	25	118.8	90	
Maximum electrical data	I_{max} [A]	U_{max} [V]	max. Ø [mm ²]	AWG (UL)
	232	1000	25 - 95	2
Maximum bridge current	[A]			
	232			
Rated data	IEC	UL / CUL	CSA	Ex
Rated voltage	1000	600	-	-
Nominal current / cross section	[A] / [mm ²]	232 / 95	- / -	- / -

Ordering data

Description	Color	Type	Order No.	Pcs./Pkt.
Terminal block, for direct mounting	gray	UKH 95-F	① 3247022	10

Terminal blocks – CLIPLINE complete

150 mm² UKH screw connection terminal blocks

General technical data

Rated data		IEC 60947-7-1			
Rated cross section	[mm ²]	150			
Cross section range	AWG	2 - 300 kcmil			
Connection capacity		Rigid	Flexible	Ferrule without/with plastic sleeve	
1 conductor	[mm ²]	35 - 150	50 - 150	50 - 150	50 - 150
2 conductors (of the same type)	[mm ²]	25 - 50	35 - 50	25 - 50	-
2 flexible conductors with a TWIN ferrule	[mm ²]	-	-	-	-
Max. cross section with insertion bridge	[mm ²]	150	120	-	-
General data					
Stripping length	[mm]	40			
Screw thread		M10			
Tightening torque	[Nm]	25 - 30			
Insulating material		PA			
Flammability rating in accordance with UL 94		V0			

Note: Additional or deviating data is listed alongside the respective product.

Notes:



In addition to the product, the internal electrical wiring is provided as a circuit diagram. Free connection points for bridging are indicated by a black dot.

The specified technical data and approvals refer to the first product in each column. For information on the products below, please refer to phoenixcontact.net/products

For full details of UL and CSA use groups, file nos., and Internet links, please visit phoenixcontact.net/products

¹⁾ The bridge current is listed alongside the respective product. For additional colors, see page 402.

System accessories

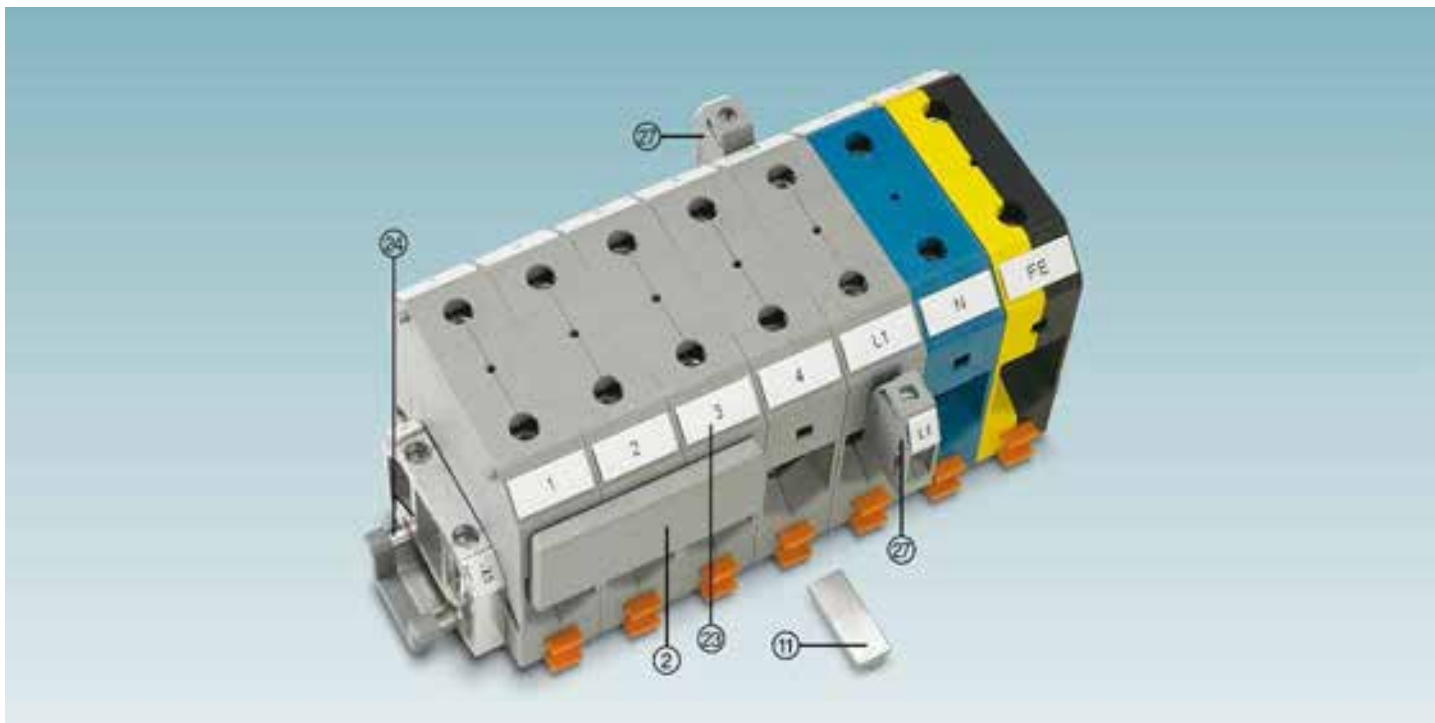

Description	No. of pos.	Color	Type	Order No.	Pcs./Pkt.	Type	Order No.	Pcs./Pkt.
② Insertion bridge ¹⁾	2	gray	EB 2-31/UKH	0201388	10			
	3	gray	EB 3-31/UKH	0201391	10			
①① Insertion profile for flat conductor connection, see page 682		silver	UKH 150/240 EP	3009244	10			
②⑦ Tap-off terminal block		gray	AGK 10-UKH 150/240	3003554	10			
Allen key			SF-THEX 8-200	1212643	5			

②④ Lateral groove labeling
②④ DIN rail and end bracket
For full accessories, visit phoenixcontact.net/products

UC-TM 10, UCT-TM 10 or ZB 10. See also Catalog 3, selection tables, from page 60.
See Catalog 3
Note: Additional or deviating accessories are listed alongside the respective product.

High-current terminal blocks

Notes:

¹⁾ For additional accessories and technical data, see page 196.

For information on installation and using accessories for Ex applications, see page 678.

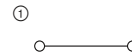

309 A, feed-through terminal block



Ex: EAC Ex IEC KEMA 99ATEX8332 U / IECEx KEM 06.0030U

Technical data¹⁾

Dimensions	[mm]
Maximum electrical data	
Maximum bridge current	[A]
Rated data	
Rated voltage	[V]
Nominal current / cross section	[A] / [mm ²]

Width	Length	Height	
31	100	118.5 (NS 35/15) / 116 (NS 32)	
I_{max} [A]	U_{max} [V]	max. Ø [mm ²]	AWG (UL)
309	1000	35 - 150	2-300
232			
IEC	UL / CUL	CSA	Ex
1000	600	600	1100
309 / 150	285 / -	275 / -	256 / 150

Ordering data

Description	Color
Terminal block	gray blue
Terminal block, voltage 1500 V	gray blue

Type	Order No.	Pcs./Pkt.
UKH 150	3010110	3
UKH 150 BU	3010123	3
UKH 150 1500V	3247433	3
UKH 150 1500V BU	3247434	3

High-current terminal blocks for direct mounting

Notes:

¹⁾ For additional accessories and technical data, see page 196.

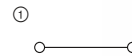

309 A, feed-through terminal block for direct mounting



Technical data¹⁾

Dimensions	[mm]
Maximum electrical data	
Maximum bridge current	[A]
Rated data	
Rated voltage	[V]
Nominal current / cross section	[A] / [mm ²]

Width	Length	Height	
31	136.1	111	
I_{max} [A]	U_{max} [V]	max. Ø [mm ²]	AWG (UL)
309	1000	35 - 150	2-300
232			
IEC	UL / CUL	CSA	Ex
1000	600	-	-
309 / 150	285 / -	- / -	- / -

Ordering data

Description	Color
Terminal block, for direct mounting	gray

Type	Order No.	Pcs./Pkt.
UKH 150-F	3247035	10

Terminal blocks – CLIPLINE complete

240 mm² UKH screw connection terminal blocks

General technical data

Rated data		IEC 60947-7-1
Rated cross section	[mm ²]	240
Cross section range	AWG	2/0 - 500 kcmil
Connection capacity		Rigid Flexible Ferrule without/with plastic sleeve
1 conductor	[mm ²]	70 - 240 70 - 240 70 - 185 70 - 185
2 conductors (of the same type)	[mm ²]	35 - 95 50 - 95 35 - 50 -
2 flexible conductors with a TWIN ferrule	[mm ²]	- - - -
Max. cross section with insertion bridge	[mm ²]	240 185 - -
General data		
Stripping length	[mm]	40
Screw thread		M10
Tightening torque	[Nm]	25 - 30
Insulating material		PA
Flammability rating in accordance with UL 94		V0

Note: Additional or deviating data is listed alongside the respective product.

Notes:



In addition to the product, the internal electrical wiring is provided as a circuit diagram. Free connection points for bridging are indicated by a black dot.

The specified technical data and approvals refer to the first product in each column. For information on the products below, please refer to phoenixcontact.net/products

For full details of UL and CSA use groups, file nos., and Internet links, please visit phoenixcontact.net/products

¹⁾ The bridge current is listed alongside the respective product. For additional colors, see page 402.

System accessories

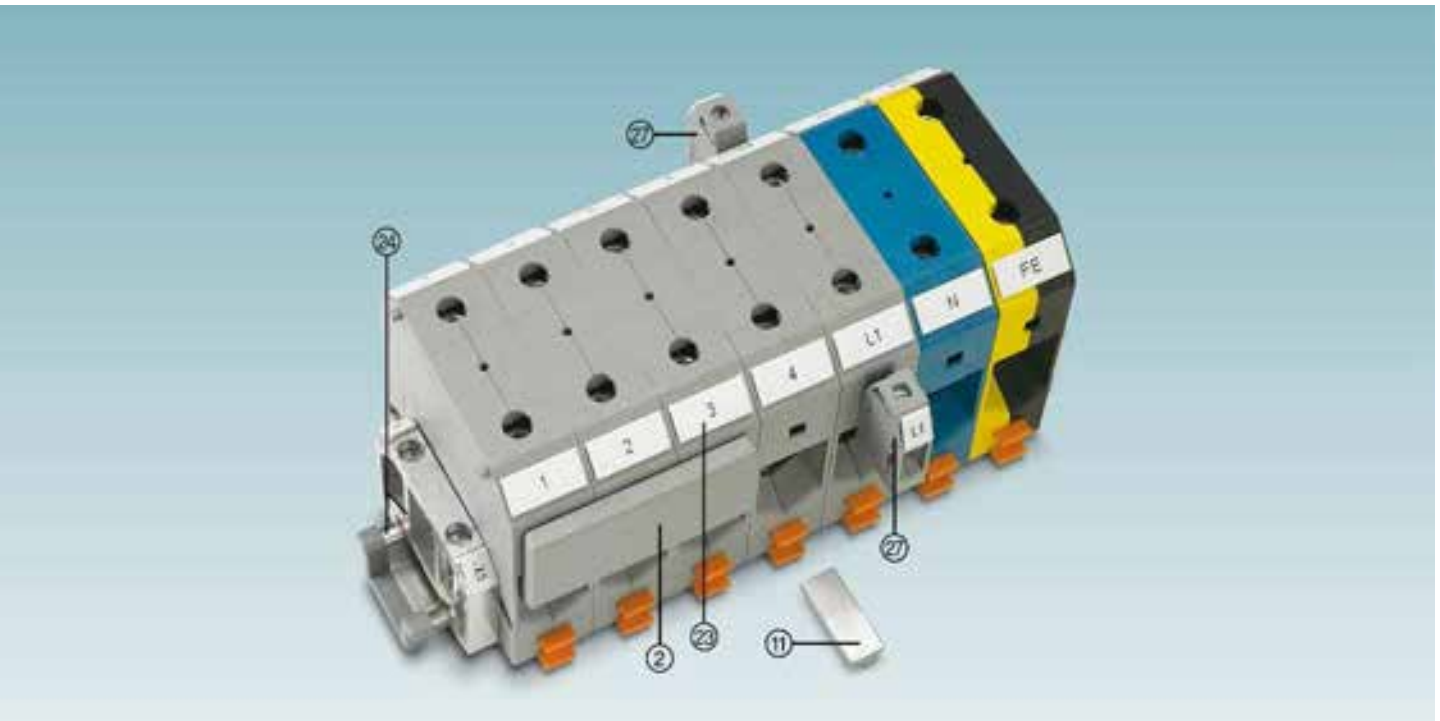

Description	No. of pos.	Color	Type	Order No.	Pcs./Pkt.	Type	Order No.	Pcs./Pkt.
② Insertion bridge ¹⁾	2	gray	EB 2-36/UKH	0201401	10			
	3	gray	EB 3-36/UKH	0201414	10			
⑪ Insertion profile for flat conductor connection, see page 682		silver	UKH 150/240 EP	3009244	10			
⑲ Tap-off terminal block		gray	AGK 10-UKH 150/240	3003554	10			
Allen key			SF-THEX 8-200	1212643	5			
⑳ Lateral groove labeling			UC-TM 10, UCT-TM 10 or ZB 10. See also Catalog 3, selection tables, from page 60.					
㉑ DIN rail and end bracket			See Catalog 3					
For full accessories, visit phoenixcontact.net/products			Note: Additional or deviating accessories are listed alongside the respective product.					

High-current terminal blocks

Notes:

¹⁾ For additional accessories and technical data, see page 198.

For information on installation and using accessories for Ex applications, see page 678.

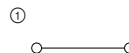

415 A, feed-through terminal block



Ex: EAC Ex IEC KEMA 99ATEX8332 U / IECEx KEM 06.0030U

Technical data¹⁾

Dimensions	Width	Length	Height	
	36	100	131.5 (NS 35/15) / 129 (NS 32)	
Maximum electrical data	I_{max} [A]	U_{max} [V]	max. Ø [mm ²]	AWG (UL)
	415	1000	70 - 240	500
Maximum bridge current	382			
Rated data	IEC	UL / CUL	CSA	Ex
Rated voltage	1000	600	600	1100
Nominal current / cross section	415 / 240	380 / -	400 / -	350 / 240

Ordering data

Description	Color	Type	Order No.	Pcs./Pkt.
Terminal block	gray	UKH 240	3010217	3
	blue	UKH 240 BU	0711852	3

High-current terminal blocks for direct mounting

Notes:

¹⁾ For additional accessories and technical data, see page 198.



415 A, feed-through terminal block for direct mounting



Technical data¹⁾

Dimensions	Width	Length	Height	
	36	136.1	124	
Maximum electrical data	I_{max} [A]	U_{max} [V]	max. Ø [mm ²]	AWG (UL)
	415	1000	70 - 240	500
Maximum bridge current	382			
Rated data	IEC	UL / CUL	CSA	Ex
Rated voltage	1000	600	-	-
Nominal current / cross section	415 / 240	380 / -	- / -	- / -

Ordering data

Description	Color	Type	Order No.	Pcs./Pkt.
Terminal block, for direct mounting	gray	UKH 240-F	3247048	10



ST spring-cage connection terminal blocks

The ST spring-cage connection terminal blocks from the CLIPLINE complete system have been developed for universal spring-loaded conductor contacting. The high contact force guarantees a vibration-proof, gas-tight connection with long-term stability.

The compact front connection ensures easy operation. The terminal point is opened using a standard screwdriver. After the conductor has been inserted into the clamping space, the screwdriver is removed and the conductor automatically makes contact.

All types of copper wires up to 35 mm² can be clamped without any pretreatment.

Spring-cage connection terminal blocks offer a large insertion space, which means that conductors with a nominal cross section can be wired both with and without ferrules.

 Your web code: [#1396](#)

Product range overview

1.5 mm²

Feed-through, multi-conductor, multi-level, and ground terminal blocks 207

2.5 mm²

Feed-through, multi-conductor, multi-level, and ground terminal blocks 211

Initiator/actuator terminal blocks 214

Disconnect and knife disconnect terminal blocks 216

Diode terminal blocks 218

Hybrid terminal blocks with screw connection on one side 220

Desk-design terminal blocks 221

Desk-design disconnect and knife disconnect terminal blocks 222

Mini terminal blocks 222

4 mm²

Feed-through, multi-conductor, multi-level, and ground terminal blocks 229

Fuse terminal blocks and lever-type disconnect terminal blocks of the same shape 231

Disconnect and knife disconnect terminal blocks 232

Diode terminal blocks 232

Hybrid terminal blocks with screw connection on one side 233

Desk-design terminal blocks 233

Desk-design disconnect and knife disconnect terminal blocks 235

6 mm²

Feed-through, multi-conductor, and ground terminal blocks 237

Test disconnect terminal blocks 237

Diode terminal blocks 239

Desk-design terminal blocks 239

10 mm²

Feed-through, multi-conductor, and ground terminal blocks 243

Hybrid terminal blocks with screw connection on one side 244

16 mm²

Feed-through, multi-conductor, and ground terminal blocks 247

35 mm²

Feed-through and ground terminal blocks 249

Hybrid terminal blocks with screw connection on one side 249

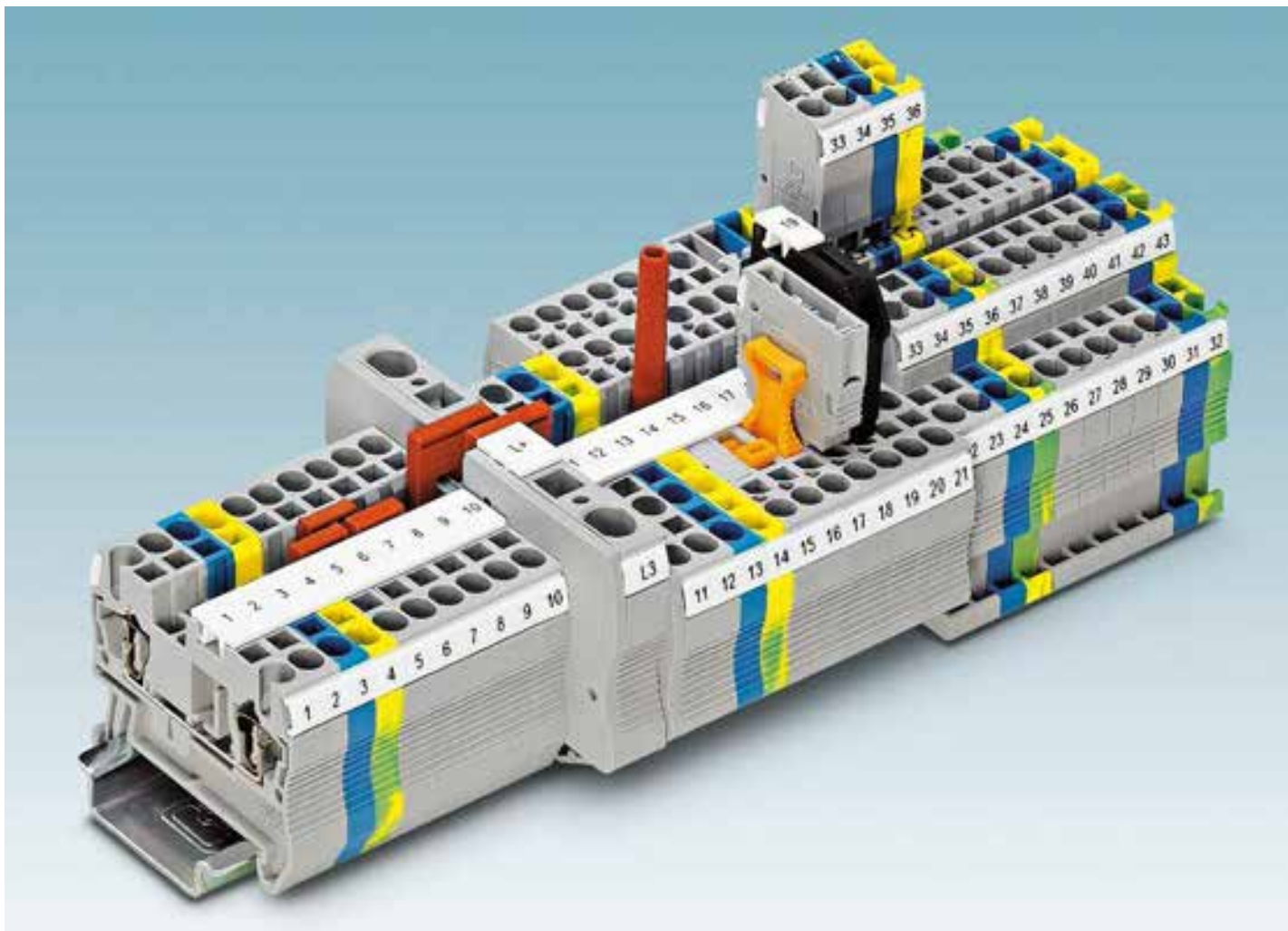

i Your web code: [#1396](#)



Space-saving design

Thanks to the space-saving design and conductor insertion from above, ST spring-cage terminal blocks are ideal for control systems where limited space is available.



Maximum connection space

Thanks to their maximum wiring space, miniature spring-cage terminal blocks offer a quick means of wiring rigid and flexible conductors, even for conductors with the nominal cross section and pre-assembled ferrule.



Large-surface labeling

Large and clear marking of the terminal points is essential for reliable and quick installation. In addition to this, each terminal point can be labeled separately.

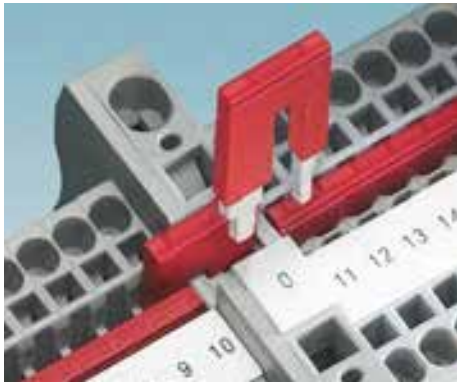

The reducing bridge allows terminal blocks with different nominal cross sections to be connected easily. The reducing bridge can be used to quickly create power blocks, e.g., an ST 10 spring-cage terminal block with an ST 2.5 or ST 4.

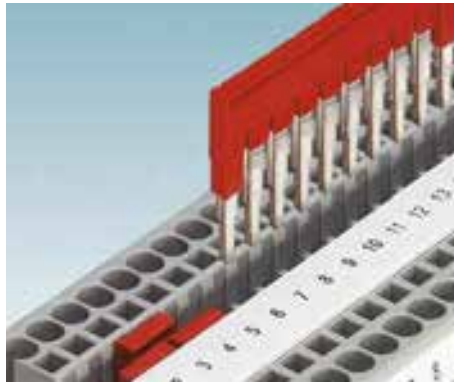

The double function shaft can be used to connect any number of terminal blocks with two-position bridges. The 2- to 50-pos. bridges allow up to 50 terminal blocks to be bridged in one step.

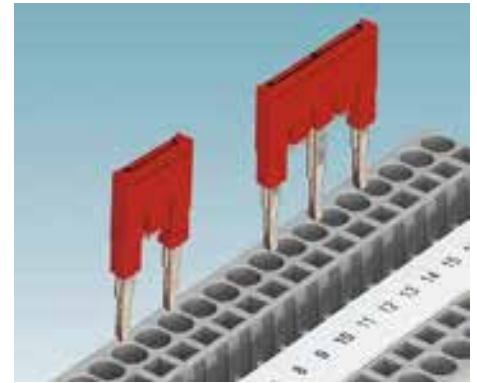

Bridging between non-adjacent terminal blocks is established by removing individual contact tabs from the standard bridge. Two potentials can then be routed in parallel through a terminal strip. The contact points can also be marked.

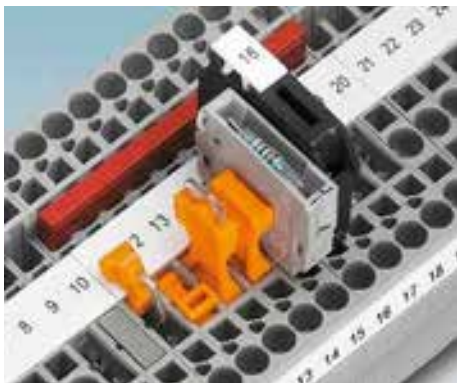

The isolated feed-through connector P-FIX, isolating connector P-DI, component connector P-CO and the cartridge fuse connector P-FU can be used in the universal plug-in zone of the disconnect terminal block.

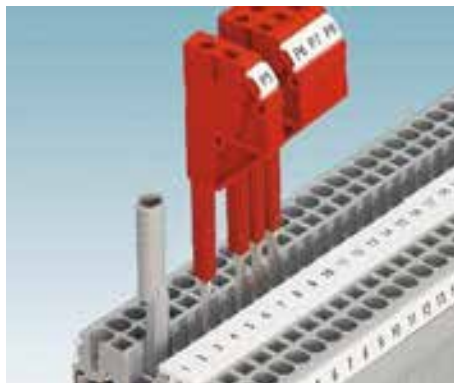

For measuring lines, a test plug with 2.3 mm diameter is available. All measurement and testing tasks can be carried out quickly using test adapters for 4 mm diameter test plugs and the alignable test plugs.

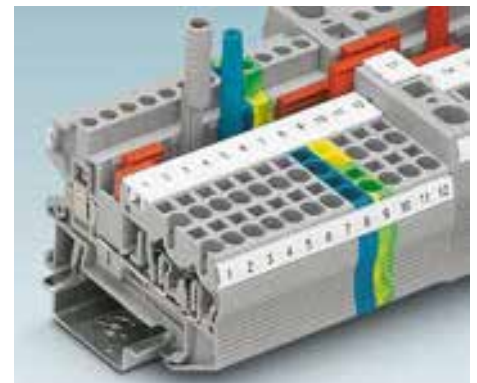

The hybrid versions combine the benefits of the spring-cage connection method with those of the universal screw connection.



The partition plates protrude beyond the terminal block contours. They provide visual as well as electrical group separation.



Cover segments are used to cover protruding terminal block segments of three- or four-conductor terminal blocks, when adding two-conductor terminal blocks. Fingers are thereby protected from contact.



ST-COMBI terminal blocks are available for creating plug-in signal and power wiring. The system is of a touch-proof design and offers plugs for self-assembly with extensive accessories. See "COMBI" section, page 267.

Terminal blocks – CLIPLINE complete

ST spring-cage connection terminal blocks

ST ... feed-through, multi-conductor, and multi-level terminal blocks



- Convenient operation, thanks to front connection
- Space saving, thanks to the compact design
- Optimum overview, thanks to large marking areas

i Your web code: #0061

STIO ... three-conductor initiator/ actuator terminal blocks



- A wide range of products, thanks to versions with PE function or LED display
- Optimum overview of signal connections, thanks to a variety of marking options
- Modular expansion up to a maximum of 50 positions, as power terminals are the same shape
- Power fed-in or power-line extended via terminals
- Potential supply via the STIO-IN power terminals

i Your web code: #0062

ST ... disconnect and knife disconnect terminal blocks



- Convenient separation of circuits using lever-type disconnect knife, isolating plug or rotary contact
- User-friendly current measurement, thanks to testing facility either side of the disconnect point
- Safe operation as the disconnect lever is locked in the end positions
- Individual assembly with disconnect element, fuse plug, component connector, and feed-through connector

i Your web code: #0063

MSB ... miniature terminal blocks

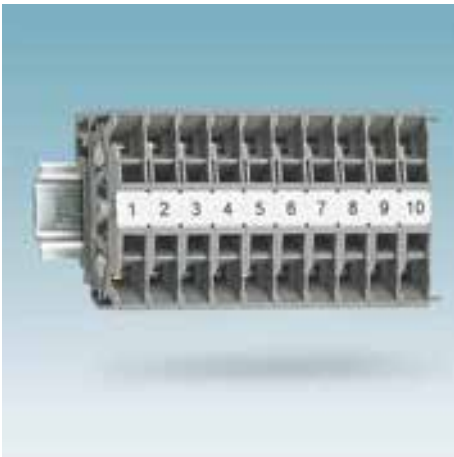

- Space saving, thanks to compact design and mounting option on a 15 mm DIN rail
- Horizontal connection for particularly flat inserts
- Vertical connection in confined spaces
- Clear, as all terminal points are marked

i Your web code: #0067

STME ... test disconnect terminal blocks

- Easy and safe operation, thanks to clear indication of switching states
- Maximum functionality, up to six universal function shafts for potential distribution or for test purposes
- Modular expansion, thanks to feed-through terminal blocks and ground terminals of the same shape
- Modular design of transformer circuits, thanks to plug-in test disconnect terminal blocks

i Your web code: **#0064**

STU ... hybrid terminal blocks

- Meet requirements for internal and external wiring at the same time as different connection methods are integrated in a single terminal block
- Free choice of connection technology, thanks to two combination options
- Space saving, thanks to the compact design
- Uniform distances from cable ducts
- Feed-through and ground terminal blocks of the same shape

i Your web code: **#0065**

STS ... desk-design terminal blocks

- Angled design enables minimized bending radii for better conductor routing
- Designed for use on wiring frames instead of typical channel wiring
- Two, three, and four-conductor terminal blocks with the same contour
- Universal disconnect zone for also accommodating isolating plugs, feed-through connectors, component connectors, and fuse plugs

i Your web code: **#0061**

Terminal blocks – CLIPLINE complete

1.5 mm² ST spring-cage connection terminal blocks

General technical data

Rated data		IEC 60947-7-1 / IEC 60947-7-2			
Rated cross section	[mm ²]	1.5			
Cross section range	AWG	28 - 16			
Connection capacity		Rigid	Flexible	Ferrule without/with plastic sleeve	
1 conductor	[mm ²]	0.08 - 1.5	0.08 - 1.5	0.14 - 1.5	0.14 - 1.5
2 flexible conductors with a TWIN ferrule	[mm ²]	-	-	-	0.5
General data					
Stripping length	[mm]	8 - 10			
Insulating material		PA			
Flammability rating in accordance with UL 94		VO			
Note: Additional or deviating data is listed alongside the respective product.					

Notes:



In addition to the product, the internal electrical wiring is provided as a circuit diagram. Free connection points for bridging are indicated by a black dot.

The specified technical data and approvals refer to the first product in each column. For information on the products below, please refer to phoenixcontact.net/products

For full details of UL and CSA use groups, file nos., and Internet links, please visit phoenixcontact.net/products

¹⁾ The bridge current is listed alongside the respective product. For additional colors, see page 402.

System accessories

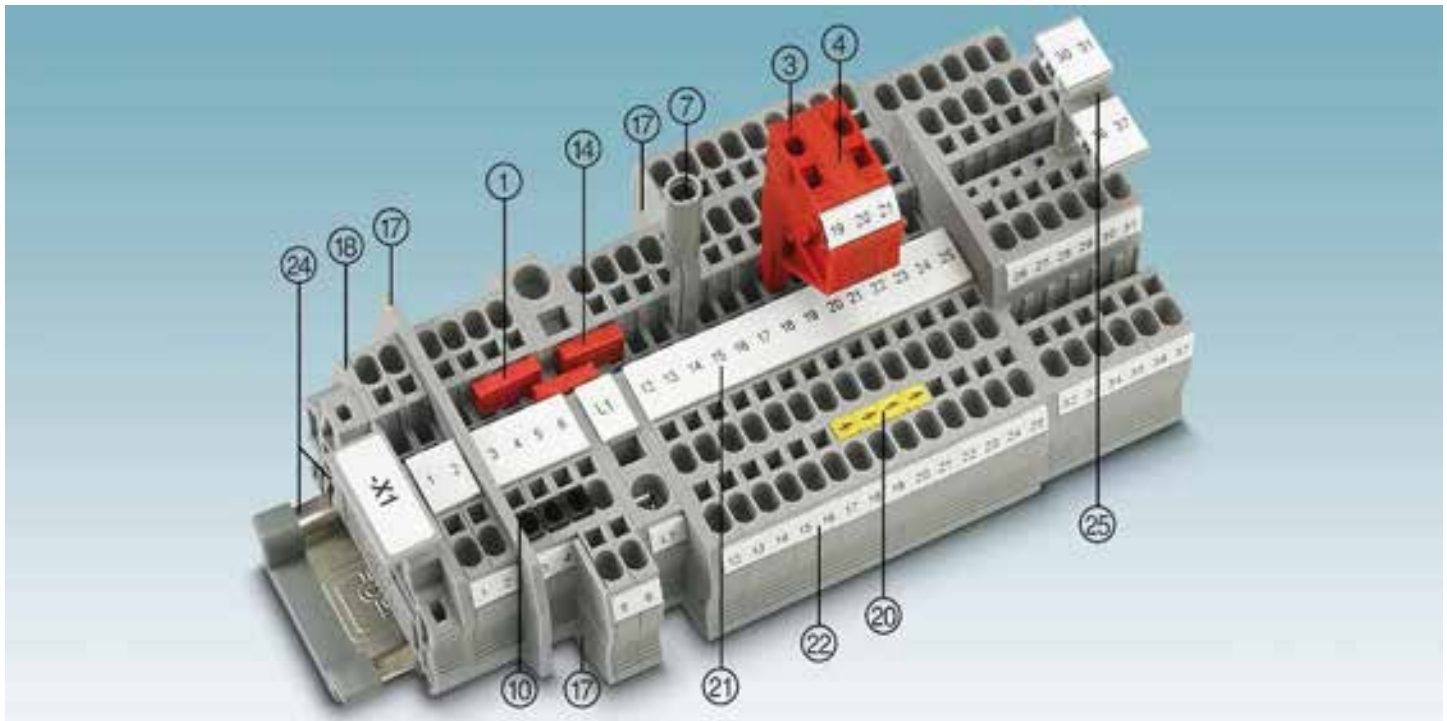

Description	No. of pos.	Color	Type	Order No.	Pcs./Pkt.	Type	Order No.	Pcs./Pkt.
① Bridge ¹⁾	2	red	FBS 2-4	3030116	50			
	3	red	FBS 3-4	3030129	50			
	4	red	FBS 4-4	3030132	50			
	5	red	FBS 5-4	3030145	50			
	10	red	FBS 10-4	3030158	10			
	20	red	FBS 20-4	3030352	10			
③ Modular test plug		red	PS-4	3030970	10			
④ Spacer plate		red	DP PS-4	3036712	10			
⑦ Test adapter, 4 mm socket hole		gray	PAI-4-N GY	3032871	10			
⑩ Insulating sleeve 0.25 - 0.5 mm ²		white	ISH 1,5/0,2	3206131	50			
		gray	ISH 1,5/0,5	3031034	50			
Screwdriver			SZF 0-0,4X2,5	1204504	10			

⑭ Reducing bridge	For RB ..., see page 408.
⑰ Partition plates/end cover segments	For ATP-... / DS-..., visit phoenixcontact.net/products
⑱ Cover	Listed alongside the respective product.
⑳ Warning labels	For WS ..., see page 420.
㉑ Center groove labeling	UC-TM 4, UCT-TM 4 or ZB 4. See also Catalog 3, selection tables from page 60.
㉒ Center and side groove labeling	UC-TMF 4, UCT-TMF 4 or ZBF 4. See also Catalog 3, selection tables from page 60.
㉓ DIN rail and end bracket	See Catalog 3
㉔ Marker carrier	For STP ..., see page 418.
For full accessories, visit phoenixcontact.net/products	Note: Additional or deviating accessories are listed alongside the respective product.

1.5 mm² ST spring-cage connection terminal blocks

Feed-through, multi-conductor, multi-level, and ground terminal blocks

Notes:
 1) For additional accessories and technical data, see page 206.
 For information on installation and using accessories for Ex applications, see page 678.

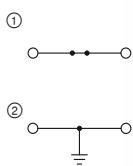

17.5 A, feed-through terminal block



Ex: EAC Ex IEC Ex
 KEMA 01ATEX2129 U / IECEx KEM 06.0043U

Technical data¹⁾

Width	Length	Height		
4.2	48.5	36.5 (NS 35/7,5)		
I _{max} [A]	U _{max} [V]	max. Ø [mm ²]	AWG (UL)	
17.5	500	0.08 - 1.5	26-14	
Maximum bridge current [A]				
17.5				
Rated data				
IEC	UL / CUL	CSA	Ex	
500	300	300	440	
Nominal current / cross section [A] / [mm ²]				
17.5 / 1.5 15 / - 15 / - 17.5 / 1.5				

Ordering data

Type	Order No.	Pcs./Pkt.
ST 1,5	3031076	50
ST 1,5 BU	3031089	50
ST 1,5-PE	3031513	50

Accessories¹⁾

D-ST 2,5	Order No.	Pcs./Pkt.
D-ST 2,5	3030417	50

Dimensions	[mm]
Width	4.2
Length	48.5
Height	36.5 (NS 35/7,5)
Maximum electrical data	
I _{max} [A]	17.5
U _{max} [V]	500
Maximum bridge current [A]	17.5
Rated data	
Rated voltage [V]	500
Nominal current / cross section [A] / [mm ²]	17.5 / 1.5

Description	Color
Terminal block	gray blue
Ground terminal	green-yellow

Cover, width: 2.2 mm	Color
Cover, width: 2.2 mm	gray

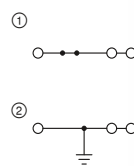

17.5 A, feed-through terminal block, 3 connections



Ex: EAC Ex IEC Ex
 KEMA 01ATEX2129 U / IECEx KEM 06.0043U

Technical data¹⁾

Width	Length	Height		
4.2	60.5	36.5 (NS 35/7,5)		
I _{max} [A]	U _{max} [V]	max. Ø [mm ²]	AWG (UL)	
17.5	500	0.08 - 1.5	26-14	
Maximum bridge current [A]				
17.5				
Rated data				
IEC	UL / CUL	CSA	Ex	
500	300	300	440	
Nominal current / cross section [A] / [mm ²]				
17.5 / 1.5 15 / - 15 / - 17.5 / 1.5				

Ordering data

Type	Order No.	Pcs./Pkt.
ST 1,5-TWIN	3031128	50
ST 1,5-TWIN BU	3031131	50
ST 1,5-TWIN-PE	3031144	50

Accessories¹⁾

D-ST 2,5-TWIN	Order No.	Pcs./Pkt.
D-ST 2,5-TWIN	3030488	50

Feed-through, multi-conductor, multi-level, and ground terminal blocks

Notes:
 1) For additional accessories and technical data, see page 206.
 For information on installation and using accessories for Ex applications, see page 678.

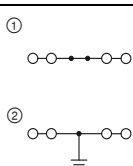

17.5 A, feed-through terminal block, 4 connections



Ex: EAC Ex IEC Ex
 KEMA 01ATEX2129 U / IECEx KEM 06.0043U

Technical data¹⁾

Width	Length	Height		
4.2	72	36.5 (NS 35/7,5)		
I _{max} [A]	U _{max} [V]	max. Ø [mm ²]	AWG (UL)	
17.5	500	0.08 - 1.5	26-14	
Maximum bridge current [A]				
17.5				
Rated data				
IEC	UL / CUL	CSA	Ex	
500	300	300	440	
Nominal current / cross section [A] / [mm ²]				
17.5 / 1.5 15 / - 15 / - 17.5 / 1.5				
General data				
Stripping length [mm]	8 - 10			

Ordering data

Type	Order No.	Pcs./Pkt.
ST 1,5-QUATTRO	3031186	50
ST 1,5-QUATTRO BU	3031199	50
ST 1,5-QUATTRO-PE	3031209	50

Accessories¹⁾

D-ST 2,5-QUATTRO	Order No.	Pcs./Pkt.
D-ST 2,5-QUATTRO	3030514	50

Dimensions	[mm]
Width	4.2
Length	72
Height	36.5 (NS 35/7,5)
Maximum electrical data	
I _{max} [A]	17.5
U _{max} [V]	500
Maximum bridge current [A]	17.5
Rated data	
Rated voltage [V]	500
Nominal current / cross section [A] / [mm ²]	17.5 / 1.5
General data	
Stripping length [mm]	8 - 10

Description	Color
Terminal block	gray gray blue
Ground terminal	green-yellow

Cover, width: 2.2 mm	Color
Cover, width: 2.2 mm	gray

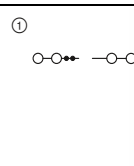

17.5 A, feed-through terminal block, 4 connections, with interrupted current bar



Technical data¹⁾

Width	Length	Height		
4.2	72	36.5 (NS 35/7,5)		
I _{max} [A]	U _{max} [V]	max. Ø [mm ²]	AWG (UL)	
17.5	500	0.08 - 1.5	26-14	
Maximum bridge current [A]				
17.5				
Rated data				
IEC	UL / CUL	CSA	Ex	
500	300	-	-	
Nominal current / cross section [A] / [mm ²]				
17.5 / 1.5 15 / - - / - - / -				
General data				
Stripping length [mm]	10			

Ordering data

Type	Order No.	Pcs./Pkt.
ST 1,5-QUATTRO-U	3038600	50

Accessories¹⁾

D-ST 2,5-QUATTRO	Order No.	Pcs./Pkt.
D-ST 2,5-QUATTRO	3030514	50

Terminal blocks – CLIPLINE complete

1.5 mm² ST spring-cage connection terminal blocks

Feed-through, multi-conductor, multi-level, and ground terminal blocks

Notes:
1) For additional accessories and technical data, see page 206.
ISH... insulating sleeves and PS ... and PAI ... test accessories cannot be used with the ST 1,5/S-QUATTRO.
For 1 mm ² conductors with ferrule and plastic sleeve, using the AI-S 1-8 TQ ferrule is recommended, Order No. 1200293.
For information on installation and using accessories for Ex applications, see page 678.

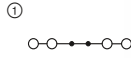

17.5 A, feed-through terminal block, 4 connections

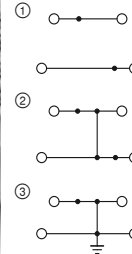

17.5 A, double-level terminal block

Dimensions	
	[mm]
Maximum electrical data	
Maximum bridge current	[A]
Rated data	
Rated voltage	[V]
Nominal current / cross section	[A] / [mm ²]
Connection capacity	
1 conductor	[mm ²]
2 flexible conductors with a TWIN ferrule	[mm ²]
General data	
Stripping length	[mm]



Technical data ¹⁾				
Width	Length	Height		
3.5	72	32 (NS 35/7,5)		
<i>I</i> _{max.} [A]	<i>U</i> _{max.} [V]	max. Ø [mm ²]	AWG (UL)	
17.5	500	0.08 - 1.5	28-16	
17.5				
IEC	UL / CUL	CSA	Ex	
500	600	600	-	
Nominal current / cross section				
17.5 / 1.5	10 / -	10 / -	- / -	
Connection capacity	Rigid	Flexible	Ferrule without/with plastic sleeve	
1 conductor	0.08 - 1.5	0.08 - 1.5	0.14 - 1.5	0.14 - 1
2 flexible conductors with a TWIN ferrule	-	-	-	-
General data	8			
Stripping length	[mm]			

Ex: EAC Ex IEC KEMA 01ATEX2129 U / IECEx KEM 06.0043U

Technical data ¹⁾				
Width	Length	Height		
4.2	67.5	47.5 (NS 35/7,5)		
<i>I</i> _{max.} [A]	<i>U</i> _{max.} [V]	max. Ø [mm ²]	AWG (UL)	
17.5	500	0.08 - 1.5	26-14	
15				
IEC	UL / CUL	CSA	Ex	
500	300	300	440	
Nominal current / cross section				
17.5 / 1.5	15 / -	15 / -	17.5 / 1.5	
Connection capacity	Rigid	Flexible	Ferrule without/with plastic sleeve	
1 conductor	0.08 - 1.5	0.08 - 1.5	0.14 - 1.5	0.14 - 1.5
2 flexible conductors with a TWIN ferrule	-	-	-	0.5
General data	10			
Stripping length	[mm]			

Description	No. of pos.	Color
Terminal block		gray
With potential distribution		blue
Ground terminal		gray
		green-yellow

Ordering data			
Type	Order No.	Pcs./Pkt.	
ST 1,5/S-QUATTRO	3213124	50	①

Ordering data			
Type	Order No.	Pcs./Pkt.	
STTB 1,5	3031157	50	①
STTB 1,5 BU	3031160	50	①
STTB 1,5-PV	3031526	50	②
STTB 1,5-PE	3036013	50	③

Cover, width: 2.2 mm		gray
Plug-in bridge		
	2	red
	3	red
	4	red
	5	red
	10	red

Accessories ¹⁾			
D-ST 1,5/S-QUATTRO	Order No.	Pcs./Pkt.	
D-ST 1,5/S-QUATTRO	3213166	50	
FBS 2-3,5	3213014	50	17.5 A
FBS 3-3,5	3213027	50	17.5 A
FBS 4-3,5	3213030	50	17.5 A
FBS 5-3,5	3213043	50	17.5 A
FBS 10-3,5	3213056	50	17.5 A

Accessories ¹⁾		
D-STTB 2,5	Order No.	Pcs./Pkt.
D-STTB 2,5	3030459	50

Terminal blocks – CLIPLINE complete

2.5 mm² ST spring-cage connection terminal blocks

General technical data

Rated data		IEC 60947-7-1 / IEC 60947-7-2			
Rated cross section	[mm ²]	2.5			
Cross section range	AWG	28 - 12			
Connection capacity		Rigid	Flexible	Ferrule without/with plastic sleeve	
1 conductor	[mm ²]	0.08 - 4	0.08 - 2.5	0.14 - 2.5	0.14 - 2.5
2 flexible conductors with a TWIN ferrule	[mm ²]	-	-	-	0.5
General data					
Stripping length	[mm]	8 - 10			
Insulating material		PA			
Flammability rating in accordance with UL 94		VO			

Note: Additional or deviating data is listed alongside the respective product.

Notes:



In addition to the product, the internal electrical wiring is provided as a circuit diagram. Free connection points for bridging are indicated by a black dot.

The specified technical data and approvals refer to the first product in each column. For information on the products below, please refer to phoenixcontact.net/products

For full details of UL and CSA use groups, file nos., and Internet links, please visit phoenixcontact.net/products

¹⁾ The bridge current is listed alongside the respective product. For additional colors, see page 402.

System accessories

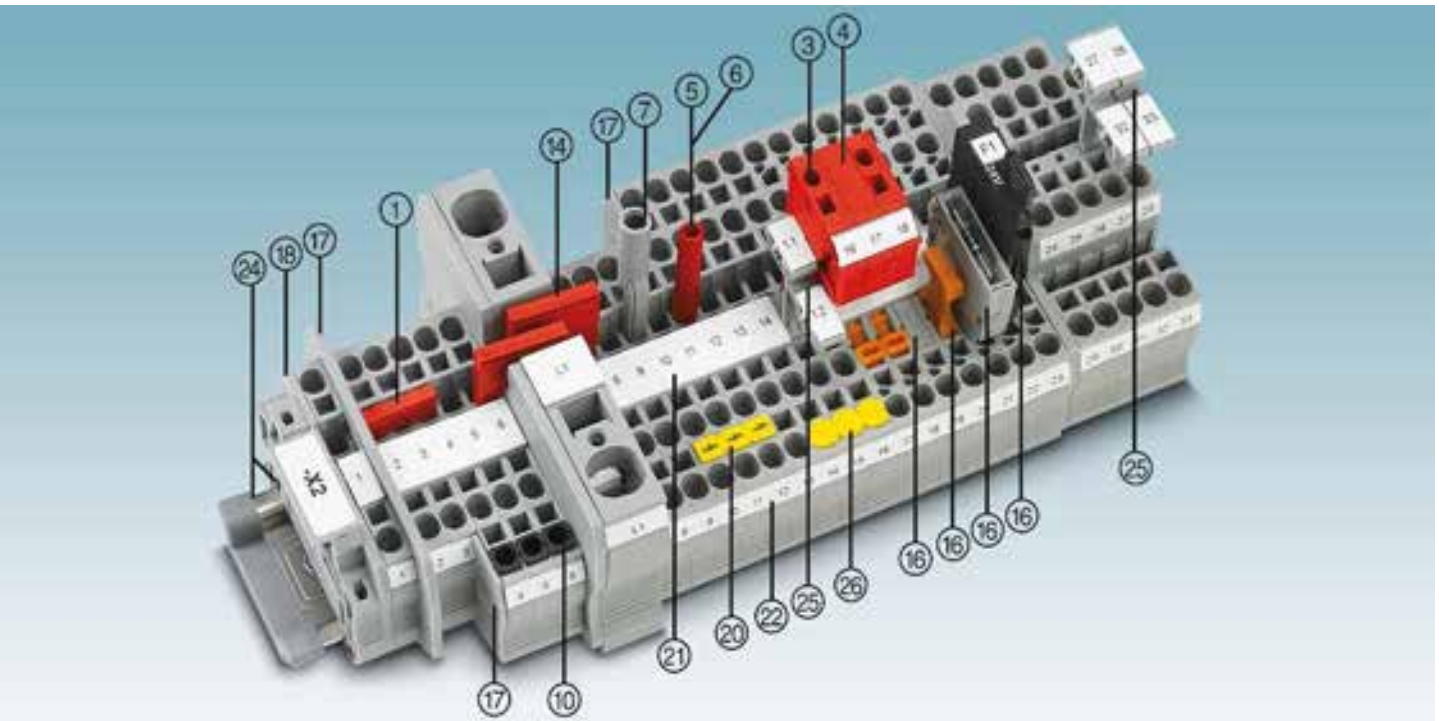

Description	No. of pos.	Color	Type	Order No.	Pcs./Pkt.	Type	Order No.	Pcs./Pkt.
① Bridge ¹⁾	2	red	FBS 2-5	3030161	50	FBSR 2-5	3033702	50
	3	red	FBS 3-5	3030174	50	FBSR 3-5	3001591	50
	4	red	FBS 4-5	3030187	50	FBSR 4-5	3001592	50
	5	red	FBS 5-5	3030190	50	FBSR 5-5	3001593	50
	10	red	FBS 10-5	3030213	10	FBSR 10-5	3033710	10
	20	red	FBS 20-5	3030226	10			
③ Modular test plug		red	PS-5	3030983	10			
④ Spacer plate		red	DP PS-5	3036725	10			
⑤ Test plug metal part		gray	MPS-MT	0201744	10			
⑥ Insulating sleeve, for MPS metal part		red	MPS-IH RD	0201676	10			
⑦ Test adapter, 4 mm socket hole		gray	PAI-4-N GY	3032871	10			
⑩ Insulating sleeve		white	ISH 2,5/0,2	3002843	50			
	0.25 - 0.5 mm ²	gray	ISH 2,5/0,5	3002856	50			
	0.75 - 1 mm ²	black	ISH 2,5/1,0	3002869	50			
Screwdriver			SZF 1-0,6X3,5	1204517	10			

⑭ Reducing bridge	For RB ..., see page 408.
⑮ Fuse and function plugs for disconnect terminal blocks	For P-FU ... / P-DI / P-FIX / P-CO ..., see from page 414.
⑰ Partition plates/end cover segments	For ATP-... / DS-..., visit phoenixcontact.net/products
⑱ Cover	Listed alongside the respective product.
⑲ Warning labels	For WS ..., see page 420.
⑲ Center groove labeling	UC-TM 5, UCT-TM 5 or ZB 5. See also Catalog 3, selection tables, from page 60.
⑲ Center and side groove labeling	UC-TMF 5, UCT-TMF 5 or ZBF 5. See also Catalog 3, selection tables, from page 60.
⑲ DIN rail and end bracket	See Catalog 3
⑲ Marker carrier	For STP ..., see page 418.
⑲ Cover for conductor shaft	For CEC ..., see page 421.
For full accessories, visit phoenixcontact.net/products	Note: Additional or deviating accessories are listed alongside the respective product.

2.5 mm² ST spring-cage connection terminal blocks

Feed-through, multi-conductor, multi-level, and ground terminal blocks

Notes:

1) For additional accessories and technical data, see page 210.

For information on installation and using accessories for Ex applications, see page 678.

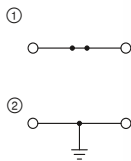

31 A, feed-through terminal block



Ex: EAC Ex IEC Ex
KEMA 00ATEX2052U / IECEx KEM 06.0051U

Technical data¹⁾

Width	Length	Height		
5.2	48.5	36.5 (NS 35/7,5)		
I _{max} [A]	U _{max} [V]	max. Ø [mm ²]	AWG (UL)	
31	800	0.08 - 4	28-12	
24 (FBS) / 17.5 (FBSR)				
IEC	UL / CUL	CSA	Ex	
800	600	600	550	
24 / 2.5	20 / -	20 / -	21 / 2.5	

Ordering data

Type	Order No.	Pcs./Pkt.
ST 2,5	3031212	50
ST 2,5 BU	3031225	50
ST 2,5-PE	3031238	50

Accessories¹⁾

D-ST 2,5	Order No.	Pcs./Pkt.
D-ST 2,5	3030417	50

Dimensions	[mm]
Maximum electrical data	
Maximum bridge current	[A]
Rated data	
Rated voltage	[V]
Nominal current / cross section	[A] / [mm ²]

Description	Color
Terminal block	gray blue
Ground terminal	green-yellow

Cover, width: 2.2 mm	Color
Cover, width: 2.2 mm	gray

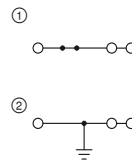

28 A, feed-through terminal block, 3 connections



Ex: EAC Ex IEC Ex
KEMA 00ATEX2052U / IECEx KEM 06.0051U

Technical data¹⁾

Width	Length	Height		
5.2	60.5	36.5 (NS 35/7,5)		
I _{max} [A]	U _{max} [V]	max. Ø [mm ²]	AWG (UL)	
28	800	0.08 - 4	28-12	
24 (FBS) / 17.5 (FBSR)				
IEC	UL / CUL	CSA	Ex	
800	600	600	550	
24 / 2.5	20 / -	20 / -	21.5 / 2.5	

Ordering data

Type	Order No.	Pcs./Pkt.
ST 2,5-TWIN	3031241	50
ST 2,5-TWIN BU	3031254	50
ST 2,5-TWIN-PE	3031267	50

Accessories¹⁾

D-ST 2,5-TWIN	Order No.	Pcs./Pkt.
D-ST 2,5-TWIN	3030488	50

Feed-through, multi-conductor, multi-level, and ground terminal blocks

Notes:

1) For additional accessories and technical data, see page 210.

For information on installation and using accessories for Ex applications, see page 678.

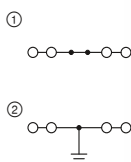

28 A, feed-through terminal block, 4 connections



Ex: EAC Ex IEC Ex
KEMA 00ATEX2052U / IECEx KEM 06.0051U

Technical data¹⁾

Width	Length	Height		
5.2	72	36.5 (NS 35/7,5)		
I _{max} [A]	U _{max} [V]	max. Ø [mm ²]	AWG (UL)	
28	800	0.08 - 4	28-12	
24 (FBS) / 17.5 (FBSR)				
IEC	UL / CUL	CSA	Ex	
800	600	600	550	
24 / 2.5	20 / -	20 / -	22 / 2.5	

Ordering data

Type	Order No.	Pcs./Pkt.
ST 2,5-QUATTRO	3031306	50
ST 2,5-QUATTRO BU	3031319	50
ST 2,5-QUATTRO-PE	3031322	50

Accessories¹⁾

D-ST 2,5-QUATTRO	Order No.	Pcs./Pkt.
D-ST 2,5-QUATTRO	3030514	50

Dimensions	[mm]
Maximum electrical data	
Maximum bridge current	[A]
Rated data	
Rated voltage	[V]
Nominal current / cross section	[A] / [mm ²]

Description	Color
Terminal block	gray
with interrupted current bar	gray blue
Ground terminal	green-yellow

Cover, width: 2.2 mm	Color
Cover, width: 2.2 mm	gray

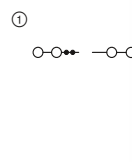

28 A, feed-through terminal block, 4 connections, with interrupted current bar



Technical data¹⁾

Width	Length	Height		
5.2	72	36.5 (NS 35/7,5)		
I _{max} [A]	U _{max} [V]	max. Ø [mm ²]	AWG (UL)	
28	800	0.08 - 4	28-12	
24 (FBS) / 17.5 (FBSR)				
IEC	UL / CUL	CSA	Ex	
800	600	600	-	
22 / 2.5	20 / -	20 / -	- / -	

Ordering data

Type	Order No.	Pcs./Pkt.
ST 2,5-QUATTRO-U	3031636	50

Accessories¹⁾

D-ST 2,5-QUATTRO	Order No.	Pcs./Pkt.
D-ST 2,5-QUATTRO	3030514	50

Terminal blocks – CLIPLINE complete

2.5 mm² ST spring-cage connection terminal blocks

Feed-through, multi-conductor, multi-level, and ground terminal blocks

Notes:
 1) For additional accessories and technical data, see page 210.
 For information on installation and using accessories for Ex applications, see page 678.

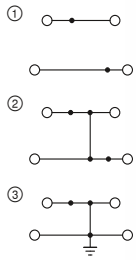

26 A, double-level terminal block

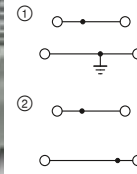

32 A, double-level ground terminal block

Ex: EAC Ex IEC Ex
 KEMA 00ATEX2052U / IECEx KEM 06.0051U

Dimensions	[mm]
Maximum electrical data	
Maximum bridge current	[A]
Rated data	
Rated voltage	[V]
Nominal current / cross section	[A] / [mm ²]

Technical data ¹⁾				
Width	Length	Height		
5.2	67.5	47.5 (NS 35/7,5)		
I _{max.} [A]	U _{max.} [V]	max. Ø [mm ²]	AWG (UL)	
26	500	0.08 - 4	28-12	
20 (FBS) / 17.5 (FBSR)				
IEC	UL / CUL	CSA	Ex	
500	600	300	440	
22 / 2.5	20 / -	20 / -	19.5 / 2.5	

Technical data ¹⁾				
Width	Length	Height		
5.2	67.5	47.5 (NS 35/7,5)		
I _{max.} [A]	U _{max.} [V]	max. Ø [mm ²]	AWG (UL)	
32	500	0.08 - 4	28-12	
20 (FBS) / 17.5 (FBSR)				
IEC	UL / CUL	CSA	Ex	
500	300	300	-	
22 / 2.5	20 / -	20 / -	- / -	

Description	Color
Terminal block	gray
	blue
With potential distribution	gray
	blue
Ground terminal	green-yellow
Terminal block	gray-yellow-green
	gray
	gray

Ordering data			
Type	Order No.	Pcs./Pkt.	
STTB 2,5	① 3031270	50	
STTB 2,5 BU	① 3031283	50	
STTB 2,5-PV	② 3031539	50	
STTB 2,5-PV BU	② 3035108	50	
STTB 2,5-PE	③ 3036026	50	

Ordering data			
Type	Order No.	Pcs./Pkt.	
STTB 2,5-PE/L	① 3036314	50	
STTB 2,5-PE/N	① 3036327	50	
STTB 2,5-L/N	② 3036330	50	

Cover, width: 2.2 mm	gray
----------------------	------

Accessories ¹⁾		
D-STTB 2,5	Order No.	Pcs./Pkt.
D-STTB 2,5	3030459	50

Accessories ¹⁾		
D-STTB 2,5	Order No.	Pcs./Pkt.
D-STTB 2,5	3030459	50

Feed-through, multi-conductor, multi-level, and ground terminal blocks

Notes:
 1) For additional accessories and technical data, see page 210.

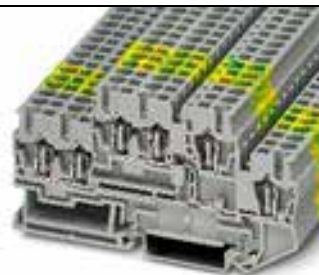
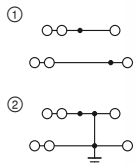

26 A, feed-through terminal block, 3 connections per level

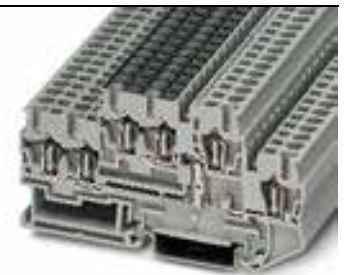
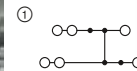

26 A, feed-through terminal block, with equipotential bonding

Dimensions	[mm]
Maximum electrical data	
Maximum bridge current	[A]
Rated data	
Rated voltage	[V]
Nominal current / cross section	[A] / [mm ²]

Technical data ¹⁾				
Width	Length	Height		
5.2	91.5	47.5 (NS 35/7,5)		
I _{max.} [A]	U _{max.} [V]	max. Ø [mm ²]	AWG (UL)	
26	500	0.08 - 4	28-12	
20 (FBS) / 17.5 (FBSR)				
IEC	UL / CUL	CSA	Ex	
500	600	300	-	
22 / 2.5	20 / -	20 / -	- / -	

Technical data ¹⁾				
Width	Length	Height		
5.2	91.5	47.5 (NS 35/7,5)		
I _{max.} [A]	U _{max.} [V]	max. Ø [mm ²]	AWG (UL)	
26	500	0.08 - 4	28-12	
20 (FBS) / 17.5 (FBSR)				
IEC	UL / CUL	CSA	Ex	
500	600	300	-	
22 / 2.5	20 / -	20 / -	- / -	

Description	Color
Terminal block	gray
	blue
	gray
Ground terminal	green-yellow

Ordering data			
Type	Order No.	Pcs./Pkt.	
STTB 2,5-TWIN	① 3038516	50	
STTB 2,5-TWIN BU	① 3038529	50	
STTB 2,5-TWIN-PE	② 3038532	50	

Ordering data			
Type	Order No.	Pcs./Pkt.	
STTB 2,5-TWIN-PV	① 3038545	50	

Cover, width: 2.2 mm	gray
----------------------	------

Accessories ¹⁾		
D-STTB 2,5-TWIN	Order No.	Pcs./Pkt.
D-STTB 2,5-TWIN	3038558	50

Accessories ¹⁾		
D-STTB 2,5-TWIN	Order No.	Pcs./Pkt.
D-STTB 2,5-TWIN	3038558	50

2.5 mm² ST spring-cage connection terminal blocks

Multi-level terminal blocks

Notes:
 1) For additional accessories and technical data, see page 210.

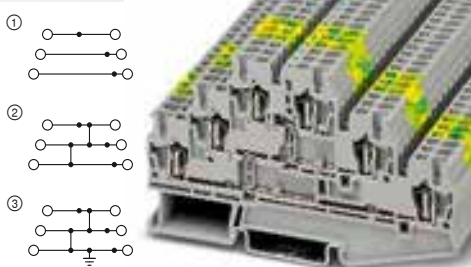

28 A, three-level terminal block



Technical data ¹⁾				
Dimensions	Width	Length	Height	
	5.2	99.5	58 (NS 35/7,5)	
Maximum electrical data	I_{max} [A]	U_{max} [V]	max. Ø [mm ²]	AWG (UL)
	28	500	0.08 - 4	28-12
	20 (FBS) / 17.5 (FBSR)			
Rated data	IEC	UL / CUL	CSA	Ex
	500	600	300	-
	20 / 2.5			

Ordering data			
Type	Order No.	Pcs./Pkt.	
ST 2,5-3L	3036042	50	①
ST 2,5-3L BU	3038710	50	①
ST 2,5-3PV	3036068	50	②
ST 2,5-3PE	3036071	50	③

Accessories ¹⁾		
Type	Order No.	Pcs./Pkt.
D-ST 2,5-3L	3036660	50

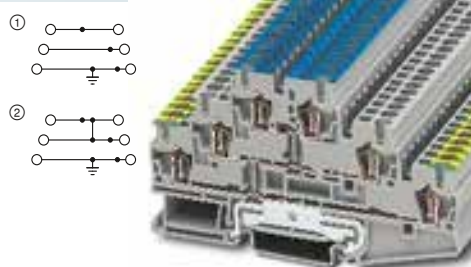

28 A, three-level terminal block with PE foot



Technical data ¹⁾				
Dimensions	Width	Length	Height	
	5.2	99.5	58 (NS 35/7,5)	
Maximum electrical data	I_{max} [A]	U_{max} [V]	max. Ø [mm ²]	AWG (UL)
	28	500	0.08 - 4	28-12
	22 (FBS) / 17.5 (FBSR)			
Rated data	IEC	UL / CUL	CSA	Ex
	500	600	300	-
	24 / 2.5			

Ordering data			
Type	Order No.	Pcs./Pkt.	
ST 2,5-PE/L/N	3036084	50	①
ST 2,5-PE/L/L	3036097	50	①
ST 2,5-PE/2PV	3038833	50	②

Accessories ¹⁾		
Type	Order No.	Pcs./Pkt.
D-ST 2,5-3L	3036660	50

Multi-level terminal blocks

Notes:
 1) For additional accessories and technical data, see page 210.
 2) The operating voltage is determined by the LED version.

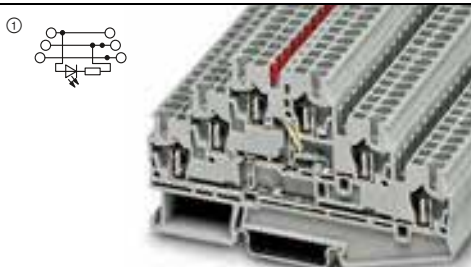

28 A, three-level terminal block with LED display



Technical data ¹⁾				
Dimensions	Width	Length	Height	
	5.2	99.5	58 (NS 35/7,5)	
Maximum electrical data	I_{max} [A]	U_{max} [V]	max. Ø [mm ²]	AWG (UL)
	28	500 ²⁾	0.08 - 4	-
	20 (FBS) / 17.5 (FBSR)			
Rated data	IEC	UL / CUL	CSA	Ex
	500 ²⁾	-	-	-
	20 / 2.5			

Ordering data			
Type	Order No.	Pcs./Pkt.	
ST 2,5-3L-LA 24RD/O-M	3035580	50	①

Accessories ¹⁾		
Type	Order No.	Pcs./Pkt.
D-ST 2,5-3L	3036660	50



26 A, four-level terminal block with PE foot



Technical data ¹⁾				
Dimensions	Width	Length	Height	
	5.2	98.5	73.5 (NS 35/7,5)	
Maximum electrical data	I_{max} [A]	U_{max} [V]	max. Ø [mm ²]	AWG (UL)
	26	800	0.08 - 4	28-12
	-			
Rated data	IEC	UL / CUL	CSA	Ex
	800	600	600	-
	20 / 2.5			

Ordering data			
Type	Order No.	Pcs./Pkt.	
ST 2,5-PE/3L	3036055	50	①

Accessories ¹⁾		
Type	Order No.	Pcs./Pkt.
D-ST 2,5-PE/3L	3036673	50

Terminal blocks – CLIPLINE complete

2.5 mm² ST spring-cage connection terminal blocks

Initiator/actuator terminal blocks

Notes:
 1) For additional accessories and technical data, see page 210.

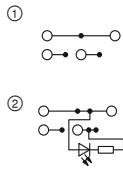

18 A, three-conductor initiator terminal block



Technical data ¹⁾				
Width	Length	Height		
5.2	75	44.5 (NS 35/7,5)		
I_{max} [A]	U_{max} [V]	max. Ø [mm ²]	AWG (UL)	
18	250	0.08 - 4	28-12	
24 (FBS) / 17.5 (FBSR)				
IEC	UL / CUL	CSA	Ex	
250	300	-	-	
Nominal current / cross section [A] / [mm ²]				
18 / 2.5 18 / - - / - - / -				

Ordering data			
Type	Order No.	Pcs./Pkt.	
STIO 2,5/3-2B/L	① 3209015	50	
STIO 2,5/3-2B/L-LA24RD/O-M	② 3209028	50	
STIO 2,5/3-2B/L-LA24GN/O-M	② 3209031	50	

Accessories ¹⁾			
D-STIO 2,5/3	3209112	50	

Dimensions	
	[mm]
Maximum electrical data	
Maximum bridge current	[A]
Rated data	
Rated voltage	[V]
Nominal current / cross section	[A] / [mm ²]

Description	Color
Terminal block	gray
Red LED, 15 - 30 V DC, 1 - 2.5 mA, LED between upper and middle level	gray
Green LED, 15 - 30 V DC, 1 - 2.5 mA, LED between upper and middle level	gray

Cover, width: 2.2 mm	gray
----------------------	------

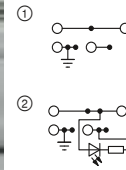

18 A, three-conductor actuator terminal block with PE foot



Technical data ¹⁾				
Width	Length	Height		
5.2	75	44.5 (NS 35/7,5)		
I_{max} [A]	U_{max} [V]	max. Ø [mm ²]	AWG (UL)	
18	250	0.08 - 4	28-12	
24 (FBS) / 17.5 (FBSR)				
IEC	UL / CUL	CSA	Ex	
250	300	-	-	
Nominal current / cross section [A] / [mm ²]				
18 / 2.5 18 / - - / - - / -				

Ordering data			
Type	Order No.	Pcs./Pkt.	
STIO 2,5/3-PE/B/L	① 3209044	50	
STIO 2,5/3-PE/B/L-LA24RD/O-M	② 3209138	50	
STIO 2,5/3-PE/B/L-LA24GN/O-M	② 3209141	50	

Accessories ¹⁾			
D-STIO 2,5/3	3209112	50	

Power terminal blocks

Notes:
 1) For additional accessories and technical data, see page 210.
 2) In the case of central power feed.



30 A, power terminal block



Technical data ¹⁾				
Width	Length	Height		
10.4	75	44.5 (NS 35/7,5)		
I_{max} [A]	U_{max} [V]	max. Ø [mm ²]	AWG (UL)	
30 ²⁾	250	0.08 - 4	28-12	
24 (FBS) / 17.5 (FBSR)				
IEC	UL / CUL	CSA	Ex	
250	300	-	-	
Nominal current / cross section [A] / [mm ²]				
30 / 2.5 20 / - - / - - / -				

Ordering data			
Type	Order No.	Pcs./Pkt.	
STIO-IN 2,5/3 OG	① 3209196	25	

Accessories ¹⁾			
D-STIO 2,5/3	3209112	50	

Description	Color
Power terminal block	orange
	orange

Cover, width: 2.2 mm	gray
----------------------	------

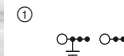

30 A, power terminal block with PE foot



Technical data ¹⁾				
Width	Length	Height		
10.4	75	44.5 (NS 35/7,5)		
I_{max} [A]	U_{max} [V]	max. Ø [mm ²]	AWG (UL)	
30 ²⁾	250	0.08 - 4	28-12	
24 (FBS) / 17.5 (FBSR)				
IEC	UL / CUL	CSA	Ex	
250	300	-	-	
Nominal current / cross section [A] / [mm ²]				
30 / 2.5 20 / - - / - - / -				

Ordering data			
Type	Order No.	Pcs./Pkt.	
STIO-IN 2,5/3-PE OG	① 3209086	25	

Accessories ¹⁾			
D-STIO 2,5/3	3209112	50	

2.5 mm² ST spring-cage connection terminal blocks

Initiator/actuator terminal blocks

Notes:
 1) For additional accessories and technical data, see page 210.

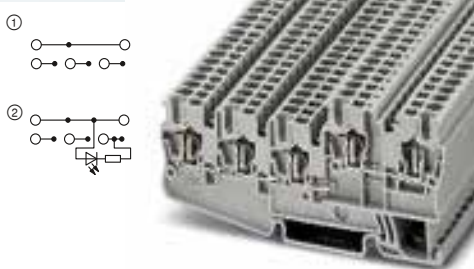

18 A, four-conductor initiator terminal block

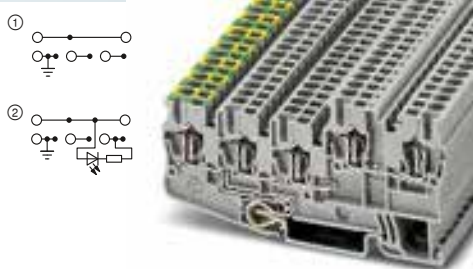

18 A, four-conductor actuator terminal block with PE foot



Technical data ¹⁾				
Width	Length	Height		
5.2	92.3	44.5 (NS 35/7,5)		
I_{max} [A]	U_{max} [V]	max. Ø [mm ²]	AWG (UL)	
18	250	0.08 - 4	28-12	
24 (FBS) / 17.5 (FBSR)				
IEC	UL / CUL	CSA	Ex	
250	300	-	-	
Nominal current / cross section [A] / [mm ²]				
18 / 2.5	18 / -	- / -	- / -	

Ordering data			
Type	Order No.	Pcs./Pkt.	
STIO 2,5/4-3B/L	① 3209057	50	
STIO 2,5/4-3B/L-LA24RD/O-M	② 3209154	50	
STIO 2,5/4-3B/L-LA24GN/O-M	② 3209167	50	

Accessories ¹⁾		
D-STIO 2,5/4	3209125	50



Technical data ¹⁾			
Width	Length	Height	
5.2	92.3	44.5 (NS 35/7,5)	
I_{max} [A]	U_{max} [V]	max. Ø [mm ²]	AWG (UL)
18	250	0.08 - 4	28-12
24 (FBS) / 17.5 (FBSR)			
IEC	UL / CUL	CSA	Ex
250	300	-	-
Nominal current / cross section [A] / [mm ²]			
18 / 2.5	18 / -	- / -	- / -

Ordering data			
Type	Order No.	Pcs./Pkt.	
STIO 2,5/4-PE/2B/L	① 3209060	50	
STIO 2,5/4-PE/2B/L-LA24RD/O-M	② 3209170	50	
STIO 2,5/4-PE/2B/L-LA24GN/O-M	② 3209183	50	

Accessories ¹⁾		
D-STIO 2,5/4	3209125	50

Power terminal blocks

Notes:
 1) For additional accessories and technical data, see page 210.
 2) In the case of central power feed.

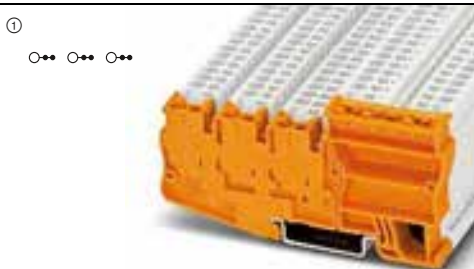

30 A, power terminal block



30 A, power terminal block with PE foot



Technical data ¹⁾				
Width	Length	Height		
10.4	92.3	44.5 (NS 35/7,5)		
I_{max} [A]	U_{max} [V]	max. Ø [mm ²]	AWG (UL)	
30 ²⁾	250	0.08 - 4	28-12	
24 (FBS) / 17.5 (FBSR)				
IEC	UL / CUL	CSA	Ex	
250	300	-	-	
Nominal current / cross section [A] / [mm ²]				
30 / 2.5	20 / -	- / -	- / -	

Ordering data			
Type	Order No.	Pcs./Pkt.	
STIO-IN 2,5/4 OG	① 3209206	25	

Accessories ¹⁾		
D-STIO 2,5/4	3209125	50



Technical data ¹⁾			
Width	Length	Height	
10.4	92.3	44.5 (NS 35/7,5)	
I_{max} [A]	U_{max} [V]	max. Ø [mm ²]	AWG (UL)
30 ²⁾	250	0.08 - 4	28-12
24 (FBS) / 17.5 (FBSR)			
IEC	UL / CUL	CSA	Ex
250	300	-	-
Nominal current / cross section [A] / [mm ²]			
30 / 2.5	20 / -	- / -	- / -

Ordering data			
Type	Order No.	Pcs./Pkt.	
STIO-IN 2,5/4-PE OG	① 3209109	25	

Accessories ¹⁾		
D-STIO 2,5/4	3209125	50

Terminal blocks – CLIPLINE complete

2.5 mm² ST spring-cage connection terminal blocks

Disconnect terminal blocks

Notes:
1) For additional accessories and technical data, see page 210.
2) Current and voltage are determined by the plug used.

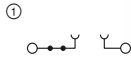

20 A, disconnect terminal block



Technical data ¹⁾				
Dimensions	Width	Length	Height	
[mm]	5.2	60.5	36.5 (NS 35/7,5)	
Maximum electrical data	I _{max.} [A]	U _{max.} [V]	max. Ø [mm ²]	AWG (UL)
	20 ²⁾	400 ²⁾	0.08 - 4	28-12
Maximum bridge current	24 (FBS) / 17.5 (FBSR)			
Rated data	IEC	UL / CUL	CSA	Ex
Rated voltage	400 ²⁾	300	300	-
Nominal current / cross section	20 ²⁾ / 2.5	16 / -	16 / -	- / -

Ordering data			
Type	Order No.	Pcs./Pkt.	
ST 2,5-TG	3038435	50	

Accessories ¹⁾			
Type	Order No.	Pcs./Pkt.	
D-ST 2,5-TWIN	3030488	50	

Description	Color
Terminal block	gray
Cover, width: 2.2 mm	gray

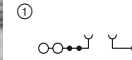

20 A, disconnect terminal block, 3 connections



Technical data ¹⁾				
Dimensions	Width	Length	Height	
[mm]	5.2	72	36.5 (NS 35/7,5)	
Maximum electrical data	I _{max.} [A]	U _{max.} [V]	max. Ø [mm ²]	AWG (UL)
	20	400 ²⁾	0.08 - 4	28-12
Maximum bridge current	24 (FBS) / 17.5 (FBSR)			
Rated data	IEC	UL / CUL	CSA	Ex
Rated voltage	400 ²⁾	300	300	-
Nominal current / cross section	20 ²⁾ / 2.5	16 / -	16 / -	- / -

Ordering data			
Type	Order No.	Pcs./Pkt.	
ST 2,5-TWIN-TG	3038448	50	

Accessories ¹⁾			
Type	Order No.	Pcs./Pkt.	
D-ST 2,5-QUATTRO	3030514	50	

Disconnect terminal blocks

Notes:
1) For additional accessories and technical data, see page 210.
2) Current and voltage are determined by the plug used.



20 A, disconnect terminal block, 4 connections



Technical data ¹⁾				
Dimensions	Width	Length	Height	
[mm]	5.2	84	36.5 (NS 35/7,5)	
Maximum electrical data	I _{max.} [A]	U _{max.} [V]	max. Ø [mm ²]	AWG (UL)
	20	400 ²⁾	0.08 - 4	28-12
Maximum bridge current	24 (FBS) / 17.5 (FBSR)			
Rated data	IEC	UL / CUL	CSA	Ex
Rated voltage	400 ²⁾	300	300	-
Nominal current / cross section	20 ²⁾ / 2.5	16 / -	16 / -	- / -

Ordering data			
Type	Order No.	Pcs./Pkt.	
ST 2,5-QUATTRO-TG	3038451	50	

Accessories ¹⁾			
Type	Order No.	Pcs./Pkt.	
D-ST 2,5-QUATTRO-MT	3038590	50	

Description	Color
Terminal block	gray
Cover, width: 2.2 mm	gray

Knife disconnect terminal blocks

Notes:

¹⁾ For additional accessories and technical data, see page 210.

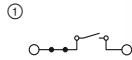

20 A, knife disconnect terminal block



Technical data¹⁾

Dimensions	Width	Length	Height	
[mm]	5.2	60.5	36.5 (NS 35/7,5)	
Maximum electrical data	I_{max} [A]	U_{max} [V]	max. Ø [mm ²]	AWG (UL)
	20	400	0.08 - 4	28-12
Maximum bridge current	24 (FBS) / 17.5 (FBSR)			
Rated data	IEC	UL / CUL	CSA	Ex
Rated voltage	400	600	300	-
Nominal current / cross section	20 / 2.5	16 / -	16 / -	- / -

Ordering data

Description	Color	Type	Order No.	Pcs./Pkt.
Terminal block	gray	ST 2,5-MT	3036343	50
	blue	ST 2,5-MT BU	3037818	50

Accessories¹⁾

Cover, width: 2.2 mm	gray	D-ST 2,5-TWIN	3030488	50
-----------------------------	------	---------------	---------	----

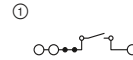

20 A, knife disconnect terminal block, 3 connections



Technical data¹⁾

Dimensions	Width	Length	Height	
[mm]	5.2	72	36.5 (NS 35/7,5)	
Maximum electrical data	I_{max} [A]	U_{max} [V]	max. Ø [mm ²]	AWG (UL)
	20	400	0.08 - 4	28-12
Maximum bridge current	24 (FBS) / 17.5 (FBSR)			
Rated data	IEC	UL / CUL	CSA	Ex
Rated voltage	400	600	300	-
Nominal current / cross section	20 / 2.5	16 / -	16 / -	- / -

Ordering data

Description	Color	Type	Order No.	Pcs./Pkt.
Terminal block	gray	ST 2,5-TWIN-MT	3036356	50
	blue	ST 2,5-TWIN-MT BU	3037821	50

Accessories¹⁾

Cover, width: 2.2 mm	gray	D-ST 2,5-QUATTRO	3030514	50
-----------------------------	------	------------------	---------	----

Knife disconnect terminal blocks

Notes:

¹⁾ For additional accessories and technical data, see page 210.

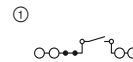

20 A, knife disconnect terminal block, 4 connections



Technical data¹⁾

Dimensions	Width	Length	Height	
[mm]	5.2	84	36.5 (NS 35/7,5)	
Maximum electrical data	I_{max} [A]	U_{max} [V]	max. Ø [mm ²]	AWG (UL)
	20	400	0.08 - 4	28-12
Maximum bridge current	24 (FBS) / 17.5 (FBSR)			
Rated data	IEC	UL / CUL	CSA	Ex
Rated voltage	400	600	300	-
Nominal current / cross section	20 / 2.5	16 / -	16 / -	- / -

Ordering data

Description	Color	Type	Order No.	Pcs./Pkt.
Terminal block	gray	ST 2,5-QUATTRO-MT	3036576	50
	blue	ST 2,5-QUATTRO-MT BU	3037834	50

Accessories¹⁾

Cover, width: 2.2 mm	gray	D-ST 2,5-QUATTRO-MT	3038590	50
-----------------------------	------	---------------------	---------	----

Terminal blocks – CLIPLINE complete

2.5 mm² ST spring-cage connection terminal blocks

Diode terminal blocks

Notes:
 1) For additional accessories and technical data, see page 210.

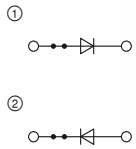

**0.5 A, diode terminal block,
1N 4007 (1300 V/0.5 A)**



Technical data ¹⁾					
Width	Length	Height			
5.2	48.5	36.5 (NS 35/7,5)			
I_{max} [A]	U_{max} [V]	max. Ø [mm ²]	AWG (UL)		
0.5	800	0.08 - 4	28-12		
24 (FBS) / 17.5 (FBSR)					
IEC	UL / CUL	CSA	Ex		
800	600	600	-		
Nominal current / cross section	[A] / [mm ²]	0.5 / 1	1 / -	1 / -	- / -

Ordering data			
Type	Order No.	Pcs./Pkt.	
ST 2,5-DIO/L-R	① 3036262	50	
ST 2,5-DIO/R-L	② 3036518	50	

Accessories ¹⁾			
Type	Order No.	Pcs./Pkt.	
D-ST 2,5	3030417	50	

Dimensions	
	[mm]
Maximum electrical data	
Maximum bridge current	[A]
Rated data	
Rated voltage	[V]
Nominal current / cross section	[A] / [mm ²]

Description	Color
Terminal block, for conducting direction see circuit diagram	gray
	gray

Cover, width: 2.2 mm	gray
----------------------	------

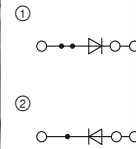

**0.5 A, diode terminal block,
1N 4007 (1300 V/0.5 A), 3 connections**



Technical data ¹⁾				
Width	Length	Height		
5.2	60.5	36.5 (NS 35/7,5)		
I_{max} [A]	U_{max} [V]	max. Ø [mm ²]	AWG (UL)	
0.5	800	0.08 - 4	28-12	
24 (FBS) / 17.5 (FBSR)				
IEC	UL / CUL	CSA	Ex	
800	600	600	-	
Nominal current / cross section	[A] / [mm ²]	0.5 / 1	20 / -	- / -

Ordering data			
Type	Order No.	Pcs./Pkt.	
ST 2,5-TWIN-DIO/L-R	① 3036246	50	
ST 2,5-TWIN-DIO/R-L	② 3036521	50	

Accessories ¹⁾			
Type	Order No.	Pcs./Pkt.	
D-ST 2,5-TWIN	3030488	50	

Diode terminal blocks

Notes:
 1) For additional accessories and technical data, see page 210.

2) The max. current is determined by the diode. Integrated: Diode 1N 4007, reverse voltage: 1300 V, maximum continuous current: 0.5 A

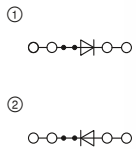

**0.5 A, diode terminal block,
1N 4007 (1300 V/0.5 A), 4 connections**



Technical data ¹⁾				
Width	Length	Height		
5.2	72	36.5 (NS 35/7,5)		
I_{max} [A]	U_{max} [V]	max. Ø [mm ²]	AWG (UL)	
0.5 ²⁾	800	0.08 - 4	28-12	
24 (FBS) / 17.5 (FBSR)				
IEC	UL / CUL	CSA	Ex	
800	600	600	-	
Nominal current / cross section	[A] / [mm ²]	0.5 / 1	20 / -	- / -

Ordering data			
Type	Order No.	Pcs./Pkt.	
ST 2,5-QUATTRO-DIO/L-R	① 3036233	50	
ST 2,5-QUATTRO-DIO/R-L	② 3036534	50	

Accessories ¹⁾			
Type	Order No.	Pcs./Pkt.	
D-ST 2,5-QUATTRO	3030514	50	

Dimensions	
	[mm]
Maximum electrical data	
Maximum bridge current	[A]
Rated data	
Rated voltage	[V]
Nominal current / cross section	[A] / [mm ²]

Description	Color
Terminal block, for conducting direction see circuit diagram	gray
	gray

Cover, width: 2.2 mm	gray
----------------------	------

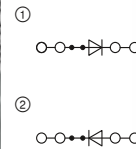

**1.5 A, diode terminal block,
1N 5408 (1000 V/1.5 A), 4 connections**



Technical data ¹⁾				
Width	Length	Height		
5.2	72	36.5 (NS 35/7,5)		
I_{max} [A]	U_{max} [V]	max. Ø [mm ²]	AWG (UL)	
1.5	800	0.08 - 4	-	
24 (FBS) / 17.5 (FBSR)				
IEC	UL / CUL	CSA	Ex	
800	-	-	-	
Nominal current / cross section	[A] / [mm ²]	1.5 / 1	- / -	- / -

Ordering data			
Type	Order No.	Pcs./Pkt.	
ST 2,5-QUATTRO-DIO 1N 5408K/L-R	① 3002216	50	
ST 2,5-QUATTRO-DIO 1N 5408K/R-L	② 3002214	50	

Accessories ¹⁾			
Type	Order No.	Pcs./Pkt.	
D-ST 2,5-QUATTRO	3030514	50	

2.5 mm² ST spring-cage connection terminal blocks

Diode terminal blocks

Notes:
 1) For additional accessories and technical data, see page 210.

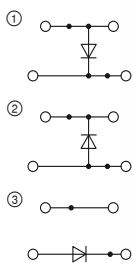

26 A, double-level diode terminal block, 1N 4007 (1300 V/0.5 A)



Technical data ¹⁾				
Dimensions	Width	Length	Height	
[mm]	5.2	67.5	47.5 (NS 35/7,5)	
Maximum electrical data	I_{max} [A]	U_{max} [V]	max. Ø [mm ²]	AWG (UL)
	26	500	0.08 - 4	28-12
Maximum bridge current	20 (FBS) / 17.5 (FBSR)			
Rated data	IEC	UL / CUL	CSA	Ex
Rated voltage	500	600	300	-
Nominal current / cross section	22 / 2.5	20 / -	- / -	- / -

Ordering data				
Description	Color	Type	Order No.	Pcs./Pkt.
Terminal block, for conducting direction see circuit diagram	gray	STTB 2,5-DIO/O-U	① 3031555	50
	gray	STTB 2,5-DIO/U-O	② 3031563	50
	gray	STTB 2,5-DIO/UL-UR	③ 3031571	50

Accessories ¹⁾			
Cover, width: 2.2 mm	gray	D-STTB 2,5	3030459 50

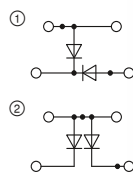

26 A, double-level diode terminal block, 1N 4007 (1300 V/0.5 A)



Technical data ¹⁾				
Dimensions	Width	Length	Height	
[mm]	5.2	67.5	47.5 (NS 35/7,5)	
Maximum electrical data	I_{max} [A]	U_{max} [V]	max. Ø [mm ²]	AWG (UL)
	26	250	0.08 - 4	28-12
Maximum bridge current	20 (FBS) / 17.5 (FBSR)			
Rated data	IEC	UL / CUL	CSA	Ex
Rated voltage	250	600	300	-
Nominal current / cross section	22 / 2.5	20 / -	- / -	- / -

Ordering data				
Description	Color	Type	Order No.	Pcs./Pkt.
Terminal block, for conducting direction see circuit diagram	gray	STTB 2,5-2DIO/O-UL/UR-UL	① 3031584	50
	gray	STTB 2,5-2DIO/O-UL/O-UR	② 3031597	50

Accessories ¹⁾			
Cover, width: 2.2 mm	gray	D-STTB 2,5	3030459 50

Double-level terminal blocks with LED display

Notes:
 1) For additional accessories and technical data, see page 210.
 2) The operating voltage is determined by the LED version.

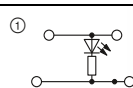

26 A, double-level terminal block with LED display



Technical data ¹⁾				
Dimensions	Width	Length	Height	
[mm]	5.2	67.5	47.5 (NS 35/7,5)	
Maximum electrical data	I_{max} [A]	U_{max} [V]	max. Ø [mm ²]	AWG (UL)
	26	250 ²⁾	0.08 - 4	28-12
Maximum bridge current	20 (FBS) / 17.5 (FBSR)			
Rated data	IEC	UL / CUL	CSA	Ex
Rated voltage	250 ²⁾	600	-	-
Nominal current / cross section	22 / 2.5	20 / -	- / -	- / -

Ordering data				
Description	Color	Type	Order No.	Pcs./Pkt.
Terminal block, with LED for 12 - 30 V DC, 0.7 - 2.4 mA	gray	STTB 2,5-LA 24 RD	① 3031607	50
with LED display for 30 - 60 V DC, 0.8 - 1.8 mA	gray	STTB 2,5-LA 60 RD	① 3031610	50
with LED display for 110 - 230 V AC/DC, 0.1 - 0.5 mA	gray	STTB 2,5-LA230	① 3031623	50

Accessories ¹⁾			
Cover, width: 2.2 mm	gray	D-STTB 2,5	3030459 50

Technical data ¹⁾				
Dimensions	Width	Length	Height	
[mm]	5.2	67.5	47.5 (NS 35/7,5)	
Maximum electrical data	I_{max} [A]	U_{max} [V]	max. Ø [mm ²]	AWG (UL)
	26	250 ²⁾	0.08 - 4	28-12
Maximum bridge current	20 (FBS) / 17.5 (FBSR)			
Rated data	IEC	UL / CUL	CSA	Ex
Rated voltage	250 ²⁾	600	-	-
Nominal current / cross section	22 / 2.5	20 / -	- / -	- / -

Ordering data				
Description	Color	Type	Order No.	Pcs./Pkt.
Terminal block, with LED for 12 - 30 V DC, 0.7 - 2.4 mA	gray	STTB 2,5-LA 24 RD	① 3031607	50
with LED display for 30 - 60 V DC, 0.8 - 1.8 mA	gray	STTB 2,5-LA 60 RD	① 3031610	50
with LED display for 110 - 230 V AC/DC, 0.1 - 0.5 mA	gray	STTB 2,5-LA230	① 3031623	50

Accessories ¹⁾			
Cover, width: 2.2 mm	gray	D-STTB 2,5	3030459 50

Terminal blocks – CLIPLINE complete

2.5 mm² ST spring-cage connection terminal blocks

Double-level terminal blocks with temperature sensor

Notes:
 1) For additional accessories and technical data, see page 210.

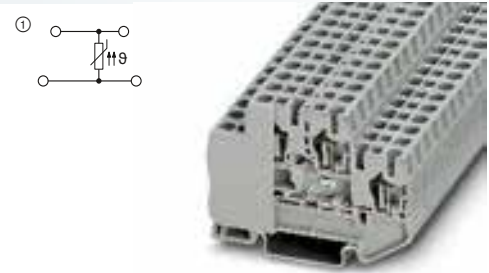

26 A, double-level terminal block with temperature sensor

ERC

Dimensions	
	[mm]
Maximum electrical data	
	[A] / [mm ²]
Rated data	
Rated voltage	[V]
Nominal current / cross section	[A] / [mm ²]

Description	Color
Terminal block, with integrated Pt 100 temperature sensor and fitted cover	gray

Technical data ¹⁾			
Width	Length	Height	
7.4	67.5	47.5 (NS 35/7,5)	
I _{max.} [A]	U _{max.} [V]	max. Ø [mm ²]	AWG (UL)
26	500	0.08 - 4	-
IEC	UL / CUL	CSA	Ex
22 / 2.5	- / -	- / -	- / -

Ordering data		
Type	Order No.	Pcs./Pkt.
STTB 2,5-PT100 MD	3035564	50

Hybrid terminal blocks with screw connection on one side, 2.5 (4) mm²

Notes:
 1) For additional accessories and technical data, see page 210.
 2) For screw connection rated data, visit phoenixcontact.net/products

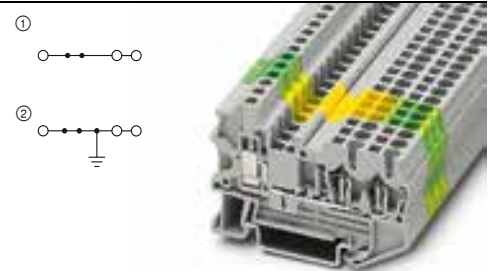

28 A, feed-through terminal block, 3 connections

ERC

Dimensions	
	[mm]
Maximum electrical data	
	[A]
Rated data ²⁾	
Rated voltage	[V]
Nominal current / cross section	[A] / [mm ²]

Description	Color
Terminal block	gray blue
Ground terminal	green-yellow

Cover, width: 2.2 mm	gray
----------------------	------

Technical data ¹⁾			
Width	Length	Height	
5.2	65.3	42.8 (NS 35/7,5)	
I _{max.} [A]	U _{max.} [V]	max. Ø [mm ²]	AWG (UL)
28	800	0.08 - 4	28-12
24 (FBS) / 17.5 (FBSR)			
IEC	UL / CUL	CSA	Ex
800	600	600	-
24 / 2.5	20 / -	20 / -	- / -

Ordering data		
Type	Order No.	Pcs./Pkt.
STU 2,5-TWIN	3033016	50
STU 2,5-TWIN BU	3033029	50
STU 2,5-TWIN-PE	3033032	50

Accessories ¹⁾		
Type	Order No.	Pcs./Pkt.
D-STU 2,5-TWIN	3033045	50

2.5 mm² ST spring-cage connection terminal blocks

Desk-design terminal blocks

Notes:
 1) For additional accessories and technical data, see page 210.
 For information on installation and using accessories for Ex applications, see page 678.



31 A, feed-through terminal block

Ex: EAC Ex IEC Ex
 PTB 07ATEX1027U / IECEx PTB 07.0024U

Technical data ¹⁾				
Width	Length	Height		
5.2	50.8	43 (NS 35/7,5)		
<i>I</i> _{max.} [A]	<i>U</i> _{max.} [V]	max. Ø [mm ²]	AWG (UL)	
31	800	0.08 - 4	28-12	
24 (FBS) / 17.5 (FBRS)				
IEC	UL / CUL	CSA	Ex	
800	600	600	550	
Nominal current / cross section	[A] / [mm ²]	24 / 2.5	20 / -	20.5 / 2.5

Ordering data			
Type	Order No.	Pcs./Pkt.	
STS 2,5	① 3036398	50	
STS 2,5 BU	① 3036408	50	
STS 2,5-PE	② 3036411	50	

Accessories ¹⁾		
D-ST5 2,5	3031762	50

Dimensions	[mm]
Maximum electrical data	
Maximum bridge current	[A]
Rated data	
Rated voltage	[V]
Nominal current / cross section	[A] / [mm ²]
Description	Color
Terminal block	gray
Ground terminal	blue
	green-yellow
Cover, width: 2.2 mm	gray

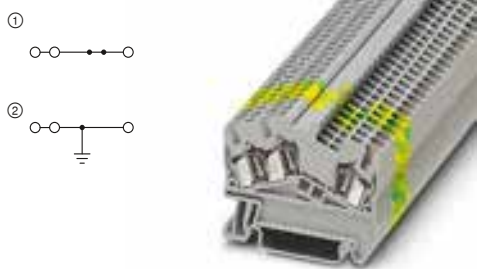

28 A, feed-through terminal block, 3 connections

Ex: EAC Ex IEC Ex
 PTB 07ATEX1027U / IECEx PTB 07.0024U

Technical data ¹⁾				
Width	Length	Height		
5.2	50.8	43 (NS 35/7,5)		
<i>I</i> _{max.} [A]	<i>U</i> _{max.} [V]	max. Ø [mm ²]	AWG (UL)	
28	800	0.08 - 4	28-12	
24 (FBS) / 17.5 (FBRS)				
IEC	UL / CUL	CSA	Ex	
800	600	600	550	
Nominal current / cross section	[A] / [mm ²]	24 / 2.5	20 / -	21 / 2.5

Ordering data			
Type	Order No.	Pcs./Pkt.	
STS 2,5-TWIN	① 3031720	50	
STS 2,5-TWIN BU	① 3036275	50	
STS 2,5-TWIN-PE	② 3031733	50	

Accessories ¹⁾		
D-ST5 2,5	3031762	50

Desk-design terminal blocks

Notes:
 1) For additional accessories and technical data, see page 210.
 For information on installation and using accessories for Ex applications, see page 678.

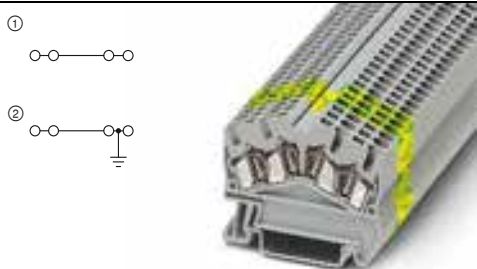

28 A, feed-through terminal block, 4 connections

Ex: EAC Ex IEC Ex
 PTB 07ATEX1027U / IECEx PTB 07.0024U

Technical data ¹⁾				
Width	Length	Height		
5.2	50.8	43 (NS 35/7,5)		
<i>I</i> _{max.} [A]	<i>U</i> _{max.} [V]	max. Ø [mm ²]	AWG (UL)	
28	800	0.08 - 4	28-12	
22 (FBS) / 17.5 (FBRS)				
IEC	UL / CUL	CSA	Ex	
800	600	600	550	
Nominal current / cross section	[A] / [mm ²]	24 / 2.5	20 / -	20.5 / 2.5

Ordering data			
Type	Order No.	Pcs./Pkt.	
STS 2,5-QUATTRO	① 3031746	50	
STS 2,5-QUATTRO BU	① 3036288	50	
STS 2,5-QUATTRO-PE	② 3031759	50	

Accessories ¹⁾		
D-ST5 2,5	3031762	50

Dimensions	[mm]
Maximum electrical data	
Maximum bridge current	[A]
Rated data	
Rated voltage	[V]
Nominal current / cross section	[A] / [mm ²]
Description	Color
Terminal block	gray
With potential distribution	gray
	blue
Ground terminal	green-yellow
Cover, width: 2.2 mm	gray

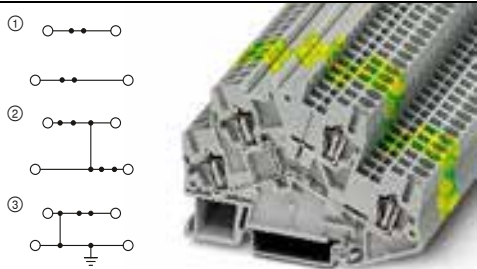

26 A, double-level terminal block

Ex: EAC Ex IEC Ex
 PTB 07ATEX1027U / IECEx PTB 07.0024U

Technical data ¹⁾				
Width	Length	Height		
5.2	78	55 (NS 35/7,5)		
<i>I</i> _{max.} [A]	<i>U</i> _{max.} [V]	max. Ø [mm ²]	AWG (UL)	
26	500	0.08 - 4	28-12	
22 (FBS) / 17.5 (FBRS)				
IEC	UL / CUL	CSA	Ex	
500	600	300	440	
Nominal current / cross section	[A] / [mm ²]	22 / 2.5	20 / -	19.5 / 2.5

Ordering data			
Type	Order No.	Pcs./Pkt.	
STTBS 2,5	① 3038464	50	
STTBS 2,5 BU	① 3038493	50	
STTBS 2,5-PV	② 3038477	50	
STTBS 2,5-PV BU	② 3035289	50	
STTBS 2,5-PE	③ 3038480	50	

Accessories ¹⁾		
D-STTBS 2,5	3038503	50

Terminal blocks – CLIPLINE complete

2.5 mm² ST spring-cage connection terminal blocks

Desk-design disconnect and knife disconnect terminal blocks

- Notes:**
 1) For additional accessories and technical data, see page 210.
 2) Current and voltage are determined by the plug used.



20 A, disconnect terminal block

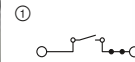

20 A, knife disconnect terminal block



		Technical data ¹⁾			
Dimensions	[mm]	Width	Length	Height	
		5.2	50.8	43 (NS 35/7,5)	
Maximum electrical data		I_{max} [A]	U_{max} [V]	max. Ø [mm ²]	AWG (UL)
		20 ²⁾	400 ²⁾	0.08 - 4	28-12
Maximum bridge current	[A]	16 (FBS) / 16 (FBSR)			
Rated data		IEC	UL / CUL	CSA	Ex
Rated voltage	[V]	400 ²⁾	300	300	-
Nominal current / cross section	[A] / [mm ²]	20 ²⁾ / 2.5	16 / -	16 / -	- / -
		Ordering data			
Description	Color	Type	Order No.	Pcs./Pkt.	
Terminal block	gray blue	STS 2,5-TG	3037009	50	
		Accessories ¹⁾			
Cover, width: 2.2 mm	gray	D-ST5 2,5	3031762	50	

		Technical data ¹⁾			
Dimensions	[mm]	Width	Length	Height	
		5.2	50.8	43 (NS 35/7,5)	
Maximum electrical data		I_{max} [A]	U_{max} [V]	max. Ø [mm ²]	AWG (UL)
		20	400	0.08 - 4	28-12
Maximum bridge current	[A]	16 (FBS) / 16 (FBSR)			
Rated data		IEC	UL / CUL	CSA	Ex
Rated voltage	[V]	400	300	300	-
Nominal current / cross section	[A] / [mm ²]	20 / 2.5	16 / -	16 / -	- / -
		Ordering data			
Description	Color	Type	Order No.	Pcs./Pkt.	
Terminal block	gray blue	STS 2,5-MT STS 2,5-MT BU	3036990 3035425	50	
		Accessories ¹⁾			
Cover, width: 2.2 mm	gray	D-ST5 2,5	3031762	50	

Feed-through, multi-conductor, and ground terminal blocks

- Notes:**
 1) For additional accessories and technical data, see page 210.
 For information on installation and using accessories for Ex applications, see page 678.

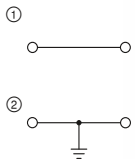

30 A, feed-through terminal block



30 A, feed-through terminal block, 4 connections



		Technical data ¹⁾			
Dimensions	[mm]	Width	Length	Height	
		5.2	32	30 (NS 15)	
Maximum electrical data		I_{max} [A]	U_{max} [V]	max. Ø [mm ²]	AWG (UL)
		30	800	0.08 - 4	28-12
Maximum bridge current	[A]	-			
Rated data		IEC	UL / CUL	CSA	Ex
Rated voltage	[V]	800	600	600	690
Nominal current / cross section	[A] / [mm ²]	24 / 2.5	20 / -	20 / -	21 / 2.5
General data		Stripping length			
	[mm]	8			
		Ordering data			
Description	No. of pos.	Color	Type	Order No.	Pcs./Pkt.
Terminal block		gray blue	MSB 2,5 MSB 2,5 BU	3244012 3244025	50
Ground terminal		green-yellow	MSB 2,5-PE	3244151	50
		Accessories ¹⁾			
Cover, 4 mm width	gray	D-MZB 1,5	3024177	50	
Insertion bridge, fully insulated	2			gray	

		Technical data ¹⁾			
Dimensions	[mm]	Width	Length	Height	
		10.4	32	30 (NS 15)	
Maximum electrical data		I_{max} [A]	U_{max} [V]	max. Ø [mm ²]	AWG (UL)
		30	800	0.08 - 4	28-12
Maximum bridge current	[A]	24			
Rated data		IEC	UL / CUL	CSA	Ex
Rated voltage	[V]	800	600	600	690
Nominal current / cross section	[A] / [mm ²]	24 / 2.5	20 / -	20 / -	21 / 2.5
General data		Stripping length			
	[mm]	8			
		Ordering data			
Description	No. of pos.	Color	Type	Order No.	Pcs./Pkt.
Terminal block		gray blue	MSDB 2,5 MSDB 2,5 BU	3244216 3244229	50
Ground terminal		green-yellow			
		Accessories ¹⁾			
Cover, 4 mm width	gray	D-MZB 1,5	3024177	50	
Insertion bridge, fully insulated	2			gray	
		ESB 2-MZDB	24 A	3029703	10

Feed-through, multi-conductor, and ground terminal blocks

Notes:
 1) For additional accessories and technical data, see page 210.
 For information on installation and using accessories for Ex applications, see page 678.

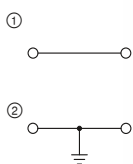

30 A, feed-through terminal block

Ex: EAC Ex IEC Ex
 PTB 08ATEX1075U / IECEx PTB 08.0048U

Technical data ¹⁾			
Width	Length	Height	
5.2	42.7	32 (NS 35/7,5)	
I _{max.} [A]	U _{max.} [V]	max. Ø [mm ²]	AWG (UL)
30	800	0.08 - 4	28-12
Maximum bridge current [A]			
-			
Rated data			
Rated voltage [V]	Nominal current / cross section [A] / [mm ²]		
800	600	600	690
24 / 2.5	20 / -	20 / -	21 / 2.5
General data			
Stripping length [mm]	8		

Ordering data			
Type	Order No.	Pcs./Pkt.	
MSB 2,5-NS 35	① 3244119	50	
MSB 2,5-NS 35 BU	① 3244122	50	
MSB 2,5-NS 35-PE	② 3244148	50	

Accessories ¹⁾		
Type	Order No.	Pcs./Pkt.
D-MZB 1,5	3024177	50

Dimensions		
Width	Length	Height
5.2	42.7	32 (NS 35/7,5)
Maximum electrical data		
I _{max.} [A]	U _{max.} [V]	max. Ø [mm ²]
30	800	0.08 - 4
Rated data		
Rated voltage [V]	Nominal current / cross section [A] / [mm ²]	
800	600	600
24 / 2.5	20 / -	20 / -
General data		
Stripping length [mm]	8	

Description	No. of pos.	Color
Terminal block		gray blue
Ground terminal		green-yellow

Cover, 4 mm width	gray
Insertion bridge, fully insulated	2 gray

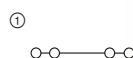

30 A, feed-through terminal block, 4 connections

Ex: EAC Ex IEC Ex
 PTB 08ATEX1075U / IECEx PTB 08.0048U

Technical data ¹⁾			
Width	Length	Height	
10.4	42.7	32 (NS 35/7,5)	
I _{max.} [A]	U _{max.} [V]	max. Ø [mm ²]	AWG (UL)
30	800	0.08 - 4	28-12
24	800	0.08 - 4	28-12
Rated data			
Rated voltage [V]	Nominal current / cross section [A] / [mm ²]		
800	600	600	690
24 / 2.5	20 / -	20 / -	21 / 2.5
General data			
Stripping length [mm]	8		

Ordering data			
Type	Order No.	Pcs./Pkt.	
MSDB 2,5-NS 35	① 3244300	50	
MSDB 2,5-NS 35 BU	① 3244313	50	

Accessories ¹⁾		
Type	Order No.	Pcs./Pkt.
D-MZB 1,5	3024177	50
ESB 2-MZDB	24 A 3029703	10

Feed-through and multi-conductor terminal blocks

Notes:
 1) For additional accessories and technical data, see page 210.
 For information on installation and using accessories for Ex applications, see page 678.



30 A, feed-through terminal block, for grouping

Ex: EAC Ex IEC Ex
 PTB 08ATEX1075U / IECEx PTB 08.0048U

Technical data ¹⁾			
Width	Length	Height	
5.2	32	22	
I _{max.} [A]	U _{max.} [V]	max. Ø [mm ²]	AWG (UL)
30	800	0.08 - 4	28-12
Rated data			
Rated voltage [V]	Nominal current / cross section [A] / [mm ²]		
800	600	600	550
24 / 2.5	20 / -	20 / -	22 / 2.5
General data			
Stripping length [mm]	8		

Ordering data			
Type	Order No.	Pcs./Pkt.	
MSB 2,5-M	① 3244067	50	
MSB 2,5-M BU	① 3244070	50	

Accessories ¹⁾		
Type	Order No.	Pcs./Pkt.
D-MZB 1,5	3024177	50

Dimensions		
Width	Length	Height
5.2	32	22
Maximum electrical data		
I _{max.} [A]	U _{max.} [V]	max. Ø [mm ²]
30	800	0.08 - 4
Rated data		
Rated voltage [V]	Nominal current / cross section [A] / [mm ²]	
800	600	600
24 / 2.5	20 / -	20 / -
General data		
Stripping length [mm]	8	

Description	Color
Terminal block	gray blue

Cover, 4 mm width	gray
-------------------	------

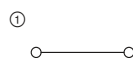

30 A, flange terminal block, for grouping

Ex: EAC Ex IEC Ex
 PTB 08ATEX1075U / IECEx PTB 08.0048U

Technical data ¹⁾			
Width	Length	Height	
5.2	32	22	
I _{max.} [A]	U _{max.} [V]	max. Ø [mm ²]	AWG (UL)
30	800	0.08 - 4	28-12
Rated data			
Rated voltage [V]	Nominal current / cross section [A] / [mm ²]		
800	600	600	550
24 / 2.5	20 / -	20 / -	22 / 2.5
General data			
Stripping length [mm]	8		

Ordering data			
Type	Order No.	Pcs./Pkt.	
MSB 2,5-F	① 3244041	50	
MSB 2,5-F BU	① 3244054	50	

Accessories ¹⁾		
Type	Order No.	Pcs./Pkt.
D-MSB 1,5-F	3024180	50

Terminal blocks – CLIPLINE complete

2.5 mm² ST spring-cage connection terminal blocks

Feed-through and multi-conductor terminal blocks

Notes:
 1) For additional accessories and technical data, see page 210.
 For information on installation and using accessories for Ex applications, see page 678.

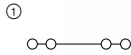

30 A, feed-through terminal block, for grouping, 4 connections



Ex: EAC Ex IEC Ex
 PTB 08ATEX1075U / IECEX PTB 08.0048U

Technical data¹⁾

Dimensions	[mm]
Width	10.4
Length	32
Height	22
Maximum electrical data	
I_{max} [A]	30
U_{max} [V]	800
max. Ø [mm ²]	0.08 - 4
AWG (UL)	28-12
Maximum bridge current	24 [A]
Rated data	
Rated voltage	800 [V]
Nominal current / cross section	24 / 2.5 [A] / [mm ²]
General data	
Stripping length	8 [mm]

Width	10.4	Length	32	Height	22
I_{max} [A]	30	U_{max} [V]	800	max. Ø [mm ²]	0.08 - 4
		AWG (UL)	28-12		
IEC	800	UL / CUL	600	CSA	600
		Ex	550		
			24 / 2.5		22 / 2.5

Ordering data

Description	No. of pos.	Color
Terminal block		gray blue

Type	Order No.	Pcs./Pkt.
MSDB 2,5-M	3244258	50
MSDB 2,5-M BU	3244261	50

Accessories¹⁾

Cover, 4 mm width	gray
Insertion bridge, fully insulated	2 gray

D-MZB 1,5	3024177	50
ESB 2-MZDB	24 A 3029703	10

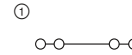

30 A, flange terminal block, 4 connections, for grouping



Ex: EAC Ex IEC Ex
 PTB 08ATEX1075U / IECEX PTB 08.0048U

Technical data¹⁾

Dimensions	[mm]
Width	10.4
Length	32
Height	22
Maximum electrical data	
I_{max} [A]	30
U_{max} [V]	800
max. Ø [mm ²]	0.08 - 4
AWG (UL)	28-12
Maximum bridge current	24 [A]
Rated data	
Rated voltage	800 [V]
Nominal current / cross section	24 / 2.5 [A] / [mm ²]
General data	
Stripping length	8 [mm]

Width	10.4	Length	32	Height	22
I_{max} [A]	30	U_{max} [V]	800	max. Ø [mm ²]	0.08 - 4
		AWG (UL)	28-12		
IEC	800	UL / CUL	600	CSA	600
		Ex	550		
			24 / 2.5		22 / 2.5

Ordering data

Description	No. of pos.	Color
Terminal block		gray blue

Type	Order No.	Pcs./Pkt.
MSDB 2,5-F	3244232	50
MSDB 2,5-F BU	3244245	50

Accessories¹⁾

D-MSB 1,5-F	3024180	50
ESB 2-MZDB	24 A 3029703	10

Feed-through and multi-conductor terminal blocks

Notes:
 1) For additional accessories and technical data, see page 210.
 For information on installation and using accessories for Ex applications, see page 678.

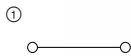

30 A, feed-through terminal block, with securing pin



Ex: EAC Ex IEC Ex
 PTB 08ATEX1075U / IECEX PTB 08.0048U

Technical data¹⁾

Dimensions	[mm]
Width	5.2
Length	32
Height	22
Maximum electrical data	
I_{max} [A]	30
U_{max} [V]	800
max. Ø [mm ²]	0.08 - 4
AWG (UL)	28-12
Maximum bridge current	- [A]
Rated data	
Rated voltage	800 [V]
Nominal current / cross section	24 / 2.5 [A] / [mm ²]
General data	
Stripping length	8 [mm]

Width	5.2	Length	32	Height	22
I_{max} [A]	30	U_{max} [V]	800	max. Ø [mm ²]	0.08 - 4
		AWG (UL)	28-12		
IEC	800	UL / CUL	600	CSA	600
		Ex	550		
			24 / 2.5		22 / 2.5

Ordering data

Description	No. of pos.	Color
Terminal block, for direct mounting		gray blue

Type	Order No.	Pcs./Pkt.
MSB 2,5-RZ	3244164	50
MSB 2,5-RZ BU	3244177	50

Accessories¹⁾

Cover, 4 mm width	gray
Insertion bridge, fully insulated	2 gray

D-MZB 1,5	3024177	50
ESB 2-MZDB	24 A 3029703	10

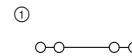

30 A, feed-through terminal block, 4 connections, with securing pin



Ex: EAC Ex IEC Ex
 PTB 08ATEX1075U / IECEX PTB 08.0048U

Technical data¹⁾

Dimensions	[mm]
Width	10.4
Length	32
Height	22
Maximum electrical data	
I_{max} [A]	30
U_{max} [V]	800
max. Ø [mm ²]	0.08 - 4
AWG (UL)	28-12
Maximum bridge current	24 [A]
Rated data	
Rated voltage	800 [V]
Nominal current / cross section	24 / 2.5 [A] / [mm ²]
General data	
Stripping length	8 [mm]

Width	10.4	Length	32	Height	22
I_{max} [A]	30	U_{max} [V]	800	max. Ø [mm ²]	0.08 - 4
		AWG (UL)	28-12		
IEC	800	UL / CUL	600	CSA	600
		Ex	550		
			24 / 2.5		22 / 2.5

Ordering data

Description	No. of pos.	Color
Terminal block		gray blue

Type	Order No.	Pcs./Pkt.
MSDB 2,5-RZ	3244339	50
MSDB 2,5-RZ BU	3244342	50

Accessories¹⁾

D-MZB 1,5	3024177	50
ESB 2-MZDB	24 A 3029703	10

Feed-through and multi-conductor terminal blocks

Notes:
1) For additional accessories and technical data, see page 210.

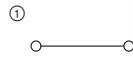

30 A, feed-through terminal block, lateral conductor entry



Technical data ¹⁾				
Dimensions	Width	Length	Height	
[mm]	5.2	32	30 (NS 15)	
Maximum electrical data	I_{max} [A]	U_{max} [V]	max. Ø [mm ²]	AWG (UL)
	30	800	0.08 - 4	28-12
Maximum bridge current	[A]	-		
Rated data	IEC	UL / CUL	CSA	Ex
Rated voltage	800	600	600	-
Nominal current / cross section	[A] / [mm ²]	24 / 2.5	20 / -	20 / -
General data				
Stripping length	[mm]	8		

Ordering data			
Type	Order No.	Pcs./Pkt.	
MSBV 2,5	3249017	50	①
MSBV 2,5 BU	3249020	50	①

Accessories ¹⁾		
Type	Order No.	Pcs./Pkt.
D-MSBV 2,5	3251018	50

Description	No. of pos.	Color
Terminal block		gray blue
Cover, 4 mm width		gray
Insertion bridge, fully insulated	2	gray

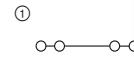

30 A, feed-through terminal block, lateral conductor entry, 4 connections



Technical data ¹⁾				
Dimensions	Width	Length	Height	
[mm]	10.4	32	30 (NS 15)	
Maximum electrical data	I_{max} [A]	U_{max} [V]	max. Ø [mm ²]	AWG (UL)
	30	800	0.08 - 4	28-12
Maximum bridge current	[A]	24		
Rated data	IEC	UL / CUL	CSA	Ex
Rated voltage	800	600	600	-
Nominal current / cross section	[A] / [mm ²]	24 / 2.5	20 / -	20 / -
General data				
Stripping length	[mm]	8		

Ordering data			
Type	Order No.	Pcs./Pkt.	
MSDBV 2,5	3249143	50	①
MSDBV 2,5 BU	3249156	50	①

Accessories ¹⁾		
Type	Order No.	Pcs./Pkt.
D-MSBV 2,5	3251018	50
ESB 2-MZDB	3029703	10

Feed-through and multi-conductor terminal blocks

Notes:
1) For additional accessories and technical data, see page 210.

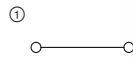

30 A, feed-through terminal block, lateral conductor entry



Technical data ¹⁾				
Dimensions	Width	Length	Height	
[mm]	5.2	42.7	32 (NS 35/7,5)	
Maximum electrical data	I_{max} [A]	U_{max} [V]	max. Ø [mm ²]	AWG (UL)
	30	800	0.08 - 4	28-12
Maximum bridge current	[A]	-		
Rated data	IEC	UL / CUL	CSA	Ex
Rated voltage	800	600	600	-
Nominal current / cross section	[A] / [mm ²]	24 / 2.5	20 / -	20 / -
General data				
Stripping length	[mm]	8		

Ordering data			
Type	Order No.	Pcs./Pkt.	
MSBV 2,5-NS 35	3249088	50	①
MSBV 2,5-NS 35 BU	3249091	50	①

Accessories ¹⁾		
Type	Order No.	Pcs./Pkt.
D-MSBV 2,5	3251018	50

Description	No. of pos.	Color
Terminal block		gray blue
Cover, 4 mm width		gray
Insertion bridge, fully insulated	2	gray

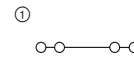

30 A, feed-through terminal block, lateral conductor entry, 4 connections



Technical data ¹⁾				
Dimensions	Width	Length	Height	
[mm]	10.4	42.7	32 (NS 35/7,5)	
Maximum electrical data	I_{max} [A]	U_{max} [V]	max. Ø [mm ²]	AWG (UL)
	30	800	0.08 - 4	28-12
Maximum bridge current	[A]	24		
Rated data	IEC	UL / CUL	CSA	Ex
Rated voltage	800	600	600	-
Nominal current / cross section	[A] / [mm ²]	24 / 2.5	20 / -	20 / -
General data				
Stripping length	[mm]	8		

Ordering data			
Type	Order No.	Pcs./Pkt.	
MSDBV 2,5-NS 35	3249211	50	①
MSDBV 2,5-NS 35 BU	3249224	50	①

Accessories ¹⁾		
Type	Order No.	Pcs./Pkt.
D-MSBV 2,5	3251018	50
ESB 2-MZDB	3029703	10

Terminal blocks – CLIPLINE complete

2.5 mm² ST spring-cage connection terminal blocks

Feed-through and multi-conductor terminal blocks

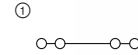

Notes:
 1) For additional accessories and technical data, see page 210.



30 A, feed-through terminal block, for grouping



30 A, feed-through terminal block, for grouping, 4 connections



		Technical data ¹⁾			
Dimensions		Width	Length	Height	
	[mm]	5.2	32	22	
Maximum electrical data		I_{max} [A]	U_{max} [V]	max. Ø [mm ²]	AWG (UL)
		30	800	0.08 - 4	28-12
Maximum bridge current	[A]	-			
Rated data		IEC	UL / CUL	CSA	Ex
Rated voltage	[V]	800	600	600	-
Nominal current / cross section	[A] / [mm ²]	24 / 2.5	20 / -	20 / -	- / -
General data					
Stripping length	[mm]	8			

		Technical data ¹⁾			
Dimensions		Width	Length	Height	
	[mm]	10.4	32	22	
Maximum electrical data		I_{max} [A]	U_{max} [V]	max. Ø [mm ²]	AWG (UL)
		30	800	0.08 - 4	28-12
Maximum bridge current	[A]	24			
Rated data		IEC	UL / CUL	CSA	Ex
Rated voltage	[V]	800	600	600	-
Nominal current / cross section	[A] / [mm ²]	24 / 2.5	20 / -	20 / -	- / -
General data					
Stripping length	[mm]	8			

			Ordering data		
Description	No. of pos.	Color	Type	Order No.	Pcs./Pkt.
Terminal block		gray	MSBV 2,5-M	3249062	50
		blue	MSBV 2,5-M BU	3249075	50

			Ordering data		
Description	No. of pos.	Color	Type	Order No.	Pcs./Pkt.
Terminal block		gray	MSDBV 2,5-M	3249198	50
		blue	MSDBV 2,5-M BU	3249208	50

			Accessories ¹⁾		
Cover, 4 mm width		gray	D-MSBV 2,5	3251018	50
Insertion bridge, fully insulated	2	gray			

			Accessories ¹⁾		
Cover, 4 mm width		gray	D-MSBV 2,5	3251018	50
Insertion bridge, fully insulated	24 A	gray	ESB 2-MZDB	3029703	10

Terminal blocks – CLIPLINE complete

4 mm² ST spring-cage connection terminal blocks

General technical data

Rated data	IEC 60947-7-1 / IEC 60947-7-2 / IEC 60947-7-3			
Rated cross section	[mm ²]	4		
Cross section range	AWG	28 - 10		
Connection capacity		Rigid	Flexible	Ferrule without/with plastic sleeve
1 conductor	[mm ²]	0.08 - 6	0.08 - 4	0.14 - 4 / 0.14 - 4
2 flexible conductors with a TWIN ferrule	[mm ²]	-	-	- / 0.5 - 1
General data				
Stripping length	[mm]	8 - 10		
Insulating material		PA		
Flammability rating in accordance with UL 94		VO		

Note: Additional or deviating data is listed alongside the respective product.

Notes:



In addition to the product, the internal electrical wiring is provided as a circuit diagram. Free connection points for bridging are indicated by a black dot.

The specified technical data and approvals refer to the first product in each column. For information on the products below, please refer to phoenixcontact.net/products

For full details of UL and CSA use groups, file nos., and Internet links, please visit phoenixcontact.net/products

¹⁾ The bridge current is listed alongside the respective product. For additional colors, see page 402.

System accessories

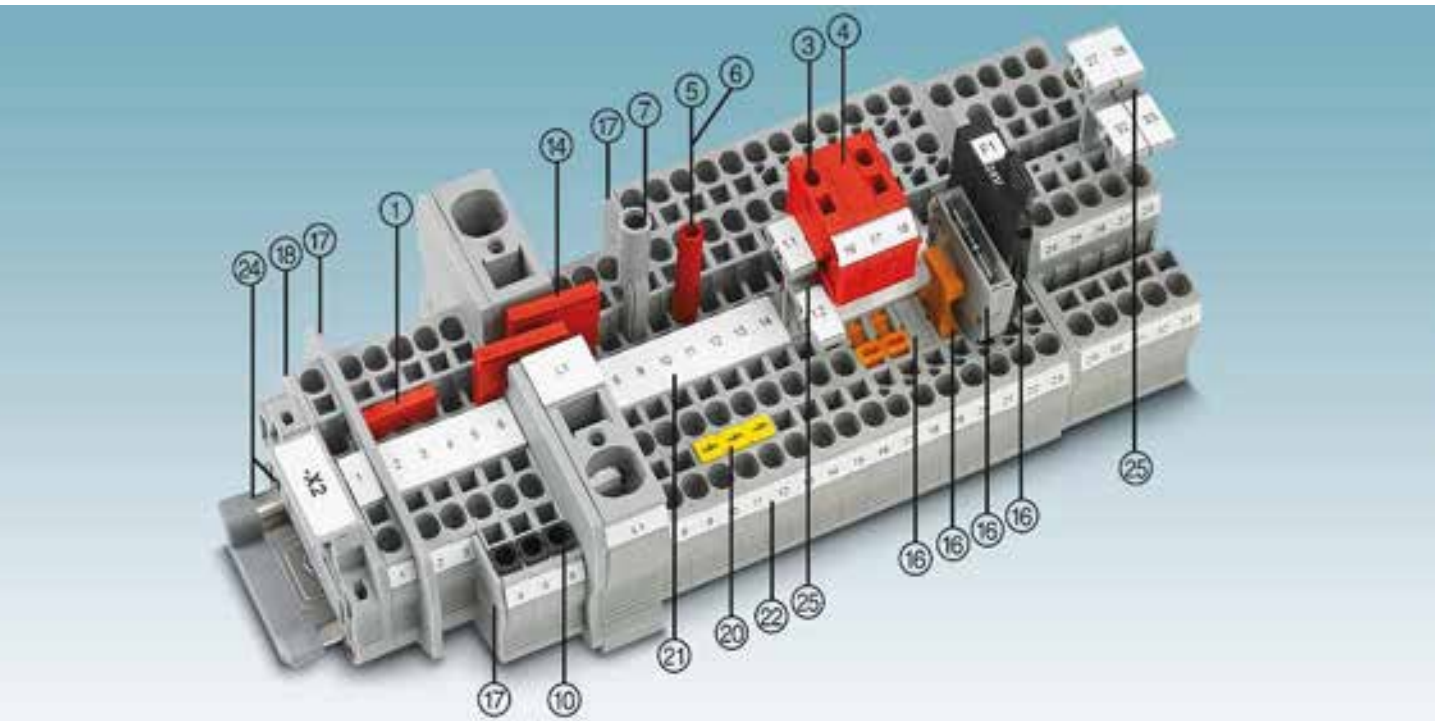

Description	No. of pos.	Color	Type	Order No.	Pcs./Pkt.	Type	Order No.	Pcs./Pkt.
① Bridge ¹⁾	2	red	FBS 2-6	3030336	50	FBSR 2-6	3033715	50
	3	red	FBS 3-6	3030242	50	FBSR 3-6	3001594	50
	4	red	FBS 4-6	3030255	50	FBSR 4-6	3001595	50
	5	red	FBS 5-6	3030349	50	FBSR 5-6	3001596	50
	10	red	FBS 10-6	3030271	10	FBSR 10-6	3033716	10
	20	red	FBS 20-6	3030365	10			
③ Modular test plug		red	PS-6	3030996	10			
④ Spacer plate		red	DP PS-6	3036738	10			
⑤ Test plug metal part		gray	MPS-MT	0201744	10			
⑥ Insulating sleeve, for MPS metal part		red	MPS-IH RD	0201676	10			
⑦ Test adapter, 4 mm socket hole		gray	PAI-4-N GY	3032871	10			
⑩ Insulating sleeve, 0.25 - 0.5 mm ² 0.75 - 1 mm ²		gray	ISH 4/0,5	3002885	50			
		black	ISH 4/1,0	3002898	50			
Screwdriver			SZF 1-0,6X3,5	1204517	10			
⑭ Reducing bridge	For RB ..., see page 408.							
⑮ Fuse and function plugs for disconnect terminal blocks	For P-FU ... / P-DI / P-FIX / P-CO ..., see from page 414.							
⑰ Partition plates/end cover segments	For ATP-... / DS-..., visit phoenixcontact.net/products							
⑱ Cover	Listed alongside the respective product.							
⑲ Warning labels	For WS ..., see page 420.							
⑳ Center groove labeling	UC-TM 6, UCT-TM 6 or ZB 6. See also Catalog 3, selection tables, from page 60.							
㉑ Center and side groove labeling	UC-TMF 6, UCT-TMF 6 or ZBF 6. See also Catalog 3, selection tables, from page 60.							
㉒ DIN rail and end bracket	See Catalog 3							
㉓ Marker carrier	For STP ..., see page 418.							
For full accessories, visit phoenixcontact.net/products	Note: Additional or deviating accessories are listed alongside the respective product.							

4 mm² ST spring-cage connection terminal blocks

Feed-through, multi-conductor, multi-level, and ground terminal blocks

Notes:
 1) For additional accessories and technical data, see page 228.
 For information on installation and using accessories for Ex applications, see page 678.



40 A, feed-through terminal block



Ex: EAC Ex IEC Ex
 KEMA 00ATEX2129U / IECEx KEM 06.0050U

Technical data¹⁾

Width	Length	Height		
6.2	56	36.5 (NS 35/7,5)		
I _{max} [A]	U _{max} [V]	max. Ø [mm ²]	AWG (UL)	
40	800	0.08 - 6	28-10	
32 (FBS) / 24 (FBSR)				
IEC	UL / CUL	CSA	Ex	
800	600	600	550	
Nominal current / cross section [A] / [mm ²]				
32 / 4		30 / -		30 / 4

Ordering data

Type	Order No.	Pcs./Pkt.
ST 4	3031364	50
ST 4 BU	3031377	50
ST 4-PE	3031380	50

Accessories¹⁾

D-ST 4	Order No.	Pcs./Pkt.
D-ST 4	3030420	50

Dimensions	[mm]
Maximum electrical data	
Maximum bridge current	[A]
Rated data	
Rated voltage	[V]
Nominal current / cross section	[A] / [mm ²]

Description	Color
Terminal block	gray
Ground terminal	green-yellow

Cover, width: 2.2 mm	gray
----------------------	------

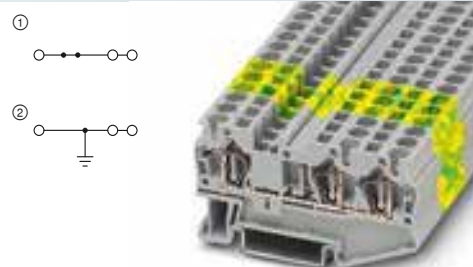

40 A, feed-through terminal block, 3 connections



Ex: EAC Ex IEC Ex
 KEMA 00ATEX2129U / IECEx KEM 06.0050U

Technical data¹⁾

Width	Length	Height		
6.2	71.5	36.5 (NS 35/7,5)		
I _{max} [A]	U _{max} [V]	max. Ø [mm ²]	AWG (UL)	
40	800	0.08 - 6	28-10	
32 (FBS) / 24 (FBSR)				
IEC	UL / CUL	CSA	Ex	
800	600	600	550	
Nominal current / cross section [A] / [mm ²]				
32 / 4		30 / -		30 / 4

Ordering data

Type	Order No.	Pcs./Pkt.
ST 4-TWIN	3031393	50
ST 4-TWIN BU	3031403	50
ST 4-TWIN-PE	3031416	50

Accessories¹⁾

D-ST 4-TWIN	Order No.	Pcs./Pkt.
D-ST 4-TWIN	3030491	50

Feed-through, multi-conductor, multi-level, and ground terminal blocks

Notes:
 1) For additional accessories and technical data, see page 228.
 For information on installation and using accessories for Ex applications, see page 678.

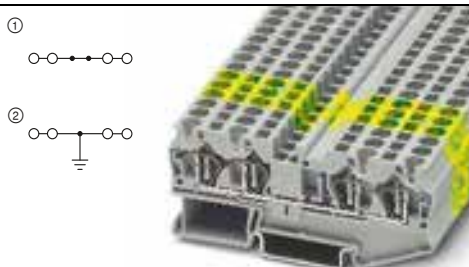

40 A, feed-through terminal block, 4 connections



Ex: EAC Ex IEC Ex
 KEMA 00ATEX2129U / IECEx KEM 06.0050U

Technical data¹⁾

Width	Length	Height		
6.2	87	36.5 (NS 35/7,5)		
I _{max} [A]	U _{max} [V]	max. Ø [mm ²]	AWG (UL)	
40	800	0.08 - 6	28-10	
32 (FBS) / 24 (FBSR)				
IEC	UL / CUL	CSA	Ex	
800	600	600	550	
Nominal current / cross section [A] / [mm ²]				
32 / 4		30 / -		28.5 / 4

Ordering data

Type	Order No.	Pcs./Pkt.
ST 4-QUATTRO	3031445	50
ST 4-QUATTRO BU	3031458	50
ST 4-QUATTRO-PE	3031461	50

Accessories¹⁾

D-ST 4-QUATTRO	Order No.	Pcs./Pkt.
D-ST 4-QUATTRO	3030527	50

Dimensions	[mm]
Maximum electrical data	
Maximum bridge current	[A]
Rated data	
Rated voltage	[V]
Nominal current / cross section	[A] / [mm ²]

Description	Color
Terminal block	gray
Ground terminal	green-yellow

Cover, width: 2.2 mm	gray
----------------------	------



37 A, feed-through terminal block, 4 connections, with interrupted current bar



Technical data¹⁾

Width	Length	Height		
6.2	87	36.5 (NS 35/7,5)		
I _{max} [A]	U _{max} [V]	max. Ø [mm ²]	AWG (UL)	
37	800	0.08 - 6	28-10	
32 (FBS) / 24 (FBSR)				
IEC	UL / CUL	CSA	Ex	
800	600	-	-	
Nominal current / cross section [A] / [mm ²]				
28 / 4		30 / -		- / -

Ordering data

Type	Order No.	Pcs./Pkt.
ST 4-QUATTRO-U	3038639	50

Accessories¹⁾

D-ST 4-QUATTRO	Order No.	Pcs./Pkt.
D-ST 4-QUATTRO	3030527	50

Terminal blocks – CLIPLINE complete

4 mm² ST spring-cage connection terminal blocks

Feed-through, multi-conductor, multi-level, and ground terminal blocks

Notes:
 1) For additional accessories and technical data, see page 228.
 For information on installation and using accessories for Ex applications, see page 678.

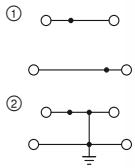

32 A, double-level terminal block

Ex: EAC Ex IEC CB
 KEMA 00ATEX2129U / IECEx KEM 06.0050U

Technical data¹⁾

Dimensions	[mm]
Width	6.2
Length	83.5
Height	47.5 (NS 35/7,5)

Maximum electrical data	[A]
Maximum bridge current	32
Rated data	26 (FBS) / 24 (FBSR)
Rated voltage	500
Nominal current / cross section	30 / 4

Rated data	[V]
Rated voltage	500
Nominal current / cross section	30 / 4

Width	Length	Height
6.2	83.5	47.5 (NS 35/7,5)

I _{max.} [A]	U _{max.} [V]	max. Ø [mm ²]	AWG (UL)
32	500	0.08 - 6	28-10

IEC	UL / CUL	CSA	Ex
26 (FBS) / 24 (FBSR)	UL / CUL	300	440
30 / 4	30 / -	30 / -	26.5 / 4

Ordering data

Description	Color
Terminal block	gray blue gray
Ground terminal	green-yellow

Type	Order No.	Pcs./Pkt.
STTB 4	3031429	50
STTB 4 BU	3031432	50
STTB 4-PE	3036039	50

Accessories ¹⁾		
D-STTB 4	3030462	50

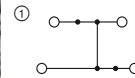

32 A, double-level terminal block, with equipotential bonding

Ex: EAC Ex IEC CB
 KEMA 00ATEX2129U / IECEx KEM 06.0050U

Technical data¹⁾

Width	Length	Height
6.2	83.5	47.5 (NS 35/7,5)

I _{max.} [A]	U _{max.} [V]	max. Ø [mm ²]	AWG (UL)
32	500	0.08 - 6	28-10

IEC	UL / CUL	CSA	Ex
22 (FBS) / 22 (FBSR)	UL / CUL	300	440
30 / 4	30 / -	30 / -	26.5 / 4

Ordering data

Type	Order No.	Pcs./Pkt.
STTB 4-PV	3031542	50

Accessories ¹⁾		
D-STTB 4	3030462	50

Multi-level terminal blocks

Notes:
 1) For additional accessories and technical data, see page 228.

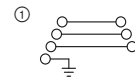

32 A, four-level terminal block with PE foot

Technical data¹⁾

Dimensions	[mm]
Width	6.2
Length	101
Height	83.5 (NS 35/7,5)

Maximum electrical data	[A]
Maximum bridge current	32
Rated data	28 (FBS) / 24 (FBSR)
Rated voltage	800
Nominal current / cross section	28 / 4

Rated data	[V]
Rated voltage	800
Nominal current / cross section	28 / 4

Width	Length	Height
6.2	101	83.5 (NS 35/7,5)

I _{max.} [A]	U _{max.} [V]	max. Ø [mm ²]	AWG (UL)
32	800	0.08 - 6	28-10

IEC	UL / CUL	CSA	Ex
28 (FBS) / 24 (FBSR)	UL / CUL	300	440
28 / 4	30 / -	30 / -	- / -

Ordering data

Description	Color
Terminal block	gray

Type	Order No.	Pcs./Pkt.
ST 4-PE/3L	3038338	50

Type	Order No.	Pcs./Pkt.
ST 4-PE/3L	3038338	50

Fuse terminal blocks and lever-type disconnect terminal blocks of the same shape

Notes:
1) For additional accessories and technical data, see page 228.
2) If the fuse is faulty, the downstream circuit is not off load.
3) The current is determined by the fuse used, the voltage by the selected LED display. Observe the maximum power dissipation, see phoenixcontact.net/products.
For the derating curve, see phoenixcontact.net/products

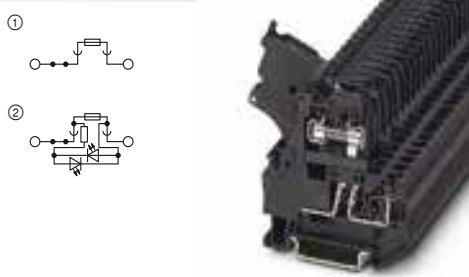

6.3 A, lever-type fuse terminal block for 5 x 20 mm cartridge fuses



Technical data ¹⁾				
Width	Length	Height		
6.2	61.5	62.5 (NS 35/7,5)		
I _{max} [A]	U _{max} [V]	max. Ø [mm ²]	AWG (UL)	
6.3 ³⁾	500 ³⁾	0.08 - 6	28-10	
32 (FBS) / 24 (FBSR)				
IEC	UL / CUL	CSA	Ex	
500 ³⁾	300	300	-	
Nominal current / cross section [A] / [mm ²]				
6.3 ³⁾ / 1 10 / - 6.3 / - - / -				

Ordering data			
Type	Order No.	Pcs./Pkt.	
ST 4-HESI (5X20)	① 3036369	50	
ST 4-HESILED 24 (5X20)	② 3036547	50	
30 ... 60 V AC/DC, 0.40 ... 0.86 mA ²⁾	② 3036550	50	
110 ... 250 V AC/DC, 0.41 ... 0.96 mA ²⁾	② 3036563	50	
Disconnect terminal block			



20 A, lever-type disconnect terminal block, same shape



Technical data ¹⁾			
Width	Length	Height	
6.2	61.5	62.5 (NS 35/7,5)	
I _{max} [A]	U _{max} [V]	max. Ø [mm ²]	AWG (UL)
20	500	0.08 - 6	-
32 (FBS) / 24 (FBSR)			
IEC	UL / CUL	CSA	Ex
500	-	-	-
Nominal current / cross section [A] / [mm ²]			
20 / 2.5 - / - - / - - / -			

Ordering data		
Type	Order No.	Pcs./Pkt.
ST 4-HEDI	① 3035140	50

Fuse terminal blocks

Notes:
1) For additional accessories and technical data, see page 228.
2) If the fuse is faulty, the downstream circuit is not off load.
3) For derating curve, visit phoenixcontact.net/products
4) The current is determined by the fuse used, the voltage by the selected LED display. Observe the maximum power dissipation, see phoenixcontact.net/products.
The recommended continuous load capacity of the fuse inserts in accordance with DIN 72581/Part 3 is max. 80 percent of their nominal current (at an ambient temperature of 23°C)
You can find a selection of matching thermal TCP circuit breakers in Catalog 4.

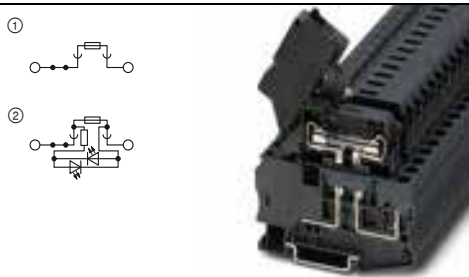

10 A, lever-type fuse terminal block for 6.3 x 32 mm cartridge fuses



Technical data ¹⁾				
Width	Length	Height		
8.2	76.5	69 (NS 35/7,5)		
I _{max} [A]	U _{max} [V]	max. Ø [mm ²]	AWG (UL)	
10 ⁴⁾	400	0.08 - 6	28-10	
41 (FBS) / 32 (FBSR)				
IEC	UL / CUL	CSA	Ex	
400	300	300	-	
Nominal current / cross section [A] / [mm ²]				
10 ⁴⁾ / 1.5 15 / - 10 / - - / -				

Ordering data			
Type	Order No.	Pcs./Pkt.	
ST 4-HESI (6,3X32)	① 3036385	50	
ST 4-HESILED 24 (6,3X32)	② 3038765	50	
110 ... 250 V AC/DC, 0.41 ... 0.96 mA ²⁾	② 3038778	50	
Fuse terminal block, for flat-type fuses			
with LED display for 12 V DC, 1.7 mA ²⁾			
with LED display for 24 V DC, 1.9 mA ²⁾			

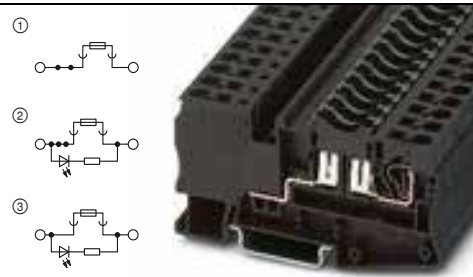

30 A, fuse terminal block for type C flat-type fuses



Technical data ¹⁾			
Width	Length	Height	
8.2	86.5	43.5 (NS 35/7,5)	
I _{max} [A]	U _{max} [V]	max. Ø [mm ²]	AWG (UL)
30 ³⁾	400 ⁴⁾	0.08 - 6	28-10
41 (FBS) / 32 (FBSR)			
IEC	UL / CUL	CSA	Ex
400 ⁴⁾	300	300	-
Nominal current / cross section [A] / [mm ²]			
30 ³⁾ / 4 30 / - 10 / - - / -			

Ordering data		
Type	Order No.	Pcs./Pkt.
ST 4-FSI/C	① 3036372	50
ST 4-FSI/C-LED 12	② 3036495	50
ST 4-FSI/C-LED 24	③ 3036505	50

Terminal blocks – CLIPLINE complete

4 mm² ST spring-cage connection terminal blocks

Disconnect and knife disconnect terminal blocks

Notes:
 1) For additional accessories and technical data, see page 228.
 2) Current and voltage are determined by the plug used.

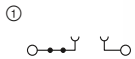

20 A, disconnect terminal block

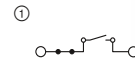

20 A, knife disconnect terminal block



Technical data ¹⁾				
Dimensions	Width	Length	Height	
[mm]	6.2	61.5	36.5 (NS 35/7,5)	
Maximum electrical data	I _{max.} [A]	U _{max.} [V]	max. Ø [mm ²]	AWG (UL)
	20 ²⁾	500 ²⁾	0.08 - 6	28-10
Maximum bridge current	20 (FBS) / 20 (FBSR)			
Rated data	IEC	UL / CUL	CSA	Ex
Rated voltage	500 ²⁾	300	300	-
Nominal current / cross section	20 ²⁾ / 2.5	10 / -	16 / -	- / -

Ordering data			
Description	Type	Order No.	Pcs./Pkt.
Disconnect terminal block	ST 4-TG	3038367	50
Knife disconnect terminal block			



Technical data ¹⁾				
Dimensions	Width	Length	Height	
[mm]	6.2	61.5	36.5 (NS 35/7,5)	
Maximum electrical data	I _{max.} [A]	U _{max.} [V]	max. Ø [mm ²]	AWG (UL)
	20	400	0.08 - 6	28-10
Maximum bridge current	20 (FBS) / 20 (FBSR)			
Rated data	IEC	UL / CUL	CSA	Ex
Rated voltage	400	300	300	-
Nominal current / cross section	20 / 2.5	10 / -	16 / -	- / -

Ordering data			
Description	Type	Order No.	Pcs./Pkt.
Knife disconnect terminal block	ST 4-MT	3038875	50

Diode terminal blocks

Notes:
 1) For additional accessories and technical data, see page 228.

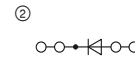
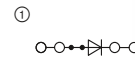

1.5 A, diode terminal block,
 1N 5408 (1000 V/1.5 A), 4 connections



Dimensions	
[mm]	6.2
Maximum electrical data	1.5
Maximum bridge current	15 (FBS) / 15 (FBSR)
Rated data	800
Rated voltage	1000
Nominal current / cross section	1.5 / 1

Description	Type	Order No.	Pcs./Pkt.
Terminal block, for conducting direction see circuit diagram	ST 4-QUATTRO-DIO 1N 5408/L-R	3037782	50
	ST 4-QUATTRO-DIO 1N 5408/R-L	3037795	50

Cover, width: 2.2 mm	D-ST 4-QUATTRO	3030527	50
----------------------	----------------	---------	----

Technical data ¹⁾				
Dimensions	Width	Length	Height	
[mm]	6.2	87	36.5 (NS 35/7,5)	
Maximum electrical data	I _{max.} [A]	U _{max.} [V]	max. Ø [mm ²]	AWG (UL)
	1.5	800	0.08 - 6	-
Maximum bridge current	15 (FBS) / 15 (FBSR)			
Rated data	IEC	UL / CUL	CSA	Ex
Rated voltage	800	-	-	-
Nominal current / cross section	1.5 / 1	- / -	- / -	- / -

Ordering data			
Description	Type	Order No.	Pcs./Pkt.
Diode terminal block	ST 4-QUATTRO-DIO 1N 5408/L-R	3037782	50
	ST 4-QUATTRO-DIO 1N 5408/R-L	3037795	50

Accessories ¹⁾			
Cover, width: 2.2 mm	D-ST 4-QUATTRO	3030527	50

Hybrid terminal blocks with screw connection on one side, 4 (6) mm²

Notes:
 1) For additional accessories and technical data, see page 228.
 2) For screw connection rated data, see page 158.

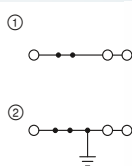

38 A, feed-through terminal block, 3 connections



Technical data ¹⁾				
Width	Length	Height		
6.2	74.4	42.8 (NS 35/7,5)		
I_{max} [A]	U_{max} [V]	max. Ø [mm ²]	AWG (UL)	
38	800	0.08 - 6	28-10	
32 (FBS) / 24 (FBSR)				
IEC	UL / CUL	CSA	Ex	
800	600	600	-	
Nominal current / cross section	[A] / [mm ²]	30 / -	30 / -	- / -
Cross section range	AWG	26 - 10	-	-

Ordering data			
Type	Order No.	Pcs./Pkt.	
STU 4-TWIN	① 3033058	50	
STU 4-TWIN BU	① 3033061	50	
STU 4-TWIN-PE	② 3033074	50	

Accessories ¹⁾		
D-STU 4-TWIN	3033087	50

Dimensions	[mm]
Maximum electrical data	
Maximum bridge current	[A]
Rated data ²⁾	
Rated voltage	[V]
Nominal current / cross section	[A] / [mm ²]
Cross section range	AWG
Description	Color
Terminal block	gray blue
With potential distribution	gray
Ground terminal	green-yellow
Cover, width: 2.2 mm	gray

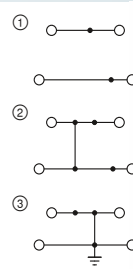

36 A, double-level terminal block



Technical data ¹⁾			
Width	Length	Height	
6.2	81	55.5 (NS 35/7,5)	
I_{max} [A]	U_{max} [V]	max. Ø [mm ²]	AWG (UL)
36	500	0.08 - 6	-
26 (FBS) / 24 (FBSR)			
IEC	UL / CUL	CSA	Ex
500	-	-	-
Nominal current / cross section	[A] / [mm ²]	- / -	- / -
Cross section range	AWG	28 - 10	-

Ordering data			
Type	Order No.	Pcs./Pkt.	
STTBU 4	① 3033155	50	
STTBU 4 BU	① 3033168	50	
STTBU 4-PV	② 3033184	50	
STTBU 4-PE	③ 3033171	50	

Accessories ¹⁾		
D-STTBU 4	3033207	50

Desk-design terminal blocks

Notes:
 1) For additional accessories and technical data, see page 228.
 For information on installation and using accessories for Ex applications, see page 678.

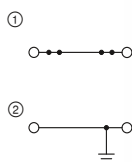

38 A, feed-through terminal block



Ex: EAC Ex IEC Ex
 PTB 07ATEX1027U / IECEx PTB 07.0024U

Technical data ¹⁾				
Width	Length	Height		
6.2	64.5	43 (NS 35/7,5)		
I_{max} [A]	U_{max} [V]	max. Ø [mm ²]	AWG (UL)	
38	800	0.08 - 6	28-10	
32 (FBS) / 24 (FBSR)				
IEC	UL / CUL	CSA	Ex	
800	600	600	550	
Nominal current / cross section	[A] / [mm ²]	30 / -	30 / -	28.5 / 4

Ordering data			
Type	Order No.	Pcs./Pkt.	
STS 4	① 3036424	50	
STS 4 BU	① 3036437	50	
STS 4-PE	② 3036440	50	

Accessories ¹⁾		
D-STS 4	3031704	50

Dimensions	[mm]
Maximum electrical data	
Maximum bridge current	[A]
Rated data	
Rated voltage	[V]
Nominal current / cross section	[A] / [mm ²]
Description	Color
Terminal block	gray blue
Ground terminal	green-yellow
Cover, width: 2.2 mm	gray

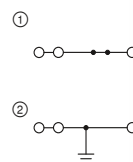

38 A, feed-through terminal block, 3 connections



Ex: EAC Ex IEC Ex
 PTB 07ATEX1027U / IECEx PTB 07.0024U

Technical data ¹⁾				
Width	Length	Height		
6.2	64.5	43 (NS 35/7,5)		
I_{max} [A]	U_{max} [V]	max. Ø [mm ²]	AWG (UL)	
38	800	0.08 - 6	28-10	
32 (FBS) / 24 (FBSR)				
IEC	UL / CUL	CSA	Ex	
800	600	600	550	
Nominal current / cross section	[A] / [mm ²]	30 / -	30 / -	30 / 4

Ordering data			
Type	Order No.	Pcs./Pkt.	
STS 4-TWIN	① 3031665	50	
STS 4-TWIN BU	① 3036291	50	
STS 4-TWIN-PE	② 3031678	50	

Accessories ¹⁾		
D-STS 4	3031704	50

Terminal blocks – CLIPLINE complete

4 mm² ST spring-cage connection terminal blocks

Desk-design terminal blocks

Notes:
 1) For additional accessories and technical data, see page 228.
 For information on installation and using accessories for Ex applications, see page 678.

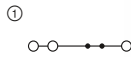

38 A, feed-through terminal block, 3 connections



Technical data ¹⁾				
Dimensions	Width	Length	Height	
[mm]	6.2	64.6	43 (NS 35/7,5)	
Maximum electrical data	$I_{max.}$ [A]	$U_{max.}$ [V]	max. Ø [mm ²]	AWG (UL)
	38	800	0.08 - 6	28-10
Maximum bridge current	32 (FBS) / 24 (FBSR) [A]			
Rated data	IEC	UL / CUL	CSA	Ex
Rated voltage	800	600	-	-
Nominal current / cross section	32 / 4	30 / -	- / -	- / -

Ordering data			
Type	Order No.	Pcs./Pkt.	
STS 4-TWIN/L	① 3036592	50	
STS 4-TWIN/L BU	① 3036589	50	

Accessories ¹⁾		
D-STBS 4-TWIN/L	Order No.	Pcs./Pkt.
D-STBS 4-TWIN/L	3036770	50

Description	Color
Terminal block	gray
Ground terminal	green-yellow

Cover, width: 2.2 mm gray



38 A, feed-through terminal block, 4 connections



Ex: EAC Ex IEC Ex
 PTB 07ATEX1027U / IECEx PTB 07.0024U

Technical data ¹⁾				
Dimensions	Width	Length	Height	
[mm]	6.2	64.5	43 (NS 35/7,5)	
Maximum electrical data	$I_{max.}$ [A]	$U_{max.}$ [V]	max. Ø [mm ²]	AWG (UL)
	38	800	0.08 - 6	28-10
Maximum bridge current	-			
Rated data	IEC	UL / CUL	CSA	Ex
Rated voltage	800	600	600	550
Nominal current / cross section	32 / 4	30 / -	30 / -	28.5 / 4

Ordering data			
Type	Order No.	Pcs./Pkt.	
STS 4-QUATTRO	① 3031681	50	
STS 4-QUATTRO BU	① 3036301	50	
STS 4-QUATTRO-PE	② 3031694	50	

Accessories ¹⁾		
D-STBS 4	Order No.	Pcs./Pkt.
D-STBS 4	3031704	50

Desk-design terminal blocks

Notes:
 1) For additional accessories and technical data, see page 228.

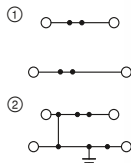

34 A, double-level terminal block



Technical data ¹⁾				
Dimensions	Width	Length	Height	
[mm]	6.2	92.4	55 (NS 35/7,5)	
Maximum electrical data	$I_{max.}$ [A]	$U_{max.}$ [V]	max. Ø [mm ²]	AWG (UL)
	34	500	0.08 - 6	28-10
Maximum bridge current	28 (FBS) / 24 (FBSR) [A]			
Rated data	IEC	UL / CUL	CSA	Ex
Rated voltage	500	600	600	-
Nominal current / cross section	28 / 4	30 / -	30 / -	- / -

Ordering data			
Type	Order No.	Pcs./Pkt.	
STTBS 4	① 3035056	50	
STTBS 4 BU	① 3035069	50	
STTBS 4-PE	② 3035072	50	

Accessories ¹⁾		
D-STTBS 4	Order No.	Pcs./Pkt.
D-STTBS 4	3035098	50

Description	Color
Terminal block	gray
With potential distribution	blue
Ground terminal	green-yellow

Cover, width: 2.2 mm gray

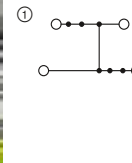

34 A, double-level terminal block, with equipotential bonding



Technical data ¹⁾				
Dimensions	Width	Length	Height	
[mm]	6.2	92.4	55 (NS 35/7,5)	
Maximum electrical data	$I_{max.}$ [A]	$U_{max.}$ [V]	max. Ø [mm ²]	AWG (UL)
	34	500	0.08 - 6	28-10
Maximum bridge current	28 (FBS) / 24 (FBSR) [A]			
Rated data	IEC	UL / CUL	CSA	Ex
Rated voltage	500	600	600	-
Nominal current / cross section	28 / 4	30 / -	30 / -	- / -

Ordering data			
Type	Order No.	Pcs./Pkt.	
STTBS 4-PV	① 3035085	50	

Accessories ¹⁾		
D-STTBS 4	Order No.	Pcs./Pkt.
D-STTBS 4	3035098	50

Desk-design disconnect and knife disconnect terminal blocks

Notes:
1) For additional accessories and technical data, see page 228.
2) Current and voltage are determined by the plug used.
3) Lower level

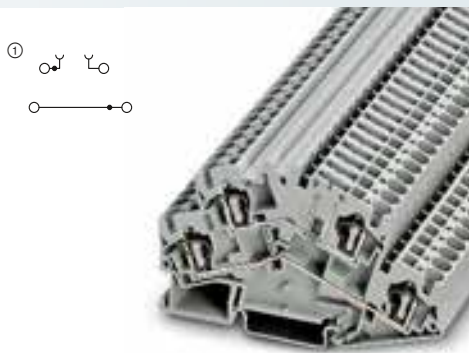

34 A, double-level terminal block with disconnect zone

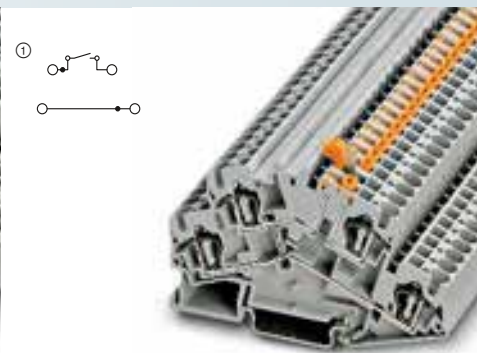

34 A, double-level knife disconnect terminal block



Technical data ¹⁾				
Width	Length	Height		
6.2	92.4	55 (NS 35/7,5)		
I _{max} [A]	U _{max} [V]	max. Ø [mm ²]	AWG (UL)	
34 ³⁾	500 ²⁾	0.08 - 6	28-10	
28 (FBS) / 24 (FBSR)				
Rated data	IEC	UL / CUL	CSA	Ex
Rated voltage [V]	500 ²⁾	600	-	-
Nominal current / cross section [A] / [mm ²]	28 ²⁾ / 2.5	16 / -	- / -	- / -
Nominal current / cross section [A] / [mm ²]	20 (disconnect level)			

Ordering data			
Description	Color	Type	Order No.
Disconnect terminal block	gray	STTBS 4-TG	3035483
Knife disconnect terminal block	gray blue		

Accessories ¹⁾			
Accessories	Order No.	Pcs./Pkt.	
Cover, width: 2.2 mm	D-STTBS 4-MT	3035548	50



Technical data ¹⁾				
Width	Length	Height		
6.2	92.4	55 (NS 35/7,5)		
I _{max} [A]	U _{max} [V]	max. Ø [mm ²]	AWG (UL)	
34 ³⁾	500	0.08 - 6	28-10	
28 (FBS) / 24 (FBSR)				
Rated data	IEC	UL / CUL	CSA	Ex
Rated voltage [V]	500	600	-	-
Nominal current / cross section [A] / [mm ²]	28 ²⁾ / 2.5	16 / -	- / -	- / -
Nominal current / cross section [A] / [mm ²]	20 (disconnect level)			

Ordering data			
Description	Color	Type	Order No.
Disconnect terminal block	gray	STTBS 4-MT	3035470
Knife disconnect terminal block	gray blue	STTBS 4-MT BU	3035522

Accessories ¹⁾			
Accessories	Order No.	Pcs./Pkt.	
Cover, width: 2.2 mm	D-STTBS 4-MT	3035548	50

Terminal blocks – CLIPLINE complete

6 mm² ST spring-cage connection terminal blocks

General technical data

Rated data	IEC 60947-7-1 / IEC 60947-7-2 / IEC 60947-7-3			
Rated cross section	[mm ²]	6		
Cross section range	AWG	24 - 8		
Connection capacity		Rigid	Flexible	Ferrule without/with plastic sleeve
1 conductor	[mm ²]	0.2 - 10	0.2 - 6	0.25 - 6 / 0.25 - 6
2 flexible conductors with a TWIN ferrule	[mm ²]	-	-	- / 0.5 - 1.5
General data				
Stripping length	[mm]	12		
Insulating material		PA		
Flammability rating in accordance with UL 94		VO		
Note: Additional or deviating data is listed alongside the respective product.				

Notes:



In addition to the product, the internal electrical wiring is provided as a circuit diagram. Free connection points for bridging are indicated by a black dot.

The specified technical data and approvals refer to the first product in each column. For information on the products below, please refer to phoenixcontact.net/products

For full details of UL and CSA use groups, file nos., and Internet links, please visit phoenixcontact.net/products

¹⁾ The bridge current is listed alongside the respective product. For additional colors, see page 402.

System accessories

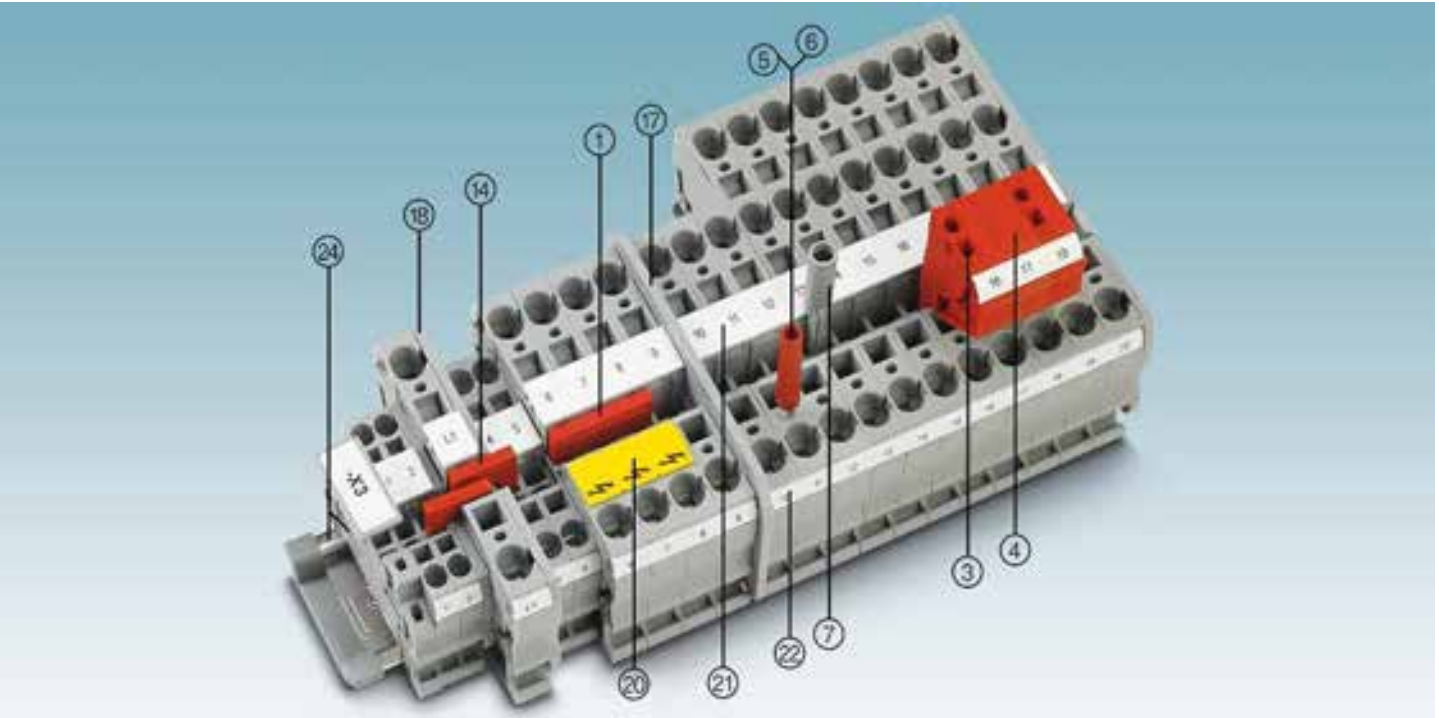

Description	No. of pos.	Color	Type	Order No.	Pcs./Pkt.	Type	Order No.	Pcs./Pkt.
① Bridge ¹⁾	2	red	FBS 2-8	3030284	10	FBSR 2-8	3033808	10
	3	red	FBS 3-8	3030297	10	FBSR 3-8	3001597	10
	4	red	FBS 4-8	3030307	10	FBSR 4-8	3000585	10
	5	red	FBS 5-8	3030310	10	FBSR 5-8	3033809	10
	10	red	FBS 10-8	3030323	10	FBSR 10-8	3001599	10
	16	red	FBS 16-8			FBSR 16-8	3033816	10
③ Modular test plug		red	PS-8	3031005	10			
④ Spacer plate		red	DP PS-8	3036741	10			
⑤ Test plug metal part		gray	MPS-MT	0201744	10			
⑥ Insulating sleeve, for MPS metal part		red	MPS-IH RD	0201676	10			
⑦ Test adapter, 4 mm socket hole		gray	PAI-4-N GY	3032871	10			
Screwdriver			SZF 2-0,8X4,0	1204520	10			

⑭ Reducing bridge	For RB ..., see page 408.
⑰ Partition plates/end cover segments	For ATP-... / DS-..., visit phoenixcontact.net/products
⑱ Cover	Listed alongside the respective product.
⑳ Warning labels	For WS ..., see page 420.
㉑ Center groove labeling	UC-TM 8, UCT-TM 8 or ZB 8. See also Catalog 3, selection tables, from page 60.
㉒ Center and side groove labeling	UC-TMF 8, UCT-TMF 8 or ZBF 8. See also Catalog 3, selection tables, from page 60.
㉓ DIN rail and end bracket	See Catalog 3
For full accessories, visit phoenixcontact.net/products	Note: Additional or deviating accessories are listed alongside the respective product.

Feed-through, multi-conductor, and ground terminal blocks

Notes:

1) For additional accessories and technical data, see page 236.

For information on installation and using accessories for Ex applications, see page 678.

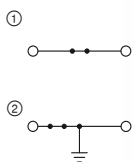

52 A, feed-through terminal block



Ex: EAC Ex IEC Ex
KEMA 00ATEX2129U / IECEx KEM 06.0050U

Technical data¹⁾

Dimensions	Width	Length	Height
[mm]	8.2	69.5	43.5 (NS 35/7,5)
Maximum electrical data	I_{max} [A]	U_{max} [V]	max. Ø [mm ²] AWG (UL)
	52	1000	0.2 - 10 24-8
Maximum bridge current	41 (FBS) / 32 (FBSR) [A]		
Rated data	IEC	UL / CUL	CSA Ex
Rated voltage	1000	600	600 550
Nominal current / cross section	41 / 6	50 / -	50 / - 36.5 / 6

Ordering data

Type	Order No.	Pcs./Pkt.
ST 6	3031487	50
ST 6 BU	3031490	50
ST 6-PE	3031500	50

Accessories¹⁾

Type	Order No.	Pcs./Pkt.
D-ST 6	3030433	50

Dimensions	Width	Length	Height
[mm]	8.2	69.5	43.5 (NS 35/7,5)
Maximum electrical data	I_{max} [A]	U_{max} [V]	max. Ø [mm ²] AWG (UL)
	52	1000	0.2 - 10 24-8
Maximum bridge current	41 (FBS) / 32 (FBSR) [A]		
Rated data	IEC	UL / CUL	CSA Ex
Rated voltage	1000	600	600 550
Nominal current / cross section	41 / 6	50 / -	50 / - 36.5 / 6

Description	Color
Terminal block	gray
Ground terminal	green-yellow

Cover, width: 2.2 mm	Color
	gray

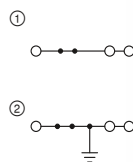

52 A, feed-through terminal block, 3 connections



Ex: EAC Ex IEC Ex
KEMA 00ATEX2129U / IECEx KEM 06.0050U

Technical data¹⁾

Dimensions	Width	Length	Height
[mm]	8.2	90.5	43.5 (NS 35/7,5)
Maximum electrical data	I_{max} [A]	U_{max} [V]	max. Ø [mm ²] AWG (UL)
	52	1000	0.2 - 10 24-8
Maximum bridge current	41 (FBS) / 32 (FBSR) [A]		
Rated data	IEC	UL / CUL	CSA Ex
Rated voltage	1000	600	600 550
Nominal current / cross section	41 / 6	50 / -	50 / - 36 / 6

Ordering data

Type	Order No.	Pcs./Pkt.
ST 6-TWIN	3036466	50
ST 6-TWIN BU	3036479	50
ST 6-TWIN-PE	3036482	50

Accessories¹⁾

Type	Order No.	Pcs./Pkt.
D-ST 6-TWIN	3036767	50

Test disconnect terminal blocks

Notes:

1) For additional accessories and technical data, see page 236.

– Rated voltage of 1000 V

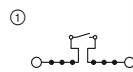

30 A, 1000 V, disconnect terminal block



Technical data¹⁾

Dimensions	Width	Length	Height
[mm]	8.2	100.8	49.6 (NS 35/7,5)
Maximum electrical data	I_{max} [A]	U_{max} [V]	max. Ø [mm ²] AWG (UL)
	30	1000	0.2 - 10 24-8
Maximum bridge current	30 (FBS) / 30 (FBSR) [A]		
Rated data	IEC	UL / CUL	CSA Ex
Rated voltage	1000	600	600 -
Nominal current / cross section	30 / 6	30 / -	30 / - - / -

Dimensions	Width	Length	Height
[mm]	8.2	100.8	49.6 (NS 35/7,5)
Maximum electrical data	I_{max} [A]	U_{max} [V]	max. Ø [mm ²] AWG (UL)
	30	1000	0.2 - 10 24-8
Maximum bridge current	30 (FBS) / 30 (FBSR) [A]		
Rated data	IEC	UL / CUL	CSA Ex
Rated voltage	1000	600	600 -
Nominal current / cross section	30 / 6	30 / -	30 / - - / -

Ordering data

Type	Order No.	Pcs./Pkt.
STME 6 HV	3035693	50
STME 6 HV BU	3035694	50

Type	Order No.	Pcs./Pkt.
STME 6 HV	3035693	50
STME 6 HV BU	3035694	50

Accessories¹⁾

Type	Order No.	Pcs./Pkt.
D-DTME 6	3034426	10

Type	Order No.	Pcs./Pkt.
D-DTME 6	3034426	10

Terminal blocks – CLIPLINE complete

6 mm² ST spring-cage connection terminal blocks

Test disconnect terminal blocks

Notes:
 1) For additional accessories and technical data, see page 236.



30 A, test disconnect terminal block

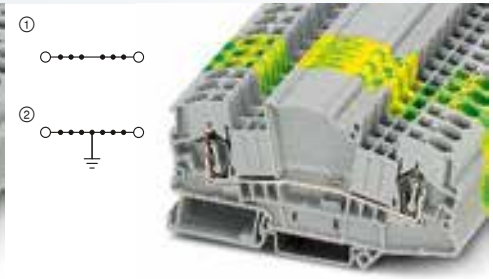

41 A, feed-through terminal block, same shape



Dimensions	[mm]
Maximum electrical data	
Maximum bridge current	[A]
Rated data	
Rated voltage	[V]
Nominal current / cross section	[A] / [mm ²]

Technical data ¹⁾			
Width	Length	Height	
8.2	100.8	49.6 (NS 35/7,5)	
I _{max.} [A]	U _{max.} [V]	max. Ø [mm ²]	AWG (UL)
30	500	0.2 - 10	24-8
30 (FBS) / 30 (FBSR)			
IEC	UL / CUL	CSA	Ex
500	600	600	-
30 / 6	30 / -	30 / -	- / -

Technical data ¹⁾			
Width	Length	Height	
8.2	100.8	49.6 (NS 35/7,5)	
I _{max.} [A]	U _{max.} [V]	max. Ø [mm ²]	AWG (UL)
41	1000	0.2 - 10	24-8
30 (FBS) / 30 (FBSR)			
IEC	UL / CUL	CSA	Ex
1000	600	600	-
41 / 6	30 / -	30 / -	- / -

Description	Color
Test disconnect terminal block	gray
Feed-through terminal block	gray
Ground terminal	green-yellow

Ordering data		
Type	Order No.	Pcs./Pkt.
STME 6	3035700	50

Ordering data		
Type	Order No.	Pcs./Pkt.
STMED 6	3035713	50
STMED 6-PE	3035726	50

Cover, width: 2.2 mm	gray
----------------------	------

Accessories ¹⁾		
D-DTME 6	3034426	10

Accessories ¹⁾		
D-DTME 6	3034426	10

Supplementary accessories for STME 6 test disconnect terminal blocks



- A current transformer measuring circuit can be created using just two STME 6
- Less space required compared to creating circuits with slide-type terminal blocks
- ① FBS... plug-in bridge for cross connection
- ② 4 mm Ø PAI-4-FIX... test plug adapter
- ③ S-ME 6 switching lock
- ④ SB-ME... bridge bar
- ⑤ C-ME 6/2 operating lever

Description	No. of pos.	Color
Test adapter, for 4-mm-Ø safety test connector, snapped into bridge shaft	1	orange
	1	yellow
	1	green
	1	violet
	1	black
	1	blue
	1	red
	1	gray
	1	brown
Switching lock, plug-in		white
Switching bridge, plug-in	2	gray/orange
	3	gray/orange
	4	gray/orange
Operating lever, for actuating 2 test disconnect terminal blocks	2	orange
	3	orange

Ordering data		
Type	Order No.	Pcs./Pkt.
PAI-4-FIX OG	3034455	10
PAI-4-FIX YE	3032745	10
PAI-4-FIX GN	3032758	10
PAI-4-FIX VT	3032761	10
PAI-4-FIX BK	3032774	10
PAI-4-FIX BU	3032729	10
PAI-4-FIX RD	3032732	10
PAI-4-FIX GY	3032790	10
PAI-4-FIX BN	3032787	10
S-ME 6	3034439	10
SB-ME 2-8	3034468	10
SB-ME 3-8	3032800	10
SB-ME 4-8	3034484	10
C-ME 6/2	3034442	10
C-ME 6/3	3034390	50

Diode terminal blocks

Notes:
1) For additional accessories and technical data, see page 236.
2) If the diode is loaded to 5 A, the surface reaches a temperature of +140°C.
3) 1000 V reverse voltage.
If several diode terminal blocks need adding to the DIN rail, a spacer plate must be placed between them.
Covers should ensure that the parts are not touched.



5 A, 1000 V, diode terminal block, same shape



Terminal block, for soldering a component



Technical data ¹⁾				
Width	Length	Height		
8.2	100.8	60 (NS 35/7,5)		
I_{max} [A]	U_{max} [V]	max. Ø [mm ²]	AWG (UL)	
5 ²⁾	1000 ³⁾	0.2 - 10	24-8	
41 (FBS) / 32 (FBSR)				
IEC	UL / CUL	CSA	Ex	
1000 ³⁾	600	-	-	
Nominal current / cross section	[A] / [mm ²]	5 / -	- / -	

Ordering data			
Type	Order No.	Pcs./Pkt.	
STME 6-DIO/L-R HV	① 3035691	50	
STME 6-DIO/R-L HV	② 3035692	50	

Accessories ¹⁾			
D-DTME 6	3034426	10	
DP-STMED 6	3035690	50	



Technical data ¹⁾				
Width	Length	Height		
8.2	100.8	60 (NS 35/7,5)		
I_{max} [A]	U_{max} [V]	max. Ø [mm ²]	AWG (UL)	
41 (FBS) / 32 (FBSR)	500	0.2 - 10	-	
IEC	UL / CUL	CSA	Ex	
500	-	-	-	
Nominal current / cross section	[A] / [mm ²]	30 / 6	- / -	

Ordering data			
Type	Order No.	Pcs./Pkt.	
STME 6-BE	① 3035688	50	

Accessories ¹⁾			
D-DTME 6	3034426	10	
DP-STMED 6	3035690	50	

Desk-design terminal blocks

Notes:
1) For additional accessories and technical data, see page 236.

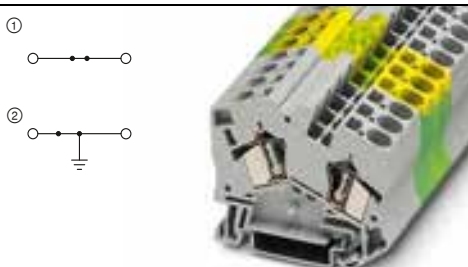

57 A, feed-through terminal block

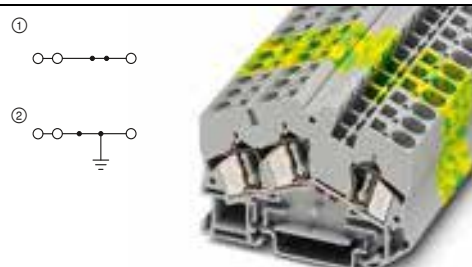

57 A, feed-through terminal block, 3 connections



Technical data ¹⁾				
Width	Length	Height		
8.2	58	50 (NS 35/7,5)		
I_{max} [A]	U_{max} [V]	max. Ø [mm ²]	AWG (UL)	
57	800	0.2 - 10	24-8	
41 (FBS) / 32 (FBSR)				
IEC	UL / CUL	CSA	Ex	
800	600	600	-	
Nominal current / cross section	[A] / [mm ²]	41 / 6	50 / -	

Ordering data			
Type	Order No.	Pcs./Pkt.	
STS 6	① 3038121	50	
STS 6 BU	① 3038134	50	
STS 6-PE	② 3038147	50	

Accessories ¹⁾			
D-ST5 6	3038189	50	



Technical data ¹⁾				
Width	Length	Height		
8.2	70	50 (NS 35/7,5)		
I_{max} [A]	U_{max} [V]	max. Ø [mm ²]	AWG (UL)	
57	800	0.2 - 10	24-8	
41 (FBS) / 32 (FBSR)				
IEC	UL / CUL	CSA	Ex	
800	600	600	-	
Nominal current / cross section	[A] / [mm ²]	41 / 6	50 / -	

Ordering data			
Type	Order No.	Pcs./Pkt.	
STS 6-TWIN	① 3038150	50	
STS 6-TWIN BU	① 3038163	50	
STS 6-TWIN-PE	② 3038176	50	

Accessories ¹⁾			
D-ST5 6-TWIN	3038202	50	

Terminal blocks – CLIPLINE complete

6 mm² ST spring-cage connection terminal blocks

Test disconnect terminal blocks



- The SRTK 6 measuring transducer disconnect terminal block and the SGSK 6 slide-type terminal block are specially designed for use in current transformer secondary circuits
- Only two SRTK 6 test disconnect terminal blocks are required for a current transformer measuring circuit
- Less space required compared to creating circuits with slide-type terminal blocks

- ① SB... switch bar
- ② 4 mm Ø test sockets PSBJ–URTK 6...
- ③ Fixed bridge for cross connection FBRI 10–8 N
- ④ Switching lock S–URTK/SP

Slide-type terminal blocks

- Several measuring devices or protective relays can be connected individually using the SGSK 6 slide-type terminal block
- The slide can be connected with the switch bar depending on the switching tasks

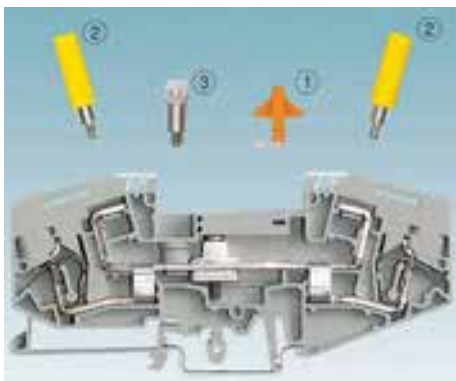

SGSK 6 slide-type terminal block

Notes:
For technical data, see page 236
S-URTK/SP switching lock can only be used with SRTK 6.

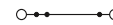

45 A, test disconnect terminal block



Dimensions	
	[mm]
Maximum electrical data	
Rated data	
Rated voltage	[V]
Nominal current / cross section	[A] / [mm ²]
Connection capacity	
1 conductor	[mm ²]
2 flexible conductors with a TWIN ferrule	[mm ²]
General data	
Disconnect slide: Thread / torque	- / [Nm]
Torque: Test socket, fixed bridge, switch bar	[Nm]

Technical data			
Width	Length	Height NS 35/7,5	
8.2	113	49	
I _{max} [A]	U _{max} [V]	max. Ø [mm ²]	AWG (UL)
45	400	0.2 - 10	18-8
IEC 60947-7-1			
IEC	UL / CUL	CSA	IEC/EN 60079-7
400	300	-	-
41 / 6	40 / -	-	-
Connection capacity		Ferrule	
Rigid	Flexible	without/with plastic sleeve	
0.2 - 10	0.2 - 6	0.25 - 6	0.25 - 6
-	-	-	0.5 - 1.5
General data		M3 / 0.6 - 0.8	
Disconnect slide: Thread / torque		-	
Torque: Test socket, fixed bridge, switch bar		0.6 - 0.8	

Description	No. of pos.	Color
Test disconnect terminal block		gray
Slide-type terminal block		gray
Feed-through terminal block		gray

Ordering data			
Type	I _{max}	Order No.	Pcs./Pkt.
SRTK 6		3029952	50
SGSK 6		3029965	50
SRDK 6		3029973	50

Accessories		
Cover, width: 2 mm		gray
Switching bridge, complete		
	2	orange
	3	orange
	4	orange
for bridging between non-adjacent terminals	10	orange
Fixed bridge, isolated		
	10	silver
Switching lock , excludes the possibility of an unintentional operation of the disconnect slide		
Test socket, insulated		
		white
		transparent
		blue
		yellow
		green
		violet
		black
		gray
		brown
		red
Short-circuit plug , for short circuiting neighboring terminal blocks, fully insulated, 2-pos.		black
4-pos.		black
Screwdriver		
Center groove labeling		

Accessories			
Type	I _{max}	Order No.	Pcs./Pkt.
D-SRTK 6		3029981	10
SB 2-8-T	41 A	3026366	10
SB 3-8-T	41 A	3026492	10
SB 4-8-T	41 A	3026379	10
SB 10-8-T SO	41 A	3026395	10
FBRI 10-8 N	41 A	2772080	10
S-URTK/SP		0311155	50
PSBJ-URTK 6 FARBLOS		3026450	10
PSBJ-URTK 6 BU		3026434	10
PSBJ-URTK 6 YE		3026405	10
PSBJ-URTK 6 GN		3026418	10
PSBJ-URTK 6 VT		3026421	10
PSBJ-URTK 6 BK		3026447	10
PSBJ-URTK 6 GY		3026612	10
PSBJ-URTK 6 BN		3026971	10
PSBJ-URTK 6 RD		3026719	10
KSSI 2-8		3000722	10
KSSI 4-8		3000735	10
SZF 2-0,8X4,0		1204520	10
UC-TM 8, UCT-TM 8 or ZB 8 (see Catalog 3)			

Terminal blocks – CLIPLINE complete

10 mm² ST spring-cage connection terminal blocks

General technical data

Rated data	IEC 60947-7-1 / IEC 60947-7-2			
Rated cross section	[mm ²]	10		
Cross section range	AWG	24 - 6		
Connection capacity		Rigid	Flexible	Ferrule without/with plastic sleeve
1 conductor	[mm ²]	0.2 - 16	0.2 - 10	0.25 - 10 0.25 - 10
2 flexible conductors with a TWIN ferrule	[mm ²]	-	-	- 1.5 - 2.5
General data				
Stripping length	[mm]	18		
Insulating material		PA		
Flammability rating in accordance with UL 94		VO		

Note: Additional or deviating data is listed alongside the respective product.

Notes:



In addition to the product, the internal electrical wiring is provided as a circuit diagram. Free connection points for bridging are indicated by a black dot.

The specified technical data and approvals refer to the first product in each column. For information on the products below, please refer to phoenixcontact.net/products

For full details of UL and CSA use groups, file nos., and Internet links, please visit phoenixcontact.net/products

¹⁾ The bridge current is listed alongside the respective product. For additional colors, see page 402.

System accessories

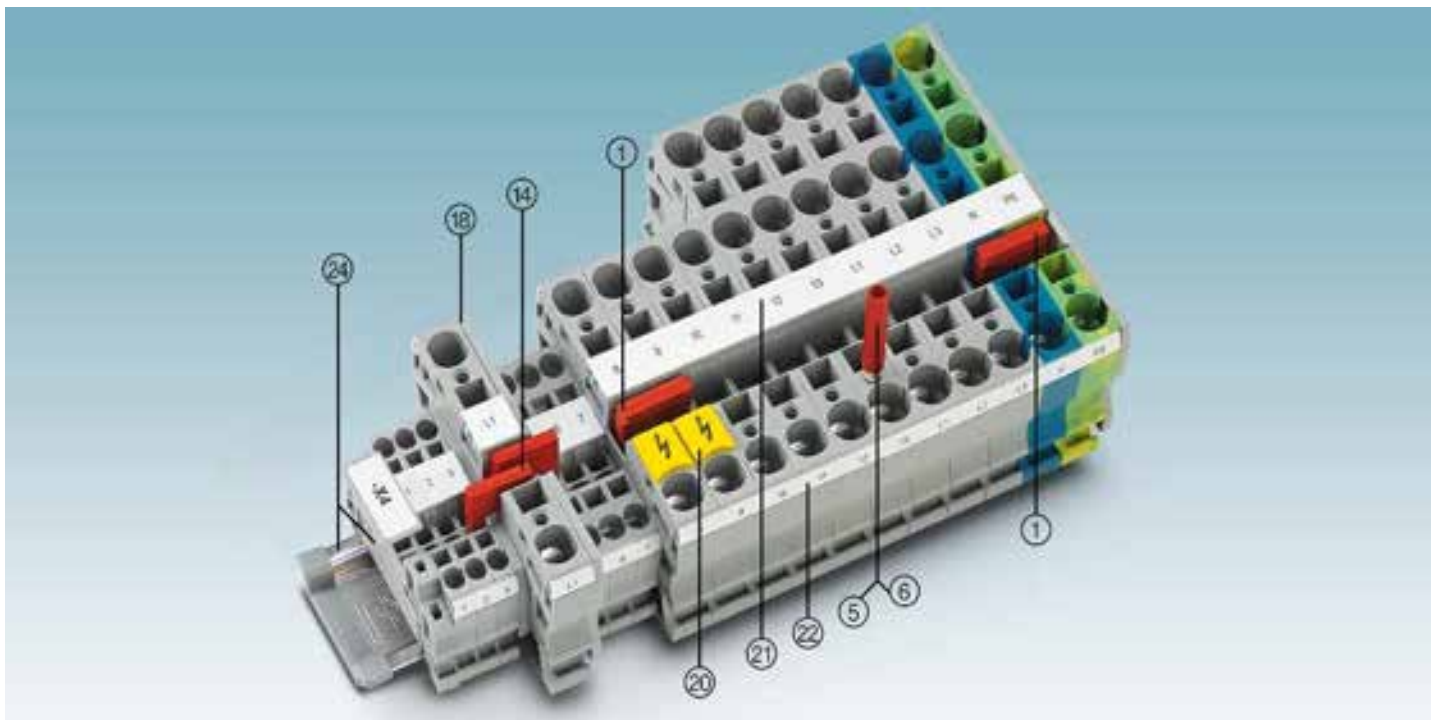

Description	No. of pos.	Color	Type	Order No.	Pcs./Pkt.	Type	Order No.	Pcs./Pkt.
① Bridge ¹⁾	2	red	FBS 2-10	3005947	10			
⑤ Test plug metal part		gray	MPS-MT	0201744	10			
⑥ Insulating sleeve, for MPS metal part		red	MPS-IH RD	0201676	10			
Screwdriver			SZF 3-1,0X5,5	1206612	10			
⑭ Reducing bridge			For RB ..., see page 408.					
⑮ Cover			Listed alongside the respective product.					
⑳ Warning labels			For WS ..., see page 420.					
㉑ Center groove labeling			UC-TM 10, UCT-TM 10 or ZB 10. See also Catalog 3, selection tables, from page 60.					
㉒ Center and side groove labeling			UC-TMF 10, UCT-TMF 10 or ZBF 10. See also Catalog 3, selection tables, from page 60.					
㉓ DIN rail and end bracket			See Catalog 3					
For full accessories, visit phoenixcontact.net/products			Note: Additional or deviating accessories are listed alongside the respective product.					

Feed-through, multi-conductor, and ground terminal blocks

Notes:
 1) For additional accessories and technical data, see page 242.
 For information on installation and using accessories for Ex applications, see page 678.

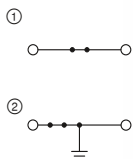

65 A, feed-through terminal block

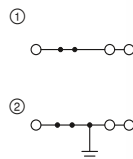

57 A, feed-through terminal block, 3 connections

Ex: EAC Ex IEC Ex

 KEMA 01ATEX2260 U / IECEx KEM 06.0033U

Technical data ¹⁾				
Dimensions	Width	Length	Height	
	10.2	71.5	50.3 (NS 35/7,5)	
Maximum electrical data	I_{max} [A]	U_{max} [V]	max. Ø [mm ²]	AWG (UL)
	65	1000	0.2 - 16	16-6
Maximum bridge current	57			
Rated data	IEC	UL / CUL	CSA	Ex
Rated voltage	1000	600	600	550
Nominal current / cross section	57 / 10	65 / -	65 / -	51 / 10

Technical data ¹⁾				
Dimensions	Width	Length	Height	
	10.2	95.4	50.3 (NS 35/7,5)	
Maximum electrical data	I_{max} [A]	U_{max} [V]	max. Ø [mm ²]	AWG (UL)
	57	1000	0.2 - 16	16-6
Maximum bridge current	57			
Rated data	IEC	UL / CUL	CSA	Ex
Rated voltage	1000	600	600	-
Nominal current / cross section	57 / 10	60 / -	55 / -	- / -

Ordering data			
Type	Order No.	Pcs./Pkt.	
ST 10	3036110	50	
ST 10 BU	3036123	50	
ST 10-PE	3036136	50	

Ordering data			
Type	Order No.	Pcs./Pkt.	
ST 10-TWIN	3035288	25	
ST 10-TWIN BU	3035292	25	
ST 10-TWIN-PE	3035302	25	

Accessories ¹⁾		
D-ST 10	Order No.	Pcs./Pkt.
D-ST 10	3036644	50

Accessories ¹⁾		
D-ST 10-TWIN	Order No.	Pcs./Pkt.
D-ST 10-TWIN	3035315	50

Description	Color
Terminal block	gray blue
Ground terminal	green-yellow

Cover, width: 2.2 mm	gray
----------------------	------

Terminal blocks – CLIPLINE complete

10 mm² ST spring-cage connection terminal blocks

Hybrid terminal blocks with screw connection on one side, 16 (16) mm²

Notes:

For additional accessories and technical data, see page 242.

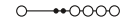

57 A, potential collective terminal block, 4 inputs 2.5 mm²



Dimensions	
	[mm]
Maximum electrical data	
Rated data, screw connection	
Rated voltage	[V]
Nominal current / cross section	[A] / [mm ²]
Cross section range	AWG
Connection capacity screw connection	
1 conductor	[mm ²]
2 conductors (of the same type)	[mm ²]
2 flexible conductors with a TWIN ferrule	[mm ²]
Rated data, spring-cage connection	
Rated voltage	[V]
Nominal current / cross section	[A] / [mm ²]
Cross section range	AWG
Connection capacity spring-cage connection	
1 conductor	[mm ²]
2 flexible conductors with a TWIN ferrule	[mm ²]
General data	
Stripping length	[mm]
Screw thread	
Tightening torque	[Nm]

Technical data				
Width	Length	Height NS 35/7,5		
10.3	68	48.3		
I_{max} [A]	U_{max} [V]	max. \varnothing [mm ²]	AWG (UL)	
57	800	0.5 - 16	20-8	
IEC 60947-7-1				
IEC	UL / CUL	CSA	IEC/ EN 60079-7	
800	600	-	-	
55 / 10	50 / -	-	-	
20 - 6	20-8	-	-	
Connection capacity screw connection	Rigid	Flexible	Ferrule	
			without/with plastic sleeve	
1 conductor	0.5 - 16	0.5 - 16	0.5 - 10	0.5 - 10
2 conductors (of the same type)	0.5 - 4	0.5 - 4	0.5 - 2.5	-
2 flexible conductors with a TWIN ferrule	-	-	-	0.5 - 6
IEC 60947-7-1				
IEC	UL / CUL	CSA	IEC/ EN 60079-7	
800	600	-	-	
24 / 2.5	50 / -	-	-	
24 - 10	20-8	-	-	
Connection capacity spring-cage connection	Rigid	Flexible	Ferrule	
			without/with plastic sleeve	
1 conductor	0.08 - 4	0.08 - 2.5	0.14 - 2.5	0.14 - 2.5
2 flexible conductors with a TWIN ferrule	-	-	-	0.14 - 0.5
8 - 10				
M4				
1.5 - 1.8				

Description	No. of pos.	Color
Terminal block		gray blue

Ordering data			
Type	I_{max}	Order No.	Pcs./Pkt.
STU 10/ 4X2,5		3033139	50
STU 10/ 4X2,5 BU		3033142	50

Pick-off terminal block , for snapping into the lateral guide		gray
Cover , width: 2.2 mm		gray
Plug-in bridge		
	2	red
	3	red
	4	red
	5	red
	10	red
Screwdriver		

Accessories			
AGK 4-UT 10		3047112	50
D-STU 10/ 4X2,5		3033197	50
FBS 2-5	24 A	3030161	50
FBS 3-5	24 A	3030174	50
FBS 4-5	24 A	3030187	50
FBS 5-5	24 A	3030190	50
FBS 10-5	24 A	3030213	10
SZF 2-0,8X4,0		1204520	10

Center and side groove labeling
--

UC-TM 10, UCT-TM 10 or ZB 10 (see Catalog 3)
--

Terminal blocks – CLIPLINE complete

16 mm² ST spring-cage connection terminal blocks

General technical data

Rated data	IEC 60947-7-1 / IEC 60947-7-2			
Rated cross section	[mm ²]	16		
Cross section range	AWG	24 - 4		
Connection capacity		Rigid	Flexible	Ferrule without/with plastic sleeve
1 conductor	[mm ²]	0.2 - 25	0.2 - 16	0.25 - 16 0.25 - 16
2 flexible conductors with a TWIN ferrule	[mm ²]	-	-	- 1.5 - 4
General data				
Stripping length	[mm]	18		
Insulating material		PA		
Flammability rating in accordance with UL 94		VO		
Note: Additional or deviating data is listed alongside the respective product.				

Notes:



In addition to the product, the internal electrical wiring is provided as a circuit diagram. Free connection points for bridging are indicated by a black dot.

The specified technical data and approvals refer to the first product in each column. For information on the products below, please refer to phoenixcontact.net/products

For full details of UL and CSA use groups, file nos., and Internet links, please visit phoenixcontact.net/products

¹⁾ The bridge current is listed alongside the respective product. For additional colors, see page 402.

System accessories

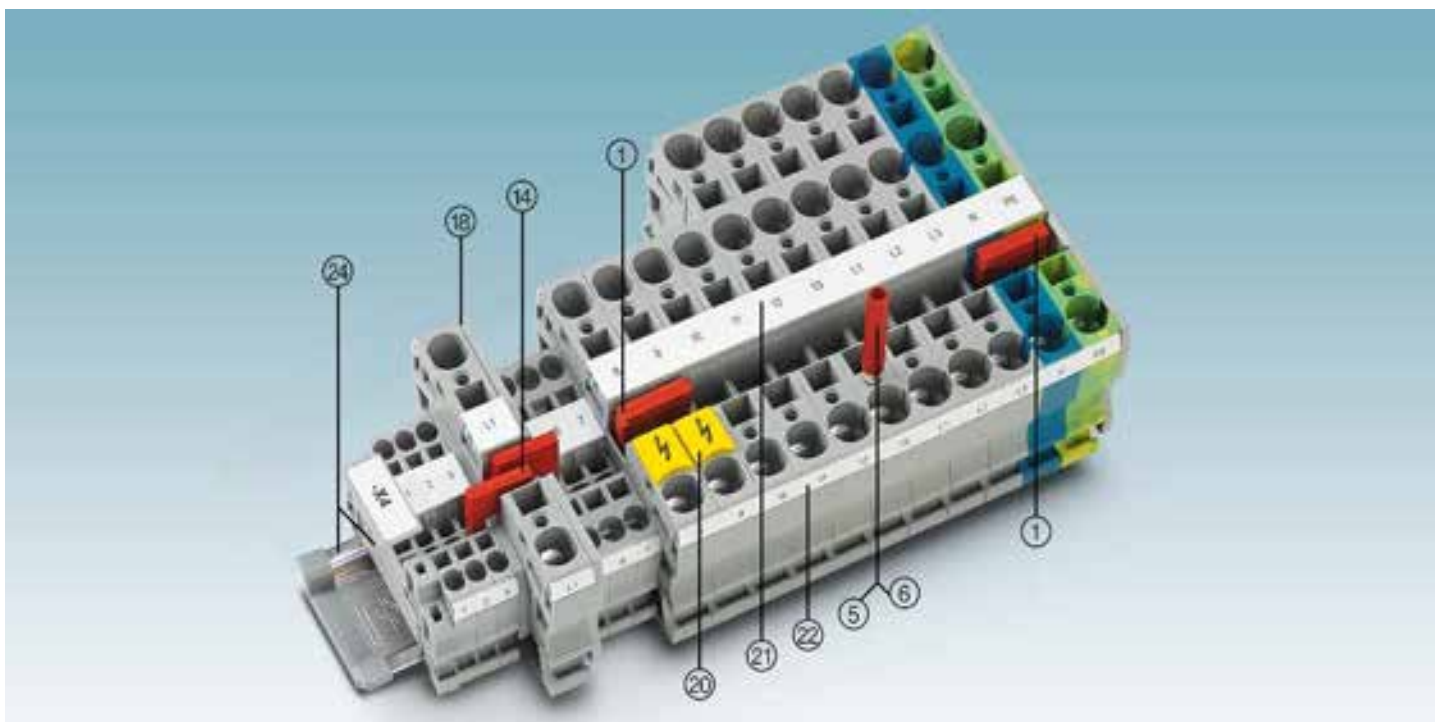

Description	No. of pos.	Color	Type	Order No.	Pcs./Pkt.	Type	Order No.	Pcs./Pkt.
① Bridge ¹⁾	2	red	FBS 2-12	3005950	10			
⑤ Test plug metal part		gray	MPS-MT	0201744	10			
⑥ Insulating sleeve, for MPS metal part		red	MPS-IH RD	0201676	10			
Screwdriver			SZF 3-1,0X5,5	1206612	10			
⑭ Reducing bridge			For RB ..., see page 408.					
⑮ Cover			Listed alongside the respective product.					
⑳ Warning labels			For WS ..., see page 420.					
㉑ Center groove labeling			UC-TM 12, UCT-TM 12 or ZB 12. See also Catalog 3, selection tables, from page 60.					
㉒ Center and side groove labeling			UC-TMF 12, UCT-TMF 12 or ZBF 12. See also Catalog 3, selection tables, from page 60.					
㉓ DIN rail and end bracket			See Catalog 3					
For full accessories, visit phoenixcontact.net/products			Note: Additional or deviating accessories are listed alongside the respective product.					

Feed-through, multi-conductor, and ground terminal blocks

Notes:
 1) For additional accessories and technical data, see page 246.
 For information on installation and using accessories for Ex applications, see page 678.

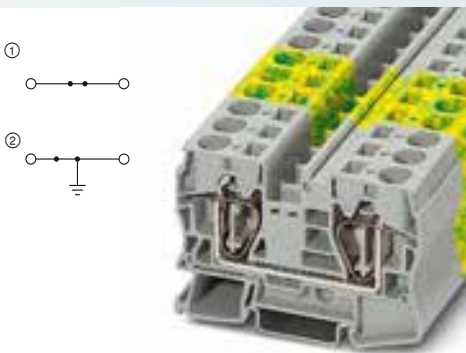

90 A, feed-through terminal block

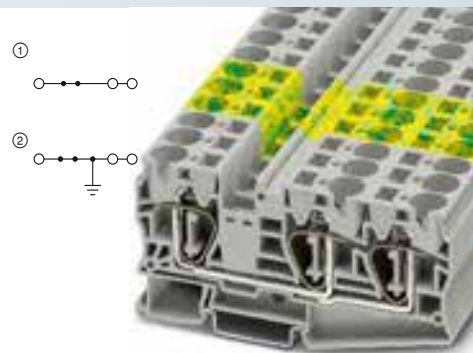

76 A, feed-through terminal block, 3 connections

SP, c, UL, US, ENEC, VDE, IEC, Ex, KEMA, ClassNK, CB

Ex: EAC Ex IEC Ex KEMA 01ATEX2260 U / IECEx KEM 06.0033U

Technical data ¹⁾				
Dimensions	Width	Length	Height	
	12.2	80	51.5 (NS 35/7,5)	
Maximum electrical data	I _{max} [A]	U _{max} [V]	max. Ø [mm ²]	AWG (UL)
	90	1000	0.2 - 25	16-4
Maximum bridge current	76			
Rated data	IEC	UL / CUL	CSA	Ex
Rated voltage	1000	600	600	550
Nominal current / cross section	76 / 16	85 / -	85 / -	64.5 / 16

Ordering data			
Type	Order No.	Pcs./Pkt.	
Terminal block	ST 16	① 3036149	50
	ST 16 BU	① 3036152	50
Ground terminal	ST 16-PE	② 3036165	25

Accessories ¹⁾		
D-ST 16	Order No.	Pcs./Pkt.
	3036657	50

SP, c, UL, US, ENEC, VDE, IEC, Ex, KEMA, ClassNK, CB

Technical data ¹⁾				
Dimensions	Width	Length	Height	
	12.2	107.8	51.5 (NS 35/7,5)	
Maximum electrical data	I _{max} [A]	U _{max} [V]	max. Ø [mm ²]	AWG (UL)
	76	1000	0.2 - 25	16-4
Maximum bridge current	76			
Rated data	IEC	UL / CUL	CSA	Ex
Rated voltage	1000	600	600	-
Nominal current / cross section	76 / 16	85 / -	75 / -	- / -

Ordering data			
Type	Order No.	Pcs./Pkt.	
Terminal block	ST 16-TWIN	① 3035328	25
	ST 16-TWIN BU	① 3035331	25
Ground terminal	ST 16-TWIN-PE	② 3035344	25

Accessories ¹⁾		
D-ST 16-TWIN	Order No.	Pcs./Pkt.
	3035357	50

Terminal blocks – CLIPLINE complete

35 mm² ST spring-cage connection terminal blocks

General technical data

Rated data	IEC 60947-7-1 / IEC 60947-7-2			
Rated cross section	[mm ²]	35		
Cross section range	AWG	14 - 2		
Connection capacity		Rigid	Flexible	Ferrule without/with plastic sleeve
1 conductor	[mm ²]	2.5 - 35	2.5 - 35	2.5 - 35
2 flexible conductors with a TWIN ferrule	[mm ²]	-	-	2.5 - 10
General data				
Stripping length	[mm]	25		
Insulating material		PA		
Flammability rating in accordance with UL 94		VO		
Note: Additional or deviating data is listed alongside the respective product.				

Notes:



In addition to the product, the internal electrical wiring is provided as a circuit diagram. Free connection points for bridging are indicated by a black dot.

The specified technical data and approvals refer to the first product in each column. For information on the products below, please refer to phoenixcontact.net/products

For full details of UL and CSA use groups, file nos., and Internet links, please visit phoenixcontact.net/products

¹⁾ The bridge current is listed alongside the respective product. For additional colors, see page 402.

System accessories

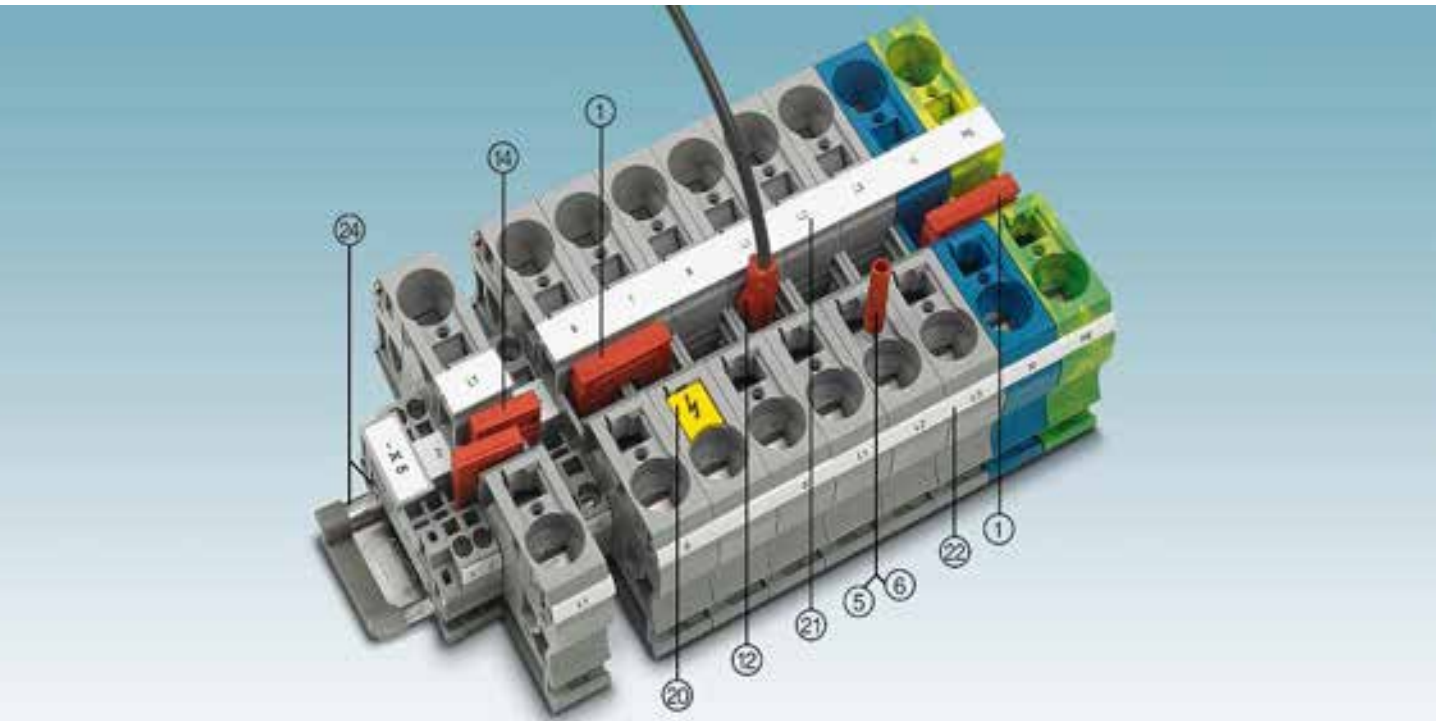

Description	No. of pos.	Color	Type	Order No.	Pcs./Pkt.	Type	Order No.	Pcs./Pkt.
① Bridge ¹⁾	2	red	FBS 2-16	3005963	10			
⑤ Test plug metal part		gray	MPS-MT	0201744	10			
⑥ Insulating sleeve, for MPS metal part		red	MPS-IH RD	0201676	10			
⑫ Test plug, with 2.5 mm ² conductor		red	PAI-ST 35/1000MM	3029994	20			
Screwdriver			SZF 3-1.0X5,5	1206612	10			
⑭ Reducing bridge			For RB ..., see page 408.					
⑯ Warning labels			For WS ..., see page 420.					
⑰ Center groove labeling			UC-TM 16, UCT-TM 16 or ZB 16,3. See also Catalog 3, selection tables from page 60.					
⑱ Center and side groove labeling			UC-TMF 16, UCT-TMF 16 or ZBF 16. See also Catalog 3, selection tables from page 60.					
⑳ DIN rail and end bracket			See Catalog 3					
For full accessories, visit phoenixcontact.net/products			Note: Additional or deviating accessories are listed alongside the respective product.					

Feed-through and ground terminal blocks

Notes:

¹⁾ For additional accessories and technical data, see page 248.

For information on installation and using accessories for Ex applications, see page 678.

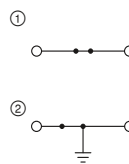

125 A, feed-through terminal block



Ex: EAC Ex IEC Ex
KEMA 01ATEX2260 U / IECEx KEM 06.0033U

Technical data¹⁾

Dimensions	Width	Length	Height	
	16	100	59 (NS 35/7,5)	
Maximum electrical data	I_{max} [A]	U_{max} [V]	max. \varnothing [mm ²]	AWG (UL)
	125	1000	2.5 - 35	14-2
Maximum bridge current	101			
Rated data	IEC	UL / CUL	CSA	Ex
Rated voltage	1000	600	600	690
Nominal current / cross section	[A] / [mm ²]	125 / 35	115 / -	115 / - 107.5 / 35

Ordering data

Description	Color	Type	Order No.	Pcs./Pkt.
Terminal block	gray	ST 35	① 3036178	10
	blue	ST 35 BU	① 3036181	10
Ground terminal	green-yellow	ST 35-PE	② 3036194	10

Hybrid terminal blocks with screw connection on one side

– Rated voltage of 1000 V

Notes:

¹⁾ The max. load current must not be exceeded by the total current of all connected conductors.

For additional accessories and technical data, visit phoenixcontact.net/products

For screw connection rated data, visit phoenixcontact.net/products

For further plug-in bridges, see page 402.



125 A (screw connection), potential collective terminal block, 4 inputs 10 mm²



Technical data

Dimensions	Width	Length	Height NS 35/7,5	
	16.2	86	46.8	
Maximum electrical data	I_{max} [A]	U_{max} [V]	max. \varnothing [mm ²]	AWG (UL)
	41 ¹⁾	1000	0.2 - 10	14-2
Rated data	IEC	UL / CUL	CSA	IEC / EN 60079-7
Rated voltage	1000	1000	-	-
Nominal current / cross section	[A] / [mm ²]	41 ¹⁾ / 6	115 / -	-
Cross section range	AWG	24 - 8	14-2	-
General data	Stripping length	[mm]	12	

Ordering data

Description	No. of pos.	Color	Type	Order No.	Pcs./Pkt.
Terminal block		gray	STU 35/ 4X10	3033126	25
		blue	STU 35/ 4X10 BU	3033210	25

Accessories

Plug-in bridge 2-pos.	2	red	FBS 2-8	3030284	10
-----------------------	---	-----	---------	---------	----



QT fast connection terminal blocks

The use of QT fast connection terminal blocks can save up to 60 percent of the time required for wiring. The conductors simply need to be cut to length for contacting in a matter of seconds. It is no longer necessary to strip or to fit splicing protection. An important characteristic is the space-saving twist connection with patented insulation displacement contact.

The start and end positions of the conductor connection are clearly identified by engagement points. When a conductor is connected, the insulation is cut open, displaced, and the conductor is securely engaged in the end position where it makes a large-area, gas-tight contact. Rigid and flexible conductors from 0.25 to 2.5 mm² can be wired without aids such as guide ferrules.

The high quality of the QT fast connection terminal blocks is proven by the fact that this connection technology features various approvals and is certified under the standard for Ex e applications.

i Your web code: [#0162](#)

Product range overview

1.5 mm²

Feed-through, multi-conductor, multi-level, and ground terminal blocks	257
Disconnect terminal blocks	258
Knife disconnect terminal blocks	259
Diode terminal blocks	259
Hybrid terminal blocks with screw connection on one side	260
Hybrid feed-through terminal blocks with spring-cage connection on one side	261

2.5 mm²

Feed-through and multi-conductor terminal blocks	263
Disconnect terminal blocks	263
Knife disconnect terminal blocks	263
Fuse terminal blocks and lever-type disconnect terminal blocks of the same shape	264
Hybrid terminal blocks with screw connection on one side	264
Hybrid feed-through terminal blocks with spring-cage connection on one side	265

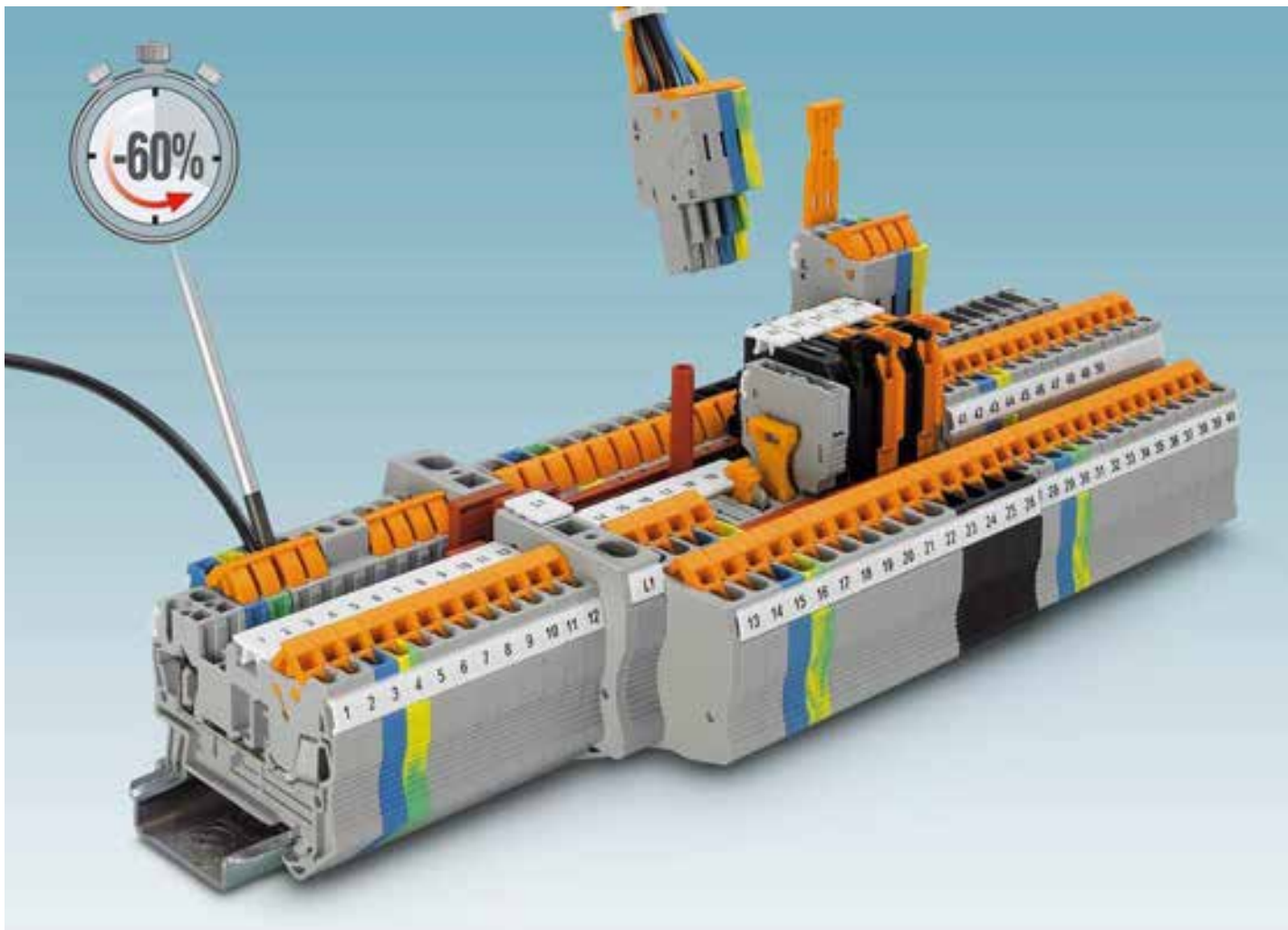

i Your web code: #0162



Space-saving design

The QUICKON QT series is characterized by the IDC connection. This allows space to be saved without limiting the quality features in any way:

- Large-surface marking
- Maximum connection space
- Flexible plug-in bridge system



Trim to length, connect, job done

Time savings of 60 percent or more compared with other connection technologies. With QUICKON fast connection technology, there is no need for stripping or for fitting splicing protection. The conductors simply need to be cut to length for contacting in a matter of seconds.



Powerful cutting contact

The 0.25 to 2.5 mm² conductor connection is provided by the patented cutting contact. High-quality special alloys and latches for the switching states ensure safe electrical connections at all times. Large, spring-mounted contact points guarantee 24 A current-carrying capacity.



The reducing bridge enables time-saving and low-cost potential distribution when supplying large cross sections. The reducing bridge connects, e.g., an ST 10 terminal block to a QTC 1,5 or QTC 2,5.

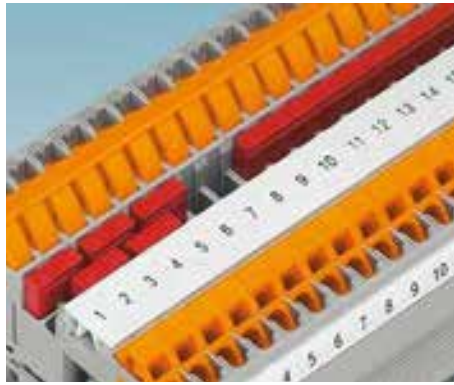

The double function shaft can be used to connect any number of terminal blocks with two-position bridges. The 2- to 50-pos. bridges allow up to 50 terminal blocks to be bridged in one step.



Non-adjacent terminal blocks can be bridged by removing individual forks from the standard bridge. Two potentials can then be routed in parallel. There is scope for marking on the top of the bridge.



The isolated feed-through connector P-FIX, isolating connector P-DI, component connector P-CO and the cartridge fuse connector P-FU with a 5.2 mm pitch can be used in the universal plug-in zone of the disconnect terminal block.



For measuring lines, a test plug with 2.3 mm diameter is available. All measurement and testing tasks can be carried out quickly using test adapters for 4 mm diameter test plugs and the alignable test plugs.



The hybrid versions combine the time-saving fast connection technology with the benefits of the screw or spring-cage method.



Lever-type fuse terminal blocks are also available to suit the function terminal blocks. The retentive fuse holders can be used in a black housing with a micro fuse or in an orange housing with a contact metal.

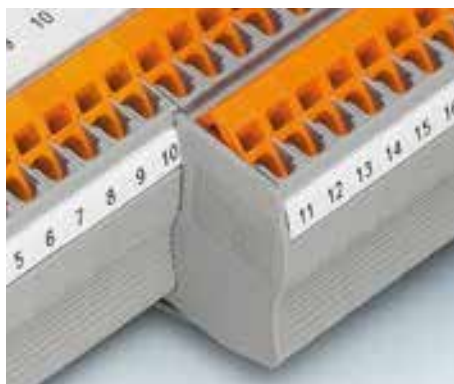

Overhanging terminal block segments of three-conductor and four-conductor terminal blocks should be covered with cover segments when adding two-conductor terminal blocks. Fingers are thereby protected from contact.



QT COMBI basic terminal blocks and plugs with fast connection are available for the plug-in configuration of signal wiring with fast connection. See "COMBI" section, page 267.

Terminal blocks – CLIPLINE complete

QT fast connection terminal blocks

QT ... feed-through terminal blocks



- Time savings of up to 60 percent during connection as no conductor pretreatment is required
- Easy to operate and use, thanks to the patented insulation displacement contact
- Universal use, thanks to large cross section range
- Space saving, thanks to the compact design

i Your web code: **#0053**

QT ... disconnect and knife disconnect terminal blocks



- Convenient separation of circuits using lever-type disconnect knife, isolating plug or rotary contact
- User-friendly current measurement, thanks to testing facility either side of the disconnect point
- Safe operation as the disconnect lever is locked in the end positions
- Clear identification of the disconnect point, thanks to color highlighting
- Easy handling of the disconnect knife using a standard screwdriver

i Your web code: **#0054**

QTCU ... and QTCS ... hybrid terminal blocks



- Meet requirements for internal and external wiring at the same time as different connection methods are integrated in a single terminal block
- Free choice of connection technology, thanks to two combination options
- Versions with fast connection/spring-cage connection or fast connection/screw connection
- Uniform distances from cable ducts
- Feed-through and ground terminal blocks of the same shape

i Your web code: **#0055**

QT ... fuse terminal blocks



- Compact design
- Two function shafts mean that all potential distribution tasks can be undertaken at speed
- QTC 2,5-TG / -MT function terminal blocks of the same shape are available
- Test connection on both sides in safety level
- The product range is rounded off with versions with an LED display to indicate that a fuse has tripped

i Your web code: [#0162](#)

Terminal blocks – CLIPLINE complete

1.5 mm² QT fast connection terminal blocks

General technical data

Rated data		IEC 60947-7-1 / IEC 60947-7-2
Rated cross section	[mm ²]	1.5
Cross section range	AWG	24 - 16
Connection cross section in acc. with DIN VDE 0295		
H05V(Z) / H07V(Z)	[mm ²]	0.5 - 1.5
Class 5 / Class 6 [litz wires Ø ≥ 0.1 mm]	[mm ²]	0.25 - 0.34
[Litz wires Ø ≥ 0.19 mm]	AWG	24 - 16
Frequency of connections with the same cross section		100

Other conductor types and materials on request.

General data	
Insulating material	PA
Flammability rating in accordance with UL 94	V0
Wire diameter incl. insulation	≤ 3 mm

Note: Additional or deviating data is listed alongside the respective product.

Notes:



In addition to the product, the internal electrical wiring is provided as a circuit diagram. Free connection points for bridging are indicated by a black dot.

The specified technical data and approvals refer to the first product in each column. For information on the products below, please refer to phoenixcontact.net/products

For full details of UL and CSA use groups, file nos., and Internet links, please visit phoenixcontact.net/products

¹⁾ The bridge current is listed alongside the respective product. For additional colors, see page 402.

System accessories

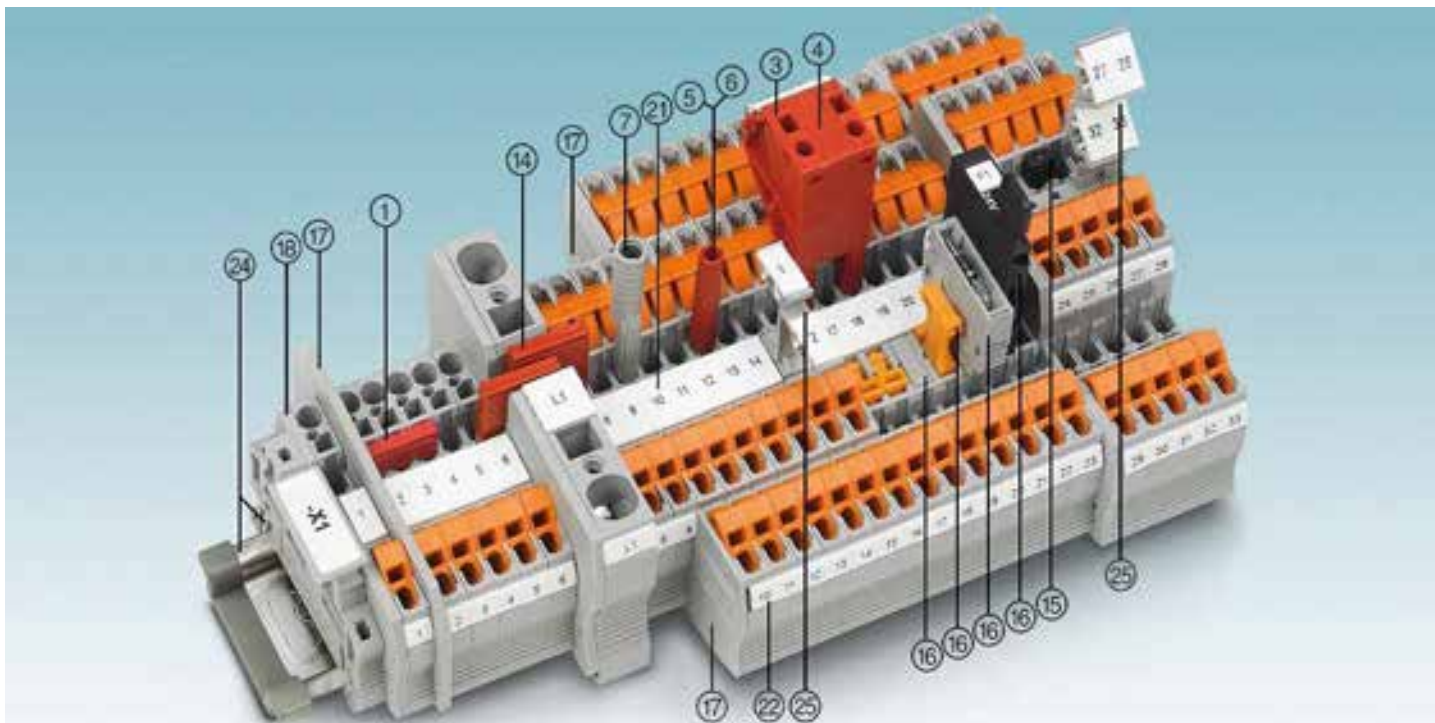

Description	No. of pos.	Color	Type	Order No.	Pcs./Pkt.	Type	Order No.	Pcs./Pkt.
① Bridge ¹⁾	2	red	FBS 2-5	3030161	50	FBSR 2-5	3033702	50
	3	red	FBS 3-5	3030174	50	FBSR 3-5	3001591	50
	4	red	FBS 4-5	3030187	50	FBSR 4-5	3001592	50
	5	red	FBS 5-5	3030190	50	FBSR 5-5	3001593	50
	10	red	FBS 10-5	3030213	10	FBSR 10-5	3033710	10
	20	red	FBS 20-5	3030226	10			
③ Modular test plug		red	PS-5	3030983	10			
④ Spacer plate		red	DP PS-5	3036725	10			
⑤ Test plug metal part		gray	MPS-MT	0201744	10			
⑥ Insulating sleeve, for MPS metal part		red	MPS-IH RD	0201676	10			
⑦ Test adapter, 4 mm socket hole		gray	PAI-4-N GY	3032871	10			
Screwdriver			SZF 1-0,6X3,5	1204517	10			

⑭ Reducing bridge	For RB ..., see page 408.
⑮ Vertical potential bridge	For FBS ..., see page 404.
⑯ Fuse and function plugs for disconnect terminal blocks	For P-FU ... / P-DI / P-FIX / P-CO ..., see from page 414.
⑰ Partition plates/end cover segments	For ATP-... / DS-..., visit phoenixcontact.net/products
⑱ Cover	Listed alongside the respective product.
⑲ Center groove labeling	UC-TM 5, UCT-TM 5 or ZB 5. See also Catalog 3, selection tables, from page 60.
⑲ Center and side groove labeling	UC-TMF 5, UCT-TMF 5 or ZBF 5. See also Catalog 3, selection tables, from page 60.
⑳ DIN rail and end bracket	See Catalog 3
㉑ Marker carrier	For STP ..., see page 418.
For full accessories, visit phoenixcontact.net/products	Note: Additional or deviating accessories are listed alongside the respective product.

Feed-through and multi-conductor terminal blocks

Notes:
 1) For additional accessories and technical data, see page 256.
 For information on installation and using accessories for Ex applications, see page 678.

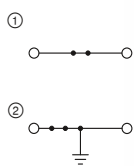

17.5 A, feed-through terminal block

UL, CE, EAC, IEC, ClassNK
 Ex: EAC Ex IEC Ex
 KEMA 03ATEX2557U / IECEx KEM 07.0015U

Technical data ¹⁾				
Width	Length	Height		
5.2	58.8	39.3 (NS 35/7,5)		
I _{max.} [A]	U _{max.} [V]	max. Ø [mm ²]	AWG (UL)	
17.5	800	0.25 - 1.5	24-16	
24 (FBS) / 17.5 (FBSR)				
IEC	UL / CUL	CSA	Ex	
800	600	600	550	
Nominal current / cross section	[A] / [mm ²]	17.5 / 1.5	10 / -	16 / 1.5

Ordering data			
Type	Order No.	Pcs./Pkt.	
QTC 1,5	① 3205019	50	
QTC 1,5 BU	① 3205022	50	
QTC 1,5-PE	② 3205035	50	

Accessories ¹⁾		
D-QTC 1,5	3205161	50

Dimensions	[mm]
Maximum electrical data	
Maximum bridge current	[A]
Rated data	
Rated voltage	[V]
Nominal current / cross section	[A] / [mm ²]

Description	Color
Terminal block	gray
	blue
Ground terminal	green-yellow

Cover, width: 2.2 mm	gray
----------------------	------

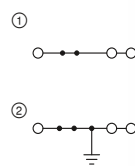

17.5 A, feed-through terminal block, 3 connections

UL, CE, EAC, IEC, ClassNK
 Ex: EAC Ex IEC Ex
 KEMA 03ATEX2557U / IECEx KEM 07.0015U

Technical data ¹⁾			
Width	Length	Height	
5.2	76.4	39.3 (NS 35/7,5)	
I _{max.} [A]	U _{max.} [V]	max. Ø [mm ²]	AWG (UL)
17.5	800	0.25 - 1.5	24-16
24 (FBS) / 17.5 (FBSR)			
IEC	UL / CUL	CSA	Ex
800	600	600	550
Nominal current / cross section	[A] / [mm ²]	17.5 / 1.5	10 / - 16 / 1.5

Ordering data		
Type	Order No.	Pcs./Pkt.
QTC 1,5-TWIN	① 3205048	50
QTC 1,5-TWIN BU	① 3205051	50
QTC 1,5-TWIN-PE	② 3205064	50

Accessories ¹⁾		
D-QTC 1,5-TWIN	3205190	50

Multi-conductor terminal blocks

Notes:
 1) For additional accessories and technical data, see page 256.
 For information on installation and using accessories for Ex applications, see page 678.

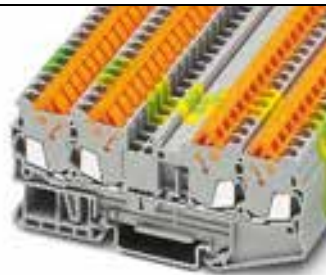
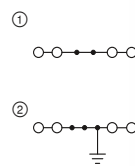

17.5 A, feed-through terminal block, 4 connections

UL, CE, EAC, IEC, ClassNK
 Ex: EAC Ex IEC Ex
 KEMA 03ATEX2557U / IECEx KEM 07.0015U

Technical data ¹⁾			
Width	Length	Height	
5.2	94	39.3 (NS 35/7,5)	
I _{max.} [A]	U _{max.} [V]	max. Ø [mm ²]	AWG (UL)
17.5	800	0.25 - 1.5	24-16
24 (FBS) / 17.5 (FBSR)			
IEC	UL / CUL	CSA	Ex
800	600	600	550
Nominal current / cross section	[A] / [mm ²]	17.5 / 1.5	10 / - 16 / 1.5

Ordering data		
Type	Order No.	Pcs./Pkt.
QTC 1,5-QUATTRO	① 3205077	50
QTC 1,5-QUATTRO BU	① 3205080	50
QTC 1,5-QUATTRO-PE	② 3205093	50

Accessories ¹⁾		
D-QTC 1,5-QUATTRO	3205174	50

Dimensions	[mm]
Maximum electrical data	
Maximum bridge current	[A]
Rated data	
Rated voltage	[V]
Nominal current / cross section	[A] / [mm ²]

Description	Color
Terminal block	gray
	blue
Ground terminal	green-yellow

Cover, width: 2.2 mm	gray
----------------------	------

Terminal blocks – CLIPLINE complete

1.5 mm² QT fast connection terminal blocks

Multi-level and disconnect terminal blocks

Notes:
 1) For additional accessories and technical data, see page 256.
 2) Current and voltage are determined by the plug used.
 For information on installation and using accessories for Ex applications, see page 678.

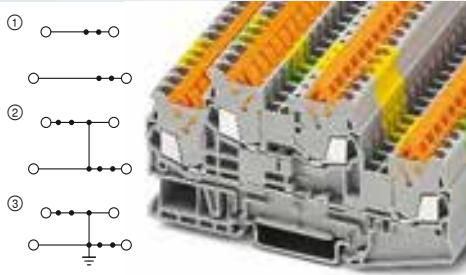

17.5 A, double-level terminal block

UL, IEC, ENEC, EAC, Ex, IEC, Ex, ClassNK

Ex: EAC Ex IEC Ex
 KEMA 03ATEX2557U / IECEx KEM 07.0015U

Technical data¹⁾

Dimensions	[mm]
Width	5.2
Length	99.6
Height	49.9 (NS 35/7,5)

Maximum electrical data	[A]
I_{max}	17.5
U_{max}	500
max. \varnothing [mm ²]	0.25 - 1.5
AWG (UL)	24 (FBS) / 17.5 (FBSR)

Rated data	[V]
Rated voltage	500
Nominal current / cross section	17.5 / 1.5

Width	Length	Height
5.2	99.6	49.9 (NS 35/7,5)

I_{max} [A]	U_{max} [V]	max. \varnothing [mm ²]	AWG (UL)
17.5	500	0.25 - 1.5	24-16

IEC	UL / CUL	CSA	Ex
24 (FBS) / 17.5 (FBSR)	500	600	440
17.5 / 1.5	10 / -	10 / -	15 / 1.5

Ordering data

Description	Color
Terminal block	gray
With potential distribution	gray
Ground terminal	green-yellow

Type	Order No.	Pcs./Pkt.
QTTCB 1,5	① 3205116	50
QTTCB 1,5 BU	① 3205129	50
QTTCB 1,5-PV	② 3205153	50
QTTCB 1,5-PE	③ 3205132	50

Accessories¹⁾

Cover, width: 2.2 mm	gray
----------------------	------

D-QTTCB 1,5	3205187	50
-------------	---------	----



17.5 A, disconnect terminal block

UL, IEC, ENEC, EAC, Ex, IEC, Ex, ClassNK

Technical data¹⁾

Width	Length	Height
5.2	76.4	39.3 (NS 35/7,5)

I_{max} [A]	U_{max} [V]	max. \varnothing [mm ²]	AWG (UL)
17.5 ²⁾	400 ²⁾	0.25 - 1.5	24-16

IEC	UL / CUL	CSA	Ex
16 (FBS) / 17.5 (FBSR)	600	600	-
17.5 / 1.5	10 / -	10 / -	- / -

Ordering data

Type	Order No.	Pcs./Pkt.
QTC 1,5-TG	① 3205145	50

Accessories¹⁾

D-QTC 1,5-TWIN	3205190	50
----------------	---------	----

Disconnect terminal blocks

Notes:
 1) For additional accessories and technical data, see page 256.
 2) Current and voltage are determined by the plug used.

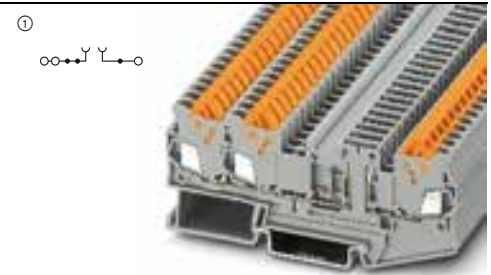

17.5 A, disconnect terminal block, 3 connections

Dimensions	[mm]
Width	5.2
Length	94
Height	39.3 (NS 35/7,5)

Maximum electrical data	[A]
I_{max}	17.5
U_{max}	400 ²⁾
max. \varnothing [mm ²]	0.25 - 1.5
AWG (UL)	-

Rated data	[V]
Rated voltage	400 ²⁾
Nominal current / cross section	17.5 / 1.5

Width	Length	Height
5.2	94	39.3 (NS 35/7,5)

I_{max} [A]	U_{max} [V]	max. \varnothing [mm ²]	AWG (UL)
17.5	400 ²⁾	0.25 - 1.5	-

IEC	UL / CUL	CSA	Ex
24 (FBS) / 17.5 (FBSR)	500	600	440
17.5 / 1.5	- / -	- / -	- / -

Ordering data

Description	Color
Disconnect terminal block	gray

Type	Order No.	Pcs./Pkt.
QTC 1,5-TWIN-TG	① 3050413	50

Accessories¹⁾

Cover, width: 2.2 mm	gray
----------------------	------

D-QTC 1,5-QUATTRO	3205174	50
-------------------	---------	----

Knife disconnect terminal blocks

Notes:
 1) For additional accessories and technical data, see page 256.

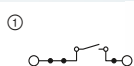

17.5 A, knife disconnect terminal block



Technical data ¹⁾				
Dimensions	Width	Length	Height	
[mm]	5.2	76.4	39.3 (NS 35/7,5)	
Maximum electrical data	I _{max.} [A]	U _{max.} [V]	max. Ø [mm ²]	AWG (UL)
	17.5	400	0.25 - 1.5	24-16
Maximum bridge current	16 (FBS) / 17.5 (FBSR)			
Rated data	IEC	UL / CUL	CSA	Ex
Rated voltage	400	600	600	-
Nominal current / cross section	17.5 / 1.5	10 / -	10 / -	- / -

Ordering data			
Type	Order No.	Pcs./Pkt.	
QTC 1,5-MT	3205103	50	

Accessories ¹⁾			
D-QTC 1,5-TWIN	3205190	50	

Description	Color
Knife disconnect terminal block	gray
Cover, width: 2.2 mm	gray

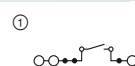

17.5 A, knife disconnect terminal block, 3 connections



Technical data ¹⁾			
Dimensions	Width	Length	Height
[mm]	5.2	94	39.3 (NS 35/7,5)
Maximum electrical data	I _{max.} [A]	U _{max.} [V]	max. Ø [mm ²]
	17.5	400	0.25 - 1.5
Maximum bridge current	24 (FBS) / 17.5 (FBSR)		
Rated data	IEC	UL / CUL	CSA
Rated voltage	400	-	-
Nominal current / cross section	17.5 / 1.5	- / -	- / -

Ordering data		
Type	Order No.	Pcs./Pkt.
QTC 1,5-TWIN-MT	3050407	50

Accessories ¹⁾		
D-QTC 1,5-QUATTRO	3205174	50

Diode terminal blocks

Notes:
 1) For additional accessories and technical data, see page 256.

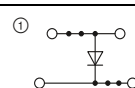

17.5 A, double-level diode terminal block, 1N 4007 (1300 V/0.5 A)



Technical data ¹⁾				
Dimensions	Width	Length	Height	
[mm]	5.2	99.6	49.9 (NS 35/7,5)	
Maximum electrical data	I _{max.} [A]	U _{max.} [V]	max. Ø [mm ²]	AWG (UL)
	17.5	500	0.25 - 1.5	24-16
Maximum bridge current	24 (FBS) / 17.5 (FBSR)			
Rated data	IEC	UL / CUL	CSA	Ex
Rated voltage	500	600	600	-
Nominal current / cross section	17.5 / 1.5	10 / -	10 / -	- / -

Ordering data			
Type	Order No.	Pcs./Pkt.	
QTTCB 1,5-DIO/O-U	3206241	50	

Accessories ¹⁾			
D-QTTCB 1,5	3205187	50	

Description	Color
Terminal block, for conducting direction see circuit diagram	gray
Cover, width: 2.2 mm	gray

Terminal blocks – CLIPLINE complete

1.5 mm² QT fast connection terminal blocks

Hybrid terminal blocks with screw connection on one side, 2.5 (4) mm²

Notes:
 1) For additional accessories and technical data, see page 256.
 2) For screw connection rated data, visit phoenixcontact.net/products
 For information on installation and using accessories for Ex applications, see page 678.

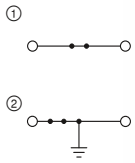

17.5 A, feed-through terminal block



Ex: EAC Ex IEC Ex
 KEMA 04ATEX2226 U / IECEx KEM 07.0007U

Technical data¹⁾

Width	Length	Height		
5.2	58.8	42.8 (NS 35/7,5)		
I_{max} [A]	U_{max} [V]	max. Ø [mm ²]	AWG (UL)	
17.5	800	0.25 - 1.5	24-16	
24 (FBS) / 17.5 (FBSR)				
IEC	UL / CUL	CSA	Ex	
800	600	600	550	
17.5 / 1.5	10 / -	10 / -	16.5 / 1.5	

Ordering data

Type	Order No.	Pcs./Pkt.
QTCU 1,5	① 3050015	50
QTCU 1,5 BU	① 3050028	50
QTCU 1,5-PE	② 3050031	50

Accessories¹⁾

D-QTCU 1,5	Order No.	Pcs./Pkt.
	3206283	50

Dimensions	[mm]
Maximum electrical data	
Maximum bridge current	[A]
Rated data ²⁾	
Rated voltage	[V]
Nominal current / cross section	[A] / [mm ²]

Description	Color
Terminal block	gray blue
Ground terminal	green-yellow

Cover, width: 2.2 mm	Color
	gray

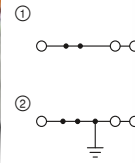

17.5 A, feed-through terminal block, 3 connections



Ex: EAC Ex IEC Ex
 KEMA 04ATEX2226 U / IECEx KEM 07.0007U

Technical data¹⁾

Width	Length	Height		
5.2	76.4	42.8 (NS 35/7,5)		
I_{max} [A]	U_{max} [V]	max. Ø [mm ²]	AWG (UL)	
17.5	800	0.25 - 1.5	24-16	
24 (FBS) / 17.5 (FBSR)				
IEC	UL / CUL	CSA	Ex	
800	600	600	550	
17.5 / 1.5	10 / -	10 / -	17.5 / 1.5	

Ordering data

Type	Order No.	Pcs./Pkt.
QTCU 1,5-TWIN	① 3050044	50
QTCU 1,5-TWIN BU	① 3050057	50
QTCU 1,5-TWIN-PE	② 3050060	50

Accessories¹⁾

D-QTCU 1,5-TWIN	Order No.	Pcs./Pkt.
	3206296	50

Double-level hybrid terminal blocks with screw connection on one side, 2.5 (4) mm²

Notes:
 1) For additional accessories and technical data, see page 256.
 2) For screw connection rated data, visit phoenixcontact.net/products

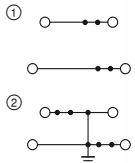

17.5 A, double-level terminal block



Technical data ¹⁾				
Width	Length	Height		
5.2	93.5	55.5 (NS 35/7,5)		
I_{max} [A]	U_{max} [V]	max. Ø [mm ²]	AWG (UL)	
17.5	500	0.25 - 1.5	24-16	
24 (FBS) / 17.5 (FBSR)				
IEC	UL / CUL	CSA	Ex	
500	600	600	-	
17.5 / 1.5	10 / -	10 / -	- / -	

Ordering data

Type	Order No.	Pcs./Pkt.
QTTCBU 1,5	① 3050264	50
QTTCBU 1,5 BU	① 3050280	50
QTTCBU 1,5-PE	② 3050277	50

Accessories¹⁾

D-QTTCBU 1,5	Order No.	Pcs./Pkt.
	3050536	50

Dimensions	[mm]
Maximum electrical data	
Maximum bridge current	[A]
Rated data ²⁾	
Rated voltage	[V]
Nominal current / cross section	[A] / [mm ²]

Description	Color
Terminal block	gray blue gray
Ground terminal	green-yellow

Cover, width: 2.2 mm	Color
	gray

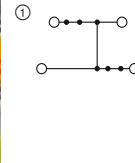

17.5 A, double-level terminal block with equipotential bonder



Technical data ¹⁾				
Width	Length	Height		
5.2	93.5	55.5 (NS 35/7,5)		
I_{max} [A]	U_{max} [V]	max. Ø [mm ²]	AWG (UL)	
17.5	500	0.25 - 1.5	24-16	
24 (FBS) / 17.5 (FBSR)				
IEC	UL / CUL	CSA	Ex	
500	600	600	-	
17.5 / 1.5	10 / -	10 / -	- / -	

Ordering data

Type	Order No.	Pcs./Pkt.
QTTCBU 1,5-PV	① 3050361	50

Accessories¹⁾

D-QTTCBU 1,5	Order No.	Pcs./Pkt.
	3050536	50

1.5 mm² QT fast connection terminal blocks

Hybrid terminal blocks with spring-cage connection on one side, 2.5 (4) mm²

Notes:
 1) For additional accessories and technical data, see page 256.
 2) For spring-cage connection rated data, see page 210.
 For information on installation and using accessories for Ex applications, see page 678.

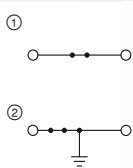

17.5 A, feed-through terminal block

UL **IEC** **Ex**
 Ex: **Ex** EAC Ex **IEC** **Ex**
 KEMA 04ATEX2226 U / IECEx KEM 07.0007U

Technical data ¹⁾				
Width	Length	Height		
5.2	54.4	39.3 (NS 35/7,5)		
I _{max} [A]	U _{max} [V]	max. Ø [mm ²]	AWG (UL)	
17.5	800	0.25 - 1.5	24-16	
24 (FBS) / 17.5 (FBSR)				
IEC	UL / CUL	CSA	Ex	
800	600	-	550	
Nominal current / cross section [A] / [mm ²]				
17.5 / 1.5 10 / - - / - 17 / 1.5				

Ordering data			
Type	Order No.	Pcs./Pkt.	
QTCS 1,5	① 3050138	50	
QTCS 1,5 BU	① 3050141	50	
QTCS 1,5-PE	② 3050154	50	

Accessories ¹⁾		
D-QTCS 1,5	Order No.	Pcs./Pkt.
D-QTCS 1,5	3206270	50

Dimensions	
	[mm]
Maximum electrical data	
Maximum bridge current	[A]
Rated data ²⁾	
Rated voltage	[V]
Nominal current / cross section	[A] / [mm ²]
Description	Color
Terminal block	gray blue
Ground terminal	green-yellow
Cover, width: 2.2 mm	gray

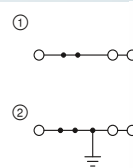

17.5 A, feed-through terminal block, 3 connections

UL **IEC** **Ex**
 Ex: **Ex** EAC Ex **IEC** **Ex**
 KEMA 04ATEX2226 U / IECEx KEM 07.0007U

Technical data ¹⁾				
Width	Length	Height		
5.2	71.6	39.3 (NS 35/7,5)		
I _{max} [A]	U _{max} [V]	max. Ø [mm ²]	AWG (UL)	
17.5	800	0.25 - 1.5	24-16	
24 (FBS) / 17.5 (FBSR)				
IEC	UL / CUL	CSA	Ex	
800	600	-	550	
Nominal current / cross section [A] / [mm ²]				
17.5 / 1.5 10 / - - / - 17.5 / 1.5				

Ordering data			
Type	Order No.	Pcs./Pkt.	
QTCS 1,5-TWIN	① 3206348	50	
QTCS 1,5-TWIN BU	① 3206351	50	
QTCS 1,5-TWIN-PE	② 3206364	50	

Accessories ¹⁾		
D-QTCS 1,5-TWIN	Order No.	Pcs./Pkt.
D-QTCS 1,5-TWIN	3206403	50

Double-level hybrid terminal blocks with spring-cage connection on one side, 2.5 (4) mm²

Notes:
 1) For additional accessories and technical data, see page 256.
 2) For spring-cage connection rated data, see page 210.

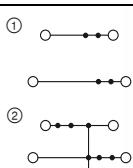

17.5 A, double-level terminal block

UL **IEC** **Ex**

Technical data ¹⁾				
Width	Length	Height		
5.2	88.2	49.9 (NS 35/7,5)		
I _{max} [A]	U _{max} [V]	max. Ø [mm ²]	AWG (UL)	
17.5	500	0.25 - 1.5	24-16	
24 (FBS) / 17.5 (FBSR)				
IEC	UL / CUL	CSA	Ex	
500	600	-	-	
Nominal current / cross section [A] / [mm ²]				
17.5 / 1.5 10 / - - / - - / -				

Ordering data			
Type	Order No.	Pcs./Pkt.	
QTTCBS 1,5	① 3050222	50	
QTTCBS 1,5 BU	① 3050235	50	
QTTCBS 1,5-PE	② 3050248	50	

Accessories ¹⁾		
D-QTTCBS 1,5	Order No.	Pcs./Pkt.
D-QTTCBS 1,5	3206335	50

Dimensions	
	[mm]
Maximum electrical data	
Maximum bridge current	[A]
Rated data ²⁾	
Rated voltage	[V]
Nominal current / cross section	[A] / [mm ²]
Description	Color
Terminal block	gray blue gray
Ground terminal	green-yellow
Cover, width: 2.2 mm	gray

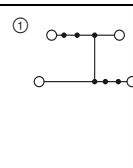

17.5 A, double-level terminal block with equipotential bonder

UL **IEC** **Ex**

Technical data ¹⁾				
Width	Length	Height		
5.2	88.2	49.9 (NS 35/7,5)		
I _{max} [A]	U _{max} [V]	max. Ø [mm ²]	AWG (UL)	
17.5	500	0.25 - 1.5	24-16	
24 (FBS) / 17.5 (FBSR)				
IEC	UL / CUL	CSA	Ex	
500	600	-	-	
Nominal current / cross section [A] / [mm ²]				
17.5 10 / - - / - - / -				

Ordering data			
Type	Order No.	Pcs./Pkt.	
QTTCBS 1,5-PV	① 3206380	50	

Accessories ¹⁾		
D-QTTCBS 1,5	Order No.	Pcs./Pkt.
D-QTTCBS 1,5	3206335	50

Terminal blocks – CLIPLINE complete

2.5 mm² QT fast connection terminal blocks

General technical data

Rated data		IEC 60947-7-1 / IEC 60947-7-2 / IEC 60947-7-3
Rated cross section	[mm ²]	2.5
Cross section range	AWG	20 - 14
Connection cross section in acc. with DIN VDE 0295		
H05V(Z) / H07V(Z)	[mm ²]	0.5 - 2.5
Class 5 / Class 6 [litz wires Ø ≥ 0.1 mm]	[mm ²]	-
[Litz wires Ø ≥ 0.19 mm]	AWG	20 - 14
Frequency of connections with the same cross section		100

Other conductor types and materials on request.

General data		
Insulating material	PA	
Flammability rating in accordance with UL 94	V0	
Wire diameter incl. insulation	≤ 3.8 mm	
Note: Additional or deviating data is listed alongside the respective product.		

Notes:



In addition to the product, the internal electrical wiring is provided as a circuit diagram. Free connection points for bridging are indicated by a black dot.

The specified technical data and approvals refer to the first product in each column. For information on the products below, please refer to phoenixcontact.net/products

For full details of UL and CSA use groups, file nos., and Internet links, please visit phoenixcontact.net/products

¹⁾ The bridge current is listed alongside the respective product. For additional colors, see page 402.

System accessories

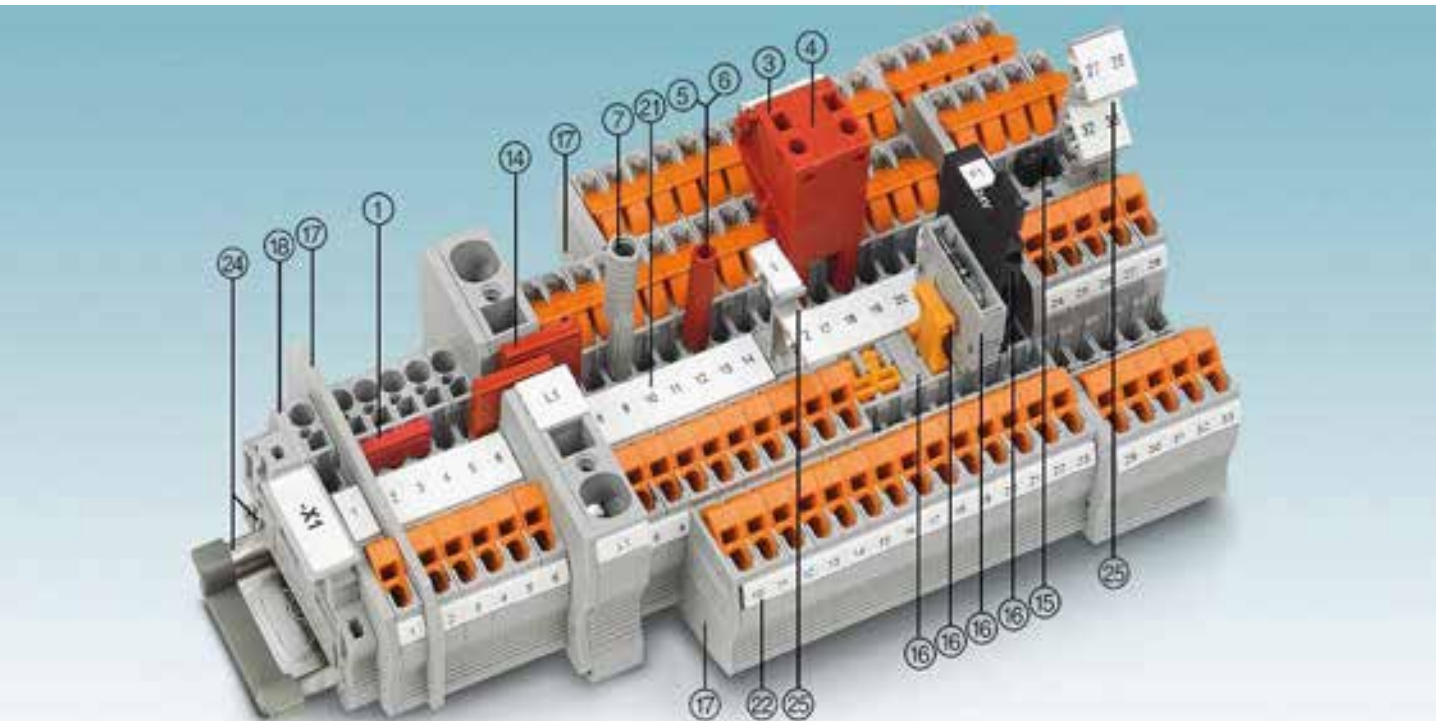

Description	No. of pos.	Color	Type	Order No.	Pcs./Pkt.	Type	Order No.	Pcs./Pkt.
① Bridge ¹⁾	2	red	FBS 2-6	3030336	50	FBSR 2-6	3033715	50
	3	red	FBS 3-6	3030242	50	FBSR 3-6	3001594	50
	4	red	FBS 4-6	3030255	50	FBSR 4-6	3001595	50
	5	red	FBS 5-6	3030349	50	FBSR 5-6	3001596	50
	10	red	FBS 10-6	3030271	10	FBSR 10-6	3033716	10
③ Modular test plug	20	red	FBS 20-6	3030365	10			
④ Spacer plate		red	PS-6	3030996	10			
⑤ Test plug metal part		red	DP PS-6	3036738	10			
⑥ Insulating sleeve, for MPS metal part		gray	MPS-MT	0201744	10			
⑦ Test adapter, 4 mm socket hole		red	MPS-IH RD	0201676	10			
Screwdriver		gray	PAI-4-N GY	3032871	10			
			SZF 1-0,6X3,5	1204517	10			

⑭ Reducing bridge	For RB ..., see page 408.
⑮ Vertical potential bridge	For FBS ..., see page 404.
⑰ Partition plates/end cover segments	For ATP-... / DS-..., visit phoenixcontact.net/products
⑱ Cover	Listed alongside the respective product.
⑲ Center groove labeling	UC-TM 6, UCT-TM 6 or ZB 6. See also Catalog 3, selection tables, from page 60.
⑳ Center and side groove labeling	UC-TMF 6, UCT-TMF 6 or ZBF 6. See also Catalog 3, selection tables, from page 60.
㉑ DIN rail and end bracket	See Catalog 3
㉒ Marker carrier	For STP ..., see page 418.
For full accessories, visit phoenixcontact.net/products	Note: Additional or deviating accessories are listed alongside the respective product.

Feed-through and disconnect terminal blocks

Notes:
 1) For additional accessories and technical data, see page 262.
 2) Current and voltage are determined by the plug used.
 For information on installation and using accessories for Ex applications, see page 678.

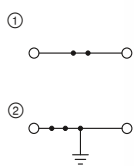

24 A, feed-through terminal block

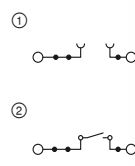

20 A, disconnect terminal block

ClassNK

Ex: EAC Ex IEC Ex
 KEMA 05ATEX2148 U / IECEx KEM 07.0010U

Technical data¹⁾

Width	Length	Height		
6.2	62.6	39.3 (NS 35/7,5)		
I _{max.} [A]	U _{max.} [V]	max. Ø [mm ²]	AWG (UL)	
24	800	0.5 - 2.5	20-14	
32 (FBS) / 24 (FBSR)				
IEC	UL / CUL	CSA	Ex	
800	600	600	550	
24 / 2.5	15 / -	15 / -	22.5 / 2.5	

Ordering data

Type	Order No.	Pcs./Pkt.
QTC 2,5	3206416	50
QTC 2,5 BU	3206429	50
QTC 2,5-PE	3206432	50

Accessories¹⁾

D-QTC 2,5	Order No.	Pcs./Pkt.
D-QTC 2,5	3206568	50

ClassNK

Ex: EAC Ex IEC Ex

Technical data¹⁾

Width	Length	Height		
6.2	82.5	39.3 (NS 35/7,5)		
I _{max.} [A]	U _{max.} [V]	max. Ø [mm ²]	AWG (UL)	
20 ²⁾	400 ²⁾	0.5 - 2.5	20-14	
32 (FBS) / 24 (FBSR)				
IEC	UL / CUL	CSA	Ex	
400 ²⁾	300	600	-	
20 / 2.5	15 / -	15 / -	- / -	

Ordering data

Type	Order No.	Pcs./Pkt.
QTC 2,5-TG	3206490	50
QTC 2,5-MT	3206487	50

Accessories¹⁾

D-QTC 2,5-TWIN	Order No.	Pcs./Pkt.
D-QTC 2,5-TWIN	3206571	50

Multi-conductor terminal blocks

Notes:
 1) For additional accessories and technical data, see page 262.
 For information on installation and using accessories for Ex applications, see page 678.

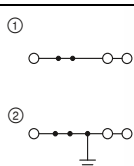

24 A, feed-through terminal block, 3 connections

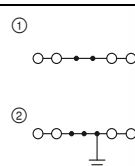

24 A, feed-through terminal block, 4 connections

ClassNK

Ex: EAC Ex IEC Ex
 KEMA 05ATEX2148 U / IECEx KEM 07.0010U

Technical data¹⁾

Width	Length	Height		
6.2	82.5	39.3 (NS 35/7,5)		
I _{max.} [A]	U _{max.} [V]	max. Ø [mm ²]	AWG (UL)	
24	800	0.5 - 2.5	20-14	
32 (FBS) / 24 (FBSR)				
IEC	UL / CUL	CSA	Ex	
800	600	600	550	
24 / 2.5	15 / -	15 / -	22.5 / 2.5	

Ordering data

Type	Order No.	Pcs./Pkt.
QTC 2,5-TWIN	3206445	50
QTC 2,5-TWIN BU	3206461	50
QTC 2,5-TWIN-PE	3206474	50

Accessories¹⁾

D-QTC 2,5-TWIN	Order No.	Pcs./Pkt.
D-QTC 2,5-TWIN	3206571	50

ClassNK

Ex: EAC Ex IEC Ex

Technical data¹⁾

Width	Length	Height		
6.2	102.4	39.3 (NS 35/7,5)		
I _{max.} [A]	U _{max.} [V]	max. Ø [mm ²]	AWG (UL)	
24	800	0.5 - 2.5	20-14	
32 (FBS) / 24 (FBSR)				
IEC	UL / CUL	CSA	Ex	
800	600	600	-	
24 / 2.5	15 / -	15 / -	- / -	

Ordering data

Type	Order No.	Pcs./Pkt.
QTC 2,5-QUATTRO	3206446	50
QTC 2,5-QUATTRO BU	3206447	50
QTC 2,5-QUATTRO-PE	3206448	50

Accessories¹⁾

D-QTC 2,5-QUATTRO	Order No.	Pcs./Pkt.
D-QTC 2,5-QUATTRO	3206449	50

Terminal blocks – CLIPLINE complete

2.5 mm² QT fast connection terminal blocks

Fuse terminal blocks and lever-type disconnect terminal blocks of the same shape

Notes:
1) For additional accessories and technical data, see page 262.
2) If the fuse is faulty, the downstream circuit is not off load.
3) For max. power dissipation, see page 694.
4) The current is determined by the fuse used, the voltage by the LED display.

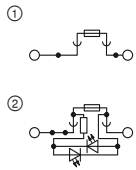

6.3 A, lever-type fuse terminal block for 5 x 20 mm cartridge fuses



Technical data ¹⁾				
Width	Length	Height		
6.2	82.5	64.9 (NS 35/7,5)		
I _{max} [A]	U _{max} [V]	max. Ø [mm ²]	AWG (UL)	
6.3 ³⁾	500 ⁴⁾	0.5 - 2.5	20-14	
32 (FBS) / 24 (FBSR)				
IEC	UL / CUL	CSA	Ex	
500 ⁴⁾	300	300	-	
6.3 / 1.5	15 / -	10 / -	- / -	

Ordering data			
Type	Order No.	Pcs./Pkt.	
QTC 2,5-HESI (5X20)	① 3050293	50	
QTC 2,5-HESILED 24 (5X20)	② 3050374	50	
QTC 2,5 HESILED 60 (5X20)	② 3050390	50	
QTC 2,5-HESILA 250 (5X20)	② 3050387	50	

Accessories ¹⁾		
D-QTC 2,5-TWIN	Order No.	Pcs./Pkt.
D-QTC 2,5-TWIN	3206571	50

Dimensions	[mm]
Maximum electrical data	
Maximum bridge current	[A]
Rated data	
Rated voltage	[V]
Nominal current / cross section	[A] / [mm ²]

Description	Color
Fuse terminal block	black
With LED display 12 ... 30 V AC/DC, 0.31 ... 0.95 mA ²⁾	black
30 ... 60 V AC/DC, 0.40 ... 0.86 mA ²⁾	black
110 ... 250 V AC/DC, 0.41 ... 0.96 mA ²⁾	black
Lever-type disconnect terminal block	black/orange

Cover, width: 2.2 mm	gray
-----------------------------	------

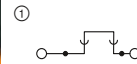

20 A, lever-type disconnect terminal block, same shape



Technical data ¹⁾				
Width	Length	Height		
6.2	82.5	64.9 (NS 35/7,5)		
I _{max} [A]	U _{max} [V]	max. Ø [mm ²]	AWG (UL)	
20	500	0.5 - 2.5	20-14	
32 (FBS) / 24 (FBSR)				
IEC	UL / CUL	CSA	Ex	
500	300	300	-	
20 / 2.5	15 / -	15 / -	- / -	

Ordering data			
Type	Order No.	Pcs./Pkt.	
QTC 2,5-HEDI	① 3206678	50	

Accessories ¹⁾		
D-QTC 2,5-TWIN	Order No.	Pcs./Pkt.
D-QTC 2,5-TWIN	3206571	50

Hybrid terminal blocks with screw connection on one side, 4 (6) mm²

Notes:
1) For additional accessories and technical data, see page 262.
2) For screw connection rated data, visit phoenixcontact.net/products
For information on installation and using accessories for Ex applications, see page 678.

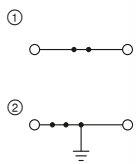

24 A, feed-through terminal block



Ex: EAC Ex IEC Ex
KEMA 05ATEX2148 U / IECEx KEM 07.0010U

Technical data ¹⁾				
Width	Length	Height		
6.2	62.6	42.8 (NS 35/7,5)		
I _{max} [A]	U _{max} [V]	max. Ø [mm ²]	AWG (UL)	
24	800	0.5 - 2.5	20-14	
32 (FBS) / 24 (FBSR)				
IEC	UL / CUL	CSA	Ex	
800	600	600	550	
24 / 2.5	15 / -	15 / -	22 / 2.5	

Ordering data			
Type	Order No.	Pcs./Pkt.	
QTCU 2,5	① 3206539	50	
QTCU 2,5 BU	① 3206542	50	
QTCU 2,5-PE	② 3206555	50	

Accessories ¹⁾		
D-QTCU 2,5	Order No.	Pcs./Pkt.
D-QTCU 2,5	3206597	50

Dimensions	[mm]
Maximum electrical data	
Maximum bridge current	[A]
Rated data²⁾	
Rated voltage	[V]
Nominal current / cross section	[A] / [mm ²]

Description	Color
Terminal block	gray
	blue
Ground terminal	green-yellow

Cover, width: 2.2 mm	gray
-----------------------------	------

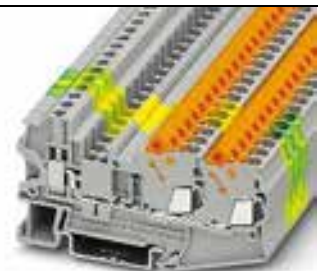
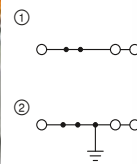

24 A, feed-through terminal block, 3 connections



Ex: EAC Ex IEC Ex
KEMA 05ATEX2148 U / IECEx KEM 07.0010U

Technical data ¹⁾				
Width	Length	Height		
6.2	82.5	42.8 (NS 35/7,5)		
I _{max} [A]	U _{max} [V]	max. Ø [mm ²]	AWG (UL)	
24	800	0.5 - 2.5	20-14	
32 (FBS) / 24 (FBSR)				
IEC	UL / CUL	CSA	Ex	
800	600	-	550	
24 / 2.5	15 / -	- / -	22 / 2.5	

Ordering data			
Type	Order No.	Pcs./Pkt.	
QTCU 2,5-TWIN	① 3050303	50	
QTCU 2,5-TWIN BU	① 3050316	50	
QTCU 2,5-TWIN-PE	② 3050329	50	

Accessories ¹⁾		
D-QTCU 2,5 TWIN	Order No.	Pcs./Pkt.
D-QTCU 2,5 TWIN	3050510	50

Hybrid disconnect terminal blocks with screw connection on one side, 4 (6) mm²

Notes:
1) For additional accessories and technical data, see page 262.
2) For screw connection rated data, visit phoenixcontact.net/products

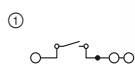

20 A, knife disconnect terminal block, 3 connections



Dimensions	[mm]
Maximum electrical data	
Maximum bridge current	[A]
Rated data²⁾	
Rated voltage	[V]
Nominal current / cross section	[A] / [mm ²]

Technical data ¹⁾			
Width	Length	Height	
6.2	79.3	42.8 (NS 35/7,5)	
I _{max} [A]	U _{max} [V]	max. Ø [mm ²]	AWG (UL)
20	400	0.5 - 2.5	20-14
20 (FBS) / 20 (FBSR)			
IEC	UL / CUL	CSA	Ex
400	300	300	-
20 / 2.5	15 / -	15 / -	- / -

Description	Color
Knife disconnect terminal block	gray blue

Ordering data		
Type	Order No.	Pcs./Pkt.
QTCU 2,5-TWIN-MT	① 3050304	50
QTCU 2,5-TWIN-MT BU	① 3050317	50

Cover, width: 2.2 mm	gray
-----------------------------	------

Accessories ¹⁾		
D-QTCU 2,5-TWIN-MT	3050511	50

Hybrid terminal blocks with spring-cage connection on one side, 4 (6) mm²

Notes:
1) For additional accessories and technical data, see page 262.
2) For spring-cage connection rated data, see page 228.
For information on installation and using accessories for Ex applications, see page 678.

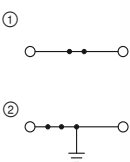

24 A, feed-through terminal block

UL ENEC EAC CE RoHS REACH ClassNK
 Ex: EAC Ex IEC Ex
 KEMA 05ATEX2148 U / IECEx KEM 07.0010U

Technical data ¹⁾			
Width	Length	Height	
6.2	59.7	39.3 (NS 35/7,5)	
I _{max} [A]	U _{max} [V]	max. Ø [mm ²]	AWG (UL)
24	800	0.5 - 2.5	20-14
32 (FBS) / 24 (FBSR)			
IEC	UL / CUL	CSA	Ex
800	600	-	550
24 / 2.5	15 / -	- / -	22.5 / 2.5

Ordering data			
Type	Order No.	Pcs./Pkt.	
QTCS 2,5	① 3206500	50	
QTCS 2,5 BU	① 3206513	50	
QTCS 2,5-PE	② 3206526	50	

Accessories ¹⁾		
D-QTCS 2,5	3206584	50

Dimensions	[mm]
Maximum electrical data	
Maximum bridge current	[A]
Rated data²⁾	
Rated voltage	[V]
Nominal current / cross section	[A] / [mm ²]

Description	Color
Terminal block	gray blue
Ground terminal	green-yellow

Cover, width: 2.2 mm	gray
-----------------------------	------

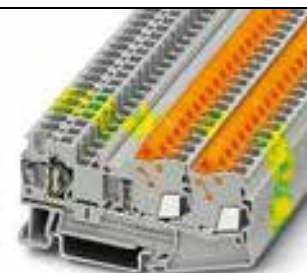
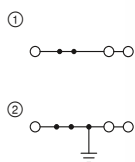

24 A, feed-through terminal block, 3 connections

UL ENEC EAC CE RoHS REACH ClassNK
 Ex: EAC Ex IEC Ex
 KEMA 05ATEX2148 U / IECEx KEM 07.0010U

Technical data ¹⁾			
Width	Length	Height	
6.2	79.6	39.3 (NS 35/7,5)	
I _{max} [A]	U _{max} [V]	max. Ø [mm ²]	AWG (UL)
24	800	0.5 - 2.5	20-14
32 (FBS) / 24 (FBSR)			
IEC	UL / CUL	CSA	Ex
800	600	-	550
24 / 2.5	15 / -	- / -	22.5 / 2.5

Ordering data			
Type	Order No.	Pcs./Pkt.	
QTCS 2,5-TWIN	① 3050332	50	
QTCS 2,5-TWIN BU	① 3050345	50	
QTCS 2,5-TWIN-PE	② 3050358	50	

Accessories ¹⁾		
D-QTCS 2,5 TWIN	3050523	50

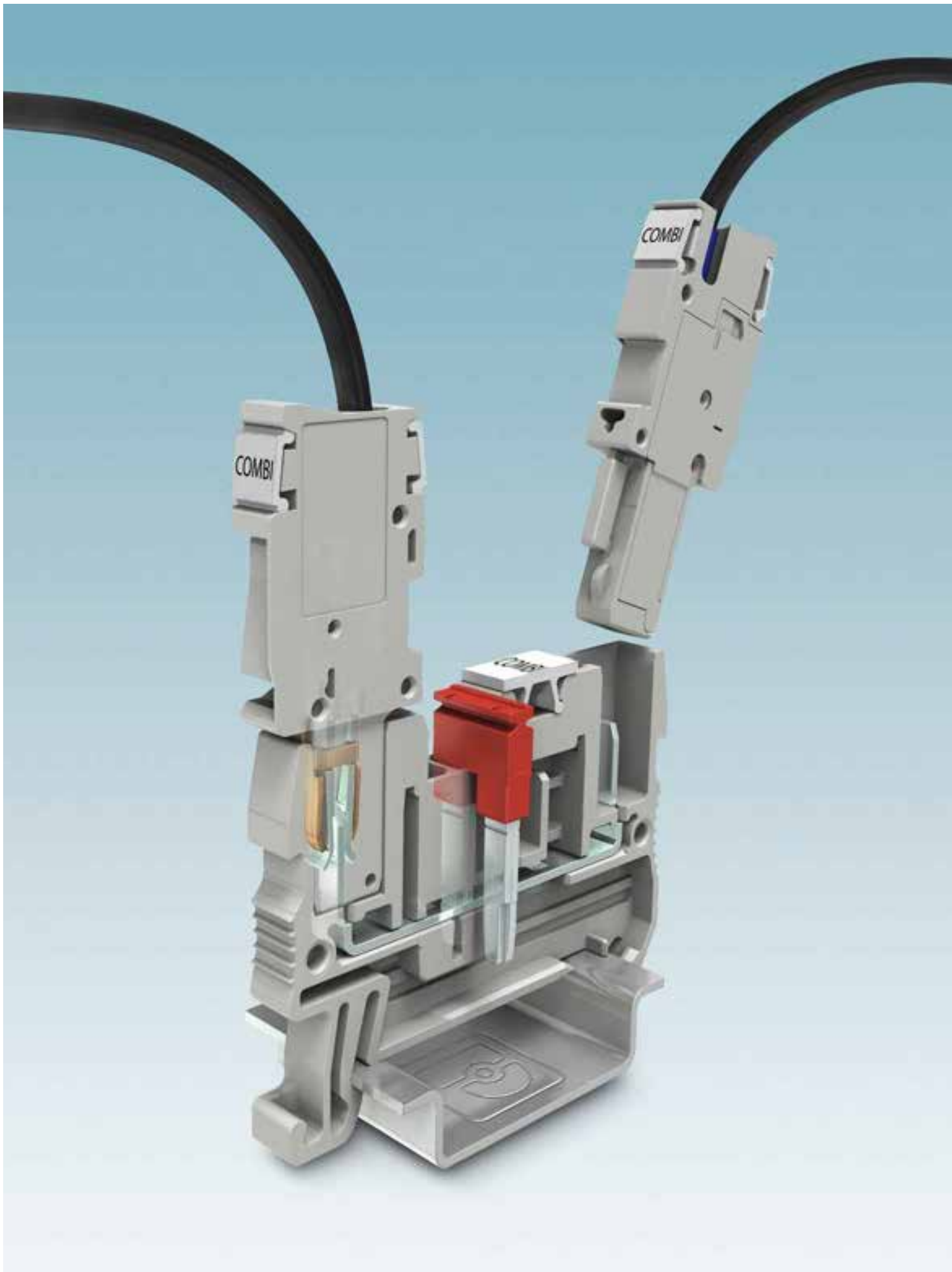

COMBI plug-in connection solutions

The COMBI connection system enables the time-saving and modular configuration of your application. Its distinguishing feature is its standardized plug-in zone. This allows you to combine basic terminal blocks which are available in Push-in, spring-cage, fast connection, and screw connection versions with one another in any configuration.

The rated values of up to 41 A and 1000 V has made a plug-in system for signal and power wiring possible. The system meets the most stringent of vibration requirements. Both the terminal blocks and the plugs are of a touch-proof design.

In addition, all plugs can be individually assembled, i.e., they can be adapted to match the required number of positions in each application. The COMBI plug-in system can be combined with the CES cable entry system (see Catalog 2) by routing the pre-assembled cables with a high degree of protection (IP54) into control cabinets and housing in a manner that saves space. This produces a quick and low-cost alternative to using heavy-duty plug-in plugs.

Push-in connection

i Your web code: [#1276](#)

Screw connection

i Your web code: [#1400](#)

Spring-cage connection

i Your web code: [#1398](#)

Quick connection

i Your web code: [#1399](#)

Product range overview

1.5 mm²

Push-in connection	277
Fast connection	287

2.5 mm²

Push-in connection	291
Screw connection	303
Spring-cage connection	309

4 mm²

Push-in connection	325
Screw connection	329
Spring-cage connection	339

6 mm²

Push-in connection	347
Screw connection	355

Accessories

358

Cabling options with the COMBI connection system

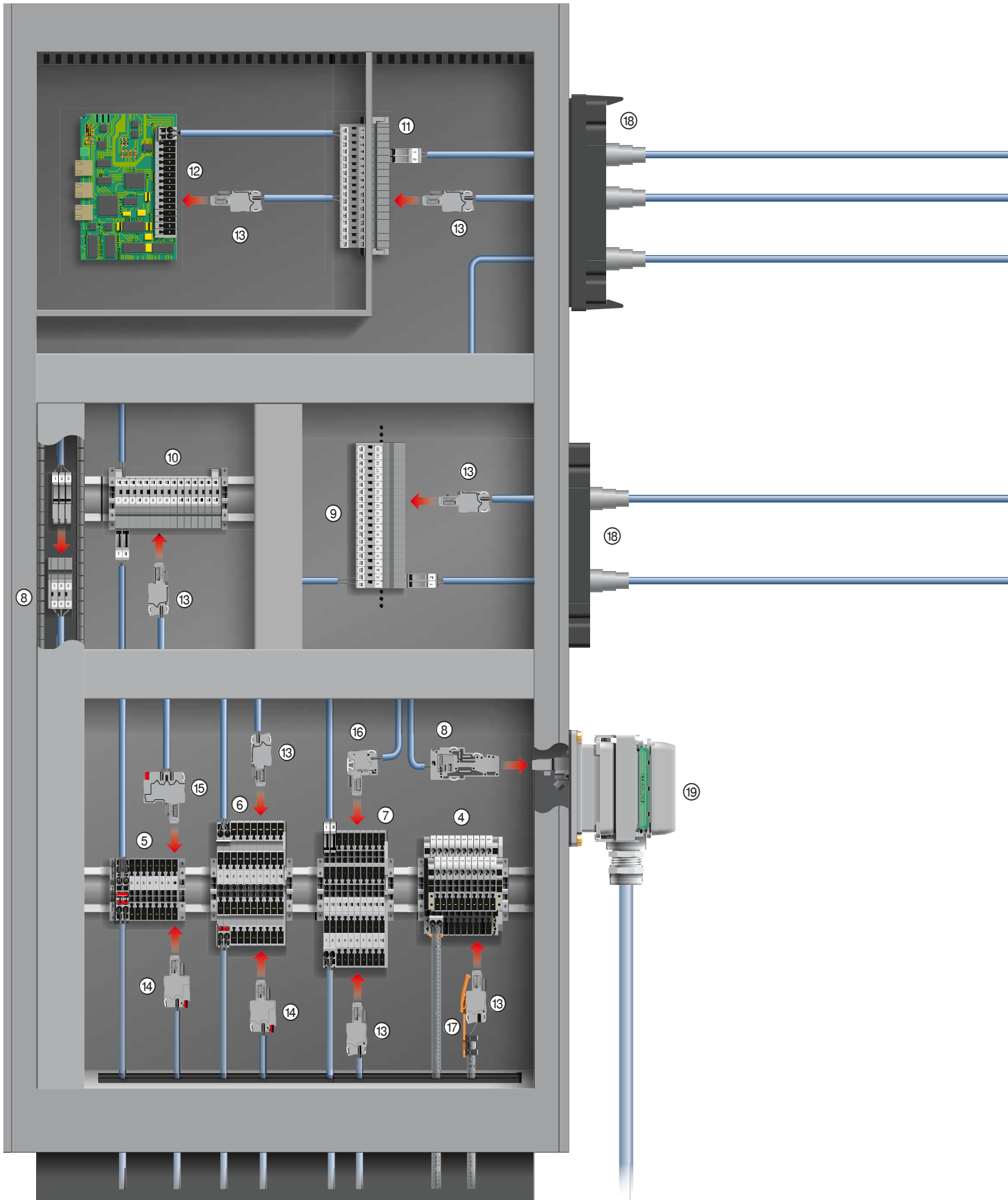

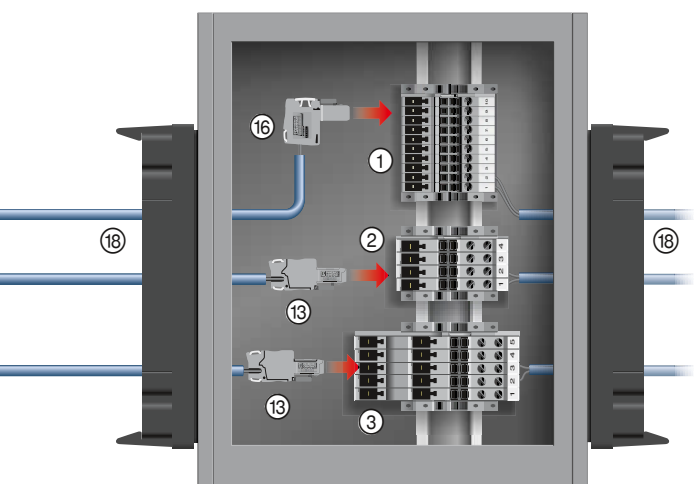

- ① Feed-through terminal blocks with one connector outlet
- ② Multi-conductor terminal blocks with one connector outlet
- ③ Multi-conductor terminal blocks with two connector outlets
- ④ Double-level terminal blocks with one connector outlet per level
- ⑤ Male-male feed-through terminal blocks
- ⑥ Male-male multi-conductor terminal blocks
- ⑦ Male-male double-level terminal blocks
- ⑧ Couplings for flying leads
- ⑨ Couplings with securing pin for direct mounting
- ⑩ Couplings for DIN rail mounting
- ⑪ Coupling for panel feed-through
- ⑫ Header for the PCB connection
- ⑬ Connector with conductor exit in plug-in direction
- ⑭ Bridgeable connector with conductor exit in plug-in direction
- ⑮ Bridgeable two-conductor connector with conductor exit in plug-in direction
- ⑯ Connector with conductor exit perpendicular to plug-in direction
- ⑰ Optional snap-on connector accessories, e.g. latching with shield connection
- ⑱ CES cable entry system with IP54/IP65 protection, see Catalog 2
- ⑲ IP67 heavy-duty connector, see Catalog 2

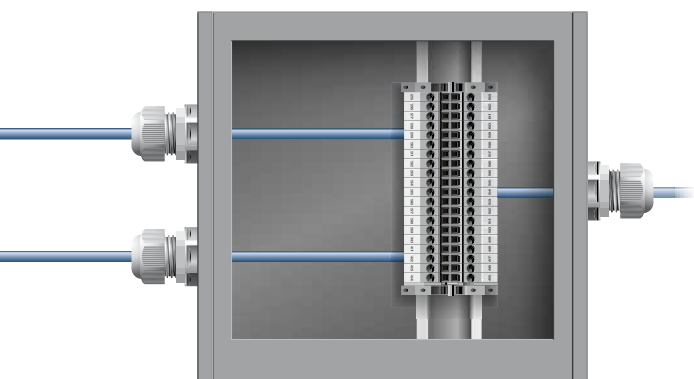

It is impossible to imagine today's applications without plug-in solutions – whether in control cabinets or in complete systems. It is here that the COMBI connection system offers users unlimited flexibility. From supplying the control cabinet and the power and control components to the quick installation of distributed system parts, the COMBI connection system always delivers the perfect solution.

There are numerous advantages to this system. Plug-in components inside the control cabinet can be installed and removed quickly and easily. Plug-in ring feeders ensure reliable power supply from one control cabinet to another. Couplings for flying leads are not only suitable for

wiring in restricted spaces. They can also be used to easily extend pre-assembled cables.

The COMBI headers support the plug-in wiring of electronic devices or components.

The CES cable entry system allows users to route up to 40 pre-assembled connectors into the control cabinet while maintaining IP54/IP65 degree of protection. When it comes to increased requirements up to IP67 or control cabinet connection in harsh industrial environments, DUPLICON is the ideal connection component.

The flexible and extensive options offered by the standardized plug-in zone of the COMBI system have won over several well-known companies.

Cross-reference list Terminal blocks – connectors

Connector









PT Push-in connection					UT screw connection			
PP-H 1,5/S Page 284	PP-H 2,5 Page 298	PP 2,5 Page 300	PP-H 4 Page 327	PP-H 6 Page 352	UPBV 2,5... Page 306	UPBV 4... Page 335	UP 4... Page 336	UP 6... Page 356

Feed-through terminal blocks										
PT 1,5/S/1P / MPT 1,5/S/1P	Page 277									
QTC 1,5/1P	Page 287									
PT 2,5/1P, ST 2,5/1P	Page 291									
UT 2,5/1P	Page 303									
PT 4/1P, ST 4/1P	Page 325									
UT 4/1P, UT 4/ 1P-H	Page 329									
PT 6/1P	Page 347									
UT 6/1P	Page 355									
Feed-through terminal blocks, three connections										
PT 1,5/S-TWIN/1P	Page 277									
PT 2,5-TWIN/1P, ST 2,5-TWIN/1P	Page 291									
UT 2,5-TWIN/1P	Page 303									
PT 4-TWIN/1P	Page 325									
UT 4-TWIN/1P	Page 329									
Knife disconnect terminal blocks										
ST 2,5-TWIN-MT/1P	Page 310									
ST 2,5-TWIN-TG/1P	Page 310									
Feed-through terminal blocks, four connections										
PT 1,5/S-QUATTRO/2P	Page 277									
PT 2,5-QUATTRO/2P ST 2,5-QUATTRO/2P	Page 291)				
PT 4-QUATTRO/2P ST 4-QUATTRO/2P	Page 325)			
UT 4-QUATTRO/2P	Page 329)			
ST 4-QUATTRO/4CP	Page 340)))		
PT 6-QUATTRO/2P	Page 347									
UT 6-QUATTRO/2P	Page 355									
Feed-through terminal blocks, six connections										
PT 2,5-HEXA/3P	Page 291)				
Double-level terminal blocks										
PTTB 1,5/S/2P	Page 277									
QTTCB 1,5/2P	Page 287									
PTTB 2,5/2P	Page 292)				
PTTBS 2,5/2P PTTBS 2,5-TWIN/2P	Page 292)				
UTTB 2,5/2P	Page 303									
STTB 2,5/2P	Page 309									
Male-male versions										
ST 2,5/2P	Page 293									
ST 2,5-QUATTRO/4P	Page 293)				
STTB 2,5/4P	Page 293									
ST 4/2P	Page 325									









1) Can only be used on the external connection pins of the basic terminal block.
 2) Can only be used on the internal connection pins of the basic terminal block.
 3) Can only be used on one side of the basic terminal block.

Cross-reference list Couplings – connectors

Connector

PT Push-in connection					UT screw connection			
PP-H 1,5/S Page 284	PP-H 2,5 Page 298	PP 2,5 Page 300	PP-H 4 Page 327	PP-H 6 Page 352	UPBY 2,5... Page 306	UPBY 4... Page 335	UP 4... Page 336	UP 6... Page 356
								

Coupling	Couplings								
	PPC 1,5/S	Page 282							
	PPC 2,5/...	Page 295							
	SC 2,5/...	Page 313							
	SC 4/...	Page 341							
	PPC 6/...	Page 350							
	Couplings with securing pin								
	SC 2,5-RZ/...	Page 314							
	SC 4-RZ/...	Page 342							
	Couplings with snap-on foot								
	PPC 1,5/S-NS/1-L	Page 283							
	PPC 2,5-NS/1-L	Page 296							
	SC 2,5-NS/1-L	Page 316							
	SC 4-NS/1-L	Page 343							
	PPC 6-NS/1-L	Page 350							
Header for PCB connection technology									
ST 2,5-PCB/...G-5,2	Page 297								
ST 4-PCB/...G-6,2	Page 326								
ST 2,5-PCBV/...G-5,2	Page 297								
ST 4-PCBV/...G-6,2	Page 326								

ST spring-cage connection						QT fast connection	CP connector housing
SP 2,5... Page 318	SP-H 2,5... Page 319	SPV 2,5... Page 320	SPB 2,5... Page 321	SPDB 2,5... Page 322	SP 4... Page 345	QP 1,5 Page 288	CP 2,5 ... Page 365
							

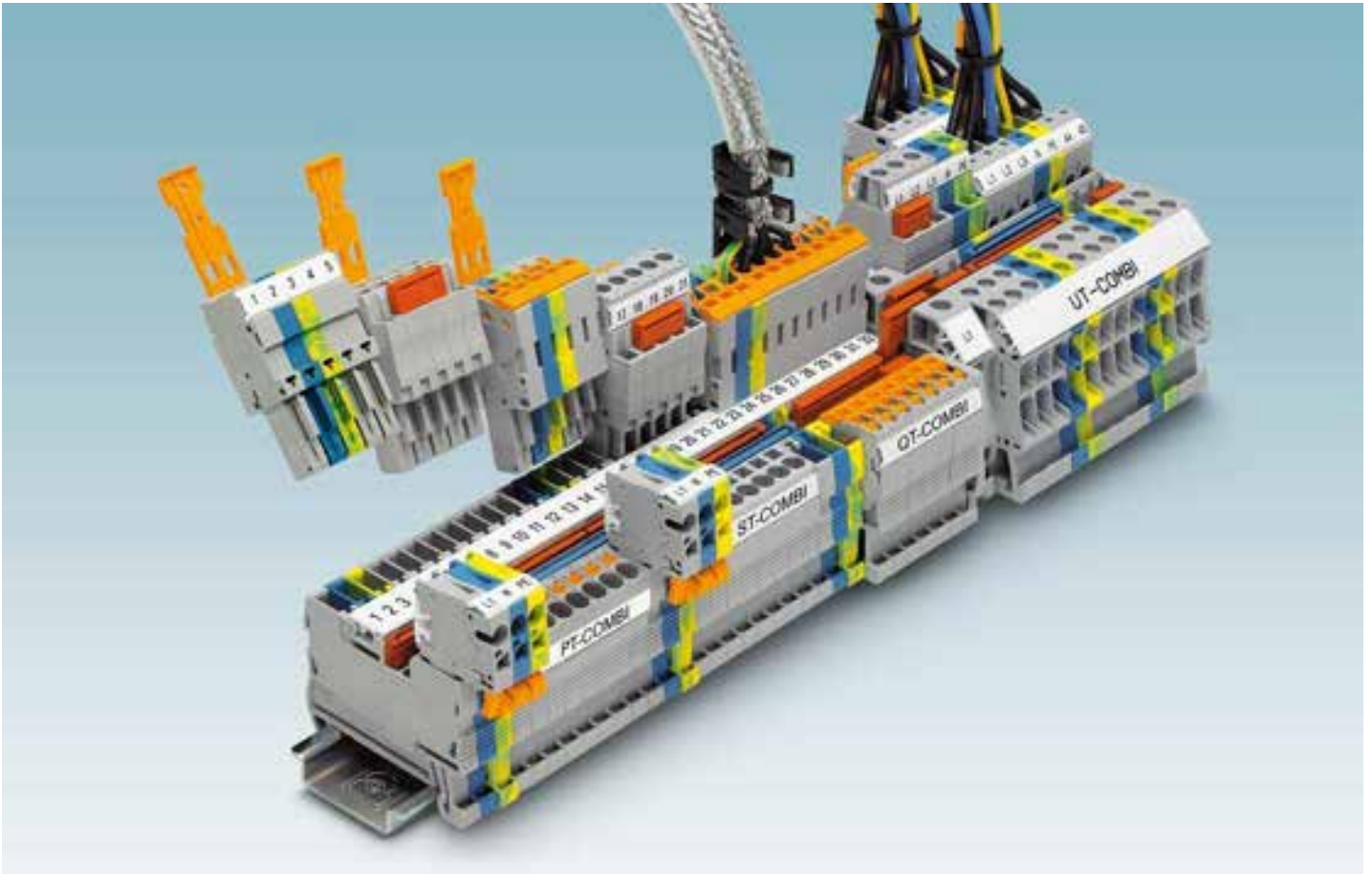

Push-in connection

i Your web code: [#1276](#)

Screw connection

i Your web code: [#1400](#)

Spring-cage connection

i Your web code: [#1398](#)

Quick connection

i Your web code: [#1399](#)



Flexible and plug-in

The COMBI family offers a free choice of connection methods. The standardized COMBI plug-in zone allows terminal blocks and plugs to be combined to suit the application regardless of connection method.



Powerful contact

The COMBI connection system enables a plug-in wiring solution up to a nominal current of 41 A and a nominal voltage of 1000 V. The contact system features an integrated covering spring so that it can withstand extreme vibration levels.



Touch proof

The COMBI system offers the highest levels of protection for users, as both the basic terminal blocks and the plugs are touch-proof. Alongside the safety aspect, this offers great flexibility for configuration work. The supply can be routed through the terminal blocks or plugs.

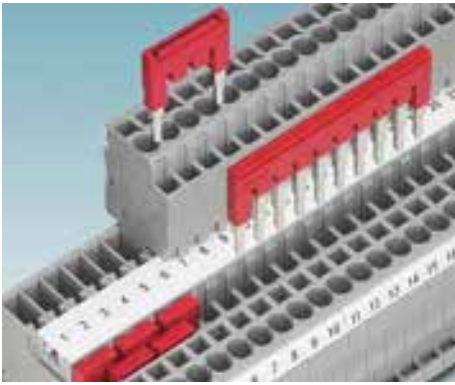

The standardized bridge system enables up to 50 terminal blocks to be connected with one bridge in an efficient manner suited to the application. Non-adjacent terminal blocks can be bridged by removing individual forks.

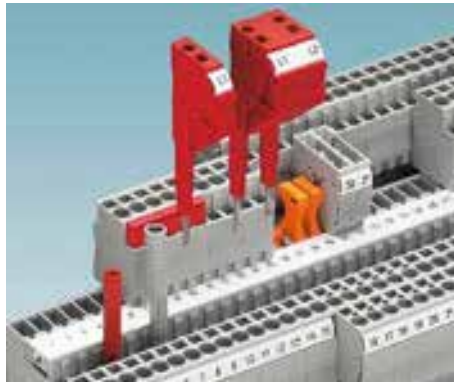

For measuring lines, a test plug with 2.3 mm diameter is available. All measurement and testing tasks can be carried out quickly using test adapters for 4 mm diameter test plugs and the alignable test plugs.



Connectors with different conductor output directions (to the side or upwards) allow for practical, efficient wiring. This results in great flexibility as required in various areas of application.

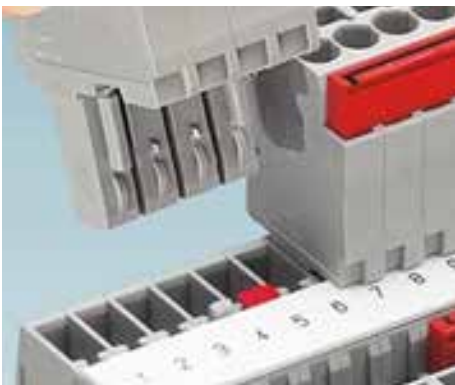

The simple and individual coding option increases wiring reliability and also protects against incorrect connecting. To do this, the pin must be released from the plug, turned and inserted in the basic terminal block.

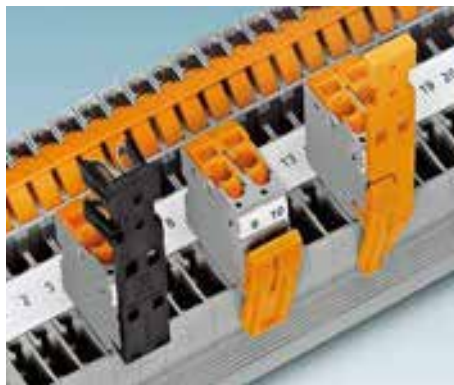

Snap-on strain relief is available to relieve the strain on cables at the connectors. Latching is also available and can be used to permanently fix connectors to basic terminal blocks.



The cable housing provides robust strain relief. These housings are split in two, making them easy to fit and safe to latch onto the COMBI connectors provided. Anti-kink devices and overall shielding braids are available as accessories.



Panel feed-throughs can be produced efficiently by simply snapping the SSL panel feed-through onto the standard receptacle. The panel feed-through is slid into the cut-out and automatically latches into place.



A receptacle version which can be fitted on rails offers a solution for applications with a low build height. The integrated duo foot allows for mounting on both NS 15 and NS 35 DIN rails.



The COMBI header is an alignable PCB connection. Universal plug-in solutions from the DIN rail through to the device can therefore be implemented with the same plug.

Terminal blocks – CLIPLINE complete

1.5 mm² COMBI PT plug-in connection solutions

General technical data

Rated data		IEC 61984
Rated cross section	[mm ²]	1.5
Cross section range	AWG	26 - 14
Connection capacity		Rigid Flexible Ferrule without/with plastic sleeve
1 conductor	[mm ²]	0.14 - 1.5 0.14 - 1.5 0.14 - 1.5 0.14 - 1
2 flexible conductors with a TWIN ferrule	[mm ²]	- - - -
Connection cross sections directly plug-in	[mm ²]	0.25 - 1.5 - 0.34 - 1.5 0.34 - 1
General data		
Stripping length	[mm]	8 - 10
Insulating material		PA
Flammability rating in accordance with UL 94		V0

Note: Additional or deviating data is listed alongside the respective product.

Notes:



In addition to the product, the internal electrical wiring is provided as a circuit diagram. Free connection points for bridging are indicated by a black dot.

The specified technical data and approvals refer to the first product in each column. For information on the products below, please refer to phoenixcontact.net/products

For full details of UL and CSA use groups, file nos., and Internet links, please visit phoenixcontact.net/products

¹⁾ The bridge current is listed alongside the respective product. For additional colors, see page 402.

System accessories

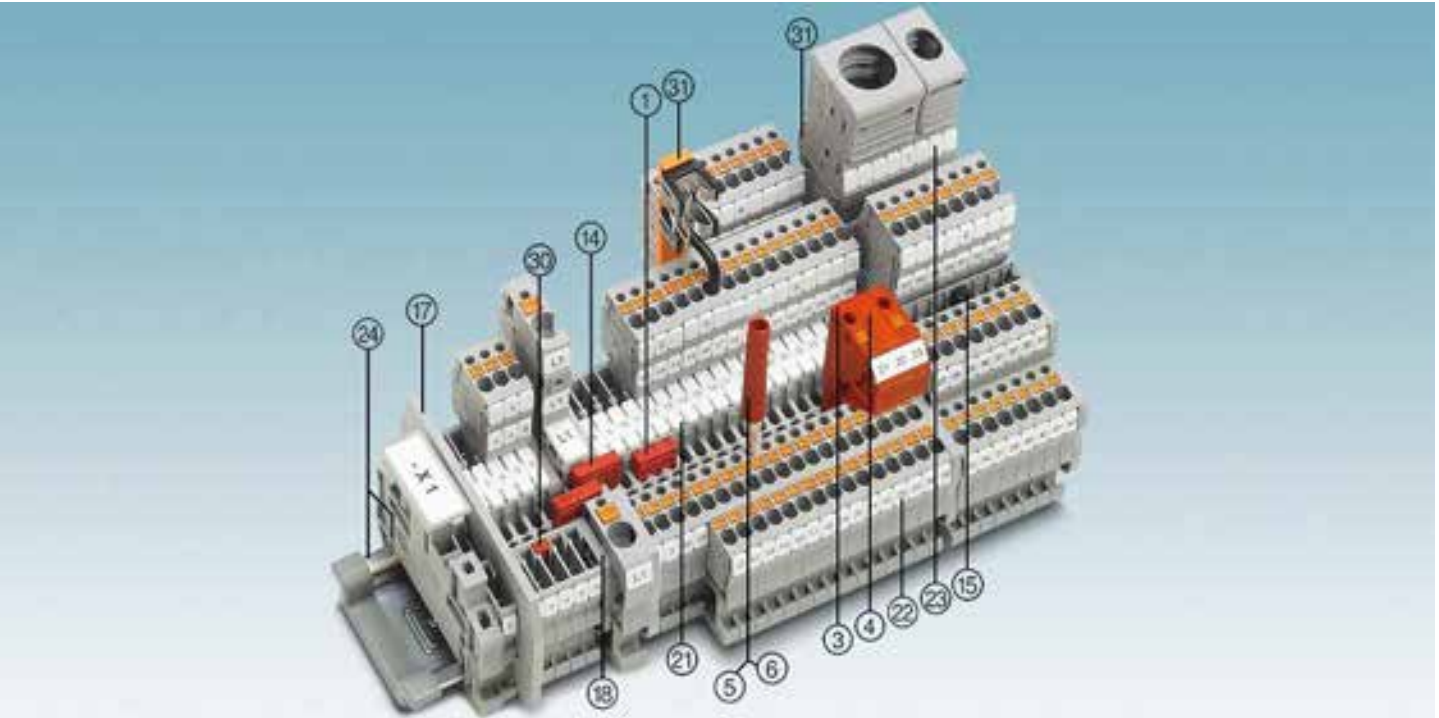

Description	No. of pos.	Color	Type	Order No.	Pcs./Pkt.	Type	Order No.	Pcs./Pkt.
① Bridge ¹⁾	2	red	FBS 2-3,5	3213014	50			
	3	red	FBS 3-3,5	3213027	50			
	4	red	FBS 4-3,5	3213030	50			
	5	red	FBS 5-3,5	3213043	50			
	10	red	FBS 10-3,5	3213056	50			
	20	red	FBS 20-3,5	3213069	50			
③ Modular test plug		red	PS-3,5	3031010	10			
④ Spacer plate		red	DP PS-3,5	3031011	10			
⑤ Test plug metal part		gray	MPS-MT	0201744	10			
⑥ Insulating sleeve, for MPS metal part		red	MPS-IH RD	0201676	10			
③ Coding profile		red	PC	3040588	50			
Screwdriver			SZF 0-0,4X2,5	1204504	10			

⑭ Reducing bridge	For RB ..., see page 408.
⑮ Vertical potential bridge	For FBS 1,5/S-PV ..., see page 404.
⑰ Partition plates/end cover segments	For ATP-... / DS-..., visit phoenixcontact.net/products
⑱ Cover	Listed alongside the respective product.
⑲ Center groove labeling	UCT-TM 3,5 or ZB 3,5. See also Catalog 3, selection tables, from page 60.
⑳ Center and side groove labeling	UCT-TMF 3,5 or ZBF 3,5. See also Catalog 3, selection tables, from page 60.
㉑ Lateral groove labeling	UCT-TMF 3,5 or ZBF 3,5. See also Catalog 3, selection tables, from page 60.
㉒ DIN rail and end bracket	See Catalog 3
㉓ Latching, strain relief, shielding	See from page 362.
For full accessories, visit phoenixcontact.net/products	Note: Additional or deviating accessories are listed alongside the respective product.

Feed-through, multi-conductor, multi-level, and ground terminal blocks

Notes:

- 1) For additional accessories and technical data, see page 276.
- 2) For derating curve, visit phoenixcontact.net/products

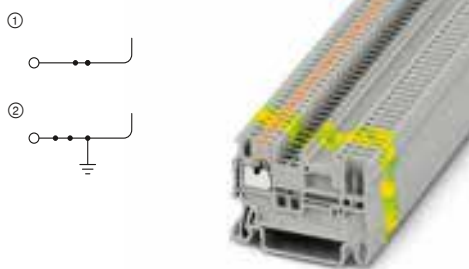

17.5 A, feed-through terminal block

UL ENEC EAC CB ClassNK

Technical data ¹⁾				
Width	Length	Height		
3.5	46	32 (NS 35/7,5)		
I_{max} [A]	U_{max} [V]	max. Ø [mm ²]	AWG (UL)	
17.5 ²⁾	500	0.14 - 1.5	26-14	
17.5				
IEC	UL / CUL	CSA	Ex	
500	600	600	-	
Nominal current / cross section [A] / [mm ²]		17.5 ²⁾ / 1.5	15 / -	- / -

Ordering data			
Type	Order No.	Pcs./Pkt.	
PT 1,5/S/1P	① 3208582	50	
PT 1,5/S/1P BU	① 3208595	50	
PT 1,5/S/1P-PE	② 3212332	50	

Accessories ¹⁾		
D-PT 1,5/S	Order No.	Pcs./Pkt.
D-PT 1,5/S	3208142	50

Dimensions	[mm]
Maximum electrical data	
Maximum bridge current	[A]
Rated data	
Rated voltage	[V]
Nominal current / cross section	[A] / [mm ²]

Description	Color
Terminal block	gray
	blue
Ground terminal	green-yellow

Cover, width: 2.2 mm	gray
----------------------	------

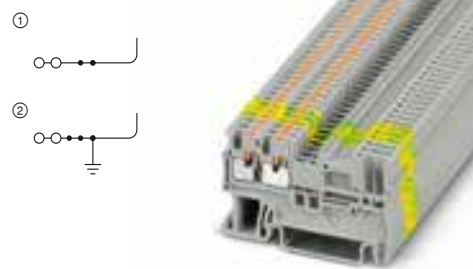

17.5 A, feed-through terminal block, 3 connections

UL ENEC EAC CB ClassNK

Technical data ¹⁾				
Width	Length	Height		
3.5	55	32 (NS 35/7,5)		
I_{max} [A]	U_{max} [V]	max. Ø [mm ²]	AWG (UL)	
17.5 ²⁾	500	0.14 - 1.5	26-14	
17.5				
IEC	UL / CUL	CSA	Ex	
500	600	600	-	
Nominal current / cross section [A] / [mm ²]		17.5 ²⁾ / 1.5	15 / -	- / -

Ordering data		
Type	Order No.	Pcs./Pkt.
PT 1,5/S-TWIN/1P	① 3212358	50
PT 1,5/S-TWIN/1P BU	① 3212361	50
PT 1,5/S-TWIN/1P-PE	② 3212374	50

Accessories ¹⁾		
D-PT 1,5/S-TWIN	Order No.	Pcs./Pkt.
D-PT 1,5/S-TWIN	3208184	50

Feed-through, multi-conductor, multi-level, and ground terminal blocks

Notes:

- 1) For additional accessories and technical data, see page 276.
- 2) For derating curve, visit phoenixcontact.net/products

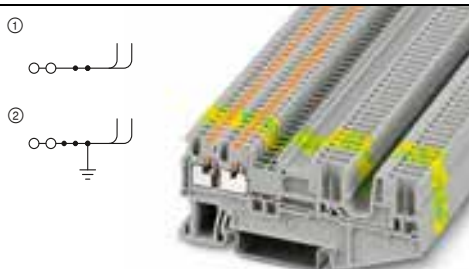

17.5 A, feed-through terminal block, 4 connections

UL ENEC EAC CB ClassNK

Technical data ¹⁾				
Width	Length	Height		
3.5	78.5	32 (NS 35/7,5)		
I_{max} [A]	U_{max} [V]	max. Ø [mm ²]	AWG (UL)	
17.5 ²⁾	500	0.14 - 1.5	26-14	
17.5				
IEC	UL / CUL	CSA	Ex	
500	600	600	-	
Nominal current / cross section [A] / [mm ²]		17.5 ²⁾ / 1.5	15 / -	- / -

Ordering data			
Type	Order No.	Pcs./Pkt.	
PT 1,5/S-QUATTRO/2P	① 3212390	50	
PT 1,5/S-QUATTRO/2P BU	① 3212400	50	
PT 1,5/S-QUATTRO/2P-PE	② 3212413	50	

Accessories ¹⁾		
D-PT 1,5/S-QUATTRO/2P	Order No.	Pcs./Pkt.
D-PT 1,5/S-QUATTRO/2P	3212426	50

Dimensions	[mm]
Maximum electrical data	
Maximum bridge current	[A]
Rated data	
Rated voltage	[V]
Nominal current / cross section	[A] / [mm ²]

Description	Color
Terminal block	gray
	blue
With potential distribution	gray
Ground terminal	green-yellow

Cover, width: 2.2 mm	gray
----------------------	------

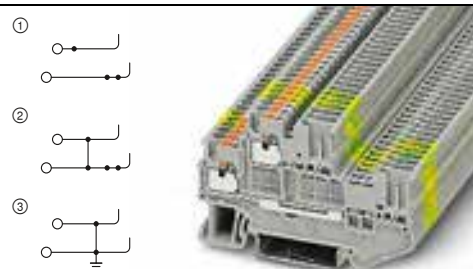

16 A, double-level terminal block

UL ENEC EAC CB ClassNK CB

Technical data ¹⁾				
Width	Length	Height		
3.5	69.3	42.6 (NS 35/7,5)		
I_{max} [A]	U_{max} [V]	max. Ø [mm ²]	AWG (UL)	
16 ²⁾	500	0.14 - 1.5	26-14	
17.5				
IEC	UL / CUL	CSA	Ex	
500	600	600	-	
Nominal current / cross section [A] / [mm ²]		16 ²⁾ / 1.5	15 / -	- / -

Ordering data		
Type	Order No.	Pcs./Pkt.
PTTB 1,5/S/2P	① 3212439	50
PTTB 1,5/S/2P BU	① 3212442	50
PTTB 1,5/S/2P-PV	② 3212468	50
PTTB 1,5/S/2P-PE	③ 3212455	50

Accessories ¹⁾		
D-PTTB 1,5/S/2P	Order No.	Pcs./Pkt.
D-PTTB 1,5/S/2P	3212471	50

Terminal blocks – CLIPLINE complete

1.5 mm² COMBI PT plug-in connection solutions

Mini feed-through and ground terminal blocks

Notes:
1) For additional accessories and technical data, see page 276.
2) For derating curve, visit phoenixcontact.net/products

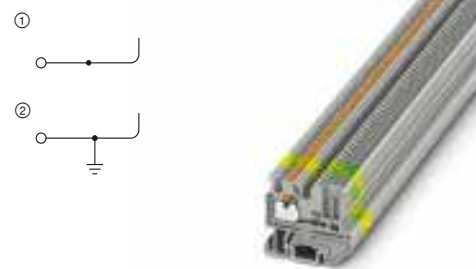

17.5 A, mini feed-through terminal block



Dimensions	[mm]
Maximum electrical data	
Maximum bridge current	[A]
Rated data	
Rated voltage	[V]
Nominal current / cross section	[A] / [mm ²]

Technical data ¹⁾			
Width	Length	Height	
3.5	33.55	28.1 (NS 15)	
I_{max} [A]	U_{max} [V]	max. \varnothing [mm ²]	AWG (UL)
17.5 ²⁾	500	0.14 - 1.5	26-14
17.5			
IEC	UL / CUL	CSA	Ex
500	600	600	-
17.5 ²⁾ / 1.5	15 / -	15 / -	- / -

Description	Color
Terminal block	gray blue
Ground terminal	green-yellow
Cover, width: 2.2 mm	gray

Ordering data		
Type	Order No.	Pcs./Pkt.
MPT 1,5/S/1P	① 3248115	50
MPT 1,5/S/1P BU	① 3248116	50
MPT 1,5/S/1P-PE	② 3248117	50

Accessories ¹⁾		
D-MPT 1,5/S	3248120	50

Feed-through, multi-conductor, multi-level, and ground terminal blocks

Notes:
1) For additional accessories and technical data, see page 276.
2) For derating curve, visit phoenixcontact.net/products

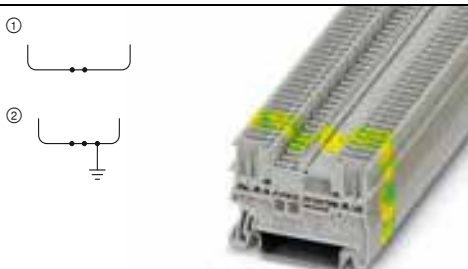

17.5 A, feed-through terminal block

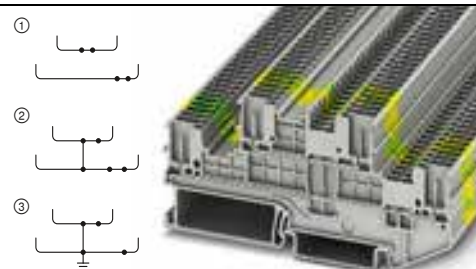

16 A, double-level terminal block



Technical data ¹⁾			
Width	Length	Height	
3.5	45.8	32 (NS 35/7,5)	
I_{max} [A]	U_{max} [V]	max. \varnothing [mm ²]	AWG (UL)
17.5 ²⁾	500	0.14 - 1.5	-
17.5			
IEC	UL / CUL	CSA	Ex
500	600	-	-
17.5 ²⁾ / 1.5	15 / -	- / -	- / -

Ordering data		
Type	Order No.	Pcs./Pkt.
PT 1,5/S/2P	① 3213784	50
PT 1,5/S/2P BU	① 3213797	50
PT 1,5/S/2P-PE	② 3213810	50

Accessories ¹⁾		
D-PT 1,5/S	3208142	50



Technical data ¹⁾			
Width	Length	Height	
3.5	93.9	42.6 (NS 35/7,5)	
I_{max} [A]	U_{max} [V]	max. \varnothing [mm ²]	AWG (UL)
16 ²⁾	500	0.14 - 1.5	-
17.5			
IEC	UL / CUL	CSA	Ex
500	600	-	-
16 ²⁾ / 1.5	15 / -	- / -	- / -

Ordering data		
Type	Order No.	Pcs./Pkt.
PTTB 1,5/S/4P	① 3213865	50
PTTB 1,5/S/4P BU	① 3213878	50
PTTB 1,5/S/4P-PV	② 3213852	50
PTTB 1,5/S/4P-PE	③ 3213881	50

Accessories ¹⁾		
D-PTTB 1,5/S/4P	3213894	50

Feed-through, multi-conductor, multi-level, and ground terminal blocks

Notes:
 1) For additional accessories and technical data, see page 276.
 2) For derating curve, visit phoenixcontact.net/products

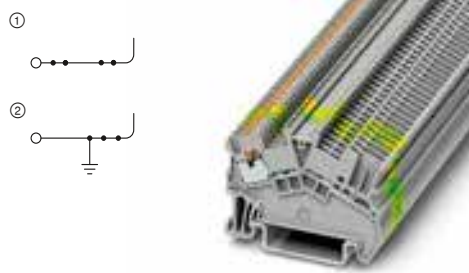

17.5 A, feed-through terminal block

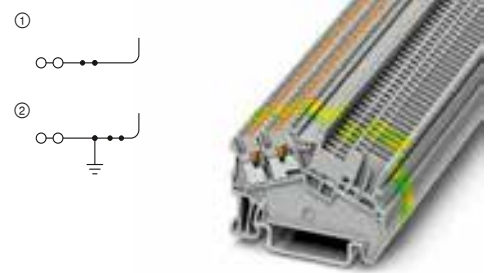

17.5 A, feed-through terminal block, 3 connections



Technical data ¹⁾				
Width	Length	Height		
3.5	50.7	38.5 (NS 35/7,5)		
I_{max} [A]	U_{max} [V]	max. Ø [mm ²]	AWG (UL)	
17.5 ²⁾	500	0.14 - 1.5	26-14	
17.5				
IEC	UL / CUL	CSA	Ex	
500	600	600	-	
Nominal current / cross section	[A] / [mm ²]	15 / -	15 / -	

Technical data ¹⁾				
Width	Length	Height		
3.5	50.7	38.5 (NS 35/7,5)		
I_{max} [A]	U_{max} [V]	max. Ø [mm ²]	AWG (UL)	
17.5 ²⁾	500	0.14 - 1.5	26-14	
17.5				
IEC	UL / CUL	CSA	Ex	
500	600	600	-	
Nominal current / cross section	[A] / [mm ²]	15 / -	15 / -	

Ordering data			
Type	Order No.	Pcs./Pkt.	
PTS 1,5/S/1P	① 3214453	50	
PTS 1,5/S/1P BU	① 3214466	50	
PTS 1,5/S/1P-PE	② 3214479	50	

Ordering data			
Type	Order No.	Pcs./Pkt.	
PTS 1,5/S-TWIN/1P	① 3214709	50	
PTS 1,5/S-TWIN/1P BU	① 3214712	50	
PTS 1,5/S-TWIN/1P-PE	② 3214725	50	

Accessories ¹⁾			
D-PTS 1,5/S	Order No.	Pcs./Pkt.	
D-PTS 1,5/S	3214576	50	

Accessories ¹⁾			
D-PTS 1,5/S	Order No.	Pcs./Pkt.	
D-PTS 1,5/S	3214576	50	

Feed-through terminal blocks, multi-conductor terminal blocks, and ground terminals in desk design

Notes:
 1) For additional accessories and technical data, see page 276.
 2) For derating curve, visit phoenixcontact.net/products

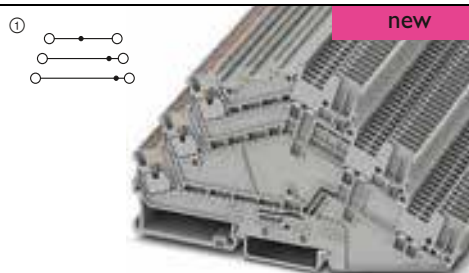

15 A, three-level terminal block

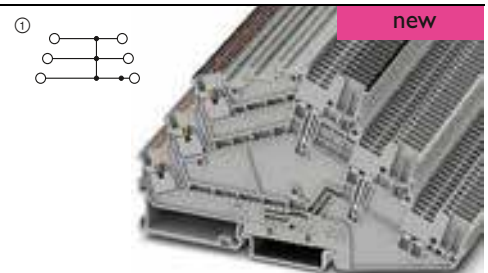

15 A, three-level terminal block with potential distribution

Technical data ¹⁾				
Width	Length	Height		
3.5	97.2	53.2 (NS 35/7,5)		
I_{max} [A]	U_{max} [V]	max. Ø [mm ²]	AWG (UL)	
15	500	0.14 - 1.5	-	
15				
IEC	UL / CUL	CSA	Ex	
500	-	-	-	
Nominal current / cross section	[A] / [mm ²]	15 ²⁾ / 1.5	- / -	

Technical data ¹⁾				
Width	Length	Height		
3.5	97.2	53.2 (NS 35/7,5)		
I_{max} [A]	U_{max} [V]	max. Ø [mm ²]	AWG (UL)	
15	500	0.14 - 1.5	-	
15				
IEC	UL / CUL	CSA	Ex	
500	-	-	-	
Nominal current / cross section	[A] / [mm ²]	15 ²⁾ / 1.5	- / -	

Ordering data			
Type	Order No.	Pcs./Pkt.	
PTS 1,5/S-3L/3P	① 1027881	50	
PTS 1,5/S-3L/3P BU	① 1027882	50	

Ordering data			
Type	Order No.	Pcs./Pkt.	
PTS 1,5/S-3PV/3P	① 1027883	50	

Accessories ¹⁾			
D-PTS 1,5/S-3L/3P	Order No.	Pcs./Pkt.	
D-PTS 1,5/S-3L/3P	1027887	50	

Accessories ¹⁾			
D-PTS 1,5/S-3L/3P	Order No.	Pcs./Pkt.	
D-PTS 1,5/S-3L/3P	1027887	50	

Terminal blocks – CLIPLINE complete

1.5 mm² COMBI PT plug-in connection solutions

Feed-through terminal blocks,
multi-conductor terminal blocks,
and ground terminals in desk design

Notes:

¹⁾ For additional accessories and technical data, see page 276.

²⁾ For derating curve, visit phoenixcontact.net/products

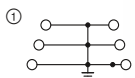

Ground terminal block

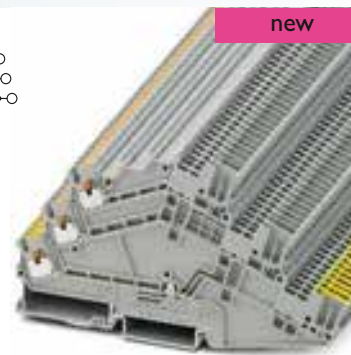
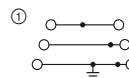

15 A, three-level terminal block with PE foot

Dimensions	
	[mm]
Maximum electrical data	
Maximum bridge current	[A]
Rated data	
Rated voltage	[V]
Nominal current / cross section	[A] / [mm ²]

Technical data ¹⁾				
Width	Length	Height		
3.5	97.2	53.2 (NS 35/7,5)		
		max. Ø [mm ²]	AWG (UL)	
		0.14 - 1.5	-	
		IEC	UL / CUL	CSA Ex
		-	-	-
		15 ²⁾ / 1.5	- / -	- / -

Description	Color
Terminal block , with PE foot	green-yellow gray gray

Ordering data			
Type	Order No.	Pcs./Pkt.	
PTS 1,5/S-3PE/3P	1027884	50	

Cover	Color
	gray

Accessories ¹⁾			
Type	Order No.	Pcs./Pkt.	
D-PTS 1,5/S-3L/3P	1027887	50	

Technical data ¹⁾				
Width	Length	Height		
3.5	97.2	53.2 (NS 35/7,5)		
I _{max} [A]	U _{max} [V]	max. Ø [mm ²]	AWG (UL)	
15	500	0.14 - 1.5	-	
15		IEC	UL / CUL	CSA Ex
		500	-	-
		15 ²⁾ / 1.5	- / -	- / -

Ordering data			
Type	Order No.	Pcs./Pkt.	
PTS 1,5/S-PE/L/L/3P	1027885	50	
PTS 1,5/S-PE/L/N/3P	1027886	50	

Accessories ¹⁾			
Type	Order No.	Pcs./Pkt.	
D-PTS 1,5/S-3L/3P	1027887	50	

Feed-through, multi-conductor, multi-level, and ground terminal blocks

Notes:
1) For additional accessories and technical data, see page 276.
2) For derating curve, visit phoenixcontact.net/products

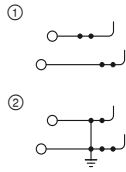

16 A, double-level terminal block

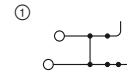

16 A, double-level terminal block with equipotential bonding



Technical data ¹⁾				
Dimensions	Width	Length	Height	
[mm]	3.5	78	55 (NS 35/7,5)	
Maximum electrical data	I_{max} [A]	U_{max} [V]	max. \emptyset [mm ²]	AWG (UL)
	16 ²⁾	500	0.14 - 1.5	26-14
Maximum bridge current	17.5			
Rated data	IEC	UL / CUL	CSA	Ex
Rated voltage	500	600	600	-
Nominal current / cross section	16 ²⁾ / 1.5	15 / -	15 / -	- / -

Ordering data			
Description	Type	Order No.	Pcs./Pkt.
Terminal block	PTTBS 1,5/S/2P	① 3214495	50
	PTTBS 1,5/S/2P BU	① 3214505	50
Ground terminal	PTTBS 1,5/S/2P-PE	② 3214518	50

Accessories ¹⁾			
Description	Type	Order No.	Pcs./Pkt.
Cover, width: 2.2 mm	D-PTTBS 1,5/S/2P	3214534	50



Technical data ¹⁾				
Dimensions	Width	Length	Height	
[mm]	3.5	78	55 (NS 35/7,5)	
Maximum electrical data	I_{max} [A]	U_{max} [V]	max. \emptyset [mm ²]	AWG (UL)
	16 ²⁾	500	0.14 - 1.5	26-14
Maximum bridge current	17.5			
Rated data	IEC	UL / CUL	CSA	Ex
Rated voltage	500	600	600	-
Nominal current / cross section	16 ²⁾ / 1.5	15 / -	15 / -	- / -

Ordering data			
Description	Type	Order No.	Pcs./Pkt.
Terminal block	PTTBS 1,5/S/2P-PV	① 3214521	50

Accessories ¹⁾			
Description	Type	Order No.	Pcs./Pkt.
Cover, width: 2.2 mm	D-PTTBS 1,5/S/2P	3214534	50

Couplings

Notes:
1) For additional accessories and technical data, see page 276.
2) For derating curve, visit phoenixcontact.net/products
For more cable housings, see page 366.



1.5 (1.5) mm², 17.5 A, coupling, 2 to 15-pos.

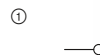

17.5 A, coupling, for self-assembly



Dimensions	[mm]
Maximum electrical data	
Rated data	[V]
Nominal current / cross section	[A] / [mm ²]

Technical data ¹⁾			
Width	Length	Height	
3.5 x No. of pos.	27	17.8	
I _{max.} [A]	U _{max.} [V]	max. Ø [mm ²]	AWG (UL)
17.5 ²⁾	500	0.14 - 1.5	26-14
IEC	UL / CUL	CSA	Ex
500	600	600	-
17.5 ²⁾ / 1.5	15 / -	15 / -	- / -

Technical data ¹⁾			
Width	Length	Height	
3.5 x No. of pos.	27	17.8	
I _{max.} [A]	U _{max.} [V]	max. Ø [mm ²]	AWG (UL)
17.5 ²⁾	500	0.14 - 1.5	26-14
IEC	UL / CUL	CSA	Ex
500	600	600	-
17.5 ²⁾ / 1.5	15 / -	15 / -	- / -

Description	No. of pos.	Width	Color
COMBI coupling	2	7 mm	gray
	3	10.5 mm	gray
	4	14 mm	gray
	5	17.5 mm	gray
	6	21 mm	gray
	7	24.5 mm	gray
	8	28 mm	gray
	9	31.5 mm	gray
	10	35 mm	gray
	11	38.5 mm	gray
	12	42 mm	gray
	13	45.5 mm	gray
	14	49 mm	gray
	15	52.5 mm	gray
	COMBI coupling, for self-assembly	1	3.5 mm
1		3.5 mm	blue
1		3.5 mm	green-yellow

Ordering data		
Type	Order No.	Pcs./Pkt.
PPC 1,5/S/ 2	3213386	50
PPC 1,5/S/ 3	3213399	50
PPC 1,5/S/ 4	3213409	50
PPC 1,5/S/ 5	3213412	50
PPC 1,5/S/ 6	3213425	25
PPC 1,5/S/ 7	3213438	25
PPC 1,5/S/ 8	3213441	25
PPC 1,5/S/ 9	3213454	25
PPC 1,5/S/10	3213467	25
PPC 1,5/S/11	3213470	10
PPC 1,5/S/12	3213483	10
PPC 1,5/S/13	3213496	10
PPC 1,5/S/14	3213506	10
PPC 1,5/S/15	3213519	10

Ordering data		
Type	Order No.	Pcs./Pkt.
PPC 1,5/S/1-L	3213357	50
PPC 1,5/S/1-L BU	3213360	50
PPC 1,5/S/1-L GNYE	3213373	50

Accessories ¹⁾			
Test plug metal part, 2.3 mm Ø	gray	MPS-MT	
Insulating sleeve, for MPS metal part	red	MPS-IH RD	
Cover, width: 3 mm	gray	D-PPC 1,5/S	
Coding star, with 4 coding branches, can be inserted in all basic terminal blocks	red	PC	
Strain relief, for plug and receptacle, 2-pos.	black	PZ 1,5/S/2	
Cable housing, for PP-H 1,5... and PPC 1,5...	3-pos.	gray	PH 1,5/S/3
	4-pos.	gray	PH 1,5/S/4
	5-pos.	gray	PH 1,5/S/5
	6-pos.	gray	PH 1,5/S/6
	7-pos.	gray	PH 1,5/S/7
	8-pos.	gray	PH 1,5/S/8
	9-pos.	gray	PH 1,5/S/9
	10-pos.	gray	PH 1,5/S/10
	11-pos.	gray	PH 1,5/S/11
	12-pos.	gray	PH 1,5/S/12
	13-pos.	gray	PH 1,5/S/13
	14-pos.	gray	PH 1,5/S/14
	15-pos.	gray	PH 1,5/S/15

Accessories ¹⁾		
MPS-MT	0201744	10
MPS-IH RD	0201676	10
D-PPC 1,5/S	3213690	50
PC	3040588	50
PZ 1,5/S/2	3212918	50
PH 1,5/S/3	3212756	50
PH 1,5/S/4	3212769	50
PH 1,5/S/5	3212772	50
PH 1,5/S/6	3212785	25
PH 1,5/S/7	3212798	25
PH 1,5/S/8	3212808	25
PH 1,5/S/9	3212811	25
PH 1,5/S/10	3212824	25
PH 1,5/S/11	3212837	10
PH 1,5/S/12	3212840	10
PH 1,5/S/13	3212853	10
PH 1,5/S/14	3212866	10
PH 1,5/S/15	3212879	10

Accessories ¹⁾		
MPS-MT	0201744	10
MPS-IH RD	0201676	10
D-PPC 1,5/S	3213690	50
PC	3040588	50
PZ 1,5/S/2	3212918	50
PH 1,5/S/3	3212756	50
PH 1,5/S/4	3212769	50
PH 1,5/S/5	3212772	50
PH 1,5/S/6	3212785	25
PH 1,5/S/7	3212798	25
PH 1,5/S/8	3212808	25
PH 1,5/S/9	3212811	25
PH 1,5/S/10	3212824	25
PH 1,5/S/11	3212837	10
PH 1,5/S/12	3212840	10
PH 1,5/S/13	3212853	10
PH 1,5/S/14	3212866	10
PH 1,5/S/15	3212879	10

Couplings

Notes:

¹⁾ For additional accessories and technical data, see page 276.

²⁾ For derating curve, visit phoenixcontact.net/products



17.5 A, coupling for DIN rail mounting



Dimensions	
	[mm]
Maximum electrical data	
Rated data	
Rated voltage	[V]
Nominal current / cross section	[A] / [mm ²]

Technical data ¹⁾			
Width	Length	Height	
3.5	43	28.3 (NS 35/7,5) / 28.3 (NS 15)	
I_{max} [A]	U_{max} [V]	max. \varnothing [mm ²]	AWG (UL)
17.5 ²⁾	500	0.14 - 1.5	26-14
IEC	UL / CUL	CSA	Ex
500	600	600	-
17.5 ²⁾ / 1.5	15 / -	15 / -	- / -

Description	Color
COMBI coupling	gray

Ordering data		
Type	Order No.	Pcs./Pkt.
PPC 1,5/S-NS/1-L	3213700	50

Cover, width: 3 mm	gray
Coding star, with 4 coding branches, can be inserted in all basic terminal blocks	red
Strain relief, for plug and receptacle, 2-pos.	black

Accessories ¹⁾		
Type	Order No.	Pcs./Pkt.
D-PPC 1,5/S	3213690	50
PC	3040588	50
PZ 1,5/S/2	3212918	50

COMBI connectors

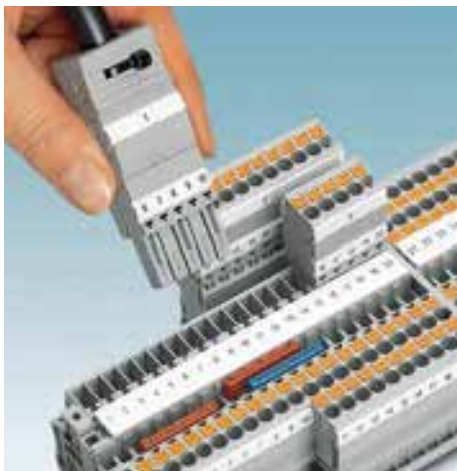

- Comprehensive, optional snap-on accessories available
- Practical coding facility
- Large-surface marking options
- Robust cable housings are available for strain relief on connecting cables

Notes:
1) For additional accessories and technical data, see page 276.
2) For derating curve, visit phoenixcontact.net/products

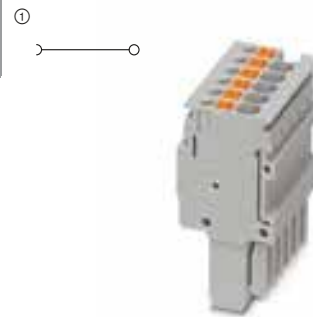

17.5 A, connector, connection in plug-in direction



Dimensions	[mm]
Width	3.5
Length	16.5
Height	31.3
Height plugged	19.5

Maximum electrical data	
I_{max} [A]	17.5 ²⁾
U_{max} [V]	500
max. Ø [mm ²]	0.14 - 1.5
AWG (UL)	26-14

Rated data	[V]
Rated voltage	500
Nominal current / cross section	17.5 ²⁾ / 1.5

Technical data ¹⁾			
Width	Length	Height	Height plugged
3.5 x No. of pos.	16.5	31.3	19.5
I_{max} [A]	U_{max} [V]	max. Ø [mm ²]	AWG (UL)
17.5 ²⁾	500	0.14 - 1.5	26-14
IEC	UL / CUL	CSA	Ex
500	600	600	-
Nominal current / cross section	[A] / [mm ²]	17.5 ²⁾ / 1.5	15 / -

Description	No. of pos.	Width	Color
COMBI connectors	1	3.5 mm	gray
	2	7 mm	gray
	3	10.5 mm	gray
	4	14 mm	gray
	5	17.5 mm	gray
	6	21 mm	gray
	7	24.5 mm	gray
	8	28 mm	gray
	9	31.5 mm	gray
	10	35 mm	gray
	11	38.5 mm	gray
	12	42 mm	gray
	13	45.5 mm	gray
	14	49 mm	gray
	15	52.5 mm	gray
	1	3.5 mm	blue
	1	3.5 mm	green-yellow

Ordering data		
Type	Order No.	Pcs./Pkt.
PP-H 1,5/S/1	① 3212484	50
PP-H 1,5/S/2	① 3212510	50
PP-H 1,5/S/3	① 3212523	50
PP-H 1,5/S/4	① 3212536	50
PP-H 1,5/S/5	① 3212549	50
PP-H 1,5/S/6	① 3212552	25
PP-H 1,5/S/7	① 3212565	25
PP-H 1,5/S/8	① 3212578	25
PP-H 1,5/S/9	① 3212581	25
PP-H 1,5/S/10	① 3212594	25
PP-H 1,5/S/11	① 3212604	10
PP-H 1,5/S/12	① 3212617	10
PP-H 1,5/S/13	① 3212620	10
PP-H 1,5/S/14	① 3212633	10
PP-H 1,5/S/15	① 3212646	10
PP-H 1,5/S/1 BU	① 3212497	50
PP-H 1,5/S/1 GNYE	① 3212507	50

Test plug metal part , 2.3 mm Ø	gray
Insulating sleeve , for MPS metal part	red
Latching and strain relief systems , for all plugs with conductor exit at top, 2-pos.	orange
Latching , for connectors, 1-pos.	orange
2-pos.	orange
Strain relief , for plug and receptacle, 2-pos.	black
Cable housing , for PP-H 1,5... and PPC 1,5... 3-pos.	gray
4-pos.	gray
5-pos.	gray
6-pos.	gray
7-pos.	gray
8-pos.	gray
9-pos.	gray
10-pos.	gray
11-pos.	gray
12-pos.	gray
13-pos.	gray
14-pos.	gray
15-pos.	gray

Accessories ¹⁾		
Type	Order No.	Pcs./Pkt.
MPS-MT	0201744	10
MPS-IH RD	0201676	10
PRZ 1,5/S	3212905	50
PR 1,5/S	3212882	50
PR 1,5/S/2	3212895	50
PZ 1,5/S/2	3212918	50
PH 1,5/S/3	3212756	50
PH 1,5/S/4	3212769	50
PH 1,5/S/5	3212772	50
PH 1,5/S/6	3212785	25
PH 1,5/S/7	3212798	25
PH 1,5/S/8	3212808	25
PH 1,5/S/9	3212811	25
PH 1,5/S/10	3212824	25
PH 1,5/S/11	3212837	10
PH 1,5/S/12	3212840	10
PH 1,5/S/13	3212853	10
PH 1,5/S/14	3212866	10
PH 1,5/S/15	3212879	10

COMBI connectors for self-assembly

- The Push-in COMBI connectors for self-assembly provide solutions that users can implement themselves
- Robust cable housings are available for strain relief on connecting cables
- The connector is assembled directly on site by snapping together single-position connector elements. See below for an example of how these go together

- ① PP-H 1,5/S/1-L
- ② PP-H 1,5/S/1-M and PP-H 1,5/S/1-M BU
- ③ PP-H 1,5/S/1-R GNYE

Notes:
1) For additional accessories and technical data, see page 276.
2) For derating curve, visit phoenixcontact.net/products
For more cable housings, see page 366.

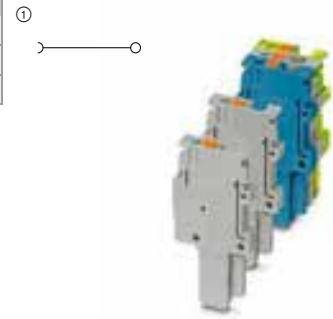

17.5 A, connector, connection in plug-in direction, for self-assembly



Dimensions	[mm]
Width	3.5 x No. of pos.
Length	16.5
Height	31.3
Height plugged	19.5

Maximum electrical data	
I_{max} [A]	17.5 ²⁾
U_{max} [V]	500
max. Ø [mm ²]	0.14 - 1.5
AWG (UL)	26-14
IEC	UL / CUL
CSA	Ex

Rated data	[V]
Rated voltage	500
Nominal current / cross section	17.5 ²⁾ / 1.5

Technical data ¹⁾			
Width	Length	Height	Height plugged
3.5 x No. of pos.	16.5	31.3	19.5
I_{max} [A]	U_{max} [V]	max. Ø [mm ²]	AWG (UL)
17.5 ²⁾	500	0.14 - 1.5	26-14
IEC	UL / CUL	CSA	Ex
500	600	600	-
Nominal current / cross section	[A] / [mm ²]	17.5 ²⁾ / 1.5	15 / -

Description	No. of pos.	Color
COMBI connector, left element	1	gray
	1	blue
	1	green-yellow
COMBI connector, center element	1	gray
	1	blue
COMBI connector, right element	1	green-yellow
	1	gray
COMBI connector, right element	1	blue
	1	gray
	1	green-yellow

Ordering data			
Type	Order No.	Pcs./Pkt.	
PP-H 1,5/S/1-L	① 3212659	50	
PP-H 1,5/S/1-L BU	① 3212662	50	
PP-H 1,5/S/1-L GNYE	① 3212675	50	
PP-H 1,5/S/1-M	① 3212688	50	
PP-H 1,5/S/1-M BU	① 3212691	50	
PP-H 1,5/S/1-M GNYE	① 3212701	50	
PP-H 1,5/S/1-R	① 3212714	50	
PP-H 1,5/S/1-R BU	① 3212727	50	
PP-H 1,5/S/1-R GNYE	① 3212730	50	

Test plug metal part, 2.3 mm Ø	gray
Insulating sleeve, for MPS metal part	red
Latching and strain relief systems, for all plugs with conductor exit at top, 2-pos.	orange
Latching, for connectors, 1-pos.	orange
2-pos.	orange
Strain relief, for plug and receptacle, 2-pos.	black
Cable housing, for PP-H 1,5... and PPC 1,5... 3-pos.	gray
4-pos.	gray
5-pos.	gray
6-pos.	gray
7-pos.	gray
8-pos.	gray
9-pos.	gray
10-pos.	gray
11-pos.	gray
12-pos.	gray
13-pos.	gray
14-pos.	gray
15-pos.	gray

Accessories ¹⁾		
MPS-MT	0201744	10
MPS-IH RD	0201676	10
PRZ 1,5/S	3212905	50
PR 1,5/S	3212882	50
PR 1,5/S/2	3212895	50
PZ 1,5/S/2	3212918	50
PH 1,5/S/3	3212756	50
PH 1,5/S/4	3212769	50
PH 1,5/S/5	3212772	50
PH 1,5/S/6	3212785	25
PH 1,5/S/7	3212798	25
PH 1,5/S/8	3212808	25
PH 1,5/S/9	3212811	25
PH 1,5/S/10	3212824	25
PH 1,5/S/11	3212837	10
PH 1,5/S/12	3212840	10
PH 1,5/S/13	3212853	10
PH 1,5/S/14	3212866	10
PH 1,5/S/15	3212879	10



Terminal blocks – CLIPLINE complete

1.5 mm² COMBI QT plug-in connection solutions

General technical data

Rated data		IEC 61984
Rated cross section	[mm ²]	1.5
Cross section range	AWG	24 - 16
Connection cross section in acc. with DIN VDE 0295		
H05V(Z) / H07V(Z)	[mm ²]	0.5 - 1.5
Class 5 / Class 6 [litz wires Ø ≥ 0.1 mm]	[mm ²]	0.25 - 0.34
[Litz wires Ø ≥ 0.19 mm]	AWG	24 - 16
Frequency of connections with the same cross section		100

Other conductor types and materials on request.

General data		
Insulating material		PA
Flammability rating in accordance with UL 94		V0
Wire diameter incl. insulation		≤ 3 mm

Note: Additional or deviating data is listed alongside the respective product.

Notes:



In addition to the product, the internal electrical wiring is provided as a circuit diagram. Free connection points for bridging are indicated by a black dot.

The specified technical data and approvals refer to the first product in each column. For information on the products below, please refer to phoenixcontact.net/products

For full details of UL and CSA use groups, file nos., and Internet links, please visit phoenixcontact.net/products

¹⁾ The bridge current is listed alongside the respective product. For additional colors, see page 402.

System accessories

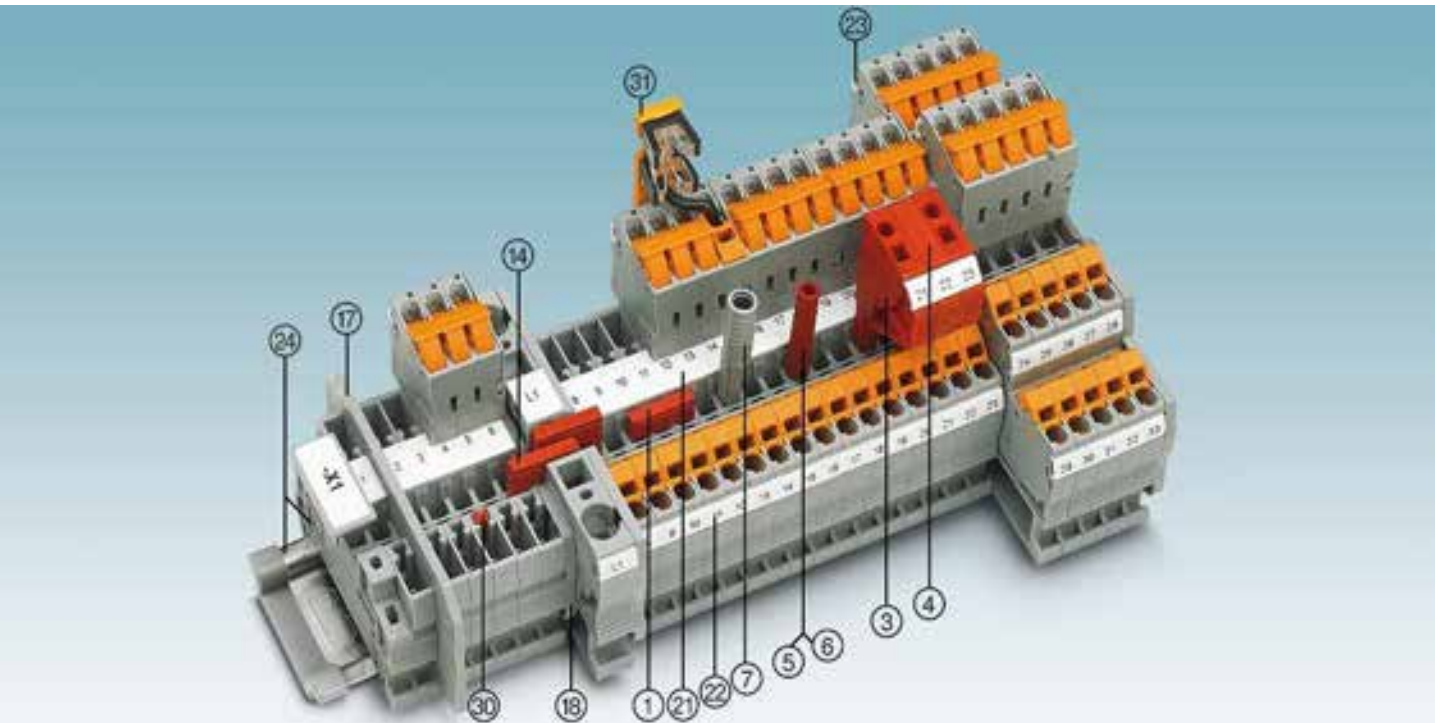

Description	No. of pos.	Color	Type	Order No.	Pcs./Pkt.	Type	Order No.	Pcs./Pkt.
① Bridge ¹⁾	2	red	FBS 2-5	3030161	50	FBSR 2-5	3033702	50
	3	red	FBS 3-5	3030174	50	FBSR 3-5	3001591	50
	4	red	FBS 4-5	3030187	50	FBSR 4-5	3001592	50
	5	red	FBS 5-5	3030190	50	FBSR 5-5	3001593	50
	10	red	FBS 10-5	3030213	10	FBSR 10-5	3033710	10
	20	red	FBS 20-5	3030226	10			
③ Modular test plug		red	PS-5	3030983	10			
④ Spacer plate		red	DP PS-5	3036725	10			
⑤ Test plug metal part		gray	MPS-MT	0201744	10			
⑥ Insulating sleeve, for MPS metal part		red	MPS-IH RD	0201676	10			
⑦ Test adapter, 4 mm socket hole		gray	PAI-4-N GY	3032871	10			
⑧ Coding profile		red	PC	3040588	50			
Screwdriver			SZF 1-0,6X3,5	1204517	10			
⑭ Reducing bridge	For RB ..., see page 408.							
⑰ Partition plates/end cover segments	For ATP-... / DS-..., visit phoenixcontact.net/products							
⑱ Cover	Listed alongside the respective product.							
⑲ Center groove labeling	UC-TM 5, UCT-TM 5 or ZB 5. See also Catalog 3, selection tables, from page 60.							
⑳ Center and side groove labeling	UC-TMF 5, UCT-TMF 5 or ZBF 5. See also Catalog 3, selection tables, from page 60.							
㉑ Lateral groove labeling	UC-TMF 5, UCT-TMF 5 or ZBF 5. See also Catalog 3, selection tables, from page 60.							
㉒ DIN rail and end bracket	See Catalog 3							
㉓ Latching, strain relief, shielding	See from page 362.							
For full accessories, visit phoenixcontact.net/products	Note: Additional or deviating accessories are listed alongside the respective product.							

Feed-through and multi-level terminal blocks and ground terminals

Notes:

- ¹⁾ For additional accessories and technical data, see page 286.
- ²⁾ For derating curve, visit phoenixcontact.net/products

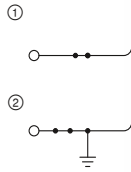

17.5 A, feed-through terminal block

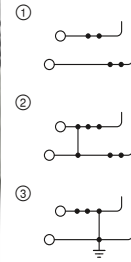

17.5 A, double-level terminal block



Technical data ¹⁾				
Width	Length	Height		
5.2	53.5	39.3 (NS 35/7,5)		
I_{max} [A]	U_{max} [V]	max. Ø [mm ²]	AWG (UL)	
17.5 ²⁾	500	0.25 - 1.5	24-16	
24 (FBS) / 17.5 (FBSR)				
IEC	UL / CUL	CSA	Ex	
500	600	600	-	
Nominal current / cross section	17.5 ²⁾ / 1.5	10 / -	10 / -	- / -

Ordering data			
Description	Type	Order No.	Pcs./Pkt.
Terminal block	QTC 1,5/ 1P	① 3050073	50
With potential distribution	QTC 1,5/ 1P BU	① 3050086	50
Ground terminal	QTC 1,5/ 1P-PE	② 3050099	50

Accessories ¹⁾		
Description	Order No.	Pcs./Pkt.
Cover, width: 2.2 mm	D-QTC 1,5/1P	3206322 50



Technical data ¹⁾				
Width	Length	Height		
5.2	87.8	49.9 (NS 35/7,5)		
I_{max} [A]	U_{max} [V]	max. Ø [mm ²]	AWG (UL)	
17.5 ²⁾	500	0.25 - 1.5	24-16	
24 (FBS) / 17.5 (FBSR)				
IEC	UL / CUL	CSA	Ex	
500	600	600	-	
Nominal current / cross section	17.5 ²⁾ / 1.5	10 / -	10 / -	- / -

Ordering data			
Description	Type	Order No.	Pcs./Pkt.
Terminal block	QTTCB 1,5/ 2P	① 3050196	50
With potential distribution	QTTCB 1,5/ 2P BU	① 3050206	50
Ground terminal	QTTCB 1,5/ 2P-PV	② 3206377	50
	QTTCB 1,5/ 2P-PE	③ 3050219	50

Accessories ¹⁾		
Description	Order No.	Pcs./Pkt.
Cover, width: 2.2 mm	D-QTTCB 1,5/2P	3206306 50

COMBI connectors



- When it comes to the connectors, as is the case with the basic terminal blocks, the right connection technology is available for every application
- The fast connector QP 1,5/... is designed for connection of rigid and flexible conductors
- The conductor is connected using the familiar IDC rotation connection with no stripping, thus saving time

Notes:
1) For additional accessories and technical data, see page 286.



17.5 A, connector, connection in plug-in direction



Dimensions	[mm]
------------	------

Maximum electrical data

Rated data	[V]
Rated voltage	500
Nominal current / cross section	17.5 / 1.5

Technical data ¹⁾			
Width	Length	Height	Height plugged
5.2 x No. of pos.	20	40	24
I _{max.} [A]	U _{max.} [V]	max. Ø [mm ²]	AWG (UL)
17.5	500	0.25 - 1.5	24-16
IEC	UL / CUL	CSA	Ex
	600	600	-
	10 / -	10 / -	- / -

Description	No. of pos.	Width	Color
COMBI connectors	1	5.2 mm	gray
	2	10.4 mm	gray
	3	15.6 mm	gray
	4	20.8 mm	gray
	5	26 mm	gray
	6	31.2 mm	gray
	7	36.4 mm	gray
	8	41.6 mm	gray
	9	46.8 mm	gray
	10	52 mm	gray
	11	57.2 mm	gray
	12	62.4 mm	gray
	13	67.6 mm	gray
	14	72.8 mm	gray
	15	78 mm	gray
	1	5.2 mm	blue
	1	5.2 mm	green-yellow

Ordering data		
Type	Order No.	Pcs./Pkt.
QP 1,5/ 1	3051108	50
QP 1,5/ 2	3051111	50
QP 1,5/ 3	3051124	50
QP 1,5/ 4	3051137	50
QP 1,5/ 5	3051140	50
QP 1,5/ 6	3051153	25
QP 1,5/ 7	3051166	25
QP 1,5/ 8	3051179	25
QP 1,5/ 9	3051182	25
QP 1,5/10	3051195	25
QP 1,5/11	3051205	10
QP 1,5/12	3051218	10
QP 1,5/13	3051221	10
QP 1,5/14	3051234	10
QP 1,5/15	3051247	10
QP 1,5/ 1 BU	3051250	50
QP 1,5/ 1 GNYE	3051263	50

Test plug metal part, 2.3 mm Ø	gray
Insulating sleeve, for MPS metal part	red
Latching and strain relief systems, for all plugs with conductor exit at top, 2-pos.	orange
Latching, for connectors, 1-pos.	orange
2-pos.	orange
Strain relief, for plugs, 2-pos.	
	black
4-pos.	black

Accessories ¹⁾		
MPS-MT	0201744	10
MPS-IH RD	0201676	10
PRZ	3040614	50
PR	3040559	50
PR/2	3040630	50
PZ/2	3040627	50
PZ/4	3040643	50

COMBI connectors



- The QT-COMBI connectors for self-assembly provide solutions that users can implement themselves
- The fast connector QP 1,5/... is designed for connection of rigid and flexible conductors
- The conductor is connected using the familiar IDC rotation connection with no stripping, thus saving time
- The connector with fast connection is assembled directly on site by snapping together single-position connector elements. See below for an example of how these go together

- ① QP 1,5/1-L
- ② QP 1,5/1-M and QP 1,5/1-M BU
- ③ QP 1,5/1-R GNYE

Notes:
1) For additional accessories and technical data, see page 286.
2) For derating curve, visit phoenixcontact.net/products
For further accessories, see page 362.

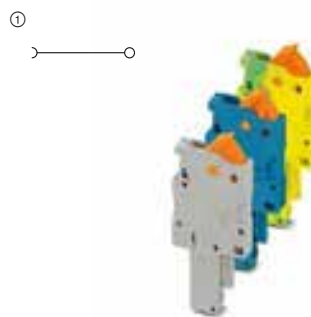

17.5 A, connector, connection in plug-in direction, for self-assembly



Dimensions	[mm]
5.2 x No. of pos.	20
Maximum electrical data	
Rated data	
Rated voltage	[V]
Nominal current / cross section	[A] / [mm ²]

Technical data ¹⁾			
Width	Length	Height	Height plugged
5.2	20	40	24
Maximum electrical data			
I_{max} [A]	U_{max} [V]	max. Ø [mm ²]	AWG (UL)
17.5 ²⁾	500	0.25 - 1.5	24-16
IEC	UL / CUL	CSA	Ex
Rated voltage	[V]		
500	600	600	-
Nominal current / cross section	[A] / [mm ²]		
17.5 ²⁾ / 1.5	10 / -	10 / -	- / -

Description	No. of pos.	Color
COMBI connector, left element	1	gray
	1	blue
	1	green-yellow
COMBI connector, center element	1	gray
	1	blue
COMBI connector, right element	1	green-yellow
	1	gray
	1	blue
	1	green-yellow

Ordering data			
Type	Order No.	Pcs./Pkt.	
QP 1,5/ 1-L	① 3051014	50	
QP 1,5/ 1-L BU	① 3051027	50	
QP 1,5/ 1-L GNYE	① 3051030	50	
QP 1,5/ 1-M	① 3051043	50	
QP 1,5/ 1-M BU	① 3051056	50	
QP 1,5/ 1-M GNYE	① 3051069	50	
QP 1,5/ 1-R	① 3051072	50	
QP 1,5/ 1-R BU	① 3051085	50	
QP 1,5/ 1-R GNYE	① 3051098	50	

Test plug metal part, 2.3 mm Ø	gray
Insulating sleeve, for MPS metal part	red
Latching and strain relief systems, for all plugs with conductor exit at top, 2-pos.	orange
Latching, for connectors, 1-pos.	orange
2-pos.	orange
Strain relief, for plugs, 2-pos.	
	black
4-pos.	black

Accessories ¹⁾		
Type	Order No.	Pcs./Pkt.
MPS-MT	0201744	10
MPS-IH RD	0201676	10
PRZ	3040614	50
PR	3040559	50
PR/2	3040630	50
PZ/2	3040627	50
PZ/4	3040643	50

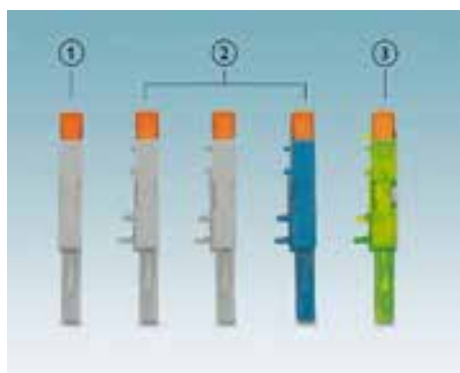

Terminal blocks – CLIPLINE complete

2.5 mm² COMBI PT plug-in connection solutions

General technical data

Rated data		IEC 61984
Rated cross section	[mm ²]	2.5
Cross section range	AWG	26 - 12
Connection capacity		Rigid Flexible Ferrule without/with plastic sleeve
1 conductor	[mm ²]	0.14 - 4 0.14 - 2.5 0.14 - 2.5 0.14 - 2.5
2 flexible conductors with a TWIN ferrule	[mm ²]	- - - 0.5
Connection cross sections directly plug-in	[mm ²]	0.34 - 4 - 0.34 - 2.5 0.34 - 2.5
General data		
Stripping length	[mm]	8 - 10
Insulating material		PA
Flammability rating in accordance with UL 94		V0

Note: Additional or deviating data is listed alongside the respective product.

Notes:



In addition to the product, the internal electrical wiring is provided as a circuit diagram. Free connection points for bridging are indicated by a black dot.

The specified technical data and approvals refer to the first product in each column. For information on the products below, please refer to phoenixcontact.net/products

For full details of UL and CSA use groups, file nos., and Internet links, please visit phoenixcontact.net/products

¹⁾ The bridge current is listed alongside the respective product. For additional colors, see page 402.

System accessories

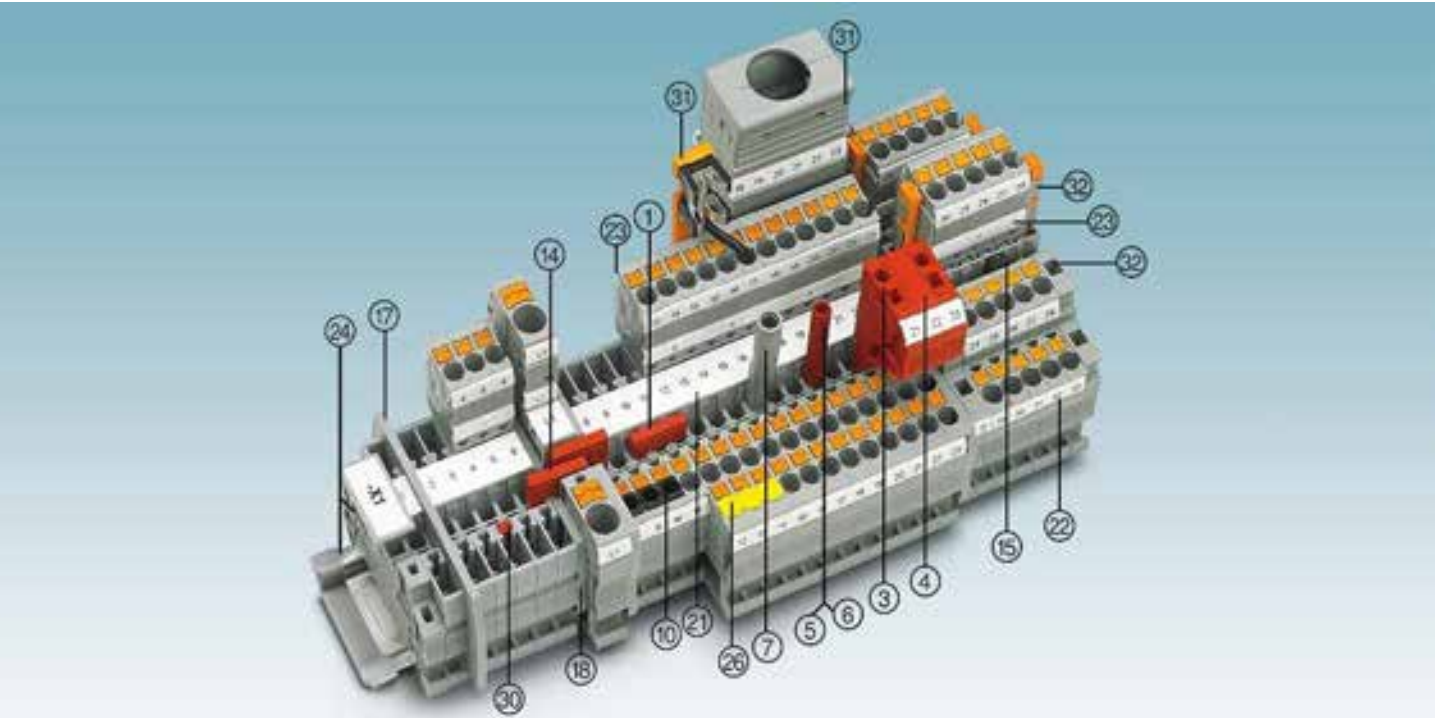

Description	No. of pos.	Color	Type	Order No.	Pcs./Pkt.	Type	Order No.	Pcs./Pkt.
① Bridge ¹⁾	2	red	FBS 2-5	3030161	50	FBSR 2-5	3033702	50
	3	red	FBS 3-5	3030174	50	FBSR 3-5	3001591	50
	4	red	FBS 4-5	3030187	50	FBSR 4-5	3001592	50
	5	red	FBS 5-5	3030190	50	FBSR 5-5	3001593	50
	10	red	FBS 10-5	3030213	10	FBSR 10-5	3033710	10
	20	red	FBS 20-5	3030226	10			
③ Modular test plug		red	PS-5	3030983	10			
④ Spacer plate		red	DP PS-5	3036725	10			
⑤ Test plug metal part		gray	MPS-MT	0201744	10			
⑥ Insulating sleeve, for MPS metal part		red	MPS-IH RD	0201676	10			
⑦ Test adapter, 4 mm socket hole		gray	PAI-4-N GY	3032871	10			
⑧ Insulating sleeve		white	ISH 2,5/0,2	3002843	50			
	0.25 - 0.5 mm ²	gray	ISH 2,5/0,5	3002856	50			
	0.75 - 1 mm ²	black	ISH 2,5/1,0	3002869	50			
⑨ Coding profile		red	PC	3040588	50			
Screwdriver			SZF 1-0,6X3,5	1204517	10			

⑭ Reducing bridge
⑮ Vertical potential bridge
⑯ Partition plates/end cover segments
⑰ Cover
⑱ Center groove labeling
⑲ Center and side groove labeling
⑳ Lateral groove labeling
㉑ DIN rail and end bracket
㉒ Cover for conductor shaft
㉓ Latching, strain relief, shielding
㉔ Screw flanges, screw flange cover
For full accessories, visit phoenixcontact.net/products

For RB ..., see page 408.
For FBS-PV ..., see page 404.
For ATP-... / DS-..., visit phoenixcontact.net/products
Listed alongside the respective product.
UC-TM 5, UCT-TM 5 or ZB 5. See also Catalog 3, selection tables, from page 60.
UC-TMF 5, UCT-TMF 5 or ZBF 5. See also Catalog 3, selection tables, from page 60.
UC-TMF 5, UCT-TMF 5 or ZBF 5. See also Catalog 3, selection tables, from page 60.
See Catalog 3
For CEC ..., see page 421.
See from page 362.
See from page 372.
Note: Additional or deviating accessories are listed alongside the respective product.

Feed-through, multi-conductor, multi-level, and ground terminal blocks

Notes:
1) For additional accessories and technical data, see page 290.
2) For derating curve, visit phoenixcontact.net/products
For screw flange, see page 372.
For self-locking flange, see page 371.

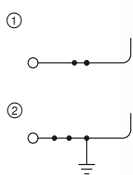

24 A, feed-through terminal block



Technical data ¹⁾				
Dimensions	Width	Length	Height	
	5.2	48.5	36.5 (NS 35/7,5)	
Maximum electrical data	I_{max} [A]	U_{max} [V]	max. Ø [mm ²]	AWG (UL)
	24 ²⁾	500	0.14 - 4	26-12
Maximum bridge current	24 (FBS) / 17.5 (FBSR)			
Rated data	IEC	UL / CUL	CSA	Ex
Rated voltage	500	600	300	-
Nominal current / cross section	24 ²⁾ / 2.5	20 / -	20 / -	- / -

Ordering data			
Type	Order No.	Pcs./Pkt.	
PT 2,5/1P	① 3210033	50	
PT 2,5/1P BU	① 3210046	50	
PT 2,5/1P-PE	② 3210059	50	

Accessories ¹⁾		
D-ST 2,5	3030417	50

Dimensions	[mm]
Maximum electrical data	
Maximum bridge current	[A]
Rated data	
Rated voltage	[V]
Nominal current / cross section	[A] / [mm ²]
Description	Color
Terminal block	gray blue
Ground terminal	green-yellow
Cover, width: 2.2 mm	gray

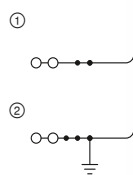

24 A, feed-through terminal block, 3 connections



Technical data ¹⁾				
Dimensions	Width	Length	Height	
	5.2	60.5	36.5 (NS 35/7,5)	
Maximum electrical data	I_{max} [A]	U_{max} [V]	max. Ø [mm ²]	AWG (UL)
	24 ²⁾	500	0.14 - 4	26-12
Maximum bridge current	24 (FBS) / 17.5 (FBSR)			
Rated data	IEC	UL / CUL	CSA	Ex
Rated voltage	500	600	300	-
Nominal current / cross section	24 ²⁾ / 2.5	20 / -	20 / -	- / -

Ordering data			
Type	Order No.	Pcs./Pkt.	
PT 2,5-TWIN/1P	① 3209633	50	
PT 2,5-TWIN/1P BU	① 3209646	50	
PT 2,5-TWIN/1P-PE	② 3209659	50	

Accessories ¹⁾		
D-ST 2,5-TWIN	3030488	50

Feed-through, multi-conductor, multi-level, and ground terminal blocks

Notes:
1) For additional accessories and technical data, see page 290.
2) For derating curve, visit phoenixcontact.net/products
For screw flange, see page 372.
For self-locking flange, see page 371.

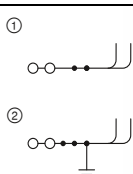

24 A, feed-through terminal block, 4 connections



Technical data ¹⁾				
Dimensions	Width	Length	Height	
	5.2	81	36.5 (NS 35/7,5)	
Maximum electrical data	I_{max} [A]	U_{max} [V]	max. Ø [mm ²]	AWG (UL)
	24 ²⁾	500	0.14 - 4	26-12
Maximum bridge current	24 (FBS) / 17.5 (FBSR)			
Rated data	IEC	UL / CUL	CSA	Ex
Rated voltage	500	600	300	-
Nominal current / cross section	24 ²⁾ / 2.5	20 / -	20 / -	- / -

Ordering data			
Type	Order No.	Pcs./Pkt.	
PT 2,5-QUATTRO/2P	① 3209662	50	
PT 2,5-QUATTRO/2P BU	① 3209675	50	
PT 2,5-QUATTRO/2P-PE	② 3209688	50	

Accessories ¹⁾		
D-ST 2,5-QUATTRO/2P	3040083	50

Dimensions	[mm]
Maximum electrical data	
Maximum bridge current	[A]
Rated data	
Rated voltage	[V]
Nominal current / cross section	[A] / [mm ²]
Description	Color
Terminal block	gray blue
Ground terminal	green-yellow
Cover, width: 2.2 mm	gray
Spacer plate, width: 5.2 mm	orange

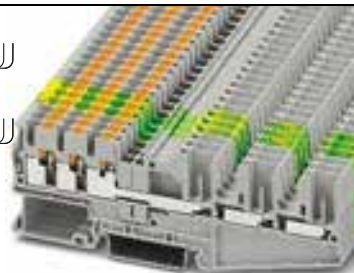
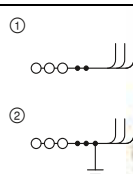

24 A, feed-through terminal block, 6 connections



Technical data ¹⁾				
Dimensions	Width	Length	Height	
	5.2	111.2	36.8 (NS 35/7,5)	
Maximum electrical data	I_{max} [A]	U_{max} [V]	max. Ø [mm ²]	AWG (UL)
	24 ²⁾	500	0.14 - 4	26-12
Maximum bridge current	24 (FBS) / 17.5 (FBSR)			
Rated data	IEC	UL / CUL	CSA	Ex
Rated voltage	500	300	-	-
Nominal current / cross section	24 ²⁾ / 2.5	20 / -	- / -	- / -

Ordering data			
Type	Order No.	Pcs./Pkt.	
PT 2,5-HEXA/3P	① 3040044	50	
PT 2,5-HEXA/3P BU	① 3040048	50	
PT 2,5-HEXA/3P-PE	② 3040052	50	

Accessories ¹⁾		
D-PT 2,5-HEXA/3P	3040058	50
DP-PT 2,5-HEXA/3P	3040060	50

Terminal blocks – CLIPLINE complete

2.5 mm² COMBI PT plug-in connection solutions

Feed-through, multi-conductor, multi-level, and ground terminal blocks

Notes:
1) For additional accessories and technical data, see page 290.
2) For derating curve, visit phoenixcontact.net/products
For screw flange, see page 372.
For self-locking flange, see page 371.

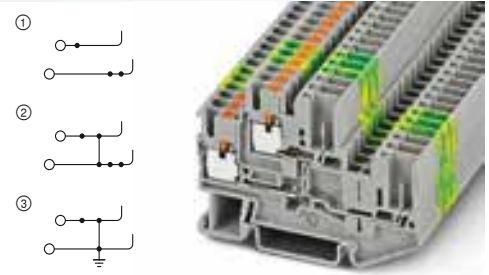

22 A, double-level terminal block

UL ENEC ERIE ClassNK

Dimensions	[mm]
Maximum electrical data	
Maximum bridge current	[A]
Rated data	
Rated voltage	[V]
Nominal current / cross section	[A] / [mm ²]

Technical data ¹⁾			
Width	Length	Height	
5.2	71.5	47.5 (NS 35/7,5)	
I _{max} [A]	U _{max} [V]	max. Ø [mm ²]	AWG (UL)
22 ²⁾	500	0.14 - 4	24-12
20 (FBS) / 17.5 (FBSR)			
IEC	UL / CUL	CSA	Ex
500	600	300	-
22 ²⁾ / 2.5	20 / -	20 / -	- / -

Description	Color
Terminal block	gray
With potential distribution	blue
Ground terminal	gray
	green-yellow
Cover, width: 2.2 mm	gray

Ordering data		
Type	Order No.	Pcs./Pkt.
PTTB 2,5/2P	① 3210871	50
PTTB 2,5/2P BU	① 3210884	50
PTTB 2,5/2P-PV	② 3210907	50
PTTB 2,5/2P-PE	③ 3210897	50

Accessories ¹⁾		
D-STTB 2,5/2P	3040096	50

Feed-through, multi-conductor, multi-level, and ground terminal blocks

Notes:
1) For additional accessories and technical data, see page 290.
2) For derating curve, visit phoenixcontact.net/products

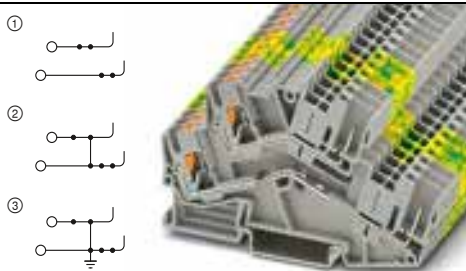

22 A, double-level terminal block, desk design

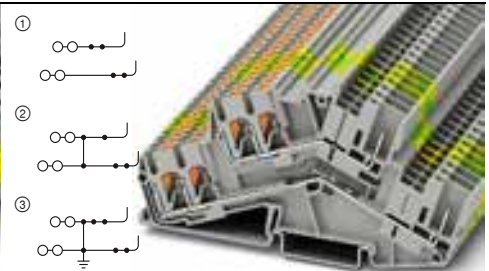

18 A, double-level terminal block, desk design

UL ENEC ERIE ClassNK

UL ENEC ERIE ClassNK

Dimensions	[mm]
Maximum electrical data	
Maximum bridge current	[A]
Rated data	
Rated voltage	[V]
Nominal current / cross section	[A] / [mm ²]

Technical data ¹⁾			
Width	Length	Height	
5.2	92.6	55 (NS 35/7,5)	
I _{max} [A]	U _{max} [V]	max. Ø [mm ²]	AWG (UL)
22 ²⁾	800	0.14 - 4	26-12
20 (FBS) / 17.5 (FBSR)			
IEC	UL / CUL	CSA	Ex
800	600	600	-
22 ²⁾ / 2.5	20 / -	20 / -	- / -

Technical data ¹⁾			
Width	Length	Height	
5.2	111.8	55 (NS 35/7,5)	
I _{max} [A]	U _{max} [V]	max. Ø [mm ²]	AWG (UL)
18 ²⁾	500	0.14 - 4	26-12
20 (FBS) / 17.5 (FBSR)			
IEC	UL / CUL	CSA	Ex
500	600	600	-
18 ²⁾ / 2.5	20 / -	20 / -	- / -

Description	Color
Terminal block	gray
With potential distribution	blue
Ground terminal	gray
	green-yellow
Cover, width: 2.2 mm	gray

Ordering data		
Type	Order No.	Pcs./Pkt.
PTTBS 2,5/2P	① 3211260	50
PTTBS 2,5/2P BU	① 3211261	50
PTTBS 2,5/2P-PV	② 3211262	50
PTTBS 2,5/2P-PE	③ 3211263	50

Ordering data		
Type	Order No.	Pcs./Pkt.
PTTBS 2,5-TWIN/2P	① 3210604	50
PTTBS 2,5-TWIN/2P BU	① 3210605	50
PTTBS 2,5-TWIN/2P-PV	② 3210607	50
PTTBS 2,5-TWIN/2P-PE	③ 3210606	50

Accessories ¹⁾		
D-PTTBS 2,5/2P	3211264	50

Accessories ¹⁾		
D-PTTBS 2,5-TWIN	3210608	50

Feed-through, multi-conductor, multi-level, and ground terminal blocks

Notes:
1) For additional accessories and technical data, see page 290.
2) For derating curve, visit phoenixcontact.net/products
For screw flange, see page 372.
For self-locking flange, see page 371.

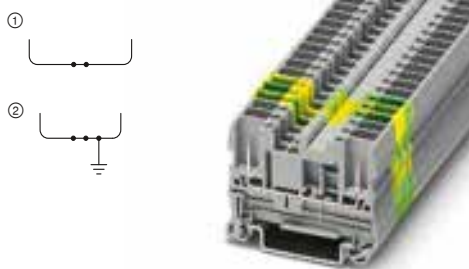

24 A, feed-through terminal block



Technical data ¹⁾				
Dimensions	Width	Length	Height	
	5.2	49.1	36.5 (NS 35/7,5)	
Maximum electrical data	I_{max} [A]	U_{max} [V]	max. Ø [mm ²]	AWG (UL)
	24 ²⁾	500	0.08 - 4	-
	24 (FBS) / 17.5 (FBSR)			
Rated data	IEC	UL / CUL	CSA	Ex
Maximum bridge current	500	600	300	-
Rated voltage	500	600	300	-
Nominal current / cross section	24 ²⁾ / 2.5	20 / -	20 / -	- / -
Cross section range	28 - 12	-	-	-
Connection capacity	Rigid	Flexible	Ferrule without/with plastic sleeve	
1 conductor	0.08 - 4	0.08 - 2.5	0.14 - 2.5	0.14 - 2.5

Ordering data			
Description	Color	Type	Order No.
Terminal block	gray	ST 2,5/2P	3042133
	blue	ST 2,5/2P BU	3042094
Ground terminal	green-yellow	ST 2,5/2P-PE	3042146
			Pcs./Pkt.
			50

Accessories ¹⁾		
Description	Order No.	Pcs./Pkt.
Cover, width: 2.2 mm	D-ST 2,5	3030417
		50

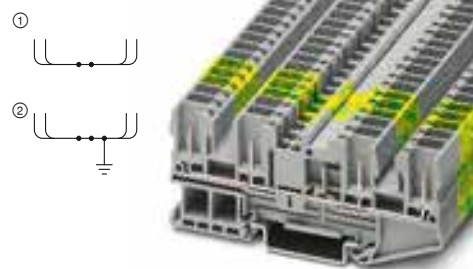

24 A, feed-through terminal block, 4 connections



Technical data ¹⁾				
Dimensions	Width	Length	Height	
	5.2	89.5	36.5 (NS 35/7,5)	
Maximum electrical data	I_{max} [A]	U_{max} [V]	max. Ø [mm ²]	AWG (UL)
	24 ²⁾	500	0.08 - 4	-
	24 (FBS) / 17.5 (FBSR)			
Rated data	IEC	UL / CUL	CSA	Ex
Maximum bridge current	500	600	600	-
Rated voltage	500	600	600	-
Nominal current / cross section	24 ²⁾ / 2.5	20 / -	20 / -	- / -
Cross section range	28 - 12	-	-	-
Connection capacity	Rigid	Flexible	Ferrule without/with plastic sleeve	
1 conductor	0.08 - 4	0.08 - 2.5	0.14 - 2.5	0.14 - 2.5

Ordering data			
Description	Color	Type	Order No.
Terminal block	gray	ST 2,5-QUATTRO/4P	3042159
	blue	ST 2,5-QUATTRO/4P BU	3042081
Ground terminal	green-yellow	ST 2,5-QUATTRO/4P-PE	3042162
			Pcs./Pkt.
			50

Accessories ¹⁾		
Description	Order No.	Pcs./Pkt.
Cover, width: 2.2 mm	D-ST 2,5-QUATTRO/4P	3042175
		50

Feed-through, multi-conductor, multi-level, and ground terminal blocks

Notes:
1) For additional accessories and technical data, see page 290.
2) For derating curve, visit phoenixcontact.net/products

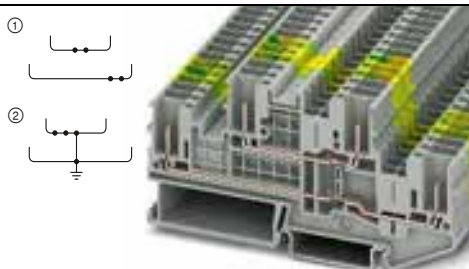

22 A, double-level terminal block



Technical data ¹⁾				
Dimensions	Width	Length	Height	
	5.2	98.8	47.5 (NS 35/7,5)	
Maximum electrical data	I_{max} [A]	U_{max} [V]	max. Ø [mm ²]	AWG (UL)
	22 ²⁾	500	0.08 - 4	-
	24 (FBS) / 17.5 (FBSR)			
Rated data	IEC	UL / CUL	CSA	Ex
Maximum bridge current	500	600	600	-
Rated voltage	500	600	600	-
Nominal current / cross section	22 ²⁾ / 2.5	20 / -	20 / -	- / -
Cross section range	28 - 12	-	-	-
Connection capacity	Rigid	Flexible	Ferrule without/with plastic sleeve	
1 conductor	0.08 - 4	0.08 - 2.5	0.14 - 2.5	0.14 - 2.5

Ordering data			
Description	Color	Type	Order No.
Terminal block	gray	STTB 2,5/4P	3061486
	blue	STTB 2,5/4P BU	3061512
Ground terminal	green-yellow	STTB 2,5/4P-PE	3061499
			Pcs./Pkt.
			50

Accessories ¹⁾		
Description	Order No.	Pcs./Pkt.
Cover, width: 2.2 mm	D-STTB 2,5/4P	3061538
		50

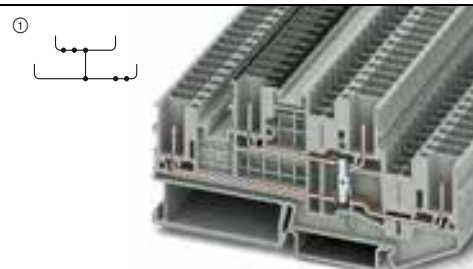

22 A, double-level terminal block with equipotential bonding



Technical data ¹⁾				
Dimensions	Width	Length	Height	
	5.2	98.8	47.5 (NS 35/7,5)	
Maximum electrical data	I_{max} [A]	U_{max} [V]	max. Ø [mm ²]	AWG (UL)
	22 ²⁾	500	0.08 - 4	-
	24 (FBS) / 17.5 (FBSR)			
Rated data	IEC	UL / CUL	CSA	Ex
Maximum bridge current	500	600	600	-
Rated voltage	500	600	600	-
Nominal current / cross section	22 ²⁾ / 2.5	20 / -	20 / -	- / -
Cross section range	28 - 12	-	-	-
Connection capacity	Rigid	Flexible	Ferrule without/with plastic sleeve	
1 conductor	0.08 - 4	0.08 - 2.5	0.14 - 2.5	0.14 - 2.5

Ordering data			
Description	Color	Type	Order No.
Terminal block	gray	STTB 2,5/4P-PV	3061509
	blue		
Ground terminal	green-yellow		
			Pcs./Pkt.
			50

Accessories ¹⁾		
Description	Order No.	Pcs./Pkt.
Cover, width: 2.2 mm	D-STTB 2,5/4P	3061538
		50

Terminal blocks – CLIPLINE complete

2.5 mm² COMBI PT plug-in connection solutions

Four-level terminal blocks

Notes:
 1) For additional accessories and technical data, see page 290.
 2) For derating curve, visit phoenixcontact.net/products



10 A, four-level terminal block

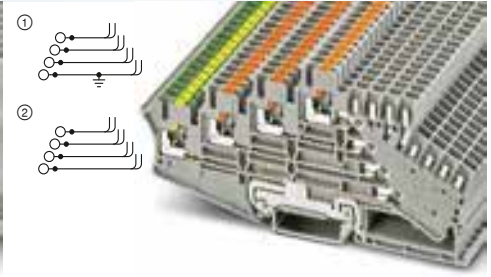

10 A, four-level terminal block with PE foot



Dimensions	
	[mm]
Maximum electrical data	
Maximum bridge current	[A]
Rated data	
Rated voltage	[V]
Nominal current / cross section	[A] / [mm ²]

Technical data ¹⁾				
Width	Length	Height		
5.2	105.6	59 (NS 35/7,5)		
I _{max} [A]	U _{max} [V]	max. Ø [mm ²]	AWG (UL)	
10 ²⁾	250	0.14 - 4	26-12	
24 (FBS) / 17.5 (FBSR)				
IEC	UL / CUL	CSA	Ex	
250	300	300	-	
10 ²⁾ / 1.5	10 / -	10 / -	- / -	

Technical data ¹⁾				
Width	Length	Height		
5.2	125	59 (NS 35/7,5)		
I _{max} [A]	U _{max} [V]	max. Ø [mm ²]	AWG (UL)	
10 ²⁾	250	0.14 - 4	26-14	
24 (FBS) / 17.5 (FBSR)				
IEC	UL / CUL	CSA	Ex	
250	300	300	-	
10 ²⁾ / 1.5	10 / -	10 / -	- / -	

Ordering data	
Description	Color
Terminal block	gray
Terminal block, with PE foot	gray
Terminal block, with two plug-in connections	gray

Type	Order No.	Pcs./Pkt.
PT 2,5-4L/1P	3012300	50

Type	Order No.	Pcs./Pkt.
PT 2,5-PE/3L/2P	3012316	50
PT 2,5-4L/2P	3012310	50

Accessories ¹⁾	
Cover, width: 2.2 mm	gray
Self-locking flange, can be labeled with UC-TM	gray
Screw flange, can be marked with UC-TM	gray

Type	Order No.	Pcs./Pkt.
D-PT 2,5-4L/1P	3012301	10
PT 2,5-4L/1P-FS	3012302	10
PT 2,5-4L/1P-F	3012326	10

Type	Order No.	Pcs./Pkt.
D-PT 2,5-4L/2P	3012311	10
PT 2,5-4L/2P-FS	3012312	10

Connector housing for four-level terminal blocks

Notes:
 In order to crimp STG-MTN... modular socket contacts, the CRIMPFOX MT 2.5 (Order No. 1204038) must be used.

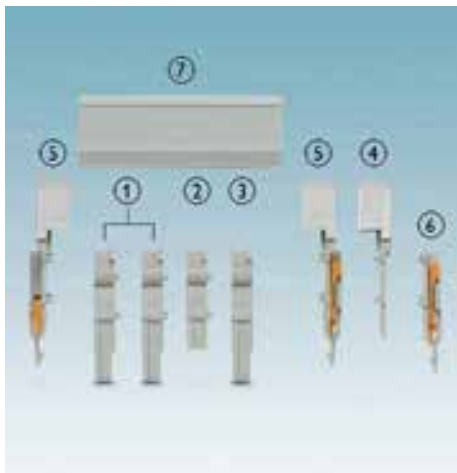

- ① 4-pos. connector with CP-H 2,5-4L-Z engagement pin
- ② DP-CP-H 2,5-4L spacer plate
- ③ CP-H 2,5-4L 4-pos. connector
- ④ D-CP-H 2,5-4L cover profile carrier
- ⑤ DFS-CP-H 2,5-4L cover profile carrier with self-locking flange cover
- ⑥ DFS-CP 2,5-4L self-locking flange cover
- ⑦ AP-CP-H cover profile



Connector housing, for accommodating four socket contacts

Description	Color
Connector housing, for accommodating 4 socket contacts	gray
Connector housing with engagement pin	gray

Ordering data		
Type	Order No.	Pcs./Pkt.
CP-H 2,5-4L	3012313	50
CP-H 2,5-4L-PE	3012323	50
CP-H 2,5-4L-Z	3012314	50
CP-H 2,5-4L-Z-PE	3012324	50

Accessories	
Self-locking flange, can be labeled with UC-TM	gray
Spacer plate	gray
Cover profile, 1 m, can be labeled with UC-TM ...	gray
Cover profile carrier	gray
Cover profile carrier, with self-locking flange cover	gray
Self-locking flange cover	gray
Screw flange cover	gray
Module socket contact, 0.5 ... 1 mm ²	silver
for wires from 1.5 ... 2.5 mm ²	silver

Accessories		
Type	Order No.	Pcs./Pkt.
PT 2,5-4L/1P-FS	3012302	10
PT 2,5-4L/2P-FS	3012312	10
DP-CP-H 2,5-4L	3012319	50
AP-CP-H METER	3012315	10
D-CP-H 2,5-4L	3012320	50
DFS-CP-H 2,5-4L	3012317	50
DFS-CP 2,5-4L	3012321	50
DF-CP 2,5-4L	3012327	10
STG-MTN 0,5-1,0	3190438	100
STG-MTN 1,5-2,5	3190506	100

Couplings

①



24 A, coupling

①



24 A, coupling, for self-assembly

Notes:

1) For additional accessories and technical data, see page 290.

2) For derating curve, visit phoenixcontact.net/products



Technical data ¹⁾				
Dimensions	Width	Length	Height	
	5.2 x No. of pos.	20.5	41	
Maximum electrical data	I _{max.} [A]	U _{max.} [V]	max. Ø [mm ²]	AWG (UL)
	24	500	0.14 - 4	26-12
Rated data	IEC	UL / CUL	CSA	Ex
Rated voltage	500	300	300	-
Nominal current / cross section	24 / 2.5	20 / -	20 / -	- / -
Connection capacity	Rigid	Flexible	Ferrule without/with plastic sleeve	
1 conductor	0.14 - 4	0.14 - 2.5	-	0.14 - 2.5
Connection cross sections directly plug-in	0.34 - 4	-	0.34 - 2.5	0.5 - 2.5



Technical data ¹⁾				
Dimensions	Width	Length	Height	
	5.2 x No. of pos.	20.5	41	
Maximum electrical data	I _{max.} [A]	U _{max.} [V]	max. Ø [mm ²]	AWG (UL)
	24 ²⁾	500	0.14 - 4	26-12
Rated data	IEC	UL / CUL	CSA	Ex
Rated voltage	500	300	300	-
Nominal current / cross section	24 ²⁾ / 2.5	20 / -	20 / -	- / -
Connection capacity	Rigid	Flexible	Ferrule without/with plastic sleeve	
1 conductor	0.14 - 4	0.14 - 2.5	-	0.14 - 2.5
Connection cross sections directly plug-in	0.34 - 4	-	0.34 - 2.5	0.5 - 2.5

Ordering data			
Description	No. of pos.	Width	Color
COMBI coupling	2	10.4 mm	gray
	3	15.4 mm	gray
	4	20.6 mm	gray
	5	25.7 mm	gray
	6	30.9 mm	gray
	7	36 mm	gray
	8	41.2 mm	gray
	9	46.3 mm	gray
	10	51.5 mm	gray
	11	56.6 mm	gray
	12	61.8 mm	gray
	13	66.9 mm	gray
	14	72.1 mm	gray
	15	77.2 mm	gray
COMBI coupling, for self-assembly	1	5.2 mm	gray
	1	5.2 mm	blue
	1	5.2 mm	green-yellow

Type	Order No.	Pcs./Pkt.
PPC 2,5/2	3000656	50
PPC 2,5/3	3000657	50
PPC 2,5/4	3000658	50
PPC 2,5/5	3000659	50
PPC 2,5/6	3000660	25
PPC 2,5/7	3000661	25
PPC 2,5/8	3000662	25
PPC 2,5/9	3000663	25
PPC 2,5/10	3000664	25
PPC 2,5/11	3000665	10
PPC 2,5/12	3000666	10
PPC 2,5/13	3000667	10
PPC 2,5/14	3000668	10
PPC 2,5/15	3000669	10

Ordering data			
Type	Order No.	Pcs./Pkt.	
PPC 2,5/1-L	3000653	50	
PPC 2,5/1-L BU	3000654	50	
PPC 2,5/1-L GNYE	3000655	50	

Accessories ¹⁾			
Accessories	Order No.	Pcs./Pkt.	
MPS-MT	0201744	10	
MPS-IH RD	0201676	10	
D-PPC 2,5	3000671	50	
PC	3040588	50	

Accessories ¹⁾			
Accessories	Order No.	Pcs./Pkt.	
MPS-MT	0201744	10	
MPS-IH RD	0201676	10	
D-PPC 2,5	3000671	50	
PC	3040588	50	

Test plug metal part, 2.3 mm Ø	gray
Insulating sleeve, for MPS metal part	red
Cover, width: 2.2 mm	gray
Coding star, with 4 coding branches, can be inserted in all basic terminal blocks	red

Terminal blocks – CLIPLINE complete

2.5 mm² COMBI PT plug-in connection solutions

Couplings

- The panel feed-through can be used to securely fasten free-hanging PPC 2,5 couplings in panel cutouts
- The panel feed-through elements are snapped onto the free-hanging receptacles, and pushed into the panel cutout where they snap in automatically



24 A, coupling for DIN rail mounting



Panel feed-through

Notes:
1) For additional accessories and technical data, see page 290.
2) For derating curve, visit phoenixcontact.net/products



Technical data ¹⁾			
Width	Length	Height	
5.2	41	35.2 (NS 35/7,5) / 34.7 (NS 15)	
I_{max.} [A]	U_{max.} [V]	max. Ø [mm²]	AWG (UL)
24 ²⁾	500	0.14 - 4	26-12
IEC	UL / CUL	CSA	Ex
500	300	300	-
24 ²⁾ / 2.5	20 / -	20 / -	- / -
Rigid	Flexible	Ferrule without/with plastic sleeve	
0.14 - 4	0.14 - 2.5	-	0.14 - 2.5
0.34 - 4	-	0.34 - 2.5	0.5 - 2.5



Technical data ¹⁾			
Width	Length	Height	
5.2	-	max. Ø [mm ²]	
		AWG (UL)	
		-	-
IEC	UL / CUL	CSA	Ex
-	-	-	-
-	- / -	- / -	- / -
Rigid	Flexible	Ferrule without/with plastic sleeve	
-	-	-	-
-	-	-	-

Description	Color
COMBI coupling	gray
Panel feed-through , for snapping on to receptacles, 1 SSL 2.5 consists of a left-hand and a right-hand element, for metal thicknesses of 0.8 - 3 mm	gray

Ordering data		
Type	Order No.	Pcs./Pkt.
PPC 2,5-NS/1-L	3000652	50

Ordering data		
Type	Order No.	Pcs./Pkt.
SSL 2,5	3043815	50

Test plug metal part , 2.3 mm Ø	gray
Insulating sleeve , for MPS metal part	red
Cover , width: 2.2 mm	gray
Coding star , with 4 coding branches, can be inserted in all basic terminal blocks	red

Accessories ¹⁾		
Type	Order No.	Pcs./Pkt.
MPS-MT	0201744	10
MPS-IH RD	0201676	10
D-PPC 2,5	3000671	50
PC	3040588	50

Accessories ¹⁾		
Type	Order No.	Pcs./Pkt.



Fit the receptacle and SSL 2.5 in panel cutout



Fixing the receptacle

COMBI headers for PCB connection

Notes:
For additional accessories and technical data, see page 364 or visit phoenixcontact.net/products

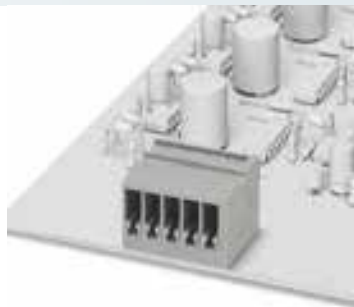

24 A, header, horizontal plug-in direction



24 A, header, vertical plug-in direction



Technical data				
Width	Length	Height		
10.4	21.7	18.1		
I _{max.} [A]		max. Ø [mm ²]		AWG (UL)
24		-		-
IEC	UL	CSA	IEC/EN 60079-7	
-	300	-	-	
Rated voltage [V]		Nominal current / cross section [A] / [mm ²]		
-		24 / 2.5		
Rated cross section [mm ²]		2.5		
General data				
Insulating material		PA		
Flammability rating in accordance with UL 94		V0		



Technical data				
Width	Length	Height		
12.5	18.05	21.7		
I _{max.} [A]		max. Ø [mm ²]		AWG (UL)
24		-		-
IEC	UL	CSA	IEC/EN 60079-7	
-	300	-	-	
Rated voltage [V]		Nominal current / cross section [A] / [mm ²]		
-		24 / 2.5		
Rated cross section [mm ²]		2.5		
General data				
Insulating material		PA		
Flammability rating in accordance with UL 94		V0		

Ordering data

Description	No. of pos.	Width	Color	Type	Order No.	Pcs./Pkt.
COMBI header	2	10.4 mm	gray	ST 2,5-PCB/ 2-G-5,2	1980378	50
	3	15.6 mm	gray	ST 2,5-PCB/ 3-G-5,2	1980381	50
	4	20.8 mm	gray	ST 2,5-PCB/ 4-G-5,2	1980394	50
	5	26 mm	gray	ST 2,5-PCB/ 5-G-5,2	1980404	50
	6	31.2 mm	gray	ST 2,5-PCB/ 6-G-5,2	1980417	50
	7	36.4 mm	gray	ST 2,5-PCB/ 7-G-5,2	1980420	50
	8	41.6 mm	gray	ST 2,5-PCB/ 8-G-5,2	1980433	50
	9	46.8 mm	gray	ST 2,5-PCB/ 9-G-5,2	1980446	50
	10	52 mm	gray	ST 2,5-PCB/10-G-5,2	1980459	50
	11	57.2 mm	gray	ST 2,5-PCB/11-G-5,2	1980462	50
	12	62.4 mm	gray	ST 2,5-PCB/12-G-5,2	1980475	50

Ordering data

Description	No. of pos.	Width	Color	Type	Order No.	Pcs./Pkt.
COMBI header	2	12.5 mm	gray	ST 2,5-PCBV/ 2-G-5,2	1980488	50
	3	17.7 mm	gray	ST 2,5-PCBV/ 3-G-5,2	1980491	50
	4	22.9 mm	gray	ST 2,5-PCBV/ 4-G-5,2	1980501	50
	5	28.1 mm	gray	ST 2,5-PCBV/ 5-G-5,2	1980514	50
	6	33.3 mm	gray	ST 2,5-PCBV/ 6-G-5,2	1980527	50
	7	38.5 mm	gray	ST 2,5-PCBV/ 7-G-5,2	1980530	50
	8	43.7 mm	gray	ST 2,5-PCBV/ 8-G-5,2	1980543	50
	9	48.9 mm	gray	ST 2,5-PCBV/ 9-G-5,2	1980556	50
	10	54.1 mm	gray	ST 2,5-PCBV/10-G-5,2	1980569	50
	11	59.3 mm	gray	ST 2,5-PCBV/11-G-5,2	1980572	50
	12	64.5 mm	gray	ST 2,5-PCBV/12-G-5,2	1980585	50

COMBI connectors

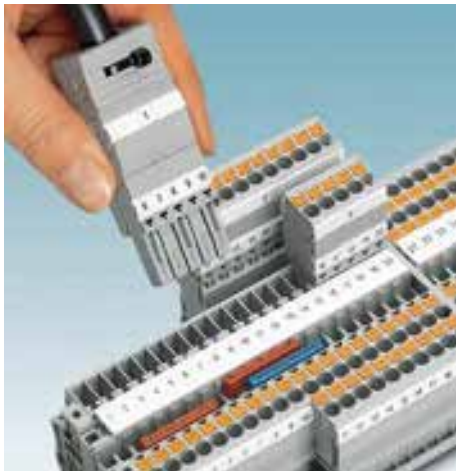

- Comprehensive, optional snap-on accessories available
- Practical coding facility
- Large-surface marking options
- Robust cable housings are available for strain relief on connecting cables

Notes:
1) For additional accessories and technical data, see page 290.
2) For derating curve, visit phoenixcontact.net/products



24 A, connector, connection in plug-in direction



Dimensions	[mm]
Width	5.2 x No. of pos.
Length	15.8
Height	40.2
Height plugged	24

Maximum electrical data	
I_{max} [A]	24 ²
U_{max} [V]	500
max. Ø [mm ²]	0.14 - 4
AWG (UL)	26-12

Rated data	[V]
Rated voltage	500
Nominal current / cross section	24 ² / 2.5

Technical data ¹⁾			
Width	Length	Height	Height plugged
5.2 x No. of pos.	15.8	40.2	24
I_{max} [A]	U_{max} [V]	max. Ø [mm ²]	AWG (UL)
24 ²	500	0.14 - 4	26-12
IEC	UL / CUL	CSA	Ex
24 ² / 2.5	20 / -	20 / -	- / -

Description	No. of pos.	Width	Color
COMBI connectors	1	5.2 mm	gray
	2	10.4 mm	gray
	3	15.6 mm	gray
	4	20.8 mm	gray
	5	26 mm	gray
	6	31.2 mm	gray
	7	36.4 mm	gray
	8	41.6 mm	gray
	9	46.8 mm	gray
	10	52 mm	gray
	11	57.2 mm	gray
	12	62.4 mm	gray
	13	67.6 mm	gray
	14	72.8 mm	gray
	15	78 mm	gray
1	5.2 mm	blue	
1	5.2 mm	green-yellow	

Ordering data		
Type	Order No.	Pcs./Pkt.
PP-H 2,5/ 1	① 3209866	50
PP-H 2,5/ 2	① 3209879	50
PP-H 2,5/ 3	① 3209882	50
PP-H 2,5/ 4	① 3209895	50
PP-H 2,5/ 5	① 3209905	50
PP-H 2,5/ 6	① 3209918	25
PP-H 2,5/ 7	① 3209921	25
PP-H 2,5/ 8	① 3209934	25
PP-H 2,5/ 9	① 3209947	25
PP-H 2,5/10	① 3209950	25
PP-H 2,5/11	① 3209963	10
PP-H 2,5/12	① 3209976	10
PP-H 2,5/13	① 3209989	10
PP-H 2,5/14	① 3209992	10
PP-H 2,5/15	① 3210004	10
PP-H 2,5/ 1 BU	① 3210017	50
PP-H 2,5/ 1 GNYE	① 3210020	50

Test plug metal part , 2.3 mm Ø	gray
Insulating sleeve , for MPS metal part	red
Latching and strain relief systems , for all plugs with conductor exit at top, 2-pos.	orange
Latching , for connectors, 1-pos.	orange
2-pos.	orange
Strain relief , for plugs, 2-pos.	black
Screw flange cover , for SP-H ... and PP 2,5..., PP-H ...COMBI connectors	gray
Cable housing , for COMBI plugs SP-H ... and PP-H ..., 2-pos.	gray
3-pos.	gray
4-pos.	gray
5-pos.	gray
6-pos.	gray
7-pos.	gray
8-pos.	gray
9-pos.	gray
10-pos.	gray
11-pos.	gray
12-pos.	gray
13-pos.	gray
14-pos.	gray
15-pos.	gray

Accessories ¹⁾		
MPS-MT	0201744	10
MPS-IH RD	0201676	10
PRZ	3040614	50
PR	3040559	50
PR/2	3040630	50
PZ/2	3040627	50
DF-SP-H 2,5	3209824	50
PH 2,5/ 2	3209691	50
PH 2,5/ 3	3209701	50
PH 2,5/ 4	3209714	50
PH 2,5/ 5	3209727	50
PH 2,5/ 6	3209730	25
PH 2,5/ 7	3209743	25
PH 2,5/ 8	3209756	25
PH 2,5/ 9	3209507	25
PH 2,5/10	3209769	25
PH 2,5/11	3209772	10
PH 2,5/12	3209785	10
PH 2,5/13	3209798	10
PH 2,5/14	3209808	10
PH 2,5/15	3209811	10

COMBI connectors for self-assembly

- The Push-in COMBI connectors for self-assembly provide solutions that users can implement themselves
- Robust cable housings are available for strain relief on connecting cables
- The connector is assembled directly on site by snapping together single-position connector elements. See below for an example of how these go together

- ① PP-H 2,5/S/1-L
- ② PP-H 2,5/S/1-M and PP-H 2.5/S/1-M BU
- ③ PP-H 2,5/S/1-R GNYE

Notes:
1) For additional accessories and technical data, see page 290.
2) For derating curve, visit phoenixcontact.net/products

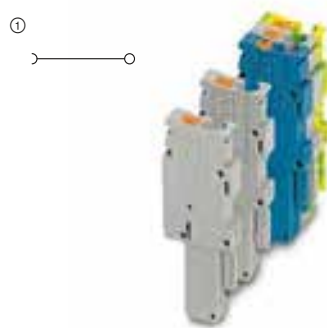

24 A, connector, connection in plug-in direction, for self-assembly



Dimensions	[mm]
Width	5.2 x No. of pos.
Length	15.8
Height	40.2
Height plugged	24

Maximum electrical data			
I _{max} [A]	U _{max} [V]	max. Ø [mm ²]	AWG (UL)
24 ²)	500	0.14 - 4	26-12
IEC	UL / CUL	CSA	Ex

Rated data	[V]
Rated voltage	500
Nominal current / cross section	24 ²) / 2.5

Technical data ¹⁾			
Width	Length	Height	Height plugged
5.2 x No. of pos.	15.8	40.2	24
I _{max} [A]	U _{max} [V]	max. Ø [mm ²]	AWG (UL)
24 ²)	500	0.14 - 4	26-12
IEC	UL / CUL	CSA	Ex
24 ²) / 2.5	20 / -	20 / -	- / -

Description	No. of pos.	Color
COMBI connector, left element	1	gray
	1	blue
	1	green-yellow
COMBI connector, center element	1	gray
	1	blue
COMBI connector, right element	1	green-yellow
	1	gray
COMBI connector, right element	1	blue
	1	gray
	1	green-yellow

Ordering data			
Type	Order No.	Pcs./Pkt.	
PP-H 2,5/1-L	① 3210062	50	
PP-H 2,5/1-L BU	① 3210075	50	
PP-H 2,5/1-L GNYE	① 3210088	50	
PP-H 2,5/1-M	① 3210091	50	
PP-H 2,5/1-M BU	① 3210101	50	
PP-H 2,5/1-M GNYE	① 3210114	50	
PP-H 2,5/1-R	① 3210127	50	
PP-H 2,5/1-R BU	① 3210130	50	
PP-H 2,5/1-R GNYE	① 3210143	50	

Test plug metal part, 2.3 mm Ø	gray
Insulating sleeve, for MPS metal part	red
Latching and strain relief systems, for all plugs with conductor exit at top, 2-pos.	orange
Latching, for connectors, 1-pos.	orange
2-pos.	orange
Strain relief, for plugs, 2-pos.	black
Screw flange cover, for SP-H ... and PP 2,5..., PP-H ... COMBI connectors	gray
Cable housing, for COMBI plugs SP-H ... and PP-H ..., 2-pos.	gray
3-pos.	gray
4-pos.	gray
5-pos.	gray
6-pos.	gray
7-pos.	gray
8-pos.	gray
9-pos.	gray
10-pos.	gray
11-pos.	gray
12-pos.	gray
13-pos.	gray
14-pos.	gray
15-pos.	gray

Accessories ¹⁾		
MPS-MT	0201744	10
MPS-IH RD	0201676	10
PRZ	3040614	50
PR	3040559	50
PR/2	3040630	50
PZ/2	3040627	50
DF-SP-H 2,5	3209824	50
PH 2,5/ 2	3209691	50
PH 2,5/ 3	3209701	50
PH 2,5/ 4	3209714	50
PH 2,5/ 5	3209727	50
PH 2,5/ 6	3209730	25
PH 2,5/ 7	3209743	25
PH 2,5/ 8	3209756	25
PH 2,5/ 9	3209507	25
PH 2,5/10	3209769	25
PH 2,5/11	3209772	10
PH 2,5/12	3209785	10
PH 2,5/13	3209798	10
PH 2,5/14	3209808	10
PH 2,5/15	3209811	10



Terminal blocks – CLIPLINE complete

2.5 mm² COMBI PT plug-in connection solutions

COMBI connectors for 800 V in accordance with IEC or 600 V in accordance with UL

- For high standards in accordance with UL 508A
- 600 V for applications in accordance with UL 1059, use group C

Notes:
1) For additional accessories and technical data, see page 290.
2) For derating curve, visit phoenixcontact.net/products

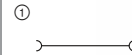

24 A, connector, connection in plug-in direction



Dimensions	[mm]
Width	5,2 x No. of pos.
Maximum electrical data	
Rated data	
Rated voltage	[V]
Nominal current / cross section	[A] / [mm ²]

Technical data ¹⁾			
Width	Length	Height	Height plugged
5,2 x No. of pos.	16	41.2	25.6
I _{max.} [A]	U _{max.} [V]	max. Ø [mm ²]	AWG (UL)
24 ²⁾	800	0.14 - 4	26-12
IEC	UL / CUL	CSA	Ex
800	600	600	-
24 ²⁾ / 2.5	20 / -	20 / -	- / -

Description	No. of pos.	Width	Color
COMBI connectors	1	5.2 mm	gray
	2	10.4 mm	gray
	3	15.6 mm	gray
	4	20.8 mm	gray
	5	26 mm	gray
	6	31.2 mm	gray
	7	36.4 mm	gray
	8	41.6 mm	gray
	9	46.8 mm	gray
	10	52 mm	gray
	11	57.2 mm	gray
	12	62.4 mm	gray
	13	67.6 mm	gray
	14	72.8 mm	gray
	15	78 mm	gray

Ordering data		
Type	Order No.	Pcs./Pkt.
PP 2,5/ 1	① 3211280	50
PP 2,5/ 2	① 3211281	50
PP 2,5/ 3	① 3211282	50
PP 2,5/ 4	① 3211283	50
PP 2,5/ 5	① 3211284	50
PP 2,5/ 6	① 3211285	25
PP 2,5/ 7	① 3211286	25
PP 2,5/ 8	① 3211287	25
PP 2,5/ 9	① 3211288	25
PP 2,5/10	① 3211289	25
PP 2,5/11	① 3211290	10
PP 2,5/12	① 3211291	10
PP 2,5/13	① 3211292	10
PP 2,5/14	① 3211293	10
PP 2,5/15	① 3211294	10

Test plug metal part , 2.3 mm Ø	gray
Insulating sleeve , for MPS metal part	red
Latching and strain relief systems , for all plugs with conductor exit at top, 2-pos.	orange
Latching , for connectors, 1-pos.	orange
2-pos.	orange
Strain relief , for plugs, 2-pos.	black
Screw flange cover , for SP-H ... and PP 2,5..., PP-H ...COMBI connectors	gray

Accessories ¹⁾		
MPS-MT	0201744	10
MPS-IH RD	0201676	10
PRZ	3040614	50
PR	3040559	50
PR/2	3040630	50
PZ/2	3040627	50
DF-SP-H 2,5	3209824	50

COMBI connectors for self-assembly

- The Push-in COMBI connectors for self-assembly provide solutions that users can implement themselves
- Robust cable housings are available for strain relief on connecting cables
- The connector is assembled directly on site by snapping together single-position connector elements. See below for an example of how these go together

- ① PP 2,5/1-L
- ② PP 2,5/1-M and PP 2,5/1-M BU
- ③ PP 2,5/1-R GNYE

Notes:
1) For additional accessories and technical data, see page 290.
2) For derating curve, visit phoenixcontact.net/products

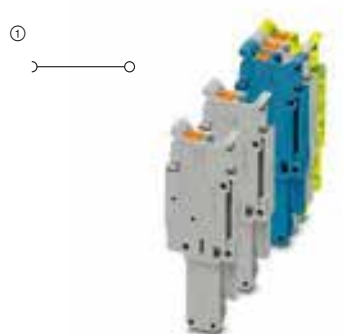

24 A, connector, connection in plug-in direction, for self-assembly



Dimensions	
	[mm]
Maximum electrical data	
Rated data	
Rated voltage	[V]
Nominal current / cross section	[A] / [mm ²]

Technical data ¹⁾			
Width	Length	Height	Height plugged
5.2 x No. of pos.	16	41.2	25.6
I _{max} [A]	U _{max} [V]	max. Ø [mm ²]	AWG (UL)
24 ²⁾	800	0.14 - 4	26-12
IEC	UL / CUL	CSA	Ex
800	600	600	-
24 ²⁾ / 2.5	20 / -	20 / -	- / -

Description	No. of pos.	Color
COMBI connector, left element	1	gray
	1	blue
	1	green-yellow
COMBI connector, center element	1	gray
	1	blue
COMBI connector, right element	1	green-yellow
	1	gray
COMBI connector, right element	1	blue
	1	gray
	1	green-yellow

Ordering data		
Type	Order No.	Pcs./Pkt.
PP 2,5/ 1-L	① 3211271	50
PP 2,5/ 1-L BU	① 3211272	50
PP 2,5/ 1-L GNYE	① 3211273	50
PP 2,5/ 1-M	① 3211274	50
PP 2,5/ 1-M BU	① 3211275	50
PP 2,5/ 1-M GNYE	① 3211276	50
PP 2,5/ 1-R	① 3211277	50
PP 2,5/ 1-R BU	① 3211278	50
PP 2,5/ 1-R GNYE	① 3211279	50

Test plug metal part, 2.3 mm Ø	gray
Insulating sleeve, for MPS metal part	red
Latching and strain relief systems, for all plugs with conductor exit at top, 2-pos.	orange
Latching, for connectors, 1-pos.	orange
Latching, for connectors, 2-pos.	orange
Strain relief, for plugs, 2-pos.	black
Screw flange cover, for SP-H ... and PP 2,5..., PP-H ...COMBI connectors	gray

Accessories ¹⁾		
MPS-MT	0201744	10
MPS-IH RD	0201676	10
PRZ	3040614	50
PR	3040559	50
PR/2	3040630	50
PZ/2	3040627	50
DF-SP-H 2,5	3209824	50



Terminal blocks – CLIPLINE complete

2.5 mm² COMBI UT plug-in connection solutions

General technical data

Rated data		IEC 61984
Rated cross section	[mm ²]	2.5
Cross section range	AWG	26 - 12
Connection capacity		Rigid Flexible Ferrule without/with plastic sleeve
1 conductor	[mm ²]	0.14 - 4 0.14 - 4 0.14 - 2.5 0.14 - 2.5
2 conductors (of the same type)	[mm ²]	0.14 - 1.5 0.14 - 1.5 0.14 - 1.5 -
2 flexible conductors with a TWIN ferrule	[mm ²]	- - - 0.5 - 1.5
General data		
Stripping length	[mm]	9
Insulating material		PA
Flammability rating in accordance with UL 94		V0

Note: Additional or deviating data is listed alongside the respective product.

Notes:



In addition to the product, the internal electrical wiring is provided as a circuit diagram. Free connection points for bridging are indicated by a black dot.

The specified technical data and approvals refer to the first product in each column. For information on the products below, please refer to phoenixcontact.net/products

For full details of UL and CSA use groups, file nos., and Internet links, please visit phoenixcontact.net/products

¹⁾ The bridge current is listed alongside the respective product. For additional colors, see page 402.

System accessories

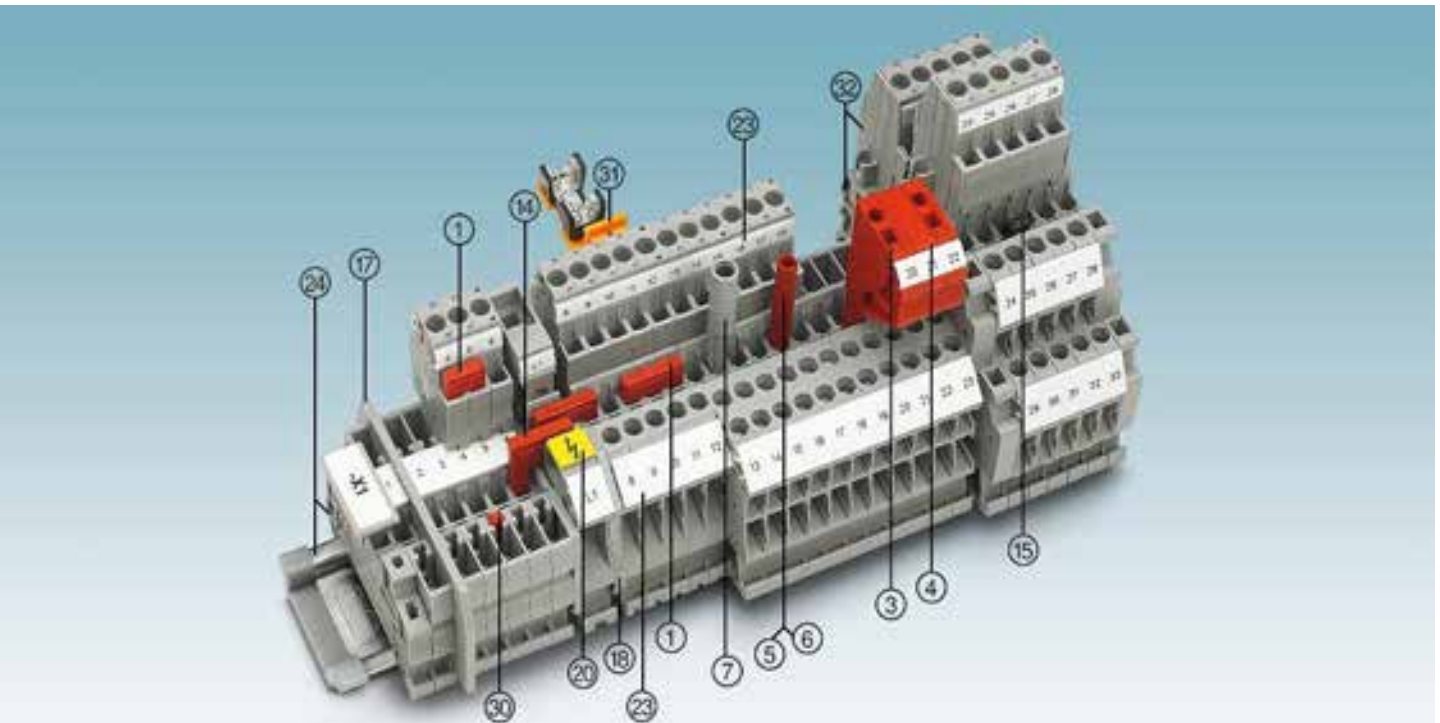

Description	No. of pos.	Color	Type	Order No.	Pcs./Pkt.	Type	Order No.	Pcs./Pkt.
① Bridge ¹⁾	2	red	FBS 2-5	3030161	50	FBSR 2-5	3033702	50
	3	red	FBS 3-5	3030174	50	FBSR 3-5	3001591	50
	4	red	FBS 4-5	3030187	50	FBSR 4-5	3001592	50
	5	red	FBS 5-5	3030190	50	FBSR 5-5	3001593	50
	10	red	FBS 10-5	3030213	10	FBSR 10-5	3033710	10
	20	red	FBS 20-5	3030226	10			
③ Modular test plug		red	PS-5	3030983	10			
④ Spacer plate		red	DP PS-5	3036725	10			
⑤ Test plug metal part		gray	MPS-MT	0201744	10			
⑥ Insulating sleeve, for MPS metal part		red	MPS-IH RD	0201676	10			
⑦ Test adapter, 4 mm socket hole		gray	PAI-4-N GY	3032871	10			
⑧ Coding profile		red	PC	3040588	50			
Screwdriver			SF-SL 0,6X3,5-100 S-VDE	1212587	10			
⑭ Reducing bridge	For RB ..., see page 408.							
⑮ Vertical potential bridge	For FBS-PV ..., see page 404.							
⑯ Partition plates/end cover segments	For ATP-... / DS-..., visit phoenixcontact.net/products							
⑰ Cover	Listed alongside the respective product.							
⑱ Warning labels	For WS ..., see page 420.							
⑳ Lateral groove labeling	Terminal block: UC-TM 5, UCT-TM 5 or ZB 5. Connector: UC-TMF 5, UCT-TMF 5 or ZBF 5. See also Catalog 3, selection tables, from page 60.							
㉑ DIN rail and end bracket	See Catalog 3							
㉒ Latching, strain relief, shielding	See from page 362.							
㉓ Screw flanges, screw flange cover	See from page 372.							
For full accessories, visit phoenixcontact.net/products	Note: Additional or deviating accessories are listed alongside the respective product.							

Feed-through, multi-conductor, multi-level, and ground terminal blocks

Notes:
 1) For additional accessories and technical data, see page 302.
 2) For derating curve, visit phoenixcontact.net/products
 For screw flange, see page 372.

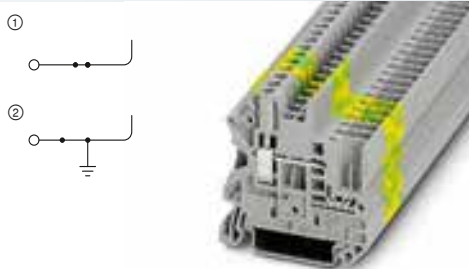

24 A, feed-through terminal block



Technical data ¹⁾			
Width	Length	Height	
5.2	49.1	47.5 (NS 35/7,5)	
I_{max} [A]	U_{max} [V]	max. Ø [mm ²]	AWG (UL)
24 ²⁾	500	0.14 - 4	26-12
24 (FBS) / 17.5 (FBSR)			
IEC	UL / CUL	CSA	Ex
500	300	300	-
Nominal current / cross section	[A] / [mm ²]	20 / -	20 / -
Connection capacity		Ferrule	
2 conductors (of the same type)		without/with plastic sleeve	
2 flexible conductors with a TWIN ferrule		0.14 - 1.5	0.14 - 1.5
		-	0.5 - 1.5

Ordering data			
Type	Order No.	Pcs./Pkt.	
UT 2,5/1P	① 3045017	50	
UT 2,5/1P BU	① 3045020	50	
UT 2,5/1P-PE	② 3045033	50	

Accessories ¹⁾		
D-UT 2,5/1P	3047154	50

Dimensions	[mm]
Maximum electrical data	
Maximum bridge current	[A]
Rated data	
Rated voltage	[V]
Nominal current / cross section	[A] / [mm ²]
Connection capacity	
2 conductors (of the same type)	[mm ²]
2 flexible conductors with a TWIN ferrule	[mm ²]

Description	Color
Terminal block	gray blue
Ground terminal	green-yellow

Cover, width: 2.2 mm	gray
----------------------	------

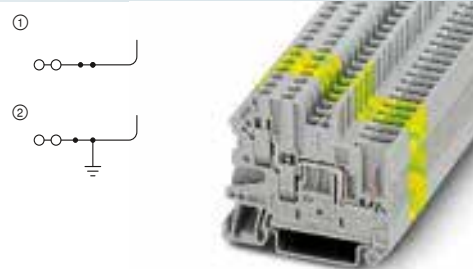

24 A, feed-through terminal block, 3 connections



Technical data ¹⁾			
Width	Length	Height	
5.2	55.7	47.5 (NS 35/7,5)	
I_{max} [A]	U_{max} [V]	max. Ø [mm ²]	AWG (UL)
24 ²⁾	500	0.14 - 4	26-12
24 (FBS) / 17.5 (FBSR)			
IEC	UL / CUL	CSA	Ex
500	300	-	-
Nominal current / cross section	[A] / [mm ²]	20 / -	- / -
Connection capacity		Ferrule	
0.14 - 1.5		without/with plastic sleeve	
		0.14 - 1	-
		-	0.5 - 1

Ordering data			
Type	Order No.	Pcs./Pkt.	
UT 2,5-TWIN/1P	① 3060490	50	
UT 2,5-TWIN/1P BU	① 3060500	50	
UT 2,5-TWIN/1P-PE	② 3060513	50	

Accessories ¹⁾		
D-UT 4-TWIN/ 1P	3045237	50

Feed-through, multi-conductor, multi-level, and ground terminal blocks

Notes:
 1) For additional accessories and technical data, see page 302.
 2) For derating curve, visit phoenixcontact.net/products
 For screw flange, see page 372.

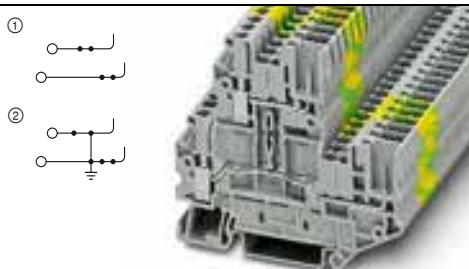

24 A, feed-through terminal block



Technical data ¹⁾			
Width	Length	Height	
5.2	69.9	65 (NS 35/7,5)	
I_{max} [A]	U_{max} [V]	max. Ø [mm ²]	AWG (UL)
24 ²⁾	500	0.14 - 4	26-12
24 (FBS) / 17.5 (FBSR)			
IEC	UL / CUL	CSA	Ex
500	600	-	-
Nominal current / cross section	[A] / [mm ²]	20 / -	- / -

Ordering data			
Type	Order No.	Pcs./Pkt.	
UTTB 2,5/2P	① 3060351	50	
UTTB 2,5/2P BU	① 3060364	50	
UTTB 2,5/2P-PE	② 3060380	50	

Accessories ¹⁾		
D-UTTB 2,5/4 2P	3060393	50

Dimensions	[mm]
Maximum electrical data	
Maximum bridge current	[A]
Rated data	
Rated voltage	[V]
Nominal current / cross section	[A] / [mm ²]

Description	Color
Terminal block	gray blue gray blue
Ground terminal	green-yellow

Cover, width: 2.2 mm	gray
----------------------	------

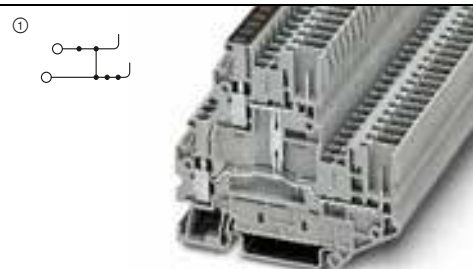

24 A, double-level terminal block with equipotential bonder



Technical data ¹⁾			
Width	Length	Height	
5.2	69.9	65 (NS 35/7,5)	
I_{max} [A]	U_{max} [V]	max. Ø [mm ²]	AWG (UL)
24 ²⁾	500	0.14 - 4	26-12
24 (FBS) / 17.5 (FBSR)			
IEC	UL / CUL	CSA	Ex
500	600	-	-
Nominal current / cross section	[A] / [mm ²]	20 / -	- / -

Ordering data			
Type	Order No.	Pcs./Pkt.	
UTTB 2,5/2P-PV	① 3060377	50	
UTTB 2,5/2P-PV BU	① 3060487	50	

Accessories ¹⁾		
D-UTTB 2,5/4 2P	3060393	50

Terminal blocks – CLIPLINE complete

2.5 mm² COMBI UT plug-in connection solutions

Feed-through, multi-conductor, multi-level, and ground terminal blocks

Notes:
1) For additional accessories and technical data, see page 302.
2) For derating curve, visit phoenixcontact.net/products
For screw flange, see page 372.
For self-locking flange, see page 371.

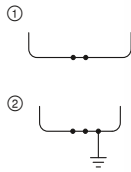

24 A, feed-through terminal block

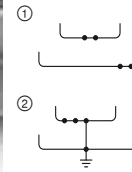

22 A, double-level terminal block



		Technical data ¹⁾			
Dimensions		Width	Length	Height	
		5.2	49.1	36.5 (NS 35/7,5)	
Maximum electrical data		I _{max} [A]	U _{max} [V]	max. Ø [mm ²]	AWG (UL)
		24 ²⁾	500	0.08 - 4	-
Maximum bridge current		24 (FBS) / 17.5 (FBSR)			
Rated data		IEC	UL / CUL	CSA	Ex
Rated voltage		500	600	300	-
Nominal current / cross section		24 ²⁾ / 2.5	20 / -	20 / -	- / -
Cross section range		28 - 12	-	-	-
Connection capacity		Rigid	Flexible	Ferrule without/with plastic sleeve	
1 conductor		0.08 - 4	0.08 - 2.5	0.14 - 2.5	0.14 - 2.5
2 flexible conductors with a TWIN ferrule		-	-	-	0.5
		Ordering data			
Description	Color	Type	Order No.	Pcs./Pkt.	
Terminal block	gray	ST 2,5/2P	① 3042133	50	
	blue	ST 2,5/2P BU	① 3042094	50	
Ground terminal	green-yellow	ST 2,5/2P-PE	② 3042146	50	
		Accessories ¹⁾			
Cover, width: 2.2 mm	gray	D-ST 2,5	3030417	50	

		Technical data ¹⁾			
Dimensions		Width	Length	Height	
		5.2	98.8	47.5 (NS 35/7,5)	
Maximum electrical data		I _{max} [A]	U _{max} [V]	max. Ø [mm ²]	AWG (UL)
		22 ²⁾	500	0.08 - 4	-
Maximum bridge current		24 (FBS) / 17.5 (FBSR)			
Rated data		IEC	UL / CUL	CSA	Ex
Rated voltage		500	600	600	-
Nominal current / cross section		22 ²⁾ / 2.5	20 / -	20 / -	- / -
Cross section range		28 - 12	-	-	-
Connection capacity		Rigid	Flexible	Ferrule without/with plastic sleeve	
1 conductor		0.08 - 4	0.08 - 2.5	0.14 - 2.5	0.14 - 2.5
2 flexible conductors with a TWIN ferrule		-	-	-	0.5
		Ordering data			
Description	Color	Type	Order No.	Pcs./Pkt.	
Terminal block	gray	STTB 2,5/4P	① 3061486	50	
	blue	STTB 2,5/4P BU	① 3061512	50	
Ground terminal	green-yellow	STTB 2,5/4P-PE	② 3061499	50	
		Accessories ¹⁾			
Cover, width: 2.2 mm	gray	D-STTB 2,5/4P	3061538	50	

Feed-through, multi-conductor, multi-level, and ground terminal blocks

Notes:
1) For additional accessories and technical data, see page 302.
2) For derating curve, visit phoenixcontact.net/products

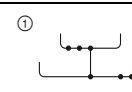

22 A, double-level terminal block with equipotential bonding



		Technical data ¹⁾			
Dimensions		Width	Length	Height	
		5.2	98.8	47.5 (NS 35/7,5)	
Maximum electrical data		I _{max} [A]	U _{max} [V]	max. Ø [mm ²]	AWG (UL)
		22 ²⁾	500	0.08 - 4	-
Maximum bridge current		24 (FBS) / 17.5 (FBSR)			
Rated data		IEC	UL / CUL	CSA	Ex
Rated voltage		500	600	600	-
Nominal current / cross section		22 ²⁾ / 2.5	20 / -	20 / -	- / -
Cross section range		28 - 12	-	-	-
Connection capacity		Rigid	Flexible	Ferrule without/with plastic sleeve	
1 conductor		0.08 - 4	0.08 - 2.5	0.14 - 2.5	0.14 - 2.5
2 flexible conductors with a TWIN ferrule		-	-	-	0.5
		Ordering data			
Description	Color	Type	Order No.	Pcs./Pkt.	
Terminal block	gray	STTB 2,5/4P-PV	① 3061509	50	
		Accessories ¹⁾			
Cover, width: 2.2 mm	gray	D-STTB 2,5/4P	3061538	50	

		Technical data ¹⁾			
Dimensions		Width	Length	Height	
		5.2	98.8	47.5 (NS 35/7,5)	
Maximum electrical data		I _{max} [A]	U _{max} [V]	max. Ø [mm ²]	AWG (UL)
		22 ²⁾	500	0.08 - 4	-
Maximum bridge current		24 (FBS) / 17.5 (FBSR)			
Rated data		IEC	UL / CUL	CSA	Ex
Rated voltage		500	600	600	-
Nominal current / cross section		22 ²⁾ / 2.5	20 / -	20 / -	- / -
Cross section range		28 - 12	-	-	-
Connection capacity		Rigid	Flexible	Ferrule without/with plastic sleeve	
1 conductor		0.08 - 4	0.08 - 2.5	0.14 - 2.5	0.14 - 2.5
2 flexible conductors with a TWIN ferrule		-	-	-	0.5
		Ordering data			
Description	Color	Type	Order No.	Pcs./Pkt.	
Terminal block	gray	STTB 2,5/4P-PV	① 3061509	50	
		Accessories ¹⁾			
Cover, width: 2.2 mm	gray	D-STTB 2,5/4P	3061538	50	

COMBI headers for PCB connection

Notes:

For additional accessories and technical data, see page 364 or visit phoenixcontact.net/products

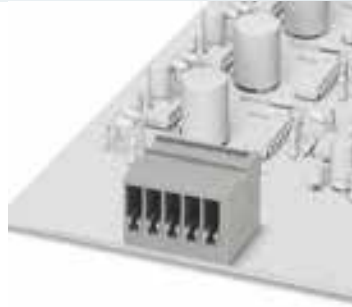

24 A, header, horizontal plug-in direction



24 A, header, vertical plug-in direction



Technical data				
Width	Length	Height		
10.4	21.7	18.1		
I _{max.} [A]		max. Ø [mm ²]		AWG (UL)
24		-		-
IEC	UL	CSA	IEC/EN 60079-7	
-	300	-	-	
Rated voltage [V]		Nominal current / cross section [A] / [mm ²]		
-		24 / 2.5		
Rated cross section [mm ²]		-		
2.5		-		
General data				
Insulating material				
PA				
Flammability rating in accordance with UL 94				
V0				



Technical data				
Width	Length	Height		
12.5	18.05	21.7		
I _{max.} [A]		max. Ø [mm ²]		AWG (UL)
24		-		-
IEC	UL	CSA	IEC/EN 60079-7	
-	300	-	-	
Rated voltage [V]		Nominal current / cross section [A] / [mm ²]		
-		24 / 2.5		
Rated cross section [mm ²]		-		
2.5		-		
General data				
Insulating material				
PA				
Flammability rating in accordance with UL 94				
V0				

Ordering data

Description	No. of pos.	Width	Color	Type	Order No.	Pcs./Pkt.
COMBI header	2	10.4 mm	gray	ST 2,5-PCB/ 2-G-5,2	1980378	50
	3	15.6 mm	gray	ST 2,5-PCB/ 3-G-5,2	1980381	50
	4	20.8 mm	gray	ST 2,5-PCB/ 4-G-5,2	1980394	50
	5	26 mm	gray	ST 2,5-PCB/ 5-G-5,2	1980404	50
	6	31.2 mm	gray	ST 2,5-PCB/ 6-G-5,2	1980417	50
	7	36.4 mm	gray	ST 2,5-PCB/ 7-G-5,2	1980420	50
	8	41.6 mm	gray	ST 2,5-PCB/ 8-G-5,2	1980433	50
	9	46.8 mm	gray	ST 2,5-PCB/ 9-G-5,2	1980446	50
	10	52 mm	gray	ST 2,5-PCB/10-G-5,2	1980459	50
	11	57.2 mm	gray	ST 2,5-PCB/11-G-5,2	1980462	50
	12	62.4 mm	gray	ST 2,5-PCB/12-G-5,2	1980475	50

Ordering data

Description	No. of pos.	Width	Color	Type	Order No.	Pcs./Pkt.
COMBI header	2	12.5 mm	gray	ST 2,5-PCBV/ 2-G-5,2	1980488	50
	3	17.7 mm	gray	ST 2,5-PCBV/ 3-G-5,2	1980491	50
	4	22.9 mm	gray	ST 2,5-PCBV/ 4-G-5,2	1980501	50
	5	28.1 mm	gray	ST 2,5-PCBV/ 5-G-5,2	1980514	50
	6	33.3 mm	gray	ST 2,5-PCBV/ 6-G-5,2	1980527	50
	7	38.5 mm	gray	ST 2,5-PCBV/ 7-G-5,2	1980530	50
	8	43.7 mm	gray	ST 2,5-PCBV/ 8-G-5,2	1980543	50
	9	48.9 mm	gray	ST 2,5-PCBV/ 9-G-5,2	1980556	50
	10	54.1 mm	gray	ST 2,5-PCBV/10-G-5,2	1980569	50
	11	59.3 mm	gray	ST 2,5-PCBV/11-G-5,2	1980572	50
	12	64.5 mm	gray	ST 2,5-PCBV/12-G-5,2	1980585	50

Terminal blocks – CLIPLINE complete

2.5 mm² COMBI UT plug-in connection solutions

COMBI connectors



- When it comes to the connectors, as is the case with the basic terminal blocks, the right connection technology is available for every application
- Comprehensive, optional snap-on accessories available
- Practical coding facility
- Large-surface marking options
- The screw connectors can be combined with COMBI terminal blocks with all forms of connection technology and are available in two versions

UPBV ... connectors

- Bridgeable with the standard bridges FBS ...
- Side conductor connection
- Screw actuation from above
- The connected conductors can be passed directly into the cable duct to save space

Notes:
1) For additional accessories and technical data, see page 302.

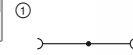

24 A, connector, connection at a right angle to the plug-in direction



Dimensions		[mm]
Maximum electrical data		
Maximum bridge current	[A]	24
Rated data		
Rated voltage	[V]	500
Nominal current / cross section	[A] / [mm ²]	24 / 2.5
Connection capacity		
2 flexible conductors with a TWIN ferrule	[mm ²]	-

Technical data ¹⁾			
Width	Length	Height	Height plugged
5.2 x No. of pos.	20.5	47	32.2
I _{max} [A]	U _{max} [V]	max. Ø [mm ²]	AWG (UL)
24 (FBS) / 17.5 (FBSR)	500	0.14 - 4	26-12
IEC	UL / CUL	CSA	Ex
500	600	-	-
24 / 2.5	20 / -	- / -	- / -
Rigid	Flexible	Ferrule without/with plastic sleeve	
-	-	-	0.5 - 1

Description	No. of pos.	Width	Color
Connector	1	5.2 mm	gray
	2	10.4 mm	gray
	3	15.6 mm	gray
	4	20.8 mm	gray
	5	26 mm	gray
	6	31.2 mm	gray
	7	36.4 mm	gray
	8	41.6 mm	gray
	9	46.8 mm	gray
	10	52 mm	gray
	11	57.2 mm	gray
	12	62.4 mm	gray
	13	67.6 mm	gray
	14	72.8 mm	gray
	15	78 mm	gray
	1	5.2 mm	blue
	1	5.2 mm	green-yellow

Ordering data		
Type	Order No.	Pcs./Pkt.
UPBV 2,5/ 1	① 3045145	50
UPBV 2,5/ 2	① 3045402	50
UPBV 2,5/ 3	① 3045415	50
UPBV 2,5/ 4	① 3045428	50
UPBV 2,5/ 5	① 3045431	50
UPBV 2,5/ 6	① 3045444	25
UPBV 2,5/ 7	① 3045457	25
UPBV 2,5/ 8	① 3045460	25
UPBV 2,5/ 9	① 3045473	25
UPBV 2,5/10	① 3045499	25
UPBV 2,5/11	① 3045509	10
UPBV 2,5/12	① 3045512	10
UPBV 2,5/13	① 3045525	10
UPBV 2,5/14	① 3045538	10
UPBV 2,5/15	① 3045541	10
UPBV 2,5/ 1 BU	① 3045240	50
UPBV 2,5/ 1 GNYE	① 3045253	50

Strain relief , for UPBV... plugs, 2-pos.	black
Latching , for UPBV plugs, 2-pos.	orange
Latching and strain relief systems , for UPBV... plugs, 2-pos.	orange
Screw flange cover , for UPBV 2,5 and UPBV 4 COMBI plugs	gray

Accessories ¹⁾	
UPZ/ 2	3045554 50
UPR/ 2	3045567 50
UPRZ	3045570 50
DF-UPBV 2,5/ 4	3060432 50

COMBI connectors for self-assembly

Notes:
1) For additional accessories and technical data, see page 302.
2) For derating curve, visit phoenixcontact.net/products

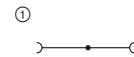

24 A, connector, connection at a right angle to the plug-in direction



Dimensions	[mm]
5.2 x No. of pos.	
Maximum electrical data	
Maximum bridge current	[A]
Rated data	
Rated voltage	[V]
Nominal current / cross section	[A] / [mm ²]
Connection capacity	
2 flexible conductors with a TWIN ferrule	[mm ²]

Technical data ¹⁾			
Width	Length	Height	Height plugged
5.2 x No. of pos.	20.5	47	32.2
I_{max} [A]	U_{max} [V]	max. Ø [mm ²]	AWG (UL)
24 ²⁾	500	0.14 - 4	26-12
24 (FBS) / 17.5 (FBSR)			
IEC	UL / CUL	CSA	Ex
500	600	-	-
24 ²⁾ / 2.5	20 / -	- / -	- / -
Rigid	Flexible	Ferrule without/with plastic sleeve	
-	-	-	0.5 - 1

Description	No. of pos.	Color
Connector, left element	1	gray
	1	blue
	1	green-yellow
Connector, center element	1	gray
	1	blue
	1	green-yellow
Connector, right element	1	gray
	1	blue
	1	green-yellow

Ordering data		
Type	Order No.	Pcs./Pkt.
UPBV 2,5/ 1-L	① 3045318	50
UPBV 2,5/ 1-L BU	① 3045321	50
UPBV 2,5/ 1-L GNYE	① 3045334	50
UPBV 2,5/ 1-M	① 3045347	50
UPBV 2,5/ 1-M BU	① 3045350	50
UPBV 2,5/ 1-M GNYE	① 3045363	50
UPBV 2,5/ 1-R	① 3045376	50
UPBV 2,5/ 1-R BU	① 3045389	50
UPBV 2,5/ 1-R GNYE	① 3045392	50

Strain relief, for UPBV... plugs, 2-pos.	black
Latching, for UPBV plugs, 2-pos.	orange
Latching and strain relief systems, for UPBV... plugs, 2-pos.	orange
Screw flange cover, for UPBV 2,5 and UPBV 4 COMBI plugs	gray

Accessories ¹⁾		
Type	Order No.	Pcs./Pkt.
UPZ/ 2	3045554	50
UPR/ 2	3045567	50
UPRZ	3045570	50
DF-UPBV 2,5/ 4	3060432	50

Terminal blocks – CLIPLINE complete

2.5 mm² COMBI ST plug-in connection solutions

General technical data

Rated data		IEC 61984
Rated cross section	[mm ²]	2.5
Cross section range	AWG	28 - 12
Connection capacity		Rigid Flexible Ferrule without/with plastic sleeve
1 conductor	[mm ²]	0.08 - 4 0.08 - 2.5 0.14 - 2.5 0.14 - 2.5
2 flexible conductors with a TWIN ferrule	[mm ²]	- - - 0.5
General data		
Stripping length	[mm]	8 - 10
Insulating material		PA
Flammability rating in accordance with UL 94		VO

Note: Additional or deviating data is listed alongside the respective product.

Notes:



In addition to the product, the internal electrical wiring is provided as a circuit diagram. Free connection points for bridging are indicated by a black dot.

The specified technical data and approvals refer to the first product in each column. For information on the products below, please refer to phoenixcontact.net/products

For full details of UL and CSA use groups, file nos., and Internet links, please visit phoenixcontact.net/products

¹⁾ The bridge current is listed alongside the respective product. For additional colors, see page 402.

System accessories

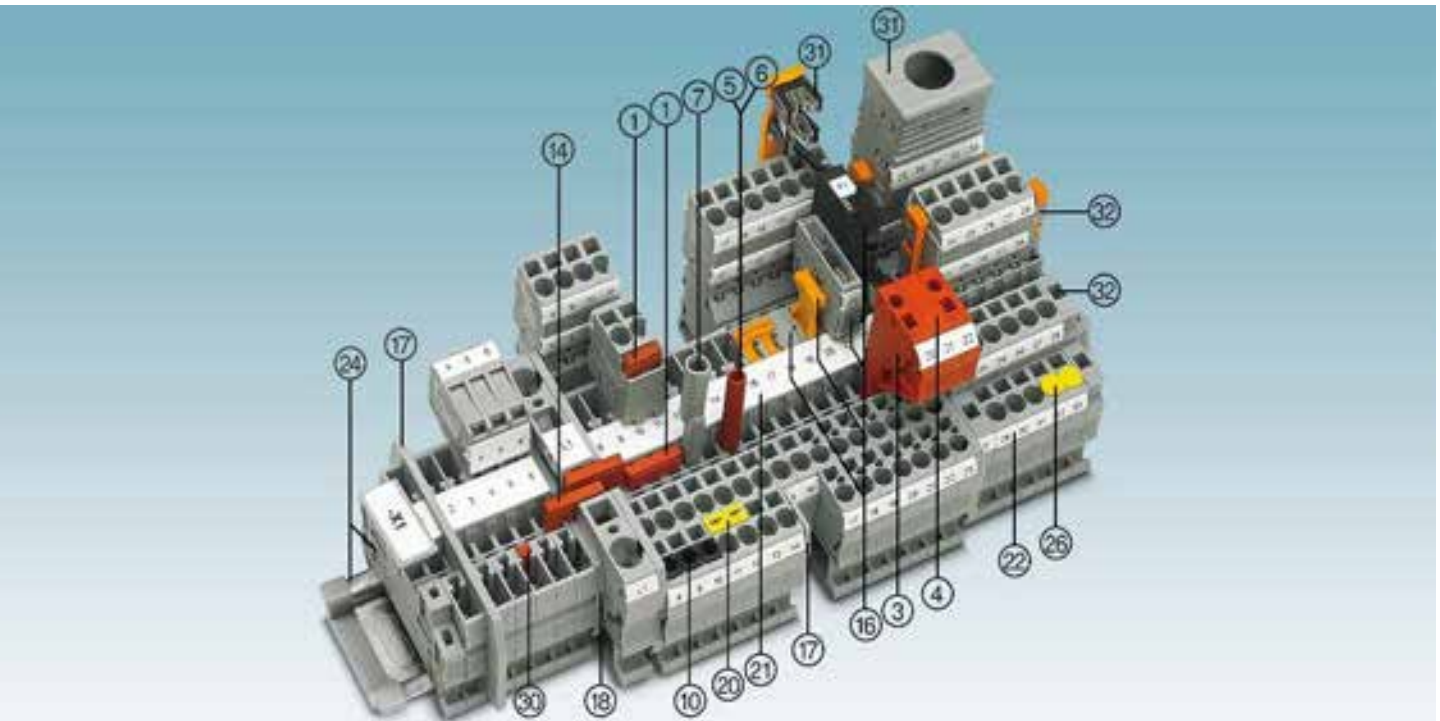

Description	No. of pos.	Color	Type	Order No.	Pcs./Pkt.	Type	Order No.	Pcs./Pkt.
① Bridge ¹⁾	2	red	FBS 2-5	3030161	50	FBSR 2-5	3033702	50
	3	red	FBS 3-5	3030174	50	FBSR 3-5	3001591	50
	4	red	FBS 4-5	3030187	50	FBSR 4-5	3001592	50
	5	red	FBS 5-5	3030190	50	FBSR 5-5	3001593	50
	10	red	FBS 10-5	3030213	10	FBSR 10-5	3033710	10
	20	red	FBS 20-5	3030226	10			
③ Modular test plug		red	PS-5	3030983	10			
④ Spacer plate		red	DP PS-5	3036725	10			
⑤ Test plug metal part		gray	MPS-MT	0201744	10			
⑥ Insulating sleeve, for MPS metal part		red	MPS-IH RD	0201676	10			
⑦ Test adapter, 4 mm socket hole		gray	PAI-4-N GY	3032871	10			
⑩ Insulating sleeve		white	ISH 2,5/0,2	3002843	50			
		gray	ISH 2,5/0,5	3002856	50			
		black	ISH 2,5/1,0	3002869	50			
Screwdriver			SZF 1-0,6X3,5	1204517	10			

⑭ Reducing bridge	For RB ..., see page 408.
⑮ Fuse and function plugs for disconnect terminal blocks	For P-FU ... / P-DI / P-FIX / P-CO ..., see from page 414.
⑰ Partition plates/end cover segments	For ATP-... / DS-..., visit phoenixcontact.net/products
⑱ Cover	Listed alongside the respective product.
⑲ Warning labels	For WS ..., see page 420.
⑲ Center groove labeling	UC-TM 5, UCT-TM 5 or ZB 5. See also Catalog 3, selection tables, from page 60.
⑲ Center and side groove labeling	UC-TMF 5, UCT-TMF 5 or ZBF 5. See also Catalog 3, selection tables, from page 60.
⑲ DIN rail and end bracket	See Catalog 3
⑲ Cover for conductor shaft	For CEC ..., see page 421.
⑲ Latching, strain relief, shielding	See from page 362.
⑲ Screw flanges, screw flange cover	See from page 372.
For full accessories, visit phoenixcontact.net/products	Note: Additional or deviating accessories are listed alongside the respective product.

Feed-through, multi-conductor, multi-level, and ground terminal blocks

Notes:
1) For additional accessories and technical data, see page 308.
2) For derating curve, visit phoenixcontact.net/products
For screw flange, see page 372.
For self-locking flange, see page 371.

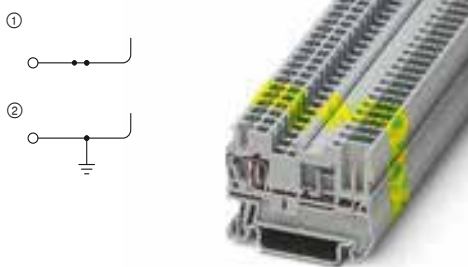

24 A, feed-through terminal block



Technical data ¹⁾				
Dimensions	Width	Length	Height	
	5.2	48.5	36.5 (NS 35/7,5)	
Maximum electrical data	I _{max.} [A]	U _{max.} [V]	max. Ø [mm ²]	AWG (UL)
	24 ²⁾	500	0.08 - 4	28-12
Maximum bridge current	24 (FBS) / 17.5 (FBSR)			
Rated data	IEC	UL / CUL	CSA	Ex
Rated voltage	500	600	300	-
Nominal current / cross section	24 ²⁾ / 2.5	20 / -	20 / -	- / -

Ordering data			
Type	Order No.	Pcs./Pkt.	
ST 2,5/ 1P	① 3040012	50	
ST 2,5/ 1P BU	① 3040656	50	
ST 2,5/ 1P-PE	② 3040025	50	

Accessories ¹⁾		
D-ST 2,5	3030417	50

Description	Color
Terminal block	gray
Ground terminal	green-yellow
Cover, width: 2.2 mm	gray

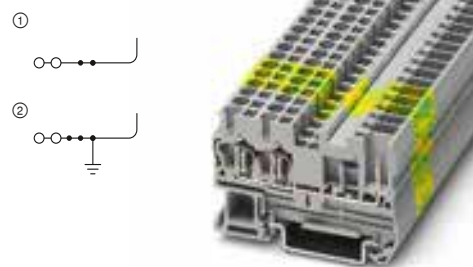

24 A, feed-through terminal block, 3 connections



Technical data ¹⁾				
Dimensions	Width	Length	Height	
	5.2	60.5	36.5 (NS 35/7,5)	
Maximum electrical data	I _{max.} [A]	U _{max.} [V]	max. Ø [mm ²]	AWG (UL)
	24 ²⁾	500	0.08 - 4	28-12
Maximum bridge current	24 (FBS) / 17.5 (FBSR)			
Rated data	IEC	UL / CUL	CSA	Ex
Rated voltage	500	600	600	-
Nominal current / cross section	24 ²⁾ / 2.5	20 / -	20 / -	- / -

Ordering data			
Type	Order No.	Pcs./Pkt.	
ST 2,5-TWIN/ 1P	① 3042117	50	
ST 2,5-TWIN/ 1P BU	① 3042104	50	
ST 2,5-TWIN/ 1P-PE	② 3042120	50	

Accessories ¹⁾		
D-ST 2,5-TWIN	3030488	50

Feed-through, multi-conductor, multi-level, and ground terminal blocks

Notes:
1) For additional accessories and technical data, see page 308.
2) For derating curve, visit phoenixcontact.net/products
For screw flange, see page 372.
For self-locking flange, see page 371.

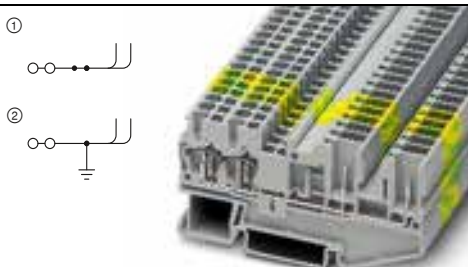

24 A, feed-through terminal block, 4 connections



Technical data ¹⁾				
Dimensions	Width	Length	Height	
	5.2	81	36.5 (NS 35/7,5)	
Maximum electrical data	I _{max.} [A]	U _{max.} [V]	max. Ø [mm ²]	AWG (UL)
	24 ²⁾	500	0.08 - 4	28-12
Maximum bridge current	24 (FBS) / 17.5 (FBSR)			
Rated data	IEC	UL / CUL	CSA	Ex
Rated voltage	500	600	600	-
Nominal current / cross section	24 ²⁾ / 2.5	20 / -	20 / -	- / -

Ordering data			
Type	Order No.	Pcs./Pkt.	
ST 2,5-QUATTRO/2P	① 3040038	50	
ST 2,5-QUATTRO/2P BU	① 3040669	50	
ST 2,5-QUATTRO/2P-PE	② 3040041	50	

Accessories ¹⁾		
D-ST 2,5-QUATTRO/2P	3040083	50

Description	Color
Terminal block	gray
With potential distribution	gray
Ground terminal	green-yellow
Cover, width: 2.2 mm	gray

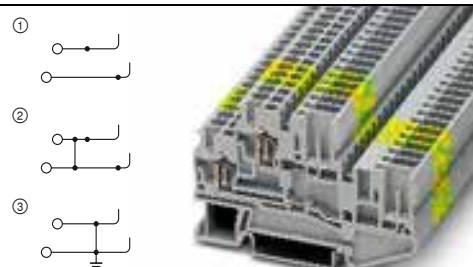

22 A, feed-through terminal block



Technical data ¹⁾				
Dimensions	Width	Length	Height	
	5.2	71.5	47.5 (NS 35/7,5)	
Maximum electrical data	I _{max.} [A]	U _{max.} [V]	max. Ø [mm ²]	AWG (UL)
	22 ²⁾	500	0.08 - 4	28-12
Maximum bridge current	24 (FBS) / 17.5 (FBSR)			
Rated data	IEC	UL / CUL	CSA	Ex
Rated voltage	500	600	600	-
Nominal current / cross section	22 ²⁾ / 2.5	20 / -	20 / -	- / -

Ordering data			
Type	Order No.	Pcs./Pkt.	
STTB 2,5/2P	① 3040054	50	
STTB 2,5/2P BU	① 3040672	50	
STTB 2,5/2P-PV	② 3040070	50	
STTB 2,5/2P-PV BU	② 3040685	50	
STTB 2,5/2P-PE	③ 3040067	50	

Accessories ¹⁾		
D-STTB 2,5/2P	3040096	50

Terminal blocks – CLIPLINE complete

2.5 mm² COMBI ST plug-in connection solutions

Multi-level terminal blocks

Notes:
1) For additional accessories and technical data, see page 308.
2) For derating curve, visit phoenixcontact.net/products
For screw flange, see page 372.
For self-locking flange, see page 371.

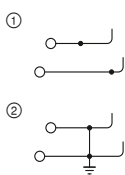

22 A, feed-through terminal block



Technical data ¹⁾				
Width	Length	Height		
5.2	71.5	47.5 (NS 35/7,5)		
I _{max} [A]	U _{max} [V]	max. Ø [mm ²]	AWG (UL)	
22 ²⁾	500	0.08 - 4	28-12	
24 (FBS) / 17.5 (FBSR)				
IEC	UL / CUL	CSA	Ex	
500	600	600	-	
22 ²⁾ / 2.5				
	20 / -	20 / -	- / -	

Ordering data			
Type	Order No.	Pcs./Pkt.	
STTB 2,5/2P SO	① 3040892	50	
STTB 2,5/2P BU SO	① 3040902	50	
STTB 2,5/2P-PE SO	② 3040915	50	

Accessories ¹⁾			
D-STTB 2,5/2P	Order No.	Pcs./Pkt.	
D-STTB 2,5/2P	3040096	50	

Dimensions	[mm]
Maximum electrical data	
Maximum bridge current	[A]
Rated data	
Rated voltage	[V]
Nominal current / cross section	[A] / [mm ²]

Description	Color
Terminal block , with marking groove on the plug-in side	gray
	blue
	gray
Ground terminal , with marking groove on the plug-in side	green/yellow

Cover , width: 2.2 mm	gray
------------------------------	------

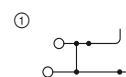

22 A, feed-through terminal block, with equipotential bonding



Technical data ¹⁾				
Width	Length	Height		
5.2	71.5	47.5 (NS 35/7,5)		
I _{max} [A]	U _{max} [V]	max. Ø [mm ²]	AWG (UL)	
22 ²⁾	500	0.08 - 4	28-12	
24 (FBS) / 17.5 (FBSR)				
IEC	UL / CUL	CSA	Ex	
500	600	-	-	
22 ²⁾ / 2.5				
	20 / -	- / -	- / -	

Ordering data			
Type	Order No.	Pcs./Pkt.	
STTB 2,5/2P-PV SO	① 3040928	50	

Accessories ¹⁾			
D-STTB 2,5/2P	Order No.	Pcs./Pkt.	
D-STTB 2,5/2P	3040096	50	

Disconnect and knife disconnect terminal blocks

Notes:
1) For additional accessories and technical data, see page 308.
2) Current and voltage are determined by the plug used.
3) For derating curve, visit phoenixcontact.net/products

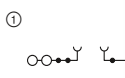

20 A, disconnect terminal block, 3 connections



Technical data ¹⁾				
Width	Length	Height		
5.2	81	36.5 (NS 35/7,5)		
I _{max} [A]	U _{max} [V]	max. Ø [mm ²]	AWG (UL)	
20 ³⁾	400 ²⁾	0.08 - 4	28-12	
24 (FBS) / 17.5 (FBSR)				
IEC	UL / CUL	CSA	Ex	
400 ²⁾	600	300	-	
20 ³⁾ / 2.5				
	20 / -	20 / -	- / -	

Ordering data			
Type	Order No.	Pcs./Pkt.	
ST 2,5-TWIN-TG/1P	① 3040847	50	

Accessories ¹⁾			
D-ST 2,5-QUATTRO/2P	Order No.	Pcs./Pkt.	
D-ST 2,5-QUATTRO/2P	3040083	50	

Dimensions	[mm]
Maximum electrical data	
Maximum bridge current	[A]
Rated data	
Rated voltage	[V]
Nominal current / cross section	[A] / [mm ²]

Description	Color
Disconnect terminal block	gray
Knife disconnect terminal block	gray

Cover , width: 2.2 mm	gray
------------------------------	------

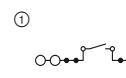

20 A, knife disconnect terminal block, 3 connections



Technical data ¹⁾				
Width	Length	Height		
5.2	81	36.5 (NS 35/7,5)		
I _{max} [A]	U _{max} [V]	max. Ø [mm ²]	AWG (UL)	
20 ³⁾	400	0.08 - 4	28-12	
24 (FBS) / 17.5 (FBSR)				
IEC	UL / CUL	CSA	Ex	
400	600	300	-	
20 ³⁾ / 2.5				
	20 / -	20 / -	- / -	

Ordering data			
Type	Order No.	Pcs./Pkt.	
ST 2,5-TWIN-MT/1P	① 3040766	50	

Accessories ¹⁾			
D-ST 2,5-QUATTRO/2P	Order No.	Pcs./Pkt.	
D-ST 2,5-QUATTRO/2P	3040083	50	

Four-level terminal blocks

Notes:
 1) For additional accessories and technical data, see page 308.
 2) For derating curve, visit phoenixcontact.net/products



10 A, four-level terminal block

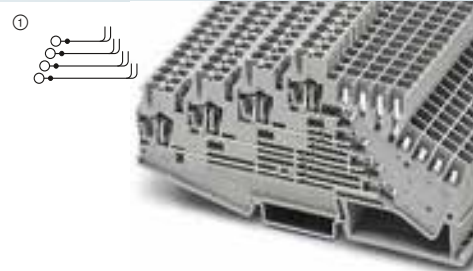

10 A, four-level terminal block, two slots



Technical data ¹⁾			
Width	Length	Height	
5.2	101	59 (NS 35/7,5)	
I_{max} [A]	U_{max} [V]	max. Ø [mm ²]	AWG (UL)
10 ²	250	0.08 - 4	28-12
24 (FBS) / 17.5 (FBSR)			
IEC	UL / CUL	CSA	Ex
250	300	300	-
10 ² / 1.5 10 / - 10 / - - / -			

Technical data ¹⁾			
Width	Length	Height	
5.2	120.5	59 (NS 35/7,5)	
I_{max} [A]	U_{max} [V]	max. Ø [mm ²]	AWG (UL)
10 ²	250	0.08 - 4	28-12
24 (FBS) / 17.5 (FBSR)			
IEC	UL / CUL	CSA	Ex
250	300	300	-
10 ² / 1.5 10 / - 10 / - - / -			

Ordering data			
Type	Order No.	Pcs./Pkt.	
ST 2,5-4L/1P	3041985	50	
ST 2,5-PE/3L/1P	3041969	50	

Ordering data			
Type	Order No.	Pcs./Pkt.	
ST 2,5-4L/2P	3042007	50	
ST 2,5-4L/2P-Z	3041998	50	

Accessories ¹⁾			
D-ST 2,5-4L/1P	3041930	50	

Accessories ¹⁾			
D-ST 2,5-4L/2P	3041927	50	

Dimensions	
	[mm]
Maximum electrical data	
Maximum bridge current	[A]
Rated data	
Rated voltage	[V]
Nominal current / cross section	[A] / [mm ²]

Description	Color
Terminal block	gray
with securing pin	gray

Description	Color
Cover, width: 2.2 mm	gray

Connector housings for four-level terminal blocks

Notes:
 In order to crimp STG-MTN... modular socket contacts, the CRIMPFOX MT 2,5 (Order No. 1204038) must be used.

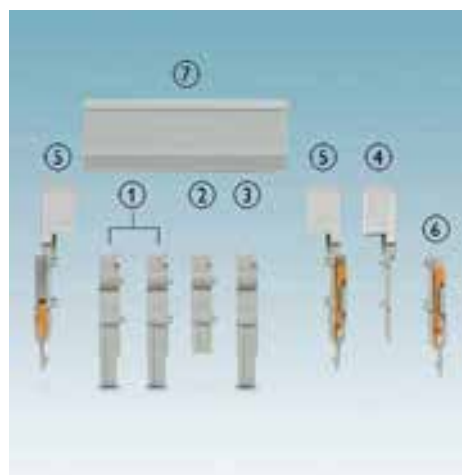

- ① 4-pos. connector with CP-H 2,5-4L-Z engagement pin
- ② DP-CP-H 2,5-4L spacer plate
- ③ CP-H 2,5-4L 4-pos. connector
- ④ D-CP-H 2,5-4L cover profile carrier
- ⑤ DFS-CP-H 2,5-4L cover profile carrier with self-locking flange cover
- ⑥ DFS-CP 2,5-4L self-locking flange cover
- ⑦ AP-CP-H cover profile



Connector housing, for accommodating four socket contacts

Description	Color
Plug housing, for accommodating 4 socket contacts	gray
Plug housing with engagement pin	gray

Ordering data			
Type	Order No.	Pcs./Pkt.	
CP-H 2,5-4L	3012313	50	
CP-H 2,5-4L-PE	3012323	50	
CP-H 2,5-4L-Z	3012314	50	
CP-H 2,5-4L-Z-PE	3012324	50	

Accessories					
Self-locking flange, can be labeled with UC-TM	gray	PT 2,5-4L/1P-FS	3012302	10	
Spacer plate	gray	DP-CP-H 2,5-4L	3012319	50	
Cover profile, 1 m, can be labeled with UC-TM ...					
	gray	AP-CP-H	METER	3012315	10
Cover profile carrier	gray	D-CP-H 2,5-4L		3012320	50
Cover profile carrier, with self-locking flange cover	gray	DFS-CP-H 2,5-4L		3012317	50
Self-locking flange cover	gray	DFS-CP 2,5-4L		3012321	50
Module socket contact, 0.5 - 1 mm ²	silver	STG-MTN 0,5-1,0		3190438	100
for wires from 1.5 ... 2.5 mm ²	silver	STG-MTN 1,5-2,5		3190506	100

Terminal blocks – CLIPLINE complete

2.5 mm² COMBI ST plug-in connection solutions

Feed-through, multi-conductor, multi-level, and ground terminal blocks

Notes:
1) For additional accessories and technical data, see page 308.
2) For derating curve, visit phoenixcontact.net/products
For screw flange, see page 372.
For self-locking flange, see page 371.

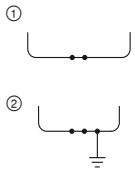

24 A, feed-through terminal block



Technical data ¹⁾				
Width	Length	Height		
5.2	49.1	36.5 (NS 35/7,5)		
I _{max} [A]	U _{max} [V]	max. Ø [mm ²]	AWG (UL)	
24 ²⁾	500	0.08 - 4	-	
24 (FBS) / 17.5 (FBSR)				
IEC	UL / CUL	CSA	Ex	
500	600	300	-	
24 ²⁾ / 2.5				
	20 / -	20 / -	- / -	

Ordering data			
Type	Order No.	Pcs./Pkt.	
ST 2,5/2P	① 3042133	50	
ST 2,5/2P BU	① 3042094	50	
ST 2,5/2P-PE	② 3042146	50	

Accessories ¹⁾			
D-ST 2,5	Order No.	Pcs./Pkt.	
D-ST 2,5	3030417	50	

Dimensions	[mm]
Maximum electrical data	
Maximum bridge current	[A]
Rated data	
Rated voltage	[V]
Nominal current / cross section	[A] / [mm ²]

Description	Color
Terminal block	gray blue
Ground terminal	green-yellow

Cover, width: 2.2 mm	gray
----------------------	------

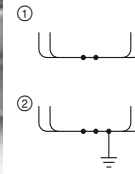

24 A, feed-through terminal block, 4 connections



Technical data ¹⁾				
Width	Length	Height		
5.2	89.5	36.5 (NS 35/7,5)		
I _{max} [A]	U _{max} [V]	max. Ø [mm ²]	AWG (UL)	
24 ²⁾	500	0.08 - 4	-	
24 (FBS) / 17.5 (FBSR)				
IEC	UL / CUL	CSA	Ex	
500	600	600	-	
24 ²⁾ / 2.5				
	20 / -	20 / -	- / -	

Ordering data			
Type	Order No.	Pcs./Pkt.	
ST 2,5-QUATTRO/4P	① 3042159	50	
ST 2,5-QUATTRO/4P BU	① 3042081	50	
ST 2,5-QUATTRO/4P-PE	② 3042162	50	

Accessories ¹⁾			
D-ST 2,5-QUATTRO/4P	Order No.	Pcs./Pkt.	
D-ST 2,5-QUATTRO/4P	3042175	50	

Feed-through, multi-conductor, multi-level, and ground terminal blocks

Notes:
1) For additional accessories and technical data, see page 308.
2) For derating curve, visit phoenixcontact.net/products

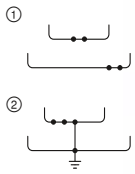

22 A, double-level terminal block



Technical data ¹⁾				
Width	Length	Height		
5.2	98.8	47.5 (NS 35/7,5)		
I _{max} [A]	U _{max} [V]	max. Ø [mm ²]	AWG (UL)	
22 ²⁾	500	0.08 - 4	-	
24 (FBS) / 17.5 (FBSR)				
IEC	UL / CUL	CSA	Ex	
500	600	600	-	
22 ²⁾ / 2.5				
	20 / -	20 / -	- / -	

Ordering data			
Type	Order No.	Pcs./Pkt.	
STTB 2,5/4P	① 3061486	50	
STTB 2,5/4P BU	① 3061512	50	
STTB 2,5/4P-PE	② 3061499	50	

Accessories ¹⁾			
D-STTB 2,5/4P	Order No.	Pcs./Pkt.	
D-STTB 2,5/4P	3061538	50	

Dimensions	[mm]
Maximum electrical data	
Maximum bridge current	[A]
Rated data	
Rated voltage	[V]
Nominal current / cross section	[A] / [mm ²]

Description	Color
Terminal block	gray blue gray
Ground terminal	green-yellow

Cover, width: 2.2 mm	gray
----------------------	------



22 A, double-level terminal block with equipotential bonding



Technical data ¹⁾				
Width	Length	Height		
5.2	98.8	47.5 (NS 35/7,5)		
I _{max} [A]	U _{max} [V]	max. Ø [mm ²]	AWG (UL)	
22 ²⁾	500	0.08 - 4	-	
24 (FBS) / 17.5 (FBSR)				
IEC	UL / CUL	CSA	Ex	
500	600	600	-	
22 ²⁾ / 2.5				
	20 / -	20 / -	- / -	

Ordering data			
Type	Order No.	Pcs./Pkt.	
STTB 2,5/4P-PV	① 3061509	50	

Accessories ¹⁾			
D-STTB 2,5/4P	Order No.	Pcs./Pkt.	
D-STTB 2,5/4P	3061538	50	

Couplings

- For secure and space-saving accommodation of plug contacts in cable ducts and distributor shafts
- Test hole in every receptacle disc, to accommodate a test plug with a 2.3 mm diameter

Notes:
¹⁾ For additional accessories and technical data, see page 308.
²⁾ For derating curve, visit phoenixcontact.net/products



24 A, coupling

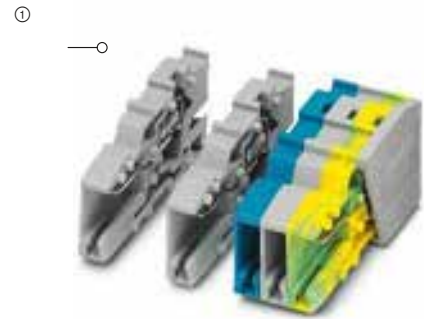

24 A, coupling, for self-assembly



Technical data ¹⁾			
Width	Length	Height	
5.2 x No. of pos.	37.2	18.8	
I _{max.} [A]	U _{max.} [V]	max. Ø [mm ²]	AWG (UL)
24	500	0.08 - 4	28-12
IEC	UL / CUL	CSA	Ex
Rated voltage [V]	500	300	-
Nominal current / cross section [A] / [mm ²]	24 / 2.5	20 / -	- / -

Ordering data			
Description	No. of pos.	Color	Type
COMBI coupling	2	gray	SC 2,5/ 2
	3	gray	SC 2,5/ 3
	4	gray	SC 2,5/ 4
	5	gray	SC 2,5/ 5
	6	gray	SC 2,5/ 6
	7	gray	SC 2,5/ 7
	8	gray	SC 2,5/ 8
	9	gray	SC 2,5/ 9
	10	gray	SC 2,5/10
	11	gray	SC 2,5/11
	12	gray	SC 2,5/12
	13	gray	SC 2,5/13
	14	gray	SC 2,5/14
	15	gray	SC 2,5/15
	COMBI coupling, for self-assembly	1	gray
1		blue	
1		green-yellow	

Accessories ¹⁾		
Accessories	Order No.	Pcs./Pkt.
MPS-MT	0201744	10
MPS-IH RD	0201676	10
PDZ/2	3040562	50
PDZ/4	3040575	50
PC	3040588	50



Technical data ¹⁾			
Width	Length	Height	
5.2 x No. of pos.	37.2	21.8	
I _{max.} [A]	U _{max.} [V]	max. Ø [mm ²]	AWG (UL)
24 ²⁾	500	0.08 - 4	28-12
IEC	UL / CUL	CSA	Ex
Rated voltage [V]	500	300	-
Nominal current / cross section [A] / [mm ²]	24 ²⁾ / 2.5	20 / -	- / -

Ordering data		
Type	Order No.	Pcs./Pkt.
SC 2,5/ 1-L	3042188	50
SC 2,5/ 1-L BU	3042191	50
SC 2,5/ 1-L GN YE	3042201	50

Accessories ¹⁾		
Accessories	Order No.	Pcs./Pkt.
MPS-MT	0201744	10
MPS-IH RD	0201676	10
D-SC 2,5	3042243	50
PDZ/2	3040562	50
PDZ/4	3040575	50
PC	3040588	50

Test plug metal part, 2.3 mm Ø	gray
Insulating sleeve, for MPS metal part	red
Cover, width: 2.2 mm	gray
Strain relief, for SPDB... plug and SC 2,5... receptacle, 2-pos.	black
4-pos.	black
Coding star, with 4 coding branches, can be inserted in all basic terminal blocks	red

Couplings

Notes:
1) For additional accessories and technical data, see page 308.
2) For derating curve, visit phoenixcontact.net/products



24 A, coupling with securing pin

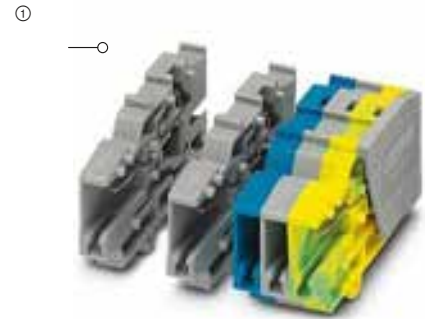

24 A, coupling with securing pin, for self-assembly



Technical data ¹⁾			
Width	Length	Height	
5.2 x No. of pos.	37.2	21.8	
I_{max.} [A]	U_{max.} [V]	max. Ø [mm²]	AWG (UL)
24	500	0.08 - 4	28-12
IEC	UL / CUL	CSA	Ex
Rated voltage [V]	500	300	-
Nominal current / cross section [A] / [mm ²]	24 / 2.5	20 / -	- / -

Ordering data					
Description	No. of pos.	Color	Type	Order No.	Pcs./Pkt.
COMBI coupling, with securing pin	2	gray	SC 2,5-RZ/ 2	3041516	50
	3	gray	SC 2,5-RZ/ 3	3041529	50
	4	gray	SC 2,5-RZ/ 4	3041532	50
	5	gray	SC 2,5-RZ/ 5	3041545	50
	6	gray	SC 2,5-RZ/ 6	3041558	25
	7	gray	SC 2,5-RZ/ 7	3041561	25
	8	gray	SC 2,5-RZ/ 8	3041574	25
	9	gray	SC 2,5-RZ/ 9	3041590	25
	10	gray	SC 2,5-RZ/10	3041587	25
	11	gray	SC 2,5-RZ/11	3041600	10
	12	gray	SC 2,5-RZ/12	3041613	10
	13	gray	SC 2,5-RZ/13	3041626	10
	14	gray	SC 2,5-RZ/14	3041639	10
	15	gray	SC 2,5-RZ/15	3041642	10
	COMBI coupling, with securing pin, for self-assembly				
	1	blue			
	1	green-yellow			

Accessories ¹⁾		
MPS-MT	0201744	10
MPS-IH RD	0201676	10
PDZ/2	3040562	50
PDZ/4	3040575	50
PC	3040588	50



Technical data ¹⁾			
Width	Length	Height	
5.2 x No. of pos.	37.2	21.8	
I_{max.} [A]	U_{max.} [V]	max. Ø [mm²]	AWG (UL)
24 ²⁾	500	0.08 - 4	28-12
IEC	UL / CUL	CSA	Ex
Rated voltage [V]	500	300	-
Nominal current / cross section [A] / [mm ²]	24 ²⁾ / 2.5	20 / -	- / -

Ordering data		
Type	Order No.	Pcs./Pkt.
SC 2,5-RZ/ 1-L	3042214	50
SC 2,5-RZ/ 1-L BU	3042227	50
SC 2,5-RZ/ 1-L GNYE	3042230	50

Accessories ¹⁾		
MPS-MT	0201744	10
MPS-IH RD	0201676	10
D-SC 2,5	3042243	50
PDZ/2	3040562	50
PDZ/4	3040575	50
PC	3040588	50

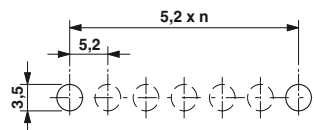

Drilling plan example: 1 x SC 2,5-RZ/ 6

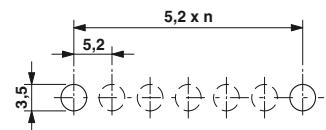

Drilling plan example: 6 x SC 2,5-RZ/ 1-L

Panel feed-through for COMBI couplings

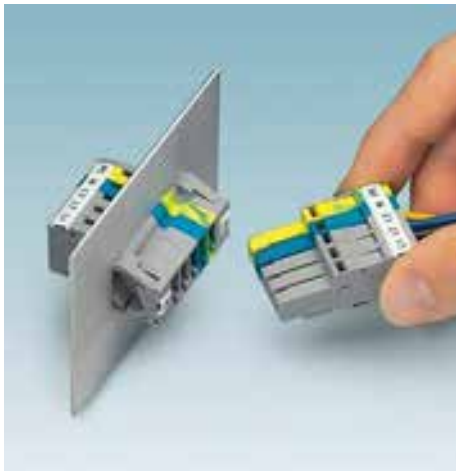

Snap receptacle onto panel feed-through SSL 2,5



Panel feed-through

- The panel feed-through can be used to securely fasten free-hanging receptacles SC 2,5 and SC 4 in panel cutouts
- The panel feed-through elements are snapped onto the free-hanging receptacles, and pushed into the panel cutout where they snap in automatically
- The receptacle is finally fixed in place by pressing shut the panel feed-through's actuation lever
- Can be used for plate thicknesses of 0.8 mm to 3 mm

Making the panel cutout

- The panel cutout is easy to produce. The height of the rectangular cutout is always the same, and the length depends on the number of positions of the receptacle. There is no longer any need for additional bore holes for fixing screws as in previously common solutions

General data	
Plate thickness	[mm] 0.8 - 3
Section height	[mm] 16.6
Section width	[mm] 5.15 x number of positions + 13 (SC 2,5) 6.15 x number of positions + 14 (SC 4)
Insulating material	PA
Flammability rating in accordance with UL 94	V0

Description	Color
Panel feed-through, for snapping on to receptacles, 1 SSL 2.5 consists of a left-hand and a right-hand element, for metal thicknesses of 0.8 - 3 mm	gray

Coding star, with 4 coding branches, can be inserted in all basic terminal blocks	red
Screwdriver	

Lateral groove labeling	
-------------------------	--

ERIC

Technical data		
----------------	--	--

Plate thickness	[mm] 0.8 - 3
Section height	[mm] 16.6
Section width	[mm] 5.15 x number of positions + 13 (SC 2,5) 6.15 x number of positions + 14 (SC 4)
Insulating material	PA
Flammability rating in accordance with UL 94	V0

Ordering data		
---------------	--	--

Type	Order No.	Pcs./Pkt.
SSL 2,5	3043815	50

Accessories		
-------------	--	--

PC	3040588	50
SZF 1-0,6X3,5	1204517	10
UC-TMF 5, UCT-TMF 5 or ZBF 5 (see Catalog 3)		



Fit the receptacle and SSL 2.5 in panel cutout



Fixing the receptacle

Terminal blocks – CLIPLINE complete

2.5 mm² COMBI ST plug-in connection solutions

Couplings

– The terminal blocks are snapped onto the free-hanging receptacles SC... as modules and can be used on the NS 15 as well as on the NS 35 DIN rail

Notes:
1) For additional accessories and technical data, see page 308.
2) For derating curve, visit phoenixcontact.net/products

①



24 A, coupling for DIN rail mounting



Dimensions	
	[mm]
Maximum electrical data	
Rated data	
Rated voltage	[V]
Nominal current / cross section	[A] / [mm ²]

Description	Color
COMBI coupling	gray

Cover, width: 2.2 mm	gray
Strain relief, for SPDB... plug and SC 2,5... receptacle, 2-pos.	black
4-pos.	black
Coding star, with 4 coding branches, can be inserted in all basic terminal blocks	red

Technical data ¹⁾			
Width	Length	Height	
5.2	43.5	34 (NS 35/7,5) / 34 (NS 15)	
I _{max.} [A]	U _{max.} [V]	max. Ø [mm ²]	AWG (UL)
24 ²⁾	500	0.08 - 4	28-12
IEC	UL / CUL	CSA	Ex
500	300	-	-
24 ²⁾ / 2.5	20 / -	- / -	- / -

Ordering data		
Type	Order No.	Pcs./Pkt.
SC 2,5-NS/ 1-L	3042340	50

Accessories ¹⁾		
Type	Order No.	Pcs./Pkt.
D-SC 2,5	3042243	50
PDZ/2	3040562	50
PDZ/4	3040575	50
PC	3040588	50

COMBI headers for PCB connection



24 A, header, horizontal plug-in direction

24 A, header, vertical plug-in direction

Notes:
For additional accessories and technical data, see page 364 or visit phoenixcontact.net/products



Technical data				
Width	Length	Height		
10.4	21.7	18.1		
I _{max.} [A]	max. Ø [mm ²]		AWG (UL)	
24	-		-	
IEC	UL	CSA	IEC/EN 60079-7	
-	300	-	-	
Nominal current / cross section	[A] / [mm ²]	24 / 2.5	15 / -	-
Rated cross section	[mm ²]	2.5	-	-
General data				
Insulating material		PA		
Flammability rating in accordance with UL 94		V0		



Technical data				
Width	Length	Height		
12.5	18.05	21.7		
I _{max.} [A]	max. Ø [mm ²]		AWG (UL)	
24	-		-	
IEC	UL	CSA	IEC/EN 60079-7	
-	300	-	-	
Nominal current / cross section	[A] / [mm ²]	24 / 2.5	15 / -	-
Rated cross section	[mm ²]	2.5	-	-
General data				
Insulating material		PA		
Flammability rating in accordance with UL 94		V0		

Ordering data

Description	No. of pos.	Width	Color	Type	Order No.	Pcs./Pkt.
COMBI header	2	10.4 mm	gray	ST 2,5-PCB/ 2-G-5,2	1980378	50
	3	15.6 mm	gray	ST 2,5-PCB/ 3-G-5,2	1980381	50
	4	20.8 mm	gray	ST 2,5-PCB/ 4-G-5,2	1980394	50
	5	26 mm	gray	ST 2,5-PCB/ 5-G-5,2	1980404	50
	6	31.2 mm	gray	ST 2,5-PCB/ 6-G-5,2	1980417	50
	7	36.4 mm	gray	ST 2,5-PCB/ 7-G-5,2	1980420	50
	8	41.6 mm	gray	ST 2,5-PCB/ 8-G-5,2	1980433	50
	9	46.8 mm	gray	ST 2,5-PCB/ 9-G-5,2	1980446	50
	10	52 mm	gray	ST 2,5-PCB/10-G-5,2	1980459	50
	11	57.2 mm	gray	ST 2,5-PCB/11-G-5,2	1980462	50
	12	62.4 mm	gray	ST 2,5-PCB/12-G-5,2	1980475	50

Ordering data

Description	No. of pos.	Width	Color	Type	Order No.	Pcs./Pkt.
COMBI header	2	12.5 mm	gray	ST 2,5-PCBV/ 2-G-5,2	1980488	50
	3	17.7 mm	gray	ST 2,5-PCBV/ 3-G-5,2	1980491	50
	4	22.9 mm	gray	ST 2,5-PCBV/ 4-G-5,2	1980501	50
	5	28.1 mm	gray	ST 2,5-PCBV/ 5-G-5,2	1980514	50
	6	33.3 mm	gray	ST 2,5-PCBV/ 6-G-5,2	1980527	50
	7	38.5 mm	gray	ST 2,5-PCBV/ 7-G-5,2	1980530	50
	8	43.7 mm	gray	ST 2,5-PCBV/ 8-G-5,2	1980543	50
	9	48.9 mm	gray	ST 2,5-PCBV/ 9-G-5,2	1980556	50
	10	54.1 mm	gray	ST 2,5-PCBV/10-G-5,2	1980569	50
	11	59.3 mm	gray	ST 2,5-PCBV/11-G-5,2	1980572	50
	12	64.5 mm	gray	ST 2,5-PCBV/12-G-5,2	1980585	50

Terminal blocks – CLIPLINE complete

2.5 mm² COMBI ST plug-in connection solutions

COMBI connectors

Notes:
1) For additional accessories and technical data, see page 308.
2) For derating curve, visit phoenixcontact.net/products

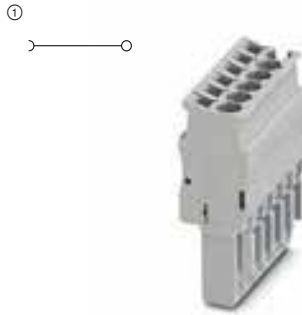

24 A, connector, connection in plug-in direction

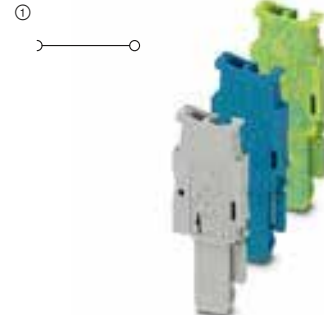

24 A, connector, connection in plug-in direction, for self-assembly



Dimensions	Technical data ¹⁾			
	Width [mm]	Length	Height	Height plugged
	5.2 x No. of pos.	15.8	39	24
Maximum electrical data	I_{max} [A]	U_{max} [V]	max. Ø [mm ²]	AWG (UL)
	24	500	0.08 - 4	26-12
Rated data	IEC	UL / CUL	CSA	Ex
Rated voltage [V]	500	600	600	-
Nominal current / cross section [A] / [mm ²]	24 / 2.5	20 / -	20 / -	- / -

Dimensions	Technical data ¹⁾			
	Width [mm]	Length	Height	Height plugged
	5.2 x No. of pos.	15.8	39	24
Maximum electrical data	I_{max} [A]	U_{max} [V]	max. Ø [mm ²]	AWG (UL)
	24 ²⁾	500	0.08 - 4	26-12
Rated data	IEC	UL / CUL	CSA	Ex
Rated voltage [V]	500	600	600	-
Nominal current / cross section [A] / [mm ²]	24 ²⁾ / 2.5	20 / -	20 / -	- / -

Description	No. of pos.	Width	Color	Ordering data		
				Type	Order No.	Pcs./Pkt.
COMBI connectors	1	5.2 mm	gray	SP 2,5/ 1	① 3040258	50
	2	10.4 mm	gray	SP 2,5/ 2	① 3040261	50
	3	15.6 mm	gray	SP 2,5/ 3	① 3040274	50
	4	20.8 mm	gray	SP 2,5/ 4	① 3040287	50
	5	26 mm	gray	SP 2,5/ 5	① 3040290	50
	6	31.2 mm	gray	SP 2,5/ 6	① 3040300	25
	7	36.4 mm	gray	SP 2,5/ 7	① 3040313	25
	8	41.6 mm	gray	SP 2,5/ 8	① 3040326	25
	9	46.8 mm	gray	SP 2,5/ 9	① 3040339	25
	10	52 mm	gray	SP 2,5/10	① 3040342	25
	11	57.2 mm	gray	SP 2,5/11	① 3040355	10
	12	62.4 mm	gray	SP 2,5/12	① 3040368	10
	13	67.6 mm	gray	SP 2,5/13	① 3040371	10
	14	72.8 mm	gray	SP 2,5/14	① 3040384	10
	15	78 mm	gray	SP 2,5/15	① 3040397	10
COMBI connector, left element	1	5.2 mm	blue	SP 2,5/ 1 BU	① 3040698	50
	1	5.2 mm	green-yellow	SP 2,5/ 1 GNYE	① 3040708	50

Description	No. of pos.	Width	Color	Ordering data			
				Type	Order No.	Pcs./Pkt.	
COMBI connector, center element	1	5.2 mm	gray	SP 2,5/ 1-L	① 3043019	50	
	1	5.2 mm	blue	SP 2,5/ 1-L BU	① 3043022	50	
	1	5.2 mm	green-yellow	SP 2,5/ 1-L GNYE	① 3043035	50	
	1	5.2 mm	gray	SP 2,5/ 1-M	① 3043043	50	
	1	5.2 mm	blue	SP 2,5/ 1-M BU	① 3043051	50	
	1	5.2 mm	green-yellow	SP 2,5/ 1-M GNYE	① 3043064	50	
	COMBI connector, right element	1	5.2 mm	gray	SP 2,5/ 1-R	① 3043077	50
		1	5.2 mm	blue	SP 2,5/ 1-R BU	① 3043080	50
		1	5.2 mm	green-yellow	SP 2,5/ 1-R GNYE	① 3043093	50

Accessories ¹⁾	Ordering data		
	Type	Order No.	Pcs./Pkt.
Latching and strain relief systems, for all plugs with conductor exit at top, 2-pos.	PRZ	3040614	50
	PR	3040559	50
	PR/2	3040630	50
	PZ/2	3040627	50
Latching, for connectors, 1-pos.	PRZ	3040614	50
	PR	3040559	50
Strain relief, for plugs, 2-pos.	PZ/2	3040627	50
	PZ/4	3040643	50

Accessories ¹⁾	Ordering data		
	Type	Order No.	Pcs./Pkt.
Latching and strain relief systems, for all plugs with conductor exit at top, 2-pos.	PRZ	3040614	50
	PR	3040559	50
	PR/2	3040630	50
	PZ/2	3040627	50
Latching, for connectors, 1-pos.	PRZ	3040614	50
	PR	3040559	50
Strain relief, for plugs, 2-pos.	PZ/2	3040627	50
	PZ/4	3040643	50

COMBI connectors

Notes:
1) For additional accessories and technical data, see page 308.
2) For derating curve, visit phoenixcontact.net/products



24 A, connector, connection in plug-in direction, cable housing can be snapped on

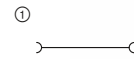

24 A, connector, connection in plug-in direction, for self-assembly, cable housing can be snapped on



Technical data ¹⁾				
Width	Length	Height	Height plugged	
5.2 x No. of pos.	15.8	39	24	
I _{max.} [A]	U _{max.} [V]	max. Ø [mm ²]	AWG (UL)	
24 ²⁾	500	0.08 - 4	26-12	
IEC	UL / CUL	CSA	Ex	
Rated voltage	300	300	-	
Nominal current / cross section	20 / -	20 / -	- / -	

Technical data ¹⁾				
Width	Length	Height	Height plugged	
5.2 x No. of pos.	15.8	39	24	
I _{max.} [A]	U _{max.} [V]	max. Ø [mm ²]	AWG (UL)	
24 ²⁾	500	0.08 - 4	26-12	
IEC	UL / CUL	CSA	Ex	
Rated voltage	300	300	-	
Nominal current / cross section	20 / -	20 / -	- / -	

Ordering data

Ordering data

Description	No. of pos.	Width	Color
COMBI connectors	1	5.2 mm	gray
	2	10.4 mm	gray
	3	15.6 mm	gray
	4	20.8 mm	gray
	5	26 mm	gray
	6	31.2 mm	gray
	7	36.4 mm	gray
	8	41.6 mm	gray
	9	46.8 mm	gray
	10	52 mm	gray
	11	57.2 mm	gray
	12	62.4 mm	gray
	13	67.6 mm	gray
	14	72.8 mm	gray
	15	78 mm	gray
COMBI connector, left element	1	5.2 mm	blue
	1	5.2 mm	green-yellow
COMBI connector, center element	1	5.2 mm	gray
	1	5.2 mm	blue
COMBI connector, right element	1	5.2 mm	gray
	1	5.2 mm	blue
	1	5.2 mm	green-yellow

Type	Order No.	Pcs./Pkt.
SP-H 2,5/ 1	3210619	50
SP-H 2,5/ 2	3210622	50
SP-H 2,5/ 3	3210635	50
SP-H 2,5/ 4	3210648	50
SP-H 2,5/ 5	3210651	50
SP-H 2,5/ 6	3210664	25
SP-H 2,5/ 7	3210677	25
SP-H 2,5/ 8	3210680	25
SP-H 2,5/ 9	3210693	25
SP-H 2,5/10	3210703	25
SP-H 2,5/11	3210716	10
SP-H 2,5/12	3210729	10
SP-H 2,5/13	3210732	10
SP-H 2,5/14	3210745	10
SP-H 2,5/15	3210758	10
SP-H 2,5/ 1 BU	3210761	50
SP-H 2,5/ 1 GNYE	3210774	50

Type	Order No.	Pcs./Pkt.
SP-H 2,5/ 1-L	3210787	50
SP-H 2,5/ 1-L BU	3210790	50
SP-H 2,5/ 1-L GNYE	3210800	50
SP-H 2,5/ 1-M	3210813	50
SP-H 2,5/ 1-M BU	3210826	50
SP-H 2,5/ 1-M GNYE	3210839	50
SP-H 2,5/ 1-R	3210842	50
SP-H 2,5/ 1-R BU	3210855	50
SP-H 2,5/ 1-R GNYE	3210868	50

Accessories¹⁾

Accessories¹⁾

Test plug metal part, 2.3 mm Ø	gray
Insulating sleeve, for MPS metal part	red
Latching and strain relief systems, for all plugs with conductor exit at top, 2-pos.	orange
Latching, for connectors, 1-pos.	orange
2-pos.	orange
Strain relief, for plugs, 2-pos.	black
4-pos.	black
Screw flange cover, for SP-H ... and PP 2,5..., PP-H ...COMBI connectors	gray
Cable housing, for COMBI plugs SP-H ... and PP-H ..., 2-pos.	gray
3-pos.	gray
4-pos.	gray
5-pos.	gray
6-pos.	gray
7-pos.	gray
8-pos.	gray
9-pos.	gray

Type	Order No.	Pcs./Pkt.
MPS-MT	0201744	10
MPS-IH RD	0201676	10
PRZ	3040614	50
PR	3040559	50
PR/2	3040630	50
PZ/2	3040627	50
PZ/4	3040643	50
DF-SP-H 2,5	3209824	50
PH 2,5/ 2	3209691	50
PH 2,5/ 3	3209701	50
PH 2,5/ 4	3209714	50
PH 2,5/ 5	3209727	50
PH 2,5/ 6	3209730	25
PH 2,5/ 7	3209743	25
PH 2,5/ 8	3209756	25
PH 2,5/ 9	3209507	25

Type	Order No.	Pcs./Pkt.
MPS-MT	0201744	10
MPS-IH RD	0201676	10
PRZ	3040614	50
PR	3040559	50
PR/2	3040630	50
PZ/2	3040627	50
PZ/4	3040643	50
DF-SP-H 2,5	3209824	50
PH 2,5/ 2	3209691	50
PH 2,5/ 3	3209701	50
PH 2,5/ 4	3209714	50
PH 2,5/ 5	3209727	50
PH 2,5/ 6	3209730	25
PH 2,5/ 7	3209743	25
PH 2,5/ 8	3209756	25
PH 2,5/ 9	3209507	25

Terminal blocks – CLIPLINE complete

2.5 mm² COMBI ST plug-in connection solutions

COMBI connectors

Notes:
1) For additional accessories and technical data, see page 308.
2) For derating curve, visit phoenixcontact.net/products

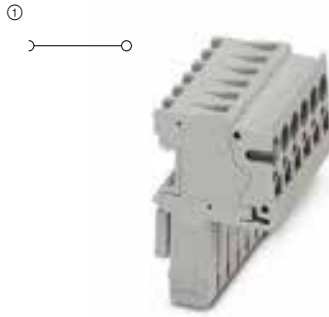

24 A, connector, connection at a right angle to the plug-in direction

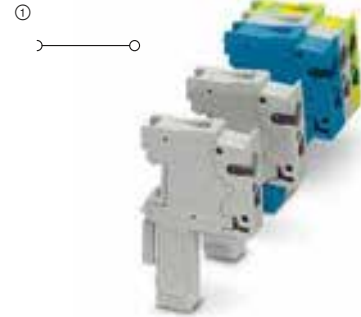

24 A, connector, connection at a right angle to the plug-in direction, for self-assembly



Dimensions	Technical data ¹⁾			
	Width [mm]	Length [mm]	Height [mm]	Height plugged [mm]
5.2 x No. of pos.	23.4	34	19	
Maximum electrical data	$I_{max.}$ [A]	$U_{max.}$ [V]	max. Ø [mm ²]	AWG (UL)
	24	500	0.08 - 4	26-12
	IEC	UL / CUL	CSA	Ex
Rated data	Rated voltage [V]			
	500	600	-	-
Nominal current / cross section	[A] / [mm ²]	24 / 2.5	20 / -	- / -

Dimensions	Technical data ¹⁾			
	Width [mm]	Length [mm]	Height [mm]	Height plugged [mm]
5.2 x No. of pos.	23.4	34	19	
Maximum electrical data	$I_{max.}$ [A]	$U_{max.}$ [V]	max. Ø [mm ²]	AWG (UL)
	24 ²⁾	500	0.08 - 4	26-12
	IEC	UL / CUL	CSA	Ex
Rated data	Rated voltage [V]			
	500	600	-	-
Nominal current / cross section	[A] / [mm ²]	24 ²⁾ / 2.5	20 / -	- / -

Ordering data				Ordering data		
Description	No. of pos.	Width	Color	Type	Order No.	Pcs./Pkt.
COMBI connectors	1	5.2 mm	gray	SPV 2,5/ 1	① 3041710	50
	2	10.4 mm	gray	SPV 2,5/ 2	① 3041723	50
	3	15.6 mm	gray	SPV 2,5/ 3	① 3041736	50
	4	20.8 mm	gray	SPV 2,5/ 4	① 3041749	50
	5	26 mm	gray	SPV 2,5/ 5	① 3041752	50
	6	31.2 mm	gray	SPV 2,5/ 6	① 3041765	25
	7	36.4 mm	gray	SPV 2,5/ 7	① 3041778	25
	8	41.6 mm	gray	SPV 2,5/ 8	① 3041781	25
	9	46.8 mm	gray	SPV 2,5/ 9	① 3041794	25
	10	52 mm	gray	SPV 2,5/10	① 3041804	25
	11	57.2 mm	gray	SPV 2,5/11	① 3041817	10
	12	62.4 mm	gray	SPV 2,5/12	① 3041820	10
	13	67.6 mm	gray	SPV 2,5/13	① 3041833	10
	14	72.8 mm	gray	SPV 2,5/14	① 3041846	10
	15	78 mm	gray	SPV 2,5/15	① 3041859	10
COMBI connector, left element	1	5.2 mm	blue	SPV 2,5/ 1 BU	① 3061017	50
	1	5.2 mm	green-yellow	SPV 2,5/ 1 GNYE	① 3061020	50
COMBI connector, center element	1	5.2 mm	gray			
	1	5.2 mm	blue			
COMBI connector, right element	1	5.2 mm	green-yellow			
	1	5.2 mm	gray			

Ordering data			Ordering data		
Type	Order No.	Pcs./Pkt.	Type	Order No.	Pcs./Pkt.
SPV 2,5/ 1-L	① 3041024	50	SPV 2,5/ 1-L BU	① 3041037	50
SPV 2,5/ 1-L BU	① 3041037	50	SPV 2,5/ 1-L GNYE	① 3041040	50
SPV 2,5/ 1-L GNYE	① 3041040	50	SPV 2,5/ 1-M	① 3041053	50
SPV 2,5/ 1-M	① 3041053	50	SPV 2,5/ 1-M BU	① 3041066	50
SPV 2,5/ 1-M BU	① 3041066	50	SPV 2,5/ 1-M GNYE	① 3041079	50
SPV 2,5/ 1-M GNYE	① 3041079	50	SPV 2,5/ 1-R	① 3041082	50
SPV 2,5/ 1-R	① 3041082	50	SPV 2,5/ 1-R BU	① 3041095	50
SPV 2,5/ 1-R BU	① 3041095	50	SPV 2,5/ 1-R GNYE	① 3041105	50
SPV 2,5/ 1-R GNYE	① 3041105	50			

Accessories ¹⁾			Accessories ¹⁾				
Description	Color	Order No.	Pcs./Pkt.	Description	Color	Order No.	Pcs./Pkt.
Test plug metal part, 2.3 mm Ø	gray	MPS-MT	0201744	10	MPS-MT	0201744	10
Insulating sleeve, for MPS metal part	red	MPS-IH RD	0201676	10	MPS-IH RD	0201676	10
Snap-on, for SPV plugs, 2-pos.	orange	PRV/2	3041862	50	PRV/2	3041862	50
Strain relief, for plugs, 2-pos. 4-pos.	black	PZ/2	3040627	50	PZ/2	3040627	50
	black	PZ/4	3040643	50	PZ/4	3040643	50

Accessories ¹⁾			Accessories ¹⁾				
Description	Color	Order No.	Pcs./Pkt.	Description	Color	Order No.	Pcs./Pkt.
Test plug metal part, 2.3 mm Ø	gray	MPS-MT	0201744	10	MPS-MT	0201744	10
Insulating sleeve, for MPS metal part	red	MPS-IH RD	0201676	10	MPS-IH RD	0201676	10
Snap-on, for SPV plugs, 2-pos.	orange	PRV/2	3041862	50	PRV/2	3041862	50
Strain relief, for plugs, 2-pos. 4-pos.	black	PZ/2	3040627	50	PZ/2	3040627	50
	black	PZ/4	3040643	50	PZ/4	3040643	50

COMBI connectors

Notes:
1) For additional accessories and technical data, see page 308.
2) For derating curve, visit phoenixcontact.net/products



24 A, connector, connection in plug-in direction

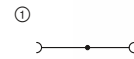

24 A, connector, connection in plug-in direction, for self-assembly



Technical data ¹⁾				
Dimensions	Width [mm]	Length	Height	Height plugged
	5.2 x No. of pos.	20	39	24
Maximum electrical data	I _{max.} [A]	U _{max.} [V]	max. Ø [mm ²]	AWG (UL)
	24	500	0.08 - 4	26-12
	24 (FBS) / 17.5 (FBSR)			
Rated data	IEC	UL / CUL	CSA	Ex
Maximum bridge current [A]	500	600	600	-
Rated voltage [V]	24 / 2.5	20 / -	20 / -	- / -
Nominal current / cross section [A] / [mm ²]				

Technical data ¹⁾				
Dimensions	Width [mm]	Length	Height	Height plugged
	5.2 x No. of pos.	20	39	24
Maximum electrical data	I _{max.} [A]	U _{max.} [V]	max. Ø [mm ²]	AWG (UL)
	24 ²⁾	500	0.08 - 4	26-12
	24 (FBS) / 17.5 (FBSR)			
Rated data	IEC	UL / CUL	CSA	Ex
Maximum bridge current [A]	500	600	600	-
Rated voltage [V]	24 ²⁾ / 2.5	20 / -	20 / -	- / -
Nominal current / cross section [A] / [mm ²]				

Ordering data

Ordering data

Description	No. of pos.	Width	Color
COMBI connectors	1	5.2 mm	gray
	2	10.4 mm	gray
	3	15.6 mm	gray
	4	20.8 mm	gray
	5	26 mm	gray
	6	31.2 mm	gray
	7	36.4 mm	gray
	8	41.6 mm	gray
	9	46.8 mm	gray
	10	52 mm	gray
	11	57.2 mm	gray
	12	62.4 mm	gray
	13	67.6 mm	gray
	14	72.8 mm	gray
	15	78 mm	gray
COMBI connector, left element	1	5.2 mm	blue
	1	5.2 mm	green-yellow
COMBI connector, center element	1	5.2 mm	gray
	1	5.2 mm	blue
COMBI connector, right element	1	5.2 mm	green-yellow
	1	5.2 mm	gray
	1	5.2 mm	blue
	1	5.2 mm	green-yellow

Type	Order No.	Pcs./Pkt.
SPB 2,5/ 1	3040106	50
SPB 2,5/ 2	3040119	50
SPB 2,5/ 3	3040122	50
SPB 2,5/ 4	3040135	50
SPB 2,5/ 5	3040143	50
SPB 2,5/ 6	3040151	25
SPB 2,5/ 7	3040164	25
SPB 2,5/ 8	3040177	25
SPB 2,5/ 9	3040180	25
SPB 2,5/10	3040193	25
SPB 2,5/11	3040203	10
SPB 2,5/12	3040216	10
SPB 2,5/13	3040229	10
SPB 2,5/14	3040232	10
SPB 2,5/15	3040245	10
SPB 2,5/ 1 BU	3040724	50
SPB 2,5/ 1 GNYE	3040711	50

Type	Order No.	Pcs./Pkt.
SPB 2,5/ 1-L	3043103	50
SPB 2,5/ 1-L BU	3043116	50
SPB 2,5/ 1-L GNYE	3043129	50
SPB 2,5/ 1-M	3043132	50
SPB 2,5/ 1-M BU	3043145	50
SPB 2,5/ 1-M GNYE	3043158	50
SPB 2,5/ 1-R	3043161	50
SPB 2,5/ 1-R BU	3043174	50
SPB 2,5/ 1-R GNYE	3043187	50

Accessories¹⁾

Accessories¹⁾

Latching and strain relief systems, for all plugs with conductor exit at top, 2-pos.	orange
Latching, for connectors, 1-pos. 2-pos.	orange
Strain relief, for plugs, 2-pos. 4-pos.	black

Accessories ¹⁾	Order No.	Pcs./Pkt.
PRZ	3040614	50
PR	3040559	50
PR/2	3040630	50
PZ/2	3040627	50
PZ/4	3040643	50

Accessories ¹⁾	Order No.	Pcs./Pkt.
PRZ	3040614	50
PR	3040559	50
PR/2	3040630	50
PZ/2	3040627	50
PZ/4	3040643	50

Terminal blocks – CLIPLINE complete

2.5 mm² COMBI ST plug-in connection solutions

COMBI connectors

Notes:
1) For additional accessories and technical data, see page 308.
2) For derating curve, visit phoenixcontact.net/products

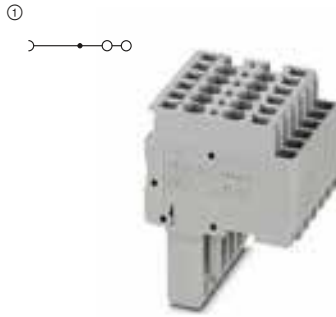

24 A, connector, two connections in plug-in direction

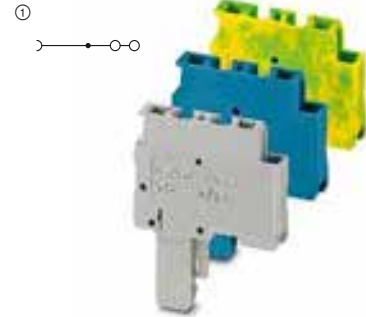

24 A, connector, two connections in plug-in direction, for self-assembly



Dimensions	
Width	[mm]
Maximum electrical data	
Maximum bridge current	[A]
Rated data	
Rated voltage	[V]
Nominal current / cross section	[A] / [mm ²]

Technical data ¹⁾			
Width	Length	Height	Height plugged
5.2 x No. of pos.	32.7	39	24
I_{max} [A]	U_{max} [V]	max. Ø [mm ²]	AWG (UL)
24	500	0.08 - 4	26-12
24 (FBS) / 17.5 (FBSR)			
IEC	UL / CUL	CSA	Ex
500	600	600	-
24 / 2.5	20 / -	20 / -	- / -

Technical data ¹⁾			
Width	Length	Height	Height plugged
5.2 x No. of pos.	32.7	39	24
I_{max} [A]	U_{max} [V]	max. Ø [mm ²]	AWG (UL)
24 ²⁾	500	0.08 - 4	26-12
24 (FBS) / 17.5 (FBSR)			
IEC	UL / CUL	CSA	Ex
500	600	600	-
24 ²⁾ / 2.5	20 / -	20 / -	- / -

Description	No. of pos.	Width	Color
COMBI connectors	1	5.2 mm	gray
	2	10.4 mm	gray
	3	15.6 mm	gray
	4	20.8 mm	gray
	5	26 mm	gray
	6	31.2 mm	gray
	7	36.4 mm	gray
	8	41.6 mm	gray
	9	46.8 mm	gray
	10	52 mm	gray
	11	57.2 mm	gray
	12	62.4 mm	gray
	13	67.6 mm	gray
	14	72.8 mm	gray
	15	78 mm	gray
COMBI connector, left element	1	5.2 mm	blue
	1	5.2 mm	green-yellow
COMBI connector, center element	1	5.2 mm	gray
	1	5.2 mm	blue
COMBI connector, right element	1	5.2 mm	green-yellow
	1	5.2 mm	gray
	1	5.2 mm	blue
	1	5.2 mm	green-yellow

Ordering data		
Type	Order No.	Pcs./Pkt.
SPDB 2,5/ 1	3040407	50
SPDB 2,5/ 2	3040410	50
SPDB 2,5/ 3	3040423	50
SPDB 2,5/ 4	3040436	50
SPDB 2,5/ 5	3040449	50
SPDB 2,5/ 6	3040452	25
SPDB 2,5/ 7	3040465	25
SPDB 2,5/ 8	3040478	25
SPDB 2,5/ 9	3040481	25
SPDB 2,5/10	3040494	25
SPDB 2,5/11	3040504	10
SPDB 2,5/12	3040517	10
SPDB 2,5/13	3040520	10
SPDB 2,5/14	3040533	10
SPDB 2,5/15	3040546	10
SPDB 2,5/ 1 BU	3040737	50
SPDB 2,5/ 1 GNYE	3040740	50

Ordering data		
Type	Order No.	Pcs./Pkt.
SPDB 2,5/ 1-L	3043190	50
SPDB 2,5/ 1-L BU	3043200	50
SPDB 2,5/ 1-L GNYE	3043213	50
SPDB 2,5/ 1-M	3043226	50
SPDB 2,5/ 1-M BU	3043239	50
SPDB 2,5/ 1-M GNYE	3043242	50
SPDB 2,5/ 1-R	3043255	50
SPDB 2,5/ 1-R BU	3043268	50
SPDB 2,5/ 1-R GNYE	3043271	50

Accessories ¹⁾	
Latching and strain relief systems, for all plugs with conductor exit at top, 2-pos.	orange
Latching, for connectors, 1-pos. 2-pos.	orange
Strain relief, for SPDB... plug and SC 2,5... receptacle, 2-pos. 4-pos.	black

Accessories ¹⁾		
PRZ	3040614	50
PR	3040559	50
PR/2	3040630	50
PDZ/2	3040562	50
PDZ/4	3040575	50

Accessories ¹⁾		
PRZ	3040614	50
PR	3040559	50
PR/2	3040630	50
PDZ/2	3040562	50
PDZ/4	3040575	50

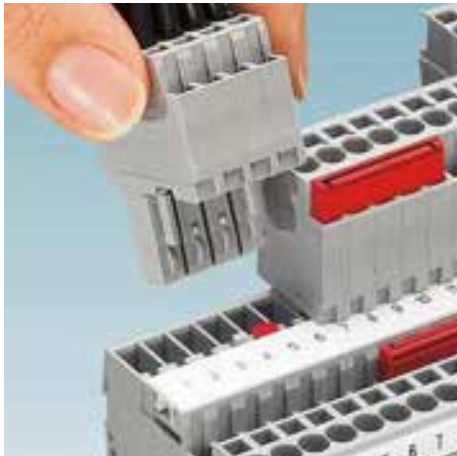
COMBI connectors with spring-cage connection

- Connector with scope for bridging, for use with basic terminal blocks
- The SPB 2,5/... connector is designed for connecting one conductor and also provides an additional bridging facility
- The SPDB 2,5/... connector is designed for connecting two conductors and also provides an additional bridging facility
- The CES cable entry system (see Catalog 2) enables the easy and space-saving installation of pre-assembled cables with IP54/IP65 protection in the control cabinet, see figure below

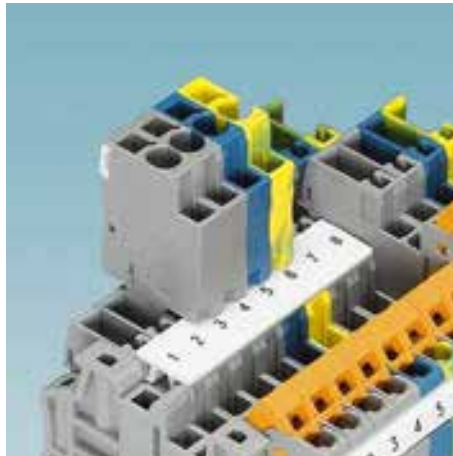
COMBI connectors with spring-cage connection for self-assembly

- The ST-COMBI connectors for self-assembly provide solutions that users can implement themselves
- Cable housings can be snapped onto the SP-H ... connectors
- The plug with spring-cage connection is assembled directly on site by snapping together single-position connector elements. See below for an example of how these go together

- ① SP 2,5/1-L
- ② SP 2,5/1-M and SP 2,5/1-M BU
- ③ SP 2,5/1-R GNYE



Terminal blocks – CLIPLINE complete

4 mm² COMBI PT plug-in connection solutions

General technical data

Rated data		IEC 61984			
Rated cross section	[mm ²]	4			
Cross section range	AWG	24 - 10			
Connection capacity		Rigid	Flexible	Ferrule without/with plastic sleeve	
1 conductor	[mm ²]	0.2 - 6	0.2 - 4	0.25 - 4	0.25 - 4
2 flexible conductors with a TWIN ferrule	[mm ²]	-	-	-	0.5 - 1
Connection cross sections directly plug-in	[mm ²]	0.5 - 6	-	0.5 - 4	0.5 - 4
General data					
Stripping length	[mm]	10 - 12			
Insulating material		PA			
Flammability rating in accordance with UL 94		V0			

Note: Additional or deviating data is listed alongside the respective product.

Notes:



In addition to the product, the internal electrical wiring is provided as a circuit diagram. Free connection points for bridging are indicated by a black dot.

The specified technical data and approvals refer to the first product in each column. For information on the products below, please refer to phoenixcontact.net/products

For full details of UL and CSA use groups, file nos., and Internet links, please visit phoenixcontact.net/products

¹⁾ The bridge current is listed alongside the respective product. For additional colors, see page 402.

System accessories

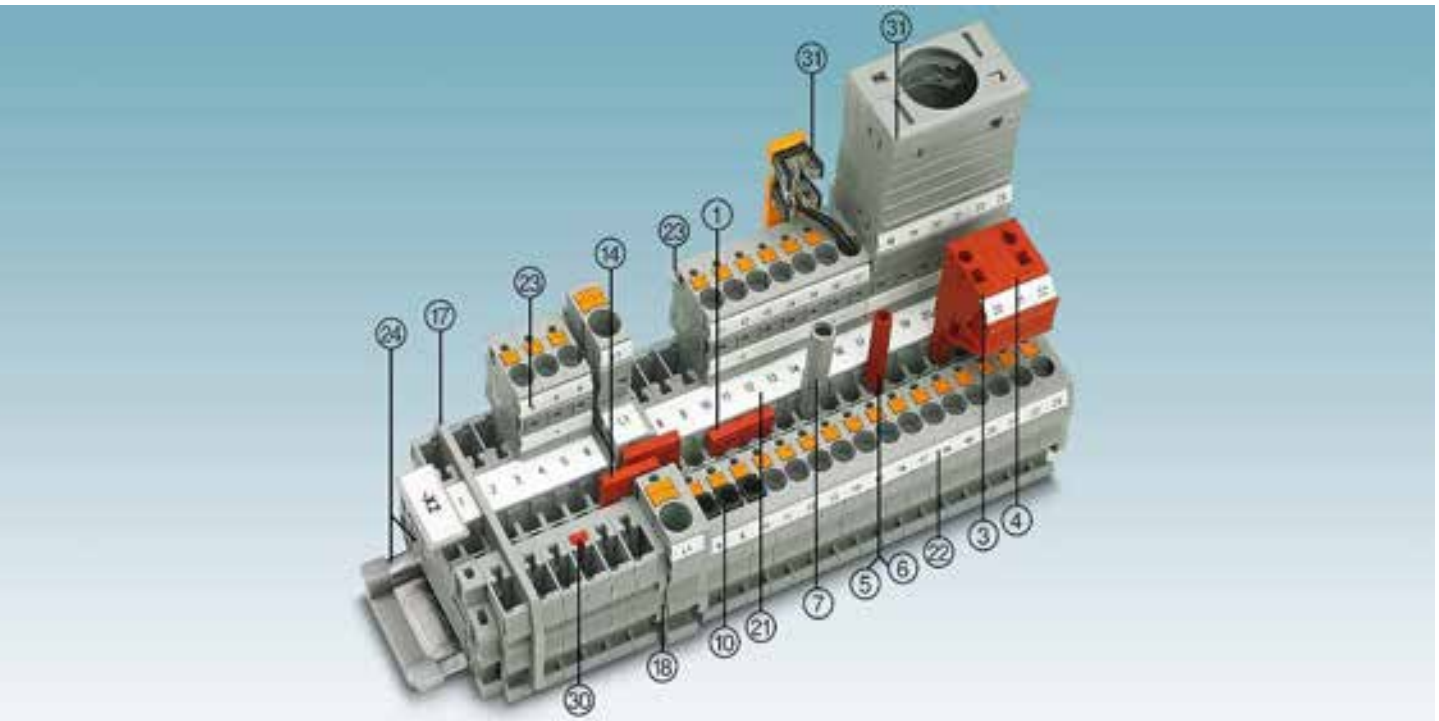

Description	No. of pos.	Color	Type	Order No.	Pcs./Pkt.	Type	Order No.	Pcs./Pkt.
① Bridge ¹⁾	2	red	FBS 2-6	3030336	50	FBSR 2-6	3033715	50
	3	red	FBS 3-6	3030242	50	FBSR 3-6	3001594	50
	4	red	FBS 4-6	3030255	50	FBSR 4-6	3001595	50
	5	red	FBS 5-6	3030349	50	FBSR 5-6	3001596	50
	10	red	FBS 10-6	3030271	10	FBSR 10-6	3033716	10
	20	red	FBS 20-6	3030365	10			
③ Modular test plug		red	PS-6	3030996	10			
④ Spacer plate		red	DP PS-6	3036738	10			
⑤ Test plug metal part		gray	MPS-MT	0201744	10			
⑥ Insulating sleeve, for MPS metal part		red	MPS-IH RD	0201676	10			
⑦ Test adapter, 4 mm socket hole		gray	PAI-4-N GY	3032871	10			
⑩ Insulating sleeve 0.75 - 1 mm ²		black	ISH 4/0,5	3002885	50			
			ISH 4/1,0	3002898	50			
⑳ Coding profile		red	PC	3040588	50			
Screwdriver			SF-SL 0,6X3,5-100 S-VDE	1212587	10			

⑭ Reducing bridge	For RB ..., see page 408.
⑰ Partition plates/end cover segments	For ATP-... / DS-..., visit phoenixcontact.net/products
⑳ Cover	Listed alongside the respective product.
㉑ Center groove labeling	UC-TM 6, UCT-TM 6 or ZB 6. See also Catalog 3, selection tables, from page 60.
㉒ Center and side groove labeling	UC-TMF 6, UCT-TMF 6 or ZBF 6. See also Catalog 3, selection tables, from page 60.
㉓ Lateral groove labeling	UC-TMF 6, UCT-TMF 6 or ZBF 6. See also Catalog 3, selection tables, from page 60.
㉔ DIN rail and end bracket	See Catalog 3
㉕ Latching, strain relief, shielding	See from page 362.
For full accessories, visit phoenixcontact.net/products	Note: Additional or deviating accessories are listed alongside the respective product.

Feed-through and multi-conductor terminal blocks

Notes:
 1) For additional accessories and technical data, see page 324.
 2) For derating curve, visit phoenixcontact.net/products

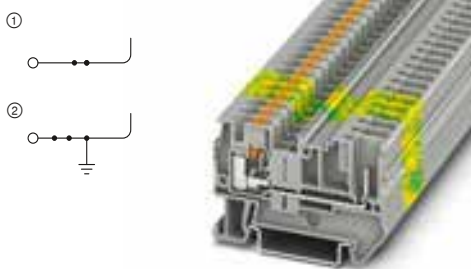

32 A, feed-through terminal block



Technical data ¹⁾				
Dimensions	Width	Length	Height	
	6.2	56	36.5 (NS 35/7,5)	
Maximum electrical data	I_{max} [A]	U_{max} [V]	max. Ø [mm ²]	AWG (UL)
	32 ²⁾	800	0.2 - 6	24-10
	32 (FBS) / 22 (FBSR)			
Maximum bridge current	[A]	IEC	UL / CUL	CSA Ex
Rated data		800	600	-
Rated voltage	[V]	32 ²⁾ / 4	28 / -	- / -
Nominal current / cross section	[A] / [mm ²]			

Ordering data			
Type	Order No.	Pcs./Pkt.	
PT 4/1P	① 3211937	50	
PT 4/1P BU	① 3212007	50	
PT 4/1P-PE	② 3211942	50	

Accessories ¹⁾		
D-ST 4	3030420	50

Description	Color
Terminal block	gray
	blue
Ground terminal	green-yellow
Cover, width: 2.2 mm	gray

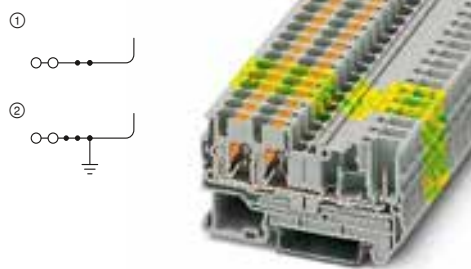

32 A, feed-through terminal block, 3 connections



Technical data ¹⁾				
Dimensions	Width	Length	Height	
	6.2	66.4	36.5 (NS 35/7,5)	
Maximum electrical data	I_{max} [A]	U_{max} [V]	max. Ø [mm ²]	AWG (UL)
	32 ²⁾	800	0.2 - 6	24-10
	32 (FBS) / 22 (FBSR)			
Maximum bridge current	[A]	IEC	UL / CUL	CSA Ex
Rated data		800	600	-
Rated voltage	[V]	32 ²⁾ / 4	28 / -	- / -
Nominal current / cross section	[A] / [mm ²]			

Ordering data			
Type	Order No.	Pcs./Pkt.	
PT 4-TWIN/1P	① 3212200	50	
PT 4-TWIN/1P BU	① 3212201	50	
PT 4-TWIN/1P-PE	② 3212202	50	

Accessories ¹⁾		
D-PT 4-TWIN/1P	3212203	50

Feed-through and multi-conductor terminal blocks

Notes:
 1) For additional accessories and technical data, see page 324.
 2) For derating curve, visit phoenixcontact.net/products

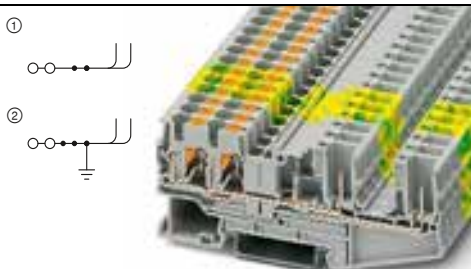

32 A, feed-through terminal block, 4 connections



Technical data ¹⁾				
Dimensions	Width	Length	Height	
	6.2	92.1	36.5 (NS 35/7,5)	
Maximum electrical data	I_{max} [A]	U_{max} [V]	max. Ø [mm ²]	AWG (UL)
	32 ²⁾	800	0.2 - 6	24-10
	32 (FBS) / 24 (FBSR)			
Maximum bridge current	[A]	IEC	UL / CUL	CSA Ex
Rated data		800	600	-
Rated voltage	[V]	32 ²⁾ / 4	28 / -	- / -
Nominal current / cross section	[A] / [mm ²]			
Cross section range	AWG	24 - 10	-	-
Connection capacity	Rigid	Flexible	Ferrule without/with plastic sleeve	
	1 conductor		0.2 - 6	0.2 - 4 / 0.25 - 4 / 0.25 - 4

Ordering data			
Type	Order No.	Pcs./Pkt.	
PT 4-QUATTRO/2P	① 3211991	50	
PT 4-QUATTRO/2P BU	① 3212000	50	
PT 4-QUATTRO/2P-PE	② 3211999	50	

Accessories ¹⁾		
D-PT 4-QUATTRO/2P	3209277	50

Description	Color
Terminal block	gray
	blue
Ground terminal	green-yellow
Cover, width: 2.2 mm	gray

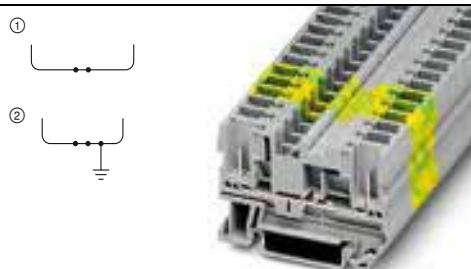

32 A, feed-through terminal block



Technical data ¹⁾				
Dimensions	Width	Length	Height	
	6.2	55.9	36.5 (NS 35/7,5)	
Maximum electrical data	I_{max} [A]	U_{max} [V]	max. Ø [mm ²]	AWG (UL)
	32 ²⁾	800	0.08 - 6	-
	32 (FBS) / 24 (FBSR)			
Maximum bridge current	[A]	IEC	UL / CUL	CSA Ex
Rated data		800	-	-
Rated voltage	[V]	32 ²⁾ / 4	- / -	- / -
Nominal current / cross section	[A] / [mm ²]			
Cross section range	AWG	28 - 10	-	-
Connection capacity	Rigid	Flexible	Ferrule without/with plastic sleeve	
	0.08 - 6		0.08 - 4	0.14 - 4 / 0.14 - 4

Ordering data			
Type	Order No.	Pcs./Pkt.	
ST 4/ 2P	① 3042735	50	
ST 4/ 2P BU	① 3043789	50	
ST 4/ 2P-PE	② 3042748	50	

Accessories ¹⁾		
D-ST 4	3030420	50

Terminal blocks – CLIPLINE complete

4 mm² COMBI PT plug-in connection solutions

COMBI headers for PCB connection

Notes:

For additional accessories and technical data, see page 364 or visit phoenixcontact.net/products



32 A, header, horizontal plug-in direction



32 A, header, vertical plug-in direction



Technical data

Dimensions	Width	Length	Height
	14.45	25.1	29.45
Maximum electrical data	[mm]		
$I_{max.}$ [A]	32	-	max. \varnothing [mm ²] AWG (UL)
Rated data	IEC	UL	CSA IEC/EN 60079-7
Rated voltage [V]	-	600	-
Nominal current / cross section [A] / [mm ²]	32 / 4	20 / -	-
Rated cross section [mm ²]	4	-	-
General data	PA		
Insulating material	V0		
Flammability rating in accordance with UL 94	V0		



Technical data

Dimensions	Width	Length	Height
	12.4	26	25.1
Maximum electrical data	[mm]		
$I_{max.}$ [A]	32	-	max. \varnothing [mm ²] AWG (UL)
Rated data	IEC	UL	CSA IEC/EN 60079-7
Rated voltage [V]	-	600	-
Nominal current / cross section [A] / [mm ²]	32 / 4	20 / -	-
Rated cross section [mm ²]	4	-	-
General data	PA		
Insulating material	V0		
Flammability rating in accordance with UL 94	V0		

Ordering data

Description	No. of pos.	Width	Color	Type	Order No.	Pcs./Pkt.
COMBI header	2	14.45 mm	gray	ST 4-PCB/ 2-G-6,2	1980598	50
	3	20.65 mm	gray	ST 4-PCB/ 3-G-6,2	1980608	50
	4	26.85 mm	gray	ST 4-PCB/ 4-G-6,2	1980611	50
	5	33.05 mm	gray	ST 4-PCB/ 5-G-6,2	1980624	50
	6	39.25 mm	gray	ST 4-PCB/ 6-G-6,2	1980637	50
	7	45.45 mm	gray	ST 4-PCB/ 7-G-6,2	1980640	50
	8	51.65 mm	gray	ST 4-PCB/ 8-G-6,2	1980653	50
	9	57.85 mm	gray	ST 4-PCB/ 9-G-6,2	1980666	50
	10	64.05 mm	gray	ST 4-PCB/10-G-6,2	1980679	50
	11	70.25 mm	gray	ST 4-PCB/11-G-6,2	1980682	50
	12	76.45 mm	gray	ST 4-PCB/12-G-6,2	1980695	50
	COMBI header	2	12.4 mm	gray		
3		18.6 mm	gray			
4		24.8 mm	gray			
5		31 mm	gray			
6		37.2 mm	gray			
7		43.4 mm	gray			
8		49.6 mm	gray			
9		55.8 mm	gray			
10		62 mm	gray			
11		68.2 mm	gray			
12		74.4 mm	gray			

Ordering data

Description	No. of pos.	Width	Color	Type	Order No.	Pcs./Pkt.
COMBI header	2	12.4 mm	gray	ST 4-PCBV/ 2-G-6,2	1980705	50
	3	18.6 mm	gray	ST 4-PCBV/ 3-G-6,2	1980718	50
	4	24.8 mm	gray	ST 4-PCBV/ 4-G-6,2	1980721	50
	5	31 mm	gray	ST 4-PCBV/ 5-G-6,2	1980734	50
	6	37.2 mm	gray	ST 4-PCBV/ 6-G-6,2	1980747	50
	7	43.4 mm	gray	ST 4-PCBV/ 7-G-6,2	1980750	50
	8	49.6 mm	gray	ST 4-PCBV/ 8-G-6,2	1980763	50
	9	55.8 mm	gray	ST 4-PCBV/ 9-G-6,2	1980776	50
	10	62 mm	gray	ST 4-PCBV/10-G-6,2	1980789	50
	11	68.2 mm	gray	ST 4-PCBV/11-G-6,2	1980792	50
	12	74.4 mm	gray	ST 4-PCBV/12-G-6,2	1980802	50

COMBI connectors

Notes:
1) For additional accessories and technical data, see page 324.
2) For derating curve, visit phoenixcontact.net/products



32 A, connector, connection in plug-in direction



32 A, connector, connection in plug-in direction, for self-assembly



Technical data¹⁾

Width	Length	Height	Height plugged
6.2 x No. of pos.	21	42.3	24
I_{max} [A]	U_{max} [V]	max. Ø [mm ²]	AWG (UL)
32 ²⁾	800	0.2 - 6	24-10
IEC	UL / CUL	CSA	Ex
800	600	-	-
Nominal current / cross section	[A] / [mm ²]	32 ²⁾ / 4	28 / -

Technical data¹⁾

Width	Length	Height	Height plugged
6.2 x No. of pos.	21	42.3	24
I_{max} [A]	U_{max} [V]	max. Ø [mm ²]	AWG (UL)
32 ²⁾	800	0.2 - 6	24-10
IEC	UL / CUL	CSA	Ex
800	600	-	-
Nominal current / cross section	[A] / [mm ²]	32 ²⁾ / 4	28 / -

Ordering data

Type	Order No.	Pcs./Pkt.
PP-H 4/ 1	3212010	50
PP-H 4/ 2	3212016	50
PP-H 4/ 3	3212022	50
PP-H 4/ 4	3212029	50
PP-H 4/ 5	3212035	50
PP-H 4/ 6	3212041	25
PP-H 4/ 7	3212048	25
PP-H 4/ 8	3212054	25
PP-H 4/ 9	3212061	25
PP-H 4/10	3212067	25
PP-H 4/11	3212074	10
PP-H 4/12	3212080	10
PP-H 4/13	3212087	10
PP-H 4/14	3212093	10
PP-H 4/15	3212100	10
PP-H 4/ 1 BU	3212077	50
PP-H 4/ 1 GNYE	3212088	50

Ordering data

Type	Order No.	Pcs./Pkt.
PP-H 4/ 1-L	3211948	50
PP-H 4/ 1-L BU	3211951	50
PP-H 4/ 1-L GNYE	3211958	50
PP-H 4/ 1-M	3211965	50
PP-H 4/ 1-M BU	3211964	50
PP-H 4/ 1-M GNYE	3211971	50
PP-H 4/ 1-R	3211977	50
PP-H 4/ 1-R BU	3211980	50
PP-H 4/ 1-R GNYE	3211987	50

Accessories¹⁾

Accessories	Order No.	Pcs./Pkt.
MPS-MT	0201744	10
MPS-IH RD	0201676	10
PRZ	3040614	50
PR	3040559	50
PR/2	3040630	50
PZ/2	3040627	50
PH 4/2	3000734	50
PH 4/3	3000736	50
PH 4/4	3000737	50
PH 4/5	3000738	50
PH 4/6	3000739	25
PH 4/7	3000740	25
PH 4/8	3000741	25
PH 4/9	3000742	25
PH 4/10	3000743	25

Accessories¹⁾

Accessories	Order No.	Pcs./Pkt.
MPS-MT	0201744	10
MPS-IH RD	0201676	10
PRZ	3040614	50
PR	3040559	50
PR/2	3040630	50
PZ/2	3040627	50
PH 4/2	3000734	50
PH 4/3	3000736	50
PH 4/4	3000737	50
PH 4/5	3000738	50
PH 4/6	3000739	25
PH 4/7	3000740	25
PH 4/8	3000741	25
PH 4/9	3000742	25
PH 4/10	3000743	25

Terminal blocks – CLIPLINE complete

4 mm² COMBI UT plug-in connection solutions

General technical data

Rated data		IEC 61984			
Rated cross section	[mm ²]	4			
Cross section range	AWG	26 - 10			
Connection capacity		Rigid	Flexible	Ferrule without/with plastic sleeve	
1 conductor	[mm ²]	0.14 - 6	0.14 - 6	0.14 - 4	0.14 - 4
2 conductors (of the same type)	[mm ²]	0.14 - 1.5	0.14 - 1.5	0.14 - 1.5	-
2 flexible conductors with a TWIN ferrule	[mm ²]	-	-	-	0.5 - 2.5
General data					
Stripping length	[mm]	9			
Insulating material		PA			
Flammability rating in accordance with UL 94		V0			

Note: Additional or deviating data is listed alongside the respective product.

Notes:



In addition to the product, the internal electrical wiring is provided as a circuit diagram. Free connection points for bridging are indicated by a black dot.

The specified technical data and approvals refer to the first product in each column. For information on the products below, please refer to phoenixcontact.net/products

For full details of UL and CSA use groups, file nos., and Internet links, please visit phoenixcontact.net/products

¹⁾ The bridge current is listed alongside the respective product. For additional colors, see page 402.

System accessories

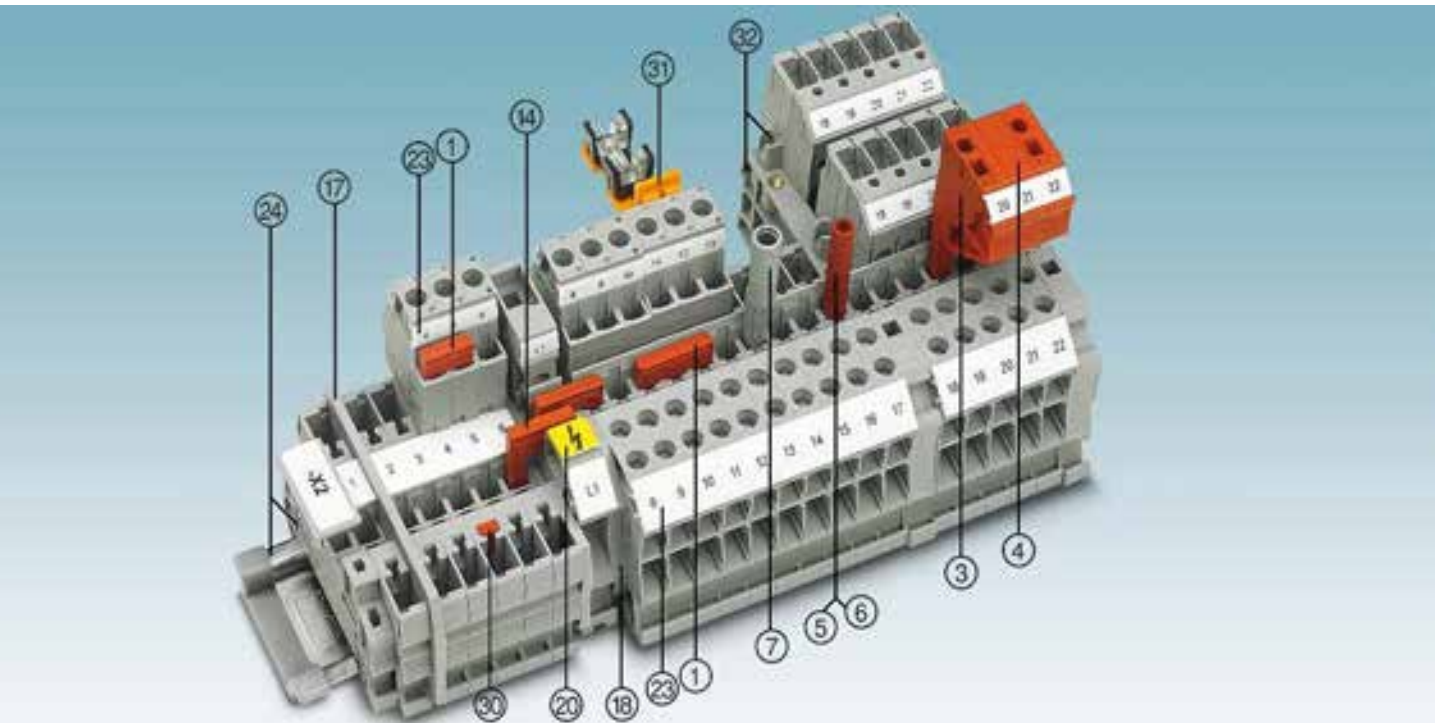

Description	No. of pos.	Color	Type	Order No.	Pcs./Pkt.	Type	Order No.	Pcs./Pkt.
① Bridge ¹⁾	2	red	FBS 2-6	3030336	50	FBSR 2-6	3033715	50
	3	red	FBS 3-6	3030242	50	FBSR 3-6	3001594	50
	4	red	FBS 4-6	3030255	50	FBSR 4-6	3001595	50
	5	red	FBS 5-6	3030349	50	FBSR 5-6	3001596	50
	10	red	FBS 10-6	3030271	10	FBSR 10-6	3033716	10
	20	red	FBS 20-6	3030365	10			
③ Modular test plug		red	PS-6	3030996	10			
④ Spacer plate		red	DP PS-6	3036738	10			
⑤ Test plug metal part		gray	MPS-MT	0201744	10			
⑥ Insulating sleeve, for MPS metal part		red	MPS-IH RD	0201676	10			
⑦ Test adapter, 4 mm socket hole		gray	PAI-4-N GY	3032871	10			
③ Coding profile		red	PC	3040588	50			
Screwdriver			SF-SL 0,6X3,5-100 S-VDE	1212587	10			
⑭ Reducing bridge	For RB ..., see page 408.							
⑰ Partition plates/end cover segments	For ATP-... / DS-..., visit phoenixcontact.net/products							
⑱ Cover	Listed alongside the respective product.							
⑳ Warning labels	For WS ..., see page 420.							
㉑ Lateral groove labeling	Terminal block: UC-TM 6, UCT-TM 6 or ZB 6 Connector: UC-TMF 6, UCT-TMF 6 or ZBF 6. See also Catalog 3, selection tables, from page 60. See Catalog 3							
㉒ DIN rail and end bracket	See from page 362.							
㉓ Latching, strain relief, shielding	See from page 372.							
㉔ Screw flanges, screw flange cover	Note: Additional or deviating accessories are listed alongside the respective product.							
For full accessories, visit phoenixcontact.net/products								

Feed-through, multi-conductor, multi-level, and ground terminal blocks

Notes:
1) For additional accessories and technical data, see page 328.
2) For derating curve, visit phoenixcontact.net/products
For screw flange, see page 372.

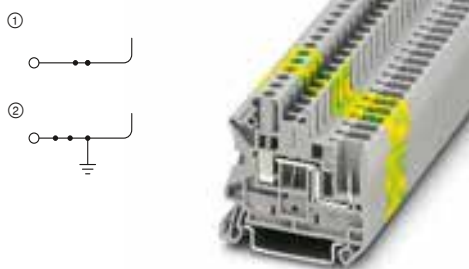

32 A, feed-through terminal block



Technical data ¹⁾				
Dimensions	Width	Length	Height	
[mm]	6.2	47.6	47.5 (NS 35/7,5)	
Maximum electrical data	I_{max} [A]	U_{max} [V]	max. Ø [mm ²]	AWG (UL)
	32 ²⁾	800	0.14 - 6	26-10
Maximum bridge current	32 (FBS) / 24 (FBSR)			
Rated data	IEC	UL / CUL	CSA	Ex
Rated voltage	800	600	600	-
Nominal current / cross section	32 ²⁾ / 4	30 / -	30 / -	- / -

Ordering data			
Type	Order No.	Pcs./Pkt.	
UT 4/ 1P	① 3045583	50	
UT 4/ 1P BU	① 3045596	50	
UT 4/ 1P-PE	② 3045606	50	

Accessories ¹⁾		
D-UT 2,5/1P	Order No.	Pcs./Pkt.
D-UT 2,5/1P	3047154	50

Description	Color
Terminal block	gray
	blue
Ground terminal	green-yellow
Cover, width: 2.2 mm	gray

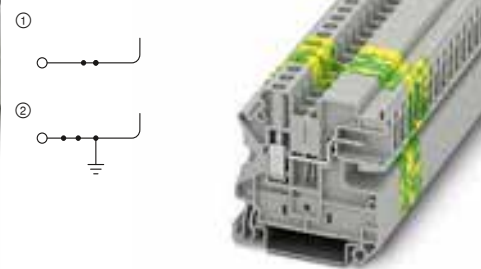

32 A, feed-through terminal block, horizontal plug-in connection



Technical data ¹⁾				
Dimensions	Width	Length	Height	
[mm]	6.2	49.8	47.5 (NS 35/7,5)	
Maximum electrical data	I_{max} [A]	U_{max} [V]	max. Ø [mm ²]	AWG (UL)
	32 ²⁾	800	0.14 - 6	26-10
Maximum bridge current	32 (FBS) / 24 (FBSR)			
Rated data	IEC	UL / CUL	CSA	Ex
Rated voltage	800	600	-	-
Nominal current / cross section	32 ²⁾ / 4	30 / -	- / -	- / -

Ordering data		
Type	Order No.	Pcs./Pkt.
UT 4/ 1P-H	① 3001369	50
UT 4/ 1P-H-PE	② 3001372	50

Accessories ¹⁾		
D-UT 4/1P-H	Order No.	Pcs./Pkt.
D-UT 4/1P-H	3001382	50

Feed-through, multi-conductor, multi-level, and ground terminal blocks

Notes:
1) For additional accessories and technical data, see page 328.
2) For derating curve, visit phoenixcontact.net/products
For screw flange, see page 372.

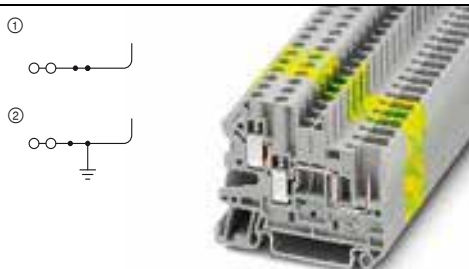

32 A, feed-through terminal block, 3 connections



Technical data ¹⁾				
Dimensions	Width	Length	Height	
[mm]	6.2	55.7	47.5 (NS 35/7,5)	
Maximum electrical data	I_{max} [A]	U_{max} [V]	max. Ø [mm ²]	AWG (UL)
	32 ²⁾	500	0.14 - 6	26-10
Maximum bridge current	32 (FBS) / 24 (FBSR)			
Rated data	IEC	UL / CUL	CSA	Ex
Rated voltage	500	600	300	-
Nominal current / cross section	32 ²⁾ / 4	30 / -	30 / -	- / -
Connection capacity	Rigid	Flexible	Ferrule without/with plastic sleeve	
2 flexible conductors with a TWIN ferrule	-	-	- 0.5 - 1	

Ordering data			
Type	Order No.	Pcs./Pkt.	
UT 4-TWIN/ 1P	① 3060267	50	
UT 4-TWIN/ 1P BU	① 3060270	50	
UT 4-TWIN/ 1P-PE	② 3060283	50	

Accessories ¹⁾		
D-UT 4-TWIN/ 1P	Order No.	Pcs./Pkt.
D-UT 4-TWIN/ 1P	3045237	50

Description	Color
Terminal block	gray
	blue
Ground terminal	green-yellow
Cover, width: 2.2 mm	gray

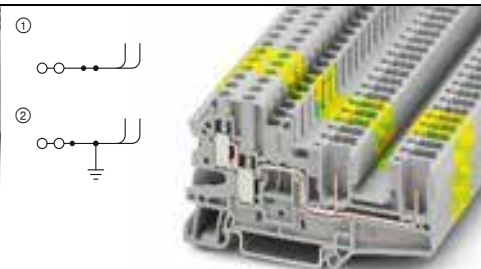

32 A, feed-through terminal block, 4 connections



Technical data ¹⁾				
Dimensions	Width	Length	Height	
[mm]	6.2	82.4	47.5 (NS 35/7,5)	
Maximum electrical data	I_{max} [A]	U_{max} [V]	max. Ø [mm ²]	AWG (UL)
	32	500	0.14 - 6	26-10
Maximum bridge current	32 (FBS) / 24 (FBSR)			
Rated data	IEC	UL / CUL	CSA	Ex
Rated voltage	500	600	300	-
Nominal current / cross section	32 ²⁾ / 4	30 / -	30 / -	- / -
Connection capacity	Rigid	Flexible	Ferrule without/with plastic sleeve	
	-	-	- 0.5 - 1	

Ordering data		
Type	Order No.	Pcs./Pkt.
UT 4-QUATTRO/ 2P	① 3060296	50
UT 4-QUATTRO/ 2P BU	① 3060306	50
UT 4-QUATTRO/ 2P-PE	② 3060319	50

Accessories ¹⁾		
D-UT 4-QUATTRO/ 2P	Order No.	Pcs./Pkt.
D-UT 4-QUATTRO/ 2P	3045648	50

Terminal blocks – CLIPLINE complete

4 mm² COMBI UT plug-in connection solutions

COMBI plug-in male/male double-level and ground terminal blocks

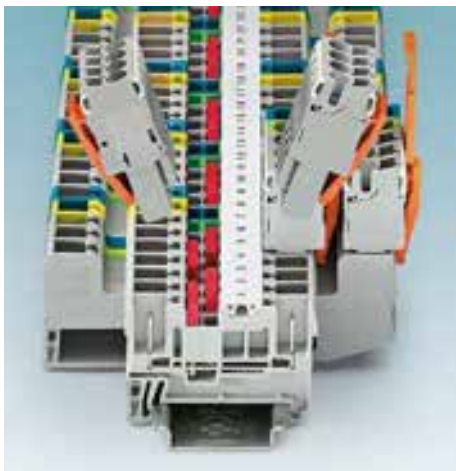

- For the male/male versions of the COMBI series, plugs can be used on both sides of the terminal blocks
- This makes the COMBI system even more flexible as the terminal blocks are used as the connection element for modules
- Connection with the standard COMBI connectors
- The extensive range of accessories, such as latching, strain relief, encoding and shield connection can be used
- Ground terminal blocks with the same shape and pitch
- Contact is made free from mechanical and electrical errors by simply snapping onto the DIN rail
- All the requirements of IEC 60947-7-2 standard are met

PROJECT complete planning enables the quick and convenient planning and configuration of error-free terminal strips.



Notes:
1) For additional accessories and technical data, see page 328.
2) For derating curve, visit phoenixcontact.net/products

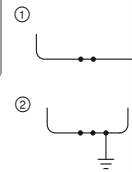

32 A, feed-through terminal block



Dimensions	
	[mm]
Maximum electrical data	
Maximum bridge current	[A]
Rated data	
Rated voltage	[V]
Nominal current / cross section	[A] / [mm ²]
Cross section range	AWG
Connection capacity	
1 conductor	[mm ²]
2 flexible conductors with a TWIN ferrule	[mm ²]
Cover, width: 2.2 mm	
	gray

Description	Color
Terminal block	gray blue
Ground terminal	green-yellow

Technical data ¹⁾				
Width	Length	Height		
6.2	55.9	36.5 (NS 35/7,5)		
I _{max} [A]	U _{max} [V]	max. Ø [mm ²]	AWG (UL)	
32 ²⁾	800	0.08 - 6	-	
32 (FBS) / 24 (FBSR)				
IEC	UL / CUL	CSA	Ex	
800	-	-	-	
Nominal current / cross section	[A] / [mm ²]	- / -	- / -	- / -
28 - 10	-	-	-	
Connection capacity		Ferrule		
Rigid	Flexible	without/with plastic sleeve		
0.08 - 6	0.08 - 4	0.14 - 4	0.14 - 4	
-	-	-	0.5 - 1	

Ordering data			
Type	Order No.	Pcs./Pkt.	
ST 4/ 2P	① 3042735	50	
ST 4/ 2P BU	① 3043789	50	
ST 4/ 2P-PE	② 3042748	50	

Accessories ¹⁾		
D-ST 4	3030420	50

Test disconnect terminal blocks

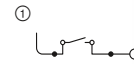

28 A, test disconnect terminal block

Notes:
1) For additional accessories and technical data, see page 328.
2) For derating curve, visit phoenixcontact.net/products



Dimensions	[mm]
Maximum electrical data	
Maximum bridge current	[A]
Rated data	
Rated voltage	[V]
Nominal current / cross section	[A] / [mm ²]
Description	Color
Terminal block	gray
Cover, width: 2.2 mm	gray

Technical data ¹⁾			
Width	Length	Height	
6.2	71.1	49.5 (NS 35/7,5)	
I_{max} [A]	U_{max} [V]	max. \varnothing [mm ²]	AWG (UL)
28 ²⁾	500	0.14 - 6	26-10
32 (FBS) / 24 (FBSR)			
IEC	UL / CUL	CSA	Ex
500	600	600	-
28 ²⁾ / 4	25 / -	25 / -	- / -

Ordering data		
Type	Order No.	Pcs./Pkt.
UTME 4/1P	3057416	50

Accessories ¹⁾		
D-UTME 4/1P	3057429	10

Supplementary accessories
for UTME 4/1P test disconnect
terminal blocks



- Only two UTME 4/1P test disconnect terminal blocks are required for a current transformer measuring circuit
- Less space required compared to creating circuits with slide-type terminal blocks

- ① FBS... plug-in bridge for cross connection
- ② 4 mm \varnothing PAI-4-FIX... test plug adapter
- ③ S-ME 4 switching lock
- ④ SB-ME... bridge bar
- ⑤ C-ME 4/2 operating lever

			Ordering data		
Description	No. of pos.	Color	Type	Order No.	Pcs./Pkt.
Test adapter, for 4 mm \varnothing safety test plugs, latches into the bridge shaft	1	orange	PAI-4-FIX-5/6 OG	3035974	10
	1	yellow	PAI-4-FIX-5/6 YE	3035977	10
	1	green	PAI-4-FIX-5/6 GN	3035978	10
	1	violet	PAI-4-FIX-5/6 VT	3035979	10
	1	black	PAI-4-FIX-5/6 BK	3035980	10
	1	blue	PAI-4-FIX-5/6 BU	3035975	10
	1	red	PAI-4-FIX-5/6 RD	3035976	10
	1	gray	PAI-4-FIX-5/6 GY	3035982	10
	1	brown	PAI-4-FIX-5/6 BN	3035981	10
Switching lock, plug-in		white	S-ME 4	3035758	10
Switching bridge, plug-in	2	gray/orange	SB-ME 2-6	3035755	10
	3	gray/orange	SB-ME 3-6	3035756	10
	4	gray/orange	SB-ME 4-6	3035757	10
Operating lever, for actuating 2 test disconnect terminal blocks	2	orange	C-ME 4/2	3035759	10
	3	orange	C-ME 4/3	3035760	10

Terminal blocks – CLIPLINE complete

4 mm² COMBI UT plug-in connection solutions

Test disconnect terminal blocks

Notes:
1) For additional accessories and technical data, see page 328.
2) For derating curve, visit phoenixcontact.net/products

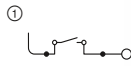

28 A, current transformer disconnect terminal block



Technical data ¹⁾				
Width	Length	Height		
6.2	86.5	49.5 (NS 35/7,5)		
I _{max} [A]	U _{max} [V]	max. Ø [mm ²]	AWG (UL)	
28	500	0.14 - 6	26-10	
32 (FBS) / 24 (FBSR)				
IEC	UL / CUL	CSA	Ex	
500	600	600	-	
Nominal current / cross section [A] / [mm ²]				
28 ²⁾ / 4	25 / -	25 / -	- / -	
Connection capacity		Ferrule		
Rigid		without/with plastic sleeve		
1 conductor	0.14 - 6	0.14 - 4	0.14 - 4	0.14 - 4
2 flexible conductors with a TWIN ferrule	-	-	0.5 - 2.5	

Ordering data			
Type	Order No.	Pcs./Pkt.	
UTME 4-CT/1P	3057432	50	

Accessories ¹⁾			
Type	Order No.	Pcs./Pkt.	
D-UTME 4-CT/1P	3057445	10	

Dimensions	
	[mm]
Maximum electrical data	
Maximum bridge current	[A]
Rated data	
Rated voltage	[V]
Nominal current / cross section	[A] / [mm ²]
Connection capacity	
1 conductor	[mm ²]
2 flexible conductors with a TWIN ferrule	[mm ²]

Description	Color
Terminal block	gray
Connector, with integrated short-circuit function,	gray
2-pos.	
3-pos.	gray

Cover, width: 2.2 mm	gray
-----------------------------	------

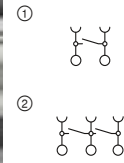

20 A, connector, with integrated short-circuit function



Technical data ¹⁾			
Width	Length	Height	
12.4	38.5	48.5	
I _{max} [A]	U _{max} [V]	max. Ø [mm ²]	AWG (UL)
20	320	0.14 - 6	26-10
-			
IEC	UL / CUL	CSA	Ex
320	300	300	-
Nominal current / cross section [A] / [mm ²]			
20 / 4	25 / -	25 / -	- / -
Connection capacity		Ferrule	
Rigid		without/with plastic sleeve	
0.14 - 6	0.14 - 6	0.14 - 4	0.14 - 4
-	-	-	0.5 - 1

Ordering data			
Type	Order No.	Pcs./Pkt.	
UPCT 4/2	3057461	10	
UPCT 4/3	3057458	10	

Accessories ¹⁾			
Type	Order No.	Pcs./Pkt.	

Supplementary accessories for UTME 4-CT/1P test disconnect terminal blocks



Notes:
1) The coding set can be used to code up to 30 plugs.

- Only two UTME 4-CT/1P test disconnect terminal blocks are required for a current transformer measuring circuit
- Less space required compared to creating circuits with slide-type terminal blocks

- 1) FBS... plug-in bridge for cross connection
- 2) 4 mm Ø PAI-4-FIX... test plug adapter
- 3) S-ME 4 switching lock
- 4) SB-ME... bridge bar
- 5) C-ME 4/2 operating lever
- 6) PC-CT 6... coding set

Description	No. of pos.	Color
Test adapter , for 4 mm Ø safety test plugs, latches into the bridge shaft	1	orange
	1	yellow
	1	green
	1	violet
	1	black
	1	blue
	1	red
	1	gray
	1	brown
Switching lock , plug-in		white
Switching bridge , plug-in	2	gray/orange
	3	gray/orange
	4	gray/orange
Operating lever , for actuating 2 test disconnect terminal blocks	2	orange
	3	orange
Coding set , for 2-pos. plugs ¹⁾		red

Ordering data			
Type	Order No.	Pcs./Pkt.	
PAI-4-FIX-5/6 OG	3035974	10	
PAI-4-FIX-5/6 YE	3035977	10	
PAI-4-FIX-5/6 GN	3035978	10	
PAI-4-FIX-5/6 VT	3035979	10	
PAI-4-FIX-5/6 BK	3035980	10	
PAI-4-FIX-5/6 BU	3035975	10	
PAI-4-FIX-5/6 RD	3035976	10	
PAI-4-FIX-5/6 GY	3035982	10	
PAI-4-FIX-5/6 BN	3035981	10	
S-ME 4	3035758	10	
SB-ME 2-6	3035755	10	
SB-ME 3-6	3035756	10	
SB-ME 4-6	3035757	10	
C-ME 4/2	3035759	10	
C-ME 4/3	3035760	10	
PC-CT 6/2	3212308	1	

COMBI headers for PCB connection

Notes:
For additional accessories and technical data, see page 364 or visit phoenixcontact.net/products



32 A, header, horizontal plug-in direction



32 A, header, vertical plug-in direction



Technical data				
Width	Length	Height		
14.45	25.1	29.45		
I _{max.} [A]		max. Ø [mm ²]		AWG (UL)
32		-		-
IEC	UL	CSA	IEC/EN 60079-7	
-	600	-	-	
Rated voltage [V]		Nominal current / cross section [A] / [mm ²]		
-		32 / 4		
Rated cross section [mm ²]		4		
4		-		
General data				
Insulating material				
PA				
Flammability rating in accordance with UL 94				
V0				



Technical data				
Width	Length	Height		
12.4	26	25.1		
I _{max.} [A]		max. Ø [mm ²]		AWG (UL)
32		-		-
IEC	UL	CSA	IEC/EN 60079-7	
-	600	-	-	
Rated voltage [V]		Nominal current / cross section [A] / [mm ²]		
-		32 / 4		
Rated cross section [mm ²]		4		
4		-		
General data				
Insulating material				
PA				
Flammability rating in accordance with UL 94				
V0				

Ordering data

Description	No. of pos.	Width	Color	Type	Order No.	Pcs./Pkt.
COMBI header	2	14.45 mm	gray	ST 4-PCB/ 2-G-6,2	1980598	50
	3	20.65 mm	gray	ST 4-PCB/ 3-G-6,2	1980608	50
	4	26.85 mm	gray	ST 4-PCB/ 4-G-6,2	1980611	50
	5	33.05 mm	gray	ST 4-PCB/ 5-G-6,2	1980624	50
	6	39.25 mm	gray	ST 4-PCB/ 6-G-6,2	1980637	50
	7	45.45 mm	gray	ST 4-PCB/ 7-G-6,2	1980640	50
	8	51.65 mm	gray	ST 4-PCB/ 8-G-6,2	1980653	50
	9	57.85 mm	gray	ST 4-PCB/ 9-G-6,2	1980666	50
	10	64.05 mm	gray	ST 4-PCB/10-G-6,2	1980679	50
	11	70.25 mm	gray	ST 4-PCB/11-G-6,2	1980682	50
	12	76.45 mm	gray	ST 4-PCB/12-G-6,2	1980695	50

Ordering data

Description	No. of pos.	Width	Color	Type	Order No.	Pcs./Pkt.
COMBI header	2	12.4 mm	gray	ST 4-PCBV/ 2-G-6,2	1980705	50
	3	18.6 mm	gray	ST 4-PCBV/ 3-G-6,2	1980718	50
	4	24.8 mm	gray	ST 4-PCBV/ 4-G-6,2	1980721	50
	5	31 mm	gray	ST 4-PCBV/ 5-G-6,2	1980734	50
	6	37.2 mm	gray	ST 4-PCBV/ 6-G-6,2	1980747	50
	7	43.4 mm	gray	ST 4-PCBV/ 7-G-6,2	1980750	50
	8	49.6 mm	gray	ST 4-PCBV/ 8-G-6,2	1980763	50
	9	55.8 mm	gray	ST 4-PCBV/ 9-G-6,2	1980776	50
	10	62 mm	gray	ST 4-PCBV/10-G-6,2	1980789	50
	11	68.2 mm	gray	ST 4-PCBV/11-G-6,2	1980792	50
	12	74.4 mm	gray	ST 4-PCBV/12-G-6,2	1980802	50

Terminal blocks – CLIPLINE complete

4 mm² COMBI UT plug-in connection solutions

Connectors

- Direct connection of current transformers and voltage transducers, e.g., to a protective relay for medium-voltage switchgear
- UP 4...CT and BP 4...CT plugs contain a short-circuit element. When removing the plug from the device, a leading short circuit of the connected current transformer is carried out

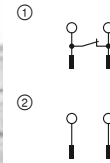
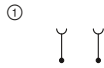

Notes:
 1) For additional accessories and technical data, see page 328.
 PT 4-WE feed-through terminal blocks, see page 653.

ERC

Technical data¹⁾

Dimensions		Width	Length	Height
		65.7	29.1	34.3
[mm]				
Maximum electrical data		$I_{max.}$ [A]	$U_{max.}$ [V]	max. Ø [mm ²] AWG (UL)
		15	320	0.5 - 2.5 -
		IEC	UL / CUL	CSA Ex
		320	-	-
Rated voltage [V]		15	-/-	-/-
Nominal current / cross section [A] / [mm ²]		2.5	-	-
Rated cross section [mm ²]		20 - 14	-	-
Cross section range AWG		Rigid	Flexible	Ferrule without/with plastic sleeve
Connection capacity		0.5 - 2.5	0.5 - 2.5	-
1 conductor [mm ²]		-	-	-
2 conductors (of the same type) [mm ²]		-	-	-
General data		Stripping length [mm]		
		-		

ERC

Technical data¹⁾

Dimensions		Width	Length	Height
		74.4	45.4	34.3
[mm]				
Maximum electrical data		$I_{max.}$ [A]	$U_{max.}$ [V]	max. Ø [mm ²] AWG (UL)
		15	320	0.14 - 6 -
		IEC	UL / CUL	CSA Ex
		320	-	-
Rated voltage [V]		15	-/-	-/-
Nominal current / cross section [A] / [mm ²]		6	-	-
Rated cross section [mm ²]		26 - 10	-	-
Cross section range AWG		Rigid	Flexible	Ferrule without/with plastic sleeve
Connection capacity		0.14 - 6	0.14 - 6	0.25 - 4 0.25 - 4
1 conductor [mm ²]		0.14 - 1.5	0.14 - 1.5	0.25 - 1.5 -
2 conductors (of the same type) [mm ²]		-	-	-
General data		Stripping length [mm]		
		8 - 9		

Ordering data

Description	No. of pos.	Color
PCB connector, with screw flange covers	8	gray
Short-circuit plug, for four current transformers	10	gray
Plug, for four voltage transducers	8	gray
Short-circuit plug, for four current transformers, bolt connection	10	gray
Plug, for four voltage transducers, bolt connection	10	gray

Type	Order No.	Pcs./Pkt.
FC 4-PCB/8	① 3208694	10
FC 4-PCB/10	① 3208736	10

Ordering data

Type	Order No.	Pcs./Pkt.
UP 4-4CT	① 3208720	10
UP 4-4VT	② 3208721	10
BP 4-5CT	① 3208733	10
BP 4-5VT	② 3208734	10

COMBI connectors

Notes:
1) For additional accessories and technical data, see page 328.
2) For derating curve, visit phoenixcontact.net/products



32 A, connector, connection at a right angle to the plug-in direction

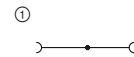

32 A, connector, connection at a right angle to the plug-in direction, for self-assembly



Technical data ¹⁾				
Dimensions	Width	Length	Height	Height plugged
	6.2 x No. of pos.	22	48.5	32.2
Maximum electrical data	I _{max.} [A]	U _{max.} [V]	max. Ø [mm ²]	AWG (UL)
	32	800	0.14 - 6	26-10
	32 (FBS) / 24 (FBSR)			
Rated data	IEC	UL / CUL	CSA	Ex
Maximum bridge current	800	600	600	-
Rated voltage	32 / 4	30 / -	30 / -	- / -
Nominal current / cross section				
Connection capacity	Rigid	Flexible	Ferrule without/with plastic sleeve	
2 flexible conductors with a TWIN ferrule	-	-	-	0.5 - 1



Technical data ¹⁾				
Dimensions	Width	Length	Height	Height plugged
	6.2 x No. of pos.	22	48.5	32.2
Maximum electrical data	I _{max.} [A]	U _{max.} [V]	max. Ø [mm ²]	AWG (UL)
	32 ²⁾	800	0.14 - 6	26-10
	32 (FBS) / 24 (FBSR)			
Rated data	IEC	UL / CUL	CSA	Ex
Maximum bridge current	800	600	600	-
Rated voltage	32 ²⁾ / 4	30 / -	30 / -	- / -
Nominal current / cross section				
Connection capacity	Rigid	Flexible	Ferrule without/with plastic sleeve	
2 flexible conductors with a TWIN ferrule	-	-	-	0.5 - 1

Ordering data						
Description	No. of pos.	Width	Color	Type	Order No.	Pcs./Pkt.
Connector	1	6.2 mm	gray	UPBV 4/ 1	3045800	50
	2	12.4 mm	gray	UPBV 4/ 2	3045813	50
	3	18.6 mm	gray	UPBV 4/ 3	3045826	50
	4	24.8 mm	gray	UPBV 4/ 4	3045839	50
	5	31 mm	gray	UPBV 4/ 5	3045842	50
	6	37.2 mm	gray	UPBV 4/ 6	3045855	25
	7	43.4 mm	gray	UPBV 4/ 7	3045868	25
	8	49.6 mm	gray	UPBV 4/ 8	3045871	25
	9	55.8 mm	gray	UPBV 4/ 9	3045884	25
	10	62 mm	gray	UPBV 4/10	3045897	25
	11	68.2 mm	gray	UPBV 4/11	3045907	10
	12	74.4 mm	gray	UPBV 4/12	3045910	10
	13	80.6 mm	gray	UPBV 4/13	3045923	10
	14	86.8 mm	gray	UPBV 4/14	3045936	10
	15	93 mm	gray	UPBV 4/15	3045949	10
Connector, left element	1	6.2 mm	green-yellow	UPBV 4/ 1 BU	3045266	50
	1	6.2 mm	gray	UPBV 4/ 1 GNYE	3045279	50
Connector, center element	1	6.2 mm	blue			
	1	6.2 mm	green-yellow			
Connector, right element	1	6.2 mm	blue			
	1	6.2 mm	green-yellow			

Ordering data			
Type	Order No.	Pcs./Pkt.	
UPBV 4/ 1-L	3045716	50	
UPBV 4/ 1-L BU	3045729	50	
UPBV 4/ 1-L GNYE	3045732	50	
UPBV 4/ 1-M	3045745	50	
UPBV 4/ 1-M BU	3045758	50	
UPBV 4/ 1-M GNYE	3045761	50	
UPBV 4/ 1-R	3045774	50	
UPBV 4/ 1-R BU	3045787	50	
UPBV 4/ 1-R GNYE	3045790	50	

Accessories ¹⁾			
Strain relief, for UPBV... plugs, 2-pos.	UPZ/ 2	3045554	50
Latching, for UPBV plugs, 2-pos.	UPR/ 2	3045567	50
Latching and strain relief systems, for UPBV... plugs, 2-pos.	UPRZ	3045570	50
Screw flange cover, for UPBV 2,5 and UPBV 4 COMBI plugs	DF-UPBV 2,5/ 4	3060432	50

Accessories ¹⁾			
Strain relief, for UPBV... plugs, 2-pos.	UPZ/ 2	3045554	50
Latching, for UPBV plugs, 2-pos.	UPR/ 2	3045567	50
Latching and strain relief systems, for UPBV... plugs, 2-pos.	UPRZ	3045570	50
Screw flange cover, for UPBV 2,5 and UPBV 4 COMBI plugs	DF-UPBV 2,5/ 4	3060432	50

Terminal blocks – CLIPLINE complete

4 mm² COMBI UT plug-in connection solutions

COMBI connectors

Notes:
1) For additional accessories and technical data, see page 328.
2) For derating curve, visit phoenixcontact.net/products



32 A, connector, connection in plug-in direction

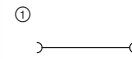

32 A, connector, connection in plug-in direction, for self-assembly



Dimensions	
	[mm]
Maximum electrical data	
Rated data	
Rated voltage	[V]
Nominal current / cross section	[A] / [mm ²]
Cross section range	AWG
Connection capacity	
1 conductor	[mm ²]
2 conductors (of the same type)	[mm ²]
2 flexible conductors with a TWIN ferrule	[mm ²]

Technical data ¹⁾			
Width	Length	Height	Height plugged
6.2 x No. of pos.	21	41.2	24.8
I _{max.} [A]	U _{max.} [V]	max. Ø [mm ²]	AWG (UL)
32 ²⁾	800	0.2 - 6	26-10
IEC	UL / CUL	CSA	Ex
800	600	600	-
32 ²⁾ / 4	30 / -	30 / -	- / -
24 - 10	-	-	-
Rigid	Flexible	Ferrule without/with plastic sleeve	
0.2 - 6	0.2 - 6	0.25 - 4	0.25 - 4
0.2 - 1.5	0.2 - 1.5	0.25 - 1.5	-
-	-	-	0.5 - 1.5

Technical data ¹⁾			
Width	Length	Height	Height plugged
6.2 x No. of pos.	21	41.2	24.8
I _{max.} [A]	U _{max.} [V]	max. Ø [mm ²]	AWG (UL)
32 ²⁾	800	0.2 - 6	26-10
IEC	UL / CUL	CSA	Ex
800	600	600	-
32 ²⁾ / 4	30 / -	30 / -	- / -
24 - 10	-	-	-
Rigid	Flexible	Ferrule without/with plastic sleeve	
0.2 - 6	0.2 - 6	0.25 - 4	0.25 - 4
0.2 - 1.5	0.2 - 1.5	0.25 - 1.5	-
-	-	-	0.5 - 1.5

Description	No. of pos.	Width	Color
Connector	1	6.2 mm	gray
	2	12.4 mm	gray
	3	18.6 mm	gray
	4	24.8 mm	gray
	5	31 mm	gray
	6	37.2 mm	gray
	7	43.4 mm	gray
	8	49.6 mm	gray
	9	55.8 mm	gray
	10	62 mm	gray
	11	68.2 mm	gray
	12	74.4 mm	gray
	13	80.6 mm	gray
	14	86.8 mm	gray
	15	93 mm	gray
Connector, left element	1	6.2 mm	blue
	1	6.2 mm	green-yellow
Connector, center element	1	6.2 mm	gray
	1	6.2 mm	blue
Connector, right element	1	6.2 mm	green-yellow
	1	6.2 mm	gray
	1	6.2 mm	blue
	1	6.2 mm	green-yellow

Ordering data		
Type	Order No.	Pcs./Pkt.
UP 4/ 1	① 3060115	50
UP 4/ 2	① 3060128	50
UP 4/ 3	① 3060131	50
UP 4/ 4	① 3060144	50
UP 4/ 5	① 3060157	50
UP 4/ 6	① 3060160	25
UP 4/ 7	① 3060173	25
UP 4/ 8	① 3060186	25
UP 4/ 9	① 3060199	25
UP 4/10	① 3060209	25
UP 4/11	① 3060212	10
UP 4/12	① 3060225	10
UP 4/13	① 3060238	10
UP 4/14	① 3060241	10
UP 4/15	① 3060254	10
UP 4/ 1 BU	① 3045282	50
UP 4/ 1 GNYE	① 3045295	50

Ordering data		
Type	Order No.	Pcs./Pkt.
UP 4/ 1-L	① 3060021	50
UP 4/ 1-L BU	① 3060034	50
UP 4/ 1-L GNYE	① 3060047	50
UP 4/ 1-M	① 3060050	50
UP 4/ 1-M BU	① 3060063	50
UP 4/ 1-M GNYE	① 3060076	50
UP 4/ 1-R	① 3060089	50
UP 4/ 1-R BU	① 3060092	50
UP 4/ 1-R GNYE	① 3060102	50

Accessories ¹⁾	
Strain relief , for plugs, 2-pos.	black
Latching , for connectors, 1-pos.	orange
Latching and strain relief systems , for all plugs with conductor exit at top, 2-pos.	orange
Screw flange cover , for UP 4 COMBI plug	gray

Accessories ¹⁾		
	Order No.	Pcs./Pkt.
PZ/2	3040627	50
PR	3040559	50
PR/2	3040630	50
PRZ	3040614	50
DF-UP 4	3060348	50

Accessories ¹⁾		
	Order No.	Pcs./Pkt.
PZ/2	3040627	50
PR	3040559	50
PR/2	3040630	50
PRZ	3040614	50
DF-UP 4	3060348	50

Terminal blocks – CLIPLINE complete

4 mm² COMBI ST plug-in connection solutions

General technical data

Rated data		IEC 61984
Rated cross section	[mm ²]	4
Cross section range	AWG	28 - 10
Connection capacity		Rigid Flexible Ferrule without/with plastic sleeve
1 conductor	[mm ²]	0.08 - 6 0.08 - 4 0.14 - 4 0.14 - 4
2 flexible conductors with a TWIN ferrule	[mm ²]	- - - 0.5 - 1
General data		
Stripping length	[mm]	8 - 10
Insulating material		PA
Flammability rating in accordance with UL 94		VO

Note: Additional or deviating data is listed alongside the respective product.

Notes:



In addition to the product, the internal electrical wiring is provided as a circuit diagram. Free connection points for bridging are indicated by a black dot.

The specified technical data and approvals refer to the first product in each column. For information on the products below, please refer to phoenixcontact.net/products

For full details of UL and CSA use groups, file nos., and Internet links, please visit phoenixcontact.net/products

¹⁾ The bridge current is listed alongside the respective product. For additional colors, see page 402.

System accessories

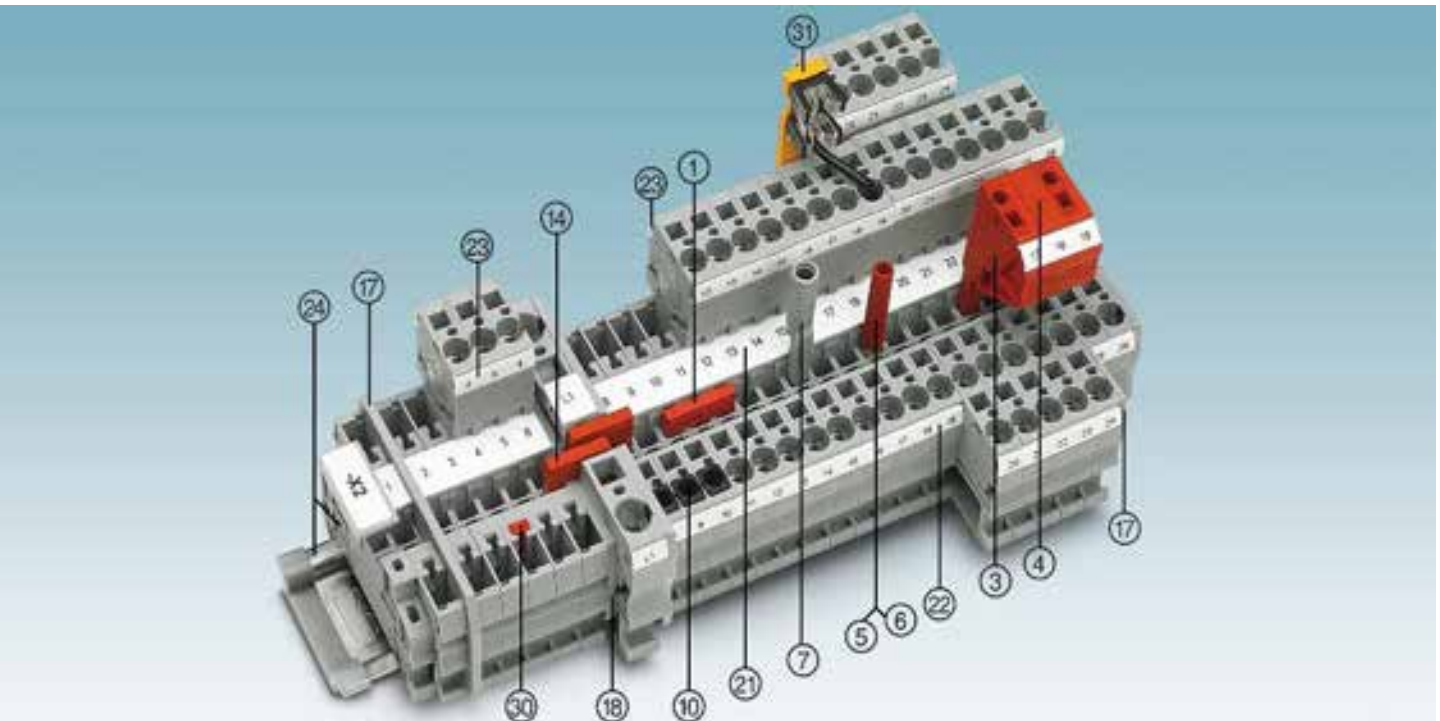

Description	No. of pos.	Color	Type	Order No.	Pcs./Pkt.	Type	Order No.	Pcs./Pkt.
① Bridge ¹⁾	2	red	FBS 2-6	3030336	50	FBSR 2-6	3033715	50
	3	red	FBS 3-6	3030242	50	FBSR 3-6	3001594	50
	4	red	FBS 4-6	3030255	50	FBSR 4-6	3001595	50
	5	red	FBS 5-6	3030349	50	FBSR 5-6	3001596	50
	10	red	FBS 10-6	3030271	10	FBSR 10-6	3033716	10
	20	red	FBS 20-6	3030365	10			
③ Modular test plug		red	PS-6	3030996	10			
④ Spacer plate		red	DP PS-6	3036738	10			
⑤ Test plug metal part		gray	MPS-MT	0201744	10			
⑥ Insulating sleeve, for MPS metal part		red	MPS-IH RD	0201676	10			
⑦ Test adapter, 4 mm socket hole		gray	PAI-4-N GY	3032871	10			
⑩ Insulating sleeve, 0.25 - 0.5 mm ²		gray	ISH 4/0,5	3002885	50			
0.75 - 1 mm ²		black	ISH 4/1,0	3002898	50			
⑳ Coding profile		red	PC	3040588	50			
Screwdriver			SZF 1-0,6X3,5	1204517	10			

⑭ Reducing bridge	For RB ..., see page 408.
⑰ Partition plates/end cover segments	For ATP-... / DS-..., visit phoenixcontact.net/products
⑱ Cover	Listed alongside the respective product.
⑲ Center groove labeling	UC-TM 6, UCT-TM 6 or ZB 6. See also Catalog 3, selection tables, from page 60.
⑲ Center and side groove labeling	UC-TMF 6, UCT-TMF 6 or ZBF 6. See also Catalog 3, selection tables, from page 60.
⑲ Lateral groove labeling	UC-TMF 6, UCT-TMF 6 or ZBF 6. See also Catalog 3, selection tables, from page 60.
⑲ DIN rail and end bracket	See Catalog 3
⑲ Latching, strain relief, shielding	See from page 362.
For full accessories, visit phoenixcontact.net/products	Note: Additional or deviating accessories are listed alongside the respective product.

Feed-through, multi-conductor, and ground terminal blocks

Notes:

- 1) For additional accessories and technical data, see page 338.
- 2) For derating curve, visit phoenixcontact.net/products

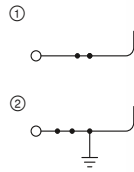

32 A, feed-through terminal block



Technical data ¹⁾				
Dimensions	Width	Length	Height	
[mm]	6.2	55.8	36.5 (NS 35/7,5)	
Maximum electrical data	I_{max} [A]	U_{max} [V]	max. Ø [mm ²]	AWG (UL)
	32 ²⁾	800	0.08 - 6	28-10
Maximum bridge current	32 (FBS) / 24 (FBSR)			
Rated data	IEC	UL / CUL	CSA	Ex
Rated voltage	800	600	600	-
Nominal current / cross section	32 ²⁾ / 4			

Ordering data			
Description	Type	Order No.	Pcs./Pkt.
Terminal block	ST 4/ 1P	① 3042719	50
	ST 4/ 1P BU	① 3042874	50
Ground terminal	ST 4/ 1P-PE	② 3042722	50

Accessories ¹⁾		
Description	Type	Order No.
Cover, width: 2.2 mm	D-ST 4	3030420

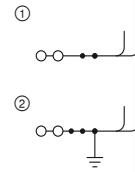

32 A, feed-through terminal block, 4 connections



Technical data ¹⁾				
Dimensions	Width	Length	Height	
[mm]	6.2	97.3	36.5 (NS 35/7,5)	
Maximum electrical data	I_{max} [A]	U_{max} [V]	max. Ø [mm ²]	AWG (UL)
	32 ²⁾	800	0.08 - 6	28-10
Maximum bridge current	32 (FBS) / 24 (FBSR)			
Rated data	IEC	UL / CUL	CSA	Ex
Rated voltage	800	600	600	-
Nominal current / cross section	32 ²⁾ / 4			

Ordering data			
Description	Type	Order No.	Pcs./Pkt.
Terminal block	ST 4-QUATTRO/2P	① 3042845	50
	ST 4-QUATTRO/2P BU	① 3042861	50
Ground terminal	ST 4-QUATTRO/2P-PE	② 3042858	50

Accessories ¹⁾		
Description	Type	Order No.
Cover, width: 2.2 mm	D-ST 4-QUATTRO/2P	3043747

Feed-through, multi-conductor, and ground terminal blocks

Notes:

- 1) For additional accessories and technical data, see page 338.
- 2) For derating curve, visit phoenixcontact.net/products

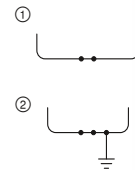

32 A, feed-through terminal block



Dimensions	
Width	6.2
Length	55.9
Height	36.5 (NS 35/7,5)

Maximum electrical data			
I_{max} [A]	32 ²⁾	U_{max} [V]	800
max. Ø [mm ²]	0.08 - 6	AWG (UL)	-
32 (FBS) / 24 (FBSR)			

Rated data			
IEC	UL / CUL	CSA	Ex
800	-	600	-
32 ²⁾ / 4			

Ordering data			
Description	Type	Order No.	Pcs./Pkt.
Terminal block	ST 4/ 2P	① 3042735	50
	ST 4/ 2P BU	① 3043789	50
Ground terminal	ST 4/ 2P-PE	② 3042748	50

Accessories ¹⁾		
Description	Type	Order No.
Cover, width: 2.2 mm	D-ST 4	3030420

Technical data ¹⁾				
Dimensions	Width	Length	Height	
[mm]	6.2	55.9	36.5 (NS 35/7,5)	
Maximum electrical data	I_{max} [A]	U_{max} [V]	max. Ø [mm ²]	AWG (UL)
	32 ²⁾	800	0.08 - 6	-
Maximum bridge current	32 (FBS) / 24 (FBSR)			
Rated data	IEC	UL / CUL	CSA	Ex
Rated voltage	800	-	600	-
Nominal current / cross section	32 ²⁾ / 4			

Ordering data			
Description	Type	Order No.	Pcs./Pkt.
Terminal block	ST 4/ 2P	① 3042735	50
	ST 4/ 2P BU	① 3043789	50
Ground terminal	ST 4/ 2P-PE	② 3042748	50

Accessories ¹⁾		
Description	Type	Order No.
Cover, width: 2.2 mm	D-ST 4	3030420

Terminal blocks – CLIPLINE complete

4 mm² COMBI ST plug-in connection solutions

Feed-through and multi-conductor terminal blocks

- This plug-in basic terminal block can be fitted with 4 mm² COMBI connectors as well as crimp contacts in the CP 4/6 connector housing
- Conductors with crimped on STG-MTN ... module socket contacts can be easily snapped into the CP 4/6 connector housing

Notes:
1) For additional accessories and technical data, see page 338.
2) For derating curve, visit phoenixcontact.net/products



32 A, feed-through terminal block, 4 connections



Dimensions	
	[mm]
Maximum electrical data	
Maximum bridge current	[A]
Rated data	
Rated voltage	[V]
Nominal current / cross section	[A] / [mm ²]
Cross section range	AWG
Connection capacity	
1 conductor	[mm ²]

Technical data ¹⁾			
Width	Length	Height	
6.2	95.9	36.8 (NS 35/7,5)	
I_{max} [A]	U_{max} [V]	max. \varnothing [mm ²]	AWG (UL)
32²⁾	500	0.08 - 4	28-10
32 (FBS) / 24 (FBSR)			
IEC	UL / CUL	CSA	Ex
500	600	600	-
Nominal current / cross section			
32 ²⁾ / 4	30 / -	30 / -	- / -
Cross section range			
28 - 12	-	-	-
Connection capacity		Ferrule	
Rigid	Flexible	without/with plastic sleeve	
0.08 - 4	0.08 - 4	-	-

Description	Color
Terminal block	gray
Cover, width: 2.2 mm	gray
Module socket contact	
for wires from 0.5 ... 1.0 mm ²	silver
for wires from 1.5 ... 2.5 mm ²	silver

Ordering data		
Type	Order No.	Pcs./Pkt.
ST 4-QUATTRO/4CP	3042736	50

Accessories ¹⁾		
Type	Order No.	Pcs./Pkt.
D-ST 4-QUATTRO/4CP	3042739	10
STG-MTN 0,5-1,0	3190438	100
STG-MTN 1,5-2,5	3190506	100

Couplings

Notes:
1) For additional accessories and technical data, see page 338.
2) For derating curve, visit phoenixcontact.net/products



32 A, coupling

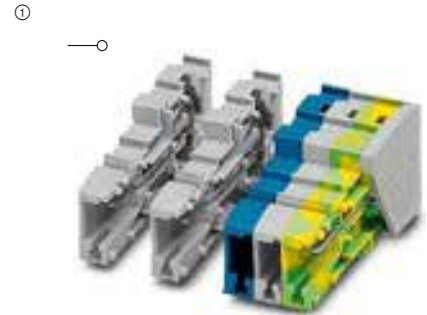

32 A, coupling, for self-assembly



Technical data ¹⁾			
Dimensions	Width [mm]	Length	Height
6.2 x No. of pos.	6.2	48.6	22.3
Maximum electrical data	I _{max.} [A]	U _{max.} [V]	max. Ø [mm ²] AWG (UL)
32	800	0.08 - 6	28-10
Rated data	IEC	UL / CUL	CSA Ex
Rated voltage [V]	800	600	-
Nominal current / cross section [A] / [mm ²]	32 / 4	30 / -	- / -

Ordering data			
Description	No. of pos.	Color	Type
COMBI coupling	2	gray	SC 4/ 2
	3	gray	SC 4/ 3
	4	gray	SC 4/ 4
	5	gray	SC 4/ 5
	6	gray	SC 4/ 6
	7	gray	SC 4/ 7
	8	gray	SC 4/ 8
	9	gray	SC 4/ 9
	10	gray	SC 4/10
	11	gray	SC 4/11
	12	gray	SC 4/12
	13	gray	SC 4/13
	14	gray	SC 4/14
	15	gray	SC 4/15
	COMBI coupling, for self-assembly	1	gray
1		blue	
1		green-yellow	

Accessories ¹⁾		
Accessories	Order No.	Pcs./Pkt.
MPS-MT	0201744	10
MPS-IH RD	0201676	10
CZ/2	3043831	50
PC	3040588	50



Technical data ¹⁾			
Dimensions	Width [mm]	Length	Height
6.2 x No. of pos.	6.2	48.6	22.3
Maximum electrical data	I _{max.} [A]	U _{max.} [V]	max. Ø [mm ²] AWG (UL)
32 ²⁾	800	0.08 - 6	28-10
Rated data	IEC	UL / CUL	CSA Ex
Rated voltage [V]	800	600	-
Nominal current / cross section [A] / [mm ²]	32 ²⁾ / 4	30 / -	- / -

Ordering data		
Type	Order No.	Pcs./Pkt.
SC 4/ 1-L	3042599	50
SC 4/ 1-L BU	3042609	50
SC 4/ 1-L GNYE	3042612	50

Accessories ¹⁾		
Accessories	Order No.	Pcs./Pkt.
MPS-MT	0201744	10
MPS-IH RD	0201676	10
D-SC 4	3043307	50
CZ/2	3043831	50
PC	3040588	50

Test plug metal part, 2.3 mm Ø	gray
Insulating sleeve, for MPS metal part	red
Cover, 3.2 mm width	gray
Strain relief, for SC 4... receptacle, 2-pos.	black
Coding star, with 4 coding branches, can be inserted in all basic terminal blocks	red

Terminal blocks – CLIPLINE complete

4 mm² COMBI ST plug-in connection solutions

Couplings

Notes:
1) For additional accessories and technical data, see page 338.
2) For derating curve, visit phoenixcontact.net/products



32 A, coupling with securing pin

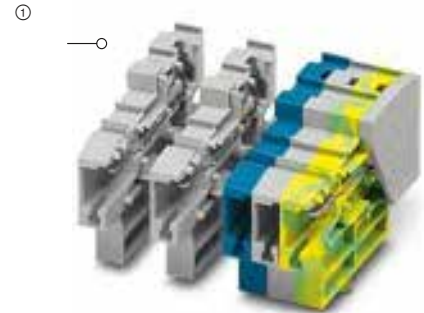

32 A, coupling with securing pin, for self-assembly



Technical data ¹⁾			
Width	Length	Height	
6.2 x No. of pos.	48.6	31	
I _{max.} [A]	U _{max.} [V]	max. Ø [mm ²]	AWG (UL)
32	800	0.08 - 6	28-10
IEC	UL / CUL	CSA	Ex
800	600	-	-
Nominal current / cross section	[A] / [mm ²]	32 / 4	30 / -

Ordering data			
Description	No. of pos.	Color	Type
COMBI coupling, with securing pin	2	gray	SC 4-RZ/ 2
	3	gray	SC 4-RZ/ 3
	4	gray	SC 4-RZ/ 4
	5	gray	SC 4-RZ/ 5
	6	gray	SC 4-RZ/ 6
	7	gray	SC 4-RZ/ 7
	8	gray	SC 4-RZ/ 8
	9	gray	SC 4-RZ/ 9
	10	gray	SC 4-RZ/10
	11	gray	SC 4-RZ/11
	12	gray	SC 4-RZ/12
	13	gray	SC 4-RZ/13
	14	gray	SC 4-RZ/14
	15	gray	SC 4-RZ/15
COMBI coupling, with securing pin, for self-assembly	1	gray	
	1	blue	
	1	green-yellow	

Accessories ¹⁾		
MPS-MT	0201744	10
MPS-IH RD	0201676	10
CZ/2	3043831	50
PC	3040588	50



Technical data ¹⁾			
Width	Length	Height	
6.2 x No. of pos.	48.6	31	
I _{max.} [A]	U _{max.} [V]	max. Ø [mm ²]	AWG (UL)
32 ²⁾	800	0.08 - 6	28-10
IEC	UL / CUL	CSA	Ex
800	600	-	-
Nominal current / cross section	[A] / [mm ²]	32 ²⁾ / 4	30 / -

Ordering data		
Type	Order No.	Pcs./Pkt.
SC 4-RZ/ 1-L	3043378	50
SC 4-RZ/ 1-L BU	3043381	50
SC 4-RZ/ 1-L GNYE	3043394	50

Accessories ¹⁾		
MPS-MT	0201744	10
MPS-IH RD	0201676	10
D-SC 4	3043307	50
CZ/2	3043831	50
PC	3040588	50

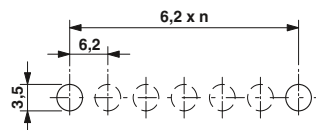

Drilling plan example: 1 x SC 4-RZ/ 6

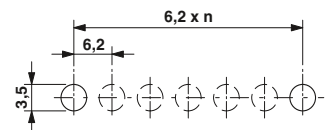

Drilling plan example: 6 x SC 4-RZ/ 1-L

Couplings

Notes:
 1) For additional accessories and technical data, see page 338.
 2) For derating curve, visit phoenixcontact.net/products

①



32 A, coupling for DIN rail mounting



Panel feed-through

ERC

Technical data ¹⁾			
Width	Length	Height	
6.2	48.6	35.6 (NS 35/7,5) / 35.6 (NS 15)	
I _{max.} [A]	U _{max.} [V]	max. Ø [mm ²]	AWG (UL)
32 ²⁾	800	0.08 - 6	28-10
IEC	UL / CUL	CSA	Ex
800	600	-	-
Nominal current / cross section	[A] / [mm ²]	32 ²⁾ / 4	30 / -

Ordering data			
Type	Order No.	Pcs./Pkt.	
SC 4-NS/ 1-L	3043404	50	

Accessories ¹⁾			
Type	Order No.	Pcs./Pkt.	
D-SC 4	3043307	50	

Dimensions	[mm]
Maximum electrical data	
Rated data	
Rated voltage	[V]
Nominal current / cross section	[A] / [mm ²]
Description	Color
COMBI coupling	gray
Panel feed-through , for snapping on to receptacles, 1 SSL 2.5 consists of a left-hand and a right-hand element, for metal thicknesses of 0.8 - 3 mm	gray
Cover , 3.2 mm width	gray
Coding star , with 4 coding branches, can be inserted in all basic terminal blocks	red

ERC

Technical data ¹⁾			
Width	Length	Height	
5.2	-	max. Ø [mm ²]	
			AWG (UL)
			-
IEC	UL / CUL	CSA	Ex
-	-	-	-
-	- / -	- / -	- / -

Ordering data			
Type	Order No.	Pcs./Pkt.	
SSL 2,5	3043815	50	

Accessories ¹⁾			
Type	Order No.	Pcs./Pkt.	
PC	3040588	50	

Terminal blocks – CLIPLINE complete

4 mm² COMBI ST plug-in connection solutions

COMBI headers for PCB connection

Notes:

For additional accessories and technical data, see page 364 or visit phoenixcontact.net/products



32 A, header, horizontal plug-in direction



32 A, header, vertical plug-in direction



Technical data

Dimensions	Width	Length	Height
	14.45	25.1	29.45
Maximum electrical data	$I_{max.}$ [A]		max. \varnothing [mm ²] AWG (UL)
	32		-
Rated data	IEC	UL	CSA IEC/EN 60079-7
Rated voltage [V]	-	600	-
Nominal current / cross section [A] / [mm ²]	32 / 4	20 / -	-
Rated cross section [mm ²]	4	-	-
General data	Insulating material PA		
Flammability rating in accordance with UL 94	V0		



Technical data

Dimensions	Width	Length	Height
	12.4	26	25.1
Maximum electrical data	$I_{max.}$ [A]		max. \varnothing [mm ²] AWG (UL)
	32		-
Rated data	IEC	UL	CSA IEC/EN 60079-7
Rated voltage [V]	-	600	-
Nominal current / cross section [A] / [mm ²]	32 / 4	20 / -	-
Rated cross section [mm ²]	4	-	-
General data	Insulating material PA		
Flammability rating in accordance with UL 94	V0		

Ordering data

Description	No. of pos.	Width	Color	Type	Order No.	Pcs./Pkt.
COMBI header	2	14.45 mm	gray	ST 4-PCB/ 2-G-6,2	1980598	50
	3	20.65 mm	gray	ST 4-PCB/ 3-G-6,2	1980608	50
	4	26.85 mm	gray	ST 4-PCB/ 4-G-6,2	1980611	50
	5	33.05 mm	gray	ST 4-PCB/ 5-G-6,2	1980624	50
	6	39.25 mm	gray	ST 4-PCB/ 6-G-6,2	1980637	50
	7	45.45 mm	gray	ST 4-PCB/ 7-G-6,2	1980640	50
	8	51.65 mm	gray	ST 4-PCB/ 8-G-6,2	1980653	50
	9	57.85 mm	gray	ST 4-PCB/ 9-G-6,2	1980666	50
	10	64.05 mm	gray	ST 4-PCB/10-G-6,2	1980679	50
	11	70.25 mm	gray	ST 4-PCB/11-G-6,2	1980682	50
	12	76.45 mm	gray	ST 4-PCB/12-G-6,2	1980695	50
	COMBI header	2	12.4 mm	gray		
3		18.6 mm	gray			
4		24.8 mm	gray			
5		31 mm	gray			
6		37.2 mm	gray			
7		43.4 mm	gray			
8		49.6 mm	gray			
9		55.8 mm	gray			
10		62 mm	gray			
11		68.2 mm	gray			
12		74.4 mm	gray			

Ordering data

Description	No. of pos.	Width	Color	Type	Order No.	Pcs./Pkt.
COMBI header	2	12.4 mm	gray	ST 4-PCBV/ 2-G-6,2	1980705	50
	3	18.6 mm	gray	ST 4-PCBV/ 3-G-6,2	1980718	50
	4	24.8 mm	gray	ST 4-PCBV/ 4-G-6,2	1980721	50
	5	31 mm	gray	ST 4-PCBV/ 5-G-6,2	1980734	50
	6	37.2 mm	gray	ST 4-PCBV/ 6-G-6,2	1980747	50
	7	43.4 mm	gray	ST 4-PCBV/ 7-G-6,2	1980750	50
	8	49.6 mm	gray	ST 4-PCBV/ 8-G-6,2	1980763	50
	9	55.8 mm	gray	ST 4-PCBV/ 9-G-6,2	1980776	50
	10	62 mm	gray	ST 4-PCBV/10-G-6,2	1980789	50
	11	68.2 mm	gray	ST 4-PCBV/11-G-6,2	1980792	50
	12	74.4 mm	gray	ST 4-PCBV/12-G-6,2	1980802	50

COMBI connectors

Notes:
1) For additional accessories and technical data, see page 338.
2) For derating curve, visit phoenixcontact.net/products



32 A, connector, connection in plug-in direction

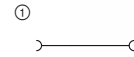

32 A, connector, connection in plug-in direction, for self-assembly



Technical data ¹⁾				
Dimensions	Width	Length	Height	Height plugged
	6.2 x No. of pos.	21	41.5	24
Maximum electrical data	I _{max.} [A]	U _{max.} [V]	max. Ø [mm ²]	AWG (UL)
	32	800	0.08 - 6	28-10
Rated data	IEC	UL / CUL	CSA	Ex
Rated voltage	800	600	600	-
Nominal current / cross section	32 / 4	30 / -	30 / -	- / -

Ordering data			
Description	No. of pos.	Width	Color
COMBI connectors	1	6.2 mm	gray
	2	12.4 mm	gray
	3	18.6 mm	gray
	4	24.8 mm	gray
	5	31 mm	gray
	6	37.2 mm	gray
	7	43.4 mm	gray
	8	49.6 mm	gray
	9	55.8 mm	gray
	10	62 mm	gray
	11	68.2 mm	gray
	12	74.4 mm	gray
	13	80.6 mm	gray
	14	86.8 mm	gray
	15	93 mm	gray
COMBI connector, left element	1	6.2 mm	blue
	1	6.2 mm	green-yellow
COMBI connector, center element	1	6.2 mm	gray
	1	6.2 mm	blue
	1	6.2 mm	green-yellow
COMBI connector, right element	1	6.2 mm	gray
	1	6.2 mm	blue
	1	6.2 mm	green-yellow

Accessories ¹⁾				
Test plug metal part, 2.3 mm Ø	gray	MPS-MT	0201744	10
Insulating sleeve, for MPS metal part	red	MPS-IH RD	0201676	10
Latching and strain relief systems, for all plugs with conductor exit at top, 2-pos.	orange	PRZ	3040614	50
Latching, for connectors, 1-pos.	orange	PR	3040559	50
2-pos.	orange	PR/2	3040630	50
Strain relief, for plugs, 2-pos.	black	PZ/2	3040627	50



Technical data ¹⁾				
Dimensions	Width	Length	Height	Height plugged
	6.2 x No. of pos.	21	41.5	24
Maximum electrical data	I _{max.} [A]	U _{max.} [V]	max. Ø [mm ²]	AWG (UL)
	32 ²⁾	800	0.08 - 6	28-10
Rated data	IEC	UL / CUL	CSA	Ex
Rated voltage	800	600	600	-
Nominal current / cross section	32 ²⁾ / 4	30 / -	30 / -	- / -

Ordering data			
Type	Order No.	Pcs./Pkt.	
SP 4/ 1	3042887	50	
SP 4/ 2	3042890	50	
SP 4/ 3	3042900	50	
SP 4/ 4	3042926	50	
SP 4/ 5	3042939	50	
SP 4/ 6	3042942	25	
SP 4/ 7	3042955	25	
SP 4/ 8	3042968	25	
SP 4/ 9	3042971	25	
SP 4/10	3042984	25	
SP 4/11	3042997	10	
SP 4/12	3043006	10	
SP 4/13	3043718	10	
SP 4/14	3043721	10	
SP 4/15	3043734	10	
SP 4/1 BU	3061033	50	
SP 4/1 GNYE	3061046	50	
SP 4/ 1-L	3042751	50	
SP 4/ 1-L BU	3042764	50	
SP 4/ 1-L GNYE	3042777	50	
SP 4/ 1-M	3042780	50	
SP 4/ 1-M BU	3042793	50	
SP 4/ 1-M GNYE	3042803	50	
SP 4/ 1-R	3042816	50	
SP 4/ 1-R BU	3042829	50	
SP 4/ 1-R GNYE	3042832	50	

Accessories ¹⁾				
Test plug metal part, 2.3 mm Ø	gray	MPS-MT	0201744	10
Insulating sleeve, for MPS metal part	red	MPS-IH RD	0201676	10
Latching and strain relief systems, for all plugs with conductor exit at top, 2-pos.	orange	PRZ	3040614	50
Latching, for connectors, 1-pos.	orange	PR	3040559	50
2-pos.	orange	PR/2	3040630	50
Strain relief, for plugs, 2-pos.	black	PZ/2	3040627	50

Terminal blocks – CLIPLINE complete

6 mm² COMBI PT plug-in connection solutions

General technical data

Rated data		IEC 61984			
Rated cross section	[mm ²]	6			
Cross section range	AWG	20 - 8			
Connection capacity		Rigid	Flexible	Ferrule without/with plastic sleeve	
1 conductor	[mm ²]	0.5 - 10	0.5 - 6	0.5 - 6	0.5 - 6
2 flexible conductors with a TWIN ferrule	[mm ²]	-	-	-	0.5 - 1.5
Connection cross sections directly plug-in	[mm ²]	1 - 10	-	1 - 6	1 - 6
General data					
Stripping length	[mm]	12			
Insulating material		PA			
Flammability rating in accordance with UL 94		V0			
Note: Additional or deviating data is listed alongside the respective product.					

Notes:



In addition to the product, the internal electrical wiring is provided as a circuit diagram. Free connection points for bridging are indicated by a black dot.

The specified technical data and approvals refer to the first product in each column. For information on the products below, please refer to phoenixcontact.net/products

For full details of UL and CSA use groups, file nos., and Internet links, please visit phoenixcontact.net/products

¹⁾ The bridge current is listed alongside the respective product. For additional colors, see page 402.

System accessories

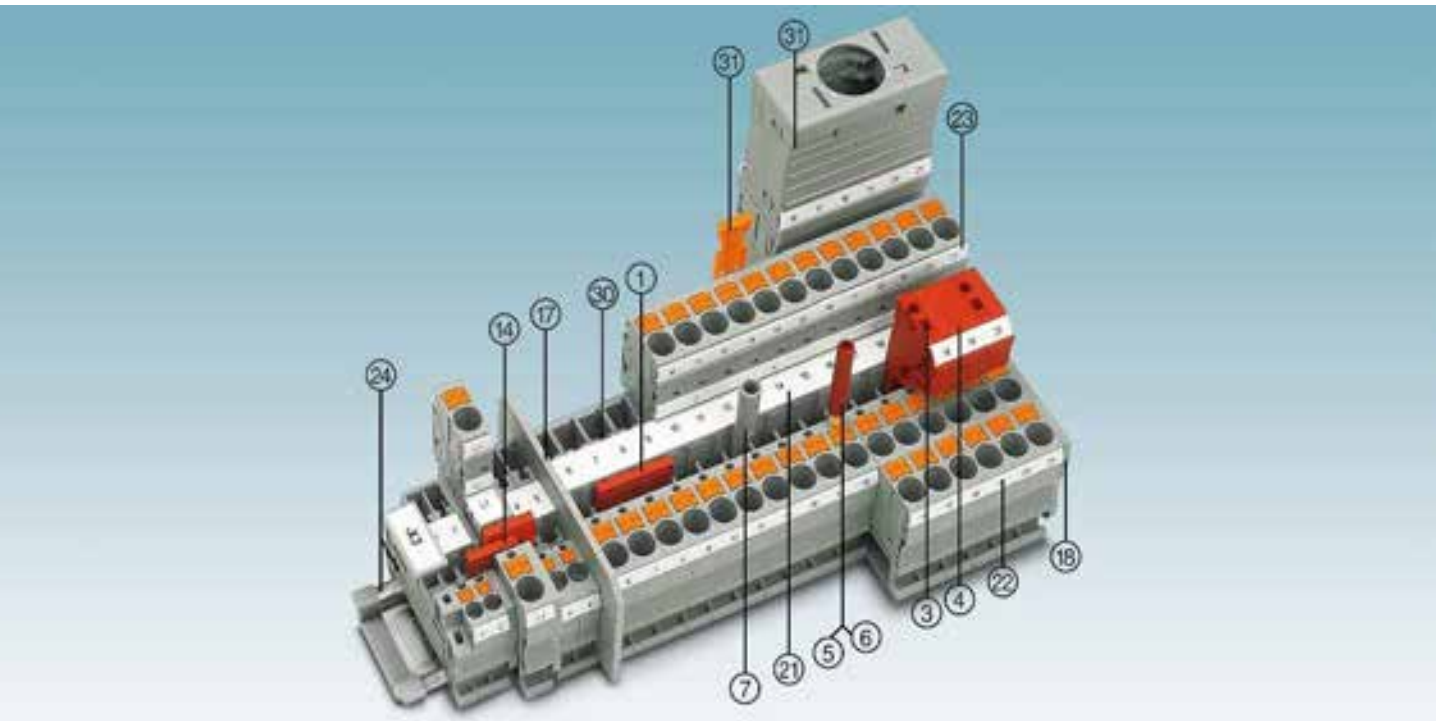

Description	No. of pos.	Color	Type	Order No.	Pcs./Pkt.	Type	Order No.	Pcs./Pkt.
① Bridge ¹⁾	2	red	FBS 2-8	3030284	10	FBSR 2-8	3033808	10
	3	red	FBS 3-8	3030297	10	FBSR 3-8	3001597	10
	4	red	FBS 4-8	3030307	10	FBSR 4-8	3000585	10
	5	red	FBS 5-8	3030310	10	FBSR 5-8	3033809	10
	10	red	FBS 10-8	3030323	10	FBSR 10-8	3001599	10
	16	red				FBSR 16-8	3033816	10
③ Modular test plug		red	PS-8	3031005	10			
④ Spacer plate		red	DP PS-8	3036741	10			
⑤ Test plug metal part		gray	MPS-MT	0201744	10			
⑥ Insulating sleeve, for MPS metal part		red	MPS-IH RD	0201676	10			
⑦ Test adapter, 4 mm socket hole		gray	PAI-4-N GY	3032871	10			
⑨ Coding profile		red	PC	3040588	50			
Screwdriver			SZF 2-0,8X4,0	1204520	10			
⑭ Reducing bridge	For RB ..., see page 408.							
⑰ Partition plates/end cover segments	For ATP-... / DS-..., visit phoenixcontact.net/products							
⑱ Cover	Listed alongside the respective product.							
⑲ Center groove labeling	UC-TM 8, UCT-TM 8 or ZB 8. See also Catalog 3, selection tables, from page 60.							
⑲ Center and side groove labeling	UC-TMF 8, UCT-TMF 8 or ZBF 8. See also Catalog 3, selection tables, from page 60.							
⑲ Lateral groove labeling	UC-TMF 8, UCT-TMF 8 or ZBF 8. See also Catalog 3, selection tables, from page 60.							
⑲ DIN rail and end bracket	See Catalog 3							
⑳ Latching, strain relief, shielding	See page 362.							
For full accessories, visit phoenixcontact.net/products	Note: Additional or deviating accessories are listed alongside the respective product.							

Feed-through, multi-conductor, and ground terminal blocks

Notes:

- 1) For additional accessories and technical data, see page 346.
- 2) For derating curve, visit phoenixcontact.net/products

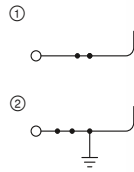

41 A, feed-through terminal block



Technical data ¹⁾			
Dimensions	Width	Length	Height
	8.2	57.7	43.5 (NS 35/7,5)
Maximum electrical data	I_{max} [A]	U_{max} [V]	max. Ø [mm ²] AWG (UL)
	41 ²⁾	1000	0.5 - 10 20-8
	41 (FBS) / 32 (FBSR)		
Rated data	IEC	UL / CUL	CSA Ex
Maximum bridge current	1000	600	600 -
Rated voltage	41 ²⁾ / 6	40 / -	40 / - - / -
Nominal current / cross section	[A] / [mm ²]		

Ordering data			
Type	Order No.	Pcs./Pkt.	
PT 6/1P	① 3061758	50	
PT 6/1P BU	① 3061761	50	
PT 6/1P-PE	② 3061774	50	

Accessories ¹⁾		
D-PT 6	3212044	50

Dimensions	[mm]
Maximum electrical data	
Maximum bridge current	[A]
Rated data	
Rated voltage	[V]
Nominal current / cross section	[A] / [mm ²]

Description	Color
Terminal block	gray
	blue
Ground terminal	green-yellow

Cover, width: 2.2 mm	gray
-----------------------------	------

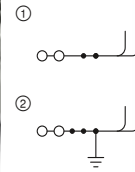

41 A, feed-through terminal block, 4 connections



Technical data ¹⁾			
Dimensions	Width	Length	Height
	8.2	99.8	43.5 (NS 35/7,5)
Maximum electrical data	I_{max} [A]	U_{max} [V]	max. Ø [mm ²] AWG (UL)
	41 ²⁾	1000	0.5 - 10 20-8
	41 (FBS) / 32 (FBSR)		
Rated data	IEC	UL / CUL	CSA Ex
Maximum bridge current	1000	600	600 -
Rated voltage	41 ²⁾ / 6	40 / -	40 / - - / -
Nominal current / cross section	[A] / [mm ²]		

Ordering data			
Type	Order No.	Pcs./Pkt.	
PT 6-QUATTRO/2P	① 3061826	50	
PT 6-QUATTRO/2P BU	① 3061839	50	
PT 6-QUATTRO/2P-PE	② 3061842	50	

Accessories ¹⁾		
D-PT 6-QUATTRO/2P	3061855	50

Test disconnect terminal blocks

Notes:

- 1) For additional accessories and technical data, see page 346.
 - 2) For derating curve, visit phoenixcontact.net/products
- For pre-assembled bridges, see phoenixcontact.net/products

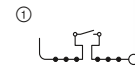

30 A, test disconnect terminal block



Dimensions	
Width	[mm]
Length	
Height	
Maximum electrical data	
I_{max} [A]	
Maximum bridge current	[A]
Rated data	
Rated voltage	[V]
Nominal current / cross section	[A] / [mm ²]

Description	Color
Terminal block, for mounting on NS 35...	gray

Cover, width: 2.2 mm	gray
-----------------------------	------

Technical data ¹⁾			
Dimensions	Width	Length	Height
	8.2	99.4	49.6 (NS 35/7,5)
Maximum electrical data	I_{max} [A]	U_{max} [V]	max. Ø [mm ²] AWG (UL)
	30 ²⁾	500	0.5 - 10 20-8
	41 (FBS) / 32 (FBSR)		
Rated data	IEC	UL / CUL	CSA Ex
Maximum bridge current	500	600	600 -
Rated voltage	30 ²⁾ / 6	30 / -	30 / - - / -
Nominal current / cross section	[A] / [mm ²]		

Ordering data			
Type	Order No.	Pcs./Pkt.	
PTME 6/1P	① 3212306	50	

Accessories ¹⁾		
D-PTME 6/1P	3212307	10

Terminal blocks – CLIPLINE complete

6 mm² COMBI PT plug-in connection solutions

Test disconnect terminal blocks

Notes:
 1) For additional accessories and technical data, see page 346.



30 A, current transformer disconnect terminal block, for short-circuit plugs



Technical data ¹⁾				
Dimensions	Width	Length	Height	
	8.2	114.9	49.6 (NS 35/7,5)	
Maximum electrical data	I _{max.} [A]	U _{max.} [V]	max. Ø [mm ²]	AWG (UL)
	30	500	0.5 - 10	20-8
	41 (FBS) / 32 (FBSR)			
Rated data	IEC	UL / CUL	CSA	Ex
Maximum bridge current	500	600	600	-
Rated voltage	30 / 6	30 / -	30 / -	- / -
Nominal current / cross section				

Ordering data			
Type	Order No.	Pcs./Pkt.	
PTME 6-CT/1P	3212300	50	

Accessories ¹⁾			
D-PTME 6-CT/1P	Order No.	Pcs./Pkt.	
D-PTME 6-CT/1P	3212303	10	

Description	Color
Disconnect terminal block	gray
Feed-through terminal block	gray
Ground terminal	green-yellow
Cover, width: 2.2 mm	gray

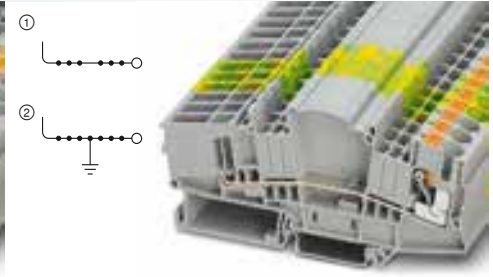

30 A, feed-through terminal block, for short-circuit plugs



Technical data ¹⁾				
Dimensions	Width	Length	Height	
	8.2	114.9	49.6 (NS 35/7,5)	
Maximum electrical data	I _{max.} [A]	U _{max.} [V]	max. Ø [mm ²]	AWG (UL)
	30	500	0.5 - 10	20-8
	41 (FBS) / 32 (FBSR)			
Rated data	IEC	UL / CUL	CSA	Ex
Maximum bridge current	500	600	600	-
Rated voltage	30 / 6	30 / -	30 / -	- / -
Nominal current / cross section				

Ordering data			
Type	Order No.	Pcs./Pkt.	
PTMED 6-CT/1P	3212301	50	
PTMED 6-CT/1P-PE	3212302	50	

Accessories ¹⁾			
D-PTME 6-CT/1P	Order No.	Pcs./Pkt.	
D-PTME 6-CT/1P	3212303	10	

Connectors, with integrated short-circuit function

Notes:
 1) For additional accessories and technical data, see page 346.



20 A, connector, 2-pos.



Technical data ¹⁾				
Dimensions	Width	Length	Height	
	16.4	38.5	48.5	
Maximum electrical data	I _{max.} [A]	U _{max.} [V]	max. Ø [mm ²]	AWG (UL)
	20	320	0.5 - 10	20-8
	IEC UL / CUL CSA Ex			
Rated voltage	320	600	600	-
Nominal current / cross section	20 / 6	30 / -	30 / -	- / -

Ordering data			
Type	Order No.	Pcs./Pkt.	
PPCT 6/2	3212304	10	

Description	Color
COMBI connector, with integrated short-circuit function, 2-pos.	gray
3-pos.	gray



20 A, connector, 3-pos.



Technical data ¹⁾				
Dimensions	Width	Length	Height	
	24.6	38.5	48.5	
Maximum electrical data	I _{max.} [A]	U _{max.} [V]	max. Ø [mm ²]	AWG (UL)
	20	320	0.5 - 10	20-8
	IEC UL / CUL CSA Ex			
Rated voltage	320	600	600	-
Nominal current / cross section	20 / 6	30 / -	30 / -	- / -

Ordering data			
Type	Order No.	Pcs./Pkt.	
PPCT 6/3	3212305	10	

Supplementary accessories for PTME 6-CT/1P test disconnect terminal blocks

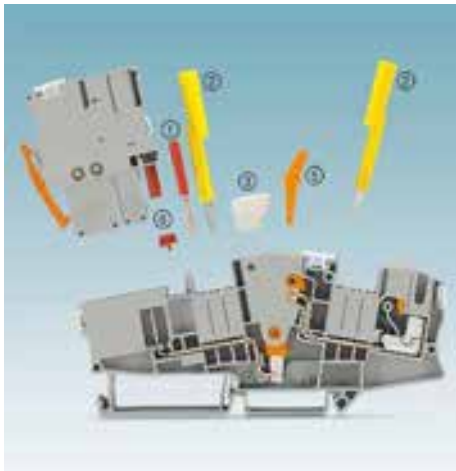

- A current transformer measuring circuit can be created using just two PTME 6-CT/1P
- Less space required compared to creating circuits with slide-type terminal blocks
- ① FBS... plug-in bridge for cross connection
- ② 4 mm Ø PAI-4-FIX... test plug adapter
- ③ S-ME 6 switching lock
- ④ SB-ME... bridge bar
- ⑤ C-ME 6/2 operating lever
- ⑥ PC-CT 6... coding set

Notes:

1) The coding set can be used to code up to 30 plugs.

			Ordering data		
Description	No. of pos.	Color	Type	Order No.	Pcs./Pkt.
Test adapter , for 4-mm-Ø safety test connector, snapped into bridge shaft	1	orange	PAI-4-FIX OG	3034455	10
	1	yellow	PAI-4-FIX YE	3032745	10
	1	green	PAI-4-FIX GN	3032758	10
	1	violet	PAI-4-FIX VT	3032761	10
	1	black	PAI-4-FIX BK	3032774	10
	1	blue	PAI-4-FIX BU	3032729	10
	1	red	PAI-4-FIX RD	3032732	10
	1	gray	PAI-4-FIX GY	3032790	10
	1	brown	PAI-4-FIX BN	3032787	10
	1	white	PAI-4-FIX WH	3032797	10
Switching lock , plug-in		white	S-ME 6	3034439	10
Switching bridge , plug-in	2	gray/orange	SB-ME 2-8	3034468	10
	3	gray/orange	SB-ME 3-8	3032800	10
	4	gray/orange	SB-ME 4-8	3034484	10
Operating lever , for actuating test disconnect terminal blocks	1	orange	C-ME 6/1	3034441	10
	2	orange	C-ME 6/2	3034442	10
	3	orange	C-ME 6/3	3034390	50
Coding set , for 2-pos. plugs ¹⁾		red	PC-CT 6/2	3212308	1

Terminal blocks – CLIPLINE complete

6 mm² COMBI PT plug-in connection solutions

Couplings

Notes:

1) For additional accessories and technical data, see page 346.

2) For derating curve, visit phoenixcontact.net/products

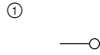

41 A, coupling

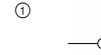

41 A, coupling, for self-assembly



Dimensions				Technical data ¹⁾				Technical data ¹⁾					
[mm]				Width	Length	Height		Width	Length	Height			
				8.2 x No. of pos.	47	24.7		8.2 x No. of pos.	47	24.7			
Maximum electrical data				I _{max.} [A]	U _{max.} [V]	max. Ø [mm ²]	AWG (UL)	I _{max.} [A]	U _{max.} [V]	max. Ø [mm ²]	AWG (UL)		
Rated data				41	1000	0.5 - 10	20-8	41 ²⁾	1000	0.5 - 10	20-8		
Rated voltage [V]				IEC	UL / CUL	CSA	Ex	IEC	UL / CUL	CSA	Ex		
Nominal current / cross section [A] / [mm ²]				1000	600	600	-	1000	600	600	-		
				41 / 6	40 / -	36 / -	- / -	41 ²⁾ / 6	40 / -	36 / -	- / -		
Ordering data				Ordering data				Ordering data					
Description	No. of pos.	Width	Color	Type	Order No.	Pcs./Pkt.	Type	Order No.	Pcs./Pkt.	Type	Order No.	Pcs./Pkt.	
COMBI coupling	2	16.4 mm	gray	PPC 6/2	① 3000693	25	PPC 6/1-L	① 3000690	50	PPC 6/1-L BU	① 3000691	50	
	3	24.6 mm	gray	PPC 6/3	① 3000694	25		PPC 6/1-L GNYE	① 3000692		50		
	4	32.8 mm	gray	PPC 6/4	① 3000695	25							
	5	41 mm	gray	PPC 6/5	① 3000697	25							
	6	49.2 mm	gray	PPC 6/6	① 3000698	25							
	7	57.4 mm	gray	PPC 6/7	① 3000699	25							
	8	65.6 mm	gray	PPC 6/8	① 3000700	25							
	9	73.8 mm	gray	PPC 6/9	① 3000701	25							
	10	82 mm	gray	PPC 6/10	① 3000702	25							
	COMBI coupling, for self-assembly	1	8.2 mm	gray									
	1	8.2 mm	blue										
	1	8.2 mm	green/yellow										
Accessories ¹⁾				Accessories ¹⁾				Accessories ¹⁾					
Test plug metal part, 2.3 mm Ø		gray		MPS-MT	0201744	10	MPS-MT	0201744	10	MPS-MT	0201744	10	
Insulating sleeve, for MPS metal part		red		MPS-IH RD	0201676	10	MPS-IH RD	0201676	10	MPS-IH RD	0201676	10	
Cover, width: 2.2 mm		gray		D-PPC 6	3000703	10	D-PPC 6	3000703	10	D-PPC 6	3000703	10	
Coding star, with 4 coding branches, can be inserted in all basic terminal blocks		red		PC	3040588	50	PC	3040588	50	PC	3040588	50	
Strain relief, for plugs, 2-pos.		black		PZ/2	3040627	50	PZ/2	3040627	50	PZ/2	3040627	50	

Couplings



- The panel feed-through can be used to securely fasten free-hanging PPC 6 couplings in panel cutouts
- The panel feed-through elements are snapped onto the free-hanging receptacles, and pushed into the panel cutout where they snap in automatically

Notes:

1) For additional accessories and technical data, see page 346.

①



41 A, coupling for DIN rail mounting



Technical data¹⁾

Dimensions	Width	Length	Height	
	8.2	43	38 (NS 35/7,5) / 38 (NS 15)	
Maximum electrical data	I_{max} [A]	U_{max} [V]	max. \varnothing [mm ²]	AWG (UL)
	41	1000	0.5 - 10	20-8
Rated data	Rated voltage	1000	600	600
	Nominal current / cross section	41 / 6	40 / -	36 / -
				Ex

Ordering data

Description	Color	Type	Order No.	Pcs./Pkt.
COMBI coupling	gray	PPC 6-NS/1-L	3000689	50

Accessories¹⁾

Cover, width: 2.2 mm	gray	D-PPC 6	3000703	10
Coding star, with 4 coding branches, can be inserted in all basic terminal blocks	red	PC	3040588	50
Strain relief, for plugs, 2-pos.	black	PZ/2	3040627	50

Terminal blocks – CLIPLINE complete

6 mm² COMBI PT plug-in connection solutions

COMBI connectors

Notes:
1) For additional accessories and technical data, see page 346.
2) For derating curve, visit phoenixcontact.net/products



41 A, connector, connection in plug-in direction

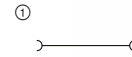

41 A, connector, connection in plug-in direction, for self-assembly



Dimensions				Technical data ¹⁾				Technical data ¹⁾			
[mm]				Width	Length	Height	Height plugged	Width	Length	Height	Height plugged
				8.2 x No. of pos.	21	49.3	31.2	8.2 x No. of pos.	21	49.3	31.2
Maximum electrical data				I _{max.} [A]	U _{max.} [V]	max. Ø [mm ²]	AWG (UL)	I _{max.} [A]	U _{max.} [V]	max. Ø [mm ²]	AWG (UL)
				41 ²⁾	1000	0.5 - 10	20-8	41 ²⁾	1000	0.5 - 10	20-8
Rated data				IEC	UL / CUL	CSA	Ex	IEC	UL / CUL	CSA	Ex
Rated voltage [V]				1000	600	600	-	1000	600	600	-
Nominal current / cross section [A] / [mm ²]				41 ²⁾ / 6	40 / -	40 / -	- / -	41 ²⁾ / 6	40 / -	40 / -	- / -
Ordering data				Ordering data				Ordering data			
Description	No. of pos.	Width	Color	Type	Order No.	Pcs./Pkt.	Type	Order No.	Pcs./Pkt.		
COMBI connectors	1	8.2 mm	gray	PP-H 6/ 1	3061541	50	PP-H 6/ 1-L	3061664	50		
	2	16.4 mm	gray	PP-H 6/ 2	3061570	50		PP-H 6/ 1-L BU	3061677	50	
	3	24.6 mm	gray	PP-H 6/ 3	3061583	50		PP-H 6/ 1-L GNYE	3061680	50	
	4	32.8 mm	gray	PP-H 6/ 4	3061596	50		PP-H 6/ 1-M	3061693	50	
	5	41 mm	gray	PP-H 6/ 5	3061606	50		PP-H 6/ 1-M BU	3061703	50	
	6	49.2 mm	gray	PP-H 6/ 6	3061619	25		PP-H 6/ 1-M GNYE	3061716	50	
	7	57.4 mm	gray	PP-H 6/ 7	3061622	25		PP-H 6/ 1-R	3061729	50	
	8	65.6 mm	gray	PP-H 6/ 8	3061635	25		PP-H 6/ 1-R BU	3061732	50	
	9	73.8 mm	gray	PP-H 6/ 9	3061648	25		PP-H 6/ 1-R GNYE	3061745	50	
	10	82 mm	gray	PP-H 6/10	3061651	25					
COMBI connector, left element	1	8.2 mm	blue	PP-H 6/ 1 BU	3061554	50					
	1	8.2 mm	green-yellow	PP-H 6/ 1 GNYE	3061567	50					
COMBI connector, center element	1	8.2 mm	gray								
	1	8.2 mm	blue								
COMBI connector, right element	1	8.2 mm	green/yellow								
	1	8.2 mm	gray								
COMBI connector, right element	1	8.2 mm	blue								
	1	8.2 mm	green/yellow								
Accessories ¹⁾				Accessories ¹⁾				Accessories ¹⁾			
Test plug metal part, 2.3 mm Ø		gray		MPS-MT	0201744	10	MPS-MT	0201744	10		
Insulating sleeve, for MPS metal part		red		MPS-IH RD	0201676	10	MPS-IH RD	0201676	10		
Latching and strain relief systems, for all plugs with conductor exit at top, 2-pos.		orange		PRZ	3040614	50	PRZ	3040614	50		
Latching, for connectors, 1-pos.		orange		PR	3040559	50	PR	3040559	50		
Latching, for connectors, 2-pos.		orange		PR/2	3040630	50	PR/2	3040630	50		
Strain relief, for plugs, 2-pos.		black		PZ/2	3040627	50	PZ/2	3040627	50		
Cable housing, for PP-H 6... COMBI plugs and PPCT 6/..., 2-pos.		gray		PH 6/2	3000680	25	PH 6/2	3000680	25		
Cable housing, for PP-H 6... COMBI plugs and PPCT 6/..., 3-pos.		gray		PH 6/3	3000681	25	PH 6/3	3000681	25		
Cable housing, for PP-H 6... COMBI plugs and PPCT 6/..., 4-pos.		gray		PH 6/4	3000682	25	PH 6/4	3000682	25		
Cable housing, for PP-H 6... COMBI plugs and PPCT 6/..., 5-pos.		gray		PH 6/5	3000683	25	PH 6/5	3000683	25		
Cable housing, for PP-H 6... COMBI plugs and PPCT 6/..., 6-pos.		gray		PH 6/6	3000684	10	PH 6/6	3000684	10		
Cable housing, for PP-H 6... COMBI plugs and PPCT 6/..., 7-pos.		gray		PH 6/7	3000685	10	PH 6/7	3000685	10		

Terminal blocks – CLIPLINE complete

6 mm² COMBI UT plug-in connection solutions

General technical data

Rated data		IEC 61984			
Rated cross section	[mm ²]	6			
Cross section range	AWG	24 - 8			
Connection capacity		Rigid	Flexible	Ferrule without/with plastic sleeve	
1 conductor	[mm ²]	0.2 - 10	0.2 - 10	0.25 - 6	0.25 - 6
2 conductors (of the same type)	[mm ²]	0.2 - 2.5	0.2 - 2.5	0.25 - 1.5	-
2 flexible conductors with a TWIN ferrule	[mm ²]	-	-	-	0.5 - 4
General data					
Stripping length	[mm]	10			
Insulating material		PA			
Flammability rating in accordance with UL 94		V0			

Note: Additional or deviating data is listed alongside the respective product.

Notes:



In addition to the product, the internal electrical wiring is provided as a circuit diagram. Free connection points for bridging are indicated by a black dot.

The specified technical data and approvals refer to the first product in each column. For information on the products below, please refer to phoenixcontact.net/products

For full details of UL and CSA use groups, file nos., and Internet links, please visit phoenixcontact.net/products

¹⁾ The bridge current is listed alongside the respective product. For additional colors, see page 402.

System accessories

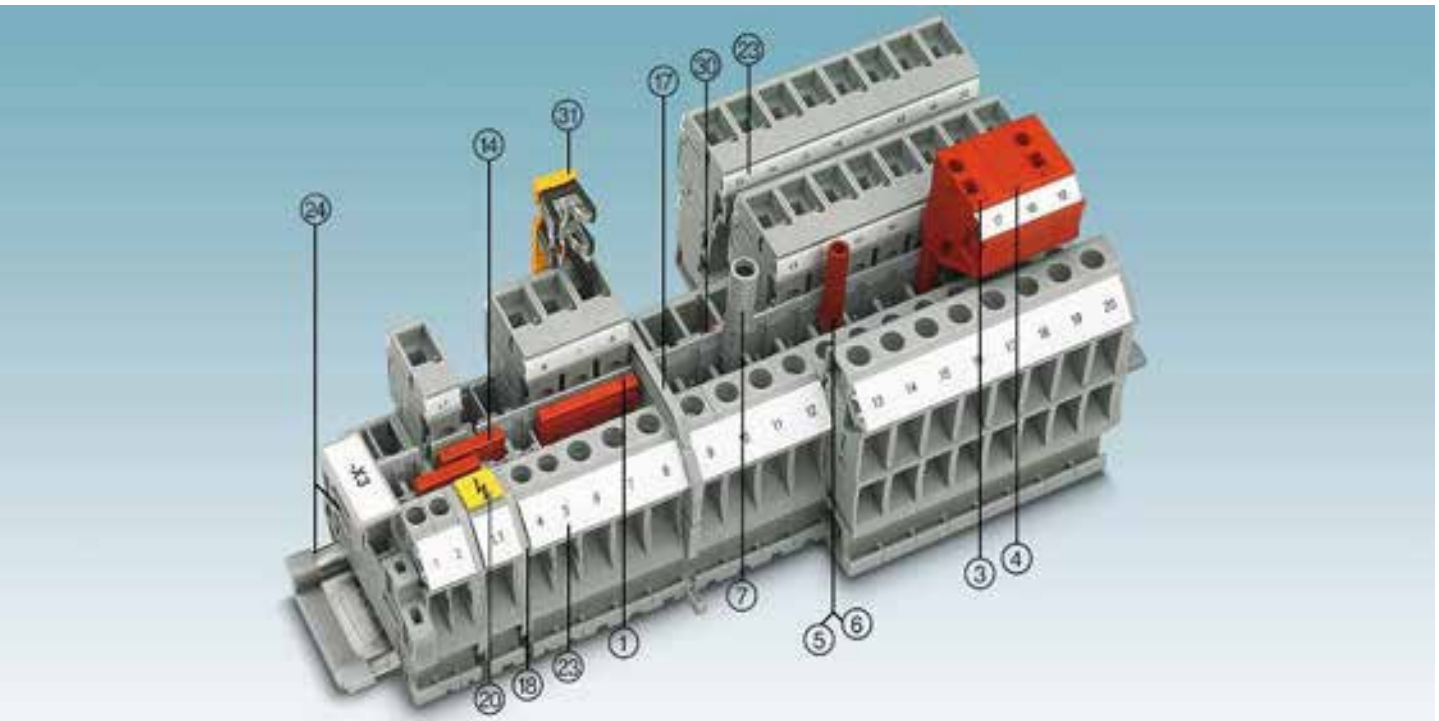

Description	No. of pos.	Color	Type	Order No.	Pcs./Pkt.	Type	Order No.	Pcs./Pkt.
① Bridge ¹⁾	2	red	FBS 2-8	3030284	10	FBSR 2-8	3033808	10
	3	red	FBS 3-8	3030297	10	FBSR 3-8	3001597	10
	4	red	FBS 4-8	3030307	10	FBSR 4-8	3000585	10
	5	red	FBS 5-8	3030310	10	FBSR 5-8	3033809	10
	10	red	FBS 10-8	3030323	10	FBSR 10-8	3001599	10
	16	red				FBSR 16-8	3033816	10
③ Modular test plug		red	PS-8	3031005	10			
④ Spacer plate		red	DP PS-8	3036741	10			
⑤ Test plug metal part		gray	MPS-MT	0201744	10			
⑥ Insulating sleeve, for MPS metal part		red	MPS-IH RD	0201676	10			
⑦ Test adapter, 4 mm socket hole		gray	PAI-4-N GY	3032871	10			
⑨ Coding profile		red	PC	3040588	50			
Screwdriver			SZS 1,0X4,0 VDE	1205066	10			
⑭ Reducing bridge	For RB ..., see page 408.							
⑰ Partition plates/end cover segments	For ATP-... / DS-..., visit phoenixcontact.net/products							
⑱ Cover	Listed alongside the respective product.							
⑳ Warning labels	For WS ..., see page 420.							
㉑ Lateral groove labeling	Terminal block: UC-TM 8, UCT-TM 8 or ZB 8 Connector: UC-TMF 8, UCT-TMF 8 or ZBF 8. See also Catalog 3, selection tables, from page 60.							
㉒ DIN rail and end bracket	See Catalog 3							
㉓ Latching, strain relief, shielding	See from page 362.							
For full accessories, visit phoenixcontact.net/products	Note: Additional or deviating accessories are listed alongside the respective product.							

Feed-through, multi-conductor, and ground terminal blocks

Notes:
 1) For additional accessories and technical data, see page 354.
 2) For derating curve, visit phoenixcontact.net/products
 For screw flange, see page 372.

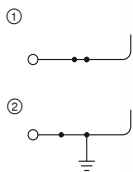

41 A, feed-through terminal block

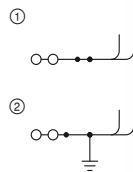

41 A, feed-through terminal block, 4 connections



Technical data ¹⁾					
Width	Length	Height			
8.2	49.1	47.5 (NS 35/7,5)			
I _{max} [A]	U _{max} [V]	max. Ø [mm ²]	AWG (UL)		
41 ²⁾	1000	0.2 - 10	24-8		
41 (FBS) / 32 (FBSR)					
IEC	UL / CUL	CSA	Ex		
1000	600	600	-		
Nominal current / cross section	[A] / [mm ²]	41 ²⁾ / 6	40 / -	50 / -	- / -

Technical data ¹⁾					
Width	Length	Height			
8.2	86.5	60 (NS 35/7,5)			
I _{max} [A]	U _{max} [V]	max. Ø [mm ²]	AWG (UL)		
41 ²⁾	1000	0.2 - 10	24-8		
41 (FBS) / 32 (FBSR)					
IEC	UL / CUL	CSA	Ex		
1000	600	600	-		
Nominal current / cross section	[A] / [mm ²]	41 ²⁾ / 6	40 / -	50 / -	- / -

Ordering data			
Type	Order No.	Pcs./Pkt.	
UT 6/1P	① 3060539	50	
UT 6/1P BU	① 3060542	50	
UT 6/1P-PE	② 3060555	50	

Ordering data			
Type	Order No.	Pcs./Pkt.	
UT 6-QUATTRO/2P	① 3060568	50	
UT 6-QUATTRO/2P BU	① 3060571	50	
UT 6-QUATTRO/2P-PE	② 3060584	50	

Accessories ¹⁾		
Type	Order No.	Pcs./Pkt.
D-UT 2,5/1P	3047154	50

Accessories ¹⁾		
Type	Order No.	Pcs./Pkt.
D-UT 6-QUATTRO/2P	3060607	50

Description	Color
Terminal block	gray blue
Ground terminal	green-yellow
Cover, width: 2.2 mm	gray

COMBI connectors



- When it comes to the connectors, as is the case with the basic terminal blocks, the right connection technology is available for every application
- Comprehensive, optional snap-on accessories available
- Practical coding facility
- Large-surface marking options
- The screw connectors can be combined with COMBI terminal blocks with all forms of connection technology and are available in two versions

UP ... connectors

- Screw actuation from the side
- Conductor connected from above
- The connector design enables a space-saving potential distribution by using four-conductor terminal blocks with 2 slots

Notes:
1) For additional accessories and technical data, see page 354.
2) For derating curve, visit phoenixcontact.net/products

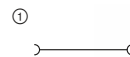

41 A, connector, connection in plug-in direction



Dimensions	[mm]
8.2 x No. of pos.	21

Maximum electrical data	
I _{max.} [A]	U _{max.} [V]
41 ²⁾	1000
IEC	UL / CUL
	CSA
	Ex

Rated data	[V]
Rated voltage	1000
Nominal current / cross section	41 ²⁾ / 6

Connection capacity	[A] / [mm ²]
Rigid	40 / -
Flexible	50 / -

1 conductor	[mm ²]
0.2 - 6	0.2 - 10
	0.25 - 6
	0.25 - 6

Technical data ¹⁾			
Width	Length	Height	Height plugged
8.2 x No. of pos.	21	42.7	26
I _{max.} [A]	U _{max.} [V]	max. Ø [mm ²]	AWG (UL)
41 ²⁾	1000	0.2 - 10	24-8
IEC	UL / CUL	CSA	Ex
Rated voltage	1000	600	-
Nominal current / cross section	41 ²⁾ / 6	40 / -	- / -
Connection capacity	Rigid	Flexible	Ferrule without/with plastic sleeve
1 conductor	0.2 - 6	0.2 - 10	0.25 - 6

Description	No. of pos.	Width	Color
Connector	1	8.2 mm	gray
	2	16.4 mm	gray
	3	24.6 mm	gray
	4	32.8 mm	gray
	5	41 mm	gray
	6	49.2 mm	gray
	7	57.4 mm	gray
	8	65.6 mm	gray
	9	73.8 mm	gray
	10	82 mm	gray
	1	8.2 mm	blue
	1	8.2 mm	green-yellow

Ordering data			
Type	Order No.	Pcs./Pkt.	
UP 6/ 1	3060610	50	①
UP 6/ 2	3060623	50	①
UP 6/ 3	3060636	50	①
UP 6/ 4	3060649	25	①
UP 6/ 5	3060652	25	①
UP 6/ 6	3060665	25	①
UP 6/ 7	3060678	25	①
UP 6/ 8	3060681	25	①
UP 6/ 9	3060694	25	①
UP 6/10	3060704	25	①
UP 6/ 1 BU	3060717	50	①
UP 6/ 1 GNYE	3060720	50	①

Strain relief, for plugs, 2-pos.	black
Latching, for connectors, 1-pos.	orange
Latching and strain relief systems, for all plugs with conductor exit at top, 2-pos.	orange
Screw flange cover, for COMBI connector UP 6	gray

Accessories ¹⁾		
PZ/2	3040627	50
PR	3040559	50
PR/2	3040630	50
PRZ	3040614	50
DF-UP 6	3060856	50

COMBI connectors for self-assembly

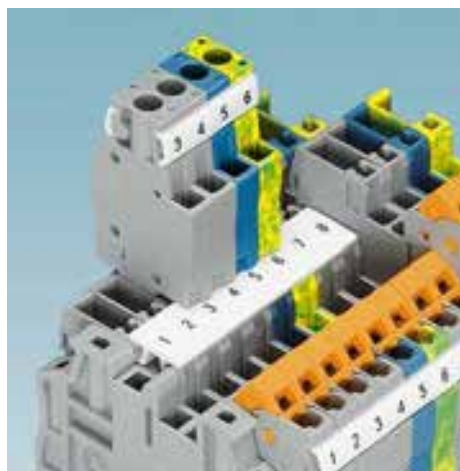

- The COMBI connectors for self-assembly provide solutions that users can implement themselves
- The connectors are snapped together from one-position connector elements directly on site
- The screw connectors can be combined with COMBI terminal blocks with all forms of connection technology and are available in two versions
- The plug is assembled directly on site by snapping together single-position connector elements. See below for an example of how these go together

- ① DF-UP 6
- ② UP 6/1-L
- ③ UP 6/1-M and UP 6/1-M BU
- ④ UP 6/1-R GNYE

Notes:
1) For additional accessories and technical data, see page 354.
2) For derating curve, visit phoenixcontact.net/products

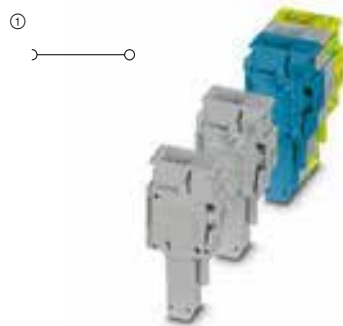

41 A, connector, connection in plug-in direction, for self-assembly



Dimensions	[mm]
8.2 x No. of pos.	21
Maximum electrical data	
Rated data	
Rated voltage	[V]
Nominal current / cross section	[A] / [mm ²]
Connection capacity	
1 conductor	[mm ²]

Technical data ¹⁾			
Width	Length	Height	Height plugged
8.2 x No. of pos.	21	42.7	26
I _{max} [A]	U _{max} [V]	max. Ø [mm ²]	AWG (UL)
41 ²⁾	1000	0.2 - 10	24-8
IEC	UL / CUL	CSA	Ex
Rated voltage	1000	600	-
Nominal current / cross section	41 ²⁾ / 6	40 / -	50 / -
Connection capacity	Rigid	Flexible	Ferrule without/with plastic sleeve
1 conductor	0.2 - 6	0.2 - 10	0.25 - 6 0.25 - 6

Description	No. of pos.	Color
Connector, left element	1	gray
	1	blue
	1	green-yellow
Connector, center element	1	gray
	1	blue
	1	green-yellow
Connector, right element	1	gray
	1	blue
	1	green-yellow

Ordering data		
Type	Order No.	Pcs./Pkt.
UP 6/ 1-L	① 3060733	50
UP 6/ 1-L BU	① 3060746	50
UP 6/ 1-L GNYE	① 3060759	50
UP 6/ 1-M	① 3060762	50
UP 6/ 1-M BU	① 3060775	50
UP 6/ 1-M GNYE	① 3060788	50
UP 6/ 1-R	① 3060791	50
UP 6/ 1-R BU	① 3060801	50
UP 6/ 1-R GNYE	① 3060814	50

Strain relief , for plugs, 2-pos.	black
Latching , for connectors, 1-pos. 2-pos.	orange
Latching and strain relief systems , for all plugs with conductor exit at top, 2-pos.	orange
Screw flange cover , for COMBI connector UP 6	gray

Accessories ¹⁾		
Type	Order No.	Pcs./Pkt.
PZ/2	3040627	50
PR	3040559	50
PR/2	3040630	50
PRZ	3040614	50
DF-UP 6	3060856	50



Cross-reference list
COMBI
accessories

Accessories

PZ 1,5/S/2 Order No. 3212918	PZ/2 Order No.: 3040627	PZ/4 Order No. 3040643	UPZ/2 Order No. 3045554	PDZ/2 Order No. 3040562	PDZ/4 Order No. 3040575	CZ/2 Order No. 3043831	PRZ-1,5/S Order No. 3212905	PRZ Order No.: 3040614	UPRZ Order No.: 3045570
------------------------------------	-------------------------------	------------------------------	-------------------------------	-------------------------------	-------------------------------	------------------------------	-----------------------------------	------------------------------	-------------------------------



Connector

	PP-H 1,5...								
	QP 1,5...								
	PP-H 2,5...								
	PP 2,5...								
	UPBV 2,5...								
	SP 2,5...								
	SP-H 2,5...								
	SPV 2,5...								
	SPB 2,5...								
	SPDB 2,5...								
	CP 2,5...								
	PP-H 4...								
	UPBV 4...								
	UP 4...								
	UPCT 4/...								
	SP 4...								
	PP-H 6... PPCT 6/...								
	UP 6...								

Terminal blocks – CLIPLINE complete

COMBI plug-in connection solutions – accessories

PR-1,5/S Order No.: 3212882	PR-1,5/S/2 Order No.: 3212895	PR Order No.: 3040559	PR/2 Order No.: 3040630	PRT/2 Order No.: 3040631	PRV/2 Order No.: 3041862	UPR/2 Order No.: 3045567	PH 1,5/S/... Order No.: 3212...	PH 2,5/... Order No.: 3209...	PH 4/... Order No.: 3000...	PH 6/... Order No.: 3000...	CPSL Order No.: 1069808	CPL Order No.: 1069807	CPS Order No.: 1069806
■	■						■						
		■	■	■									
		■	■	■				■					
						■							
		■	■	■									
		■	■	■					■				
					■								
		■	■	■									
		■	■	■									
												■	■
		■	■	■									
		■	■	■									
						■							
		■	■	■									
										■			
		■	■	■						■			

Terminal blocks – CLIPLINE complete

COMBI plug-in connection solutions – accessories

Cross-reference list
COMBI accessories

Accessories















PZ 1,5/S/2 Order No. 3212918	PZ/2 Order No.: 3040627	PZ/4 Order No. 3040643	UPZ/2 Order No. 3045554	PDZ/2 Order No. 3040562	PDZ/4 Order No. 3040575	CZ/2 Order No. 3043831	PRZ-1,5/S Order No. 3212905	PRZ Order No.: 3040614	UPRZ Order No.: 3045570
------------------------------------	-------------------------------	------------------------------	-------------------------------	-------------------------------	-------------------------------	------------------------------	-----------------------------------	------------------------------	-------------------------------



	PZ 1,5/S/2 Order No. 3212918	PZ/2 Order No.: 3040627	PZ/4 Order No. 3040643	UPZ/2 Order No. 3045554	PDZ/2 Order No. 3040562	PDZ/4 Order No. 3040575	CZ/2 Order No. 3043831	PRZ-1,5/S Order No. 3212905	PRZ Order No.: 3040614	UPRZ Order No.: 3045570
PPC 1,5...										
PPC 2,5...										
SC 2,5...										
SC 4...										
PPC 6...										

Terminal blocks – CLIPLINE complete

COMBI plug-in connection solutions – accessories

PR-1,5/S Order No.: 3212882	PR-1,5/S/2 Order No.: 3212895	PR Order No.: 3040559	PR/2 Order No.: 3040630	PRT/2 Order No.: 3040631	PRV/2 Order No.: 3041862	UPR/2 Order No.: 3045567	PH 1,5/S/... Order No.: 3212...	PH 2,5/... Order No.: 3209...	PH 4/... Order No.: 3000...	PH 6/... Order No.: 3000...	CPSL Order No.: 1069808	CPL Order No.: 1069807	CPS Order No.: 1069806
													

Strain relief for connectors



- The strain relief can be snapped onto the outside of the connector as an option
- The conductor can be fixed using Phoenix Contact cable ties

Notes:
For application options of accessories, refer to page 358.
For corresponding cable ties, see Catalog 3.



General data	
Material	
Description	Color
Strain relief, for connector and receptacle, 2-pos.	black
Strain relief, for connectors, 2-pos. 4-pos.	black
Strain relief, for UPBV... connectors, 2-pos.	black

Technical data		
PA-GF		
Ordering data		
Type	Order No.	Pcs./Pkt.
PZ 1,5/S/2	3212918	50
PZ/2	3040627	50
PZ/4	3040643	50
UPZ/ 2	3045554	50

Strain relief for plugs and receptacles



- The strain relief is snapped into the connector center on the spring-cage connectors or spring-cage couplings
- The conductor can be fixed using Phoenix Contact cable ties

Notes:
For application options of accessories, refer to page 358.
For corresponding cable ties, see Catalog 3.



General data	
Material	
Description	Color
Strain relief, for SPDB... plug and SC 2,5... receptacle, 2-pos. 4-pos.	black
Strain relief, for SC 4... receptacle, 2-pos.	black

Technical data		
PA-GF		
Ordering data		
Type	Order No.	Pcs./Pkt.
PDZ/2	3040562	50
PDZ/4	3040575	50
CZ/2	3043831	50

Snap-lock device and strain relief



- Snap-lock fitting and strain relief in one component
- Can be snapped into connector housing as an option
- The conductor can be fixed using Phoenix Contact cable ties

Notes:
For application options of accessories, refer to page 358.
For corresponding cable ties, see Catalog 3.



General data	
Material	
Description	Color
Latching and strain relief systems, for all connectors with conductor exit at top, 2-pos.	orange
Latching and strain relief systems, for all connectors with conductor exit at top, 2-pos.	orange
Latching and strain relief systems, for UPBV... connectors, 2-pos.	orange

Technical data		
PA-GF		
Ordering data		
Type	Order No.	Pcs./Pkt.
PRZ 1,5/S	3212905	50
PRZ	3040614	50
UPRZ	3045570	50

Snap-lock fitting



- Can be used in all connector versions
- It is snapped into the outside of the connector housing and hooks onto the terminal block housing when the connector is snapped on

Notes:
For application options of accessories, refer to page 358.



General data	
Material	
Description	Color
Latching, for connectors, 1-pos. 2-pos.	orange
Latching, for connectors, 1-pos. 2-pos.	orange
Snap-on, for SPV connectors, 2-pos.	orange
Latching, for UPBV connectors, 2-pos.	orange
Latching, for plugs, release with just a screwdriver	orange

Technical data		
PA-GF		
Ordering data		
Type	Order No.	Pcs./Pkt.
PR 1,5/S	3212882	50
PR 1,5/S/2	3212895	50
PR	3040559	50
PR/2	3040630	50
PRV/2	3041862	50
UPR/ 2	3045567	50
PRT/2	3040631	50

Terminal blocks – CLIPLINE complete

COMBI plug-in connection solutions – accessories

Shielding PSH ...



- For connecting shielded cables
- Is snapped into a strain relief once the connector has been wired
- Connected shielded cable is fixed using a cable tie
- The shielding's connecting cable is connected via the plug and then makes direct contact with the terminal block upon connection

Notes:
For corresponding cable ties, see Catalog 3.



General data	
Material	PA
Description	Color
Shielding, for mounting on PZ/... and PRZ, 2-pos., for cables with 3 ... 6 mm diameter, cable length: 55 mm	black
Cable length: 500 mm	black
For cables with 5 ... 10 mm diameter, cable length: 55 mm	black

Technical data		
PA		
Ordering data		
Type	Order No.	Pcs./Pkt.
PSH 3- 6	3040591	50
PSH 3- 6 500MM	3061525	10
PSH 5-10	3040601	50

Encoding PC



- Can be used in all terminal blocks, receptacles and PCB headers
- The individual coding elements are inserted at the coding position in the basic terminal block and the coding tab is removed at the corresponding point of the plug



General data	
Material	PC
Description	Color
Coding star, with 4 coding branches, can be inserted in all basic terminal blocks	red

Technical data		
PC		
Ordering data		
Type	Order No.	Pcs./Pkt.
PC	3040588	50

CP ... connector housings

new

- Connector housing, for accommodating conductors with crimped module socket contacts
- As an alternative to the COMBI connectors, can be used in all plug-in 2.5 mm² terminal blocks of the CLIPLINE complete system, COMBI, see cross-reference list, page 270



		Ordering data		
Description	Color	Type	Order No.	Pcs./Pkt.
Connector housing , for accommodating module socket contacts, partition width: 5.1 mm, 2-pos.	gray	CP 2,5/2	3061102	50
3-pos.	gray	CP 2,5/3	3061103	50
4-pos.	gray	CP 2,5/4	3061104	50
5-pos.	gray	CP 2,5/5	3061105	50
6-pos.	gray	CP 2,5/6	3061106	50
8-pos.	gray	CP 2,5/8	3061108	50
10-pos.	gray	CP 2,5/10	3061110	50
		Accessories		
Latching and strain relief systems , for CP... plugs	orange	CPSL	1069808	1
Latching , for CP... plugs	orange	CPL	1069807	1
Strain relief , for CP... plugs	orange	CPS	1069806	1

Cable housings for COMBI connectors

Notes:
For additional accessories, visit phoenixcontact.net/products.



- Robust cable housing for strain relief on connection cables
- Two-section housing
- Easy assembly
- Secure latching on the COMBI plugs and COMBI couplings provided
- Add, as with the connectors, without loss of pitch
- Additional scope for labeling to mark the connectors
- The conductor can be fixed using Phoenix Contact cable ties



Cable housing, 3- to 15-pos., snap-in to PP-H 1,5 plug and PPC 1,5 coupling

ERC

General data	
Material	PA

Technical data		
PA		

Description	No. of pos.	Width	Color
Cable housing, for PP-H 1,5... and PPC 1,5...			
	3	10.5 mm	gray
	4	14 mm	gray
	5	17.5 mm	gray
	6	21 mm	gray
	7	24.5 mm	gray
	8	28 mm	gray
	9	31.5 mm	gray
	10	35 mm	gray
	11	38.5 mm	gray
	12	42 mm	gray
	13	45.5 mm	gray
	14	49 mm	gray
	15	52.5 mm	gray
Cable housing, for COMBI plugs SP-H ... and PP-H ...			
	2	10.4 mm	gray
	3	15.6 mm	gray
	4	20.8 mm	gray
	5	26 mm	gray
	6	31.2 mm	gray
	7	36.4 mm	gray
	8	41.6 mm	gray
	9	46.8 mm	gray
	10	52 mm	gray
	11	57.2 mm	gray
	12	62.4 mm	gray
	13	67.6 mm	gray
	14	72.8 mm	gray
	15	78 mm	gray
Cable housing, for PP-H 4... COMBI plugs			
	2	12.4 mm	gray
	3	18.6 mm	gray
	4	24.8 mm	gray
	5	31 mm	gray
	6	37.2 mm	gray
	7	43.4 mm	gray
	8	49.6 mm	gray
	9	55.8 mm	gray
	10	62 mm	gray
Cable housing, for PP-H 6... COMBI plugs and PPCT 6/...			
	2	16.4 mm	gray
	3	24.6 mm	gray
	4	32.8 mm	gray
	5	41 mm	gray
	6	49.2 mm	gray
	7	57.4 mm	gray

Ordering data		
Type	Order No.	Pcs./Pkt.
PH 1,5/S/3	3212756	50
PH 1,5/S/4	3212769	50
PH 1,5/S/5	3212772	50
PH 1,5/S/6	3212785	25
PH 1,5/S/7	3212798	25
PH 1,5/S/8	3212808	25
PH 1,5/S/9	3212811	25
PH 1,5/S/10	3212824	25
PH 1,5/S/11	3212837	10
PH 1,5/S/12	3212840	10
PH 1,5/S/13	3212853	10
PH 1,5/S/14	3212866	10
PH 1,5/S/15	3212879	10
PH 2,5/ 2	3209691	50
PH 2,5/ 3	3209701	50
PH 2,5/ 4	3209714	50
PH 2,5/ 5	3209727	50
PH 2,5/ 6	3209730	25
PH 2,5/ 7	3209743	25
PH 2,5/ 8	3209756	25
PH 2,5/ 9	3209507	25
PH 2,5/10	3209769	25
PH 2,5/11	3209772	10
PH 2,5/12	3209785	10
PH 2,5/13	3209798	10
PH 2,5/14	3209808	10
PH 2,5/15	3209811	10
PH 4/2	3000734	50
PH 4/3	3000736	50
PH 4/4	3000737	50
PH 4/5	3000738	50
PH 4/6	3000739	25
PH 4/7	3000740	25
PH 4/8	3000741	25
PH 4/9	3000742	25
PH 4/10	3000743	25
PH 6/2	3000680	25
PH 6/3	3000681	25
PH 6/4	3000682	25
PH 6/5	3000683	25
PH 6/6	3000684	10
PH 6/7	3000685	10

Accessories for cable housings



Bend protection sleeve

General data	
Material	
Description	Color
Bend protection sleeve	black black black

Technical data		
PA 6.6		
Ordering data		
Type	Order No.	Pcs./Pkt.
CPH 3-9	3212015	25
CPH 4-12	3212028	25
CPH 9-15	3000768	25

Accessories for cable housings



Cable clamp



Shield connection







General data	
Material	
Description	Color
Cable clamp	silver silver
Shield connection	silver/black silver/black

Technical data		
Steel, galvanized		
Ordering data		
Type	Order No.	Pcs./Pkt.
HSR	3212031	25
HSR 6/8	3000769	25

Technical data		
Metal		
Ordering data		
Type	Order No.	Pcs./Pkt.
HSH-METALL	3210910	50
HSH-METALL-6/8	3000770	25

Cross-reference list Cable housing accessories

Accessories

	Cable diameter [mm]	CPH 3-9 Order No. 3212905		CPH 4-12 Order No. 3040614		
			Cable diameter [mm]		Cable diameter [mm]	
	PH 1,5/S/3	3212756	Max. 6.6			
	PH 1,5/S/4	3212769	Max. 6.6			
	PH 1,5/S/5	3212772	Max. 12	3 ... 9		
	PH 1,5/S/6	3212785	Max. 12	3 ... 9		
	PH 1,5/S/7	3212798	Max. 12	3 ... 9		
	PH 1,5/S/8	3212808	Max. 12	3 ... 9		
	PH 1,5/S/9	3212811	Max. 15		4 ... 12	
	PH 1,5/S/10	3212824	Max. 15		4 ... 12	
	PH 1,5/S/11	3212837	Max. 15		4 ... 12	
	PH 1,5/S/12	3212840	Max. 15		4 ... 12	
	PH 1,5/S/13	3212853	Max. 15		4 ... 12	
	PH 1,5/S/14	3212866	Max. 15		4 ... 12	
	PH 1,5/S/15	3212879	Max. 15		4 ... 12	
		PH 2,5/2	3209691	Max. 6.6		
		PH 2,5/3	3209701	Max. 12		
PH 2,5/4		3209714	Max. 12	3 ... 9		
PH 2,5/5		3209727	Max. 12	3 ... 9		
PH 2,5/6		3209730	Max. 15		4 ... 12	
PH 2,5/7		3209743	Max. 15		4 ... 12	
PH 2,5/8		3209756	Max. 15		4 ... 12	
PH 2,5/9		3209507	Max. 15		4 ... 12	
PH 2,5/10		3209769	Max. 15		4 ... 12	
PH 2,5/11		3209772	Max. 15		4 ... 12	
PH 2,5/12		3209785	Max. 15		4 ... 12	
PH 2,5/13		3209798	Max. 15		4 ... 12	
PH 2,5/14		3209808	Max. 15		4 ... 12	
PH 2,5/15		3209811	Max. 15		4 ... 12	
		PH 4/2	3000734	Max. 8.8		
	PH 4/3	3000736	Max. 14.95			
	PH 4/4	3000737	Max. 18.4			
	PH 4/5	3000738	Max. 18.4			
	PH 4/6	3000739	Max. 18.4			
	PH 4/7	3000740	Max. 18.4			
	PH 4/8	3000741	Max. 18.4			
	PH 4/9	3000742	Max. 18.4			
	PH 4/10	3000743	Max. 18.4			
		PH 6/2	3000680	Max. 12.8		
PH 6/3		3000681	Max. 18.4			
PH 6/4		3000682	Max. 18.4			
PH 6/5		3000683	Max. 18.4			
PH 6/6		3000684	Max. 18.4			
PH 6/7		3000685	Max. 18.4			

Self-locking flange covers



The secure latching protects the connectors from coming loose by mistake.

- The **self-locking flanges** are snapped onto the DIN rail directly
- Same shape and pitch as the basic terminal blocks
- Due to the offset arrangement of the locking holes, only one self-locking flange is required between two neighboring connectors
- The **self-locking flange covers** can be snapped onto the connector housing later on
- Automatic latching in self-locking flange



- When connecting, the plugs latch automatically in the self-locking flange

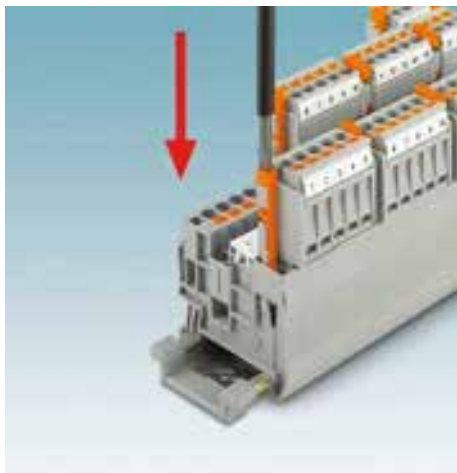

- The plug is released again by pressing down the locking hook with a screwdriver

General data

Insulating material

Description	Color
Self-locking flange cover , for SPB 2,5	gray
Self-locking flange cover , for SPDB 2,5	gray
Self-locking flange cover , for SP-H 2,5... and PP 2,5..., PP-H 2,5...	gray
Self-locking flange , for ST-COMBI and PT-COMBI terminal blocks when using SPB 2,5..., SPDB 2,5..., SP-H 2,5..., and PP-H 2,5 connectors, for ST 2,5/1P, ST 2,5/1P-PE, PT 2,5/1P, PT 2,5/1P-PE	gray
for ST 2,5-TWIN/1P, ST 2,5-TWIN/1P-PE, PT 2,5-TWIN/1P, PT 2,5-TWIN/1P-PE	gray
for ST 2,5-QUATTRO/2P, ST 2,5-QUATTRO/2P-PE, PT 2,5-QUATTRO/2P, PT 2,5-QUATTRO/2P-PE	gray
for ST 2,5-QUATTRO/4P, ST 2,5-QUATTRO/4P-PE	gray
for ST 2,5/2P, ST 2,5/2P-PE	gray
for STTB 2,5/2P, STTB 2,5/2P-PE, PTTB 2,5/2P, PTTB 2,5/2P-PE	gray



Self-locking flange cover



Self-locking flange

ERC

Technical data
-

Ordering data		
Type	Order No.	Pcs./Pkt.
DFS-SPB 2,5	3061444	50
DFS-SPDB 2,5	3061457	50
DFS-SP-H 2,5	3061431	50

Technical data
PA

Ordering data		
Type	Order No.	Pcs./Pkt.
ST 2,5/1P-FS	3061376	50
ST 2,5-TWIN/1P-FS	3061389	50
ST 2,5-QUATTRO/2P-FS	3061392	50
ST 2,5-QUATTRO/4P-FS	3061402	50
ST 2,5/2P-FS	3061415	50
STTB 2,5/2P-FS	3061428	50

Screw flange and flange covers

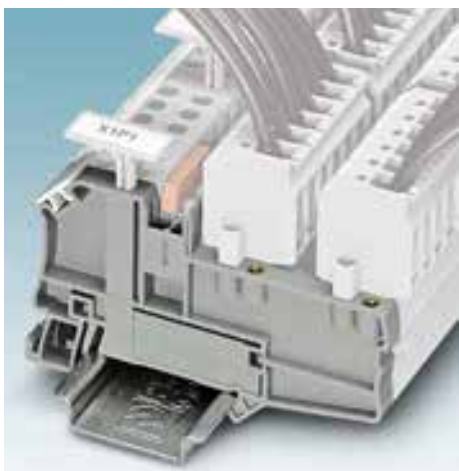

- The secure latching protects the connectors from coming loose by mistake.
- The **screw flanges** snapped onto the DIN rail directly
 - Same shape and pitch as the basic terminal blocks
 - Due to the offset arrangement of the screw sockets, only one basic flange is required between two neighboring connectors
 - The **screw flange covers** can be snapped onto the plug housing later on
 - For reliably screwing down the connector with the screw flange



Screw flange cover



General data	
Tightening torque	[Nm]
Insulating material	

Technical data	
Tightening torque	0,4 - 0,5
Insulating material	PA

Description	Color
Screw flange cover , for UP 4 COMBI plug	gray
For UP 6 COMBI plug	gray
Screw flange cover , for UPBV 2,5 and UPBV 4 COMBI plugs	gray
Screw flange cover , for SP-H ... and PP 2,5..., PP-H ...COMBI connectors	gray
Screw flange , for UT-COMBI terminal blocks, when using UPBV 2,5..., SP...2,5... or PP-H 2,5 plugs	gray
for UT 2,5/1P, UT 2,5/1P-PE	gray
for UT 2,5-TWIN/1P	gray
for UTTB 2,5/ 2P, UTTB 2,5/ 2P-PV, UTTB 2,5/ 2P-PE	gray
for UT 4/ 1P, UT 4/ 1P-PE	gray
for UT 2,5-TWIN/ 1P, UT 2,5-TWIN/ 1P-PE, UT 4-TWIN/ 1P, UT 4-TWIN/ 1P-PE	gray
for UT 4-QUATTRO/2P, UT 4-QUATTRO/2P-PE	gray
for UT 6-QUATTRO/2P, UT 6-QUATTRO/2P-PE	gray
Screw flange , for ST-COMBI terminal blocks, when using UPBV 2,5..., SP...2,5... or PP-H 2,5 plugs	gray
for ST 2,5/1P, ST 2,5/1P-PE, PT 2,5/1P, PT 2,5/1P-PE	gray
for ST 2,5/2P, ST 2,5/2P-PE, PT 2,5/2P, PT 2,5/2P-PE	gray
for ST 2,5-TWIN/1P, ST 2,5-TWIN/1P-PE, PT 2,5-TWIN/1P, PT 2,5-TWIN/1P-PE	gray
for ST 2,5-QUATTRO/2P, ST 2,5-QUATTRO/2P-PE, ST 2,5-TWIN-MT/1P, ST 2,5-TWIN-TG/1P, PT 2,5-QUATTRO/2P, PT 2,5-QUATTRO/2P-PE	gray
for ST 2,5-QUATTRO/4P, ST 2,5-QUATTRO/4P-PE	gray
for STTB 2,5/2P, STTB 2,5/2P-PV, STTB 2,5/2P-PE, PTTB 2,5/2P	gray
Screw flange , for QT-COMBI terminal blocks, when using UPBV 2,5..., SP...2,5... or PP-H 2,5 plugs	gray
for QTC 1,5/1P, QTC 1,5/1P-PE	gray
for QTTCB 1,5/ 2P, QTTCB 1,5/ 2P-PE	gray

Ordering data		
Type	Order No.	Pcs./Pkt.
DF-UP 4	3060348	50
DF-UP 6	3060856	50
DF-UPBV 2,5/ 4	3060432	50
DF-SP-H 2,5	3209824	50



Screw flange



Screw flange



Screw flange

ERIC			ERIC			ERIC		
Technical data			Technical data			Technical data		
0.4 - 0.5 PA			0.4 - 0.5 PA			0.4 - 0.5 PA		
Ordering data			Ordering data			Ordering data		
Type	Order No.	Pcs./Pkt.	Type	Order No.	Pcs./Pkt.	Type	Order No.	Pcs./Pkt.
UT 2,5/1P-F	3060445	50						
UT 2,5-TWIN/1P-F	3061172	50						
UTTB 2,5/2P-F	3060474	50						
UT 4/ 1P-F	3060458	50						
UT 4-TWIN/ 1P-F	3060322	50						
UT 4-QUATTRO/ 2P-F	3060335	50						
UT 6-QUATTRO/2P-F	3060843	50						
			ST 2,5/1P-F	3209837	50			
			ST 2,5/2P-F	3061198	50			
			ST 2,5-TWIN/1P-F	3209840	50			
			ST 2,5-QUATTRO/2P-F	3209853	50			
			ST 2,5-QUATTRO/4P-F	3061208	50			
			STTB 2,5/2P-F	3061169	50			
						QTC 1,5/1P-F	3061211	50
						QTTCB 1,5/ 2P-F	3061185	50



RT, RO bolt connection terminal blocks, and HV high-current connectors

The bolt connection terminal blocks have been developed with a particularly robust design and for the convenient wiring of ring cable lugs or fork-type cable lugs. A special characteristic of the bolt connection is the often required multi-conductor connection, on which up to four cable lugs can be connected per bolt.

All types of conductors up to 300 mm² can be wired securely and with long-term stability.

RT

The RT series is a part of the modular CLIPLINE complete range and is therefore flexible in use. The key feature of these terminal blocks is the hinged cover which can be swiveled open and which features a captive cap nut. This ensures quick and easy ring cable lug wiring.

The integrated screw locking in the form of a spring retainer guarantees safe use, even in applications which are subject to shock and vibration.

All ring cable lugs can be connected in accordance with DIN 46234, DIN 46235 or DIN 46237.

i Your web code: #1401

RBO and HV

The RBO and HV series are particularly well suited to power connections and large conductor cross sections. They are just as well suited as feed-in terminals as they are as potential distributors. Thanks to the comprehensive range of accessories, such as the pick-off terminals with Push-in connection, the broadest range of circuits can be developed.

RT product range overview

2.5 mm²

Feed-through and ground terminal blocks **379**

6 mm²

Feed-through and ground terminal blocks **381**

Test disconnect terminal blocks **382**

35 mm²

Feed-through terminal blocks **385**

RBO product range overview **386**

HV product range overview **395**

Terminal blocks – CLIPLINE complete

RT bolt connection terminal blocks

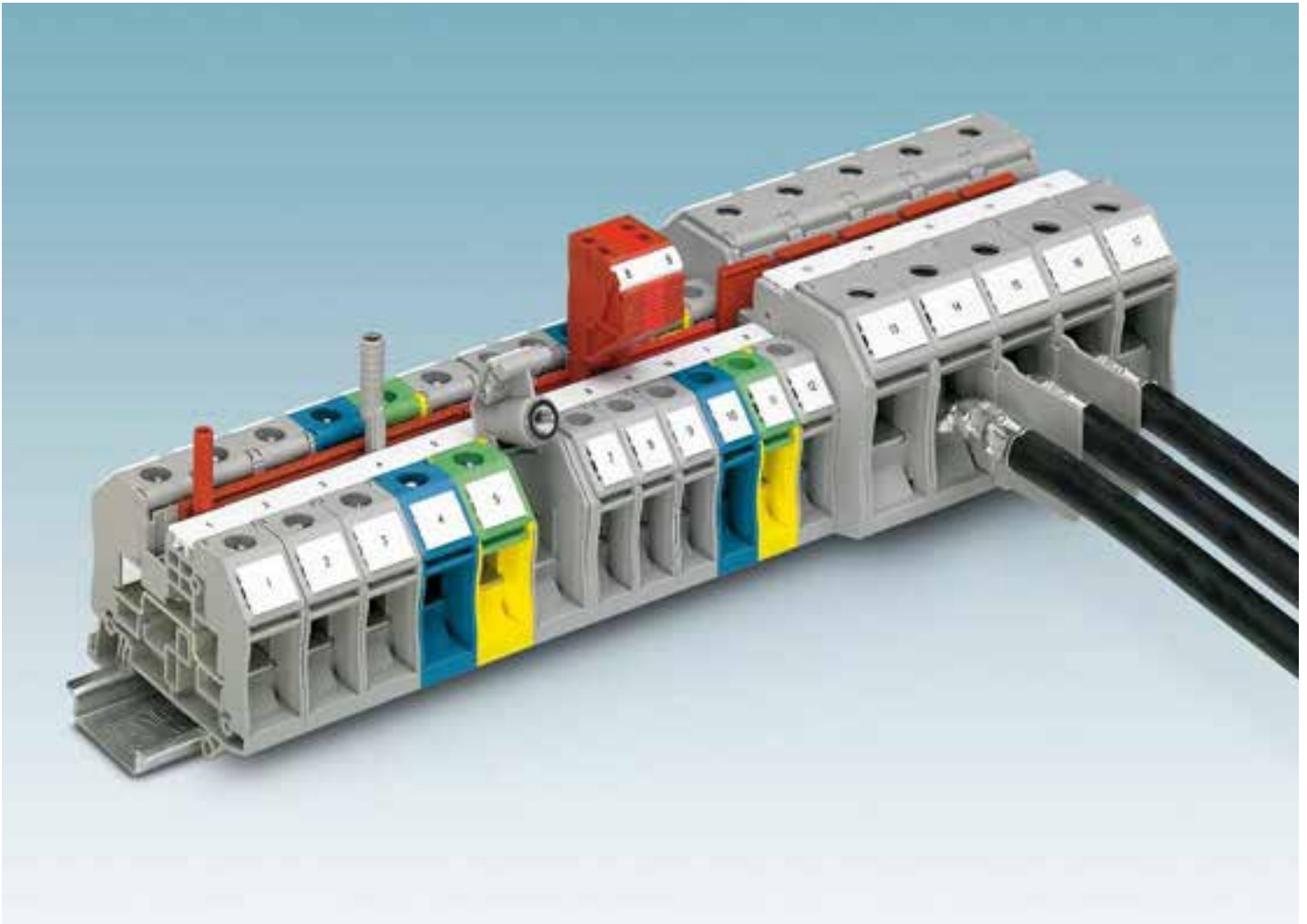

i Your web code: #1401



Robust and zero-maintenance

The bolt connection method is used in numerous applications. The benefits are:

- Robust contact
- Zero maintenance thanks to integrated screw retention
- Multiple conductor connection



Snap-on PE foot

Ground terminal blocks of the same shape are simply snapped onto the DIN rail in order to make contact. This mechanically and electrically efficient contacting meets all the requirements of the IEC 60947-7-2 standard.



Flexible plug-in bridge system

Potential can be distributed quickly using standardized plug-in bridges. Using two bridge shafts in all terminal blocks makes flexible chain and level bridging and bridging between non-adjacent terminal blocks possible.

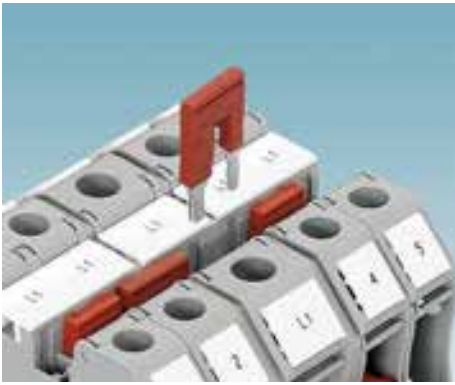

The reducing bridge enables a simple connection of terminal blocks with different nominal cross sections, e.g., an RT 8 with an RT 3 terminal block. Power blocks can be created quickly using the reducing bridge.

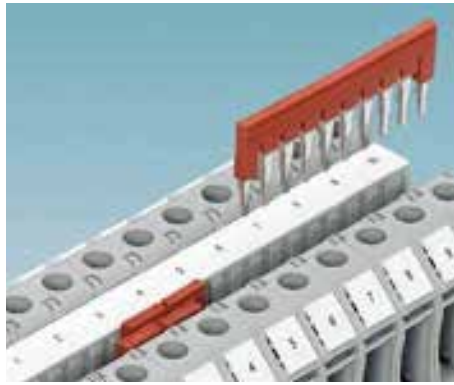

The double function shaft can be used to connect any number of terminal blocks with two-position bridges. The 2- to 50-pos. bridges allow up to 50 terminal blocks to be bridged in one step.

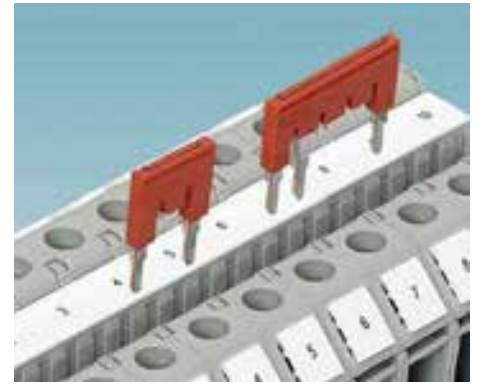

Bridging between non-adjacent terminal blocks is established by removing individual contact tabs from the standard bridge. Two potentials can then be routed in parallel through a terminal strip. The contact points can also be marked.



The RT 5-T is used in applications where the connections have to be separable. The feed-through can be opened or closed using a screwed disconnect slide without the contact points having to be released.

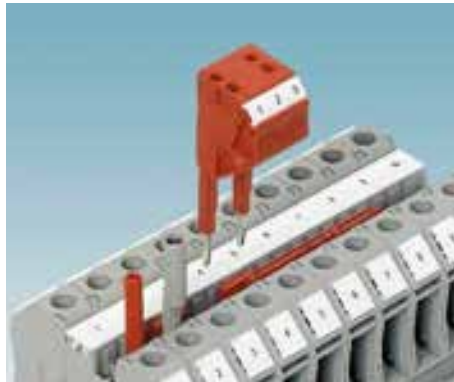

A test plug with a diameter of 2.3 mm is available for measuring lines and a test adapter with a diameter of 4 mm is available for safety test plugs. Test adapters can be implemented quickly with the alignable test plug.



Clear labeling can be easily produced with the RT terminal blocks. Large and clear marking in the middle of the terminal block guarantees reliable and quick installation.



The hinged cover typical of RT terminal blocks ensures finger protection when using an insulated cable lug. Connecting the conductor is also a much simpler process thanks to the retentive, integrated cap nut. Each terminal point can also be marked on the hinged cover itself.



The open RTO series has the same shape as the RT series. Instead of cap nuts, standard hexagonal nuts are used in the hinged cover. A version with a transparent cover ensures touch proofness. The right terminal block is therefore available for every application.



The RT and RTO terminal blocks can be wired with uninsulated cable lugs as well. These are fitted with BE-RT plug-on dividing panels to guarantee the high rated voltages.

Terminal blocks – CLIPLINE complete

2.5 mm² RT bolt connection terminal blocks

General technical data

Rated data		IEC 60947-7-1 / IEC 60947-7-2
Rated cross section	[mm ²]	2.5
Cross section range	AWG	26 - 14
Connection capacity, DIN 46234		
Cable lugs, DIN 46234	[mm ²]	0.5 - 2.5
Connection bolt / hole diameter / width	[mm]	3 / 3.2 / 6
Connection capacity, DIN 46237		
Cable lugs DIN 46237	[mm ²]	1 - 2.5
Connection bolt / hole diameter / width	[mm]	3 / 3.2 / 6
Color code	red	1.00 mm ²
Color code	blue	2.50 mm ²
General data		
Tightening torque	[Nm]	0.6 - 0.8
Bolt thread		M3
Insulating material		PA
Flammability rating in accordance with UL 94		V0

Note: Additional or deviating data is listed alongside the respective product.

Notes:



In addition to the product, the internal electrical wiring is provided as a circuit diagram. Free connection points for bridging are indicated by a black dot.

The specified technical data and approvals refer to the first product in each column. For information on the products below, please refer to phoenixcontact.net/products

For full details of UL and CSA use groups, file nos., and Internet links, please visit phoenixcontact.net/products

¹⁾ The bridge current is listed alongside the respective product. For additional colors, see page 402.

System accessories

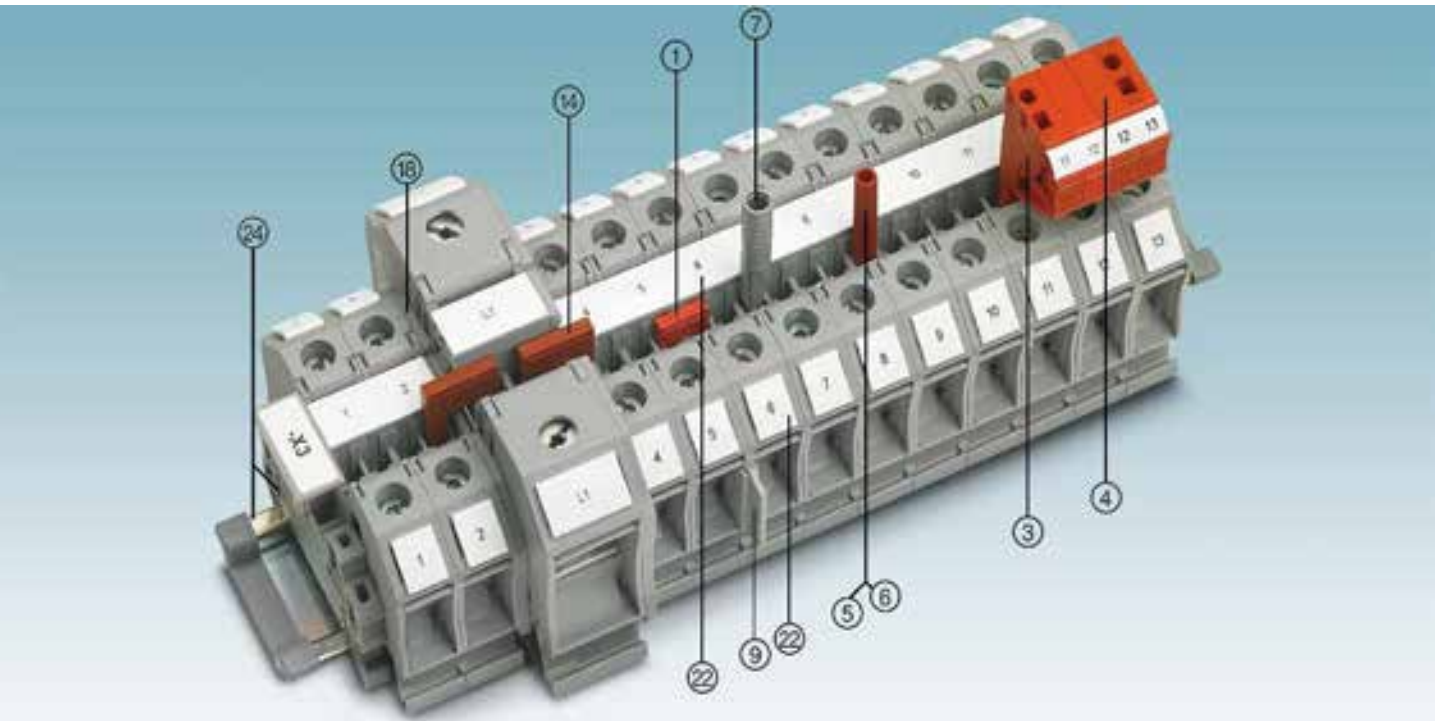

Description	No. of pos.	Color	Type	Order No.	Pcs./Pkt.	Type	Order No.	Pcs./Pkt.
① Bridge ¹⁾	2	red	FBS 2-6	3030336	50	FBSR 2-6	3033715	50
	3	red	FBS 3-6	3030242	50	FBSR 3-6	3001594	50
	4	red	FBS 4-6	3030255	50	FBSR 4-6	3001595	50
	5	red	FBS 5-6	3030349	50	FBSR 5-6	3001596	50
	10	red	FBS 10-6	3030271	10	FBSR 10-6	3033716	10
	20	red	FBS 20-6	3030365	10			
③ Modular test plug		red	PS-6	3030996	10			
④ Spacer plate		red	DP PS-6	3036738	10			
⑤ Test plug metal part		gray	MPS-MT	0201744	10			
⑥ Insulating sleeve, for MPS metal part		red	MPS-IH RD	0201676	10			
⑦ Test adapter, 4 mm socket hole		gray	PAI-4-N GY	3032871	10			
⑨ Path extension		gray	BE-RT 3/5	3049819	50			
Screwdriver			SZS 1,0X6,5 VDE	1205079	10			
Socket wrench			SHN 5.5	1209855	10			
⑭ Reducing bridge			For RB ..., see page 408.					
⑮ Cover			Listed alongside the respective product.					
⑰ Center and side groove labeling			UC-TM 8, UCT-TM 8 or ZB 8. See also Catalog 3, selection tables, from page 60.					
⑱ DIN rail and end bracket			See Catalog 3					
For full accessories, visit phoenixcontact.net/products			Note: Additional or deviating accessories are listed alongside the respective product.					

Feed-through and ground terminal blocks

Notes:
 1) For additional accessories and technical data, see page 378.
 When using multi-position PS-... test plugs that are mounted side by side, one DP PS-... spacer plate with the same pitch must be used alternately to achieve the terminal block width, see page 411.
 For CARRIER 35-8 separating disk with storage option for bridges, visit phoenixcontact.net/products.
 Further technical notes and connection conditions are to be found on page 682.
 For information on installation and using accessories for Ex applications, see page 678.

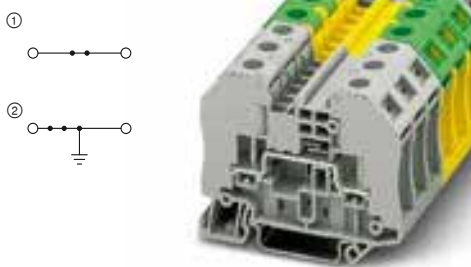

24 A, feed-through terminal block

UL ENEC CB
 Ex: EAC Ex IEC Ex
 PTB 09ATEX1003U / IECEx PTB 08.0063U

Technical data¹⁾

Width	Length	Height		
12.3	66	51 (NS 35/7,5)		
I _{max.} [A]	U _{max.} [V]	max. Ø [mm ²]	AWG (UL)	
24	1000	0.1 - 2.5	-	
32 (FBS) / 24 (FBSR)				
IEC	UL / CUL	CSA	Ex	
1000	600	-	550	
Nominal current / cross section [A] / [mm ²]		24 / 2.5	- / - 24 / 2.5	

Ordering data

Type	Order No.	Pcs./Pkt.
RT 3	① 3049013	50
RT 3 BU	① 3049110	50
RT 3-PE	② 3049411	50

Accessories¹⁾

Type	Order No.	Pcs./Pkt.
D-RT 3/5	3049097	50

Dimensions [mm]

Maximum electrical data

Maximum bridge current [A]

Rated data

Rated voltage [V]

Nominal current / cross section [A] / [mm²]

Description	Color
Terminal block	gray blue
Ground terminal	green-yellow

Cover, width: 2.2 mm	gray
----------------------	------

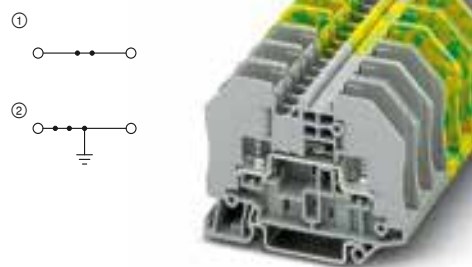

24 A, feed-through terminal block, open

UL ENEC CB
 Ex: EAC Ex IEC Ex
 PTB 09ATEX1003U / IECEx PTB 08.0063U

Technical data¹⁾

Width	Length	Height		
12.3	66	49.9 (NS 35/7,5)		
I _{max.} [A]	U _{max.} [V]	max. Ø [mm ²]	AWG (UL)	
24	1000	0.1 - 2.5	-	
32 (FBS) / 24 (FBSR)				
IEC	UL / CUL	CSA	Ex	
1000	600	-	550	
Nominal current / cross section [A] / [mm ²]		24 / 2.5	30 / - - / - 24 / 2.5	

Ordering data

Type	Order No.	Pcs./Pkt.
RTO 3	① 3049518	50
RTO 3 BU	① 3049660	50
RTO 3-PE	② 3049615	50

Accessories¹⁾

Type	Order No.	Pcs./Pkt.
D-RT 3/5	3049097	50

Feed-through and ground terminal blocks

Notes:
 1) For additional accessories and technical data, see page 378.
 Further technical notes and connection conditions are to be found on page 682.

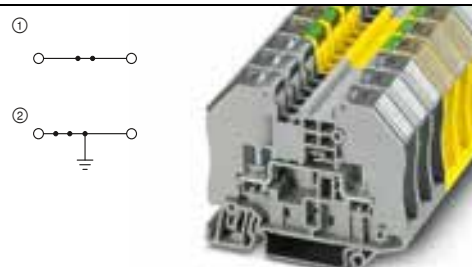

24 A, feed-through terminal block, with transparent shock protection cover

ERIC

Technical data¹⁾

Width	Length	Height		
12.3	66	51 (NS 35/7,5)		
I _{max.} [A]	U _{max.} [V]	max. Ø [mm ²]	AWG (UL)	
24	1000	0.1 - 2.5	-	
32 (FBS) / 24 (FBSR)				
IEC	UL / CUL	CSA	Ex	
1000	-	-	-	
Nominal current / cross section [A] / [mm ²]		24 / 2.5	- / - - / -	

Ordering data

Type	Order No.	Pcs./Pkt.
RTO 3-TC	① 3049945	50
RTO 3-TC BU	① 3049835	50
RTO 3-PE-TC	② 3049958	50

Accessories¹⁾

Type	Order No.	Pcs./Pkt.
D-RT 3/5	3049097	50

Dimensions [mm]

Maximum electrical data

Maximum bridge current [A]

Rated data

Rated voltage [V]

Nominal current / cross section [A] / [mm²]

Description	Color
Terminal block	gray blue
Ground terminal	green-yellow

Cover, width: 2.2 mm	gray
----------------------	------

Terminal blocks – CLIPLINE complete

6 mm² RT bolt connection terminal blocks

General technical data

Rated data		IEC 60947-7-1 / IEC 60947-7-2
Rated cross section	[mm ²]	6
Cross section range	AWG	26 - 10
Connection capacity, DIN 46234		
Cable lugs, DIN 46234	[mm ²]	0.5 - 6
Connection bolt / hole diameter / width	[mm]	5 / 5.3 / 10
Connection capacity, DIN 46237		
Cable lugs DIN 46237	[mm ²]	1 - 6
Connection bolt / hole diameter / width	[mm]	5 / 5.3 / 10
Color code		1.00 mm ² red
Color code		2.50 mm ² blue
Color code		6.00 mm ² yellow
General data		
Tightening torque	[Nm]	2.5 - 3
Bolt thread		M5
Insulating material		PA
Flammability rating in accordance with UL 94		V0
Note: Additional or deviating data is listed alongside the respective product.		

Notes:



In addition to the product, the internal electrical wiring is provided as a circuit diagram. Free connection points for bridging are indicated by a black dot.

The specified technical data and approvals refer to the first product in each column. For information on the products below, please refer to phoenixcontact.net/products

For full details of UL and CSA use groups, file nos., and Internet links, please visit phoenixcontact.net/products

¹⁾ The bridge current is listed alongside the respective product. For additional colors, see page 402.

System accessories

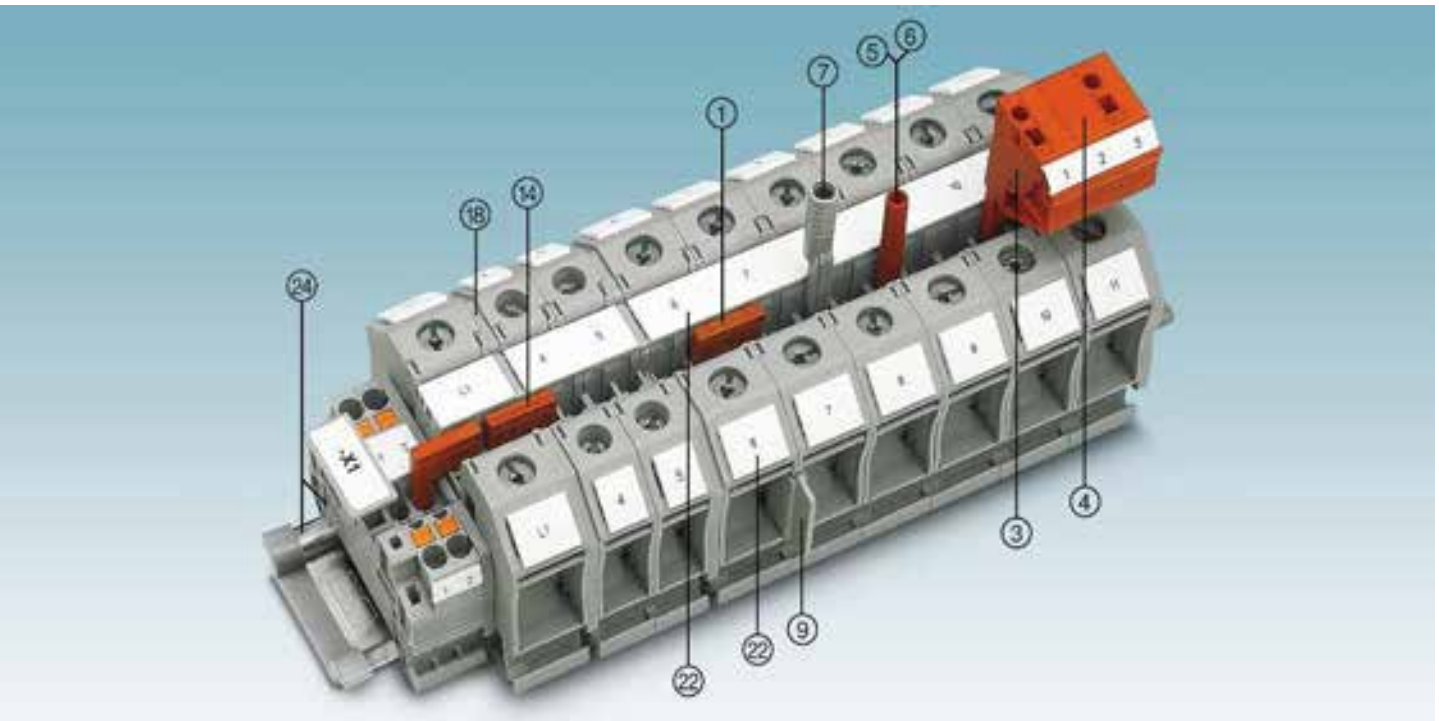

Description	No. of pos.	Color	Type	Order No.	Pcs./Pkt.	Type	Order No.	Pcs./Pkt.
① Bridge ¹⁾	2	red	FBS 2-8	3030284	10	FBSR 2-8	3033808	10
	3	red	FBS 3-8	3030297	10	FBSR 3-8	3001597	10
	4	red	FBS 4-8	3030307	10	FBSR 4-8	3000585	10
	5	red	FBS 5-8	3030310	10	FBSR 5-8	3033809	10
	10	red	FBS 10-8	3030323	10	FBSR 10-8	3001599	10
	16	red				FBSR 16-8	3033816	10
③ Modular test plug		red	PS-8	3031005	10			
④ Spacer plate		red	DP PS-8	3036741	10			
⑤ Test plug metal part		gray	MPS-MT	0201744	10			
⑥ Insulating sleeve, for MPS metal part		red	MPS-IH RD	0201676	10			
⑦ Test adapter, 4 mm socket hole		gray	PAI-4-N GY	3032871	10			
⑨ Path extension		gray	BE-RT 3/5	3049819	50			
Screwdriver			SZS 1,0X6,5 VDE	1205079	10			
Socket wrench			SHN 8	1209868	10			
⑭ Reducing bridge	For RB ..., see page 408.							
⑰ Partition plates/end cover segments	For ATP... / DS..., visit phoenixcontact.net/products							
⑱ Cover	Listed alongside the respective product.							
⑳ Center and side groove labeling	UC-TM 12, UCT-TM 12 or ZB 12. See also Catalog 3, selection tables, from page 60.							
㉑ DIN rail and end bracket	See Catalog 3							
For full accessories, visit phoenixcontact.net/products	Note: Additional or deviating accessories are listed alongside the respective product.							

Feed-through and ground terminal blocks

Notes:
 1) For additional accessories and technical data, see page 380.
 Further technical notes and connection conditions are to be found on page 682.
 For information on installation and using accessories for Ex applications, see page 678.

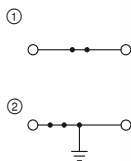

41 A, feed-through terminal block

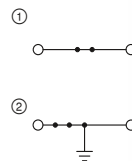

41 A, feed-through terminal block, open

UL US ENEC CB
 Ex: Ex EAC Ex

UL US ENEC CB
 Ex: Ex EAC Ex IEC Ex
 PTB 09ATEX1003U / IECEx PTB 08.0063U

Technical data ¹⁾				
Dimensions	Width	Length	Height	
	16.3	66	51 (NS 35/7,5)	
Maximum electrical data	I_{max} [A]	U_{max} [V]	max. Ø [mm ²]	AWG (UL)
	41	1000	0.1 - 6	-
Maximum bridge current	41 (FBS)			
Rated data	IEC	UL / CUL	CSA	Ex
Rated voltage	1000	600	-	550
Nominal current / cross section	41 / 6	30 / -	- / -	41 / 6

Technical data ¹⁾				
Dimensions	Width	Length	Height	
	16.3	66	49.9 (NS 35/7,5)	
Maximum electrical data	I_{max} [A]	U_{max} [V]	max. Ø [mm ²]	AWG (UL)
	41	1000	0.1 - 6	-
Maximum bridge current	41 (FBS)			
Rated data	IEC	UL / CUL	CSA	Ex
Rated voltage	1000	600	-	550
Nominal current / cross section	41 / 6	30 / -	- / -	39 / 6

Ordering data			
Type	Order No.	Pcs./Pkt.	
RT 5	3049026	①	50
RT 5 BU	3049123	①	50
RT 5-PE	3049424	②	50

Ordering data			
Type	Order No.	Pcs./Pkt.	
RTO 5	3049521	①	50
RTO 5 BU	3049767	①	50
RTO 5-TC	3049961	①	50
RTO 5-TC BU	3049851	①	50
RTO 5-PE	3049628	②	50
RTO 5-PE-TC	3049974	②	50

Accessories ¹⁾		
D-RT 3/5	3049097	50

Accessories ¹⁾		
D-RT 3/5	3049097	50

Description	Color
Terminal block	gray blue
With transparent shock-protection hood	gray blue
Ground terminal	green-yellow
With transparent shock-protection hood	green-yellow

Cover, width: 2.2 mm	gray
----------------------	------

Terminal blocks – CLIPLINE complete

6 mm² RT bolt connection terminal blocks

Test disconnect terminal blocks

Notes:

1) For additional accessories and technical data, see page 380.

2) Rated voltage for 500 V open disconnect point.

Further technical notes and connection conditions are to be found on page 682.

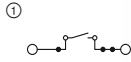

41 A, test disconnect terminal block

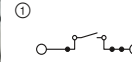

41 A, test disconnect terminal block, open



Technical data ¹⁾				
Dimensions	Width	Length	Height	
[mm]	16.3	91.4	51 (NS 35/7,5)	
Maximum electrical data	I_{max} [A]	U_{max} [V]	max. Ø [mm ²]	AWG (UL)
	41	1000 ²⁾	0.1 - 6	-
Rated data	41 (FBS) / 32 (FBSR)			
Maximum bridge current [A]	IEC	UL / CUL	CSA	Ex
Rated voltage [V]	1000 ²⁾	600	-	-
Nominal current / cross section [A] / [mm ²]	41 / 6	30 / -	- / -	- / -
General data	Tightening torque disconnect slide [Nm]			
	1.5 - 1.8			

Ordering data			
Description	Type	Order No.	Pcs./Pkt.
Test disconnect terminal block	RT 5-T	3049039	25
With transparent shock-protection hood			

Accessories ¹⁾			
Description	Type	Order No.	Pcs./Pkt.
Cover, width: 2.2 mm	D-RT 5-T	3049291	50



Technical data ¹⁾				
Dimensions	Width	Length	Height	
[mm]	16.3	91.4	49.9 (NS 35/7,5)	
Maximum electrical data	I_{max} [A]	U_{max} [V]	max. Ø [mm ²]	AWG (UL)
	41	1000 ²⁾	0.1 - 6	-
Rated data	41 (FBS) / 32 (FBSR)			
Maximum bridge current [A]	IEC	UL / CUL	CSA	Ex
Rated voltage [V]	1000 ²⁾	600	-	-
Nominal current / cross section [A] / [mm ²]	41 / 6	30 / -	- / -	- / -
General data	Tightening torque disconnect slide [Nm]			
	1.5 - 1.8			

Ordering data			
Description	Type	Order No.	Pcs./Pkt.
Test disconnect terminal block	RTO 5-T	3049233	25
With transparent shock-protection hood	RTO 5-T-TC	3049990	25

Accessories ¹⁾			
Description	Type	Order No.	Pcs./Pkt.
Cover, width: 2.2 mm	D-RT 5-T	3049291	50

Test disconnect terminal blocks

Notes:

¹⁾ For additional accessories and technical data, see page 380.

Further technical notes and connection conditions are to be found on page 682.

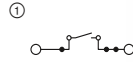

41 A, test disconnect terminal block

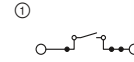

41 A, test disconnect terminal block, with transparent shock protection cover

Technical data¹⁾

Dimensions	Width	Length	Height	
	12.3	82.4	51 (NS 35/7,5)	
Maximum electrical data	I_{max} [A]	U_{max} [V]	max. Ø [mm ²]	AWG (UL)
	41	500	0.1 - 6	-
Rated data	32 (FBS) / 24 (FBSR)			
	Maximum bridge current	[A]	32 (FBS) / 24 (FBSR)	
Rated voltage	IEC	UL / CUL	CSA	Ex
	500	600	-	-
Nominal current / cross section	UL / CUL	CSA	Ex	
	41	30 / -	- / -	- / -
General data	Tightening torque	[Nm]	1.5 - 1.8	
	Bolt thread	M4		

Ordering data

Description	No. of pos.	Color	Type	Order No.	Pcs./Pkt.
Test disconnect terminal block, with test socket screws		gray	RT 4-T-P/P	3000565	25
		gray			

Accessories¹⁾

Description	No. of pos.	Color	Type	Order No.	Pcs./Pkt.
Cover, width: 2.2 mm		gray	D-RT 4-T	3000606	50
Plug-in bridge	2	red	FBS 2-6	3030336	50
	3	red	FBS 3-6	3030242	50
	4	red	FBS 4-6	3030255	50
	5	red	FBS 5-6	3030349	50
	10	red	FBS 10-6	3030271	10
Modular test plug, for the individual assembly of test pin strips	20	red	FBS 20-6	3030365	10
		red	PS-6	3030996	10
Spacer plate for test plug, for skipping individual terminal blocks during the assembly of individual test plugs, 6.2 mm wide, can be labeled with ZBF 6		red	DP PS-6	3036738	10
Screwdriver			SF-SL 0,8X4,0-100	1212551	10

Technical data¹⁾

Dimensions	Width	Length	Height	
	12.3	82.4	51 (NS 35/7,5)	
Maximum electrical data	I_{max} [A]	U_{max} [V]	max. Ø [mm ²]	AWG (UL)
	41	500	0.1 - 6	-
Rated data	32 (FBS) / 24 (FBSR)			
	Maximum bridge current	[A]	32 (FBS) / 24 (FBSR)	
Rated voltage	IEC	UL / CUL	CSA	Ex
	500	600	-	-
Nominal current / cross section	UL / CUL	CSA	Ex	
	41	30 / -	- / -	- / -
General data	Tightening torque	[Nm]	1.5 - 1.8	
	Bolt thread	M4		

Ordering data

Description	No. of pos.	Color	Type	Order No.	Pcs./Pkt.
Test disconnect terminal block, with test socket screws		gray	RT 4-T-P/P	3000565	25
		gray			
Test disconnect terminal block, with transparent shock protection cover		gray	RTO 4-T-TC	3000558	25
		gray			

Accessories¹⁾

Description	No. of pos.	Color	Type	Order No.	Pcs./Pkt.
Cover, width: 2.2 mm		gray	D-RT 4-T	3000606	50
Plug-in bridge	2	red	FBS 2-6	3030336	50
	3	red	FBS 3-6	3030242	50
	4	red	FBS 4-6	3030255	50
	5	red	FBS 5-6	3030349	50
	10	red	FBS 10-6	3030271	10
Modular test plug, for the individual assembly of test pin strips	20	red	FBS 20-6	3030365	10
		red	PS-6	3030996	10
Spacer plate for test plug, for skipping individual terminal blocks during the assembly of individual test plugs, 6.2 mm wide, can be labeled with ZBF 6		red	DP PS-6	3036738	10
Screwdriver			SF-SL 0,8X4,0-100	1212551	10

Terminal blocks – CLIPLINE complete

35 mm² RT bolt connection terminal blocks

General technical data

Rated data		IEC 60947-7-1
Rated cross section	[mm ²]	35
Cross section range	AWG	14 - 2
Connection capacity, DIN 46234		
Cable lugs, DIN 46234	[mm ²]	2.5 - 35
Connection bolt / hole diameter / width	[mm]	8 / 8.4 / 16
Connection capacity, DIN 46237		
Cable lugs DIN 46237	[mm ²]	2.5 - 6
Connection bolt / hole diameter / width	[mm]	8 / 8.4 / 14
Color code		2.50 mm ²
Color code	yellow	6.00 mm ²
General data		
Tightening torque	[Nm]	4.5 - 5
Bolt thread		M8
Insulating material		PA
Flammability rating in accordance with UL 94		V0

Note: Additional or deviating data is listed alongside the respective product.

Notes:



In addition to the product, the internal electrical wiring is provided as a circuit diagram. Free connection points for bridging are indicated by a black dot.

The specified technical data and approvals refer to the first product in each column. For information on the products below, please refer to phoenixcontact.net/products

For full details of UL and CSA use groups, file nos., and Internet links, please visit phoenixcontact.net/products

¹⁾ The bridge current is listed alongside the respective product. For additional colors, see page 402.

System accessories

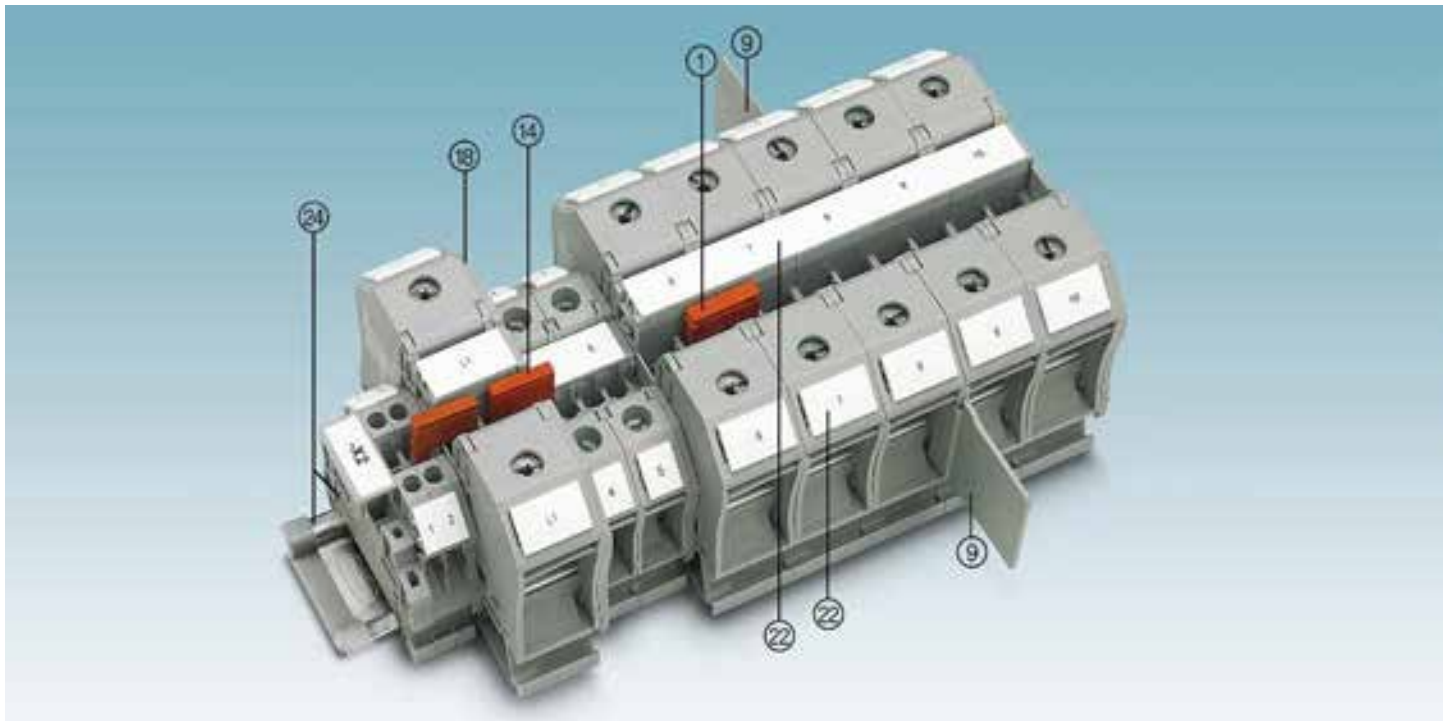

Description	No. of pos.	Color	Type	Order No.	Pcs./Pkt.	Type	Order No.	Pcs./Pkt.
① Bridge ¹⁾	2	red	FBS 2-10	3005947	10			
③ Path extension		gray	BE-RT 8	3049916	50			
Socket wrench			SHN 13	1209923	10			
④ Reducing bridge			For RB ..., see page 408.					
⑧ Cover			Listed alongside the respective product.					
⑫ Center and side groove labeling			UC-TM 16, UCT-TM 16 or ZB 16,3. See also Catalog 3, selection tables from page 60.					
⑳ DIN rail and end bracket			See Catalog 3					
For full accessories, visit phoenixcontact.net/products			Note: Additional or deviating accessories are listed alongside the respective product.					

Feed-through terminal blocks

Notes:
 1) For additional accessories and technical data, see page 384.
 Further technical notes and connection conditions are to be found on page 682.
 For information on installation and using accessories for Ex applications, see page 678.



125 A, feed-through terminal block

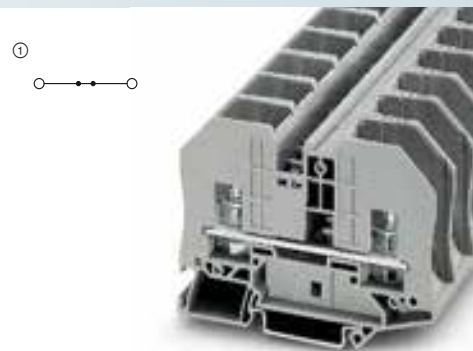

125 A, feed-through terminal block, open

UL US ENEC CB
 Ex: EAC Ex IEC Ex
 PTB 09ATEX1003U / IECEx PTB 08.0063U

Technical data ¹⁾				
Dimensions	Width	Length	Height	
	20.3	84	63.8 (NS 35/7,5)	
Maximum electrical data	I_{max} [A]	U_{max} [V]	max. \varnothing [mm ²]	AWG (UL)
	125	1000	2.5 - 35	-
Rated data	Maximum bridge current [A]	57	IEC	UL / CUL
	Rated voltage [V]	1000	600	-
	Nominal current / cross section [A] / [mm ²]	125 / 35	130 / -	- / -
General data	Tightening torque [Nm]	4.5 - 5		

Ordering data			
Description	Type	Order No.	Pcs./Pkt.
Terminal block	RT 8	3049042	25
With transparent shock-protection hood	RT 8 BU	3049148	25

Accessories ¹⁾		
Cover, width: 2.2 mm	Type	Order No.
	D-RT 8	3049194

UL US ENEC CB
 Ex: EAC Ex IEC Ex
 PTB 09ATEX1003U / IECEx PTB 08.0063U

Technical data ¹⁾				
Dimensions	Width	Length	Height	
	20.3	84	62.2 (NS 35/7,5)	
Maximum electrical data	I_{max} [A]	U_{max} [V]	max. \varnothing [mm ²]	AWG (UL)
	125	1000	2.5 - 35	-
Rated data	Maximum bridge current [A]	57	IEC	UL / CUL
	Rated voltage [V]	1000	600	-
	Nominal current / cross section [A] / [mm ²]	125 / 35	115 / -	- / -
General data	Tightening torque [Nm]	6 - 10		

Ordering data			
Description	Type	Order No.	Pcs./Pkt.
Terminal block	RTO 8	3049343	25
With transparent shock-protection hood	RTO 8 BU	3049864	25
	RTO 8-TC	3050002	25
	RTO 8-TC BU	3049929	25

Accessories ¹⁾		
Cover, width: 2.2 mm	Type	Order No.
	D-RT 8	3049194

Terminal blocks – CLIPLINE complete

RBO bolt connection terminal blocks



i Your web code: #1401



Extensive program

The RBO product range offers a suitable compact terminal block with bolt connection from M5 to M16 for every conductor connection from 0.5 - 300 mm²

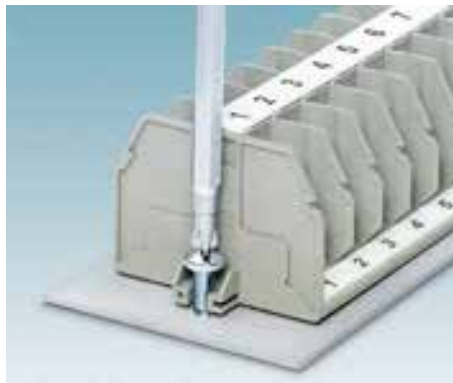

Flexible assembly

The bolt connection terminal blocks offer two mounting options:

- Can be snapped onto the conventional EN DIN rails
- Direct mounting on mounting plates



Modular shock protection

Using the extensive range of accessories, modular shock protection can be implemented easily and in accordance with application requirements.

RBO 5... bolt connection terminals, for M5 ring and fork-type cable lugs

- Compact connection with ring- and fork-type cable lugs
- Bridge shaft for potential distribution using standard screw bridges
- Bridge bar isolator switching bridge for switchable cross connections
- Mounting on standard DIN rails or directly in control boxes

Notes:

¹⁾ 57 A for continuous bridging, 41 A for bridging between non-adjacent terminal blocks

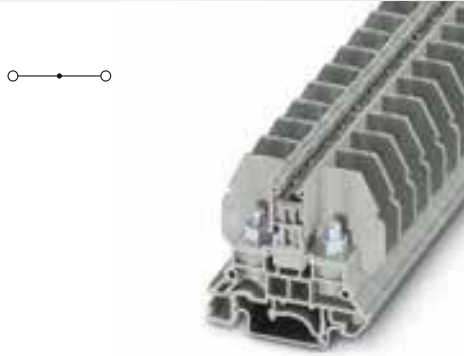

10 (10) mm², 57 A, feed-through terminal block for DIN rail mounting

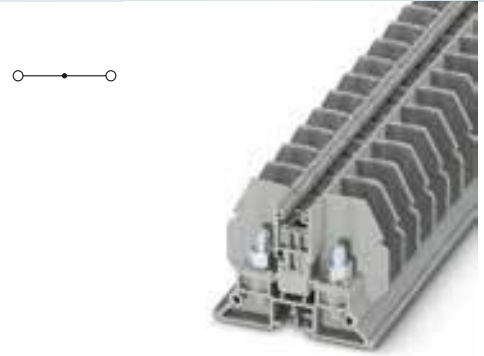

10 (10) mm², 57 A, feed-through terminal block for direct mounting



Technical data				
Dimensions	Width [mm]	Length [mm]	Height NS 35/7,5 [mm]	
	13	53.3	47	
Dimensions	Width [mm]	Length [mm]	Height NS 32 [mm]	
	13	53.3	52	
Dimensions	Width [mm]	Length [mm]	Height [mm]	
	13	53.3	-	
Maximum electrical data	I _{max} [A]	U _{max} [V]	max. Ø [mm ²]	AWG (UL)
	57	800	0.1 - 10	-
Rated data	IEC 60947-7-1			
	IEC	UL / CUL	CSA	IEC/ EN 60079-7
Rated voltage [V]	800	600	-	-
Nominal current / cross section [A] / [mm ²]	57 / 10	45 / -	-	-
Rated cross section [mm ²]	10	-	-	-
Cross section range AWG	26 - 8	-	-	-
Connection capacity, DIN 46234	IEC 60947-7-1			
Cable lugs, DIN 46234 [mm ²]	0.1 - 10			
Connection bolt / hole diameter / width [mm]	5 / 5.3 / 10			
Connection capacity, DIN 46237	IEC 60947-7-1			
Cable lugs DIN 46237 [mm ²]	0.5 - 6			
Connection bolt / hole diameter / width [mm]	5 / 5.3 / 10			
Color code	red	1.00 mm ²		
	blue	2.50 mm ²		
	yellow	6.00 mm ²		
General data	M5			
Bolt thread	2 - 2.2			
Tightening torque [Nm]	PA			
Insulating material	V0			
Flammability rating in accordance with UL 94				



Technical data				
Dimensions	Width [mm]	Length [mm]	Height NS 35/7,5 [mm]	
	13	53.3	-	
Dimensions	Width [mm]	Length [mm]	Height NS 32 [mm]	
	13	53.3	-	
Dimensions	Width [mm]	Length [mm]	Height [mm]	
	13	53.3	37	
Maximum electrical data	I _{max} [A]	U _{max} [V]	max. Ø [mm ²]	AWG (UL)
	57	800	0.1 - 10	-
Rated data	IEC 60947-7-1			
	IEC	UL / CUL	CSA	IEC/ EN 60079-7
Rated voltage [V]	800	600	-	-
Nominal current / cross section [A] / [mm ²]	57 / 10	45 / -	-	-
Rated cross section [mm ²]	10	-	-	-
Cross section range AWG	26 - 8	-	-	-
Connection capacity, DIN 46234	IEC 60947-7-1			
Cable lugs, DIN 46234 [mm ²]	0.1 - 10			
Connection bolt / hole diameter / width [mm]	5 / 5.3 / 10			
Connection capacity, DIN 46237	IEC 60947-7-1			
Cable lugs DIN 46237 [mm ²]	0.5 - 6			
Connection bolt / hole diameter / width [mm]	5 / 5.3 / 10			
Color code	red	1.00 mm ²		
	blue	2.50 mm ²		
	yellow	6.00 mm ²		
General data	M5			
Bolt thread	2 - 2.2			
Tightening torque [Nm]	PA			
Insulating material	V0			
Flammability rating in accordance with UL 94				

Ordering data

Description	No. of pos.	Color	Type	I _{max}	Order No.	Pcs./Pkt.
Bolt connection terminal, for mounting on NS 32... or NS 35...		gray	RBO 5		3058059	50
Flange terminal block, for direct mounting, including D-RSC 5-F cover flange		gray				
Flange terminal block, for direct mounting, including D-RSC 5-F cover flange, 4-pos.		gray				
Block, 6-pos.		gray				
Block, 8-pos.		gray				
Block, 12-pos.		gray				

Ordering data

Type	I _{max}	Order No.	Pcs./Pkt.
RBO 5-F		3058062	50
RBO 5-F/4		3058237	1
RBO 5-F/6		3058240	1
RBO 5-F/8		3058253	1
RBO 5-F/12		3059252	1

Accessories

Accessories	Order No.	Pcs./Pkt.
Cover, width: 2.2 mm	3058020	50
Cover flange, width: 2.2 mm		
Fixed bridge, isolated		
Isolator bridge bar, can be separated, with 10 screws		
Separating disk, for separation of neighboring bridges, can be fitted later, no loss of pitch		
Cover profile, supply length 1 m		transparent
Socket wrench		
Center groove labeling	ZB 13 (see Catalog 3)	
Lateral groove labeling	ZBF 13 (see Catalog 3)	

Accessories

Accessories	Order No.	Pcs./Pkt.
D-RSC 5	3058020	50
D-RSC 5-F	3059647	50
FB 10-13	3059126	10
FB 10-13 ISO	3059663	10
TS-KK 3	2770215	50
AP RSC	3058017	10
SHN 8	1209868	10
ZB 13 (see Catalog 3)		
ZBF 13 (see Catalog 3)		

Terminal blocks – CLIPLINE complete

RBO bolt connection terminal blocks

Measuring transducer disconnect terminal blocks with blocks connection RBO 5-T..., for M5 ring- and fork-type cable lugs

- Connection screws with 4 mm test connection
- Compact connection with ring- and fork-type cable lugs
- Bridge shaft for potential distribution using standard screw bridges
- Bridge bar isolator switching bridge for switchable cross connections
- Mounting on standard DIN rails or directly in control boxes

Notes:
1) 57 A for continuous bridging, 41 A for bridging between non-adjacent terminal blocks
2) Rated voltage for 630 V open disconnect point

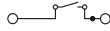

10 (10) mm², 50 A, test disconnect terminal block

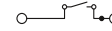

10 (10) mm², 50 A, test disconnect terminal block, for direct mounting



Dimensions		[mm]
Dimensions		[mm]
Dimensions		[mm]
Maximum electrical data		
Rated data		
Rated voltage	[V]	800 ²⁾
Nominal current / cross section	[A] / [mm ²]	50 / 10
Rated cross section	[mm ²]	10
Cross section range	AWG	26 - 8
Connection capacity, DIN 46234		
Cable lugs, DIN 46234	[mm ²]	0.1 - 10
Connection bolt / hole diameter / width	[mm]	5 / 5.3 / 10
Connection capacity, DIN 46237		
Cable lugs DIN 46237	[mm ²]	0.5 - 6
Connection bolt / hole diameter / width	[mm]	5 / 5.3 / 10
Color code		red 1.00 mm ² blue 2.50 mm ² yellow 6.00 mm ²
General data		
Disconnect slide: Thread / torque	- / [Nm]	M4 / 1.2 - 1.4
Bolt thread		M5
Tightening torque	[Nm]	2 - 2.2
Insulating material		PA
Flammability rating in accordance with UL 94		V0

Technical data			
Width	Length	Height NS 35/7,5	
13	79.9	47	
Width	Length	Height NS 32	
13	79.9	52	
Width	Length	Height	
13	79.9	-	
I _{max} [A]	U _{max} [V]	max. Ø [mm ²]	AWG (UL)
50	800 ²⁾	0.1 - 10	-
IEC 60947-7-1			
IEC	UL / CUL	CSA	IEC/ EN 60079-7
800 ²⁾	600	-	-
50 / 10	45 / -	-	-
10	-	-	-
26 - 8	-	-	-

Technical data			
Width	Length	Height NS 35/7,5	
13	79.9	-	
Width	Length	Height NS 32	
13	79.9	-	
Width	Length	Height	
13	79.9	39.7	
I _{max} [A]	U _{max} [V]	max. Ø [mm ²]	AWG (UL)
50	800 ²⁾	0.1 - 10	-
IEC 60947-7-1			
IEC	UL / CUL	CSA	IEC/ EN 60079-7
800 ²⁾	600	-	-
50 / 10	45 / -	-	-
10	-	-	-
26 - 8	-	-	-

Description	No. of pos.	Color
Test disconnect terminal block, for mounting on NS 32... or NS 35...		gray
Test disconnect terminal block, with flange, for direct mounting		gray

Ordering data			
Type	I _{max}	Order No.	Pcs./Pkt.
RBO 5-T		3058114	50
RBO 5-T-F		3058169	50

Ordering data			
Type	I _{max}	Order No.	Pcs./Pkt.
RBO 5-T-F		3058169	50

Accessories	No. of pos.	Color
Cover, width: 2.2 mm		gray
Fixed bridge, isolated	10	silver
Isolator bridge bar, can be separated, with 10 screws	10	silver
Separating disk, for separation of neighboring bridges, can be fitted later, no loss of pitch		gray
Cover profile, supply length 1 m		transparent
Screwdriver		
Center groove labeling		
Lateral groove labeling		

Accessories			
Type	I _{max}	Order No.	Pcs./Pkt.
D-RSC 5-T		3058046	50
FB 10-13	57 A ¹⁾	3059126	10
FB 10-13 ISO	24 A	3059663	10
TS-KK 3		2770215	50
AP RSC-T		3059139	10
SZG 0,9X6,5 VDE		1205134	10
ZB 13 (see Catalog 3)			
ZBF 13 (see Catalog 3)			

Accessories			
Type	I _{max}	Order No.	Pcs./Pkt.
D-RSC 5-T-F		3059346	50
FB 10-13	57 A ¹⁾	3059126	10
FB 10-13 ISO	24 A	3059663	10
TS-KK 3		2770215	50
AP RSC-T		3059139	10
SZG 0,9X6,5 VDE		1205134	10
ZB 13 (see Catalog 3)			
ZBF 13 (see Catalog 3)			

Bolt connection terminal blocks RBO 6..., for M6 ring- and fork-type cable lugs

- Compact connection with ring- and fork-type cable lugs
- Bridge shaft for potential distribution using standard screw bridges
- Bridge bar isolator switching bridge for switchable cross connections
- Mounting on standard DIN rails or directly in control boxes

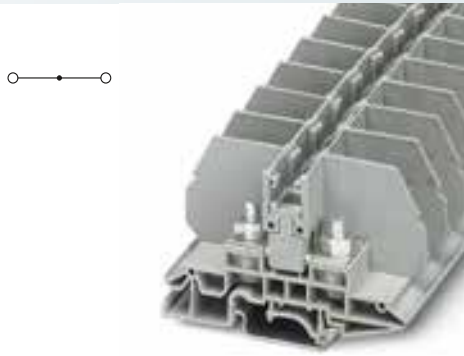

35 (35) mm², 125 A, feed-through terminal block, for DIN rail mounting

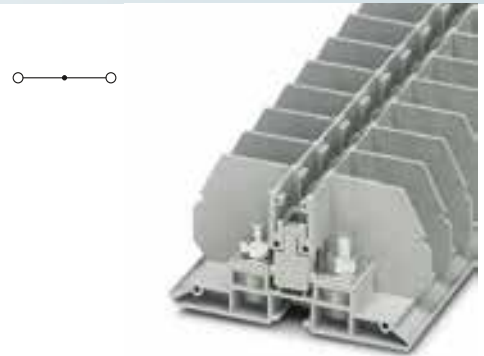

35 (35) mm², 125 A, feed-through terminal block, for direct mounting



		Technical data			
Dimensions		Width	Length	Height NS 35/7,5	
	[mm]	17	80.8	49.8	
Dimensions		Width	Length	Height NS 32	
	[mm]	17	80.8	54.8	
Dimensions		Width	Length	Height	
	[mm]	17	80.8	-	
Maximum electrical data		I _{max} [A]	U _{max} [V]	max. Ø [mm ²]	AWG (UL)
		125	800	2.5 - 35	-
Rated data		IEC 60947-7-1			
		IEC	UL / CUL	CSA	IEC/ EN 60079-7
Rated voltage	[V]	800	600	600	-
Nominal current / cross section	[A] / [mm ²]	125 / 35	115 / -	115 / -	-
Rated cross section	[mm ²]	35	-	-	-
Cross section range	AWG	12 - 2	-	12-2	-
Connection capacity, DIN 46234					
Cable lugs, DIN 46234	[mm ²]	6 - 35			
Connection bolt / hole diameter / width	[mm]	6 / 6.5 / 15			
Connection capacity, DIN 46237					
Cable lugs DIN 46237	[mm ²]	2.5 - 6			
Connection bolt / hole diameter / width	[mm]	6 / 6.5 / 11			
	blue	2.50 mm ²			
	yellow	6.00 mm ²			
General data					
Bolt thread		M6			
Tightening torque	[Nm]	3.2 - 3.7			
Insulating material		PA			
Flammability rating in accordance with UL 94		V0			

		Technical data			
Dimensions		Width	Length	Height NS 35/7,5	
	[mm]	17	80.8	-	
Dimensions		Width	Length	Height NS 32	
	[mm]	17	80.8	-	
Dimensions		Width	Length	Height	
	[mm]	17	80.8	39.7	
Maximum electrical data		I _{max} [A]	U _{max} [V]	max. Ø [mm ²]	AWG (UL)
		125	800	2.5 - 35	-
Rated data		IEC 60947-7-1			
		IEC	UL / CUL	CSA	IEC/ EN 60079-7
Rated voltage	[V]	800	600	600	-
Nominal current / cross section	[A] / [mm ²]	125 / 35	115 / -	115 / -	-
Rated cross section	[mm ²]	35	-	-	-
Cross section range	AWG	12 - 2	-	12-2	-
Connection capacity, DIN 46234					
Cable lugs, DIN 46234	[mm ²]	6 - 35			
Connection bolt / hole diameter / width	[mm]	6 / 6.5 / 15			
Connection capacity, DIN 46237					
Cable lugs DIN 46237	[mm ²]	2.5 - 6			
Connection bolt / hole diameter / width	[mm]	6 / 6.5 / 11			
	blue	2.50 mm ²			
	yellow	6.00 mm ²			
General data					
Bolt thread		M6			
Tightening torque	[Nm]	3.2 - 3.7			
Insulating material		PA			
Flammability rating in accordance with UL 94		V0			

			Ordering data			
Description	No. of pos.	Color	Type	I _{max}	Order No.	Pcs./Pkt.
Bolt connection terminal , for mounting on NS 32... or NS 35...		gray	RBO 6		3075896	40
Flange terminal block , for direct mounting, including cover flange D-RSC 6-F		gray				

			Ordering data			
Description	No. of pos.	Color	Type	I _{max}	Order No.	Pcs./Pkt.
Bolt connection terminal , for mounting on NS 32... or NS 35...		gray	RBO 6		3075896	40
Flange terminal block , for direct mounting, including cover flange D-RSC 6-F		gray	RBO 6-F		3075935	40

			Accessories			
Cover, width: 2.2 mm		gray	D-RSC 6		3213098	50
Cover flange, width: 2.2 mm		gray				
Fixed bridge, isolated	10	silver	FB 10-17	57 A	3075951	10
Isolator bridge bar, can be separated, with 10 screws						
	10	silver	FB 10-17 ISO	57 A	3213085	10
Separating disk, for separation of neighboring bridges, can be fitted later, no loss of pitch		gray	TS-KK 3		2770215	50
Cover profile, supply length 1 m		transparent	AP RSC-T		3059139	10

			Accessories			
Cover, width: 2.2 mm		gray	D-RSC 6-F		3213108	50
Cover flange, width: 2.2 mm		gray				
Fixed bridge, isolated	10	silver	FB 10-17	57 A	3075951	10
Isolator bridge bar, can be separated, with 10 screws						
	10	silver	FB 10-17 ISO	57 A	3213085	10
Separating disk, for separation of neighboring bridges, can be fitted later, no loss of pitch		gray	TS-KK 3		2770215	50
Cover profile, supply length 1 m		transparent	AP RSC-T		3059139	10

Center groove labeling	ZB 17 (see Catalog 3)
Lateral groove labeling	ZBF 17 (see Catalog 3)

Center groove labeling	ZB 17 (see Catalog 3)
Lateral groove labeling	ZBF 17 (see Catalog 3)

RBO bolt connection terminal blocks

RBO bolt connection terminal blocks, open, for ring- and fork-type cable lugs



- Optional snap-on finger protection
- Compact connection with ring- and fork-type cable lugs
- Potential distribution with connection rails
- The covering hoods for the RBO 10, RBO 12, and RBO 16 bolt terminal blocks can be sealed to prevent unauthorized opening. The lugs that can be snapped on for this purpose are supplied as standard with the covering hoods
- The RBO 10, RBO 12, and RBO 16 have a 4 mm test connection at the center of the terminal block

Mounting options

- Mounting either on standard mounting rails or directly in switch boxes, see Figure below



Notes:
For corresponding test plugs, see the following page.
1) For information on installation and using accessories for Ex applications, see page 678.

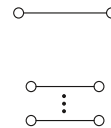

70 (70) mm², 192 A, feed-through terminal block, for DIN rail and direct mounting

Ex: EAC Ex IEC Ex

 SEV13ATEX0132U / IECEx SEV13.0003U

Dimensions		[mm]	
Maximum electrical data			
Rated data			
Rated voltage	[V]	1000	
Nominal current / cross section	[A] / [mm ²]	192 / 70	
Rated cross section	[mm ²]	70	
Cross section range	AWG	8 - 2/0	
Connection capacity, DIN 46234			
Cable lugs, DIN 46234	[mm ²]	2.5 - 70	
Connection bolt / hole diameter / width	[mm]	8 / 8.4 / 22	
Connection capacity, DIN 46235			
Cable lugs DIN 46235	[mm ²]	16 - 70	
Connection bolt / hole diameter / width	[mm]	8 / 8.4 / 24	
Connection capacity, DIN 46237			
Cable lugs DIN 46237	[mm ²]	2.5 - 6	
Connection bolt / hole diameter / width	[mm]	8 / 8.4 / 14	
	blue	2.50 mm ²	
	yellow	6.00 mm ²	
General data			
Bolt thread		M8	
Tightening torque	[Nm]	6 - 12	
Insulating material		PA	
Flammability rating in accordance with UL 94		V0	

Technical data			
Width	Length	Height NS 35/15	
29	136	74.5	
I_{max} [A]	U_{max} [V]	max. \varnothing [mm ²]	AWG (UL)
192	1000	6 - 70	-
IEC 60947-7-1			
IEC	UL / CUL	CSA	IEC / EN 60079-7
			690
			187 / 70
			2.5-70

Description	No. of pos.	Color
Bolt connection terminal block , for direct mounting or mounting on NS 35/15		gray
		blue
		black/yellow
Block, 4-pos., (3 x gray, 1 x blue)		gray/blue
Block, 5-pos., (3 x gray, 1 x blue, 1 x black-yellow)		gray/blue/black-yellow

Connection rail, for cross connection of high-current connectors		
	2	silver
	3	silver
Covering hood , as retrofit snap-on shock protection for cable lug connection		gray
		blue
		black/yellow
End bracket , aluminum, for screwing on, for end support of 50 - 300 mm ² terminal blocks, can be marked with ZB 10, for mounting on NS 35...		silver
Terminal strip marker , adjustable height, for end clamp CLIPFIX ..., can be labeled with EML (20x8) label or directly with B-STIFT or X-PEN		gray
Center groove labeling		

Ordering data			
Type	I_{max}	Order No.	Pcs./Pkt.
RBO 8		3213137	5
RBO 8 BU		3213136	5
RBO 8-FE		3213139	5
RBO 8-3L/N/FE		3076280	2

Accessories ¹⁾			
RBO 8-VS 2	192 A	3213179	10
RBO 8-VS 3	192 A	3213182	10
HC-RBO 8		3247967	10
HC-RBO 8 BU		3247969	10
HC-RBO 8-FE		3247968	10
E/AL-NS 35		1201662	10
UC-TM 12, UCT-TM 12 or ZB 12 (see Catalog 3)			

RBO bolt connection terminal blocks

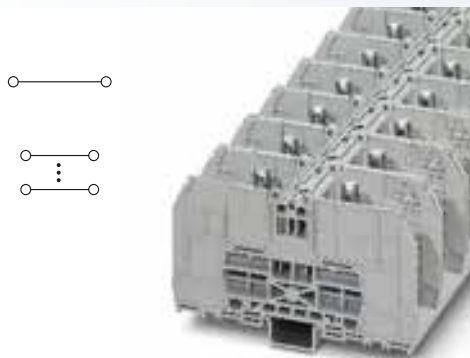

150 (150) mm², 309 A, feed-through terminal block, for DIN rail and direct mounting

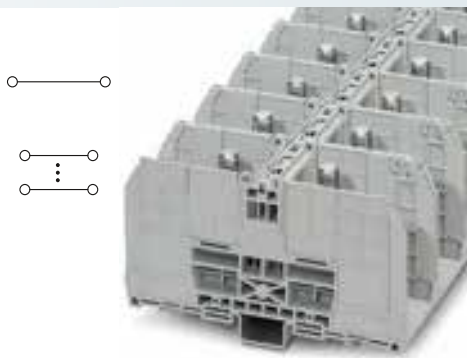

240 (240) mm², 415 A, feed-through terminal block, for DIN rail and direct mounting

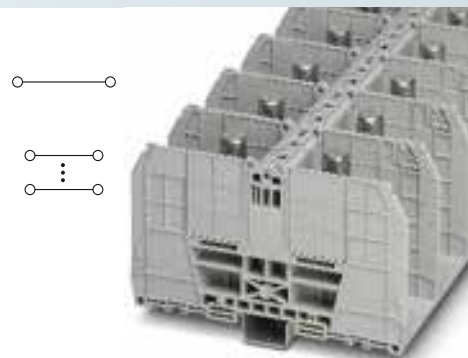

300 (300) mm², 520 A, feed-through terminal block, for DIN rail and direct mounting



Ex: EAC Ex IEC RoHS
SEV13ATEX0132U / IECEx SEV13.0003U



Ex: EAC Ex IEC RoHS
SEV13ATEX0132U / IECEx SEV13.0003U



Ex: EAC Ex IEC RoHS
SEV13ATEX0132U / IECEx SEV13.0003U

Technical data			
Width	Length	Height NS 35/15	
41	144	84.5	
I_{max} [A]	U_{max} [V]	max. Ø [mm ²]	AWG (UL)
309	1000	6 - 150	10-350
IEC 60947-7-1			
IEC	UL / CUL	CSA	IEC/ EN 60079-7
1000	600	1000	1100
309 / 150	310 / -	310 / -	309 / 150
150	-	-	6-150
10 - 300	10-350	10-350	-
6 - 150			
10 / 10.5 / 30			
16 - 150			
10 / 10.5 / 34			
6 - 6			
10 / 10.5 / 18			
6.00 mm ²			
M10			
10 - 20			
PA			
V0			

Technical data			
Width	Length	Height NS 35/15	
49	164	90.8	
I_{max} [A]	U_{max} [V]	max. Ø [mm ²]	AWG (UL)
415	1000	10 - 240	8-600
IEC 60947-7-1			
IEC	UL / CUL	CSA	IEC/ EN 60079-7
1000	600	1000	1100
415 / 240	420 / -	420 / -	415 / 240
240	-	-	10-240
8 - 500	8-600	8-600	-
10 - 240			
12 / 13 / 38			
25 - 240			
12 / 13 / 42			
-			
- / - / -			
M12			
14 - 30			
PA			
V0			

Technical data			
Width	Length	Height NS 35/15	
54.8	164	99.3	
I_{max} [A]	U_{max} [V]	max. Ø [mm ²]	AWG (UL)
520	1000	25 - 300	4-1000
IEC 60947-7-1			
IEC	UL / CUL	CSA	IEC/ EN 60079-7
1000	600	1000	1100
520 / 300	540 / -	540 / -	520 / 300
300	-	-	25-300
4 - 600	4-1000	4-1000	-
25 - 240			
16 / 17 / 38			
50 - 300			
16 / 17 / 48			
-			
- / - / -			
M16			
25 - 35			
PA			
V0			

Ordering data			
Type	I_{max}	Order No.	Pcs./Pkt.
RBO 10		3244614	5
RBO 10 BU		3244616	5
RBO 10-FE		3244615	5

Ordering data			
Type	I_{max}	Order No.	Pcs./Pkt.
RBO 12		3244627	5
RBO 12 BU		3244629	5
RBO 12-FE		3244628	5

Ordering data			
Type	I_{max}	Order No.	Pcs./Pkt.
RBO 16		3244630	5
RBO 16 BU		3244632	5
RBO 16-FE		3244631	5
RBO 16-3L/N		3076277	1

Accessories ¹⁾			
Type		Order No.	Pcs./Pkt.
RBO 10-VS 2	309 A	3244643	10
RBO 10-VS 3	309 A	3244656	10
HC-RBO 10		3247970	6
HC-RBO 10 BU		3247972	6
HC-RBO 10-FE		3247971	6
E/AL-NS 35		1201662	10
KLM 3-L		0814788	100

Accessories ¹⁾			
Type		Order No.	Pcs./Pkt.
RBO 12-VS 2	415 A	3244669	10
RBO 12-VS 3	415 A	3244672	10
HC-RBO 12		3247983	6
HC-RBO 12 BU		3247985	6
HC-RBO 12-FE		3247984	6
E/AL-NS 35		1201662	10
KLM 3-L		0814788	100

Accessories ¹⁾			
Type		Order No.	Pcs./Pkt.
RBO 16-VS 2	520 A	3244685	10
RBO 16-VS 3	520 A	3244698	10
HC-RBO 16		3247996	6
HC-RBO 16 BU		3247998	6
HC-RBO 16-FE		3247997	6
E/AL-NS 35		1201662	10
KLM 3-L		0814788	100

UC-TM 12, UCT-TM 12 or ZB 12
(see Catalog 3)

UC-TM 12, UCT-TM 12 or ZB 12
(see Catalog 3)

UC-TM 12, UCT-TM 12 or ZB 12
(see Catalog 3)

RBO bolt connection terminal blocks

RBO bolt connection terminal blocks with covering hoods, for ring- and fork-type cable lugs



- With protective covers
- Compact connection with ring- and fork-type cable lugs
- Potential distribution with connection rails
- The covering hoods for the RBO 10, RBO 12, and RBO 16 bolt terminal blocks can be sealed to prevent unauthorized opening. The lugs that can be snapped on for this purpose are supplied as standard
- The RBO 10, RBO 12, and RBO 16 have a 4 mm test connection at the center of the terminal block
- The covering hoods can be custom-marked using the following labels: **0830433 PML-WV101 (25X25)**

Notes:

- 1) For information on installation and using accessories for Ex applications, see page 678.
- 2) Cable lug must be insulated with shrink sleeve.

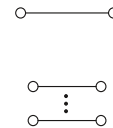

70 (70) mm², 192 A, feed-through terminal block, for DIN rail and direct mounting

Ex: EAC Ex IEC RoHS

 SEV13ATEX0132U / IECEx SEV13.0003U

Technical data

Dimensions		Width	Length	Height NS 35/15
		29	184	74.5
Maximum electrical data		I _{max} [A]	U _{max} [V]	max. Ø [mm ²] AWG (UL)
		192	1500 ²⁾	6 - 70 -
Rated data		IEC 60947-7-1	UL / CUL	CSA IEC/EN 60079-7
Rated voltage	[V]	1500 ²⁾	600	690
Nominal current / cross section	[A] / [mm ²]	192 / 70	175 / -	187 / 70
Rated cross section	[mm ²]	70	-	2.5-70
Cross section range	AWG	8 - 2/0	-	-
Connection capacity, DIN 46234		Cable lugs, DIN 46234	[mm ²]	2.5 - 70
		Connection bolt / hole diameter / width	[mm]	8 / 8.4 / 22
Connection capacity, DIN 46235		Cable lugs DIN 46235	[mm ²]	16 - 70
		Connection bolt / hole diameter / width	[mm]	8 / 8.4 / 24
Connection capacity, DIN 46237		Cable lugs DIN 46237	[mm ²]	2.5 - 6
		Connection bolt / hole diameter / width	[mm]	8 / 8.4 / 14
			blue	2.50 mm ²
			yellow	6.00 mm ²
General data		Bolt thread	M8	
		Tightening torque	[Nm]	6 - 12
		Insulating material	PA	
		Flammability rating in accordance with UL 94	V0	

Ordering data

Description	No. of pos.	Color	Type	I _{max}	Order No.	Pcs./Pkt.
Bolt connection terminal blocks, with covering hood , for direct mounting or mounting on NS 35/15		gray	RBO 8-HC		3247973	5
		blue	RBO 8-HC BU		3247974	5
		black/yellow	RBO 8-FE-HC		3247975	5

Accessories¹⁾

Description	No. of pos.	Color	Type	I _{max}	Order No.	Pcs./Pkt.
Connection rail , for cross connection of high-current connectors	2	silver	RBO 8-VS 2	192 A	3213179	10
	3	silver	RBO 8-VS 3	192 A	3213182	10
		silver	E/AL-NS 35		1201662	10
End bracket , aluminum, for screwing on, for end support of 50 - 300 mm ² terminal blocks, can be marked with ZB 10, for mounting on NS 35...		silver				
Terminal strip marker , adjustable height, for end clamp CLIPFIX ..., can be labeled with EML (20x8) label or directly with B-STIFT or X-PEN		gray				
Center groove labeling					UC-TM 12, UCT-TM 12 or ZB 12 (see Catalog 3)	



RBO bolt connection terminal blocks

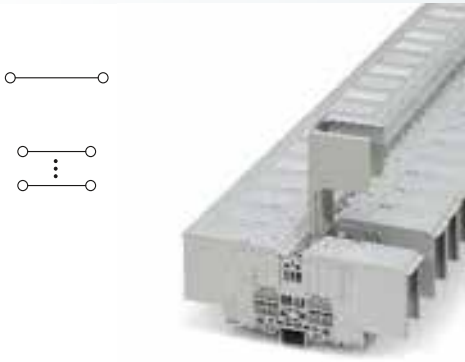

150 (150) mm², 309 A, feed-through terminal block, for DIN rail and direct mounting

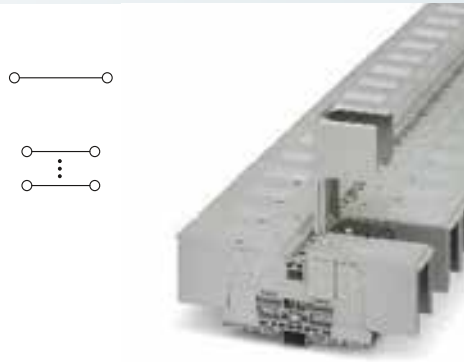

240 (240) mm², 415 A, feed-through terminal block, for DIN rail and direct mounting

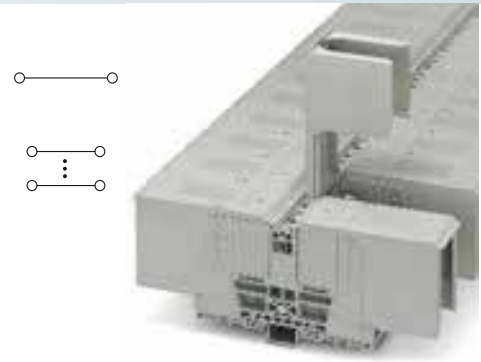

300 (300) mm², 520 A, feed-through terminal block, for DIN rail and direct mounting

Ex: EAC Ex IEC CE

 SEV13ATEX0132U / IECEx SEV13.0003U

Ex: EAC Ex IEC CE

 SEV13ATEX0132U / IECEx SEV13.0003U

Ex: EAC Ex IEC CE

 SEV13ATEX0132U / IECEx SEV13.0003U

Technical data			
Width	Length	Height NS 35/15	
41	235	84.5	
I_{max} [A]	U_{max} [V]	max. Ø [mm ²]	AWG (UL)
309	1500 ²⁾	6 - 150	10-350
IEC 60947-7-1			
IEC	UL / CUL	CSA	IEC/ EN 60079-7
1500 ²⁾	600	1000	1100
309 / 150	310 / -	310 / -	309 / 150
150	-	-	6-150
10 - 300	10-350	10-350	-
6 - 150			
10 / 10.5 / 30			
16 - 150			
10 / 10.5 / 34			
6 - 6			
10 / 10.5 / 18			
6.00 mm ²			
M10			
10 - 20			
PA			
V0			

Technical data			
Width	Length	Height NS 35/15	
49	265	90.8	
I_{max} [A]	U_{max} [V]	max. Ø [mm ²]	AWG (UL)
415	1500	10 - 240	8-600
IEC 60947-7-1			
IEC	UL / CUL	CSA	IEC/ EN 60079-7
1500	600	1000	1100
415 / -	420 / -	420 / -	415 / 240
240	-	-	10-240
8 - 500	8-600	8-600	-
10 - 240			
12 / 13 / 38			
25 - 240			
12 / 13 / 42			
-			
- / - / -			
M12			
14 - 30			
PA			
V0			

Technical data			
Width	Length	Height NS 35/15	
54.8	283.5	99.3	
I_{max} [A]	U_{max} [V]	max. Ø [mm ²]	AWG (UL)
520	1500 ²⁾	25 - 300	4-1000
IEC 60947-7-1			
IEC	UL / CUL	CSA	IEC/ EN 60079-7
1500 ²⁾	600	1000	1100
520 / 300	540 / -	540 / -	520 / 300
300	-	-	25-300
4 - 600	4-1000	4-1000	-
25 - 240			
16 / 17 / 38			
50 - 300			
16 / 17 / 48			
-			
- / - / -			
M16			
25 - 35			
PA			
V0			

Ordering data			
Type	I_{max}	Order No.	Pcs./Pkt.
RBO 10-HC		3247976	5
RBO 10-HC BU		3247977	5
RBO 10-FE-HC		3247978	5

Ordering data			
Type	I_{max}	Order No.	Pcs./Pkt.
RBO 12-HC		3247986	5
RBO 12-HC BU		3247987	5
RBO 12-FE-HC		3247988	5

Ordering data			
Type	I_{max}	Order No.	Pcs./Pkt.
RBO 16-HC		3247989	5
RBO 16-HC BU		3247990	5
RBO 16-FE-HC		3247991	5

Accessories ¹⁾			
Type		Order No.	Pcs./Pkt.
RBO 10-VS 2	309 A	3244643	10
RBO 10-VS 3	309 A	3244656	10
E/AL-NS 35		1201662	10
KLM 3-L		0814788	100

Accessories ¹⁾			
Type		Order No.	Pcs./Pkt.
RBO 12-VS 2	415 A	3244669	10
RBO 12-VS 3	415 A	3244672	10
E/AL-NS 35		1201662	10
KLM 3-L		0814788	100

Accessories ¹⁾			
Type		Order No.	Pcs./Pkt.
RBO 16-VS 2	520 A	3244685	10
RBO 16-VS 3	520 A	3244698	10
E/AL-NS 35		1201662	10
KLM 3-L		0814788	100

UC-TM 12, UCT-TM 12 or ZB 12
(see Catalog 3)

UC-TM 12, UCT-TM 12 or ZB 12
(see Catalog 3)

UC-TM 12, UCT-TM 12 or ZB 12
(see Catalog 3)

Terminal blocks – CLIPLINE complete

HV high-current connectors

HV ... high-current connectors



- Secure connection of up to four conductors with cable lugs in accordance with DIN 46234, 46235, and 46237 in very tight spaces
- Spring washers are used to prevent hexagonal nuts from loosening
- Extensive range of accessories for safe and comfortable wiring of conductors up to 120 mm²



- Two and three-pos. connection rails are available for potential distribution
- The feed-through window provided in the partition plates can be easily removed for mounting the connection rails

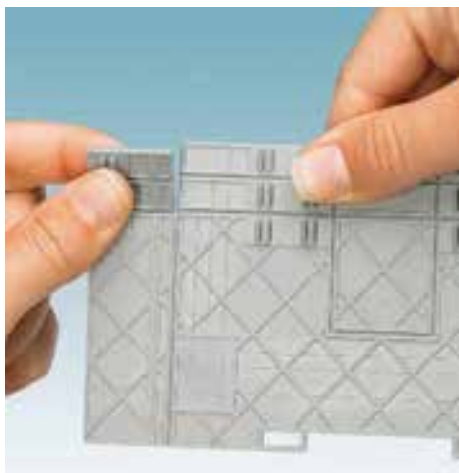

- Two different partition plates can be used for the family of single and twin bolt terminal blocks
- Labeling the partition plates allows their height and length to be adapted at the respective bolt terminal blocks

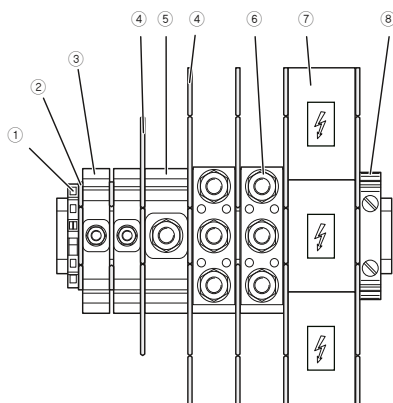

- ① CLIPFIX 35-5 end bracket
- ② HV M12/1-TP partition plate
- ③ HV M5/1 or HV M6/1 high-current connectors
- ④ HV M12/2-TP partition plate
- ⑤ HV M8/1, HV M10/1 or HV M12/1 high-current connectors
- ⑥ HV M6/2, HV M8/2 or HV M10/2 high-current connectors
- ⑦ HV M10/1-AP cover
- ⑧ E/AL-NS 35 end bracket

Notes:

Further technical notes and connection conditions are to be found on page 682.

Dimensions

[mm]

Maximum electrical data

Rated data

Rated voltage	[V]
Nominal current / cross section	[A] / [mm ²]
Rated cross section	[mm ²]
Cross section range	AWG

Connection capacity, bolt connection

Cable lugs, DIN 46234	[mm ²]
Cable lugs DIN 46235	[mm ²]
Cable lugs DIN 46237	[mm ²]

General data

Bolt length	[mm]
Screw thread	
Tightening torque	[Nm]
Insulating material	
Flammability rating in accordance with UL 94	

Description	No. of pos.	Color
High-current connectors, for mounting on NS 35...		gray

Connection rail, for cross connection of high-current connectors	2	silver
	3	silver

Reducing bridge, for connecting HV M8/1 to HV M6/1	2	silver
--	---	--------

Reducing bridge, for connecting HV M10/1 to HV M6/1	3	silver
---	---	--------

Separating plate		gray
Cover		gray
Adhesive warning plate, self-adhesive, black print: Lightning flash with mixed version: "Vorsicht Spannung – Attention Danger" size of label: 13 x 23.5 mm		yellow/black

Adhesive warning plate, self-adhesive, black print: Lightning flash with mixed version: "Vorsicht Spannung – Attention Danger" size of label: 32 x 26 mm		yellow/black
--	--	--------------

End bracket, for snapping onto NS 35, 5.15 mm wide, can be marked with ZB 5 and UCT-EM (30X5), parking option for bridges and test plugs		gray
--	--	------

End bracket, aluminum, for screwing on, for end support of 50 - 300 mm ² terminal blocks, can be marked with ZB 10, for mounting on NS 35...		silver
---	--	--------

Adhesive warning plate, self-adhesive, black print: Lightning flash with mixed version: "Vorsicht Spannung – Attention Danger" size of label: 13 x 23.5 mm		yellow/black
--	--	--------------

Lateral groove labeling

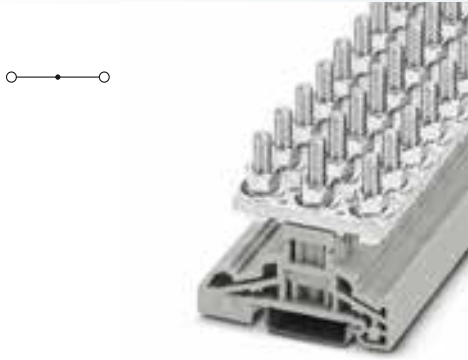

35 (35) mm², 125 A, M6 bolt terminal block

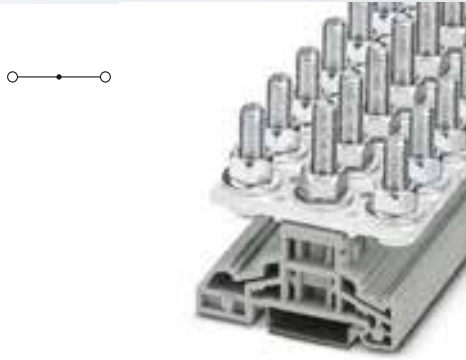

50 (50) mm², 150 A, M8 bolt terminal block

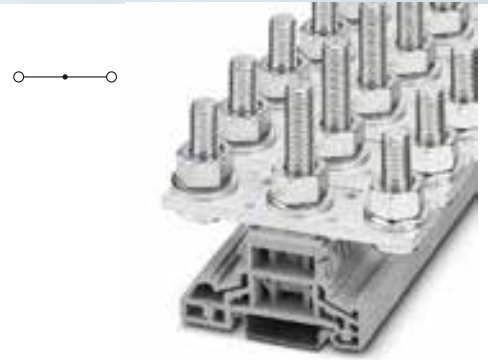

120 (120) mm², 269 A, M10 bolt terminal block

® EAC

® EAC

® EAC

Technical data			
Width	Length	Height NS 35/7,5	
16	67	58	
I_{max} [A]	U_{max} [V]	max. Ø [mm ²]	AWG (UL)
125	1000	2.5 - 35	-
IEC 60947-7-1			
IEC	UL / CUL	CSA	IEC/ EN 60079-7
1000	-	1000	-
125 / 35	-	120 / -	-
35	-	-	-
-	-	-4	-
2.5 - 35			
6 - 35			
2.5 - 6			
16			
M6			
3 - 6			
PA			
V0			

Technical data			
Width	Length	Height NS 35/7,5	
21	67	66	
I_{max} [A]	U_{max} [V]	max. Ø [mm ²]	AWG (UL)
150	1000	2.5 - 50	-
IEC 60947-7-1			
IEC	UL / CUL	CSA	IEC/ EN 60079-7
1000	-	1000	-
150 / 50	-	130 / -	-
50	-	-	-
-	-	-3	-
2.5 - 50			
6 - 35			
- 10			
21			
M8			
6 - 12			
PA			
V0			

Technical data			
Width	Length	Height NS 35/7,5	
32	67	76	
I_{max} [A]	U_{max} [V]	max. Ø [mm ²]	AWG (UL)
269	1000	6 - 120	-
IEC 60947-7-1			
IEC	UL / CUL	CSA	IEC/ EN 60079-7
1000	-	1000	-
269 / 120	-	225 / -	-
120	-	-	-
-	-	-00	-
6 - 120			
10 - 95			
- 6			
26			
M10			
10 - 20			
PA			
V0			

Ordering data			
Type	I_{max}	Order No.	Pcs./Pkt.
HV M6/2		3049547	25

Ordering data			
Type	I_{max}	Order No.	Pcs./Pkt.
HV M8/2		3049550	25

Ordering data			
Type	I_{max}	Order No.	Pcs./Pkt.
HV M10/2		3049563	10

Accessories			
Type	I_{max}	Order No.	Pcs./Pkt.
HV M6/1-VS 2	125 A	3049262	10
HV M6/1-VS 3	125 A	3049275	10
HV M12/2-TP		3049709	25
HV M6/1-AP		3049903	25
WS-4K		1004584	10
CLIPFIX 35-5		3022276	50

Accessories			
Type	I_{max}	Order No.	Pcs./Pkt.
HV M8/1-VS 2	150 A	3049369	10
HV M8/1-VS 3	150 A	3049372	10
HV M8/1 M6/1-STL		3071094	10
HV M12/2-TP		3049709	25
HV M8/1-AP		3049398	25
WS-4K		1004584	10
E/AL-NS 35		1201662	10

Accessories			
Type	I_{max}	Order No.	Pcs./Pkt.
HV M10/1-VS 2	269 A	3049466	10
HV M10/1-VS 3	269 A	3049479	10
HV M10/1 M6/1-STL2		3071081	10
HV M12/2-TP		3049709	25
HV M10/1-AP		3049495	10
WS-4K		1004584	10
WS-2K		1004513	10
E/AL-NS 35		1201662	10

UC-TM 12, UCT-TM 12 or ZB 12
(see Catalog 3)

UC-TM 12, UCT-TM 12 or ZB 12
(see Catalog 3)

UC-TM 12, UCT-TM 12 or ZB 12
(see Catalog 3)

HV high-current connectors

HV ... high-current connectors

- The bolt connection terminal blocks for cable lugs in accordance with DIN 46234, DIN 46235 and DIN 46237 are available as part of the high-current connector UHV ... range
- For connecting a maximum of four conductors
- Versions with connection bolts of between M5 and M12
- Extensive, supplementary accessories



16 (16) mm², 76 A, M5 bolt terminal block



35 (35) mm², 125 A, M6 bolt terminal block

Notes:
Further technical notes and connection conditions are to be found on page 682.



			Technical data				Technical data			
Dimensions			Width	Length	Height NS 35/7,5		Width	Length	Height NS 35/7,5	
Maximum electrical data			13	67	58		16	67	58	
Rated data			I_{max} [A]	U_{max} [V]	max. \varnothing [mm ²]	AWG (UL)	I_{max} [A]	U_{max} [V]	max. \varnothing [mm ²]	AWG (UL)
Connection capacity, bolt connection			76	1000	0.1 - 16	-	125	1000	1.5 - 35	-
General data			IEC 60947-7-1				IEC 60947-7-1			
Bolt length			IEC	UL / CUL	CSA	IEC/ EN 60079-7	IEC	UL / CUL	CSA	IEC/ EN 60079-7
Screw thread			1000	-	1000	-	1000	-	1000	-
Tightening torque			76 / 16	-	60 / -	-	125 / 35	-	115 / -	-
Insulating material			16	-	-	-	35	-	-	-
Flammability rating in accordance with UL 94			-	-	-8	-	-	-	-4	-
Ordering data			Ordering data				Ordering data			
Description			Type	I_{max}	Order No.	Pcs./Pkt.	Type	I_{max}	Order No.	Pcs./Pkt.
High-current connectors, for mounting on NS 35...			HV M5/1		3049107	25	HV M6/1		3049204	25
Accessories			Accessories				Accessories			
Connection rail, for cross connection of high-current connectors			HV M5/1-VS 2	76 A	3049437	10	HV M6/1-VS 2	125 A	3049262	10
Reducing bridge, for connecting HV M8/1 to HV M6/1			HV M5/1-VS 3	76 A	3049440	10	HV M6/1-VS 3	125 A	3049275	10
Reducing bridge, for connecting HV M10/1 to HV M6/1										
Separating plate			HV M12/1-TP		3049602	25	HV M12/1-TP		3049602	25
Cover			HV M5/1-AP		3049806	25	HV M6/1-AP		3049903	25
Adhesive warning plate, self-adhesive, black print: Lightning flash with mixed version: "Vorsicht Spannung – Attention Danger" size of label: 13 x 23.5 mm			WS-4K		1004584	10	WS-4K		1004584	10
Adhesive warning plate, self-adhesive, black print: Lightning flash with mixed version: "Vorsicht Spannung – Attention Danger" size of label: 32 x 26 mm										
End bracket, for snapping onto NS 35, 5.15 mm wide, can be marked with ZB 5 and UCT-EM (30X5), parking option for bridges and test plugs			CLIPFIX 35-5		3022276	50	CLIPFIX 35-5		3022276	50
End bracket, aluminum, for screwing on, for end support of 50 - 300 mm ² terminal blocks, can be marked with ZB 10, for mounting on NS 35...										
Lateral groove labeling			UCT-TM 12, UCT-TM 12 or ZB 12 (see Catalog 3)				UCT-TM 12, UCT-TM 12 or ZB 12 (see Catalog 3)			



50 (50) mm², 150 A, M8 bolt terminal block



120 (120) mm², 269 A, M10 bolt terminal block



120 (120) mm², 269 A, M12 bolt terminal block



Technical data			
Width	Length	Height NS 35/7,5	
21	67	66	
I_{max} [A]	U_{max} [V]	max. Ø [mm ²]	AWG (UL)
150	1000	1.5 - 50	-
IEC 60947-7-1			
IEC	UL / CUL	CSA	IEC/ EN 60079-7
1000	-	1000	-
150 / 50	-	125 / -	-
50	-	-	-
-	-	-3	-
2.5 - 50			
6 - 35			
6 - 10			
30.5			
M8			
6 - 12			
PA			
V0			

Technical data			
Width	Length	Height NS 35/7,5	
32	67	76	
I_{max} [A]	U_{max} [V]	max. Ø [mm ²]	AWG (UL)
269	1000	1.5 - 120	-
IEC 60947-7-1			
IEC	UL / CUL	CSA	IEC/ EN 60079-7
1000	-	1000	-
269 / 120	-	220 / -	-
120	-	-	-
-	-	-00	-
6 - 120			
10 - 95			
- 6			
40.5			
M10			
10 - 20			
PA			
V0			

Technical data			
Width	Length	Height NS 35/7,5	
32	67	76	
I_{max} [A]	U_{max} [V]	max. Ø [mm ²]	AWG (UL)
269	1000	6 - 120	-
IEC 60947-7-1			
IEC	UL / CUL	CSA	IEC/ EN 60079-7
1000	-	1000	-
269 / 120	-	220 / -	-
120	-	-	-
-	-	-00	-
6 - 120			
10 - 95			
-			
40.5			
M12			
14 - 31			
PA			
V0			

Ordering data			
Type	I_{max}	Order No.	Pcs./Pkt.
HV M8/1		3049301	25

Ordering data			
Type	I_{max}	Order No.	Pcs./Pkt.
HV M10/1		3049408	10

Ordering data			
Type	I_{max}	Order No.	Pcs./Pkt.
HV M12/1		3049505	10

Accessories			
Type	I_{max}	Order No.	Pcs./Pkt.
HV M8/1-VS 2	150 A	3049369	10
HV M8/1-VS 3	150 A	3049372	10
HV M8/1 M6/1-STL		3071094	10
HV M12/2-TP		3049709	25
HV M8/1-AP		3049398	25
WS-4K		1004584	10
CLIPFIX 35-5		3022276	50

Accessories			
Type	I_{max}	Order No.	Pcs./Pkt.
HV M10/1-VS 2	269 A	3049466	10
HV M10/1-VS 3	269 A	3049479	10
HV M10/1 M6/1-STL2		3071081	10
HV M12/2-TP		3049709	25
HV M10/1-AP		3049495	10
WS-4K		1004584	10
WS-2K		1004513	10
E/AL-NS 35		1201662	10

Accessories			
Type	I_{max}	Order No.	Pcs./Pkt.
HV M12/1-VS 2	269 A	3049631	10
HV M12/1-VS 3	269 A	3049644	10
HV M12/2-TP		3049709	25
HV M10/1-AP		3049495	10
WS-4K		1004584	10
WS-2K		1004513	10
E/AL-NS 35		1201662	10

UC-TM 12, UCT-TM 12 or ZB 12
(see Catalog 3)

UC-TM 12, UCT-TM 12 or ZB 12
(see Catalog 3)

UC-TM 12, UCT-TM 12 or ZB 12
(see Catalog 3)



Accessories

The CLIPLINE complete system offers you a uniform range of accessories for all connection technologies.

Marking and test accessories are standardized and reduce logistics costs. In addition, all terminal blocks of the CLIPLINE complete system can be freely combined with each other using the double function shaft. All disconnect terminal blocks in the CLIPLINE complete system have a standardized disconnect zone. Various function connectors are available for use in the disconnect terminal blocks. Isolating connectors are used for simple disconnection. The fuse connectors are designed for the use of cartridge fuse inserts. The patented component connector allows you to mount components quickly, without the risk of polarity reversal, and without the need for soldering.

 **Your web code: #1402**

Product range overview

Accessories	400
Plug-in bridges	402
Reducing bridges table	408
Test plugs and test adapters	410
Fuse, isolating, and component connectors	414
Marker carriers	418
Terminal block group marking	419
Warning labels	420

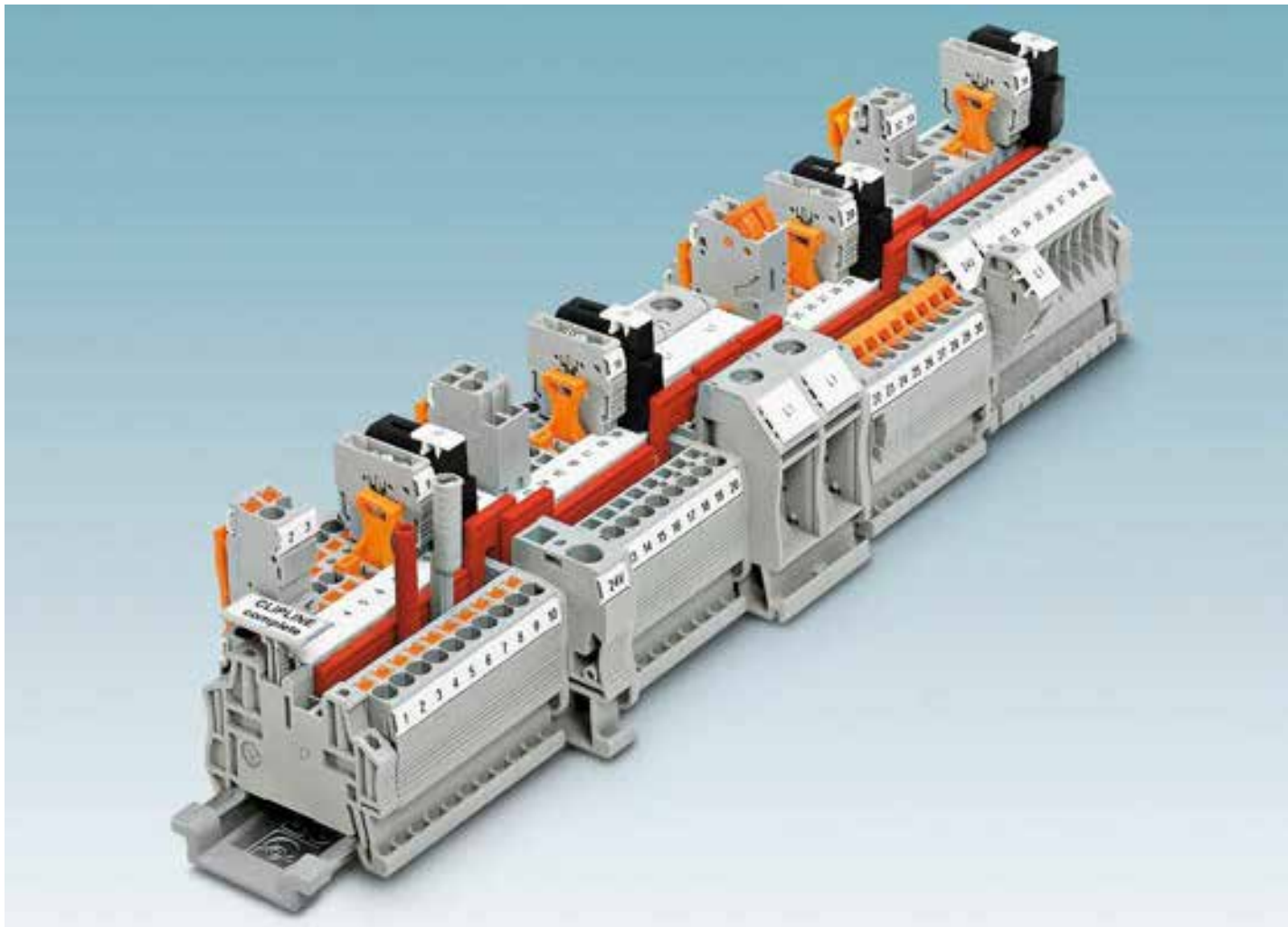

i Your web code: #1402

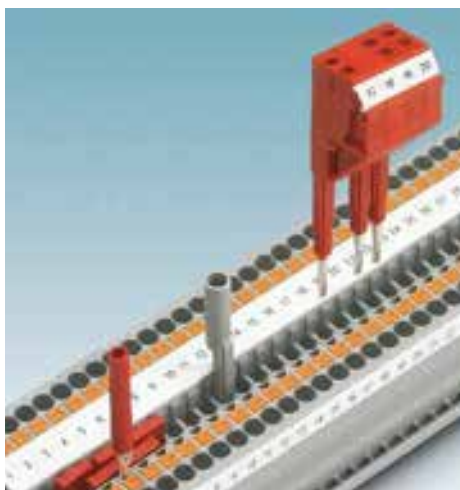

Function shaft

All the terminal blocks in the CLIPLINE complete system have function shafts to allow fast and individual potential distribution through plug-in bridges and simple testing.



Multifunctional disconnect zone

All the disconnect terminal blocks in the CLIPLINE complete system have a standardized disconnect zone. Various functional inserts are available for use in the disconnect terminal blocks.



Marking

All terminal points in the terminal blocks of the CLIPLINE complete system can have large markings. Optional snap-on large marker carriers are available for group and terminal strip marking.

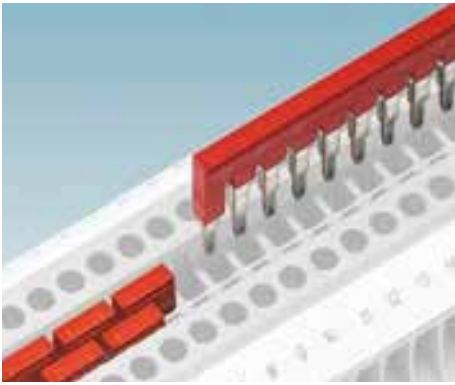

The bridge shafts are arranged in a line across all terminal blocks allowing for a combination of connection methods. The 2- to 50-pos. plug-in bridges allow all potential bridging tasks to be undertaken at speed.

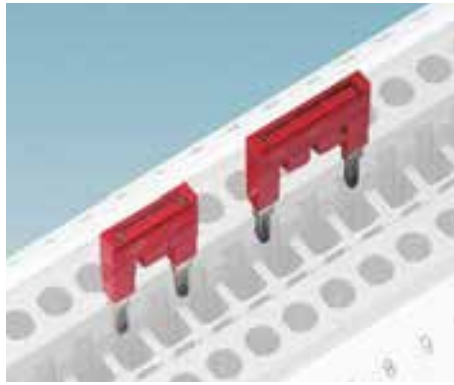

Bridging between non-adjacent terminal blocks is established by removing individual contact tabs from the standard bridge. Two potentials can then be routed in parallel through a terminal strip. The contact points can also be marked.

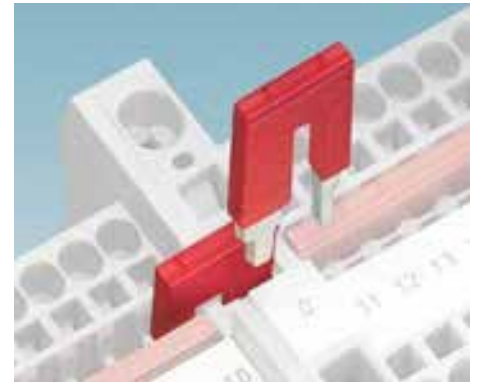

The reducing bridge enables terminal blocks with different nominal cross-sections to be connected with ease, e.g. a ST 10 terminal block with an ST 2,5. Power blocks can be created quickly using the reducing bridge.

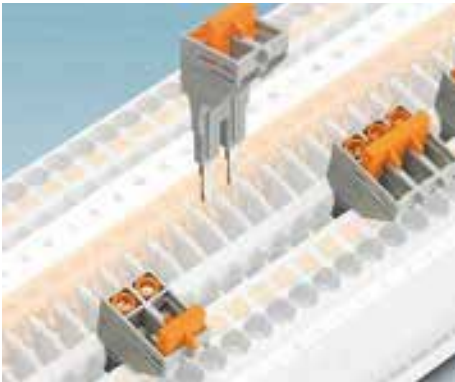

The plug-in SB-ME bridge bars make contact by being securely latched into the function shaft. They create a removable connection between neighboring terminal blocks. This enables a transformer short circuit to be created in measuring transducer disconnect terminal blocks, for example.



Vertical bridge to connect the upper and the lower levels of a double-level terminal block. The vertical bridge can be easily connected later through the function shaft of the upper level to the lower level.

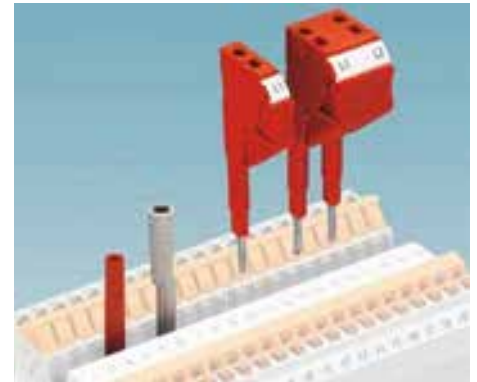

A test plug with a diameter of 2.3 mm is available for measuring lines and a test adapter with a diameter of 4 mm is available for safety test plugs. Test adapters can be implemented quickly with the alignable test plug.



The P-DI isolating connector can be removed to release the connection easily, and then "parked" back to front in the disconnect zone. The P-FIX contact metal seals the disconnect point with the same shape and cannot be removed again once fitted.



The patented component connector P-CO allows components to be quickly and reliably accommodated using spring-loaded contacts and to be connected without the risk of reverse polarity.



The fuse connectors P-FU are intended to accommodate cartridge fuse inserts. The fuse used can be checked visually via the LED.

Accessories

Plug-in bridges FBS ...



- To allow individual potential distribution, the terminal blocks of the CLIPLINE complete system have two bridge shafts
- The 2- to 50-pos. bridges can bridge up to 50 terminal blocks in one step in these bridge shafts

Designation of bridges

- The last digit in the bridge designation indicates the width of the terminal block. An FBS ...-4 bridge can be used with CLIPLINE complete terminal blocks with a width of 4.2 mm, and an FBS ...-6 bridge can be used with terminal blocks with a width of 6.2 mm

Notes:

The current values for the FBS ... bridges can deviate when used in different modular terminal blocks. The precise values can be found in the accessories data for the respective modular terminal blocks.



Plug-in bridge, red

ERC

Ordering data

Description	No. of pos.	Type	I _{max}	Order No.	Pcs./Pkt.	
Plug-in bridge	2	FBS 2-3,5	17.5 A	3213014	50	
	3	FBS 3-3,5		3213027	50	
	4	FBS 4-3,5		3213030	50	
	5	FBS 5-3,5		3213043	50	
	10	FBS 10-3,5		3213056	50	
	20	FBS 20-3,5		3213069	50	
Plug-in bridge	50	FBS 50-3,5		3000706	10	
	Plug-in bridge	2	FBS 2-4	17.5 A	3030116	50
		3	FBS 3-4		3030129	50
		4	FBS 4-4		3030132	50
		5	FBS 5-4		3030145	50
		10	FBS 10-4		3030158	10
20		FBS 20-4	3030352		10	
Plug-in bridge	2	FBS 2-5	24 A	3030161	50	
	3	FBS 3-5		3030174	50	
	4	FBS 4-5		3030187	50	
	5	FBS 5-5		3030190	50	
	10	FBS 10-5		3030213	10	
	20	FBS 20-5		3030226	10	
Plug-in bridge	50	FBS 50-5		3038930	10	
	Plug-in bridge	2	FBS 2-6	32 A	3030336	50
		3	FBS 3-6		3030242	50
		4	FBS 4-6		3030255	50
		5	FBS 5-6		3030349	50
		10	FBS 10-6		3030271	10
20		FBS 20-6	3030365		10	
Plug-in bridge	50	FBS 50-6		3032224	10	
	Plug-in bridge	2	FBS 2-8	41 A	3030284	10
		3	FBS 3-8		3030297	10
		4	FBS 4-8		3030307	10
		5	FBS 5-8		3030310	10
		6	FBS 6-8		3032470	10
10		FBS 10-8	3030323		10	
Plug-in bridge	2	FBS 2-10	50 A	3005947	10	
	5	FBS 5-10		3005948	10	
Plug-in bridge	2	FBS 2-12	76 A	3005950	10	
Plug-in bridge	2	FBS 2-16	101 A	3005963	10	
Pre-assembled bridge, labeled	3-pos., positions 1, 3	FBS 1/3-8	41 A	3032363	10	
	4-pos., positions 1, 4	FBS 1/4-8		3032376	10	
	5-pos., positions 1, 3, 5	FBS 1/3/5-8		3032389	10	
	10-pos., positions 1, 4, 7, 10	FBS 1/4/7/10-8		3032402	10	
	8-pos., positions 1, 2, 4, 6-8	FBS 1/2/4/6-8		3032378	10	
Cover cap, provides reliable touch protection when using cut-to-length FBS ...-5 and FBS ...-6 bridges	red	FBS C		3012325	50	



Plug-in bridge, blue



Plug-in bridge, gray



Plug-in bridge, orange

ERIC

ERIC

ERIC

Ordering data				Ordering data				Ordering data			
Type	I_{max}	Order No.	Pcs./Pkt.	Type	I_{max}	Order No.	Pcs./Pkt.	Type	I_{max}	Order No.	Pcs./Pkt.
FBS 2-3,5 BU	17.5 A	3213086	50	FBS 2-3,5 GY	17.5 A	3213153	50				
FBS 3-3,5 BU		3213099	50	FBS 3-3,5 GY		3213167	50				
FBS 4-3,5 BU		3213109	50	FBS 4-3,5 GY		3213180	50				
FBS 5-3,5 BU		3213112	50	FBS 5-3,5 GY		3213183	50				
FBS 10-3,5 BU		3213125	50	FBS 10-3,5 GY		3213196	50				
FBS 20-3,5 BU		3213138	50	FBS 20-3,5 GY		3213206	50				
FBS 50-3,5 BU		3000708	10	FBS 50-3,5 GY		3000707	10				
FBS 2-4 BU	17.5 A	3030117	50	FBS 2-4 GY	17.5 A	3030118	50				
FBS 3-4 BU		3030130	50	FBS 3-4 GY		3030131	50				
FBS 4-4 BU		3030133	50	FBS 4-4 GY		3030134	50				
FBS 5-4 BU		3030146	50	FBS 5-4 GY		3030147	50				
FBS 10-4 BU		3036851	10	FBS 10-4 GY		3030160	10				
FBS 20-4 BU		3030353	10	FBS 20-4 GY		3030354	10				
FBS 2-5 BU	24 A	3036877	50	FBS 2-5 GY	24 A	3038969	50				
FBS 3-5 BU		3036880	50	FBS 3-5 GY		3038972	50				
FBS 4-5 BU		3036893	50	FBS 4-5 GY		3038985	50				
FBS 5-5 BU		3036903	50	FBS 5-5 GY		3038998	50				
FBS 10-5 BU		3036916	10	FBS 10-5 GY		3039007	10				
FBS 20-5 BU		3036929	10	FBS 20-5 GY		3038671	10				
FBS 50-5 BU		3032114	10	FBS 50-5 GY		3032127	10				
FBS 2-6 BU	32 A	3036932	50	FBS 2-6 GY	32 A	3032237	50				
FBS 3-6 BU		3036945	50	FBS 3-6 GY		3032240	50				
FBS 4-6 BU		3036958	50	FBS 4-6 GY		3032279	50				
FBS 5-6 BU		3036961	50	FBS 5-6 GY		3032266	50				
FBS 10-6 BU		3032198	10	FBS 10-6 GY		3032253	10				
FBS 20-6 BU		3032208	10								
FBS 50-6 BU		3032211	10								
FBS 2-8 BU	41 A	3032567	10	FBS 2-8 GY	41 A	3032621	10	FBS 2-8 CT	41 A	3033830	10
FBS 3-8 BU		3032570	10	FBS 3-8 GY		3032622	10	FBS 3-8 CT		3033831	10
FBS 4-8 BU		3032583	10	FBS 4-8 GY		3032635	10	FBS 4-8 CT		3033832	10
FBS 5-8 BU		3032596	10	FBS 5-8 GY		3032648	10				
FBS 6-8 BU		3032677	10	FBS 6-8 GY		3032664	10				
FBS 10-8 BU		3032606	10	FBS 10-8 GY		3032651	10	FBS 10-8 CT		3033833	10
Accessories				Accessories				Accessories			
FBSC		3012325	50	FBSC		3012325	50	FBSC		3012325	50

Accessories

FBS-PV ... vertical potential bridges

- Potential bridge for subsequent connection of the upper and the lower levels of a double-level terminal block
- The FBS-PV PT 2,5-4L vertical bridge can be used with the PT 2,5-4L ... terminal blocks
- The FBS-PV UT vertical bridge can be used with the UTTB 2,5, UTTB 4, PT 2,5-PE/3L, and PT 4-PE/3L



ERC

Description	No. of pos.	Ordering data				Ordering data			
		Type	I_{max}	Order No.	Pcs./Pkt.	Type	I_{max}	Order No.	Pcs./Pkt.
Vertical potential bridge, to connect the upper and lower level	1	FBS-PV PT 2,5-4L	10 A	3012318	50	FBS-PV UT	22 A	3047358	50

FBS-PV ... vertical potential bridges

- The vertical bridge FBS-PV can be used with the STTBS 2,5, STTBS 4, PTTB 2,5, PTTB 4, PTTBS 2,5, QTTCB 1,5, and STTB 2,5/4P
- The vertical bridge FBS 1,5/S-PV can be used with the PTTB 1,5/S, PT 1,5/S-3L, and PT 1,5/S-PE/L/L



ERC

ERC

Description	No. of pos.	Ordering data				Ordering data			
		Type	I_{max}	Order No.	Pcs./Pkt.	Type	I_{max}	Order No.	Pcs./Pkt.
Vertical potential bridge, to connect the upper and lower level	1	FBS-PV	32 A	3032185	50	FBS 1,5/S-PV	16 A	3216263	10

FBSW ... plug-in wire bridge



- Wires of different lengths are used to connect individual terminal blocks with different terminal widths and the plug-in bridge shaft
- For a terminal width of 5.2 mm and 6.2 mm



		Ordering data			
Description	No. of pos.	Type	I _{max}	Order No.	Pcs./Pkt.
Wire bridge					
Length 60 mm	1	FBSW 2-5/60MM	10 A	3030170	10
Length 110 mm	1	FBSW 2-5/110MM		3030171	10
Length 250 mm	1	FBSW 2-5/250MM		3030172	10

Accessories

FBSR(H) ... plug-in bridges and SB-ME ... switching bridges



FBSRH

- The FBSRH ...-8 bridges have a molded extraction tool which means that they can be used conveniently and without tools for individual bridging tasks. This enables a transformer short circuit to be created in measuring transducer disconnect terminal blocks, for example

SB-ME

- The plug-in SB-ME bridge bars make contact by being securely latched into the function shaft. They create a removable connection between neighboring terminal blocks. This enables a transformer short circuit to be created in measuring transducer disconnect terminal blocks, for example

Designation of bridges

- The last digit in the bridge designation indicates the width of the terminal block. An FBSR ...-5 bridge can be used with CLIPLINE complete terminal blocks with a width of 5.2 mm, and an FBSR ...-6 bridge can be used with terminal blocks with a width of 6.2 mm

Notes:

The switching bridges also snap into the function shaft and occupy both bridge shafts.

The FBSR ... bridges have a reduced current carrying capacity in comparison with the standard FBS ... bridges.



Plug-in bridge

ERC

Ordering data

Description	No. of pos.	Type	I _{max}	Order No.	Pcs./Pkt.
Plug-in bridge	2	FBSR 2-5	17.5 A	3033702	50
	3	FBSR 3-5		3001591	50
	4	FBSR 4-5		3001592	50
	5	FBSR 5-5		3001593	50
	10	FBSR 10-5		3033710	10
Plug-in bridge	2	FBSR 2-6	24 A	3033715	50
	3	FBSR 3-6		3001594	50
	4	FBSR 4-6		3001595	50
	5	FBSR 5-6		3001596	50
	10	FBSR 10-6		3033716	10
Plug-in bridge	2	FBSR 2-8	32 A	3033808	10
	3	FBSR 3-8		3001597	10
	4	FBSR 4-8		3000585	10
	5	FBSR 5-8		3033809	10
	10	FBSR 10-8		3001599	10
	16	FBSR 16-8		3033816	10
Bridge, with extraction tool	2				
Bridge, with extraction tool	2				
	3				
	4				
Switching bridge, plug-in	2				
	3				
	4				
Switching bridge, plug-in	2				
	3				
	4				
Switching bridge, plug-in	2				
	3				
	4				
Accessories					
Cover cap, provides reliable touch protection when using cut-to-length FBS ...-5 and FBS ...-6 bridges	red	FBS		3012325	50
Partition plate, with storage option for switching bridges	gray				



Plug-in bridge,
with and without extraction tool



30 A, switching bridge,
plug-in with additional latching



25 A switching bridge,
plug-in

ERC

ERC

ERC

Ordering data

Type	I _{max}	Order No.	Pcs./Pkt.
FBSRH 2-6	24 A	3033812	10
FBSRH 2-8	32 A	3033802	10
FBSRH 3-8		3033803	10
FBSRH 4-8		3033804	10

Ordering data

Type	I _{max}	Order No.	Pcs./Pkt.
SB-ME 2-8	30 A	3034468	10
SB-ME 3-8		3032800	10
SB-ME 4-8		3034484	10

Ordering data

Type	I _{max}	Order No.	Pcs./Pkt.
SB-ME 2-6	25 A	3035755	10
SB-ME 3-6		3035756	10
SB-ME 4-6		3035757	10
SB-MER 2-8	25 A	3000587	10
SB-MER 3-8		3000588	10
SB-MER 4-8		3000589	10

Accessories

CARRIER 35-8	3034387	10
--------------	---------	----

Accessories

--	--	--

Accessories

--	--	--

Accessories

Example of a 10 mm² central supply with reducing bridges
RB UT 10-(2,5/4) to 2.5 mm²

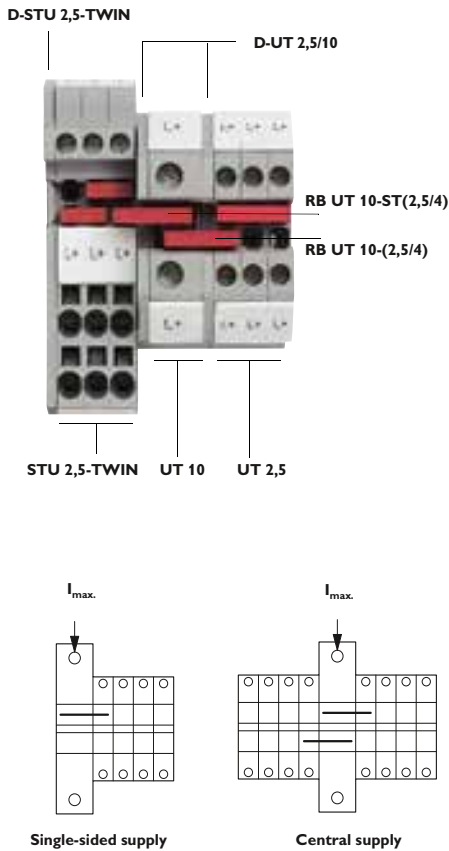

Reducing bridges enable the simple connection of standard terminal blocks with different nominal cross sections and connection technologies from the CLIPLINE complete system. Power supplies with large cross sections can be easily distributed among several smaller output terminal blocks. The connection technologies and the connected cross sections must be taken into consideration in order to select suitable reducing bridges. The appropriate reducing bridge and the maximum permissible bridge current for single-sided supply and central supply can be determined using the adjacent table.

Note

When using reducing bridges, covers must be used depending on the supply direction. The auto correction function in PROJECT complete provides optimum support during this process.

Reducing bridging with standard UT feed-through terminal blocks

Supply		Pick-off		Single-sided supply	Central supply	Bridge
Terminal block	Cross section [mm ²]	Terminal block	Cross section [mm ²]	I _{max.} [A]	I _{max.} [A]	
UT 4	4	UT 2,5	2,5	24	24	FBS 2-5 3030161
UT 6	6	UT 2,5	2,5	40	56	RB UT 6-(2,5/4) 3047251
		UT 4	4	45	56	
		PT 2,5	2,5	40	56	RB UT 6-ST(2,5/4) 3047264
		PT 4	4	45	56	
		ST 2,5	2,5	40	56	
		ST 4	4	45	56	
		QTC 1,5	1,5	35	56	
QTC 2,5	2,5	40	56			
UT 10	10	UT 2,5	2,5	40	65	RB UT 10-(2,5/4) 3047060
		UT 4	4	45	65	
		PT 2,5	2,5	40	65	RB UT 10-ST(2,5/4) 3047086
		PT 4	4	45	65	
		ST 2,5	2,5	40	65	
		ST 4	4	45	65	
		QTC 1,5	1,5	35	65	
QTC 2,5	2,5	40	65			
UT 16	16	UT 2,5	2,5	40	80	RB UT 16-(2,5/4) 3047073
		UT 4	4	45	90	
		UT 6	6	37	74	RB UT 16-ST(2,5/4) 3047099
		PT 2,5	2,5	40	80	
		PT 4	4	45	90	
		ST 2,5	2,5	40	80	
		ST 4	4	45	90	
		QTC 1,5	1,5	35	70	
		QTC 2,5	2,5	40	80	
		UT 35	35	UT 2,5	2,5	
UT 4	4			45	90	
PT 2,5	2,5			40	80	RB UT 35-ST(2,5/4) 3047280
PT 4	4			45	90	
ST 2,5	2,5			40	80	
ST 4	4			45	90	
QTC 1,5	1,5			35	70	
QTC 2,5	2,5	40	80			
UT 35	35	UT 10	10	57	114	RB UT 35-10 3032168
		UT 16	16	90	90	RB 35-16 3032169

Reducing bridging with standard RT feed-through terminal blocks

Supply		Pick-off		Single-sided supply	Central supply	Bridge
Terminal block	Cross section [mm ²]	Terminal block	Cross section [mm ²]	I _{max.} [A]	I _{max.} [A]	
RT 5	6	UT 2,5	2,5	40	56	RB UT 6-(2,5/4) 3047251
		UT 4	4	40	56	
		RT 3	2,5	40	56	
		PT 2,5	2,5	40	56	RB UT 6-ST(2,5/4) 3047264
		PT 4	4	40	56	
		ST 2,5	2,5	40	56	
		ST 4	4	40	56	
		QTC 1,5	1,5	35	56	
		QTC 2,5	2,5	40	56	
RT 8	35	RT 3	2,5	40	56	RB ST 10-(2,5/4) 3030873
		UT 2,5	2,5	40	65	
		UT 4	4	45	65	

Reducing bridging with standard PT and ST feed-through terminal blocks						
Supply		Pick-off		Single-sided supply	Central supply	Bridge
Terminal block	Cross section [mm ²]	Terminal block	Cross section [mm ²]	I _{max} [A]	I _{max} [A]	
ST 2,5 PT 2,5	2.5	PT 1,5/S	1.5	24	30	RB ST (2,5/4)-1,5/S 3214356
		ST 1,5	1.5	31	31	RB ST (2,5/4)-1,5 3038943
		QTC 1,5	1.5	31	31	FBS 2-5 3030161
ST 4 PT 4	4	PT 1,5/S	1.5	24	40	RB ST (2,5/4)-1,5/S 3214356
		ST 1,5	1.5	35	40	RB ST (2,5/4)-1,5 3038943
		PT 2,5	2.5	40	40	FBS 2-5 3030161
		ST 2,5	2.5	40	40	
		QTC 1,5	1.5	35	40	
		QTC 2,5	2.5	40	40	FBS 2-6 3030336
ST 6 PT 6	6	PT 1,5/S	1.5	24	48	RB ST 6-1,5/S 3213250
		PT 2,5	2.5	40	56	RB ST 6-(2,5/4) 3030860
		PT 4	4	45	56	
		ST 2,5	2.5	40	56	
		ST 4	4	45	56	
		QTC 1,5	1.5	35	56	
		QTC 2,5	2.5	40	56	
ST 10 PT 10	10	PT 1,5/S	1.5	24	48	RB ST 10-1,5/S 3213252
		PT 2,5	2.5	40	65	RB ST 10-(2,5/4) 3030873
		PT 4	4	45	65	
		ST 2,5	2.5	40	65	
		ST 4	4	45	65	
		QTC 1,5	1.5	35	65	
		QTC 2,5	2.5	40	65	
ST 16 PT 16	16	PT 6	6	37	74	RB 16-6 3047072
		ST 6	6	37	74	RB ST 16-1,5/S 3213254
		PT 1,5/S	1.5	24	48	
		PT 2,5	2.5	40	80	RB ST 16-(2,5/4) 3030886
		PT 4	4	45	90	
		ST 2,5	2.5	40	80	
		ST 4	4	45	90	
		QTC 1,5	1.5	35	70	
		QTC 2,5	2.5	40	80	
ST 35 PTPOWER 35	35	PT 2,5	2.5	40	80	RB ST 35-(2,5/4) 3030899
		PT 4	4	45	90	
		ST 2,5	2.5	40	80	
		ST 4	4	45	90	
		QTC 1,5	1.5	35	70	
		QTC 2,5	2.5	40	80	RB PTPOWER 35-ST (2,5/4) 3030900
		PT 2,5	2.5	40	80	
		PT 4	4	45	90	
		ST 2,5	2.5	40	80	
		ST 4	4	45	90	
PTPOWER 35	35	PT 16 N	16	90	125	RB PTPOWER 35-ST 16 3032170
		ST 16	16	90	125	
ST 35	35	ST 16	16	90	125	RB 35-16 3032169
STS 4	4	STS 2,5	2.5	40	40	FBS 2-5 3030161
STS 6	6	STS 2,5	2.5	40	56	RB ST 6-(2,5/4) 3030860
		STS 4	4	45	56	

Reducing bridging with standard QT feed-through terminal blocks						
Supply		Pick-off		Single-sided supply	Central supply	Bridge
Terminal block	Cross section [mm ²]	Terminal block	Cross section [mm ²]	I _{max} [A]	I _{max} [A]	
QTC 2,5	2.5	QTC 1,5	1.5	31	31	FBS 2-5 3030161

Terminal blocks – CLIPLINE complete

Accessories

Test plugs PS ...

- Two-part test plug for individual connector color combination
- The test connectors are plugged in the function shaft of the terminal blocks from the CLIPLINE complete system or in the test connections provided for them
- The modular test connector housings PS-...2,3MM can be used to put together individual test adapters



ERC

		Ordering data		
Description	Color	Type	Order No.	Pcs./Pkt.
Modular test plug housing , for MPS metal part, can be marked with ZB 5	red	PS-5/2,3MM RD	3038723	10
	red	PS-6/2,3MM RD	3038736	10
	red	PS-8/2,3MM RD	3048564	10
Insulating sleeve , for MPS metal part	white			
Insulating sleeve , for MPS metal part	red			
	blue			
	yellow			
	green			
	gray			
	black			
Test plug metal part , 2.3 mm Ø	gray	MPS-MT	0201744	10
4 mm Ø	silver	MPS-MT/ 4MM	3048577	10

ERC

Ordering data		
Type	Order No.	Pcs./Pkt.
MPS-IH WH	0201663	10
MPS-IH RD	0201676	10
MPS-IH BU	0201689	10
MPS-IH YE	0201692	10
MPS-IH GN	0201702	10
MPS-IH GY	0201728	10
MPS-IH BK	0201731	10
MPS-MT	0201744	10
MPS-MT/ 4MM	3048577	10

Test plugs PS ...



ERC

		Ordering data		
Description	Color	Type	Order No.	Pcs./Pkt.
Individual test plug , delivery: 1-pos.				
	red	PS-UK 2,5 B/E	3001132	10
Modular test plug , delivery: set of 10 with connection pin				
Pitch 5.2 mm	red	PS-UK 2,5 B/Z-5	3001226	1
Modular test plug , delivery: set of 10 with connection pin				
Pitch 6.2 mm	red	PS-UK 2,5 B/Z-6	3001239	1

Test plugs PS ...

- The test connectors are plugged in the function shaft of the terminal blocks from the CLIPLINE complete system or in the test connections provided for them



EAC

EAC

Description	Color	Ordering data			Ordering data		
		Type	Order No.	Pcs./Pkt.	Type	Order No.	Pcs./Pkt.
Individual double-level test plug , contacts in the upper and lower level simultaneously, delivery: 1-pos., for UTTB ...							
	red	PS-UKK/E	3000641	10			
Modular double-level test plug , contacts in the upper and lower level simultaneously, delivery: 10-pos. blocks with 2 connection pins, for UTTB 2,5							
	red				PS-UKK 3	3000638	1
Modular double-level test plug , contacts in the upper and lower level simultaneously, delivery: 10-pos. blocks with 2 connection pins, for UTTB 4							
	red				PS-UKK 5	3000625	1

Modular test plugs PS- and spacer plates DP PS-...

- The test plugs make contact in the function shaft of terminal blocks from the CLIPLINE complete system
- Test adapters can be assembled individually with the modular test plugs PS-... and spacers DP PS-...



Modular test plug

Spacer plates

Description	Color	Ordering data			Ordering data		
		Type	Order No.	Pcs./Pkt.	Type	Order No.	Pcs./Pkt.
Individual test plug , 3.5 mm width, can be marked with ZBF 3,5 and UCT-TMF 3,5							
	red	PS-3,5/E	3031012	10			
4.2 mm width, can be marked with ZBF 4, UC-TMF 4, and UCT-TMF 4	red	PS-4/E	3036709	10			
Modular test plug , for the individual assembly of test pin strips							
3.5 mm, can be marked with ZBF 3,5 and UCT-TMF 3,5	red	PS-3,5	3031010	10	DP PS-3,5	3031011	10
4.2 mm, can be labeled with ZBF 4, UC-TMF 4 and UCT-TMF 4	red	PS-4	3030970	10	DP PS-4	3036712	10
5.2 mm, can be labeled with ZBF 5, UC-TMF 5 and UCT-TMF 5	red	PS-5	3030983	10	DP PS-5	3036725	10
6.2 mm, can be labeled with ZBF 6, UC-TMF 6 and UCT-TMF 6	red	PS-6	3030996	10	DP PS-6	3036738	10
8.2 mm, can be labeled with ZBF 8, UC-TMF 8 and UCT-TMF 8	red	PS-8	3031005	10	DP PS-8	3036741	10

Accessories

Test adapters PAI ...

- Reliable contacting of test plugs with a 4 mm diameter in the function shaft
- The small external diameter of the test socket means that finger-safe protected safety connectors can also be used

Notes:

*) Touch-proof against unintentional direct contact in accordance with DIN EN 50274 when plugged in.



4 mm test adapter, for terminal blocks with 4.2 mm pitch

ERC

Ordering data

Description	Color
Test adapter, 4 mm test socket hole*)	gray

Type	Order No.	Pcs./Pkt.
PAI-4	3030925	10



4 mm test adapter, for terminal blocks with 5.2 mm, 6.2 mm and 8.2 mm pitch

ERC

Ordering data

Type	Order No.	Pcs./Pkt.
PAI-4-N GY	3032871	10

Snap-on test adapters PAI-4-FIX ...

- Test adapter for accommodating safety test plugs with a 4 mm diameter
- Makes contact and latches securely at any point in the function shaft

Notes:

Touch-proof against unintentional direct contact in accordance with DIN EN 50274 when plugged in.



4 mm test adapter, for terminal blocks with 5.2 mm and 6.2 mm pitch

ERC

Ordering data

Description	Color
Test adapter, for 4 mm Ø safety test plugs, latches into the bridge shaft	
	orange
	yellow
	green
	violet
	black
	blue
	red
	gray
	brown
	white

Type	Order No.	Pcs./Pkt.
PAI-4-FIX-5/6 OG	3035974	10
PAI-4-FIX-5/6 YE	3035977	10
PAI-4-FIX-5/6 GN	3035978	10
PAI-4-FIX-5/6 VT	3035979	10
PAI-4-FIX-5/6 BK	3035980	10
PAI-4-FIX-5/6 BU	3035975	10
PAI-4-FIX-5/6 RD	3035976	10
PAI-4-FIX-5/6 GY	3035982	10
PAI-4-FIX-5/6 BN	3035981	10
PAI-4-FIX-5/6 WH	3035983	10



4 mm test adapter, for terminal blocks with 8.2 mm pitch

ERC

Ordering data

Type	Order No.	Pcs./Pkt.
PAI-4-FIX OG	3034455	10
PAI-4-FIX YE	3032745	10
PAI-4-FIX GN	3032758	10
PAI-4-FIX VT	3032761	10
PAI-4-FIX BK	3032774	10
PAI-4-FIX BU	3032729	10
PAI-4-FIX RD	3032732	10
PAI-4-FIX GY	3032790	10
PAI-4-FIX BN	3032787	10
PAI-4-FIX WH	3032797	10

PAIS ... test plugs**Notes:**

1) Touch-proof against unintentional direct contact in accordance with DIN EN 50274 when plugged in.

- Angled test plug for accommodating safety test plugs with a 4 mm diameter
- Makes contact and latches securely at any point in the function shaft



ERIC

		Ordering data		
Description	Color	Type	Order No.	Pcs./Pkt.
Test plug¹⁾				
	gray	PAIS-4-FIX GY	3032791	10
	black	PAIS-4-FIX BK	3032792	10
	red	PAIS-4-FIX RD	3032793	10
	blue	PAIS-4-FIX BU	3032798	10
	yellow	PAIS-4-FIX YE	3032799	10
	green	PAIS-4-FIX GN	3032801	10
	violet	PAIS-4-FIX VT	3032802	10

Accessories

Fuse connectors P-FU ...

- Large-surface marking options
- Versions with bipolar error display
- Test contacts on both sides of the fuse

Notes:
1) If the fuse is faulty, the downstream circuit is not off load.
2) For max. power dissipation, see page 694.



6.2 mm fuse connector,
for 5 x 20 mm cartridge fuses



Technical data		
Width	Length	Height
6.2	25	57.7
Maximum load current		
6.3 ²⁾		
Ordering data		
Type	Order No.	Pcs./Pkt.
P-FU 5X20-5	3209235	10
P-FU 5X20 LED 24-5	3209248	10
P-FU 5X20 LED 60-5	3209251	10
P-FU 5X20 LED 250-5	3209264	10

Accessories	
Center groove labeling	UC-TMF 6, UCT-TMF 6 or ZBF 6 (see Catalog 3)



6.2 mm fuse connector,
for 5 x 20 mm cartridge fuses



Technical data		
Width	Length	Height
6.2	28	25
Maximum load current		
6.3 ²⁾		
Ordering data		
Type	Order No.	Pcs./Pkt.
P-FU 5X20	3036806	10
P-FU 5X20 LED 24	3036819	10
P-FU 5X20 LED 60	3036822	10
P-FU 5X20 LA 250	3036835	10

Accessories	
Center groove labeling	UC-TMF 5, UCT-TMF 5 or ZBF 5 (see Catalog 3)

Dimensions	
	[mm]
Rated data	
Maximum load current	[A]
Description	
Color	
Fuse connector, width: 5.2 mm	black
LED for 12 - 30 V DC, 0.35 - 0.95 mA ¹⁾	black
for 30 - 60 V AC/DC, 0.36 - 0.95 mA ¹⁾	black
for 110 - 250 V AC/DC, 0.4 - 0.95 mA ¹⁾	black
Fuse connector, width: 6.2 mm ²⁾	black
with LED for 12 - 30 V DC, 0.31 - 0.95 mA ¹⁾	black
30 - 60 V AC/DC, 0.40 - 0.86 mA ¹⁾	black
for 110 - 250 V AC/DC, 0.41 - 0.96 mA	black

Fuse connectors P-FU ...

Notes:
1) If the fuse is faulty, the downstream circuit is not off load.
2) For max. power dissipation, see page 694.



- Large-surface marking options
- Versions with bipolar error display
- Test contacts on both sides of the fuse

Dimensions	
	[mm]
Rated data	
Maximum load current	[A]
General data	
Insulating material	PA
Flammability rating in accordance with UL 94	V0
Description	
Color	
Fuse connector, width: 8.2 mm	black
with LED for 12 - 30 V DC, 0.31 - 0.95 mA ¹⁾	black
30 - 60 V AC/DC, 0.40 - 0.86 mA ¹⁾	black
for 110 - 250 V AC/DC, 0.41 - 0.96 mA	black

Accessories	
Center groove labeling	UC-TMF 6, UCT-TMF 6 or ZBF 6 (see Catalog 3)



8.2 mm fuse connector,
for 6.3 x 32 mm cartridge fuses



Technical data		
Width	Length	Height
8.2	40	27
Maximum load current		
10 ²⁾		
Ordering data		
Type	Order No.	Pcs./Pkt.
P-FU 6,3X32	3046498	10
P-FU 6,3X32 LED 24	3046508	10
P-FU 6,3X32 LED 60	3046511	10
P-FU 6,3X32 LA 250	3046524	10

Accessories	
Center groove labeling	UC-TMF 6, UCT-TMF 6 or ZBF 6 (see Catalog 3)

Switching lock S-MT



- The optional switching lock snaps in and effectively prevents accidental switching
- Can be used in all knife disconnect terminal blocks ...-MT from the CLIPLINE complete system



Switching lock

EAC

Dimensions	
	[mm]

General data	
Insulating material	PA
Flammability rating in accordance with UL 94	V2

Description	Color
Switching lock, plug-in	white

Technical data		
Width	Length	Height
3.5	10.5	23.1

Ordering data		
Type	Order No.	Pcs./Pkt.
S-MT	3247954	50

Isolating connectors P-DI

Notes:
1) Observe max. load current.



- The isolating connector P-DI can be removed to release the connection easily and then “parked” back to front in the disconnect zone
- Can be used in all disconnect terminal blocks ...-TG from the CLIPLINE complete system



Function plug for universal disconnect zone

EAC

Dimensions	
	[mm]

Rated data	
Maximum load current	[A]
	20

General data	
Insulating material	PA
Flammability rating in accordance with UL 94	V2

Description	Color
Isolating plug ¹⁾	orange

Technical data		
Width	Length	Height
3.5	10.8	23.1

Ordering data		
Type	Order No.	Pcs./Pkt.
P-DI	3036783	50

Accessories

Through connectors P-FIX



- The P-FIX contact metal seals the disconnect point with the same shape and cannot be removed again once fitted
- Can be used in all disconnect terminal blocks ...-TG from the CLIPLINE complete system

Notes:
1) Observe max. load current.



Feed-through connector



Dimensions	[mm]
Rated data	
Maximum load current	[A] 20
General data	
Insulating material	PA
Flammability rating in accordance with UL 94	V0

Technical data

Width	Length	Height
4	10.5	-

Description	Color
Feed-through connector ¹⁾	gray

Ordering data

Type	Order No.	Pcs./Pkt.
P-FIX	3038956	50

Component connectors P-CO ...



- The P-CO patented component connector can quickly and reliably accommodate components using spring-loaded contacts
- A coder recess ensures protection against incorrect polarity
- For assembly, the spring-cage connections are opened or closed inside the connector with just one turn of the standard screwdriver

- Can be used in all disconnect terminal blocks ...-TG from the CLIPLINE complete system

Notes:
1) Integrated: Diode 1N 4007, reverse voltage: 1300 V, maximum continuous current: 1.0 A
2) Depending on the power dissipation of the components. Max. 0.5 W with separate arrangement.



Component connector



Dimensions	[mm]
Rated data	
Maximum load current	[A] 6 ²⁾
General data	
Insulating material	PA
Flammability rating in accordance with UL 94	V0

Technical data

Width	Length	Height
5.1	24.2	33.3

Description	Color
Component connector, labeled with ZBF 5 or UC-TMF 5	gray
Component connector, with integrated 1N 4007 diode, conducting direction from right to left, direction viewed: Open terminal side ¹⁾	gray
Conducting from left to right, direction viewed: Open terminal side	gray

Ordering data

Type	Order No.	Pcs./Pkt.
P-CO	3036796	10
P-CO 1N4007/R-L	3032457	10
P-CO 1N4007/L-R	3032460	10

P-CO XL component connectors



- Fast component installation without soldering, thanks to spring-cage connection
- Can be flexibly plugged into all CLIPLINE complete disconnect terminal blocks, thanks to universal disconnect zone
- Safe use of discrete components with high power dissipation, thanks to optimum heat dissipation
- Plug-in integration of discrete components with a diameter of up to 10 mm
- Coding ensures connection without the risk of polarity reversal

Notes:

¹⁾ Dependent on the power dissipation of the components.
Max. 1 W with single arrangement.



Component connector



Dimensions	
	[mm]

Rated data	
Maximum load current	[A]

General data	
Insulating material	PA
Flammability rating in accordance with UL 94	V0

Description	Color
Component connector , for PT, ST, QTC disconnect terminal blocks, engaged in the central marking groove	gray
Component connector , can be fitted with SKN 2,5 diode, for PT, ST, QTC disconnect terminal blocks, engaged in the central marking groove	gray
Component connector , for UT disconnect terminal blocks	gray

Lateral groove labeling

Technical data

Width	Length	Height
12.3	41.2	37.5

10 ¹⁾

PA
V0

Ordering data

Type	Order No.	Pcs./Pkt.
P-CO XL	3036797	10
P-CO XL SKN	3036798	10
P-CO XL-UT	3036799	10

Accessories

UC-TMF 8 or ZBF 8 (see Catalog 3)

Accessories

STP ... marker carriers, for multi-level terminal blocks



STP ...

- The marker carriers enlarge the marking areas of wired multi-level terminal blocks
- Depending on version, the marker carriers are placed in the receivers on the upper terminal block level

STP ...-ZB

- The marker carriers can, for example, snap into the center marking groove of ST spring-cage terminal blocks and double the marking area; see figure below

CARRIER-TM 300

- Can be snapped into all terminal blocks in the CLIPLINE complete system that have a lateral flat marker groove
- For accommodating ZB ..., UC-TM ... or UCT-TM ... terminal markers which increases the marking area

CARRIER-TMD 300

- Double-row snap-in marker adapter for accommodating two ZB ... or UC-TM ... and UCT-TM ... terminal markers which doubles the marking area



Marker carrier

General data

Material	
Flammability rating in accordance with UL 94	
Temperature range	[°C]
Components	

Technical data

PA
V2
-40 ... 100
free from silicone and halogen

Description

Color

Double marker carrier, can be snapped into PTTB 1,5/S Push-in double-level terminal blocks, can be marked with: ZB(F) 3,5 or UCT-TM(F) 3,5

gray

Triple marker carrier, can be snapped into the Push-in three-level terminal block PT 1,5/S-3..., can be marked with: ZB(F) 3,5 or UCT-TM(F) 3,5

gray

Double marker carrier, can be snapped into the STTB 1,5, PTTB 1,5 double-level spring-cage terminal blocks, can be marked with: UC-TM(F) 4, ZB(F) 4 or UCT-TM(F) 4

gray

Double marker carrier, can be snapped into STTB 2,5, STTB 4, PTTB 2,5, PTTB 4 double-level terminal blocks, can be marked with: UC-TM(F) 5, ZB(F) 5 or UCT-TM(F) 5

gray

Triple marker carrier, can be snapped into the ST 2,5–3..., PT 2,5–3... three-level terminal block, can be marked with: UC-TM(F) 5, ZB(F) 5 or UCT-TM 5

gray

Double marker carrier, can be snapped into QTTCS ... and QTTCS ... double-level fast-connection terminal blocks, can be marked with UC-TM(F) 5, ZB(F) 5 or UCT-TM(F) 5

gray

Double marker carrier, can be snapped into all terminal blocks with a width of 4.2 mm and a central zack marker strip groove, can be marked with: UC-TM(F) 4, ZB(F) 4 or UCT-TM(F) 4

gray

Double marker carrier, can be snapped into all terminal blocks with a width of 5.2 mm or above and a central zack marker strip groove, can be marked with: UC-TM(F) 5, ZB(F) 5 or UCT-TM(F) 5

gray

Marker adapter, 300 mm long, can be snapped into the lateral groove on terminal blocks, designed to accommodate UC-TM..., ZB... or UCT-TM...

gray

Marker adapter, double row, 300 mm long, can be snapped into the center groove on terminal blocks, designed to accommodate two UC-TM..., ZB... or UCT-TM...

gray

Marker adapters, such as the CARRIER-TM 300; marking area at an angle to the top of the terminal block, designed to accommodate UC-TM..., ZB... or UCT-TM...

gray

Ordering data

Type	Order No.	Pcs./Pkt.
STP 3,5-2	0830131	100
STP 3,5-3	0830132	100
STP 4-2	0810575	100
STP 5-2	0800967	100
STP 5-3	0810562	100
STP 5-2/S	0800970	100
STP 4-2-ZB	3038613	100
STP 5-2-ZB	3037643	100
CARRIER-TM 300	0828282	25
CARRIER-TMD 300	0828693	25
CARRIER-TMH 300	0830670	25

Terminal block group marking GBS ...

- Space-saving group labeling directly on the terminal block
- Fits all terminal blocks with a high central marker groove
- Large-surface labeling with labels or manually using B-STIFT or X-PEN



3.5 mm and 5.2 mm pitch



29 mm pitch

General data		Technical data			Technical data		
Material		PA		PA / PC			
Flammability rating in accordance with UL 94		V2		V2			
Temperature range	[°C]	-40 ... 120		-40 ... 100			
Components		free from silicone and halogen		free from silicone and halogen			
Description		Ordering data			Ordering data		
	Color	Type	Order No.	Pcs./Pkt.	Type	Order No.	Pcs./Pkt.
Group marking label , can be snapped into terminal center, can be marked with an EML (24X4)R or EML (25,4X12,7)R... label or manually with B-STIFT or X-PEN, in the foot part with ZB 5, UC-TM 5 or UCT-TM 5	gray	GBS 5-25X5	0829126	100			
	gray	GBS 5-25X12	0810588	100			
Group marking label , can be snapped into terminal center, can be labeled with ESL 26 x 6 or EMT (25 x 6) R insert strips, in foot part with zack marker strip ZB, length: 29 mm	gray				GBS-ZB/26X6	0809298	50

Accessories

Warning labels WS ...



- Warning labels and warning covers serve to cover and identify mains terminal blocks
- This prevents accidental actuation of the terminal points
- The WS UT ... warning labels snap into the screw shafts of the relevant terminal block, they can be isolated lengthwise and crosswise
- The WS PT ... warning labels snap into the inspection holes of the Push-in terminal blocks



General data

Material
Wipe resistance

Technical data

PVC
DIN EN 61010-1 (VDE 0411-1)

Ordering data

Description	Color
Warning label, for PT series	
5.2 mm wide	yellow/black
6.2 mm wide	yellow/black
8.2 mm wide	yellow/black
10.2 mm wide	yellow/black
12 mm wide	yellow/black
Warning label, for UT series	
5.2 mm wide	yellow/black
6.2 mm wide	yellow/black
8.2 mm wide	yellow/black
10.2 mm wide	yellow/black
12 mm wide	yellow/black
16 mm wide	yellow/black
Warning cover, for ST series	
4.2 mm wide	yellow
5.2 mm wide	yellow
6.2 mm wide	yellow
8.2 mm wide	yellow
10.2 mm wide	yellow

Type	Order No.	Pcs./Pkt.
WS PT 2,5	1029026	10
WS PT 4	1029563	10
WS PT 6	1029029	10
WS PT 10	1029030	10
WS PT 16	1029033	10
WS UT 2,5	3047923	10
WS UT 4	3047332	10
WS UT 6	3047345	10
WS UT 10	3047361	10
WS UT 16	3047374	10
WS UT 35	3047387	10
WST 1,5	3030958	50
WST 2,5	3030941	50
WST 4	3030954	50
WST 6	3030967	10
WST 10/35	3030006	25



Warning label, for ST series



Warning label, for PT series

Warning label, with diode circuit symbols



General data		Technical data		
Material		PVC		
Wipe resistance		DIN EN 61010-1 (VDE 0411-1)		
Description		Ordering data		
Color		Type	Order No.	Pcs./Pkt.
Warning label, for the PT series, with diode circuit symbols				
	yellow/black	WS-DIO PT 2,5	1029037	10

CEC ... cover for conductor shaft

- Filler plug for the cover for the conductor shaft
- CEC 2,5 can be used with PT 2,5 Push-in connection terminal blocks and ST 2,5 spring-cage connection terminal blocks
- The CEC PTPOWER ... warning labels can be used with PTPOWER Push-in connection terminal blocks



Cover for PT 2,5 and ST 2,5 terminal blocks



Cover for PTPOWER ... terminal blocks

new

Description		Ordering data			Ordering data		
	Color	Type	Order No.	Pcs./Pkt.	Type	Order No.	Pcs./Pkt.
Cover, for conductor shaft, 10-pos.	yellow	CEC 2,5	3062757	50			
Cover, for conductor shaft with PTPOWER 35 and PTPOWER 50	yellow				CEC PTPOWER 35/50	1056086	10
Cover, for conductor shaft with PTPOWER 95 and PTPOWER 185	yellow				CEC PTPOWER 95/185	1056087	10



You can save time when securing electrical connections and components in switchgear by using suitable mounting devices. Make the best use of space in the control cabinet by cleverly combining mounting accessories. The DIN rails form the basis of the control cabinet inner workings. They guarantee that rail-mounted components are held safely in place.

Phoenix Contact offers a wide range of standardized rails made from various materials. The rails can be ordered cut to length and with pre-drilled holes. The product range is completed with round cable clamps and profile rails.

End brackets are used for secure lateral holding of the components, especially in the event of jolts and vibrations in the systems. Depending on the application, they must either be fastened using screws or can simply be snapped onto the DIN rails as in the case of the CLIPFIX series. Marker carriers can be snapped onto the end brackets. This provides a good overview and creates a visual distinction between individual terminal strip blocks.

There is a wide range of cover profiles to ensure the necessary level of safety. The wide choice of cable ducts provides users with flexible and straightforward cable installation solutions that simply involve breaking out the lateral segments without any need for tools. The mounting material range is rounded off with installation materials that include pick-off terminal blocks, Europe connectors, and junction box connectors.

Detailed information can be found in Catalog 3 or at phoenixcontact.net/products

i Your web code: #0094

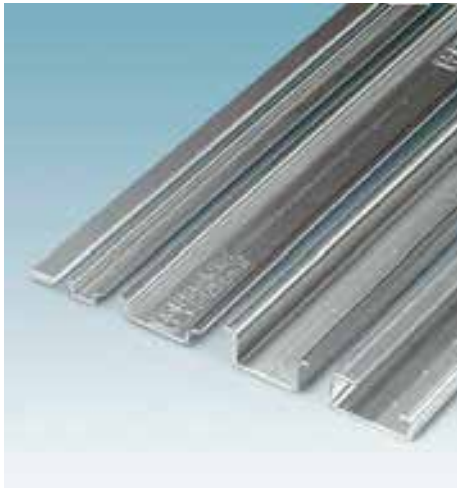

For control cabinet manufacturing applications, the key features of the NS 15 and NS 35 DIN rails are their high degree of dimensional accuracy and double surface tempering. They are galvanized and feature thick layer passivation, which makes them RoHS compliant.

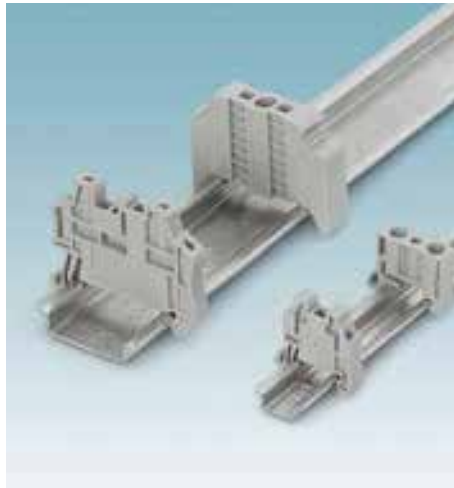

When used in conjunction with the various standard DIN rails, the end brackets ensure that the components remain securely attached to the rails. A comprehensive range of end brackets is available for specific applications.



The cover profiles are used to cover live parts. They also prevent unintended actuation of terminal points or disconnect terminal blocks.



Phoenix Contact offers various connecting terminal blocks, branch terminal blocks and power terminal blocks for busbars in switchgear and control gear.



The wide range of Europe terminal blocks includes terminal blocks with and without wire protection. The individual positions can be separated easily by twisting without the need for tools. The Push-in connection technology of the socket terminal block series makes it easy to insert rigid conductors or conductors with ferrules into the terminal point. Low insertion forces and high pull-out forces ensure a secure connection.



The rail-mountable socket in a standard format is as much a must in modern switchgear as in simple distributors. The socket is mounted in an exposed position to allow assembly tools, service devices, and other electrical equipment to be installed conveniently.

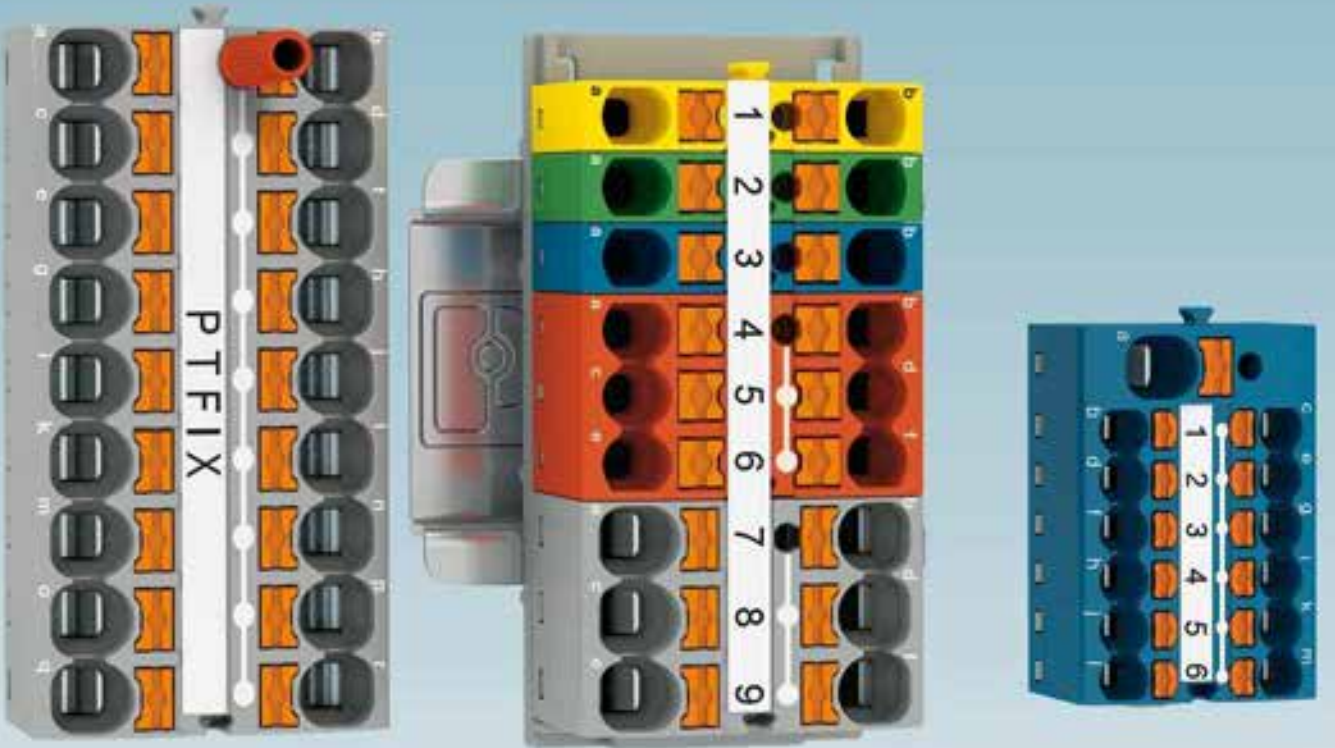
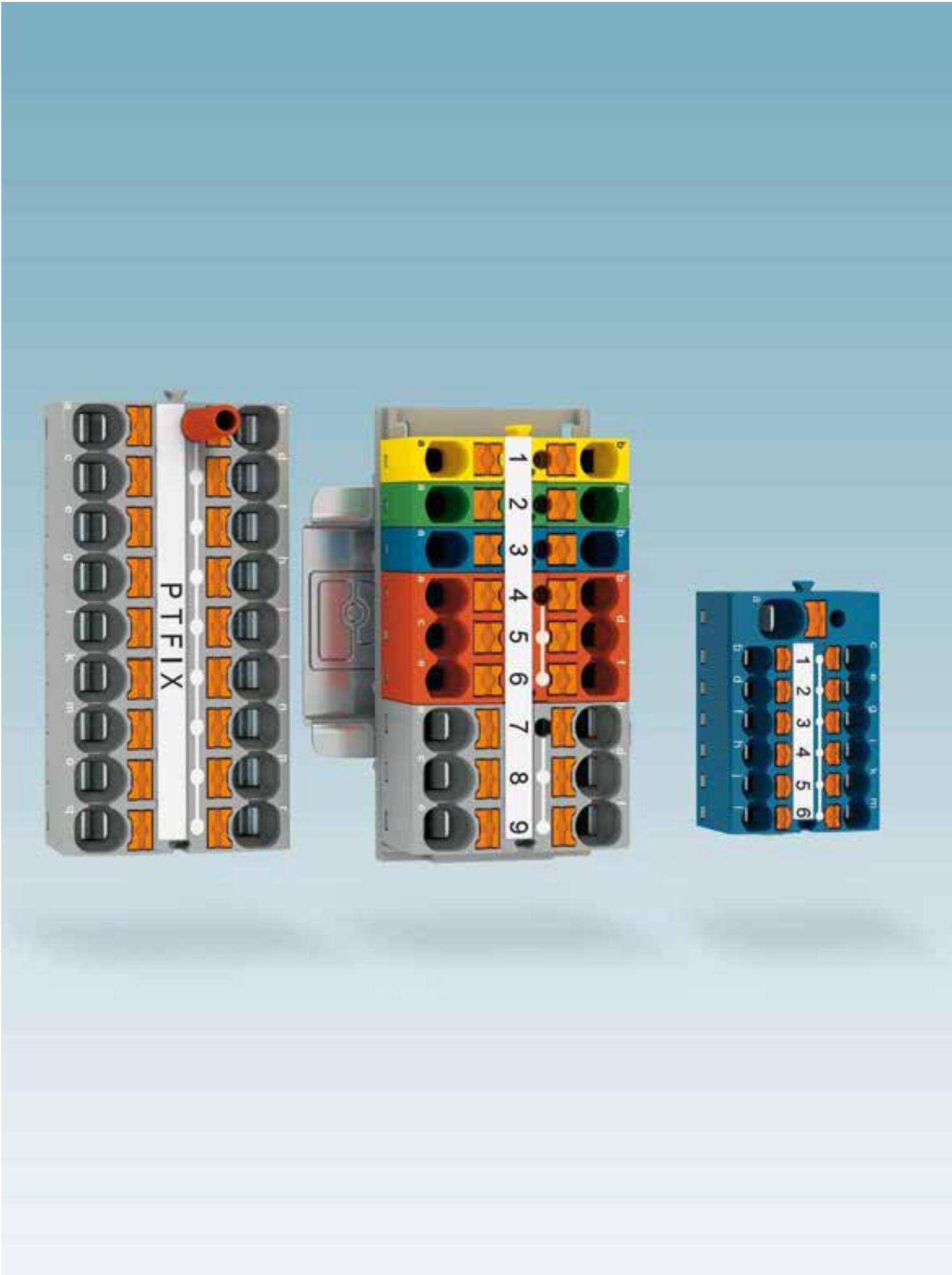

PTFIX ... distribution blocks

The PTFIX distribution blocks with Push-in connection come ready to connect and are available with various numbers of positions and mounting types. They can be used straight away and expanded as needed. PTFIX thus helps to ensure flexible and cost-effective load and control current distribution.

The Push-in connection technology enables you to insert conductors quickly and easily. Even small conductors from 0.25 mm² can be connected reliably and without using tools. Simply use the push button for disconnection purposes and to connect flexible conductors without ferrules.

Product range overview

1.5 mm²

Distribution blocks	428
Distribution blocks with feed-in	434

2.5 mm²

Distribution blocks	438
Distribution blocks with feed-in	442

4 mm²

Distribution blocks	446
Distribution blocks with feed-in	450

Distribution blocks

PTFIX distributor blocks



The PTFIX distribution blocks with Push-in connection come ready to connect and are available with various numbers of positions and mounting types. They can be used straight away and expanded as needed. PTFIX thus helps to ensure flexible and cost-effective load and control current distribution.

i Your web code: #2041



Simply unpack, connect, and you're done!

Ready-to-connect blocks enable fast assembly without manual bridging, offering time savings of up to 80%.



Easy insertion

The reduction in insertion forces of up to 50% permits easy and direct insertion of rigid and flexible conductors with ferrules with a cross section of 0.34 mm² or greater. Stranded conductors without ferrules are connected using the push button.



Intuitive and secure installation

Distribution and feed blocks with 6, 12, and 18 terminal points are available for intuitive and secure installation in 11 colors.



Distribution block versions for transverse mounting on the DIN rail enable high wiring density and space savings of up to 50%.



The distribution blocks are mounted on 35 mm standard DIN rails and enable easy-to-see and convenient conductor routing.



Distribution blocks for mounting on 15 mm standard DIN rails are available for use in small junction boxes.



The self-adhesive distribution blocks can be quickly and easily fixed to flat surfaces with no mounting preparation and no tools.



The basic blocks can be individually self-assembled with different adapters or flanges in accordance with the desired mounting type.



Optional snap-on mounting accessories for direct or DIN rail mounting.



The distribution blocks can be connected in series and individually expanded with the two-pos. plug-in bridges from the CLIPLINE complete system.



The reducing bridge from the CLIPLINE complete system accessories enables easy connection of terminal blocks with different nominal cross sections, e.g., a PT 10 Push-in terminal block.



Convenient testing option with 2.3 mm test plug in easily accessible test opening. Marker strips can be supplied for easy wiring identification.

Distribution blocks

1.5 mm² PTFIX distribution blocks

General technical data

Rated data		IEC 60947-7-1 / IEC 60998-2-2			
Rated cross section	[mm ²]	1.5			
Cross section range	AWG	26 - 14			
Connection capacity		Rigid	Flexible	Ferrule without/with plastic sleeve	
1 conductor	[mm ²]	0.14 - 2.5	0.14 - 1.5	0.14 - 1.5	0.14 - 1.5
2 flexible conductors with a TWIN ferrule	[mm ²]	-	-	-	-
Connection cross sections directly plug-in	[mm ²]	0.34 - 2.5	-	0.34 - 1.5	0.34 - 1.5
General data					
Stripping length	[mm]	8 - 10			
Insulating material		PA			
Flammability rating in accordance with UL 94		V0			

Notes:

The specified technical data and approvals refer to the first product in each column. For information on the products below, please refer to phoenixcontact.net/products

For full details of UL and CSA use groups, file nos., and Internet links, please visit phoenixcontact.net/products

¹⁾ The bridge current is listed alongside the respective product. For additional colors, see page 402.

Note: Additional or deviating data is listed alongside the respective product.

System accessories

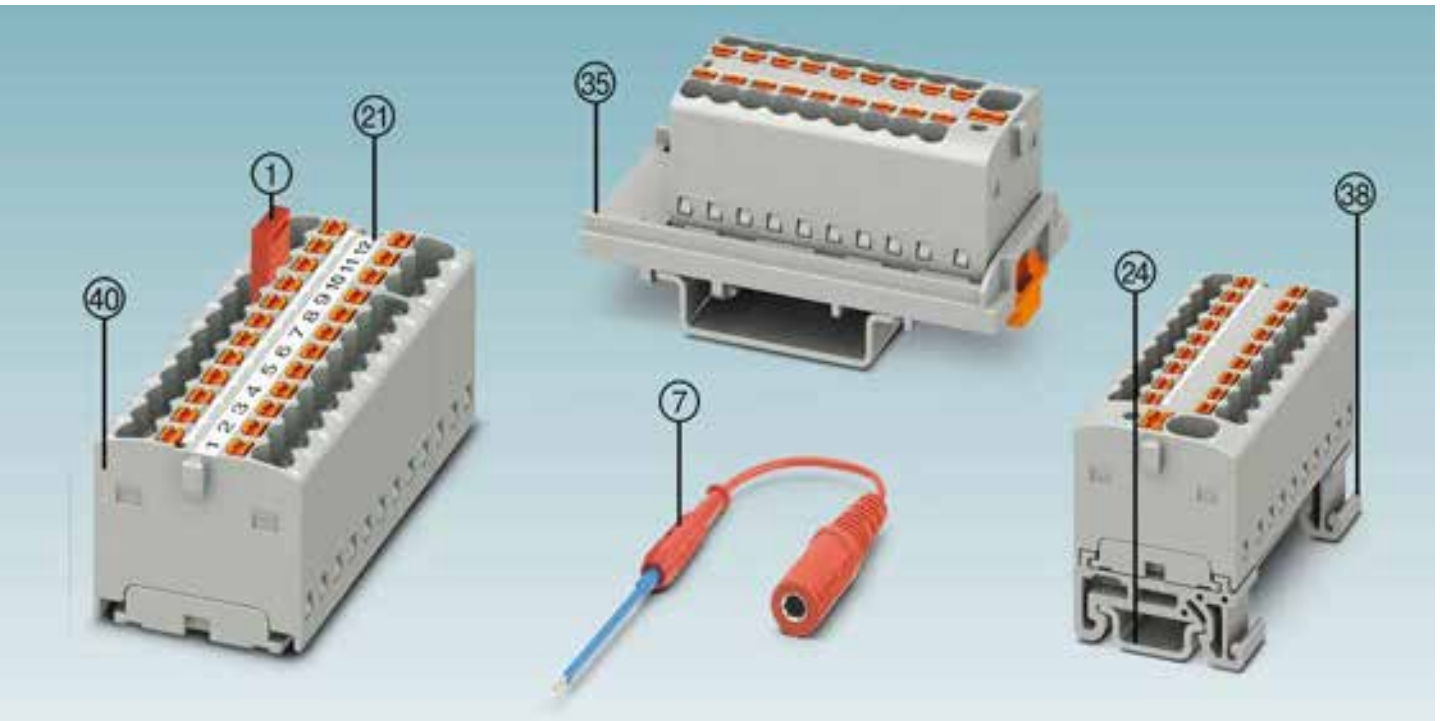

Description	No. of pos.	Color	Type	Order No.	Pcs./Pkt.	Type	Order No.	Pcs./Pkt.
① Bridge ¹⁾	2	red	FBS 2-4	3030116	50			
② Test plug			MPS-MT 1-S	1944372	1			
⑦ Test adapter, 4 mm socket hole			MPS-MT 1-S4-B RD	1982800	50			
③⑤ NS 35 or NS 15 DIN rail adapters, transverse			PTFIX 1,5-NS35	1049497	30			
③⑤ NS 35 DIN rail adapters, lateral			PTFIX 1,5-NS35AD	1049498	30			
NS 35 DIN rail adapters with end bracket function, lateral			PTFIX 1,5-NS35AD-FIX	1049499	30			
③⑤ NS 15 DIN rail adapters, lateral			PTFIX 1,5-NS15A	1049500	30			
NS 15 DIN rail adapters with end bracket function, lateral			PTFIX 1,5-NS15A-FIX	1049501	30			
④⑥ Mounting flange		gray	PTFIX 1,5-F	1049503	30			
④⑥ Mounting flange			PTFIX 1,5-RZF	1050613	20			
Screwdriver			SZF 0-0,4X2,5	1204504	10			
②③ Center groove labeling	TML (... X3.8)R, see also Catalog 3							
②③ DIN rail and end bracket	See Catalog 3							
For full accessories, visit phoenixcontact.net/products	Note: Additional or deviating accessories are listed alongside the respective product.							

1.5 mm² PTFIX distribution blocks

PTFIX ... distribution blocks

The basic blocks can be individually self-assembled with different adapters or flanges in accordance with the desired mounting type.

Notes:
1) For additional accessories and technical data, see page 428.
With distribution blocks, the maximum permissible total current can vary with different numbers of terminal points.

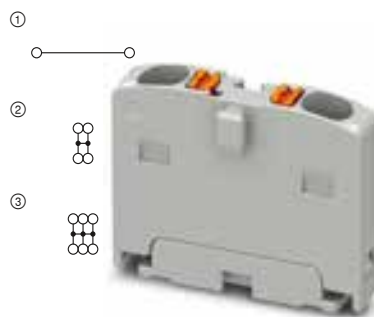

20 A, basic block, for self-assembly



Dimensions	
	[mm]
Width	4.2
Length	21.6
Height	17.7
Maximum electrical data	
I_{max} [A]	20
U_{max} [V]	450
Rated voltage	450 [V]
Nominal current / cross section	17.5 [A] / [mm ²]

Technical data ¹⁾				
Width	Length	Height		
4.2	21.6	17.7		
I_{max} [A]	U_{max} [V]	max. Ø [mm ²]	AWG (UL)	
20	450	0.14 - 2.5	26-14	
IEC	UL / CUL	CSA	Ex	
450	300	300	-	
17.5	15 / -	15 / -	- / -	

Description	Color
Basic block, 2 terminal points	gray
4 terminal points	gray
6 terminal points	gray
12 terminal points	gray
18 terminal points	gray
2 terminal points	blue
4 terminal points	blue
6 terminal points	blue
12 terminal points	blue
18 terminal points	blue
2 terminal points	red
4 terminal points	red
6 terminal points	red
12 terminal points	red
18 terminal points	red
2 terminal points	yellow
4 terminal points	yellow
6 terminal points	yellow
12 terminal points	yellow
18 terminal points	yellow
2 terminal points	green
4 terminal points	green
6 terminal points	green
12 terminal points	green
18 terminal points	green
2 terminal points	brown
4 terminal points	brown
6 terminal points	brown
12 terminal points	brown
18 terminal points	brown
2 terminal points	white
4 terminal points	white
6 terminal points	white
12 terminal points	white
18 terminal points	white
2 terminal points	black
4 terminal points	black
6 terminal points	black
12 terminal points	black
18 terminal points	black
2 terminal points	violet
4 terminal points	violet
6 terminal points	violet
12 terminal points	violet
18 terminal points	violet
2 terminal points	pink
4 terminal points	pink
6 terminal points	pink
12 terminal points	pink
18 terminal points	pink

Ordering data			
Type	Order No.	Pcs./Pkt.	
PTFIX 2X1,5 GY	1045923	50	①
PTFIX 4X1,5 GY	1046608	30	②
PTFIX 6X1,5 GY	3002757	20	③
PTFIX 12X1,5 GY	3002758	20	
PTFIX 18X1,5 GY	3002760	20	
PTFIX 2X1,5 BU	1045925	50	①
PTFIX 4X1,5 BU	1046610	30	②
PTFIX 6X1,5 BU	3002761	20	③
PTFIX 12X1,5 BU	3002763	20	
PTFIX 18X1,5 BU	3002764	20	
PTFIX 2X1,5 RD	1045929	50	①
PTFIX 4X1,5 RD	1046611	30	②
PTFIX 6X1,5 RD	3002765	20	③
PTFIX 12X1,5 RD	3002766	20	
PTFIX 18X1,5 RD	3002767	20	
PTFIX 2X1,5 YE	1045931	50	①
PTFIX 4X1,5 YE	1046612	30	②
PTFIX 6X1,5 YE	3002768	20	③
PTFIX 12X1,5 YE	3002769	20	
PTFIX 18X1,5 YE	3002770	20	
PTFIX 2X1,5 GN	1045932	50	①
PTFIX 4X1,5 GN	1046613	30	②
PTFIX 6X1,5 GN	3002771	20	③
PTFIX 12X1,5 GN	3002772	20	
PTFIX 18X1,5 GN	3002773	20	
PTFIX 2X1,5 BN	1045935	50	①
PTFIX 4X1,5 BN	1046614	30	②
PTFIX 6X1,5 BN	3002774	20	③
PTFIX 12X1,5 BN	3002776	20	
PTFIX 18X1,5 BN	3002777	20	
PTFIX 2X1,5 WH	1045936	50	①
PTFIX 4X1,5 WH	1046615	30	②
PTFIX 6X1,5 WH	3002778	20	③
PTFIX 12X1,5 WH	3002779	20	
PTFIX 18X1,5 WH	3002780	20	
PTFIX 2X1,5 BK	1045937	50	①
PTFIX 4X1,5 BK	1046616	30	②
PTFIX 6X1,5 BK	3002781	20	③
PTFIX 12X1,5 BK	3002782	20	
PTFIX 18X1,5 BK	3002783	20	
PTFIX 2X1,5 VT	1045940	50	①
PTFIX 4X1,5 VT	1046617	30	②
PTFIX 6X1,5 VT	3002784	20	③
PTFIX 12X1,5 VT	3002785	20	
PTFIX 18X1,5 VT	3002786	20	
PTFIX 2X1,5 PK	1045941	50	①
PTFIX 4X1,5 PK	1046618	30	②
PTFIX 6X1,5 PK	3002787	20	③
PTFIX 12X1,5 PK	3002789	20	
PTFIX 18X1,5 PK	3002790	20	

Distribution blocks

1.5 mm² PTFIX distribution blocks

PTFIX ... distribution blocks

Notes:
With distribution blocks, the maximum permissible total current can vary with different numbers of terminal points.
¹⁾ For additional accessories and technical data, see page 428.

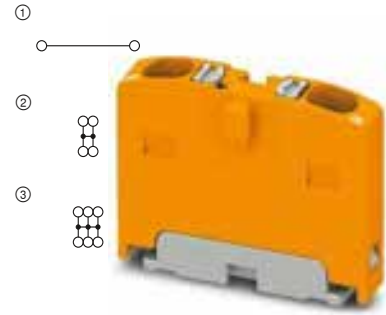

20 A, basic block, for self-assembly



Dimensions	
	[mm]
Maximum electrical data	
Rated data	
Rated voltage	[V]
Nominal current / cross section	[A] / [mm ²]

Technical data ¹⁾			
Width	Length	Height	
4.2	21.6	17.7	
I _{max} [A]	U _{max} [V]	max. Ø [mm ²]	AWG (UL)
20	450	0.14 - 2.5	26-14
IEC	UL / CUL	CSA	Ex
450	300	300	-
17.5	15 / -	15 / -	- / -

Description	Color
Basic block, 2 terminal points	orange
4 terminal points	orange
6 terminal points	orange
12 terminal points	orange
18 terminal points	orange
2 terminal points	black/yellow
4 terminal points	black/yellow
6 terminal points	black/yellow
12 terminal points	black/yellow
18 terminal points	black/yellow

Ordering data		
Type	Order No.	Pcs./Pkt.
PTFIX 2X1,5 OG	① 1045939	50
PTFIX 4X1,5 OG	② 1046619	30
PTFIX 6X1,5 OG	③ 3002792	20
PTFIX 12X1,5 OG	3002793	20
PTFIX 18X1,5 OG	3002794	20
PTFIX 2X1,5-FE	① 1045933	50
PTFIX 4X1,5-FE	② 1046620	30
PTFIX 6X1,5-FE	③ 3002795	20
PTFIX 12X1,5-FE	3002796	20
PTFIX 18X1,5-FE	3002797	20

Distribution blocks

1.5 mm² PTFIX distribution blocks

PTFIX ... distribution blocks

- The self-adhesive distribution blocks can be attached quickly and simply to flat surfaces with no preparation
- Distribution blocks are available for mounting onto 15 mm standard DIN rails for use in small junction boxes

Notes:
For additional accessories and technical data, see page 428.
With distribution blocks, the maximum permissible total current can vary with different numbers of terminal points.

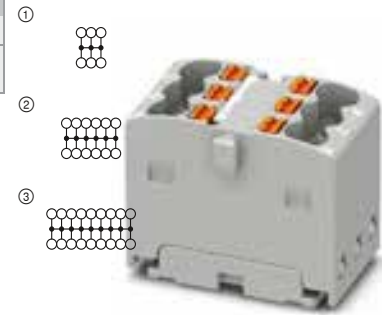

26 A, adhesive mounting



Dimensions	
	[mm]
Dimensions	
	[mm]
Dimensions	
	[mm]
Maximum electrical data	
Rated data	
Rated voltage	[V]
Nominal current / cross section	[A] / [mm ²]

Technical data			
Width	Length	Height NS 35/7,5	
12.5	21.6	-	
Width	Length	Height NS 15	
12.5	21.6	-	
Width	Length	Height	
12.5	21.6	18.7	
I _{max} [A]	U _{max} [V]	max. Ø [mm ²]	AWG (UL)
26	450	0.14 - 2.5	26-14
IEC	UL / CUL	CSA	IEC/EN 60079-7
450	300	300	-
17.5 / -	15	15 / -	-

Description	Color
Basic block, 6 terminal points	gray
12 terminal points	gray
18 terminal points	gray
6 terminal points	blue
12 terminal points	blue
18 terminal points	blue
6 terminal points	red
12 terminal points	red
18 terminal points	red
6 terminal points	yellow
12 terminal points	yellow
18 terminal points	yellow
6 terminal points	green
12 terminal points	green
18 terminal points	green
6 terminal points	brown
12 terminal points	brown
18 terminal points	brown
6 terminal points	white
12 terminal points	white
18 terminal points	white
6 terminal points	black
12 terminal points	black
18 terminal points	black
6 terminal points	violet
12 terminal points	violet
18 terminal points	violet
6 terminal points	pink
12 terminal points	pink
18 terminal points	pink
6 terminal points	orange
12 terminal points	orange
18 terminal points	orange
6 terminal points	black/yellow
12 terminal points	black/yellow
18 terminal points	black/yellow

Ordering data			
Type	Order No.	Pcs./Pkt.	
PTFIX 6X1,5-G GY	① 3002798	20	
PTFIX 12X1,5-G GY	② 3002799	20	
PTFIX 18X1,5-G GY	③ 3002804	20	
PTFIX 6X1,5-G BU	① 3002864	20	
PTFIX 12X1,5-G BU	② 3002865	20	
PTFIX 18X1,5-G BU	③ 3002876	20	
PTFIX 6X1,5-G RD	① 3002877	20	
PTFIX 12X1,5-G RD	② 3002878	20	
PTFIX 18X1,5-G RD	③ 3002879	20	
PTFIX 6X1,5-G YE	① 3002880	20	
PTFIX 12X1,5-G YE	② 3002881	20	
PTFIX 18X1,5-G YE	③ 3002882	20	
PTFIX 6X1,5-G GN	① 3002883	20	
PTFIX 12X1,5-G GN	② 3002884	20	
PTFIX 18X1,5-G GN	③ 3002886	20	
PTFIX 6X1,5-G BN	① 3002887	20	
PTFIX 12X1,5-G BN	② 3002888	20	
PTFIX 18X1,5-G BN	③ 3002889	20	
PTFIX 6X1,5-G WH	① 3002890	20	
PTFIX 12X1,5-G WH	② 3002891	20	
PTFIX 18X1,5-G WH	③ 3002892	20	
PTFIX 6X1,5-G BK	① 3002893	20	
PTFIX 12X1,5-G BK	② 3002894	20	
PTFIX 18X1,5-G BK	③ 3002895	20	
PTFIX 6X1,5-G VT	① 3002896	20	
PTFIX 12X1,5-G VT	② 3002897	20	
PTFIX 18X1,5-G VT	③ 3002899	20	
PTFIX 6X1,5-G PK	① 3002900	20	
PTFIX 12X1,5-G PK	② 3002901	20	
PTFIX 18X1,5-G PK	③ 3002902	20	
PTFIX 6X1,5-G OG	① 3002903	20	
PTFIX 12X1,5-G OG	② 3002904	20	
PTFIX 18X1,5-G OG	③ 3002905	20	
PTFIX 6X1,5-G FE	① 3002906	20	
PTFIX 12X1,5-G FE	② 3002907	20	
PTFIX 18X1,5-G FE	③ 3002909	20	

new

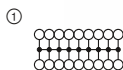

26 A, mounting on DIN rail NS 35 or NS 15, transverse to the DIN rail

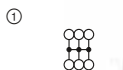

26 A, mounting on DIN rail NS 15, along the DIN rail



Technical data			
Width	Length	Height NS 35/7,5	
21.6	58.1	28.4	
Width	Length	Height NS 15	
21.6	58.1	26.4	
Width	Length	Height	
21.6	58.1	-	
I _{max} [A]	U _{max} [V]	max. Ø [mm ²]	AWG (UL)
26	500	0.14 - 2.5	26-14
IEC	UL / CUL	CSA	IEC/ EN 60079-7
500	300	300	-
17.5 / -	15	15 / -	-

Technical data			
Width	Length	Height NS 35/7,5	
12.5	21.6	-	
Width	Length	Height NS 15	
12.5	21.6	27.4	
Width	Length	Height	
12.5	21.6	-	
I _{max} [A]	U _{max} [V]	max. Ø [mm ²]	AWG (UL)
26	500	0.14 - 2.5	26-14
IEC	UL / CUL	CSA	IEC/ EN 60079-7
500	300	300	-
17.5 / -	15	15 / -	-

Ordering data		
Type	Order No.	Pcs./Pkt.
PTFIX 18X1,5-NS35 GY	① 1046949	20
PTFIX 18X1,5-NS35 BU	① 1046950	20
PTFIX 18X1,5-NS35 RD	① 1046951	20
PTFIX 18X1,5-NS35 YE	① 1046954	20
PTFIX 18X1,5-NS35 GN	① 1046953	20
PTFIX 18X1,5-NS35 BN	① 1046952	20
PTFIX 18X1,5-NS35 WH	① 1046956	20
PTFIX 18X1,5-NS35 BK	① 1046955	20
PTFIX 18X1,5-NS35 VT	① 1046957	20
PTFIX 18X1,5-NS35 PK	① 1046959	20
PTFIX 18X1,5-NS35 OG	① 1046958	20
PTFIX 18X1,5-NS35-FE	① 1046960	20

Ordering data		
Type	Order No.	Pcs./Pkt.
PTFIX 6X1,5-NS15A GY	① 3002910	20
PTFIX 12X1,5-NS15A GY	② 3002914	20
PTFIX 18X1,5-NS15A GY	③ 3002917	20
PTFIX 6X1,5-NS15A BU	① 3002919	20
PTFIX 12X1,5-NS15A BU	② 3002922	20
PTFIX 18X1,5-NS15A BU	③ 3002926	20
PTFIX 6X1,5-NS15A RD	① 3002928	20
PTFIX 12X1,5-NS15A RD	② 3002931	20
PTFIX 18X1,5-NS15A RD	③ 3002934	20
PTFIX 6X1,5-NS15A YE	① 3002955	20
PTFIX 12X1,5-NS15A YE	② 3002958	20
PTFIX 18X1,5-NS15A YE	③ 3002961	20
PTFIX 6X1,5-NS15A GN	① 3002963	20
PTFIX 12X1,5-NS15A GN	② 3002964	20
PTFIX 18X1,5-NS15A GN	③ 3002965	20
PTFIX 6X1,5-NS15A BN	① 3002970	20
PTFIX 12X1,5-NS15A BN	② 3002971	20
PTFIX 18X1,5-NS15A BN	③ 3002972	20
PTFIX 6X1,5-NS15A WH	① 3002936	20
PTFIX 12X1,5-NS15A WH	② 3002941	20
PTFIX 18X1,5-NS15A WH	③ 3002944	20
PTFIX 6X1,5-NS15A BK	① 3002967	20
PTFIX 12X1,5-NS15A BK	② 3002968	20
PTFIX 18X1,5-NS15A BK	③ 3002969	20
PTFIX 6X1,5-NS15A VT	① 3002973	20
PTFIX 12X1,5-NS15A VT	② 3002974	20
PTFIX 18X1,5-NS15A VT	③ 3002975	20
PTFIX 6X1,5-NS15A PK	① 3002976	20
PTFIX 12X1,5-NS15A PK	② 3002977	20
PTFIX 18X1,5-NS15A PK	③ 3002978	20
PTFIX 6X1,5-NS15A OG	① 3002946	20
PTFIX 12X1,5-NS15A OG	② 3002949	20
PTFIX 18X1,5-NS15A OG	③ 3002952	20
PTFIX 6X1,5-NS15A-FE	① 3002980	20
PTFIX 12X1,5-NS15A-FE	② 3002981	20
PTFIX 18X1,5-NS15A-FE	③ 3002983	20

Distribution blocks

1.5 mm² distribution blocks with PTFIX feed-in

General technical data

Rated data		IEC 60947-7-1 / IEC 60998-2-2
Rated cross section	[mm ²]	1.5
Cross section range	AWG	26 - 14
Connection capacity		Rigid Flexible Ferrule without/with plastic sleeve
1 conductor	[mm ²]	0.14 - 2.5 0.14 - 1.5 0.14 - 1.5 0.14 - 1.5
2 flexible conductors with a TWIN ferrule	[mm ²]	- - - -
Connection cross sections directly plug-in	[mm ²]	0.34 - 2.5 - 0.34 - 1.5 0.34 - 1.5
Rated data, feed		IEC 60947-7-1 / IEC 60998-2-2
Nominal current / cross section range	[A] / [AWG]	41 - , 57 - / 24 - 12
Supply connection capacity		Rigid Flexible Ferrule without/with plastic sleeve
1 conductor	[mm ²]	0.2 - 6 0.2 - 4 0.2 - 4 0.2 - 4
2 flexible conductors with a TWIN ferrule	[mm ²]	- - - -
Connection cross sections directly plug-in	[mm ²]	0.34 - 6 4 0.2 - 4 0.2 - 4
General data		
Stripping length	[mm]	8 - 10
Insulating material		PA
Flammability rating in accordance with UL 94		V0

Notes:

The specified technical data and approvals refer to the first product in each column. For information on the products below, please refer to phoenixcontact.net/products

For full details of UL and CSA use groups, file nos., and Internet links, please visit phoenixcontact.net/products

1) The bridge current is listed alongside the respective product. For additional colors, see page 402.

Note: Additional or deviating data is listed alongside the respective product.

System accessories

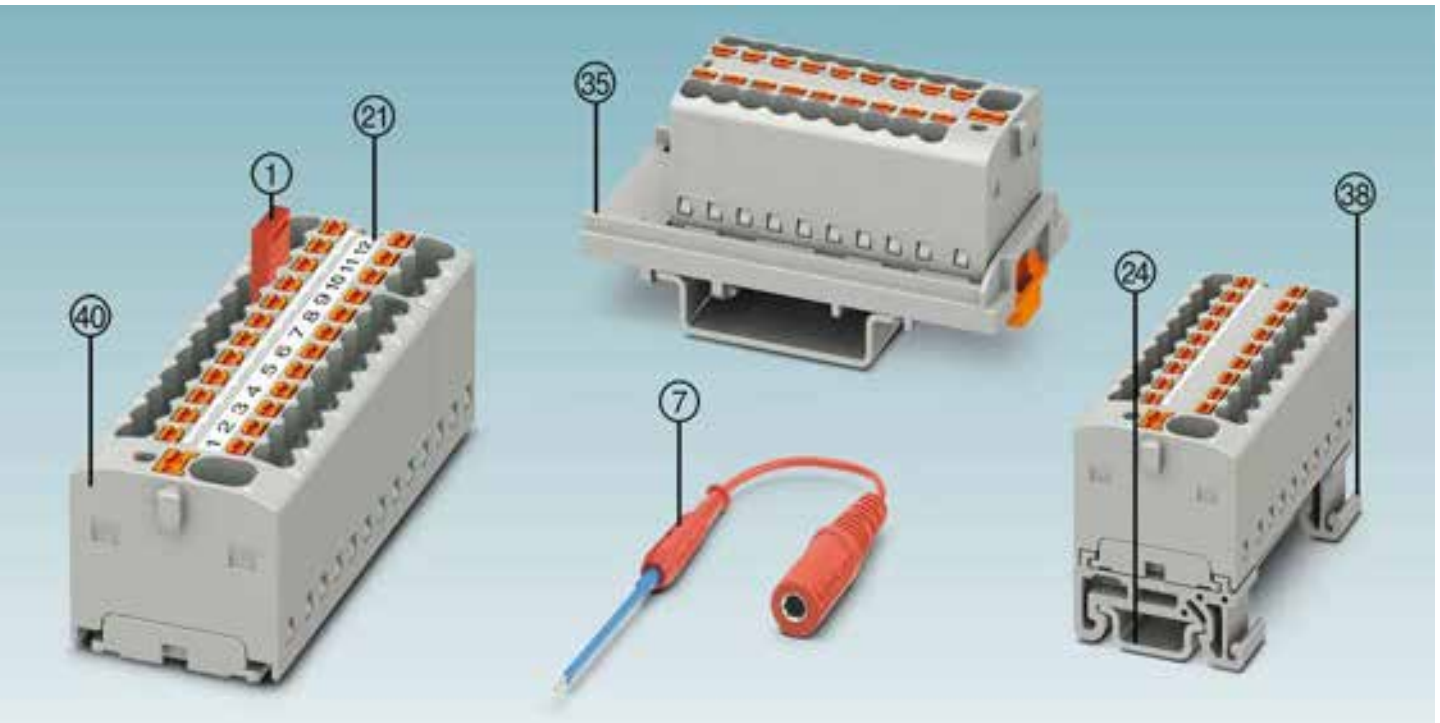

Description	No. of pos.	Color	Type	Order No.	Pcs./Pkt.	Type	Order No.	Pcs./Pkt.
① Bridge ¹⁾	2	red	FBS 2-4	3030116	50			
② Test plug			MPS-MT 1-S	1944372	1			
⑦ Test adapter, 4 mm socket hole			MPS-MT 1-S4-B RD	1982800	50			
③⑤ NS 35 or NS 15 DIN rail adapters, transverse			PTFIX 1,5-NS35	1049497	30			
③⑥ NS 35 DIN rail adapters, lateral			PTFIX 1,5-NS35AD	1049498	30			
NS 35 DIN rail adapters with end bracket function, lateral			PTFIX 1,5-NS35AD-FIX	1049499	30			
③⑧ NS 15 DIN rail adapters, lateral			PTFIX 1,5-NS15A	1049500	30			
NS 15 DIN rail adapters with end bracket function, lateral			PTFIX 1,5-NS15A-FIX	1049501	30			
④④ Mounting flange		gray	PTFIX 1,5-F	1049503	30			
Screwdriver			SZF 0-0,4X2,5	1204504	10			
②① Center groove labeling			TML (... X3.8)R, see also Catalog 3					
②② DIN rail and end bracket			See Catalog 3					
For full accessories, visit phoenixcontact.net/products			Note: Additional or deviating accessories are listed alongside the respective product.					

PTFIX ... distribution blocks

The basic blocks can be individually self-assembled with different adapters or flanges in accordance with the desired mounting type.

Notes:
1) For additional accessories and technical data, see page 434.
Observe DIN IEC 60364-4-43 (DIN VDE 0100-430:2010-10) section 433.2 ff.
With distribution blocks, the maximum permissible total current can vary with different numbers of terminal points.



new

32 A, basic block, with feed-in, for self-assembly

ERIC

Dimensions	[mm]
Maximum electrical data	
Rated data	
Rated voltage	[V]
Nominal current / cross section	[A] / [mm ²]

Technical data ¹⁾				
Width	Length	Height		
19	21.6	17.7		
I _{max.} [A]	U _{max.} [V]	max. Ø [mm ²]	AWG (UL)	
32	450	0.14 - 2.5	-	
IEC	UL / CUL	CSA	Ex	
450	-	-	-	
17.5	- / -	- / -	- / -	

Description	Color
Basic block, with supply, 7 terminal points	gray
13 terminal points	gray
19 terminal points	gray
7 terminal points	blue
13 terminal points	blue
19 terminal points	blue
7 terminal points	red
13 terminal points	red
19 terminal points	red
7 terminal points	yellow
13 terminal points	yellow
19 terminal points	yellow
7 terminal points	green
13 terminal points	green
19 terminal points	green
7 terminal points	brown
13 terminal points	brown
19 terminal points	brown
7 terminal points	white
13 terminal points	white
19 terminal points	white
7 terminal points	black
13 terminal points	black
19 terminal points	black
7 terminal points	violet
13 terminal points	violet
19 terminal points	violet
7 terminal points	pink
13 terminal points	pink
19 terminal points	pink
7 terminal points	orange
13 terminal points	orange
19 terminal points	orange
7 terminal points	black/yellow
13 terminal points	black/yellow
19 terminal points	black/yellow

Ordering data		
Type	Order No.	Pcs./Pkt.
PTFIX 4/6X1,5 GY ①	1047466	20
PTFIX 4/12X1,5 GY ②	1046961	20
PTFIX 4/18X1,5 GY ③	1047418	20
PTFIX 4/6X1,5 BU ①	1047467	20
PTFIX 4/12X1,5 BU ②	1046962	20
PTFIX 4/18X1,5 BU ③	1047419	20
PTFIX 4/6X1,5 RD ①	1047468	20
PTFIX 4/12X1,5 RD ②	1046963	20
PTFIX 4/18X1,5 RD ③	1047420	20
PTFIX 4/6X1,5 YE ①	1047471	20
PTFIX 4/12X1,5 YE ②	1046966	20
PTFIX 4/18X1,5 YE ③	1047423	20
PTFIX 4/6X1,5 GN ①	1047470	20
PTFIX 4/12X1,5 GN ②	1046965	20
PTFIX 4/18X1,5 GN ③	1047422	20
PTFIX 4/6X1,5 BN ①	1047469	20
PTFIX 4/12X1,5 BN ②	1046964	20
PTFIX 4/18X1,5 BN ③	1047421	20
PTFIX 4/6X1,5 WH ①	1047473	20
PTFIX 4/12X1,5 WH ②	1046972	20
PTFIX 4/18X1,5 WH ③	1047425	20
PTFIX 4/6X1,5 BK ①	1047472	20
PTFIX 4/12X1,5 BK ②	1046967	20
PTFIX 4/18X1,5 BK ③	1047424	20
PTFIX 4/6X1,5 VT ①	1047474	20
PTFIX 4/12X1,5 VT ②	1046968	20
PTFIX 4/18X1,5 VT ③	1047426	20
PTFIX 4/6X1,5 PK ①	1047476	20
PTFIX 4/12X1,5 PK ②	1046970	20
PTFIX 4/18X1,5 PK ③	1047428	20
PTFIX 4/6X1,5 OG ①	1047475	20
PTFIX 4/12X1,5 OG ②	1046969	20
PTFIX 4/18X1,5 OG ③	1047427	20
PTFIX 4/6X1,5-FE ①	1047477	20
PTFIX 4/12X1,5-FE ②	1046971	20
PTFIX 4/18X1,5-FE ③	1047429	20

Distribution blocks

1.5 mm² distribution blocks with PTFIX feed-in

Distribution blocks

Notes:
For additional accessories and technical data, see page 434.
Observe DIN IEC 60364-4-43 (DIN VDE 0100-430:2010-10) section 433.2 ff.
With distribution blocks, the maximum permissible total current can vary with different numbers of terminal points.

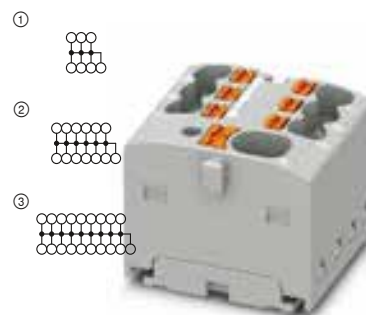

32 A, adhesive mounting

ERC

Dimensions	
	[mm]
Dimensions	
	[mm]
Dimensions	
	[mm]
Maximum electrical data	
Rated data	
Rated voltage	[V]
Nominal current / cross section	[A] / [mm ²]

Technical data			
Width	Length	Height NS 35/7,5	
19	21.6	-	
Width	Length	Height NS 15	
19	21.6	-	
Width	Length	Height	
19	21.6	18.7	
I _{max} [A]	U _{max} [V]	max. Ø [mm ²]	AWG (UL)
32	450	0.14 - 2.5	-
IEC	UL / CUL	CSA	IEC/EN 60079-7
450	-	-	-
17.5 / -	-	-	-

Description	Color
Basic block, with supply, 7 terminal points	gray
13 terminal points	gray
19 terminal points	gray
7 terminal points	blue
13 terminal points	blue
19 terminal points	blue
7 terminal points	red
13 terminal points	red
19 terminal points	red
7 terminal points	yellow
13 terminal points	yellow
19 terminal points	yellow
7 terminal points	green
13 terminal points	green
19 terminal points	green
7 terminal points	brown
13 terminal points	brown
19 terminal points	brown
7 terminal points	white
13 terminal points	white
19 terminal points	white
7 terminal points	black
13 terminal points	black
19 terminal points	black
7 terminal points	violet
13 terminal points	violet
19 terminal points	violet
7 terminal points	pink
13 terminal points	black/yellow
19 terminal points	pink
7 terminal points	orange
13 terminal points	orange
19 terminal points	orange
7 terminal points	black/yellow
13 terminal points	black/yellow
19 terminal points	black/yellow

Ordering data			
Type	Order No.	Pcs./Pkt.	
PTFIX 4/6X1,5-G GY	① 1047478	20	
PTFIX 4/12X1,5-G GY	② 1046973	20	
PTFIX 4/18X1,5-G GY	③ 1047430	20	
PTFIX 4/6X1,5-G BU	① 1047479	20	
PTFIX 4/12X1,5-G BU	② 1046974	20	
PTFIX 4/18X1,5-G BU	③ 1047431	20	
PTFIX 4/6X1,5-G RD	① 1047480	20	
PTFIX 4/12X1,5-G RD	② 1046975	20	
PTFIX 4/18X1,5-G RD	③ 1047432	20	
PTFIX 4/6X1,5-G YE	① 1047483	20	
PTFIX 4/12X1,5-G YE	② 1046978	20	
PTFIX 4/18X1,5-G YE	③ 1047435	20	
PTFIX 4/6X1,5-G GN	① 1047482	20	
PTFIX 4/12X1,5-G GN	② 1046977	20	
PTFIX 4/18X1,5-G GN	③ 1047434	20	
PTFIX 4/6X1,5-G BN	① 1047481	20	
PTFIX 4/12X1,5-G BN	② 1046976	20	
PTFIX 4/18X1,5-G BN	③ 1047433	20	
PTFIX 4/6X1,5-G WH	① 1047485	20	
PTFIX 4/12X1,5-G WH	② 1046980	20	
PTFIX 4/18X1,5-G WH	③ 1047437	20	
PTFIX 4/6X1,5-G BK	① 1047484	20	
PTFIX 4/12X1,5-G BK	② 1046979	20	
PTFIX 4/18X1,5-G BK	③ 1047436	20	
PTFIX 4/6X1,5-G VT	① 1047486	20	
PTFIX 4/12X1,5-G VT	② 1046981	20	
PTFIX 4/18X1,5-G VT	③ 1047438	20	
PTFIX 4/6X1,5-G PK	① 1047488	20	
PTFIX 4/12X1,5-G PK	② 1046983	20	
PTFIX 4/18X1,5-G PK	③ 1047440	20	
PTFIX 4/6X1,5-G OG	① 1047487	20	
PTFIX 4/12X1,5-G OG	② 1046982	20	
PTFIX 4/18X1,5-G OG	③ 1047439	20	
PTFIX 4/6X1,5-G FE	① 1047489	20	
PTFIX 4/12X1,5-G FE	② 1046984	20	
PTFIX 4/18X1,5-G FE	③ 1047441	20	

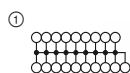

32 A, mounting on DIN rail NS 35 or NS 15, transverse to the DIN rail

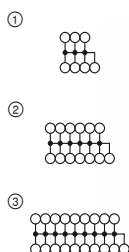

32 A, mounting on DIN rail NS 15, along the DIN rail

ERC

Technical data			
Width	Length	Height NS 35/7,5	
21.6	58.1	28.4	
Width	Length	Height NS 15	
21.6	58.1	26.4	
Width	Length	Height	
21.6	58.1	-	
I _{max} [A]	U _{max} [V]	max. Ø [mm ²]	AWG (UL)
32	500	0.14 - 2.5	-
IEC	UL / CUL	CSA	IEC/ EN 60079-7
500	-	-	-
17.5 / -	-	-	-

ERC

Technical data			
Width	Length	Height NS 35/7,5	
19	21.6	-	
Width	Length	Height NS 15	
19	21.6	27.4	
Width	Length	Height	
19	21.6	-	
I _{max} [A]	U _{max} [V]	max. Ø [mm ²]	AWG (UL)
32	500	0.14 - 2.5	-
IEC	UL / CUL	CSA	IEC/ EN 60079-7
500	-	-	-
17.5 / -	-	-	-

Ordering data		
Type	Order No.	Pcs./Pkt.
PTFIX 4/18X1,5-NS35 GY	① 1047454	20
PTFIX 4/18X1,5-NS35 BU	① 1047455	20
PTFIX 4/18X1,5-NS35 RD	① 1047456	20
PTFIX 4/18X1,5-NS35 YE	① 1047459	20
PTFIX 4/18X1,5-NS35 GN	① 1047458	20
PTFIX 4/18X1,5-NS35 BN	① 1047457	20
PTFIX 4/18X1,5-NS35 WH	① 1047461	20
PTFIX 4/18X1,5-NS35 BK	① 1047460	20
PTFIX 4/18X1,5-NS35 VT	① 1047462	20
PTFIX 4/18X1,5-NS35 PK	① 1047464	20
PTFIX 4/18X1,5-NS35 OG	① 1047463	20
PTFIX 4/18X1,5-NS35-FE	① 1047465	20

Ordering data		
Type	Order No.	Pcs./Pkt.
PTFIX 4/6X1,5-NS15A GY	① 1047490	20
PTFIX 4/12X1,5-NS15A GY	② 1046985	20
PTFIX 4/18X1,5-NS15A GY	③ 1047442	20
PTFIX 4/6X1,5-NS15A BU	① 1047491	20
PTFIX 4/12X1,5-NS15A BU	② 1046986	20
PTFIX 4/18X1,5-NS15A BU	③ 1047443	20
PTFIX 4/6X1,5-NS15A RD	① 1047492	20
PTFIX 4/12X1,5-NS15A RD	② 1046987	20
PTFIX 4/18X1,5-NS15A RD	③ 1047444	20
PTFIX 4/6X1,5-NS15A YE	① 1047495	20
PTFIX 4/12X1,5-NS15A YE	② 1046990	20
PTFIX 4/18X1,5-NS15A YE	③ 1047447	20
PTFIX 4/6X1,5-NS15A GN	① 1047494	20
PTFIX 4/12X1,5-NS15A GN	② 1046989	20
PTFIX 4/18X1,5-NS15A GN	③ 1047446	20
PTFIX 4/6X1,5-NS15A BN	① 1047493	20
PTFIX 4/12X1,5-NS15A BN	② 1046988	20
PTFIX 4/18X1,5-NS15A BN	③ 1047445	20
PTFIX 4/6X1,5-NS15A WH	① 1047497	20
PTFIX 4/12X1,5-NS15A WH	② 1046992	20
PTFIX 4/18X1,5-NS15A WH	③ 1047449	20
PTFIX 4/6X1,5-NS15A BK	① 1047496	20
PTFIX 4/12X1,5-NS15A BK	② 1046991	20
PTFIX 4/18X1,5-NS15A BK	③ 1047448	20
PTFIX 4/6X1,5-NS15A VT	① 1047498	20
PTFIX 4/12X1,5-NS15A VT	② 1046993	20
PTFIX 4/18X1,5-NS15A VT	③ 1047450	20
PTFIX 4/6X1,5-NS15A PK	① 1047500	20
PTFIX 4/12X1,5-NS15A PK	② 1046995	20
PTFIX 4/18X1,5-NS15A PK	③ 1047452	20
PTFIX 4/6X1,5-NS15A OG	① 1047499	20
PTFIX 4/12X1,5-NS15A OG	② 1046994	20
PTFIX 4/18X1,5-NS15A OG	③ 1047451	20
PTFIX 4/6X1,5-NS15A-FE	① 1047501	20
PTFIX 4/12X1,5-NS15A-FE	② 1046996	20
PTFIX 4/18X1,5-NS15A-FE	③ 1047453	20

Distribution blocks

2.5 mm² PTFIX distributor blocks

General technical data

Rated data		IEC 60947-7-1 / IEC 60998-2-2			
Rated cross section	[mm ²]	2.5			
Cross section range	AWG	26 - 12			
Connection capacity		Rigid	Flexible	Ferrule without/with plastic sleeve	
1 conductor	[mm ²]	0.14 - 4	0.14 - 2.5	0.14 - 2.5	0.14 - 2.5
2 flexible conductors with a TWIN ferrule	[mm ²]	-	-	-	-
Connection cross sections directly plug-in	[mm ²]	0.34 - 4	-	0.34 - 2.5	0.34 - 2.5
General data					
Stripping length	[mm]	8 - 10			
Insulating material		PA			
Flammability rating in accordance with UL 94		V0			
Note: Additional or deviating data is listed alongside the respective product.					

Notes:

The specified technical data and approvals refer to the first product in each column. For information on the products below, please refer to phoenixcontact.net/products

For full details of UL and CSA use groups, file nos., and Internet links, please visit phoenixcontact.net/products

¹⁾ The bridge current is listed alongside the respective product. For additional colors, see page 402.

System accessories

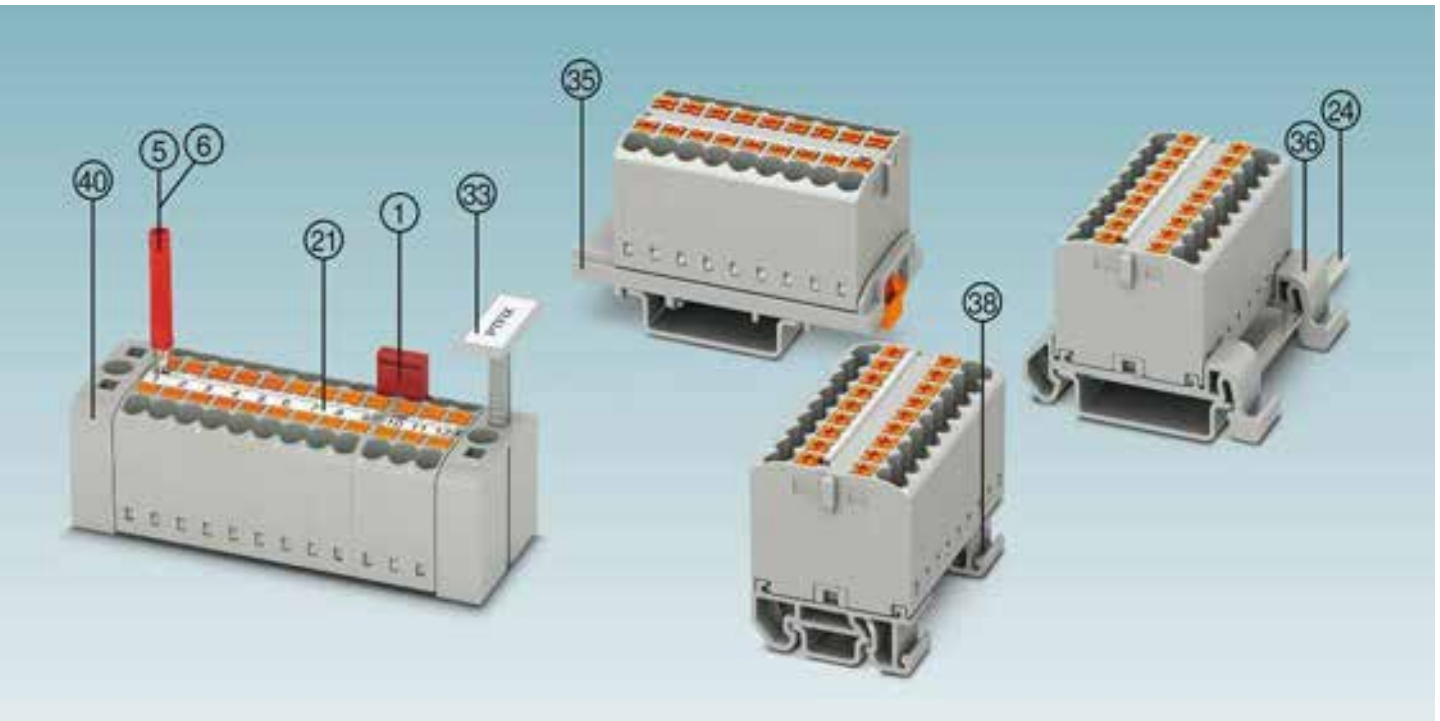

Description	No. of pos.	Color	Type	Order No.	Pcs./Pkt.	Type	Order No.	Pcs./Pkt.
① Bridge ¹⁾	2	red	FBS 2-5	3030161	50			
⑤ Test plug metal part		silver	MPS-MT SN	3212251	10			
⑥ Insulating sleeve, for MPS metal part		red	MPS-IH RD	0201676	10			
③ Terminal strip markers		gray	KLM 2	0807575	100			
④ Terminal strip markers		gray	KLM 3	0811969	100			
⑤ NS 35 or NS 15 DIN rail adapters, transverse		gray	PTFIX-NS35	3274054	20			
⑥ NS 35 DIN rail adapters, lateral		gray	PTFIX-NS35A	3274056	20			
NS 35 DIN rail adapters with end bracket function, lateral		gray	PTFIX-NS35A-FIX	3274057	20			
③ NS 15 DIN rail adapters, lateral		gray	PTFIX-NS15A	3274058	20			
NS 15 DIN rail adapters with end bracket function, lateral		gray	PTFIX-NS15A-FIX	3274059	20			
④ Mounting flange		gray	PTFIX-F	3274060	20			
Screwdriver			SZF 1-0,6X3,5	1204517	10			

② Center groove labeling

④ DIN rail and end bracket

For full accessories, visit phoenixcontact.net/products

TML (... X3.8)R, see also Catalog 3

See Catalog 3

Note: Additional or deviating accessories are listed alongside the respective product.

2.5 mm² PTFIX distributor blocks

PTFIX ... distribution blocks

The basic blocks can be mounted directly with mounting flanges.

Notes:
1) For additional accessories and technical data, see page 438.
With distribution blocks, the maximum permissible total current can vary with different numbers of terminal points.

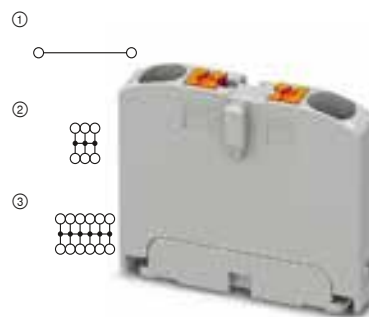

27 A, basic block, for self-assembly



Dimensions	[mm]
Width	5.2
Length	28.6
Height	21.7

Maximum electrical data	
I_{max} [A]	27
U_{max} [V]	450
IEC	450
Nominal current / cross section	24 [A] / [mm ²]

Technical data ¹⁾			
Width	Length	Height	
5.2	28.6	21.7	
I_{max} [A]	U_{max} [V]	max. Ø [mm ²]	AWG (UL)
27	450	0.14 - 4	26-12
IEC	UL / CUL	CSA	Ex
450	600	600	-
24	20 / -	20 / -	- / -

Description	Color
Basic block, 2 terminal points	gray
6 terminal points	gray
12 terminal points	gray
18 terminal points	gray
2 terminal points	blue
6 terminal points	blue
12 terminal points	blue
18 terminal points	blue
2 terminal points	red
6 terminal points	red
12 terminal points	red
18 terminal points	red
2 terminal points	yellow
6 terminal points	yellow
12 terminal points	yellow
18 terminal points	yellow
2 terminal points	green
6 terminal points	green
12 terminal points	green
18 terminal points	green
2 terminal points	brown
6 terminal points	brown
12 terminal points	brown
18 terminal points	brown
2 terminal points	white
6 terminal points	white
12 terminal points	white
18 terminal points	white
2 terminal points	black
6 terminal points	black
12 terminal points	black
18 terminal points	black
2 terminal points	violet
6 terminal points	violet
12 terminal points	violet
18 terminal points	violet
2 terminal points	pink
6 terminal points	pink
12 terminal points	pink
18 terminal points	pink
2 terminal points	orange
6 terminal points	orange
12 terminal points	orange
18 terminal points	orange
2 terminal points	black/yellow
6 terminal points	black/yellow
12 terminal points	black/yellow
18 terminal points	black/yellow
6 terminal points	blue/white

Ordering data			
Type	Order No.	Pcs./Pkt.	
PTFIX 2X2,5 GY	1028067	50	①
PTFIX 6X2,5 GY	3273264	10	②
PTFIX 12X2,5 GY	3273286	8	③
PTFIX 18X2,5 GY	3273308	8	
PTFIX 2X2,5 BU	1028068	50	①
PTFIX 6X2,5 BU	3273266	10	②
PTFIX 12X2,5 BU	3273288	8	③
PTFIX 18X2,5 BU	3273310	8	
PTFIX 2X2,5 RD	1028069	50	①
PTFIX 6X2,5 RD	3273268	10	②
PTFIX 12X2,5 RD	3273290	8	③
PTFIX 18X2,5 RD	3273312	8	
PTFIX 2X2,5 YE	1028070	50	①
PTFIX 6X2,5 YE	3273270	10	②
PTFIX 12X2,5 YE	3273292	8	③
PTFIX 18X2,5 YE	3273314	8	
PTFIX 2X2,5 GN	1028071	50	①
PTFIX 6X2,5 GN	3273272	10	②
PTFIX 12X2,5 GN	3273294	8	③
PTFIX 18X2,5 GN	3273316	8	
PTFIX 2X2,5 BN	1028072	50	①
PTFIX 6X2,5 BN	3273274	10	②
PTFIX 12X2,5 BN	3273296	8	③
PTFIX 18X2,5 BN	3273318	8	
PTFIX 2X2,5 WH	1028073	50	①
PTFIX 6X2,5 WH	3273276	10	②
PTFIX 12X2,5 WH	3273298	8	③
PTFIX 18X2,5 WH	3273320	8	
PTFIX 2X2,5 BK	1028074	50	①
PTFIX 6X2,5 BK	3273278	10	②
PTFIX 12X2,5 BK	3273300	8	③
PTFIX 18X2,5 BK	3273322	8	
PTFIX 2X2,5 VT	1028075	50	①
PTFIX 6X2,5 VT	3273280	10	②
PTFIX 12X2,5 VT	3273302	8	③
PTFIX 18X2,5 VT	3273324	8	
PTFIX 2X2,5 PK	1028076	50	①
PTFIX 6X2,5 PK	3273281	10	②
PTFIX 12X2,5 PK	3273303	8	③
PTFIX 18X2,5 PK	3273325	8	
PTFIX 2X2,5 OG	1028077	50	①
PTFIX 6X2,5 OG	3273282	10	②
PTFIX 12X2,5 OG	3273304	8	③
PTFIX 18X2,5 OG	3273326	8	
PTFIX 2X2,5-FE	1028078	50	①
PTFIX 6X2,5-FE	3273284	10	②
PTFIX 12X2,5-FE	3273306	8	③
PTFIX 18X2,5-FE	3273328	8	
PTFIX 6X2,5 BUWH	1091675	10	②

Distribution blocks

2.5 mm² PTFIX distributor blocks

PTFIX ... distribution blocks

Notes:
For additional accessories and technical data, see page 438.
With distribution blocks, the maximum permissible total current can vary with different numbers of terminal points.

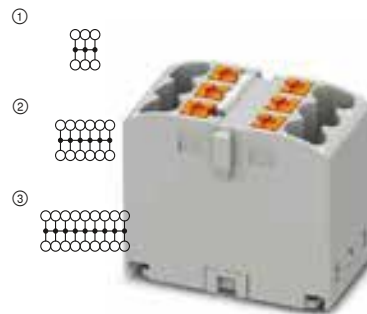

32 A, adhesive mounting



Dimensions	
	[mm]
Dimensions	
	[mm]
Dimensions	
	[mm]
Maximum electrical data	
Rated data	
Rated voltage	[V]
Nominal current / cross section	[A] / [mm ²]

Technical data			
Width	Length	Height NS 35/7,5	
16	28.6	-	
Width	Length	Height NS 15	
16	28.6	-	
Width	Length	Height	
16	28.6	22.7	
I _{max} [A]	U _{max} [V]	max. Ø [mm ²]	AWG (UL)
32	450	0.14 - 4	26-12
IEC	UL / CUL	CSA	IEC/EN 60079-7
450	600	600	-
24 / -	20	20 / -	-

Description	Color
Basic block, 6 terminal points	gray
12 terminal points	gray
18 terminal points	gray
6 terminal points	blue
12 terminal points	blue
18 terminal points	blue
6 terminal points	red
12 terminal points	red
18 terminal points	red
6 terminal points	yellow
12 terminal points	yellow
18 terminal points	yellow
6 terminal points	green
12 terminal points	green
18 terminal points	green
6 terminal points	brown
12 terminal points	brown
18 terminal points	brown
6 terminal points	white
12 terminal points	white
18 terminal points	white
6 terminal points	black
12 terminal points	black
18 terminal points	black
6 terminal points	violet
12 terminal points	violet
18 terminal points	violet
6 terminal points	pink
12 terminal points	pink
18 terminal points	pink
6 terminal points	orange
12 terminal points	orange
18 terminal points	orange
6 terminal points	black/yellow
12 terminal points	black/yellow
18 terminal points	black/yellow

Ordering data			
Type	Order No.	Pcs./Pkt.	
PTFIX 6X2,5-G GY	① 3273395	10	
PTFIX 12X2,5-G GY	② 3273416	8	
PTFIX 18X2,5-G GY	③ 3273438	8	
PTFIX 6X2,5-G BU	① 3273396	10	
PTFIX 12X2,5-G BU	② 3273418	8	
PTFIX 18X2,5-G BU	③ 3273440	8	
PTFIX 6X2,5-G RD	① 3273398	10	
PTFIX 12X2,5-G RD	② 3273420	8	
PTFIX 18X2,5-G RD	③ 3273442	8	
PTFIX 6X2,5-G YE	① 3273400	10	
PTFIX 12X2,5-G YE	② 3273422	8	
PTFIX 18X2,5-G YE	③ 3273444	8	
PTFIX 6X2,5-G GN	① 3273402	10	
PTFIX 12X2,5-G GN	② 3273424	8	
PTFIX 18X2,5-G GN	③ 3273446	8	
PTFIX 6X2,5-G BN	① 3273404	10	
PTFIX 12X2,5-G BN	② 3273426	8	
PTFIX 18X2,5-G BN	③ 3273448	8	
PTFIX 6X2,5-G WH	① 3273406	10	
PTFIX 12X2,5-G WH	② 3273428	8	
PTFIX 18X2,5-G WH	③ 3273450	8	
PTFIX 6X2,5-G BK	① 3273408	10	
PTFIX 12X2,5-G BK	② 3273430	8	
PTFIX 18X2,5-G BK	③ 3273452	8	
PTFIX 6X2,5-G VT	① 3273410	10	
PTFIX 12X2,5-G VT	② 3273432	8	
PTFIX 18X2,5-G VT	③ 3273454	8	
PTFIX 6X2,5-G PK	① 3273411	10	
PTFIX 12X2,5-G PK	② 3273433	8	
PTFIX 18X2,5-G PK	③ 3273455	8	
PTFIX 6X2,5-G OG	① 3273412	10	
PTFIX 12X2,5-G OG	② 3273434	8	
PTFIX 18X2,5-G OG	③ 3273456	8	
PTFIX 6X2,5-FE-G	① 3273414	10	
PTFIX 12X2,5-FE-G	② 3273436	8	
PTFIX 18X2,5-FE-G	③ 3273458	8	

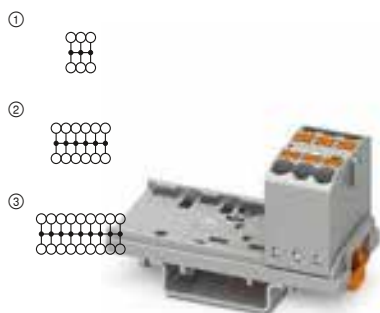

32 A, mounting on DIN rail NS 35 or NS 15, transverse to the DIN rail

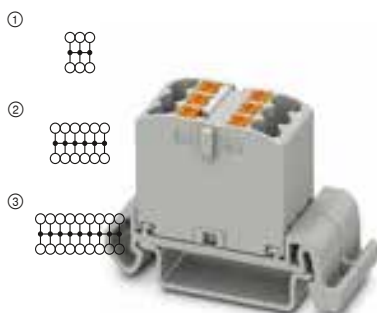

32 A, mounting on DIN rail NS 35, along the DIN rail

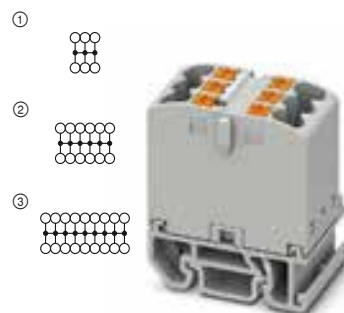

32 A, mounting on DIN rail NS 15, along the DIN rail



Technical data			
Width	Length	Height NS 35/7,5	
28.6	58.1	32.4	
Width	Length	Height NS 15	
28.6	58.1	30.4	
Width	Length	Height	
28.6	58.1	-	
I _{max} [A]	U _{max} [V]	max. Ø [mm ²]	AWG (UL)
32	690	0.14 - 4	26-12
IEC	UL / CUL	CSA	IEC/ EN 60079-7
690	600	600	-
24 / -	20	20 / -	-

Technical data			
Width	Length	Height NS 35/7,5	
16	45.7	30.9	
Width	Length	Height NS 15	
16	45.7	-	
Width	Length	Height	
16	45.7	-	
I _{max} [A]	U _{max} [V]	max. Ø [mm ²]	AWG (UL)
32	690	0.14 - 4	26-12
IEC	UL / CUL	CSA	IEC/ EN 60079-7
690	600	600	-
24 / -	20	20 / -	-

Technical data			
Width	Length	Height NS 35/7,5	
16	28.6	-	
Width	Length	Height NS 15	
16	28.6	31.4	
Width	Length	Height	
16	28.6	-	
I _{max} [A]	U _{max} [V]	max. Ø [mm ²]	AWG (UL)
32	690	0.14 - 4	-
IEC	UL / CUL	CSA	IEC/ EN 60079-7
690	-	600	-
24 / -	-	20 / -	-

Ordering data			
Type	Order No.	Pcs./Pkt.	
PTFIX 6X2,5-NS35 GY	① 3273000	10	
PTFIX 12X2,5-NS35 GY	② 3273022	8	
PTFIX 18X2,5-NS35 GY	③ 3273044	8	
PTFIX 6X2,5-NS35 BU	① 3273002	10	
PTFIX 12X2,5-NS35 BU	② 3273024	8	
PTFIX 18X2,5-NS35 BU	③ 3273046	8	
PTFIX 6X2,5-NS35 RD	① 3273004	10	
PTFIX 12X2,5-NS35 RD	② 3273026	8	
PTFIX 18X2,5-NS35 RD	③ 3273048	8	
PTFIX 6X2,5-NS35 YE	① 3273006	10	
PTFIX 12X2,5-NS35 YE	② 3273028	8	
PTFIX 18X2,5-NS35 YE	③ 3273050	8	
PTFIX 6X2,5-NS35 GN	① 3273008	10	
PTFIX 12X2,5-NS35 GN	② 3273030	8	
PTFIX 18X2,5-NS35 GN	③ 3273052	8	
PTFIX 6X2,5-NS35 BN	① 3273010	10	
PTFIX 12X2,5-NS35 BN	② 3273032	8	
PTFIX 18X2,5-NS35 BN	③ 3273054	8	
PTFIX 6X2,5-NS35 WH	① 3273012	10	
PTFIX 12X2,5-NS35 WH	② 3273034	8	
PTFIX 18X2,5-NS35 WH	③ 3273056	8	
PTFIX 6X2,5-NS35 BK	① 3273014	10	
PTFIX 12X2,5-NS35 BK	② 3273036	8	
PTFIX 18X2,5-NS35 BK	③ 3273058	8	
PTFIX 6X2,5-NS35 VT	① 3273016	10	
PTFIX 12X2,5-NS35 VT	② 3273038	8	
PTFIX 18X2,5-NS35 VT	③ 3273060	8	
PTFIX 6X2,5-NS35 PK	① 3273017	10	
PTFIX 12X2,5-NS35 PK	② 3273039	8	
PTFIX 18X2,5-NS35 PK	③ 3273061	8	
PTFIX 6X2,5-NS35 OG	① 3273018	10	
PTFIX 12X2,5-NS35 OG	② 3273040	8	
PTFIX 18X2,5-NS35 OG	③ 3273062	8	
PTFIX 6X2,5-NS35-FE	① 3273020	10	
PTFIX 12X2,5-NS35-FE	② 3273042	8	
PTFIX 18X2,5-NS35-FE	③ 3273064	8	

Ordering data			
Type	Order No.	Pcs./Pkt.	
PTFIX 6X2,5-NS35A GY	① 3273132	10	
PTFIX 12X2,5-NS35A GY	② 3273154	8	
PTFIX 18X2,5-NS35A GY	③ 3273176	8	
PTFIX 6X2,5-NS35A BU	① 3273134	10	
PTFIX 12X2,5-NS35A BU	② 3273156	8	
PTFIX 18X2,5-NS35A BU	③ 3273178	8	
PTFIX 6X2,5-NS35A RD	① 3273136	10	
PTFIX 12X2,5-NS35A RD	② 3273158	8	
PTFIX 18X2,5-NS35A RD	③ 3273180	8	
PTFIX 6X2,5-NS35A YE	① 3273138	10	
PTFIX 12X2,5-NS35A YE	② 3273160	8	
PTFIX 18X2,5-NS35A YE	③ 3273182	8	
PTFIX 6X2,5-NS35A GN	① 3273140	10	
PTFIX 12X2,5-NS35A GN	② 3273162	8	
PTFIX 18X2,5-NS35A GN	③ 3273184	8	
PTFIX 6X2,5-NS35A BN	① 3273142	10	
PTFIX 12X2,5-NS35A BN	② 3273164	8	
PTFIX 18X2,5-NS35A BN	③ 3273186	8	
PTFIX 6X2,5-NS35A WH	① 3273144	10	
PTFIX 12X2,5-NS35A WH	② 3273166	8	
PTFIX 18X2,5-NS35A WH	③ 3273188	8	
PTFIX 6X2,5-NS35A BK	① 3273146	10	
PTFIX 12X2,5-NS35A BK	② 3273168	8	
PTFIX 18X2,5-NS35A BK	③ 3273190	8	
PTFIX 6X2,5-NS35A VT	① 3273148	10	
PTFIX 12X2,5-NS35A VT	② 3273170	8	
PTFIX 18X2,5-NS35A VT	③ 3273192	8	
PTFIX 6X2,5-NS35A PK	① 3273149	10	
PTFIX 12X2,5-NS35A PK	② 3273171	8	
PTFIX 18X2,5-NS35A PK	③ 3273193	8	
PTFIX 6X2,5-NS35A OG	① 3273150	10	
PTFIX 12X2,5-NS35A OG	② 3273172	8	
PTFIX 18X2,5-NS35A OG	③ 3273194	8	
PTFIX 6X2,5-NS35A-FE	① 3273152	10	
PTFIX 12X2,5-NS35A-FE	② 3273174	8	
PTFIX 18X2,5-NS35A-FE	③ 3273196	8	

Ordering data			
Type	Order No.	Pcs./Pkt.	
PTFIX 6X2,5-NS15A GY	① 3274100	10	
PTFIX 12X2,5-NS15A GY	② 3274122	8	
PTFIX 18X2,5-NS15A GY	③ 3274144	8	
PTFIX 6X2,5-NS15A BU	① 3274102	10	
PTFIX 12X2,5-NS15A BU	② 3274124	8	
PTFIX 18X2,5-NS15A BU	③ 3274146	8	
PTFIX 6X2,5-NS15A RD	① 3274104	10	
PTFIX 12X2,5-NS15A RD	② 3274126	8	
PTFIX 18X2,5-NS15A RD	③ 3274148	8	
PTFIX 6X2,5-NS15A YE	① 3274106	10	
PTFIX 12X2,5-NS15A YE	② 3274128	8	
PTFIX 18X2,5-NS15A YE	③ 3274150	8	
PTFIX 6X2,5-NS15A GN	① 3274108	10	
PTFIX 12X2,5-NS15A GN	② 3274130	8	
PTFIX 18X2,5-NS15A GN	③ 3274152	8	
PTFIX 6X2,5-NS15A BN	① 3274110	10	
PTFIX 12X2,5-NS15A BN	② 3274132	8	
PTFIX 18X2,5-NS15A BN	③ 3274154	8	
PTFIX 6X2,5-NS15A WH	① 3274112	10	
PTFIX 12X2,5-NS15A WH	② 3274134	8	
PTFIX 18X2,5-NS15A WH	③ 3274156	8	
PTFIX 6X2,5-NS15A BK	① 3274114	10	
PTFIX 12X2,5-NS15A BK	② 3274136	8	
PTFIX 18X2,5-NS15A BK	③ 3274158	8	
PTFIX 6X2,5-NS15A VT	① 3274116	10	
PTFIX 12X2,5-NS15A VT	② 3274138	8	
PTFIX 18X2,5-NS15A VT	③ 3274160	8	
PTFIX 6X2,5-NS15A PK	① 3274117	10	
PTFIX 12X2,5-NS15A PK	② 3274139	8	
PTFIX 18X2,5-NS15A PK	③ 3274161	8	
PTFIX 6X2,5-NS15A OG	① 3274118	10	
PTFIX 12X2,5-NS15A OG	② 3274140	8	
PTFIX 18X2,5-NS15A OG	③ 3274162	8	
PTFIX 6X2,5-NS15A-FE	① 3274120	10	
PTFIX 12X2,5-NS15A-FE	② 3274142	8	
PTFIX 18X2,5-NS15A-FE	③ 3274164	8	

Distribution blocks

2.5 mm² distributor blocks with PTFIX feed-in

General technical data

Rated data		IEC 60947-7-1 / IEC 60998-2-2
Rated cross section	[mm ²]	2.5
Cross section range	AWG	26 - 12
Connection capacity		Rigid Flexible Ferrule without/with plastic sleeve
1 conductor	[mm ²]	0.14 - 4 0.14 - 2.5 0.14 - 2.5 0.14 - 2.5
2 flexible conductors with a TWIN ferrule	[mm ²]	- - - -
Connection cross sections directly plug-in	[mm ²]	0.34 - 4 - 0.34 - 2.5 0.34 - 2.5
Rated data, feed		IEC 60947-7-1 / IEC 60998-2-2
Nominal current / cross section range	[A] / [AWG]	41 with 6 mm ² conductor cross section , 57 with 10 mm ² conductor cross section / 20 - 8
Supply connection capacity		Rigid Flexible Ferrule without/with plastic sleeve
1 conductor	[mm ²]	0.5 - 10 0.5 - 6 0.5 - 10 0.5 - 10
2 flexible conductors with a TWIN ferrule	[mm ²]	- - - 0.5 - 2.5
Connection cross sections directly plug-in	[mm ²]	0.5 - 6 - 1 - 6 1 - 6
General data		
Stripping length	[mm]	8 - 10
Insulating material		PA
Flammability rating in accordance with UL 94		V0

Note: Additional or deviating data is listed alongside the respective product.

Notes:

The specified technical data and approvals refer to the first product in each column. For information on the products below, please refer to phoenixcontact.net/products

For full details of UL and CSA use groups, file nos., and Internet links, please visit phoenixcontact.net/products

) The bridge current is listed alongside the respective product. For additional colors, see page 402.

System accessories



Description	No. of pos.	Color	Type	Order No.	Pcs./Pkt.	Type	Order No.	Pcs./Pkt.
① Bridge ¹⁾	2	red	FBS 2-5	3030161	50			
⑤ Test plug metal part		silver	MPS-MT SN	3212251	10			
⑥ Insulating sleeve, for MPS metal part		red	MPS-IH RD	0201676	10			
③ Terminal strip markers		gray	KLM 2	0807575	100			
② Terminal strip markers		gray	KLM 3	0811969	100			
③ NS 35 or NS 15 DIN rail adapters, transverse		gray	PTFIX-NS35	3274054	20			
③ NS 35 DIN rail adapters, lateral		gray	PTFIX-NS35A	3274056	20			
NS 35 DIN rail adapters with end bracket function, lateral		gray	PTFIX-NS35A-FIX	3274057	20			
③ NS 15 DIN rail adapters, lateral		gray	PTFIX-NS15A	3274058	20			
NS 15 DIN rail adapters with end bracket function, lateral		gray	PTFIX-NS15A-FIX	3274059	20			
④ Mounting flange		gray	PTFIX-F	3274060	20			
Screwdriver			SZF 1-0,6X3,5	1204517	10			
② Center groove labeling			TML (... X3.8)R, see also Catalog 3					
② DIN rail and end bracket			See Catalog 3					
For full accessories, visit phoenixcontact.net/products			Note: Additional or deviating accessories are listed alongside the respective product.					

PTFIX ... distribution blocks

The basic blocks can be individually self-assembled with different adapters or flanges in accordance with the desired mounting type.

Notes:
1) For additional accessories and technical data, see page 442.
Observe DIN IEC 60364-4-43 (DIN VDE 0100-430:2010-10) section 433.2 ff.
With distribution blocks, the maximum permissible total current can vary with different numbers of terminal points.

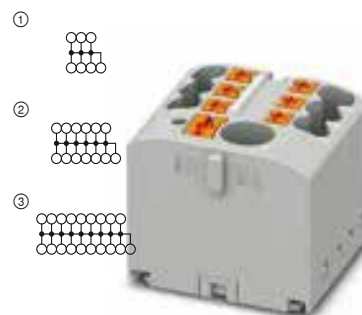

57 A, basic block, with feed-in, for self-assembly



Dimensions	
	[mm]
Maximum electrical data	
Rated data	
Rated voltage	[V]
Nominal current / cross section	[A] / [mm ²]

Technical data ¹⁾			
Width	Length	Height	
25.6	28.6	21.7	
I _{max.} [A]	U _{max.} [V]	max. Ø [mm ²]	AWG (UL)
57	450	0.14 - 4	20-8
IEC	UL / CUL	CSA	Ex
450	600	600	-
24	50 / -	50 / -	- / -

Description	Color
Basic block, with supply, 7 terminal points	gray
13 terminal points	gray
19 terminal points	gray
7 terminal points	blue
13 terminal points	blue
19 terminal points	blue
7 terminal points	red
13 terminal points	red
19 terminal points	red
7 terminal points	yellow
13 terminal points	yellow
19 terminal points	yellow
7 terminal points	green
13 terminal points	green
19 terminal points	green
7 terminal points	brown
13 terminal points	brown
19 terminal points	brown
7 terminal points	white
13 terminal points	white
19 terminal points	white
7 terminal points	black
13 terminal points	black
19 terminal points	black
7 terminal points	violet
13 terminal points	violet
19 terminal points	violet
7 terminal points	pink
13 terminal points	pink
19 terminal points	pink
7 terminal points	orange
13 terminal points	orange
19 terminal points	orange
7 terminal points	black/yellow
13 terminal points	black/yellow
19 terminal points	black/yellow
7 terminal points	blue/white
13 terminal points	blue/white
19 terminal points	blue/white

Ordering data		
Type	Order No.	Pcs./Pkt.
PTFIX 6/6X2,5 GY	3273330	10
PTFIX 6/12X2,5 GY	3273352	8
PTFIX 6/18X2,5 GY	3273374	8
PTFIX 6/6X2,5 BU	3273332	10
PTFIX 6/12X2,5 BU	3273354	8
PTFIX 6/18X2,5 BU	3273376	8
PTFIX 6/6X2,5 RD	3273334	10
PTFIX 6/12X2,5 RD	3273356	8
PTFIX 6/18X2,5 RD	3273378	8
PTFIX 6/6X2,5 YE	3273336	10
PTFIX 6/12X2,5 YE	3273358	8
PTFIX 6/18X2,5 YE	3273380	8
PTFIX 6/6X2,5 GN	3273338	10
PTFIX 6/12X2,5 GN	3273360	8
PTFIX 6/18X2,5 GN	3273382	8
PTFIX 6/6X2,5 BN	3273340	10
PTFIX 6/12X2,5 BN	3273362	8
PTFIX 6/18X2,5 BN	3273384	8
PTFIX 6/6X2,5 WH	3273342	10
PTFIX 6/12X2,5 WH	3273364	8
PTFIX 6/18X2,5 WH	3273386	8
PTFIX 6/6X2,5 BK	3273344	10
PTFIX 6/12X2,5 BK	3273366	8
PTFIX 6/18X2,5 BK	3273388	8
PTFIX 6/6X2,5 VT	3273346	10
PTFIX 6/12X2,5 VT	3273368	8
PTFIX 6/18X2,5 VT	3273390	8
PTFIX 6/6X2,5 PK	3273347	10
PTFIX 6/12X2,5 PK	3273369	8
PTFIX 6/18X2,5 PK	3273391	8
PTFIX 6/6X2,5 OG	3273348	10
PTFIX 6/12X2,5 OG	3273370	8
PTFIX 6/18X2,5 OG	3273392	8
PTFIX 6/6X2,5-FE	3273350	10
PTFIX 6/12X2,5-FE	3273372	8
PTFIX 6/18X2,5-FE	3273394	8
PTFIX 6/6X2,5 BUWH	1091674	10
PTFIX 6/12X2,5 BUWH	1091672	8
PTFIX 6/18X2,5 BUWH	1091673	8

Distribution blocks

2.5 mm² distributor blocks with PTFIX feed-in

Distribution blocks

Notes:
For additional accessories and technical data, see page 442.
Observe DIN IEC 60364-4-43 (DIN VDE 0100-430:2010-10) section 433.2 ff.
With distribution blocks, the maximum permissible total current can vary with different numbers of terminal points.

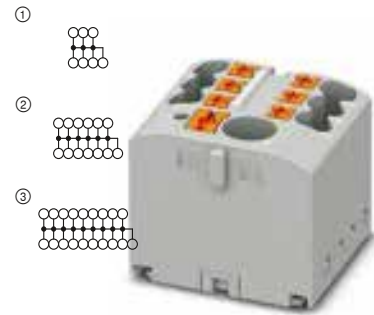

57 A, adhesive mounting



Dimensions	
	[mm]
Dimensions	
	[mm]
Dimensions	
	[mm]
Maximum electrical data	
Rated data	
Rated voltage	[V]
Nominal current / cross section	[A] / [mm ²]

Technical data			
Width	Length	Height NS 35/7,5	
25.6	28.6	-	
Width	Length	Height NS 15	
25.6	28.6	-	
Width	Length	Height	
25.6	28.6	22.7	
I _{max} [A]	U _{max} [V]	max. Ø [mm ²]	AWG (UL)
57	450	0.14 - 4	20-8
IEC	UL / CUL	CSA	IEC/EN 60079-7
450	600	600	-
24 / -	50	50 / -	-

Description	Color
Basic block, with supply, 7 terminal points	gray
13 terminal points	gray
19 terminal points	gray
7 terminal points	blue
13 terminal points	blue
19 terminal points	blue
7 terminal points	red
13 terminal points	red
19 terminal points	red
7 terminal points	yellow
13 terminal points	yellow
19 terminal points	yellow
7 terminal points	green
13 terminal points	green
19 terminal points	green
7 terminal points	brown
13 terminal points	brown
19 terminal points	brown
7 terminal points	white
13 terminal points	white
19 terminal points	white
7 terminal points	black
13 terminal points	black
19 terminal points	black
7 terminal points	violet
13 terminal points	violet
19 terminal points	violet
7 terminal points	pink
13 terminal points	pink
19 terminal points	pink
7 terminal points	orange
13 terminal points	orange
19 terminal points	orange
7 terminal points	black/yellow
13 terminal points	black/yellow
19 terminal points	black/yellow

Ordering data			
Type	Order No.	Pcs./Pkt.	
PTFIX 6/6X2,5-G GY	① 3273460	10	
PTFIX 6/12X2,5-G GY	② 3273482	8	
PTFIX 6/18X2,5-G GY	③ 3273504	8	
PTFIX 6/6X2,5-G BU	① 3273462	10	
PTFIX 6/12X2,5-G BU	② 3273484	8	
PTFIX 6/18X2,5-G BU	③ 3273506	8	
PTFIX 6/6X2,5-G RD	① 3273464	10	
PTFIX 6/12X2,5-G RD	② 3273486	8	
PTFIX 6/18X2,5-G RD	③ 3273508	8	
PTFIX 6/6X2,5-G YE	① 3273466	10	
PTFIX 6/12X2,5-G YE	② 3273488	8	
PTFIX 6/18X2,5-G YE	③ 3273510	8	
PTFIX 6/6X2,5-G GN	① 3273468	10	
PTFIX 6/12X2,5-G GN	② 3273490	8	
PTFIX 6/18X2,5-G GN	③ 3273512	8	
PTFIX 6/6X2,5-G BN	① 3273470	10	
PTFIX 6/12X2,5-G BN	② 3273492	8	
PTFIX 6/18X2,5-G BN	③ 3273514	8	
PTFIX 6/6X2,5-G WH	① 3273472	10	
PTFIX 6/12X2,5-G WH	② 3273494	8	
PTFIX 6/18X2,5-G WH	③ 3273516	8	
PTFIX 6/6X2,5-G BK	① 3273474	10	
PTFIX 6/12X2,5-G BK	② 3273496	8	
PTFIX 6/18X2,5-G BK	③ 3273518	8	
PTFIX 6/6X2,5-G VT	① 3273476	10	
PTFIX 6/12X2,5-G VT	② 3273498	8	
PTFIX 6/18X2,5-G VT	③ 3273520	8	
PTFIX 6/6X2,5-G PK	① 3273477	10	
PTFIX 6/12X2,5-G PK	② 3273499	8	
PTFIX 6/18X2,5-G PK	③ 3273521	8	
PTFIX 6/6X2,5-G OG	① 3273478	10	
PTFIX 6/12X2,5-G OG	② 3273500	8	
PTFIX 6/18X2,5-G OG	③ 3273522	8	
PTFIX 6/6X2,5-FE-G	① 3273480	10	
PTFIX 6/12X2,5-FE-G	② 3273502	8	
PTFIX 6/18X2,5-FE-G	③ 3273524	8	

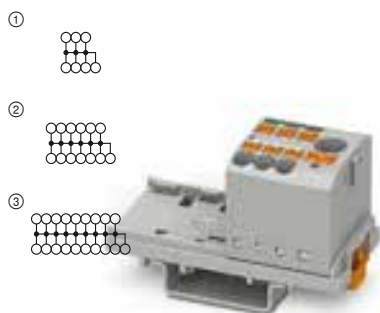

57 A, mounting on DIN rail NS 35 or NS 15, transverse to the DIN rail

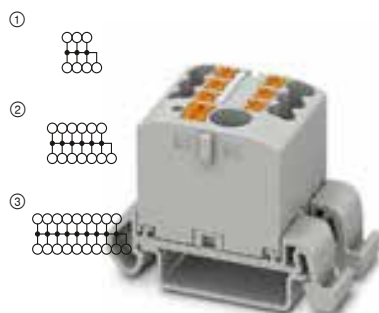

57 A, mounting on DIN rail NS 35, along the DIN rail

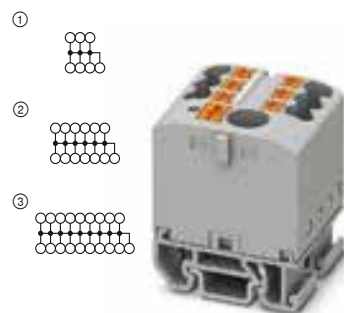

57 A, mounting on NS 15 DIN rail, along the DIN rail



Technical data			
Width	Length	Height NS 35/7,5	
28.6	58.1	32.4	
Width	Length	Height NS 15	
28.6	58.1	30.4	
Width	Length	Height	
28.6	58.1	-	
I_{max} [A]	U_{max} [V]	max. Ø [mm ²]	AWG (UL)
24	500	0.14 - 4	20-8
IEC	UL / CUL	CSA	IEC/ EN 60079-7
500	600	600	-
24 / -	50	50 / -	-

Technical data			
Width	Length	Height NS 35/7,5	
25.6	45.7	30.9	
Width	Length	Height NS 15	
25.6	45.7	-	
Width	Length	Height	
25.6	45.7	-	
I_{max} [A]	U_{max} [V]	max. Ø [mm ²]	AWG (UL)
57	690	0.14 - 4	20-8
IEC	UL / CUL	CSA	IEC/ EN 60079-7
690	600	600	-
24 / -	50	50 / -	-

Technical data			
Width	Length	Height NS 35/7,5	
25.6	28.6	-	
Width	Length	Height NS 15	
25.6	28.6	31.4	
Width	Length	Height	
25.6	28.6	-	
I_{max} [A]	U_{max} [V]	max. Ø [mm ²]	AWG (UL)
57	690	0.14 - 4	-
IEC	UL / CUL	CSA	IEC/ EN 60079-7
690	-	600	-
24 / -	-	50 / -	-

Ordering data		
Type	Order No.	Pcs./Pkt.
PTFIX 6/6X2,5-NS35 GY	3273066	10
PTFIX 6/12X2,5-NS35 GY	3273088	8
PTFIX 6/18X2,5-NS35 GY	3273110	8
PTFIX 6/6X2,5-NS35 BU	3273068	10
PTFIX 6/12X2,5-NS35 BU	3273090	8
PTFIX 6/18X2,5-NS35 BU	3273112	8
PTFIX 6/6X2,5-NS35 RD	3273070	10
PTFIX 6/12X2,5-NS35 RD	3273092	8
PTFIX 6/18X2,5-NS35 RD	3273114	8
PTFIX 6/6X2,5-NS35 YE	3273072	10
PTFIX 6/12X2,5-NS35 YE	3273094	8
PTFIX 6/18X2,5-NS35 YE	3273116	8
PTFIX 6/6X2,5-NS35 GN	3273074	10
PTFIX 6/12X2,5-NS35 GN	3273096	8
PTFIX 6/18X2,5-NS35 GN	3273118	8
PTFIX 6/6X2,5-NS35 BN	3273076	10
PTFIX 6/12X2,5-NS35 BN	3273098	8
PTFIX 6/18X2,5-NS35 BN	3273120	8
PTFIX 6/6X2,5-NS35 WH	3273078	10
PTFIX 6/12X2,5-NS35 WH	3273100	8
PTFIX 6/18X2,5-NS35 WH	3273122	8
PTFIX 6/6X2,5-NS35 BK	3273080	10
PTFIX 6/12X2,5-NS35 BK	3273102	8
PTFIX 6/18X2,5-NS35 BK	3273124	8
PTFIX 6/6X2,5-NS35 VT	3273082	10
PTFIX 6/12X2,5-NS35 VT	3273104	8
PTFIX 6/18X2,5-NS35 VT	3273126	8
PTFIX 6/6X2,5-NS35 PK	3273083	10
PTFIX 6/12X2,5-NS35 PK	3273105	8
PTFIX 6/18X2,5-NS35 PK	3273127	8
PTFIX 6/6X2,5-NS35 OG	3273084	10
PTFIX 6/12X2,5-NS35 OG	3273106	8
PTFIX 6/18X2,5-NS35 OG	3273128	8
PTFIX 6/6X2,5-NS35-FE	3273086	10
PTFIX 6/12X2,5-NS35-FE	3273108	8
PTFIX 6/18X2,5-NS35-FE	3273130	8

Ordering data		
Type	Order No.	Pcs./Pkt.
PTFIX 6/6X2,5-NS35A GY	3273198	10
PTFIX 6/12X2,5-NS35A GY	3273220	8
PTFIX 6/18X2,5-NS35A GY	3273242	8
PTFIX 6/6X2,5-NS35A BU	3273200	10
PTFIX 6/12X2,5-NS35A BU	3273222	8
PTFIX 6/18X2,5-NS35A BU	3273244	8
PTFIX 6/6X2,5-NS35A RD	3273202	10
PTFIX 6/12X2,5-NS35A RD	3273224	8
PTFIX 6/18X2,5-NS35A RD	3273246	8
PTFIX 6/6X2,5-NS35A YE	3273204	10
PTFIX 6/12X2,5-NS35A YE	3273226	8
PTFIX 6/18X2,5-NS35A YE	3273248	8
PTFIX 6/6X2,5-NS35A GN	3273206	10
PTFIX 6/12X2,5-NS35A GN	3273228	8
PTFIX 6/18X2,5-NS35A GN	3273250	8
PTFIX 6/6X2,5-NS35A BN	3273208	10
PTFIX 6/12X2,5-NS35A BN	3273230	8
PTFIX 6/18X2,5-NS35A BN	3273252	8
PTFIX 6/6X2,5-NS35A WH	3273210	10
PTFIX 6/12X2,5-NS35A WH	3273232	8
PTFIX 6/18X2,5-NS35A WH	3273254	8
PTFIX 6/6X2,5-NS35A BK	3273212	10
PTFIX 6/12X2,5-NS35A BK	3273234	8
PTFIX 6/18X2,5-NS35A BK	3273256	8
PTFIX 6/6X2,5-NS35A VT	3273214	10
PTFIX 6/12X2,5-NS35A VT	3273236	8
PTFIX 6/18X2,5-NS35A VT	3273258	8
PTFIX 6/6X2,5-NS35A PK	3273215	10
PTFIX 6/12X2,5-NS35A PK	3273237	8
PTFIX 6/18X2,5-NS35A PK	3273259	8
PTFIX 6/6X2,5-NS35A OG	3273216	10
PTFIX 6/12X2,5-NS35A OG	3273238	8
PTFIX 6/18X2,5-NS35A OG	3273260	8
PTFIX 6/6X2,5-NS35A-FE	3273218	10
PTFIX 6/12X2,5-NS35A-FE	3273240	8
PTFIX 6/18X2,5-NS35A-FE	3273262	8

Ordering data		
Type	Order No.	Pcs./Pkt.
PTFIX 6/6X2,5-NS15A GY	3274166	10
PTFIX 6/12X2,5-NS15A GY	3274188	8
PTFIX 6/18X2,5-NS15A GY	3274210	8
PTFIX 6/6X2,5-NS15A BU	3274168	10
PTFIX 6/12X2,5-NS15A BU	3274190	8
PTFIX 6/18X2,5-NS15A BU	3274212	8
PTFIX 6/6X2,5-NS15A RD	3274170	10
PTFIX 6/12X2,5-NS15A RD	3274192	8
PTFIX 6/18X2,5-NS15A RD	3274214	8
PTFIX 6/6X2,5-NS15A YE	3274172	10
PTFIX 6/12X2,5-NS15A YE	3274194	8
PTFIX 6/18X2,5-NS15A YE	3274216	8
PTFIX 6/6X2,5-NS15A GN	3274174	10
PTFIX 6/12X2,5-NS15A GN	3274196	8
PTFIX 6/18X2,5-NS15A GN	3274218	8
PTFIX 6/6X2,5-NS15A BN	3274176	10
PTFIX 6/12X2,5-NS15A BN	3274198	8
PTFIX 6/18X2,5-NS15A BN	3274220	8
PTFIX 6/6X2,5-NS15A WH	3274178	10
PTFIX 6/12X2,5-NS15A WH	3274200	8
PTFIX 6/18X2,5-NS15A WH	3274222	8
PTFIX 6/6X2,5-NS15A BK	3274180	10
PTFIX 6/12X2,5-NS15A BK	3274202	8
PTFIX 6/18X2,5-NS15A BK	3274224	8
PTFIX 6/6X2,5-NS15A VT	3274182	10
PTFIX 6/12X2,5-NS15A VT	3274204	8
PTFIX 6/18X2,5-NS15A VT	3274226	8
PTFIX 6/6X2,5-NS15A PK	3274183	10
PTFIX 6/12X2,5-NS15A PK	3274205	8
PTFIX 6/18X2,5-NS15A PK	3274227	8
PTFIX 6/6X2,5-NS15A OG	3274184	10
PTFIX 6/12X2,5-NS15A OG	3274206	8
PTFIX 6/18X2,5-NS15A OG	3274228	8
PTFIX 6/6X2,5-NS15A-FE	3274186	10
PTFIX 6/12X2,5-NS15A-FE	3274208	8
PTFIX 6/18X2,5-NS15A-FE	3274230	8

Distribution blocks

4 mm² PTFIX distribution blocks

General technical data

Rated data		IEC 60947-7-1 / IEC 60998-2-2			
Rated cross section	[mm ²]	4			
Cross section range	AWG	24 - 10			
Connection capacity		Rigid	Flexible	Ferrule without/with plastic sleeve	
1 conductor	[mm ²]	0.2 - 6	0.2 - 4	0.2 - 4	0.2 - 4
2 flexible conductors with a TWIN ferrule	[mm ²]	-	-	-	-
Connection cross sections directly plug-in	[mm ²]	0.5 - 6	-	0.75 - 4	0.5 - 4
General data					
Stripping length	[mm]	10 - 12			
Insulating material		PA			
Flammability rating in accordance with UL 94		V0			

Note: Additional or deviating data is listed alongside the respective product.

Notes:

The specified technical data and approvals refer to the first product in each column. For information on the products below, please refer to phoenixcontact.net/products

For full details of UL and CSA use groups, file nos., and Internet links, please visit phoenixcontact.net/products

¹⁾ The bridge current is listed alongside the respective product. For additional colors, see page 402.

System accessories



Description	No. of pos.	Color	Type	Order No.	Pcs./Pkt.	Type	Order No.	Pcs./Pkt.
① Bridge ¹⁾	2	red	FBS 2-6	3030336	50			
⑤ Test plug metal part		silver	MPS-MT SN	3212251	10			
⑥ Insulating sleeve, for MPS metal part		red	MPS-IH RD	0201676	10			
③ Terminal strip markers		gray	KLM 2	0807575	100			
④ Terminal strip markers		gray	KLM 3	0811969	100			
⑤ NS 35 or NS 15 DIN rail adapters, transverse		gray	PTFIX-NS35	3274054	20			
⑥ NS 35 DIN rail adapters, lateral		gray	PTFIX-NS35A	3274056	20			
NS 35 DIN rail adapters with end bracket function, lateral		gray	PTFIX-NS35A-FIX	3274057	20			
③ NS 15 DIN rail adapters, lateral		gray	PTFIX-NS15A	3274058	20			
NS 15 DIN rail adapters with end bracket function, lateral		gray	PTFIX-NS15A-FIX	3274059	20			
④ Mounting flange		gray	PTFIX-F	3274060	20			
Screwdriver			SZF 1-0,6X3,5	1204517	10			

② Center groove labeling

④ DIN rail and end bracket

For full accessories, visit phoenixcontact.net/products

TML (... X3.8)R, see also Catalog 3

See Catalog 3

Note: Additional or deviating accessories are listed alongside the respective product.

new

PTFIX ... distribution blocks

The basic blocks can be mounted directly with mounting flanges.

Notes:
1) For additional accessories and technical data, see page 446.
With distribution blocks, the maximum permissible total current can vary with different numbers of terminal points.

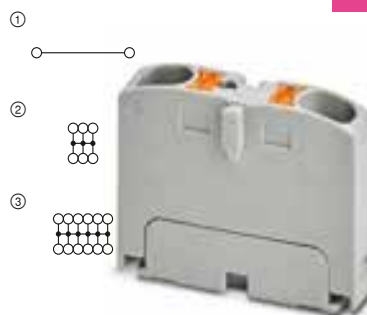

41 A, basic block, for self-assembly

ERIC

Dimensions	[mm]
Maximum electrical data	
Rated data	[V]
Rated voltage	450
Nominal current / cross section	[A] / [mm ²]
	32

Technical data ¹⁾				
Width	Length	Height		
6.2	28.6	21.7		
I_{max} [A]	U_{max} [V]	max. \varnothing [mm ²]	AWG (UL)	
41	450	0.2 - 6	-	
IEC	UL / CUL	CSA	Ex	
450	-	-	-	
32	- / -	- / -	- / -	

Description	Color
Basic block, 2 terminal points	gray
6 terminal points	gray
12 terminal points	gray
18 terminal points	gray
2 terminal points	blue
6 terminal points	blue
12 terminal points	blue
18 terminal points	blue
2 terminal points	red
6 terminal points	red
12 terminal points	red
18 terminal points	red
2 terminal points	yellow
6 terminal points	yellow
12 terminal points	yellow
18 terminal points	yellow
2 terminal points	green
6 terminal points	green
12 terminal points	green
18 terminal points	green
2 terminal points	brown
6 terminal points	brown
12 terminal points	brown
18 terminal points	brown
2 terminal points	white
6 terminal points	white
12 terminal points	white
18 terminal points	white
2 terminal points	black
6 terminal points	black
12 terminal points	black
18 terminal points	black
2 terminal points	violet
6 terminal points	violet
12 terminal points	violet
18 terminal points	violet
2 terminal points	pink
6 terminal points	pink
12 terminal points	pink
18 terminal points	pink
2 terminal points	orange
6 terminal points	orange
12 terminal points	orange
18 terminal points	orange
2 terminal points	black/yellow
6 terminal points	black/yellow
12 terminal points	black/yellow
18 terminal points	black/yellow

Ordering data			
Type	Order No.	Pcs./Pkt.	
PTFIX 2X4 GY	① 1028360	50	
PTFIX 6X4 GY	② 3273790	10	
PTFIX 12X4 GY	③ 3273812	8	
PTFIX 18X4 GY	3273834	8	
PTFIX 2X4 BU	① 1028361	50	
PTFIX 6X4 BU	② 3273792	10	
PTFIX 12X4 BU	③ 3273814	8	
PTFIX 18X4 BU	3273836	8	
PTFIX 2X4 RD	① 1028362	50	
PTFIX 6X4 RD	② 3273794	10	
PTFIX 12X4 RD	③ 3273816	8	
PTFIX 18X4 RD	3273838	8	
PTFIX 2X4 YE	① 1028363	50	
PTFIX 6X4 YE	② 3273796	10	
PTFIX 12X4 YE	③ 3273818	8	
PTFIX 18X4 YE	3273840	8	
PTFIX 2X4 GN	① 1028364	50	
PTFIX 6X4 GN	② 3273798	10	
PTFIX 12X4 GN	③ 3273820	8	
PTFIX 18X4 GN	3273842	8	
PTFIX 2X4 BN	① 1028365	50	
PTFIX 6X4 BN	② 3273800	10	
PTFIX 12X4 BN	③ 3273822	8	
PTFIX 18X4 BN	3273844	8	
PTFIX 2X4 WH	① 1028366	50	
PTFIX 6X4 WH	② 3273802	10	
PTFIX 12X4 WH	③ 3273824	8	
PTFIX 18X4 WH	3273846	8	
PTFIX 2X4 BK	① 1028367	50	
PTFIX 6X4 BK	② 3273804	10	
PTFIX 12X4 BK	③ 3273826	8	
PTFIX 18X4 BK	3273848	8	
PTFIX 2X4 VT	① 1028368	50	
PTFIX 6X4 VT	② 3273806	10	
PTFIX 12X4 VT	③ 3273828	8	
PTFIX 18X4 VT	3273850	8	
PTFIX 2X4 PK	① 1028369	50	
PTFIX 6X4 PK	② 3273807	10	
PTFIX 12X4 PK	③ 3273829	8	
PTFIX 18X4 PK	3273851	8	
PTFIX 2X4 OG	① 1028370	50	
PTFIX 6X4 OG	② 3273808	10	
PTFIX 12X4 OG	③ 3273830	8	
PTFIX 18X4 OG	3273852	8	
PTFIX 2X4-FE	① 1028371	50	
PTFIX 6X4-FE	② 3273810	10	
PTFIX 12X4-FE	③ 3273832	8	
PTFIX 18X4-FE	3273854	8	

Distribution blocks

4 mm² PTFIX distribution blocks

PTFIX ... distribution blocks

new

Notes:
For additional accessories and technical data, see page 446.
With distribution blocks, the maximum permissible total current can vary with different numbers of terminal points.

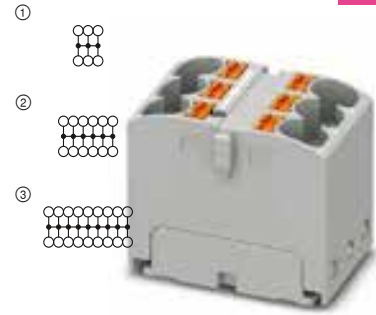

63 A, adhesive mounting



Dimensions	
	[mm]
Dimensions	
	[mm]
Dimensions	
	[mm]
Maximum electrical data	
Rated data	
Rated voltage	[V]
Nominal current / cross section	[A] / [mm ²]

Technical data			
Width	Length	Height NS 35/7,5	
18.5	28.6	-	
Width	Length	Height NS 15	
18.5	28.6	-	
Width	Length	Height	
18.5	28.6	22.7	
I _{max.} [A]	U _{max.} [V]	max. Ø [mm ²]	AWG (UL)
63	450	0.2 - 6	24-10
IEC	UL / CUL	CSA	IEC/ EN 60079-7
450	600	600	-
32 / -	32	32 / -	-

Description	Color
Basic block, 6 terminal points	gray
12 terminal points	gray
18 terminal points	gray
6 terminal points	blue
12 terminal points	blue
18 terminal points	blue
6 terminal points	red
12 terminal points	red
18 terminal points	red
6 terminal points	yellow
12 terminal points	yellow
18 terminal points	yellow
6 terminal points	green
12 terminal points	green
18 terminal points	green
6 terminal points	brown
12 terminal points	brown
18 terminal points	brown
6 terminal points	white
12 terminal points	white
18 terminal points	white
6 terminal points	black
12 terminal points	black
18 terminal points	black
6 terminal points	violet
12 terminal points	violet
18 terminal points	violet
6 terminal points	pink
12 terminal points	pink
18 terminal points	pink
6 terminal points	orange
12 terminal points	orange
18 terminal points	orange
6 terminal points	black/yellow
12 terminal points	black/yellow
18 terminal points	black/yellow

Ordering data			
Type	Order No.	Pcs./Pkt.	
PTFIX 6X4-G GY	① 3273922	10	
PTFIX 12X4-G GY	② 3273944	8	
PTFIX 18X4-G GY	③ 3273966	8	
PTFIX 6X4-G BU	① 3273924	10	
PTFIX 12X4-G BU	② 3273946	8	
PTFIX 18X4-G BU	③ 3273968	8	
PTFIX 6X4-G RD	① 3273926	10	
PTFIX 12X4-G RD	② 3273948	8	
PTFIX 18X4-G RD	③ 3273970	8	
PTFIX 6X4-G YE	① 3273928	10	
PTFIX 12X4-G YE	② 3273950	8	
PTFIX 18X4-G YE	③ 3273972	8	
PTFIX 6X4-G GN	① 3273930	10	
PTFIX 12X4-G GN	② 3273952	8	
PTFIX 18X4-G GN	③ 3273974	8	
PTFIX 6X4-G BN	① 3273932	10	
PTFIX 12X4-G BN	② 3273954	8	
PTFIX 18X4-G BN	③ 3273976	8	
PTFIX 6X4-G WH	① 3273934	10	
PTFIX 12X4-G WH	② 3273956	8	
PTFIX 18X4-G WH	③ 3273978	8	
PTFIX 6X4-G BK	① 3273936	10	
PTFIX 12X4-G BK	② 3273958	8	
PTFIX 18X4-G BK	③ 3273980	8	
PTFIX 6X4-G VT	① 3273938	10	
PTFIX 12X4-G VT	② 3273960	8	
PTFIX 18X4-G VT	③ 3273982	8	
PTFIX 6X4-G PK	① 3273939	10	
PTFIX 12X4-G PK	② 3273961	8	
PTFIX 18X4-G PK	③ 3273983	8	
PTFIX 6X4-G OG	① 3273940	10	
PTFIX 12X4-G OG	② 3273962	8	
PTFIX 18X4-G OG	③ 3273984	8	
PTFIX 6X4-FE-G	① 3273942	10	
PTFIX 12X4-FE-G	② 3273964	8	
PTFIX 18X4-FE-G	③ 3273986	8	

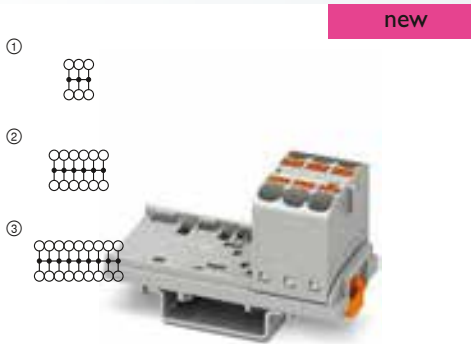

63 A, mounting on DIN rail NS 35 or NS 15, transverse to the DIN rail

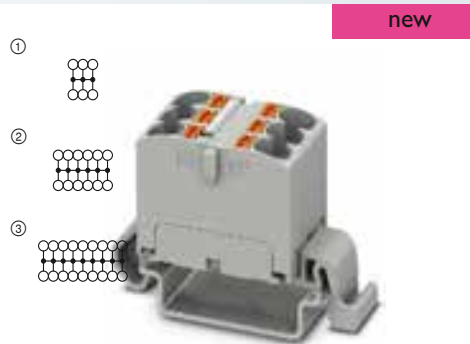

63 A, mounting on DIN rail NS 35, along the DIN rail



Technical data			
Width	Length	Height NS 35/7,5	
28.6	58.1	32.4	
Width	Length	Height NS 15	
28.6	58.1	30.4	
Width	Length	Height	
28.6	58.1	-	
I _{max} [A]	U _{max} [V]	max. Ø [mm ²]	AWG (UL)
63	800	0.2 - 6	24-10
IEC	UL / CUL	CSA	IEC/ EN 60079-7
800	600	600	-
32 / -	32	32 / -	-

Technical data			
Width	Length	Height NS 35/7,5	
18.5	45.7	30.9	
Width	Length	Height NS 15	
18.5	45.7	-	
Width	Length	Height	
18.5	45.7	-	
I _{max} [A]	U _{max} [V]	max. Ø [mm ²]	AWG (UL)
63	800	0.2 - 6	24-10
IEC	UL / CUL	CSA	IEC/ EN 60079-7
800	600	600	-
32 / -	32	32 / -	-

Ordering data			
Type	Order No.	Pcs./Pkt.	
PTFIX 6X4-NS35 GY	① 3273526	8	
PTFIX 12X4-NS35 GY	② 3273548	8	
PTFIX 18X4-NS35 GY	③ 3273570	8	
PTFIX 6X4-NS35 BU	① 3273528	8	
PTFIX 12X4-NS35 BU	② 3273550	8	
PTFIX 18X4-NS35 BU	③ 3273572	8	
PTFIX 6X4-NS35 RD	① 3273530	8	
PTFIX 12X4-NS35 RD	② 3273552	8	
PTFIX 18X4-NS35 RD	③ 3273574	8	
PTFIX 6X4-NS35 YE	① 3273532	8	
PTFIX 12X4-NS35 YE	② 3273554	8	
PTFIX 18X4-NS35 YE	③ 3273576	8	
PTFIX 6X4-NS35 GN	① 3273534	8	
PTFIX 12X4-NS35 GN	② 3273556	8	
PTFIX 18X4-NS35 GN	③ 3273578	8	
PTFIX 6X4-NS35 BN	① 3273536	8	
PTFIX 12X4-NS35 BN	② 3273558	8	
PTFIX 18X4-NS35 BN	③ 3273580	8	
PTFIX 6X4-NS35 WH	① 3273538	8	
PTFIX 12X4-NS35 WH	② 3273560	8	
PTFIX 18X4-NS35 WH	③ 3273582	8	
PTFIX 6X4-NS35 BK	① 3273540	8	
PTFIX 12X4-NS35 BK	② 3273562	8	
PTFIX 18X4-NS35 BK	③ 3273584	8	
PTFIX 6X4-NS35 VT	① 3273542	8	
PTFIX 12X4-NS35 VT	② 3273564	8	
PTFIX 18X4-NS35 VT	③ 3273586	8	
PTFIX 6X4-NS35 PK	① 3273543	8	
PTFIX 12X4-NS35 PK	② 3273565	8	
PTFIX 18X4-NS35 PK	③ 3273587	8	
PTFIX 6X4-NS35 OG	① 3273544	8	
PTFIX 12X4-NS35 OG	② 3273566	8	
PTFIX 18X4-NS35 OG	③ 3273588	8	
PTFIX 6X4-NS35-FE	① 3273546	8	
PTFIX 12X4-NS35-FE	② 3273568	8	
PTFIX 18X4-NS35-FE	③ 3273590	8	

Ordering data			
Type	Order No.	Pcs./Pkt.	
PTFIX 6X4-NS35A GY	① 3273658	10	
PTFIX 12X4-NS35A GY	② 3273680	8	
PTFIX 18X4-NS35A GY	③ 3273702	8	
PTFIX 6X4-NS35A BU	① 3273660	10	
PTFIX 12X4-NS35A BU	② 3273682	8	
PTFIX 18X4-NS35A BU	③ 3273704	8	
PTFIX 6X4-NS35A RD	① 3273662	10	
PTFIX 12X4-NS35A RD	② 3273684	8	
PTFIX 18X4-NS35A RD	③ 3273706	8	
PTFIX 6X4-NS35A YE	① 3273664	10	
PTFIX 12X4-NS35A YE	② 3273686	8	
PTFIX 18X4-NS35A YE	③ 3273708	8	
PTFIX 6X4-NS35A GN	① 3273666	10	
PTFIX 12X4-NS35A GN	② 3273688	8	
PTFIX 18X4-NS35A GN	③ 3273710	8	
PTFIX 6X4-NS35A BN	① 3273668	10	
PTFIX 12X4-NS35A BN	② 3273690	8	
PTFIX 18X4-NS35A BN	③ 3273712	8	
PTFIX 6X4-NS35A WH	① 3273670	10	
PTFIX 12X4-NS35A WH	② 3273692	8	
PTFIX 18X4-NS35A WH	③ 3273714	8	
PTFIX 6X4-NS35A BK	① 3273672	10	
PTFIX 12X4-NS35A BK	② 3273694	8	
PTFIX 18X4-NS35A BK	③ 3273716	8	
PTFIX 6X4-NS35A VT	① 3273674	10	
PTFIX 12X4-NS35A VT	② 3273696	8	
PTFIX 18X4-NS35A VT	③ 3273718	8	
PTFIX 6X4-NS35A PK	① 3273675	10	
PTFIX 12X4-NS35A PK	② 3273697	8	
PTFIX 18X4-NS35A PK	③ 3273719	8	
PTFIX 6X4-NS35A OG	① 3273676	10	
PTFIX 12X4-NS35A OG	② 3273698	8	
PTFIX 18X4-NS35A OG	③ 3273720	8	
PTFIX 6X4-NS35A-FE	① 3273678	10	
PTFIX 12X4-NS35A-FE	② 3273700	8	
PTFIX 18X4-NS35A-FE	③ 3273722	8	

Distribution blocks

4 mm² distribution blocks with PTFIX feed-in

General technical data

Rated data		IEC 60947-7-1 / IEC 60998-2-2			
Rated cross section	[mm ²]	4			
Cross section range	AWG	24 - 10			
Connection capacity		Rigid	Flexible	Ferrule without/with plastic sleeve	
1 conductor	[mm ²]	0.2 - 6	0.2 - 4	0.2 - 4	0.2 - 4
2 flexible conductors with a TWIN ferrule	[mm ²]	-	-	-	0.5 - 1
Connection cross sections directly plug-in	[mm ²]	0.5 - 6	-	0.75 - 4	0.5 - 4
Rated data, feed		IEC 60947-7-1 / IEC 60998-2-2			
Nominal current / cross section range	[A] / [AWG]	-, - / 20 - 6			
Supply connection capacity		Rigid	Flexible	Ferrule without/with plastic sleeve	
1 conductor	[mm ²]	0.5 - 10	0.5 - 10	0.5 - 10	0.5 - 10
2 flexible conductors with a TWIN ferrule	[mm ²]	-	-	-	0.5 - 4
Connection cross sections directly plug-in	[mm ²]	0.5 - 16	-	1 - 10	1 - 10
General data					
Stripping length	[mm]	10 - 12			
Insulating material		PA			
Flammability rating in accordance with UL 94		V0			

Notes:

The specified technical data and approvals refer to the first product in each column. For information on the products below, please refer to phoenixcontact.net/products

For full details of UL and CSA use groups, file nos., and Internet links, please visit phoenixcontact.net/products

) The bridge current is listed alongside the respective product. For additional colors, see page 402.

Note: Additional or deviating data is listed alongside the respective product.

System accessories

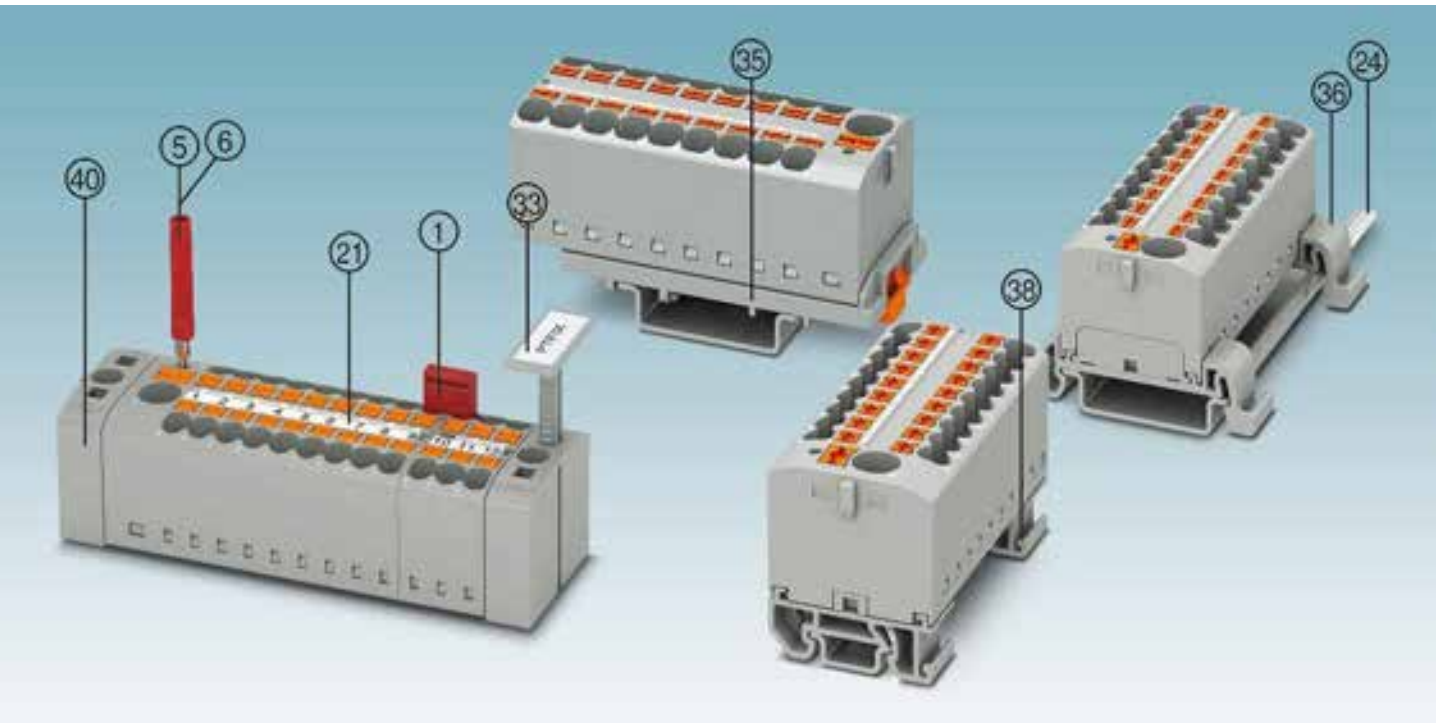

Description	No. of pos.	Color	Type	Order No.	Pcs./Pkt.	Type	Order No.	Pcs./Pkt.
① Bridge ¹⁾	2	red	FBS 2-6	3030336	50			
⑤ Test plug metal part		silver	MPS-MT SN	3212251	10			
⑥ Insulating sleeve, for MPS metal part		red	MPS-IH RD	0201676	10			
③ Terminal strip markers		gray	KLM 2	0807575	100			
② Terminal strip markers		gray	KLM 3	0811969	100			
③ NS 35 or NS 15 DIN rail adapters, transverse		gray	PTFIX-NS35	3274054	20			
③ NS 35 DIN rail adapters, lateral		gray	PTFIX-NS35A	3274056	20			
NS 35 DIN rail adapters with end bracket function, lateral		gray	PTFIX-NS35A-FIX	3274057	20			
③ NS 15 DIN rail adapters, lateral		gray	PTFIX-NS15A	3274058	20			
NS 15 DIN rail adapters with end bracket function, lateral		gray	PTFIX-NS15A-FIX	3274059	20			
④ Mounting flange		gray	PTFIX-F	3274060	20			
Screwdriver			SZF 1-0,6X3,5	1204517	10			
② Center groove labeling			TML (... X3.8)R, see also Catalog 3					
② DIN rail and end bracket			See Catalog 3					
For full accessories, visit phoenixcontact.net/products			Note: Additional or deviating accessories are listed alongside the respective product.					

new

PTFIX ... distribution blocks

The basic blocks can be individually self-assembled with different adapters or flanges in accordance with the desired mounting type.

Notes:
1) For additional accessories and technical data, see page 450.
Observe DIN IEC 60364-4-43 (DIN VDE 0100-430:2010-10) section 433.2 ff.
With distribution blocks, the maximum permissible total current can vary with different numbers of terminal points.

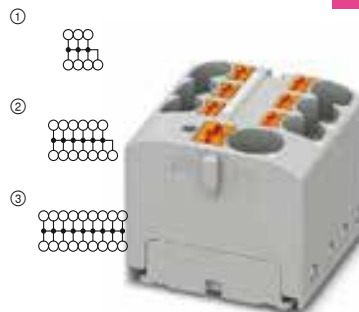

63 A, basic block, for self-assembly



Dimensions	
	[mm]
Maximum electrical data	
Rated data	
Rated voltage	[V]
Nominal current / cross section	[A] / [mm ²]

Technical data ¹⁾			
Width	Length	Height	
27.9	28.6	21.7	
I _{max} [A]	U _{max} [V]	max. Ø [mm ²]	AWG (UL)
63	450	0.2 - 6	20-8
IEC	UL / CUL	CSA	Ex
450	600	600	-
32	57 / -	57 / -	- / -

Description	Color
Basic block, with supply, 7 terminal points	gray
13 terminal points	gray
19 terminal points	gray
7 terminal points	blue
13 terminal points	blue
19 terminal points	blue
7 terminal points	red
13 terminal points	red
19 terminal points	red
7 terminal points	yellow
13 terminal points	yellow
19 terminal points	yellow
7 terminal points	green
13 terminal points	green
19 terminal points	green
7 terminal points	brown
13 terminal points	brown
19 terminal points	brown
7 terminal points	white
13 terminal points	white
19 terminal points	white
7 terminal points	black
13 terminal points	black
19 terminal points	black
7 terminal points	violet
13 terminal points	violet
19 terminal points	violet
7 terminal points	pink
13 terminal points	pink
19 terminal points	pink
7 terminal points	orange
13 terminal points	orange
19 terminal points	orange
7 terminal points	black/yellow
13 terminal points	black/yellow
19 terminal points	black/yellow

Ordering data		
Type	Order No.	Pcs./Pkt.
PTFIX 10/6X4 GY	3273856	8
PTFIX 10/12X4 GY	3273878	8
PTFIX 10/18X4 GY	3273900	8
PTFIX 10/6X4 BU	3273858	8
PTFIX 10/12X4 BU	3273880	8
PTFIX 10/18X4 BU	3273902	8
PTFIX 10/6X4 RD	3273860	8
PTFIX 10/12X4 RD	3273882	8
PTFIX 10/18X4 RD	3273904	8
PTFIX 10/6X4 YE	3273862	8
PTFIX 10/12X4 YE	3273884	8
PTFIX 10/18X4 YE	3273906	8
PTFIX 10/6X4 GN	3273864	8
PTFIX 10/12X4 GN	3273886	8
PTFIX 10/18X4 GN	3273908	8
PTFIX 10/6X4 BN	3273866	8
PTFIX 10/12X4 BN	3273888	8
PTFIX 10/18X4 BN	3273910	8
PTFIX 10/6X4 WH	3273868	8
PTFIX 10/12X4 WH	3273890	8
PTFIX 10/18X4 WH	3273912	8
PTFIX 10/6X4 BK	3273870	8
PTFIX 10/12X4 BK	3273892	8
PTFIX 10/18X4 BK	3273914	8
PTFIX 10/6X4 VT	3273872	8
PTFIX 10/12X4 VT	3273894	8
PTFIX 10/18X4 VT	3273916	8
PTFIX 10/6X4 PK	3273873	8
PTFIX 10/12X4 PK	3273895	8
PTFIX 10/18X4 PK	3273917	8
PTFIX 10/6X4 OG	3273874	8
PTFIX 10/12X4 OG	3273896	8
PTFIX 10/18X4 OG	3273918	8
PTFIX 10/6X4-FE	3273876	8
PTFIX 10/12X4-FE	3273898	8
PTFIX 10/18X4-FE	3273920	8

Distribution blocks

4 mm² distribution blocks with PTFIX feed-in

Distribution blocks

new

Notes:
For additional accessories and technical data, see page 450.
Observe DIN IEC 60364-4-43 (DIN VDE 0100-430:2010-10) section 433.2 ff.
With distribution blocks, the maximum permissible total current can vary with different numbers of terminal points.

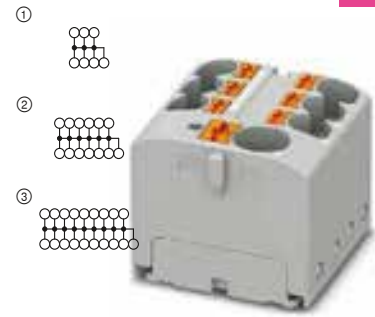

63 A, adhesive mounting



Dimensions	
	[mm]
Dimensions	
	[mm]
Dimensions	
	[mm]
Maximum electrical data	
Rated data	
Rated voltage	[V]
Nominal current / cross section	[A] / [mm ²]

Technical data			
Width	Length	Height NS 35/7,5	
27.9	28.6	-	
Width	Length	Height NS 15	
27.9	28.6	-	
Width	Length	Height	
27.9	28.6	22.7	
I _{max} [A]	U _{max} [V]	max. Ø [mm ²]	AWG (UL)
63	450	0.2 - 6	20-8
IEC	UL / CUL	CSA	IEC / EN 60079-7
450	600	600	-
32 / -	57	57 / -	-

Description	Color
Basic block, with supply, 7 terminal points	gray
13 terminal points	gray
19 terminal points	gray
7 terminal points	blue
13 terminal points	blue
19 terminal points	blue
7 terminal points	red
13 terminal points	red
19 terminal points	red
7 terminal points	yellow
13 terminal points	yellow
19 terminal points	yellow
7 terminal points	green
13 terminal points	green
19 terminal points	green
7 terminal points	brown
13 terminal points	brown
19 terminal points	brown
7 terminal points	white
13 terminal points	white
19 terminal points	white
7 terminal points	black
13 terminal points	black
19 terminal points	black
7 terminal points	violet
13 terminal points	violet
19 terminal points	violet
7 terminal points	pink
13 terminal points	pink
19 terminal points	pink
7 terminal points	orange
13 terminal points	orange
19 terminal points	orange
7 terminal points	black/yellow
13 terminal points	black/yellow
19 terminal points	black/yellow

Ordering data			
Type	Order No.	Pcs./Pkt.	
PTFIX 10/6X4-G GY	① 3273988	8	
PTFIX 10/12X4-G GY	② 3274010	8	
PTFIX 10/18X4-G GY	③ 3274032	8	
PTFIX 10/6X4-G BU	① 3273990	8	
PTFIX 10/12X4-G BU	② 3274012	8	
PTFIX 10/18X4-G BU	③ 3274034	8	
PTFIX 10/6X4-G RD	① 3273992	8	
PTFIX 10/12X4-G RD	② 3274014	8	
PTFIX 10/18X4-G RD	③ 3274036	8	
PTFIX 10/6X4-G YE	① 3273994	8	
PTFIX 10/12X4-G YE	② 3274016	8	
PTFIX 10/18X4-G YE	③ 3274038	8	
PTFIX 10/6X4-G GN	① 3273996	8	
PTFIX 10/12X4-G GN	② 3274018	8	
PTFIX 10/18X4-G GN	③ 3274040	8	
PTFIX 10/6X4-G BN	① 3273998	8	
PTFIX 10/12X4-G BN	② 3274020	8	
PTFIX 10/18X4-G BN	③ 3274042	8	
PTFIX 10/6X4-G WH	① 3274000	8	
PTFIX 10/12X4-G WH	② 3274022	8	
PTFIX 10/18X4-G WH	③ 3274044	8	
PTFIX 10/6X4-G BK	① 3274002	8	
PTFIX 10/12X4-G BK	② 3274024	8	
PTFIX 10/18X4-G BK	③ 3274046	8	
PTFIX 10/6X4-G VT	① 3274004	8	
PTFIX 10/12X4-G VT	② 3274026	8	
PTFIX 10/18X4-G VT	③ 3274048	8	
PTFIX 10/6X4-G PK	① 3274005	8	
PTFIX 10/12X4-G PK	② 3274027	8	
PTFIX 10/18X4-G PK	③ 3274049	8	
PTFIX 10/6X4-G OG	① 3274006	8	
PTFIX 10/12X4-G OG	② 3274028	8	
PTFIX 10/18X4-G OG	③ 3274050	8	
PTFIX 10/6X4-FE-G	① 3274008	8	
PTFIX 10/12X4-FE-G	② 3274030	8	
PTFIX 10/18X4-FE-G	③ 3274052	8	

new

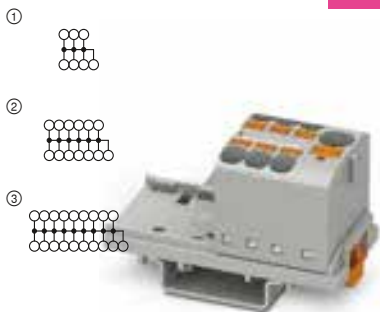

63 A, mounting on DIN rail NS 35 or NS 15, transverse to the DIN rail

new

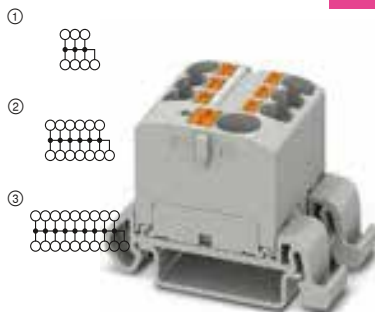

63 A, mounting on DIN rail NS 35, along the DIN rail



Technical data			
Width	Length	Height NS 35/7,5	
28.6	58.1	32.4	
Width	Length	Height NS 15	
28.6	58.1	30.4	
Width	Length	Height	
28.6	58.1	-	
I _{max} [A]	U _{max} [V]	max. Ø [mm ²]	AWG (UL)
63	800	0.2 - 6	20-8
IEC	UL / CUL	CSA	IEC / EN 60079-7
800	600	600	-
32 / -	57	57 / -	-

Technical data			
Width	Length	Height NS 35/7,5	
27.9	45.7	30.9	
Width	Length	Height NS 15	
27.9	45.7	-	
Width	Length	Height	
27.9	45.7	-	
I _{max} [A]	U _{max} [V]	max. Ø [mm ²]	AWG (UL)
63	800	0.2 - 6	20-8
IEC	UL / CUL	CSA	IEC / EN 60079-7
800	600	600	-
32 / -	57	57 / -	-

Ordering data

Ordering data

Type	Order No.	Pcs./Pkt.
PTFIX 10/6X4-NS35 GY	① 3273592	8
PTFIX 10/12X4-NS35 GY	② 3273614	8
PTFIX 10/18X4-NS35 GY	③ 3273636	8
PTFIX 10/6X4-NS35 BU	① 3273594	8
PTFIX 10/12X4-NS35 BU	② 3273616	8
PTFIX 10/18X4-NS35 BU	③ 3273638	8
PTFIX 10/6X4-NS35 RD	① 3273596	8
PTFIX 10/12X4-NS35 RD	② 3273618	8
PTFIX 10/18X4-NS35 RD	③ 3273640	8
PTFIX 10/6X4-NS35 YE	① 3273598	8
PTFIX 10/12X4-NS35 YE	② 3273620	8
PTFIX 10/18X4-NS35 YE	③ 3273642	8
PTFIX 10/6X4-NS35 GN	① 3273600	8
PTFIX 10/12X4-NS35 GN	② 3273622	8
PTFIX 10/18X4-NS35 GN	③ 3273644	8
PTFIX 10/6X4-NS35 BN	① 3273602	8
PTFIX 10/12X4-NS35 BN	② 3273624	8
PTFIX 10/18X4-NS35 BN	③ 3273646	8
PTFIX 10/6X4-NS35 WH	① 3273604	8
PTFIX 10/12X4-NS35 WH	② 3273626	8
PTFIX 10/18X4-NS35 WH	③ 3273648	8
PTFIX 10/6X4-NS35 BK	① 3273606	8
PTFIX 10/12X4-NS35 BK	② 3273628	8
PTFIX 10/18X4-NS35 BK	③ 3273650	8
PTFIX 10/6X4-NS35 VT	① 3273608	8
PTFIX 10/12X4-NS35 VT	② 3273630	8
PTFIX 10/18X4-NS35 VT	③ 3273652	8
PTFIX 10/6X4-NS35 PK	① 3273609	8
PTFIX 10/12X4-NS35 PK	② 3273631	8
PTFIX 10/18X4-NS35 PK	③ 3273653	8
PTFIX 10/6X4-NS35 OG	① 3273610	8
PTFIX 10/12X4-NS35 OG	② 3273632	8
PTFIX 10/18X4-NS35 OG	③ 3273654	8
PTFIX 10/6X4-NS35-FE	① 3273612	8
PTFIX 10/12X4-NS35-FE	② 3273634	8
PTFIX 10/18X4-NS35-FE	③ 3273656	8

Type	Order No.	Pcs./Pkt.
PTFIX 10/6X4-NS35A GY	① 3273724	8
PTFIX 10/12X4-NS35A GY	② 3273746	8
PTFIX 10/18X4-NS35A GY	③ 3273768	8
PTFIX 10/6X4-NS35A BU	① 3273726	8
PTFIX 10/12X4-NS35A BU	② 3273748	8
PTFIX 10/18X4-NS35A BU	③ 3273770	8
PTFIX 10/6X4-NS35A RD	① 3273728	8
PTFIX 10/12X4-NS35A RD	② 3273750	8
PTFIX 10/18X4-NS35A RD	③ 3273772	8
PTFIX 10/6X4-NS35A YE	① 3273730	8
PTFIX 10/12X4-NS35A YE	② 3273752	8
PTFIX 10/18X4-NS35A YE	③ 3273774	8
PTFIX 10/6X4-NS35A GN	① 3273732	8
PTFIX 10/12X4-NS35A GN	② 3273754	8
PTFIX 10/18X4-NS35A GN	③ 3273776	8
PTFIX 10/6X4-NS35A BN	① 3273734	8
PTFIX 10/12X4-NS35A BN	② 3273756	8
PTFIX 10/18X4-NS35A BN	③ 3273778	8
PTFIX 10/6X4-NS35A WH	① 3273736	8
PTFIX 10/12X4-NS35A WH	② 3273758	8
PTFIX 10/18X4-NS35A WH	③ 3273780	8
PTFIX 10/6X4-NS35A BK	① 3273738	8
PTFIX 10/12X4-NS35A BK	② 3273760	8
PTFIX 10/18X4-NS35A BK	③ 3273782	8
PTFIX 10/6X4-NS35A VT	① 3273740	8
PTFIX 10/12X4-NS35A VT	② 3273762	8
PTFIX 10/18X4-NS35A VT	③ 3273784	8
PTFIX 10/6X4-NS35A PK	① 3273741	8
PTFIX 10/12X4-NS35A PK	② 3273763	8
PTFIX 10/18X4-NS35A PK	③ 3273785	8
PTFIX 10/6X4-NS35A OG	① 3273742	8
PTFIX 10/12X4-NS35A OG	② 3273764	8
PTFIX 10/18X4-NS35A OG	③ 3273786	8
PTFIX 10/6X4-NS35A-FE	① 3273744	8
PTFIX 10/12X4-NS35A-FE	② 3273766	8
PTFIX 10/18X4-NS35A-FE	③ 3273788	8

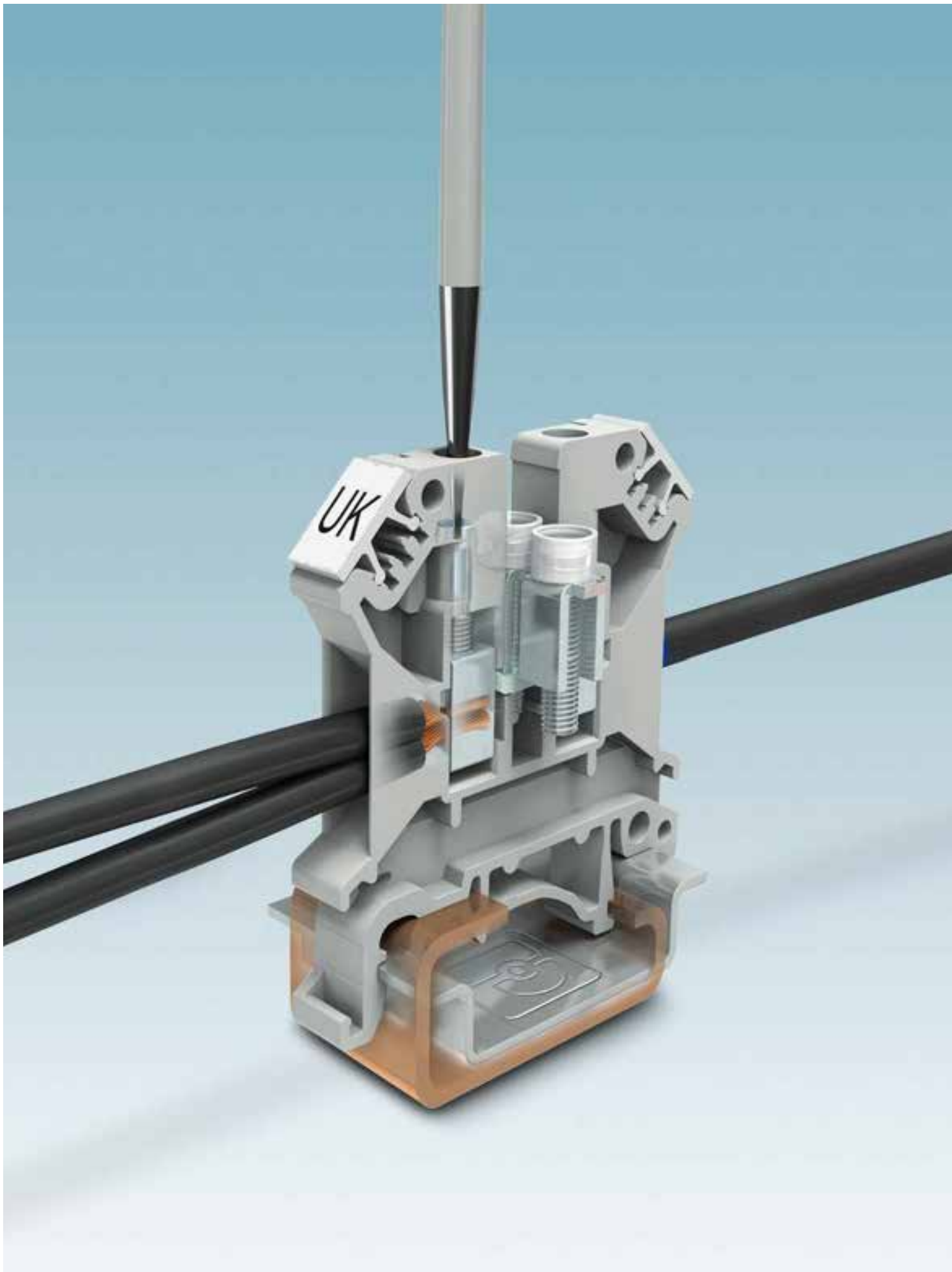

UK universal terminal blocks, OTTA, RSC, UHV high-current terminal blocks, UBAL universal terminal blocks, SK shield connection clamps

Universal modular terminal blocks

Screw connections continue to dominate industrial connection technology. No other connection technology can achieve such high contact forces in a confined space. Our UK universal terminal block series, which has been accepted throughout the world, is named after the universal snap-on foot for DIN and G-profile rails, as well as the multi-conductor connection. Another feature of this terminal block series is the flexible screw-type bridge system with a high current carrying capacity.

In addition to standard terminal blocks, the comprehensive terminal block range in this series also includes a wide range of special terminal blocks. These include, for example, terminal blocks with slip-on connections, terminal blocks for use in high temperatures, and terminal block series for energy supply and building installation.

In addition to numerous approvals, all terminal blocks in the basic series are certified in accordance with the ATEX standard and can be used in Ex e potentially explosive areas.

i Your web code: [#1397](#)

Shield connection clamps

Shield connection clamps ensure error-free operation of your system. They provide optimum wiring convenience, are suitable for all standard cable shielding, and support EMC-compliant wiring thanks to their large surfaces and low-impedance and low-resistance contact transitions.

i Your web code: [#0845](#)

Product range overview

UK universal modular terminal blocks	456
Feed-through and ground terminal blocks	458
Feed-through and ground terminal blocks with 3 and 4 connections	466
Double-level and ground double-level terminal blocks	472
Cross-reference list: bridges	476
Three-level and three-conductor initiator terminal blocks	480
Four-conductor initiator and actuator terminal blocks	486
Three and four-level terminal blocks	488
Fuse terminal blocks	490
Lever-type fuse terminal blocks for photovoltaics	502
Disconnect terminal blocks	506
Knife disconnect terminal blocks	512
Slide-type terminal blocks, test disconnect terminal blocks	517
Double-level diode terminal blocks, component terminal blocks, LED terminal blocks	528
Ground disconnect terminal block	533
UK universal modular terminal blocks with special connection	534
SSK high-temperature terminal blocks	541
USST spring-assisted screw terminal blocks	545
MT and MBK mini screw terminal blocks	553
OTTA bolt connection terminal blocks	563
RSC bolt connection terminal blocks	568
UHV high-current connectors	574
G device terminal blocks	577
UDB trunk line branch terminals	580
UBAL universal terminal blocks for aluminum conductors	582
Accessories	586
SK shield connection clamps	594

Terminal blocks – Classic

UK universal modular terminal blocks

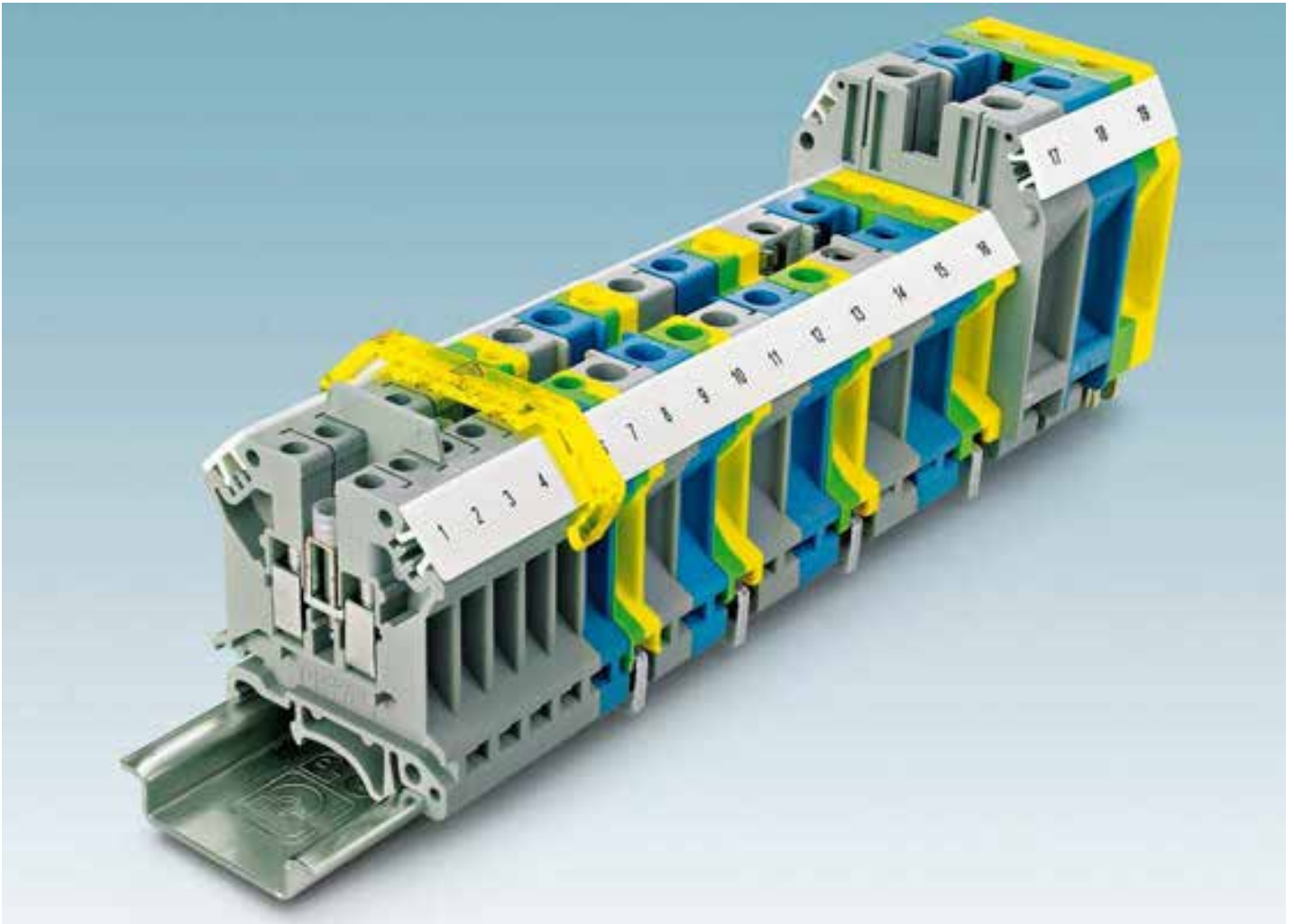

i Your web code: #1397



Universal and zero-maintenance

The UK screw connection is characterized by three main features.

- Global standard
- Multiple conductor connection
- Zero maintenance thanks to Reakdyn principle



Universal housing foot

The universal foot allows the terminal blocks to be easily snapped onto two popular DIN rail profiles, the NS 35 DIN rail or the NS 32 DIN rail with G shape.



Screw-type bridge system

The range of application for terminal blocks is greatly determined by the bridge accessories. A wide choice of bridges is available for the UK series, enabling all switching tasks to be performed with ease.



If used with the corresponding fixed bridges, the step brackets STL... allow terminal blocks with different nominal cross sections to be connected. This allows infed blocks to be created with ease.

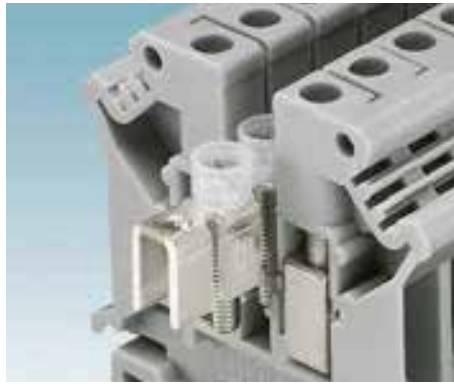

Any number of positions can be easily disconnected from a 10-pos. strip of the fixed bridge with isolation cap FBI ..., placed in the bridge shaft and screwed down.

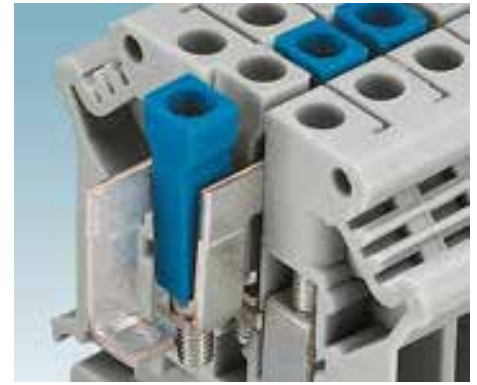

The L bridges LB ... can be used to guide two different potentials over up to 100 terminal blocks in the bridge shaft. Isolated and color-coded contact screws clearly indicate the relevant potential.



The bridge bar isolator switching bridges ISSBI ... enable switchable cross connections if used with bridge bar isolator IS Here the screw has the function of a live switching element.



The isolated insertion bridges EB ... are simply clamped down at the connection points with or without conductors. The bridges can be assembled as required for the number of positions. Individual forks are removed for jumping bridging.



PSB ... test sockets which can be screwed into the bridge shaft enable reliable test points for 2.3 mm and 4 mm test plugs. The 2.3 mm MPS ... test plug makes direct contact in the bridge shaft when using terminal blocks with an overall width of 5.2 mm and 6.2 mm.



Large and clear marking of the terminal points is essential for reliable and quick installation. Each terminal point in the UK series can be labeled separately.



The separating disk TS ... is used to electrically and visually separate two neighboring bridges. A separating disk should be placed on both sides of the bridge in order for the terminal blocks to retain their complete nominal voltage.



The partition plates protrude beyond the terminal block contours. They provide visual as well as electrical group separation.

Terminal blocks – Classic

UK universal modular terminal blocks

Feed-through terminal blocks UK ...



- The UK series of universal screw terminal blocks possesses typical features which are crucial to practical use
- Universal foot which can be used on DIN rails NS 35 ... and NS 32 ...
- Potential distribution alternatively via fixed bridges in the terminal center or insertion bridges in the clamping space
- High bridge currents

High-current terminal blocks up to 240 mm²

The UKH high-current terminal blocks up to 240 mm² can be found in the section on UT screw connection terminal blocks

PROJECT complete planning enables the quick and convenient planning and configuration of error-free terminal strips.



Notes:
For more insertion bridges, visit phoenixcontact.net/products
1) For information on installation and using accessories for Ex applications, see page 678.



1.5 (1.5) mm², 17.5 A,
feed-through terminal block



KEMA 98ATEX1651 U / IECEx KEM 06.0034U

Dimensions		[mm]
Dimensions		[mm]
Maximum electrical data		
Rated data		
Rated voltage	[V]	500
Nominal current / cross section	[A] / [mm ²]	17.5 / 1.5
Rated cross section	[mm ²]	1.5
Cross section range	AWG	26 - 16
Connection capacity		
1 conductor	[mm ²]	0.14 - 1.5
2 conductors (of the same type)	[mm ²]	0.14 - 0.75
2 flexible conductors with a TWIN ferrule	[mm ²]	-
Max. cross section with insertion bridge	[mm ²]	-
General data		
Stripping length	[mm]	7
Screw thread		M2
Tightening torque	[Nm]	0.22 - 0.25
Insulating material		PA
Flammability rating in accordance with UL 94		V0

Technical data				
Width	Length	Height NS 35/7.5		
4.2	42.5	42		
Width	Length	Height NS 32		
4.2	42.5	47		
I _{max} [A]	U _{max} [V]	max. Ø [mm ²]	AWG (UL)	
17.5	500	0.14 - 1.5	30-14	
IEC 60947-7-1		Ex		
IEC	UL / CUL	CSA	IEC / EN 60079-7	
500	300	-	352	
17.5 / 1.5	15 / -	-	17 / 1.5	
1.5	-	-	0.14-1.5	
26 - 16	30-14	-	26 - 16	
Connection capacity			Ferrule	
Rigid	Flexible	without/with plastic sleeve		
0.14 - 1.5	0.14 - 1.5	0.25 - 0.75	0.25 - 0.75	
0.14 - 0.75	0.14 - 0.75	0.25 - 0.34	-	
-	-	-	0.5 - 0.5	
-	-	-	-	

Description	No. of pos.	Color
Terminal block, for mounting on NS 32... or NS 35...		gray
		blue

Cover, width: 1.5 mm		gray
Cover, width: 1.8 mm		blue
		gray
		blue
Fixed bridge, isolated	10	silver
Insertion bridge, insulated	10	gray
Switch bar for 2 terminal blocks, complete, to increase insulation an end cover must be interposed	2	silver
Isolator bridge bar, divisible, with 10 screws, for switchable branches with IS-K...	10	silver
Bridge bar isolator, as distance piece for isolator bridge bar		gray
Separating disk, for separation of neighboring bridges, can be fitted later, no loss of pitch		gray
Partition plate, 1.5 mm wide		gray
Test socket		silver
Test socket, insulated, can be used only with FBI and ISSBI		silver
Screwdriver		
Lateral groove labeling		

Ordering data			
Type	I _{max}	Order No.	Pcs./Pkt.
UK 1,5 N		3005837	50
UK 1,5 N BU		3005840	50

Accessories ¹⁾			
D-UK 2,5		3001022	50
D-UK 2,5 BU		3001103	50
FBRN 10-4 N	12 A	3001624	10
ATP-UK		3003224	50
SZS 0,4X2,5 VDE		1205037	10
ZB 4 (see Catalog 3)			

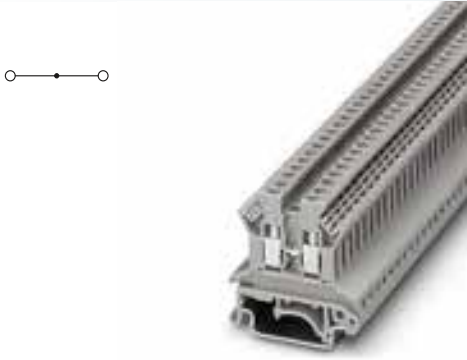

2.5 (4) mm², 24 A,
feed-through terminal block

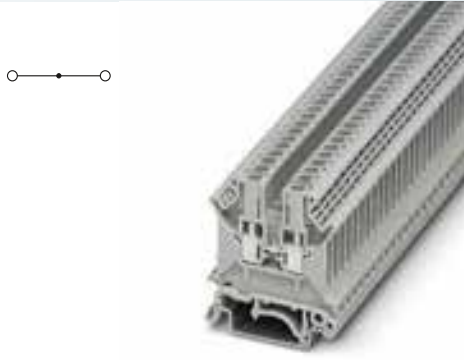

2.5 (4) mm², 32 A,
feed-through terminal block

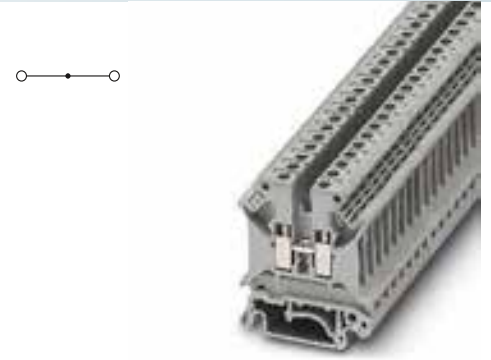

4 (6) mm², 41 A,
feed-through terminal block



Ex: EAC Ex IEC CB
KEMA 06ATEX119 U / IECEx KEM 06.0034U



Ex: EAC Ex IEC CB
KEMA 98ATEX1651 U / IECEx KEM 06.0034U



Ex: EAC Ex IEC CB
KEMA 98ATEX1651 U / IECEx KEM 06.0034U

Technical data			
Width	Length	Height NS 35/7,5	
5.2	42.5	42	
Width	Length	Height NS 32	
5.2	42.5	47	
I_{max} [A]	U_{max} [V]	max. Ø [mm ²]	AWG (UL)
24	800	0.2 - 4	30-12
IEC 60947-7-1			
IEC	UL / CUL	CSA	IEC/ EN 60079-7
800	300	300	550
24 / 2.5	20 / -	20 / -	22 / 2.5
2.5	-	-	0.2-2.5
24 - 12	30-12	28-12	24 - 12
Rigid	Flexible	Ferrule	
without/with plastic sleeve			
0.2 - 4	0.2 - 2.5	0.25 - 2.5	0.25 - 1.5
0.2 - 1	0.2 - 1	0.25 - 1	-
-	-	-	0.5 - 1.5
2.5	2.5	-	-
7			
M3			
0.6 - 0.8			
PA			
V2			

Technical data			
Width	Length	Height NS 35/7,5	
5.2	42.5	47	
Width	Length	Height NS 32	
5.2	42.5	52	
I_{max} [A]	U_{max} [V]	max. Ø [mm ²]	AWG (UL)
32	800	0.2 - 4	28-12
IEC 60947-7-1			
IEC	UL / CUL	CSA	IEC/ EN 60079-7
800	600	600	690
24 / 2.5	20 / -	20 / -	23 / 2.5
2.5	-	-	0.2-2.5
24 - 12	28-12	28-12	24 - 12
Rigid	Flexible	Ferrule	
without/with plastic sleeve			
0.2 - 4	0.2 - 2.5	0.25 - 2.5	0.25 - 1.5
0.2 - 1.5	0.2 - 1.5	0.25 - 1.5	-
-	-	-	0.5 - 1
4	2.5	-	-
8			
M3			
0.6 - 0.8			
PA			
V0			

Technical data			
Width	Length	Height NS 35/7,5	
6.2	42.5	47	
Width	Length	Height NS 32	
6.2	42.5	52	
I_{max} [A]	U_{max} [V]	max. Ø [mm ²]	AWG (UL)
41	800	0.2 - 6	30-10
IEC 60947-7-1			
IEC	UL / CUL	CSA	IEC/ EN 60079-7
800	600	600	690
32 / 4	30 / -	30 / -	30.5 / 4
4	-	-	0.2-4
24 - 10	30-10	28-10	24 - 10
Rigid	Flexible	Ferrule	
without/with plastic sleeve			
0.2 - 6	0.2 - 4	0.25 - 4	0.25 - 2.5
0.2 - 1.5	0.2 - 1.5	0.25 - 1.5	-
-	-	-	0.5 - 2.5
4	4	-	-
8			
M3			
0.6 - 0.8			
PA			
V0			

Ordering data			
Type	I_{max}	Order No.	Pcs./Pkt.
UK 2,5 N		3003347	50
UK 2,5 N BU		3003350	50

Ordering data			
Type	I_{max}	Order No.	Pcs./Pkt.
UK 3 N		3001501	50
UK 3 N BU		3001514	50

Ordering data			
Type	I_{max}	Order No.	Pcs./Pkt.
UK 5 N		3004362	50
UK 5 N BU		3004388	50

Accessories ¹⁾			
D-UK 2,5		3001022	50
D-UK 2,5 BU		3001103	50
FBR1 10-5 N	24 A	2770642	10
EBL 10- 5	24 A	2303132	10
USBR 2-7	18 A	2303239	1
TS-KK 3		2770215	50
ATP-UK		3003224	50
PSB 3/10/4		0601292	10
PSBJ 3/13/4		0201304	10
SF-SL 0,6X3,5-100 S-VDE		1212587	10

Accessories ¹⁾			
D-UK 4/10		3003020	50
D-UK 4/10 BU		3003101	50
FBR1 10-5 N	30 A	2770642	10
EBL 10- 5	24 A	2303132	10
TS-K		1302215	50
ATP-UK		3003224	50
PSB 3/10/4		0601292	10
PSBJ 3/13/4		0201304	10
SF-SL 0,6X3,5-100 S-VDE		1212587	10

Accessories ¹⁾			
D-UK 4/10		3003020	50
D-UK 4/10 BU		3003101	50
FBI 10- 6	41 A	0203250	10
EB 10- 6	32 A	0201139	10
USBR 2-7	34 A	2303239	1
ISSBI 10- 6	30 A	0301505	10
IS-K 4		1302338	100
TS-K		1302215	50
ATP-UK		3003224	50
PSB 3/10/4		0601292	10
PSBJ 3/13/4		0201304	10
SF-SL 0,6X3,5-100 S-VDE		1212587	10

ZB 5 (see Catalog 3)

ZB 5 (see Catalog 3)

ZB 6 (see Catalog 3)

Terminal blocks – Classic

UK universal modular terminal blocks

UHSK/S 2000 feed-through terminal blocks

- All universal terminal blocks of the UK ... series can also be used in the area at risk of explosion in accordance with IEC/EN 60079 as standard
- The corresponding EC type examination certificate numbers for the Ex approval can be found in the technical connection data

Notes:
 1) For information on installation and using accessories for Ex applications, see page 678.



6 (10) mm², 57 A, 2000 V, feed-through terminal block

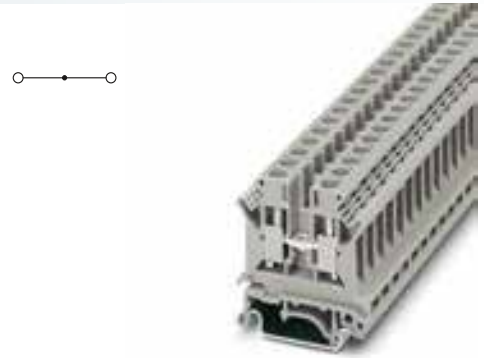

6 (10) mm², 57 A, feed-through terminal block

Ex:

 SEV12ATEX0168U / IECEx SEV12.0008U

Technical data				
Width	Length	Height NS 35/7,5		
10.2	52	70.5		
Width	Length	Height NS 32		
10.2	52	75.5		
I _{max} [A]	U _{max} [V]	max. Ø [mm ²]	AWG (UL)	
57	2000	0.5 - 10	26-8	
IEC 60947-7-1				
IEC	UL / CUL	CSA	IEC/EN 60079-7	
2000	1000	600	1100	
Nominal current / cross section [A] / [mm ²]		25 / -	41 / 6	
41 / -	50 / -	-	0.5-6	
Rated cross section [mm ²]		-	20 - 8	
6	-	-	-	
Cross section range AWG		26-12	20 - 8	
20 - 8	26-8	-	-	
Connection capacity				
	Rigid	Flexible	Ferrule without/with plastic sleeve	
1 conductor [mm ²]	0.5 - 10	0.5 - 6	0.5 - 10	0.5 - 6
2 conductors (of the same type) [mm ²]	0.5 - 6	0.5 - 6	0.5 - 6	-
2 flexible conductors with a TWIN ferrule [mm ²]	-	-	-	0.5 - 6
Max. cross section with insertion bridge [mm ²]	-	-	-	-
General data				
Stripping length [mm]	10			
Screw thread	M4			
Tightening torque [Nm]	1.5 - 1.8			
Insulating material	PA			
Flammability rating in accordance with UL 94	V0			

Ex:

 KEMA 98ATEX1651 U / IECEx KEM 06.0034U

Technical data				
Width	Length	Height NS 35/7,5		
8.2	42.5	47		
Width	Length	Height NS 32		
8.2	42.5	52		
I _{max} [A]	U _{max} [V]	max. Ø [mm ²]	AWG (UL)	
57	800	0.2 - 10	26-8	
IEC 60947-7-1				
IEC	UL / CUL	CSA	IEC/EN 60079-7	
800	600	600	690	
Nominal current / cross section [A] / [mm ²]		50 / -	41 / 6	
41 / 6	50 / -	-	0.2-6	
Rated cross section [mm ²]		-	24 - 8	
6	-	-	-	
Cross section range AWG		26-8	24 - 8	
24 - 8	26-8	-	-	
Connection capacity				
	Rigid	Flexible	Ferrule without/with plastic sleeve	
0.2 - 10	0.2 - 6	0.25 - 6	0.25 - 6	
0.2 - 2.5	0.2 - 2.5	0.25 - 1.5	-	
-	-	-	0.5 - 4	
4	4	-	-	
General data				
Stripping length [mm]	10			
Screw thread	M4			
Tightening torque [Nm]	1.5 - 1.8			
Insulating material	PA			
Flammability rating in accordance with UL 94	V0			

Description	No. of pos.	Color
Terminal block, with universal foot for mounting on NS 32... or NS 35...		gray
Terminal block, for mounting on NS 35...		blue gray blue

Ordering data				
Type	I _{max}	Order No.	Pcs./Pkt.	
UHSK/S 2000		0704076	50	

Ordering data				
Type	I _{max}	Order No.	Pcs./Pkt.	
UK 6 N		3004524	50	
UK 6 N BU		3004977	50	

Accessories ¹⁾		
Cover, width: 1.8 mm		gray
Cover, width: 1.5 mm		gray
Cover, width: 2 mm		gray
Fixed bridge, isolated		silver
	2	silver
	10	silver
Insertion bridge, fully insulated		gray
	10	gray
Switching bridge for 2 terminal blocks, a cover must be placed between them to increase isolation		silver
	2	silver
Isolator bridge bar, divisible, with 10 screws, for switchable branches with IS-K...		silver
	10	silver
Bridge bar isolator, as distance piece for isolator bridge bar		gray
Separating disk, for separation of neighboring bridges, can be fitted later, no loss of pitch		gray
Partition plate, 1.5 mm wide		gray
Test socket, for test connection with test plug PS		silver
Screwdriver		
Lateral groove labeling		

Accessories ¹⁾				
Type	I _{max}	Order No.	Pcs./Pkt.	
D-UHSK 2000		0704021	50	
FBI 10-10	61 A	0203276	10	

Accessories ¹⁾				
Type	I _{max}	Order No.	Pcs./Pkt.	
D-UK 4/10		3003020	50	
FBI 10- 8	57 A	0203263	10	
EB 10- 8	57 A	0202138	10	
SB 2- 8/13 N	40 A	0200062	1	
ISSBI 10- 8	57 A	0301534	10	
IS-K 10		1303337	100	
TS-K		1302215	50	
ATP-UK		3003224	50	
PSB 4/7/6		0303299	10	
SZS 1,0X4,0 VDE		1205066	10	

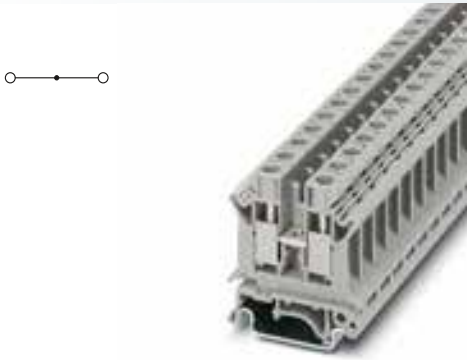

10 (16) mm², 76 A,
feed-through terminal block

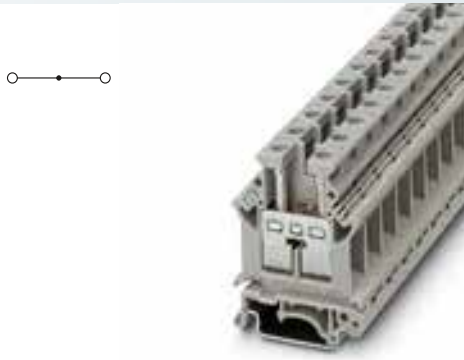

16 (25) mm², 101 A,
feed-through terminal block

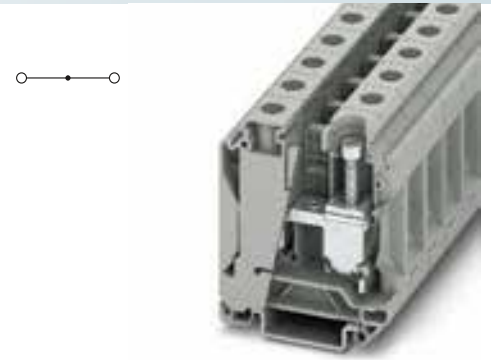

35 (35) mm², 125 A,
feed-through terminal block

Ex: EAC Ex IEC UL ClassNK CB

 KEMA 98ATEX1786U / IECEx KEM 06.0029U

Ex: EAC Ex IEC UL ClassNK CB

 KEMA 98ATEX1786U / IECEx KEM 06.0029U

Technical data			
Width	Length	Height NS 35/7,5	
10.2	42.5	47.3	
Width	Length	Height NS 32	
10.2	42.5	52.3	
I _{max} [A]	U _{max} [V]	max. Ø [mm ²]	
76	800	24-6	
IEC 60947-7-1			
IEC	UL / CUL	CSA	IEC/ EN 60079-7
800	600	600	690
57 / 10	65 / -	65 / -	57 / 10
10	-	-	0.5-10
20 - 6	24-6	24-6	20 - 6
Rigid	Flexible	Ferrule without/with plastic sleeve	
0.5 - 16	0.5 - 10	0.5 - 10	0.5 - 6
0.5 - 4	0.5 - 4	0.5 - 2.5	-
-	-	-	0.5 - 6
10	10	-	-
10			
M4			
1.5 - 1.8			
PA			
V0			

Technical data			
Width	Length	Height NS 35/7,5	
12.2	42.5	54	
Width	Length	Height NS 32	
12.2	42.5	59	
I _{max} [A]	U _{max} [V]	max. Ø [mm ²]	
101	800	2.5 - 25	
IEC 60947-7-1			
IEC	UL / CUL	CSA	IEC/ EN 60079-7
800	600	600	690
76 / 16	85 / -	85 / -	74 / 16
16	-	-	4-16
14 - 4	22-4	22-4	14 - 4
Rigid	Flexible	Ferrule without/with plastic sleeve	
2.5 - 25	4 - 16	1.5 - 16	1.5 - 16
1.5 - 6	1.5 - 4	1.5 - 6	-
-	-	-	0.75 - 10
16	16	-	-
11			
M4			
1.5 - 1.8			
PA			
V0			

Technical data			
Width	Length	Height NS 35/7,5	
16	54.5	62	
Width	Length	Height NS 32	
16	54.5	-	
I _{max} [A]	U _{max} [V]	max. Ø [mm ²]	
125	1000	10 - 35	
IEC 60947-7-1			
IEC	UL / CUL	CSA	IEC/ EN 60079-7
1000	600	-	-
125 / 35	115	-	-
35	-	-	-
8 - 2	8-2	-	-
Rigid	Flexible	Ferrule without/with plastic sleeve	
10 - 35	10 - 35	10 - 35	10 - 35
6 - 16	6 - 10	6 - 10	-
-	-	-	6 - 10
-	-	-	-
16			
M6			
3.2 - 3.7			
PA			
V0			

Ordering data			
Type	I _{max}	Order No.	Pcs./Pkt.
UK 10 N		3005073	50
UK 10 N BU		3005086	50

Ordering data			
Type	I _{max}	Order No.	Pcs./Pkt.
UK 16 N		3006043	50
UK 16 N BU		3006056	50

Ordering data			
Type	I _{max}	Order No.	Pcs./Pkt.
UK 35 N		3074130	50
UK 35 N BU		3058350	50

Accessories ¹⁾			
D-UK 4/10		3003020	50
FBI 10-10	76 A	0203276	10
EB 10-10	70 A	0203137	10
TS-K		1302215	50
ATP-UK		3003224	50
PSB 4/7/6		0303299	10
SZS 1,0X4,0 VDE		1205066	10

Accessories ¹⁾			
D-UK 16		3006027	50
FBI 10-12	101 A	0203454	10
EB 10-12	70 A	3006137	10
TS-K		1302215	50
ATP-UK		3003224	50
PSB 4/7/6		0303299	10
SZS 1,0X4,0 VDE		1205066	10

Accessories ¹⁾			
FBI 2-15	125 A	0201333	10
PSB 6/5/6		0205290	10
SZS 1,0X6,5 VDE		1205079	10

ZB 10 (see Catalog 3)

ZB 12 (see Catalog 3)

ZB 16,3 (see Catalog 3)

Terminal blocks – Classic

UK universal modular terminal blocks

Ground terminal blocks USLKG ...

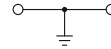
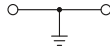

Notes:
1) For information on installation and using accessories for Ex applications, see page 678.



1.5 (1.5) mm², ground terminal block



2.5 (4) mm², ground terminal block

Ex: EAC Ex IECEx
 KEMA 99ATEX4487U / IECEx KEM 06.0035U

Ex: EAC Ex IECEx
 KEMA 96ATEX4370 U / IECEx KEM 06.0035U

Dimensions		[mm]	
Dimensions		[mm]	
Maximum electrical data			
Rated data			
Rated voltage	[V]	-	-
Nominal current / cross section	[A] / [mm ²]	- / -	-
Rated cross section	[mm ²]	1.5	-
Cross section range	AWG	26 - 16	26-14
Connection capacity			
1 conductor	[mm ²]	0.14 - 1.5	0.14 - 1.5
2 conductors (of the same type)	[mm ²]	0.14 - 0.75	0.14 - 0.75
2 flexible conductors with a TWIN ferrule	[mm ²]	-	-
General data			
Stripping length	[mm]	7	
Terminal point: Thread / torque	- / [Nm]	M2 / 0.22 - 0.25	
Mounting: Thread / torque	- / [Nm]	PE foot with mounting screw, M2 / 0.22 - 0.25	
Insulating material		PA	
Flammability rating in accordance with UL 94		V0	

Technical data				
Width	Length	Height NS 35/7,5		
4.2	42.5	42		
Width	Length	Height NS 32		
4.2	42.5	47		
		max. Ø [mm ²]	AWG (UL)	
		0.14 - 1.5	26-14	
IEC 60947-7-2				
IEC	UL / CUL	CSA	IEC/ EN 60079-7	
-	-	-	-	
-	-	-	- / 1.5	
1.5	-	-	0.14-1.5	
26 - 16	26-14	-	26 - 16	
Connection capacity		Ferrule		
Rigid	Flexible	without/with plastic sleeve		
0.14 - 1.5	0.14 - 1.5	0.25 - 0.75	0.25 - 0.75	
0.14 - 0.75	0.14 - 0.75	0.25 - 0.34	-	
-	-	-	0.5 - 0.5	
General data				
Stripping length	[mm]	7		
Terminal point: Thread / torque	- / [Nm]	M2 / 0.22 - 0.25		
Mounting: Thread / torque	- / [Nm]	PE foot with mounting screw, M2 / 0.22 - 0.25		
Insulating material		PA		
Flammability rating in accordance with UL 94		V0		

Technical data				
Width	Length	Height NS 35/7,5		
5.2	42.5	42		
Width	Length	Height NS 32		
5.2	42.5	47		
		max. Ø [mm ²]	AWG (UL)	
		0.2 - 4	-	
IEC 60947-7-2				
IEC	UL / CUL	CSA	IEC/ EN 60079-7	
-	-	-	-	
-	-	-	- / 2.5	
2.5	-	-	0.2-2.5	
24 - 12	-	28-12	24 - 12	
Connection capacity		Ferrule		
Rigid	Flexible	without/with plastic sleeve		
0.2 - 4	0.2 - 2.5	0.25 - 2.5	0.25 - 1.5	
0.2 - 1	0.2 - 1	0.25 - 1.5	-	
-	-	-	0.5 - 1.5	
General data				
Stripping length	[mm]	7		
Terminal point: Thread / torque	- / [Nm]	M3 / 0.6 - 0.8		
Mounting: Thread / torque	- / [Nm]	PE foot with mounting screw, M2.5 / 0.5 - 0.6		
Insulating material		PA		
Flammability rating in accordance with UL 94		V0		

Ordering data	
Description	Color
Ground terminal block, for mounting on NS 32... or NS 35...	green-yellow
Ground terminal block, for mounting on NS 35/15-2,3	green-yellow

Ordering data		
Type	Order No.	Pcs./Pkt.
USLKG 1,5 N	3005853	50

Ordering data		
Type	Order No.	Pcs./Pkt.
USLKG 2,5 N	0441119	50
USLKG 2,5 N-1	0443081	50

Accessories ¹⁾	
Screwdriver	
Lateral groove labeling	

Accessories ¹⁾		
SZS 0,4X2,5 VDE	1205037	10
ZB 4 (see Catalog 3)		

Accessories ¹⁾		
SF-SL 0,6X3,5-100 S-VDE	1212587	10
ZB 5 (see Catalog 3)		

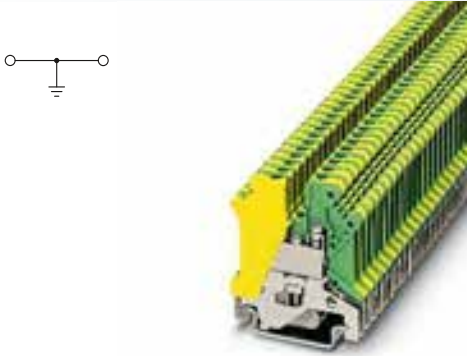

2.5 (4) mm², ground terminal block

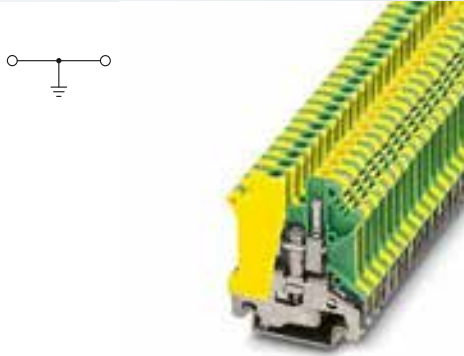

4 (6) mm², ground terminal block

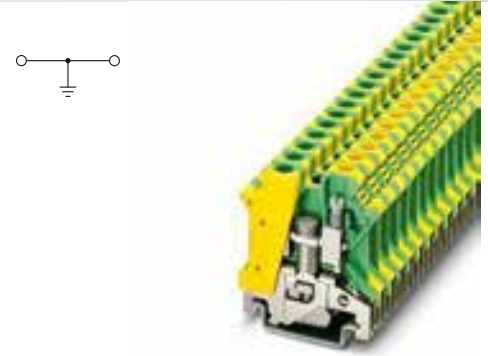

6 (10) mm², ground terminal block



Ex: EAC Ex IEC KEMA
KEMA 97ATEX1622 U / IECEx KEM 06.0035U



Ex: EAC Ex IEC KEMA
KEMA 99ATEX4487U / IECEx KEM 06.0035U



Ex: EAC Ex IEC KEMA
KEMA 96ATEX4370 U / IECEx KEM 06.0035U

Technical data			
Width	Length	Height NS 35/7,5	
5.2	42.5	47	
Width	Length	Height NS 32	
5.2	42.5	52	
		max. Ø [mm ²]	AWG (UL)
		0.2 - 4	24-12
IEC 60947-7-2			
IEC	UL / CUL	CSA	IEC/ EN 60079-7
-	-	-	-
-/-	-	-/-	-/2.5
2.5	-	-	0.2-2.5
24 - 12	24-12	22-12	24 - 12
Rigid	Flexible	Ferrule	
		without/with plastic sleeve	
0.2 - 4	0.2 - 2.5	0.25 - 2.5	0.25 - 1.5
0.2 - 1.5	0.2 - 1.5	0.25 - 1.5	-
-	-	-	0.5 - 1.5
8			
M3 / 0.6 - 0.8			
PE foot with mounting screw, M2.5 / 0.5 - 0.6			
PA			
V0			

Technical data			
Width	Length	Height NS 35/7,5	
6.2	42.5	47	
Width	Length	Height NS 32	
6.2	42.5	52	
		max. Ø [mm ²]	AWG (UL)
		0.2 - 6	24-10
IEC 60947-7-2			
IEC	UL / CUL	CSA	IEC/ EN 60079-7
-	-	-	-
-/-	-	-/-	-/4
4	-	-	0.2-4
24 - 10	24-10	26-10	24 - 10
Rigid	Flexible	Ferrule	
		without/with plastic sleeve	
0.2 - 6	0.2 - 4	0.25 - 4	0.25 - 2.5
0.2 - 1.5	0.2 - 1.5	0.25 - 1.5	-
-	-	-	0.5 - 2.5
8			
M3 / 0.6 - 0.8			
PE foot with mounting screw, M3 / 0.6 - 0.8			
PA			
V0			

Technical data			
Width	Length	Height NS 35/7,5	
8.2	42.5	47	
Width	Length	Height NS 32	
8.2	42.5	52	
		max. Ø [mm ²]	AWG (UL)
		0.2 - 10	24-8
IEC 60947-7-2			
IEC	UL / CUL	CSA	IEC/ EN 60079-7
-	-	-	-
-/-	-	-	-/6
6	-	-	0.2-6
24 - 8	24-8	-	24 - 8
Rigid	Flexible	Ferrule	
		without/with plastic sleeve	
0.2 - 10	0.2 - 6	0.25 - 6	0.25 - 6
0.2 - 2.5	0.2 - 2.5	0.25 - 1.5	-
-	-	-	0.5 - 4
10			
M4 / 1.5 - 1.8			
PE foot with mounting screw, M4 / 1.5 - 1.8			
PA			
V0			

Ordering data		
Type	Order No.	Pcs./Pkt.
USLKG 3	0441083	50
USLKG 3-1	0441106	50

Ordering data		
Type	Order No.	Pcs./Pkt.
USLKG 5	0441504	50
USLKG 5-1	0441517	50

Ordering data		
Type	Order No.	Pcs./Pkt.
USLKG 6 N	0442079	50
USLKG 6 N-1	0444048	50

Accessories ¹⁾		
SF-SL 0,6X3,5-100 S-VDE	1212587	10
ZB 5 (see Catalog 3)		

Accessories ¹⁾		
SF-SL 0,6X3,5-100 S-VDE	1212587	10
ZB 6 (see Catalog 3)		

Accessories ¹⁾		
SZS 1,0X4,0 VDE	1205066	10
ZB 8 (see Catalog 3)		

Terminal blocks – Classic

UK universal modular terminal blocks

Ground terminal blocks USLKG ...

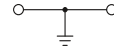

10 (16) mm², ground terminal block

Notes:
 1) For information on installation and using accessories for Ex applications, see page 678.

Ex: Ex, IEC Ex, EAC Ex, IEC Ex, KTR, CB

 KEMA 99ATEX4487U / IECEx KEM 06.0035U

Dimensions	
	[mm]
Dimensions	
	[mm]
Maximum electrical data	
Rated data	
Rated voltage	[V]
Nominal current / cross section	[A] / [mm ²]
Rated cross section	[mm ²]
Cross section range	AWG
Connection capacity	
1 conductor	[mm ²]
2 conductors (of the same type)	[mm ²]
2 flexible conductors with a TWIN ferrule	[mm ²]
General data	
Stripping length	[mm]
Terminal point: Thread / torque	- / [Nm]
Mounting: Thread / torque	- / [Nm]
Insulating material	
Flammability rating in accordance with UL 94	

Technical data			
Width	Length	Height NS 35/7,5	
10.2	42.5	47	
Width	Length	Height NS 32	
10.2	42.5	52	
		max. Ø [mm ²]	AWG (UL)
		0.5 - 16	20-6
IEC 60947-7-2			Ex
IEC	UL / CUL	CSA	IEC/ EN 60079-7
-	-	-	-
- / 10	-	- / -	- / 10
10	-	-	0.5-10
20 - 6	20-6	24-6	20 - 6
Connection capacity	Rigid	Flexible	Ferrule
			without/with plastic sleeve
1 conductor	0.5 - 16	0.5 - 10	0.5 - 10 0.5 - 6
2 conductors (of the same type)	0.5 - 4	0.5 - 4	0.5 - 2.5 -
2 flexible conductors with a TWIN ferrule	-	-	- 0.5 - 6
General data			
Stripping length	[mm]	10	
Terminal point: Thread / torque	- / [Nm]	M4 / 1.5 - 1.8	
Mounting: Thread / torque	- / [Nm]	PE foot with mounting screw, M4 / 1.5 - 1.8	
Insulating material		PA	
Flammability rating in accordance with UL 94		V0	

Description	Color
Ground terminal block, for mounting on NS 32... or NS 35...	green-yellow
Ground terminal block, for mounting on NS 35/15--2,3	green-yellow
Ground terminal block, for mounting on NS 35...	green-yellow

Ordering data		
Type	Order No.	Pcs./Pkt.
USLKG 10 N	3003923	50
USLKG 10 N-1	0442082	50

Screwdriver
Lateral groove labeling

Accessories ¹⁾		
SZS 1,0X4,0 VDE	1205066	10
ZB 10 (see Catalog 3)		

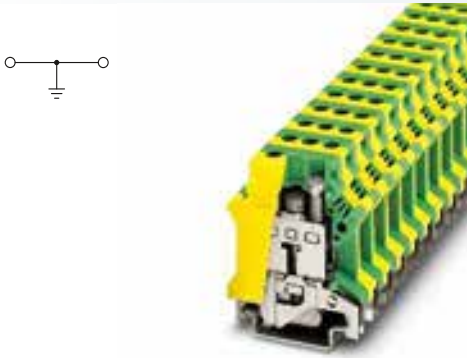
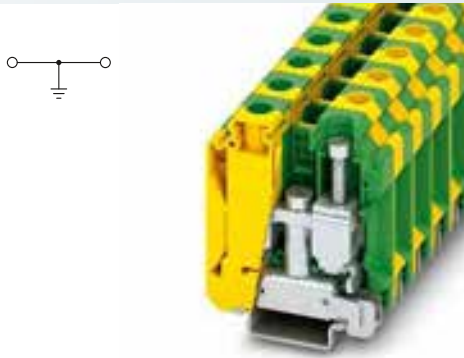
16 (25) mm², ground terminal block35 (35) mm², ground terminal block

Ex: EAC Ex

 KEMA 99ATEX4487U / IECEx KEM 06.0035U

Technical data			
Width	Length	Height NS 35/7,5	
12.2	42.5	54	
Width	Length	Height NS 32	
12.2	42.5	59	
		max. Ø [mm ²]	AWG (UL)
		2.5 - 25	14-4
IEC 60947-7-2			
IEC	UL / CUL	CSA	IEC/ EN 60079-7
-	-	-	-
- / 16	-	- / -	- / 16
16	-	-	4-16
12 - 4	14-4	22-4	12 - 4
Rigid	Flexible	Ferrule	
		without/with plastic sleeve	
2.5 - 25	4 - 16	1.5 - 16	1.5 - 16
1.5 - 6	1.5 - 4	1.5 - 6	-
-	-	-	0.75 - 10
11			
M4 / 1.5 - 1.8			
PE foot with mounting screw, M4 / 1.5 - 1.8			
PA			
V0			

Technical data			
Width	Length	Height NS 35/7,5	
16	53.4	62	
Width	Length	Height NS 32	
16	53.4	-	
		max. Ø [mm ²]	AWG (UL)
		10 - 35	-
IEC 60947-7-2			
IEC	UL / CUL	CSA	IEC/ EN 60079-7
-	-	-	-
- / 35	-	-	-
35	-	-	-
8 - 2	-	-	-
Rigid	Flexible	Ferrule	
		without/with plastic sleeve	
10 - 35	10 - 35	10 - 35	10 - 35
6 - 16	6 - 10	6 - 10	-
-	-	-	6 - 10
16			
M6 / 3.2 - 3.7			
PE foot with mounting screw, M5 / 2.5 - 3			
PA			
V0			

Ordering data		
Type	Order No.	Pcs./Pkt.
USLKG 16 N	0443023	50
USLKG 16 N-1	0443036	50

Ordering data		
Type	Order No.	Pcs./Pkt.
USLKG 35 N	3074143	50

Accessories ¹⁾		
SZS 1,0X4,0 VDE	1205066	10
ZB 12 (see Catalog 3)		

Accessories ¹⁾		
SZS 1,0X6,5 VDE	1205079	10
ZB 16,3 (see Catalog 3)		

Feed-through and ground terminal blocks with three UK 10-PLUS connections



- These twin modular terminal blocks are designed for the basic job of potential branching
- The simple way to connect with very different types of conductors with very different cross sections
- Two independent conductor connections can be used on the switch cabinet side
- Bridgeable in the terminal center, even with feed-through terminal blocks added as neighbors: UK 3-TWIN with UK 3 N, UK 5-TWIN with UK 5 N and UK 10-TWIN and UK 10-PLUS with UK 10 N
- The terminal blocks UK 3-TWIN and UK 5-TWIN have the same shape but different pitch widths
- The UK 10-TWIN has two 10 mm² connection options
- The UK 10-PLUS has one connection for connecting through a 10 mm² supply cable and a 4 mm² tap
- UK 10-TWIN and UK 10-PLUS can also be bridged in the terminal center with the feed-through terminal blocks UK 10 N
- With universal foot for mounting on NS 35 ...or NS 32 ... DIN rails

Notes:

If added to the open side of the UK 3-TWIN and UK 5-TWIN universal terminal blocks UK, the open metal part must be closed with the UK 5-TWIN-DECKELSEGMENT, five of which are supplied with every package.

¹⁾ Tap: 41 A / 6 mm²



2.5 (2.5) mm², 24 A, feed-through terminal block, 3 connections



Dimensions		[mm]
Dimensions		[mm]
Maximum electrical data		
Rated data		
Rated voltage	[V]	400
Nominal current / cross section	[A] / [mm ²]	24 / 2.5
Rated cross section	[mm ²]	2.5
Cross section range	AWG	24 - 14
Connection capacity continuity		
1 conductor	[mm ²]	0.2 - 2.5
2 conductors (of the same type)	[mm ²]	0.2 - 0.5
2 flexible conductors with a TWIN ferrule	[mm ²]	-
Max. cross section with insertion bridge	[mm ²]	2.5
Connection capacity pick-off		
1 conductor	[mm ²]	-
2 conductors (of the same type)	[mm ²]	-
2 flexible conductors with a TWIN ferrule	[mm ²]	-
General data		
Stripping length: Continuity / pick-off	[mm]	8 / -
Continuity: Thread / torque		M3 / 0.5 - 0.6
Pick-off: Thread / torque		- / -
Insulating material		PA
Flammability rating in accordance with UL 94		V2

Technical data			
Width	Length	Height NS 35/7,5	
5.2	50.5	47	
Width	Length	Height NS 32	
5.2	50.5	52	
I _{max} [A]	U _{max} [V]	max. Ø [mm ²]	AWG (UL)
24	400	0.2 - 2.5	30-12
IEC 60947-7-1			
IEC	UL / CUL	CSA	IEC/ EN 60079-7
400	300	300	-
24 / 2.5	10 / -	20 / -	-
2.5	-	-	-
24 - 14	30-12	28-12	-
Connection capacity continuity		Ferrule	
Rigid	Flexible	without/with plastic sleeve	
0.2 - 2.5	0.2 - 2.5	0.25 - 1.5	0.25 - 1
0.2 - 0.5	0.2 - 0.5	0.25 - 0.5	-
-	-	-	0.5 - 0.75
2.5	2.5	-	-
Connection capacity pick-off		Ferrule	
Rigid	Flexible	without/with plastic sleeve	
-	-	-	-
-	-	-	-
-	-	-	-

Description	No. of pos.	Color
Terminal block, with universal foot for reversible mounting on NS 32... or NS 35...		gray
		blue

Cover, width: 2 mm		gray
		blue
Fixed bridge, isolated	10	silver
Insertion bridge, insulated	2	gray
	3	gray
	10	gray
Separating disk, for separation of neighboring bridges, can be fitted later, no loss of pitch		gray
Test socket		silver
Test socket, insulated, can be used only with FBI and ISSBI		silver
Screwdriver		
Lateral groove labeling		

Ordering data			
Type	I _{max}	Order No.	Pcs./Pkt.
UK 3-TWIN		3002225	50
UK 3-TWIN BU		3002416	50

Accessories			
D-UK 5-TWIN		1923034	50
D-UK 5-TWIN BU		1923050	50
FBR1 10-5 N	24 A	2770642	10
EBL 2- 5	24 A	2303145	10
EBL 3- 5	24 A	2303158	10
EBL 10- 5	24 A	2303132	10
TS-K		1302215	50
PSB 3/10/4		0601292	10
PSBJ 3/13/4		0201304	10
SF-SL 0,6X3,5-100 S-VDE		1212587	10
ZB 5 (see Catalog 3)			

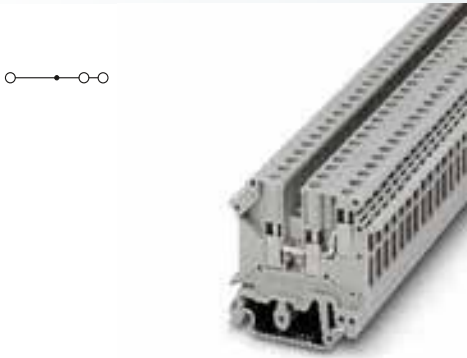

4 (4) mm², 32 A, feed-through terminal block, 3 connections

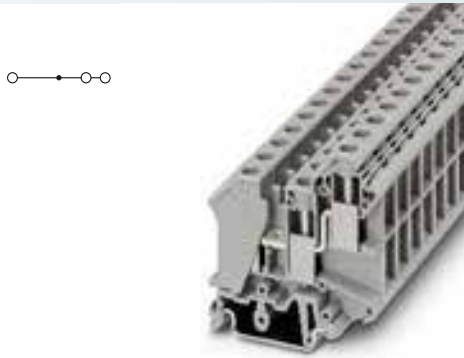

10 (16) mm², 76 A, feed-through terminal block, 3 connections

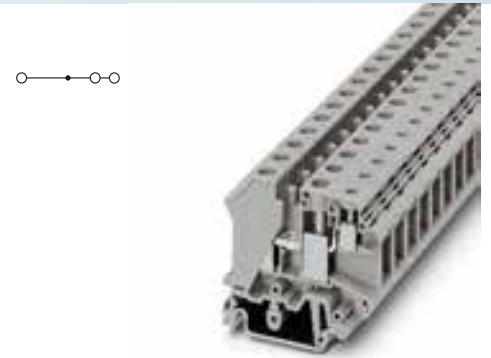

10 (16) mm², 76 A, feed-through terminal block, with tap

UL ENEC EAC KEUR ClassNK CB
Ex: Ex EAC Ex

UL ENEC EAC KEUR CB

UL ENEC EAC

Technical data			
Width	Length	Height NS 35/7,5	
6.2	50.5	47	
Width	Length	Height NS 32	
6.2	50.5	52	
I _{max} [A]	U _{max} [V]	max. Ø [mm ²]	AWG (UL)
32	500	0.2 - 4	30-10
IEC 60947-7-1			
IEC	UL / CUL	CSA	IEC/ EN 60079-7
500	150	300	275
32 / 4	30 / -	30 / -	32
4	-	-	-
24 - 12	30-10	22-10	0,2-4
Rigid	Flexible	Ferrule	
		without/with plastic sleeve	
0.2 - 4	0.2 - 4	0.25 - 4	0.25 - 2.5
0.2 - 1.5	0.2 - 1.5	0.25 - 1.5	-
-	-	-	0.5 - 1.5
4	4	-	-
Rigid	Flexible	Ferrule	
		without/with plastic sleeve	
-	-	-	-
-	-	-	-
-	-	-	-
8 / -			
M3 / 0.6 - 0.8			
- / -			
PA			
V2			

Technical data			
Width	Length	Height NS 35/7,5	
10.2	56.5	59	
Width	Length	Height NS 32	
10.2	56.5	64	
I _{max} [A]	U _{max} [V]	max. Ø [mm ²]	AWG (UL)
76	800	0.5 - 16	24-6
IEC 60947-7-1			
IEC	UL / CUL	CSA	IEC/ EN 60079-7
800	300	600	-
57 / 10	65 / -	65 / -	-
10	-	-	-
20 - 6	24-6	24-6	-
Rigid	Flexible	Ferrule	
		without/with plastic sleeve	
0.5 - 16	0.5 - 10	0.5 - 10	0.5 - 6
0.5 - 4	0.5 - 4	0.5 - 2.5	-
-	-	-	0.5 - 4
-	-	-	-
Rigid	Flexible	Ferrule	
		without/with plastic sleeve	
-	-	-	-
-	-	-	-
-	-	-	-
11 / -			
M4 / 1.5 - 1.8			
- / -			
PA			
V0			

Technical data			
Width	Length	Height NS 35/7,5	
10.2	53	47	
Width	Length	Height NS 32	
10.2	53	52	
I _{max} [A]	U _{max} [V]	max. Ø [mm ²]	AWG (UL)
76 ¹⁾	800	0.5 - 16	24-6
IEC 60947-7-1			
IEC	UL / CUL	CSA	IEC/ EN 60079-7
800	300	600	-
57 / 10	65 / -	65 / -	-
10	-	-	-
20 - 6	24-6	24-6	-
Rigid	Flexible	Ferrule	
		without/with plastic sleeve	
0.5 - 16	0.5 - 10	0.5 - 10	0.5 - 6
0.5 - 4	0.5 - 4	0.5 - 2.5	-
-	-	-	0.5 - 4
-	-	-	-
Rigid	Flexible	Ferrule	
		without/with plastic sleeve	
0.2 - 6	0.2 - 4	0.25 - 4	0.25 - 4
0.2 - 1.5	0.2 - 1.5	0.25 - 1.5	-
-	-	-	0.5 - 1.5
-	-	-	-
11 / 7			
M4 / 1.5 - 1.8			
M3 / 0.6 - 0.8			
PA			
V0			

Ordering data			
Type	I _{max}	Order No.	Pcs./Pkt.
UK 5-TWIN		1923021	50
UK 5-TWIN BU		1923047	50

Ordering data			
Type	I _{max}	Order No.	Pcs./Pkt.
UK 10-TWIN		3005196	50
UK 10-TWIN BU		3005235	50

Ordering data			
Type	I _{max}	Order No.	Pcs./Pkt.
UK 10-PLUS		3001381	50
UK 10-PLUS BU		3001475	50

Accessories			
D-UK 5-TWIN		1923034	50
D-UK 5-TWIN BU		1923050	50
FBI 10- 6	32 A	0203250	10
EB 2- 6	32 A	0201155	100
EB 3- 6	32 A	0201142	100
EB 10- 6	32 A	0201139	10
TS-K		1302215	50
PSB 3/10/4		0601292	10
PSBJ 3/13/4		0201304	10
SF-SL 0,6X3,5-100 S-VDE		1212587	10
ZB 6 (see Catalog 3)			

Accessories			
FBI 10-10	76 A	0203276	10
TS-KK 3		2770215	50
PSB 4/7/6		0303299	10
PSBJ 4/15/6 RD		0303325	10
SZS 1,0X4,0 VDE		1205066	10
ZB 10 (see Catalog 3)			

Accessories			
FBI 10-10	76 A	0203276	10
TS-KK 3		2770215	50
PSB 4/7/6		0303299	10
PSBJ 4/15/6 RD		0303325	10
SZS 1,0X4,0 VDE		1205066	10
ZB 10 (see Catalog 3)			

Terminal blocks – Classic

UK universal modular terminal blocks

Ground terminal blocks with three UK ...-TWIN-PE and UK 10-PLUS-PE connections



- Same shape and pitch as the feed-through terminal blocks
- Universal ground conductor foot for mounting on NS 35 ...- or NS 32 ... DIN rails (with the exception of NS 35/15-2,3)
- LB ... and ISSBI 10-6 bridges can be attached to the neighboring UK, UK-TWIN, and UK-PLUS versions with bridging facility thanks to the housing cutouts in the ground terminal blocks

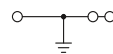

2.5 (2.5) mm², ground terminal block, 3 connections



Dimensions		[mm]	
Dimensions		[mm]	
Maximum electrical data			
Rated data			
Rated voltage	[V]	-	
Nominal current / cross section	[A] / [mm ²]	- / -	
Rated cross section	[mm ²]	2.5	
Cross section range	AWG	24 - 14	
Connection capacity continuity			
1 conductor	[mm ²]	0.2 - 2.5	0.2 - 2.5
2 conductors (of the same type)	[mm ²]	-	-
2 flexible conductors with a TWIN ferrule	[mm ²]	-	-
Connection capacity pick-off			
1 conductor	[mm ²]	-	-
2 conductors (of the same type)	[mm ²]	-	-
2 flexible conductors with a TWIN ferrule	[mm ²]	-	-
General data			
Stripping length: Continuity / pick-off	[mm]	8 / -	
Continuity: Thread / torque		M3 / 0.5 - 0.6	
Pick-off: Thread / torque		- / -	
Mounting: Thread / torque	- / [Nm]	PE foot with mounting screw, M2.5 / 0.5 - 0.6	
Insulating material		PA	
Flammability rating in accordance with UL 94		V0	

Technical data			
Width	Length	Height NS 35/7,5	
5.2	50.5	47	
Width	Length	Height NS 32	
5.2	50.5	52	
Maximum electrical data		max. Ø [mm ²]	AWG (UL)
		0.2 - 2.5	30-12
IEC 60947-7-2			
IEC	UL / CUL	CSA	IEC/ EN 60079-7

Description	Color
Ground terminal block, for mounting on NS 32... or NS 35...	green-yellow

Ordering data		
Type	Order No.	Pcs./Pkt.
UK 3-TWIN-PE	1923128	50

Screwdriver
Lateral groove labeling

Accessories		
SF-SL 0,6X3,5-100 S-VDE	1212587	10
ZB 5 (see Catalog 3)		

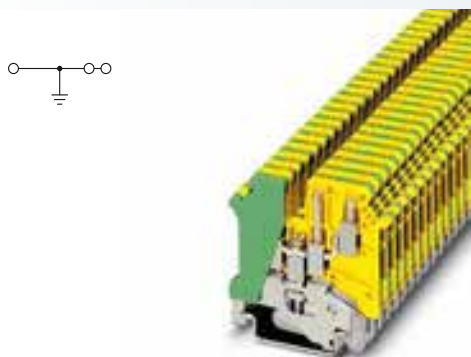

4 (4) mm², ground terminal block, 3 connections

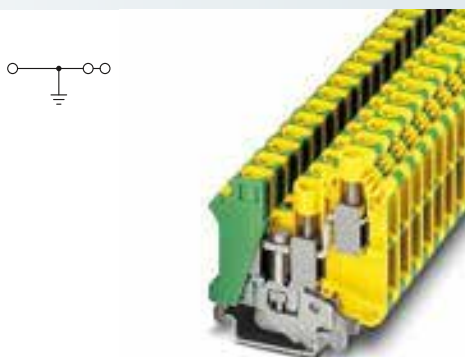

10 (16) mm², 76 A, ground terminal block, 3 connections

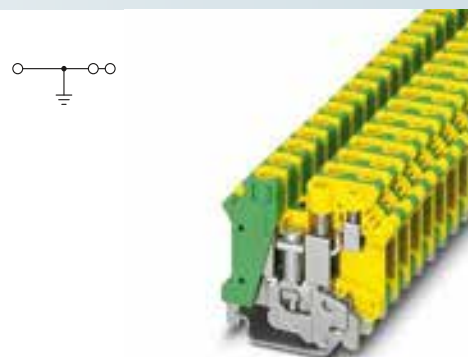

10 (16) mm², 76 A, ground terminal block, with tap and PE foot



Technical data			
Width	Length	Height NS 35/7,5	
6.2	50.5	47	
Width	Length	Height NS 32	
6.2	50.5	52	
		max. Ø [mm ²]	AWG (UL)
		0.2 - 4	30-10
IEC 60947-7-2			
IEC	UL / CUL	CSA	IEC/ EN 60079-7
-	-	-	-
- / -	-	-	-
4	-	-	-
24 - 12	30-10	-	-
Rigid	Flexible	Ferrule without/with plastic sleeve	
0.2 - 4	0.2 - 4	0.25 - 4	0.25 - 2.5
-	-	-	-
-	-	-	-
Rigid	Flexible	Ferrule without/with plastic sleeve	
-	-	-	-
-	-	-	-
-	-	-	-
8 / -			
M3 / 0.6 - 0.8			
- / -			
PE foot with mounting screw, M3 / 0.6 - 0.8			
PA			
V2			

Technical data			
Width	Length	Height NS 35/7,5	
10.2	56.5	59	
Width	Length	Height NS 32	
10.2	56.5	64	
		max. Ø [mm ²]	AWG (UL)
		0.5 - 16	24-6
IEC 60947-7-2			
IEC	UL / CUL	CSA	IEC/ EN 60079-7
-	-	-	-
- / 10	-	- / -	-
10	-	-	-
20 - 6	24-6	24-6	-
Rigid	Flexible	Ferrule without/with plastic sleeve	
0.5 - 16	0.5 - 10	0.5 - 10	0.5 - 6
-	-	-	-
-	-	-	-
Rigid	Flexible	Ferrule without/with plastic sleeve	
-	-	-	-
-	-	-	-
-	-	-	-
11 / -			
M4 / 1.5 - 1.8			
- / -			
PE foot with mounting screw, M4 / 1.5 - 1.8			
PA			
V0			

Technical data			
Width	Length	Height NS 35/7,5	
10.2	53	47	
Width	Length	Height NS 32	
10.2	53	52	
		max. Ø [mm ²]	AWG (UL)
		0.5 - 16	24-6
IEC 60947-7-2			
IEC	UL / CUL	CSA	IEC/ EN 60079-7
-	-	-	-
- / 10	-	- / -	-
10	-	-	-
20 - 6	24-6	24-6	-
Rigid	Flexible	Ferrule without/with plastic sleeve	
0.5 - 16	0.5 - 10	0.5 - 10	0.5 - 6
-	-	-	-
-	-	-	-
Rigid	Flexible	Ferrule without/with plastic sleeve	
0.2 - 6	0.2 - 4	0.25 - 4	0.25 - 4
-	-	-	-
-	-	-	-
11 / 7			
M4 / 1.5 - 1.8			
M3 / 0.6 - 0.8			
PE foot with mounting screw, M4 / 1.5 - 1.8			
PA			
V0			

Ordering data		
Type	Order No.	Pcs./Pkt.
UK 5-TWIN-PE	1923076	50

Ordering data		
Type	Order No.	Pcs./Pkt.
UK 10-TWIN-PE	3001433	50

Ordering data		
Type	Order No.	Pcs./Pkt.
UK 10-PLUS-PE	3001420	50

Accessories		
SF-SL 0,6X3,5-100 S-VDE	1212587	10
ZB 6 (see Catalog 3)		

Accessories		
SZS 1,0X4,0 VDE	1205066	10
ZB 10 (see Catalog 3)		

Accessories		
SZS 1,0X4,0 VDE	1205066	10
ZB 10 (see Catalog 3)		

Terminal blocks – Classic

UK universal modular terminal blocks

Feed-through and PE terminal blocks with four UDK ... connections

- Two connection points on each side to accommodate several conductors
- Double bridge shaft enables individual potential distribution and supply
- Design width 5.2 mm or 6.2 mm
- UDK 3 and UDK 4 are of the same shape

Ground terminal block UDK ...-PE

- Same shape and pitch as the feed-through terminal blocks
- The ISSBI 10-6 bridge can be attached to the neighboring UDK 4 versions with bridging facility thanks to the housing cutouts in the ground terminal blocks
- Universal ground conductor foot for mounting on NS 35 ...- or NS 32 ... DIN rails (with the exception of NS 35/15-2,3)

PROJECT complete planning enables the quick and convenient planning and configuration of error-free terminal strips.



2.5 (4) mm², 32 A, feed-through terminal block, 4 connections



Dimensions		[mm]	
Dimensions		[mm]	
Maximum electrical data			
Rated data			
Rated voltage	[V]	500	300
Nominal current / cross section	[A] / [mm ²]	24 / 2.5	20 / -
Rated cross section	[mm ²]	2.5	-
Cross section range	AWG	24 - 12	30-12
Connection capacity			
1 conductor	[mm ²]	0.2 - 4	0.2 - 2.5
2 conductors (of the same type)	[mm ²]	0.2 - 1	0.2 - 1.5
2 flexible conductors with a TWIN ferrule	[mm ²]	-	-
Max. cross section with insertion bridge	[mm ²]	2.5	2.5
General data			
Stripping length	[mm]	8	
Terminal point: Thread / torque	- / [Nm]	M3 / 0.5 - 0.6	
Mounting: Thread / torque	- / [Nm]	- / -	
Insulating material		PA	
Flammability rating in accordance with UL 94		V2	

Technical data				
Width	Length	Height NS 35/7,5		
5.2	63.5	47		
Width	Length	Height NS 32		
5.2	63.5	52		
I _{max} [A]	U _{max} [V]	max. Ø [mm ²]	AWG (UL)	
32	500	0.2 - 4	30-12	
IEC 60947-7-1				
IEC	UL / CUL	CSA	IEC/ EN 60079-7	
Rated voltage	[V]	500	300	-
Nominal current / cross section	[A] / [mm ²]	24 / 2.5	20 / -	-
Rated cross section	[mm ²]	2.5	-	-
Cross section range	AWG	24 - 12	30-12	-
Connection capacity				
		Rigid	Flexible	Ferrule without/with plastic sleeve
1 conductor	[mm ²]	0.2 - 4	0.2 - 2.5	0.25 - 2.5 / 0.25 - 1.5
2 conductors (of the same type)	[mm ²]	0.2 - 1	0.2 - 1.5	0.25 - 1.5 / -
2 flexible conductors with a TWIN ferrule	[mm ²]	-	-	- / 0.5 - 1
Max. cross section with insertion bridge	[mm ²]	2.5	2.5	- / -
General data				
Stripping length	[mm]	8		
Terminal point: Thread / torque	- / [Nm]	M3 / 0.5 - 0.6		
Mounting: Thread / torque	- / [Nm]	- / -		
Insulating material		PA		
Flammability rating in accordance with UL 94		V2		

Description	No. of pos.	Color
Terminal block, for mounting on NS 32... or NS 35...		gray
		blue
Ground terminal block, for mounting on NS 32... or NS 35...		green-yellow

Ordering data			
Type	I _{max}	Order No.	Pcs./Pkt.
UDK 3		2775375	50
UDK 3 BU		2718277	50

Cover, width: 1.5 mm			gray	blue
Fixed bridge, for cross connections in the terminal center, screw heads with insulation collar				
	2	silver		
	3	silver		
	4	silver		
	10	silver		
Insertion bridge, insulated				
	2	gray		
	3	gray		
	10	gray		
Switch bar for 2 terminal blocks, complete, to increase insulation an end cover must be interposed				
	2	silver		
Isolator bridge bar, divisible, with 10 screws, for switchable branches with IS-K...				
	10	silver		
Bridge bar isolator, as distance piece for isolator bridge bar				
		gray		
Separating disk, for separation of neighboring bridges, can be fitted later, no loss of pitch				
		gray		
Screwdriver				
Lateral groove labeling				

Accessories				
Type	I _{max}	Order No.	Pcs./Pkt.	
D-UDK 4		2775113	50	
D-UDK 4 BU		2775197	50	
FBRI 2-5 N	26 A	3000227	10	
FBRI 3-5 N	26 A	3000201	10	
FBRI 4-5 N	26 A	3000191	10	
FBRI 10-5 N	26 A	2770642	10	
EBL 2- 5	26 A	2303145	10	
EBL 3- 5	26 A	2303158	10	
EBL 10- 5	26 A	2303132	10	
TS-KK 3		2770215	50	
SF-SL 0,6X3,5-100 S-VDE		1212587	10	
ZB 5 (see Catalog 3)				



4 (6) mm², 32 A, feed-through terminal block, 4 connections

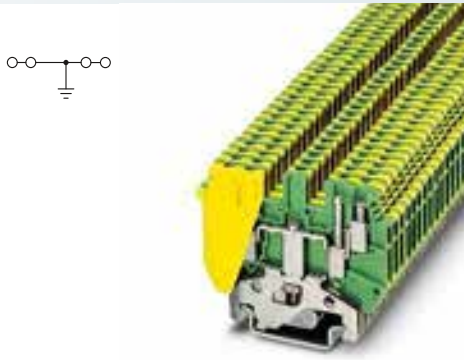

2.5 (4) mm², ground terminal block, 4 connections

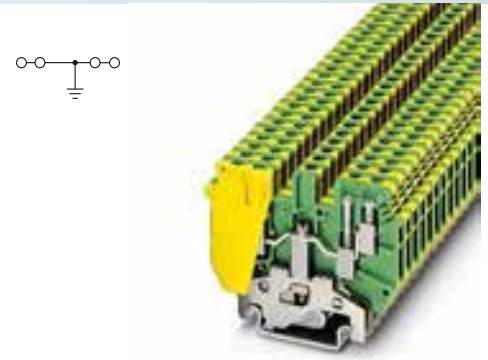

4 (6) mm², ground terminal block, 4 connections



Technical data			
Width	Length	Height NS 35/7,5	
6.2	63.5	47	
Width	Length	Height NS 32	
6.2	63.5	52	
I_{max} [A]	U_{max} [V]	max. Ø [mm ²]	AWG (UL)
32	630	0.2 - 6	30-10
IEC 60947-7-1			
IEC	UL / CUL	CSA	IEC/ EN 60079-7
630	600	600	-
32 / 4	30 / -	25 / -	-
4	-	-	-
24 - 10	30-10	22-10	-
Rigid	Flexible	Ferrule without/with plastic sleeve	
0.2 - 6	0.2 - 4	0.25 - 4	0.25 - 1.5
0.2 - 1	0.2 - 1.5	0.25 - 1.5	-
-	-	-	0.5 - 1
2.5	2.5	-	-
8			
M3 / 0.5 - 0.6			
- / -			
PA			
V2			

Technical data			
Width	Length	Height NS 35/7,5	
5.2	63.5	47	
Width	Length	Height NS 32	
5.2	63.5	52	
I_{max} [A]	U_{max} [V]	max. Ø [mm ²]	AWG (UL)
-	-	0.2 - 4	30-12
IEC 60947-7-2			
IEC	UL / CUL	CSA	IEC/ EN 60079-7
-	-	-	-
- / -	-	-	-
2.5	-	-	-
24 - 12	30-12	-	-
Rigid	Flexible	Ferrule without/with plastic sleeve	
0.2 - 4	0.2 - 2.5	0.25 - 2.5	0.25 - 1.5
-	-	-	-
-	-	-	-
-	-	-	-
8			
M3 / 0.5 - 0.6			
PE foot with mounting screw, M2.5 / 0.5 - 0.6			
PA			
V2			

Technical data			
Width	Length	Height NS 35/7,5	
6.2	63.5	47	
Width	Length	Height NS 32	
6.2	63.5	52	
I_{max} [A]	U_{max} [V]	max. Ø [mm ²]	AWG (UL)
-	-	0.2 - 6	22-10
IEC 60947-7-2			
IEC	UL / CUL	CSA	IEC/ EN 60079-7
-	-	-	-
- / -	-	- / -	-
4	-	-	-
24 - 10	22-10	22-10	-
Rigid	Flexible	Ferrule without/with plastic sleeve	
0.2 - 6	0.2 - 4	0.25 - 4	0.25 - 1.5
-	-	-	-
-	-	-	-
-	-	-	-
8			
M3 / 0.5 - 0.6			
PE foot with mounting screw, M3 / 0.6 - 0.8			
PA			
V2			

Ordering data			
Type	I_{max}	Order No.	Pcs./Pkt.
UDK 4		2775016	50
UDK 4 BU		2775090	50

Ordering data			
Type		Order No.	Pcs./Pkt.
UDK 3-PE		2775456	50

Ordering data			
Type		Order No.	Pcs./Pkt.
UDK 4-PE		2775184	50

Accessories			
D-UDK 4		2775113	50
D-UDK 4 BU		2775197	50
FBI 10- 6	32 A	0203250	10
EB 2- 6	26 A	0201155	100
EB 3- 6	26 A	0201142	100
EB 10- 6	26 A	0201139	10
USBR 2-7	24 A	2303239	1
ISSBI 10- 6	32 A	0301505	10
IS-K 4		1302338	100
TS-KK 3		2770215	50
SF-SL 0,6X3,5-100 S-VDE		1212587	10
ZB 6 (see Catalog 3)			

Accessories			
SF-SL 0,6X3,5-100 S-VDE		1212587	10
ZB 5 (see Catalog 3)			

Accessories			
SF-SL 0,6X3,5-100 S-VDE		1212587	10
ZB 6 (see Catalog 3)			

Terminal blocks – Classic

UK universal modular terminal blocks

Double-level terminal blocks UKK ...

- Compact double-level terminal blocks in nominal cross sections of 2.5 and 4 mm²
- One or two bridge shafts
- Large-surface marking options
- Even if fully wired, the level offset offers unobstructed access to the lower connection level

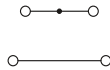

2.5 (4) mm², 32 A, double-level terminal block

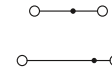

2.5 (4) mm², 32 A, double-level terminal block, both levels can be bridged



Dimensions		Technical data	
Dimensions	[mm]	Width	Length
Dimensions	[mm]	Width	Length
Maximum electrical data		I _{max} [A]	U _{max} [V]
Rated data		max. Ø [mm ²]	AWG (UL)
Rated voltage	[V]	IEC 60947-7-1	
Nominal current / cross section	[A] / [mm ²]	IEC	UL / CUL
Rated cross section	[mm ²]	CSA	IEC/ EN 60079-7
Cross section range	AWG	IEC 60947-7-1	
Connection capacity		Rigid	Flexible
1 conductor	[mm ²]	without/with plastic sleeve	
2 conductors (of the same type)	[mm ²]	0.2 - 4	0.2 - 2.5
2 flexible conductors with a TWIN ferrule	[mm ²]	0.2 - 1	0.2 - 1.5
Max. cross section with insertion bridge	[mm ²]	-	-
General data		2.5	2.5
Stripping length	[mm]	Ferrule	
Screw thread		without/with plastic sleeve	
Tightening torque	[Nm]	0.2 - 4	0.25 - 2.5
Insulating material		0.2 - 1	0.25 - 1.5
Flammability rating in accordance with UL 94		-	0.5 - 1
		2.5	2.5

Dimensions		Technical data	
Dimensions	[mm]	Width	Length
Dimensions	[mm]	Width	Length
Maximum electrical data		I _{max} [A]	U _{max} [V]
Rated data		max. Ø [mm ²]	AWG (UL)
Rated voltage	[V]	IEC 60947-7-1	
Nominal current / cross section	[A] / [mm ²]	IEC	UL / CUL
Rated cross section	[mm ²]	CSA	IEC/ EN 60079-7
Cross section range	AWG	IEC 60947-7-1	
Connection capacity		Rigid	Flexible
1 conductor	[mm ²]	without/with plastic sleeve	
2 conductors (of the same type)	[mm ²]	0.2 - 4	0.2 - 2.5
2 flexible conductors with a TWIN ferrule	[mm ²]	0.2 - 1	0.2 - 1.5
Max. cross section with insertion bridge	[mm ²]	-	-
General data		2.5	2.5
Stripping length	[mm]	Ferrule	
Screw thread		without/with plastic sleeve	
Tightening torque	[Nm]	0.2 - 4	0.25 - 2.5
Insulating material		0.2 - 1	0.25 - 1.5
Flammability rating in accordance with UL 94		-	0.5 - 1
		2.5	2.5

Description			Ordering data			
Description	No. of pos.	Color	Type	I _{max}	Order No.	Pcs./Pkt.
Double-level terminal block, for mounting on NS 35... and NS 32...		gray	UKK 3		2770011	50
Double-level terminal block, for mounting on NS 35... and NS 32..., with equipotential bonding between the levels		blue gray	UKK 3 BU		2770095	50

Description			Ordering data			
Description	No. of pos.	Color	Type	I _{max}	Order No.	Pcs./Pkt.
Double-level terminal block, for mounting on NS 35... and NS 32...		gray	UKKB 3		2771010	50
Double-level terminal block, for mounting on NS 35... and NS 32..., with equipotential bonding between the levels		blue gray	UKKB 3 BU		2771094	50

Accessories			Accessories			
Accessories	No. of pos.	Color	Accessories	No. of pos.	Color	Accessories
Cover, width: 2.5 mm		gray blue	D-UKK 3/5			D-UKKB 3/5
Spacer plate, compensates for level offsets, width: 2.5 mm		gray	D-UKK 3/5 BU			D-UKKB 3/5 BU
Fixed bridge, isolated	2 3 4 10	silver silver silver silver	DP-UKK 3/5			DP-UKKB 3/5
Insertion bridge, insulated	2 3 10	gray gray gray	FBRNI 2-5 N	28 A	3000175	FBRNI 2-5 N
Isolator bridge bar, divisible, with 10 screws, for switchable branches with IS-K...	10	silver	FBRNI 3-5 N	28 A	3000162	FBRNI 3-5 N
Bridge bar isolator, as distance piece for isolator bridge bar		gray	FBRNI 4-5 N	28 A	3000159	FBRNI 4-5 N
Separating disk, for separation of neighboring bridges, can be fitted later, no loss of pitch		gray	FBRNI 10-5 N	28 A	2770639	FBRNI 10-5 N
Partition plate, 2.5 mm wide		gray	EBL 10-5	22 A	2303132	EBL 10-5
Screwdriver			TS-KK 3		2770215	TS-KK 3
Lateral groove labeling			ATP-UKK 3/5		2778521	ATP-UKKB 3
			SF-SL 0,6X3,5-100 S-VDE		1212587	SF-SL 0,6X3,5-100 S-VDE

Accessories			Accessories			
Accessories	No. of pos.	Color	Accessories	No. of pos.	Color	Accessories
Cover, width: 2.5 mm		gray blue	D-UKKB 3/5			D-UKKB 3/5
Spacer plate, compensates for level offsets, width: 2.5 mm		gray	D-UKKB 3/5 BU			D-UKKB 3/5 BU
Fixed bridge, isolated	2 3 4 10	silver silver silver silver	DP-UKKB 3/5			DP-UKKB 3/5
Insertion bridge, insulated	2 3 10	gray gray gray	FBRNI 2-5 N	28 A	3000175	FBRNI 2-5 N
Isolator bridge bar, divisible, with 10 screws, for switchable branches with IS-K...	10	silver	FBRNI 3-5 N	28 A	3000162	FBRNI 3-5 N
Bridge bar isolator, as distance piece for isolator bridge bar		gray	FBRNI 4-5 N	28 A	3000159	FBRNI 4-5 N
Separating disk, for separation of neighboring bridges, can be fitted later, no loss of pitch		gray	FBRNI 10-5 N	28 A	2770639	FBRNI 10-5 N
Partition plate, 2.5 mm wide		gray	EBL 10-5	22 A	2303132	EBL 10-5
Screwdriver			TS-KK 3		2770215	TS-KK 3
Lateral groove labeling			ATP-UKKB 3		2771065	ATP-UKKB 3
			SF-SL 0,6X3,5-100 S-VDE		1212587	SF-SL 0,6X3,5-100 S-VDE

UK universal modular terminal blocks

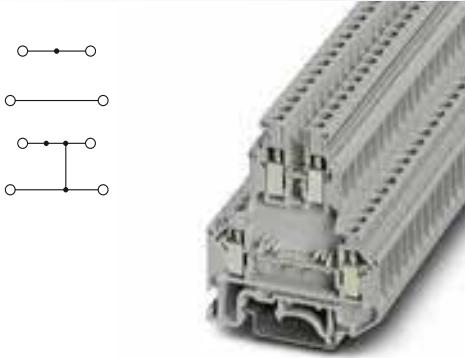

4 (4) mm², 32 A, double-level terminal block

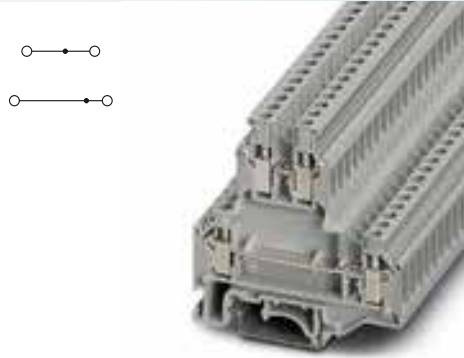

4 (4) mm², 32 A, double-level terminal block, both levels can be bridged

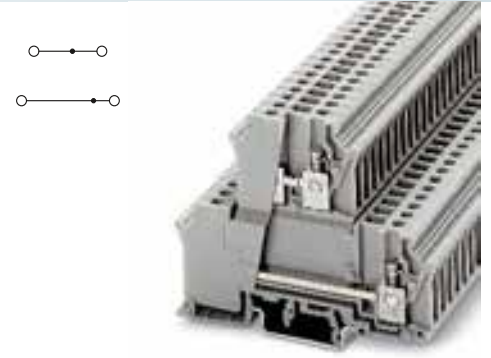

4 (4) mm², 32 A, 800 V, double-level terminal block, both levels can be bridged



Technical data			
Width	Length	Height NS 35/7,5	
6.2	56	62	
Width	Length	Height NS 32	
6.2	56	67	
I_{max} [A]	U_{max} [V]	max. Ø [mm ²]	AWG (UL)
32	500	0.2 - 4	26-10
IEC 60947-7-1			
IEC	UL / CUL	CSA	IEC/EN 60079-7
500	600	300	-
32 / 4	30 / -	30 / -	-
4	-	-	-
24 - 12	26-10	28-10	-
Rigid	Flexible	Ferrule without/with plastic sleeve	
0.2 - 4	0.2 - 4	0.25 - 4	0.25 - 2.5
0.2 - 1.5	0.2 - 1.5	0.25 - 1.5	-
-	-	-	0.5 - 1.5
4	2.5	-	-
8			
M3			
0.6 - 0.8			
PA			
V0			

Technical data			
Width	Length	Height NS 35/7,5	
6.2	67	62	
Width	Length	Height NS 32	
6.2	67	67	
I_{max} [A]	U_{max} [V]	max. Ø [mm ²]	AWG (UL)
32	500	0.2 - 4	26-10
IEC 60947-7-1			
IEC	UL / CUL	CSA	IEC/EN 60079-7
500	600	300	-
32 / 4	30 / -	25 / -	-
4	-	-	-
24 - 12	26-10	28-10	-
Rigid	Flexible	Ferrule without/with plastic sleeve	
0.2 - 4	0.2 - 4	0.25 - 4	0.25 - 2.5
0.2 - 1.5	0.2 - 1.5	0.25 - 1.5	-
-	-	-	0.5 - 1.5
4	2.5	-	-
8			
M3			
0.6 - 0.8			
PA			
V0			

Technical data			
Width	Length	Height NS 35/7,5	
6.2	84.5	64	
Width	Length	Height NS 32	
6.2	84.5	69	
I_{max} [A]	U_{max} [V]	max. Ø [mm ²]	AWG (UL)
32	800	0.2 - 4	28-12
IEC 60947-7-1			
IEC	UL / CUL	CSA	IEC/EN 60079-7
800	600	-	750
32 / 4	20 / -	-	27
4	-	-	-
24 - 12	28-12	-	0.2-4
Rigid	Flexible	Ferrule without/with plastic sleeve	
0.2 - 4	0.2 - 4	0.25 - 4	0.25 - 2.5
0.2 - 2.5	0.2 - 2.5	0.25 - 2.5	-
-	-	-	0.5 - 1.5
4	2.5	-	-
8			
M3			
0.6 - 0.8			
PA			
V2			

Ordering data			
Type	I_{max}	Order No.	Pcs./Pkt.
UKK 5		2774017	50
UKK 5 BU		2774091	50
UKK 5-PV		2791388	50

Ordering data			
Type	I_{max}	Order No.	Pcs./Pkt.
UKKB 5		2771146	50
UKKB 5 BU		3216053	50

Ordering data			
Type	I_{max}	Order No.	Pcs./Pkt.
UXKK 4		2780014	50

Accessories			
D-UKK 3/5		2770024	50
D-UKK 3/5 BU		2770105	50
DP-UKK 3/5		2770794	50
FBI 10- 6	32 A	0203250	10
EB 2- 6	28 A	0201155	100
EB 3- 6	28 A	0201142	100
EB 10- 6	28 A	0201139	10
ISSBI 10- 6	24 A	0301505	10
IS-K 4		1302338	100
TS-KK 3		2770215	50
ATP-UKK 3/5		2778521	50
SF-SL 0,6X3,5-100 S-VDE		1212587	10

Accessories			
D-UKKB 3/5		2771023	50
D-UKKB 3/5 BU		2771104	50
DP-UKKB 3/ 5		2770804	50
FBI 10- 6	32 A	0203250	10
EB 2- 6	28 A	0201155	100
EB 3- 6	28 A	0201142	100
EB 10- 6	28 A	0201139	10
ISSBI 10- 6	24 A	0301505	10
IS-K 4		1302338	100
TS-KK 3		2770215	50
ATP-UKKB 3		2771065	50
SF-SL 0,6X3,5-100 S-VDE		1212587	10

Accessories			
FBI 10- 6	24 A	0203250	10

ZB 6 (see Catalog 3)

ZB 6 (see Catalog 3)

ZB 6 (see Catalog 3)

Terminal blocks – Classic

UK universal modular terminal blocks

Double-level terminal blocks UKKB 10 ...

- Can be bridged on both levels for all potential distribution tasks
- Design width of just 10.2 mm
- One of the special features of the UKKB 10/2,5 is that it allows two 2.5 mm² conductors to be connected in the upper level

Notes:
UKKB 10-PV: 70 A / 500 V

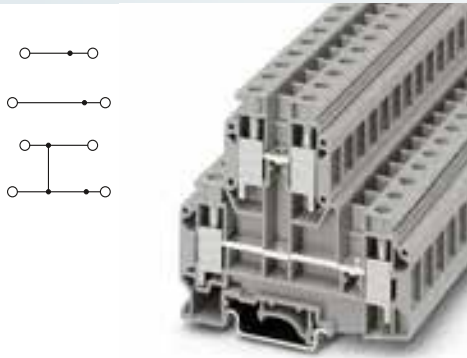

10 (16) mm², 76 A, double-level terminal block

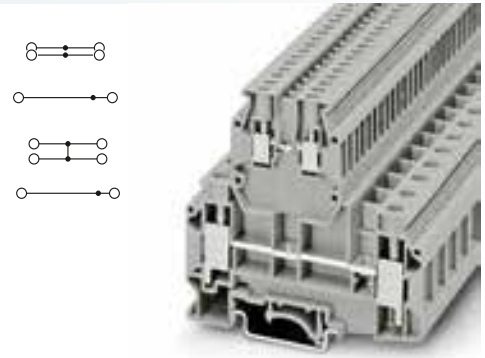

10 (16) mm², 76 A, double-level terminal block, upper level with 2 x 2.5 mm² feed-through terminal blocks



Dimensions		[mm]
Dimensions		[mm]
Maximum electrical data		
Rated data lower level		
Rated voltage	[V]	500
Nominal current / cross section	[A] / [mm ²]	57 / 10
Rated cross section	[mm ²]	10
Cross section range	AWG	20 - 6
Connection capacity, lower level		
1 conductor	[mm ²]	0.5 - 16
2 conductors (of the same type)	[mm ²]	0.5 - 6
2 flexible conductors with a TWIN ferrule	[mm ²]	0.5 - 4
Rated data, upper level		
Rated voltage	[V]	500
Nominal current / cross section	[A] / [mm ²]	57 / 10
Rated cross section	[mm ²]	10
Cross section range	AWG	20 - 6
Connection capacity, upper level		
1 conductor	[mm ²]	0.5 - 16
2 conductors (of the same type)	[mm ²]	0.5 - 6
Two conductors with a TWIN ferrule	[mm ²]	0.5 - 4
General data		
Stripping length, lower / upper level	[mm]	11 / 11
Thread, lower / upper level		M4 / M4
Tightening torque, lower / upper level	[Nm]	1.5 - 1.8 / 1.5 - 1.8
Insulating material		PA
Flammability rating in accordance with UL 94		V0

Technical data			
Width	Length	Height NS 35/7,5	
10.2	77.5	73	
Width	Length	Height NS 32	
10.2	77.5	78	
I _{max} [A]	U _{max} [V]	max. Ø [mm ²]	AWG (UL)
76	500	0.5 - 16	24-6
IEC 60947-7-1			
IEC	UL / CUL	CSA	IEC/ EN 60079-7
500	600	300	-
57 / 10	65 / -	65 / -	-
10	-	-	-
20 - 6	24-6	24-6	-
Rigid		Flexible	Ferrule without/with plastic sleeve
0.5 - 16	0.5 - 10	0.5 - 10	0.5 - 6
0.5 - 6	0.5 - 4	0.5 - 6	-
IEC 60947-7-1			
IEC	UL / CUL	CSA	IEC/ EN 60079-7
500	600	300	-
57 / 10	65 / -	65 / -	-
10	-	-	-
20 - 6	24-6	24-6	-
Rigid		Flexible	Ferrule without/with plastic sleeve
0.5 - 16	0.5 - 10	0.5 - 10	0.5 - 6
0.5 - 6	0.5 - 4	0.5 - 6	-
IEC 60947-7-1			
IEC	UL / CUL	CSA	IEC/ EN 60079-7
500	600	300	-
24 / 2.5	20 / -	20 / -	-
10	-	-	-
24 - 12	30-12	28-12	-
Rigid		Flexible	Ferrule without/with plastic sleeve
0.2 - 4	0.2 - 2.5	0.25 - 2.5	0.25 - 1.5
0.2 - 1.5	0.2 - 1.5	0.25 - 1	-
0.5 - 1.5			

Technical data			
Width	Length	Height NS 35/7,5	
10.2	77.5	73	
Width	Length	Height NS 32	
10.2	77.5	78	
I _{max} [A]	U _{max} [V]	max. Ø [mm ²]	AWG (UL)
76	500	0.5 - 16	24-6
IEC 60947-7-1			
IEC	UL / CUL	CSA	IEC/ EN 60079-7
500	600	300	-
57 / 10	65 / -	65 / -	-
10	-	-	-
20 - 6	24-6	24-6	-
Rigid		Flexible	Ferrule without/with plastic sleeve
0.5 - 16	0.5 - 10	0.5 - 10	0.5 - 6
0.5 - 6	0.5 - 4	0.5 - 6	-
IEC 60947-7-1			
IEC	UL / CUL	CSA	IEC/ EN 60079-7
500	600	300	-
24 / 2.5	20 / -	20 / -	-
10	-	-	-
24 - 12	30-12	28-12	-
Rigid		Flexible	Ferrule without/with plastic sleeve
0.2 - 4	0.2 - 2.5	0.25 - 2.5	0.25 - 1.5
0.2 - 1.5	0.2 - 1.5	0.25 - 1	-
0.5 - 1.5			
Stripping length, lower / upper level		[mm]	11 / 8
Thread, lower / upper level			M4 / M3
Tightening torque, lower / upper level		[Nm]	1.2 - 1.8 / 0.5 - 0.8
Insulating material			PA
Flammability rating in accordance with UL 94			V0

Description	No. of pos.	Color
Terminal block, for mounting on NS 32... or NS 35...		gray
Terminal block, with equipotential bond, for mounting on NS 32 ... or NS 35...		gray

Ordering data			
Type	I _{max}	Order No.	Pcs./Pkt.
UKKB 10		2772077	50
UKKB 10-PV		3003567	50

Ordering data			
Type	I _{max}	Order No.	Pcs./Pkt.
UKKB 10/2,5		2771007	50
UKKB 10/2,5-PV		2775485	50

Accessories		
Cover, width: 1.5 mm		gray
Fixed bridge, isolated	10	silver
Fixed bridge, for cross connections in the terminal center, screw heads with insulating collar, divisible, with 10 screws	10	silver
Chain bridge, with screw	1	silver
Isolator bridge bar, divisible, with 10 screws, for switchable branches with IS-K...	10	silver
Bridge bar isolator, as distance piece for isolator bridge bar		gray
Screwdriver		
Labeling for upper level		
Labeling for lower level		

Accessories			
D-UKKB 10	I _{max}	Order No.	Pcs./Pkt.
D-UKKB 10		3001394	50
FBI 10-10	70 A	0203276	10
KB- 10	70 A	0203205	100
ISSBI 10-10	38 A	0301521	10
IS-K 10		1303337	100
SZS 1,0X4,0 VDE		1205066	10
ZB 10 (see Catalog 3)			
ZB 10 (see Catalog 3)			

Accessories			
D-UKKB 10	I _{max}	Order No.	Pcs./Pkt.
D-UKKB 10		3001394	50
FBRI 10-5 N	26 A	2770642	10
FBI 10-10	70 A	0203276	10
KB- 10	70 A	0203205	100
ISSBI 10-10	38 A	0301521	10
IS-K 10		1303337	100
SZS 1,0X4,0 VDE		1205066	10
ZB 5 (see Catalog 3)			
ZB 10 (see Catalog 3)			

**Double-level ground terminal blocks
UKK 5-PE and UKKB 5-PE**

- Same shape and pitch as the feed-through terminal blocks
- Even if fully wired, the level offset offers unobstructed access to the lower connection level
- Universal ground conductor foot for mounting on NS 35 ...- or NS 32 ... DIN rails (with the exception of NS 35/15-2,3)

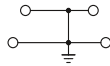

4 (4) mm², double-level ground terminal block

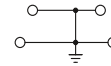

4 (4) mm², double-level ground terminal block



Technical data				
Dimensions	Width	Length	Height NS 35/7,5	
	6.2	56	62	
Dimensions	Width	Length	Height NS 32	
	6.2	56	67	
Maximum electrical data			max. Ø [mm ²]	AWG (UL)
			0.2 - 4	24-10
Rated data	IEC 60947-7-2			
	IEC	UL / CUL	CSA	IEC/ EN 60079-7
Rated voltage [V]	-	-	-	-
Nominal current / cross section [A] / [mm ²]	- / -	-	- / -	-
Rated cross section [mm ²]	4	-	-	-
Cross section range AWG	24 - 12	24-10	28-10	-
Connection capacity	Rigid	Flexible	Ferrule without/with plastic sleeve	
1 conductor [mm ²]	0.2 - 4	0.2 - 4	0.25 - 4	0.25 - 2.5
2 conductors (of the same type) [mm ²]	-	-	-	-
2 flexible conductors with a TWIN ferrule [mm ²]	-	-	-	-
General data				
Stripping length [mm]	8			
Terminal point: Thread / torque	M3 / 0.6 - 0.8			
Mounting: Thread / torque	PE foot with mounting screw, M3 / 0.6 - 0.8			
Insulating material	PA			
Flammability rating in accordance with UL 94	V2			

Ordering data		
Type	Order No.	Pcs./Pkt.
UKK 5-PE	2774211	50

Accessories		
	Order No.	
SF-SL 0,6X3,5-100 S-VDE	1212587	10
ZB 6 (see Catalog 3)		



Technical data				
Dimensions	Width	Length	Height NS 35/7,5	
	6.2	67	62	
Dimensions	Width	Length	Height NS 32	
	6.2	67	67	
Maximum electrical data			max. Ø [mm ²]	AWG (UL)
			0.2 - 4	24-10
Rated data	IEC 60947-7-2			
	IEC	UL / CUL	CSA	IEC/ EN 60079-7
Rated voltage [V]	-	-	-	-
Nominal current / cross section [A] / [mm ²]	- / -	-	- / -	-
Rated cross section [mm ²]	4	-	-	-
Cross section range AWG	24 - 12	24-10	28-10	-
Connection capacity	Rigid	Flexible	Ferrule without/with plastic sleeve	
1 conductor [mm ²]	0.2 - 4	0.2 - 4	0.25 - 4	0.25 - 2.5
2 conductors (of the same type) [mm ²]	-	-	-	-
2 flexible conductors with a TWIN ferrule [mm ²]	-	-	-	-
General data				
Stripping length [mm]	8			
Terminal point: Thread / torque	M3 / 0.6 - 0.8			
Mounting: Thread / torque	PE foot with mounting screw, M3 / 0.6 - 0.8			
Insulating material	PA			
Flammability rating in accordance with UL 94	V2			

Ordering data		
Type	Order No.	Pcs./Pkt.
UKKB 5-PE	3007123	50

Accessories		
	Order No.	
SF-SL 0,6X3,5-100 S-VDE	1212587	10
ZB 6 (see Catalog 3)		

Description	Color
Ground terminal block, for mounting on NS 32... or NS 35...	green-yellow

Screwdriver	
Lateral groove labeling	

Terminal blocks – Classic

UK universal modular terminal blocks

Cross-reference list – Bridges

Type	Order No.	UK 2,5 N Page 459	UK 3 N Page 459	UK 5 N Page 459	UK 6 N Page 460	UK 10 N Page 461	UK 16 N Page 461	UK 35 N Page 461
Isolator bridge bar, in conjunction with isolator bridge								
ISSBI 10-5	3026256							
ISSBI 10-6	0301505							
ISSBI 10-8	0301534							
ISSBI 10-10	0301521							
Isolator bridge, in conjunction with isolator bridge bar								
IS-K 2,5	3026243							
IS-K 4	1302338							
IS-K 10	1303337							
Cross connection bar, in conjunction with distance piece								
FB 150	0201595							
Distance piece, in connection with cross connection bar								
ZS-6	0201605							
ZSR	2303608							
L-bridge, 10-pos.								
LB 10-6 GY	0202358							
LB 10-6 BU	0202280							
L-bridge, 100-pos.								
LB 100-6 GY	0202345							
LB 100-6 BU	0202303							
Chain bridge								
KB 6	0201472							
KB 8	0202206							
KB 10	0203205							
KB 15	0204259							

Isolator bridge bar ISSBI ...



Cross connection bar FB ...

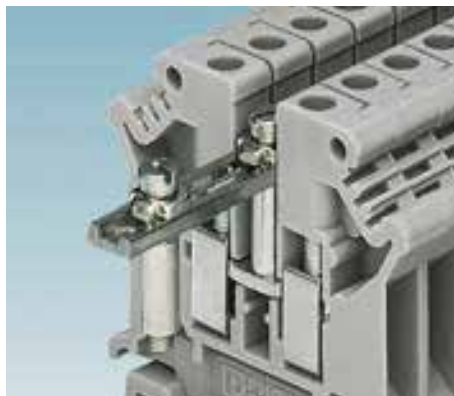

L-bridge LB ...



UK 3-TWIN Page 466	UK 5-TWIN Page 467	UK 10-TWIN Page 467	UDK 3 Page 470	UDK 4 Page 471	UKK 3 Page 472	UKKB 3 Page 472	UKK 5 Page 473	UKKB 5 Page 473	UKKB 10 Page 474

Chain bridge KB ...

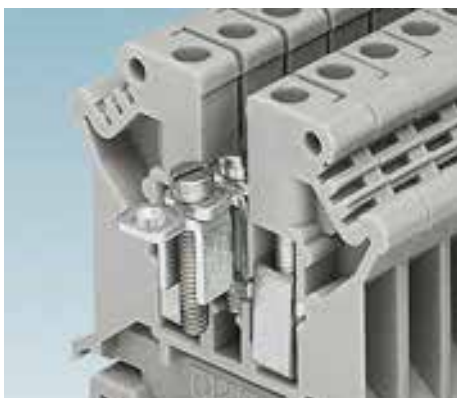

Terminal blocks – Classic

UK universal modular terminal blocks

Cross-reference list – Bridges

Type	Order No.	UK 2,5 N Page 459	UK 3 N Page 459	UK 5 N Page 459	UK 6 N Page 460	UK 10 N Page 461	UK 16 N Page 461	UK 35 N Page 461
Bridge bar across two terminal blocks								
USBR 2-7	2303239							
SB 2-8/13	0202235							
SB 2-10/15	0203234							
Bridge bar for bridged terminal block groups								
USBRJ 2-7	2305538							
SBJ 2-8/13	0303286							
SBJ 2-10/15	0302287							
Star-delta bridge								
EB 3-6/ST	5020807							
EB 6-6/DR	5020255							
EB 3-8/ST	5020810							
EB 3-8/DR	5020768							
EB 3-10/ST	5020823							
EB 6-10/DR	5020771							
Step bracket								
STL 10N/5N	0204110							
Short-circuit plug								
KSS 5	2303543							
KSS 6	0301547							
KSS 3-6	0309523							
KSS 8	0311540							
KSS 10	0310541							

Bridge bar USBR ..., SB ...



Star bridge EB .../ST



Delta bridge EB .../DR



UK 3-TWIN Page 466	UK 5-TWIN Page 467	UK 10-TWIN Page 467	UDK 3 Page 470	UDK 4 Page 471	UKK 3 Page 472	UKKB 3 Page 472	UKK 5 Page 473	UKKB 5 Page 473	UKKB 10 Page 474

Step bracket STL ...



Short-circuit plug KSS ...



Terminal blocks – Classic

UK universal modular terminal blocks

Three-level and three-conductor initiator terminal blocks DIK 1,5 ... and DIKD 1,5 ...

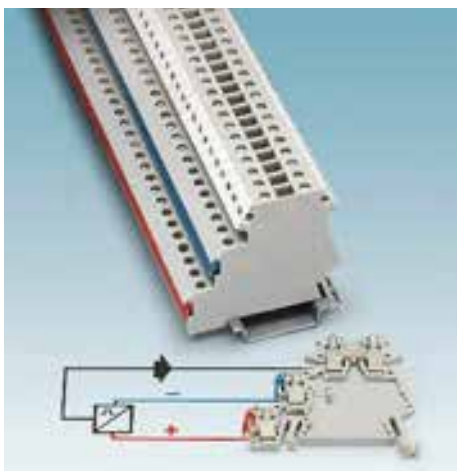

In order to reduce wiring effort, conductors of initiators and actuators are wired in junction boxes. The positive and negative connections are combined so that all that remains is to install the signal lines and a conductor pair for the power supply between the junction box and controller.

DIK 1,5

- The feed-through connections for the signal line, which can be marked, are in the top level
- The two bottom terminal points supply the initiator with potential
- The lower terminal points can be bridged using a divisible insertion bridge

DIKD 1,5

- The positive and negative potential can be fed into the insertion bridges via this power terminal block
- The first initiator can also be connected to this three-conductor feed-through terminal block

DIKD 1,5-PV

- Space-saving potential distributor terminal block
- Bridgeable upper level makes potential distribution over more than 6 terminal points possible
- The potential distributor terminal block is available with a gray, blue or black insulating housing for clear potential demarcation

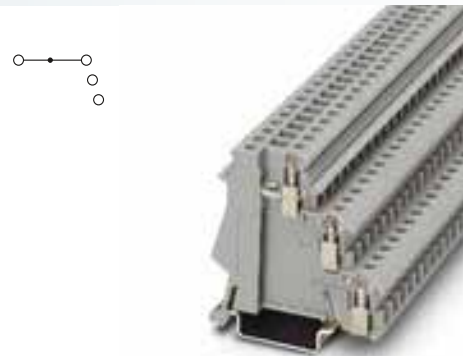

2.5 (4) mm², 26 A, three-conductor initiator terminal block



Dimensions	
	[mm]
Maximum electrical data	
Rated data	
Rated voltage	[V]
Nominal current / cross section	[A] / [mm ²]
Rated cross section	[mm ²]
Cross section range	AWG
Connection capacity	
1 conductor	[mm ²]
2 conductors (of the same type)	[mm ²]
2 flexible conductors with a TWIN ferrule	[mm ²]
Max. cross section with insertion bridge	[mm ²]
General data	
Stripping length	[mm]
Screw thread	
Tightening torque	[Nm]
Insulating material	
Flammability rating in accordance with UL 94	

Technical data				
Width	Length	Height NS 35/7,5		
6.2	55	54.5		
I _{max} [A]	U _{max} [V]	max. Ø [mm ²]	AWG (UL)	
26	250	0.2 - 4	30-14	
IEC 60947-7-1				
IEC	UL / CUL	CSA	IEC/EN 60079-7	
250	300	300	-	
24 / 2.5	15 / -	15 / -	-	
2.5	-	-	-	
24 - 12	30-14	28-14	-	
Rigid	Flexible	Ferrule		
		without/with plastic sleeve		
0.2 - 4	0.2 - 2.5	0.25 - 2.5	0.25 - 2.5	
0.2 - 1	0.2 - 1	0.25 - 1	-	
-	-	-	0.5 - 1	
4	2.5	-	-	
Ordering data				
Type	I _{max}	Order No.	Pcs./Pkt.	
DIK 1,5		2715966	50	
DIK 1,5 BU		2716059	50	
Accessories				
FBI 10- 6	24 A	0203250	10	
EB 10- DIK BU	24 A	2716680	10	
EB 10- DIK RD	24 A	2716774	10	
EB 10- DIK GY	24 A	2715937	10	
EB 80- DIK BU	24 A	2715940	1	
EB 80- DIK RD	24 A	2715953	1	
EB 80- DIK WH	24 A	2715788	1	
ATP-DIK 1,5		1413272	50	
SF-SL 0,6X3,5-100 S-VDE		1212587	10	
SK 6,2/3,8 (see Catalog 3)				
ZB 6 (see Catalog 3)				

Description	No. of pos.	Color
Terminal block, for mounting on NS 35...		gray blue
Terminal block, with three through contacts, for mounting on NS 35...		gray blue
Terminal block, with through contacts in the upper and middle levels, for mounting on NS 35...		gray
Terminal block, with equipotential bonder, for mounting on NS 35...		gray blue black

Fixed bridge, isolated	10	silver
Insertion bridge, for middle and lower levels	10	blue
	10	red
	10	gray
	80	blue
	80	red
	80	white
Partition plate, 2 mm width		gray
Screwdriver		
Marker strips, for middle and lower level		
Labeling for upper level		

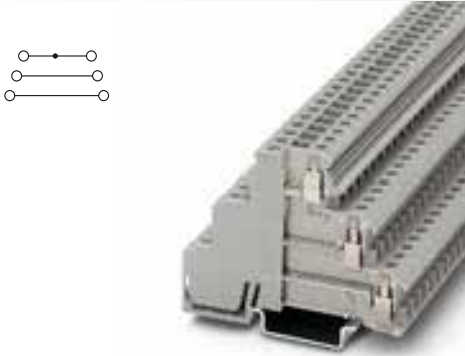

2.5 (4) mm², 30 A, three-level terminal block

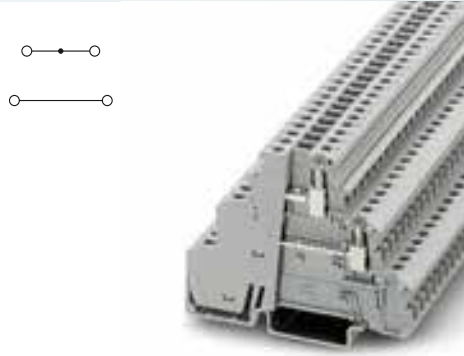

2.5 (4) mm², 30 A, three-level terminal block with two feed-through levels

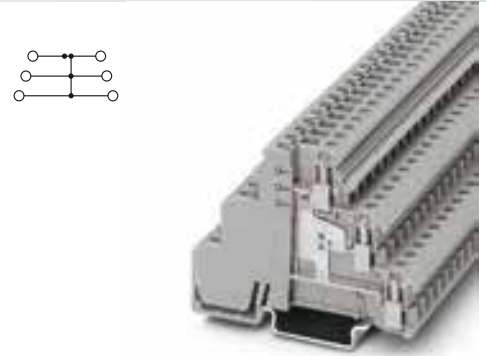

2.5 (4) mm², 32 A, three-level terminal block, internally connected levels



Technical data			
Width	Length	Height NS 35/7,5	
6.2	72.5	54.5	
I_{max} [A]	U_{max} [V]	max. Ø [mm ²]	AWG (UL)
30	250	0.2 - 4	30-14
IEC 60947-7-1			
IEC	UL / CUL	CSA	IEC/ EN 60079-7
250	300	300	-
24 / 2.5	15 / -	15 / -	-
2.5	-	-	-
24 - 12	30-14	28-14	-
Rigid	Flexible	Ferrule without/with plastic sleeve	
0.2 - 4	0.2 - 2.5	0.25 - 2.5	0.25 - 2.5
0.2 - 1	0.2 - 1	0.25 - 1	-
-	-	-	0.5 - 1
4	2.5	-	-
8			
M3			
0.5 - 0.6			
PA			
V2			

Technical data			
Width	Length	Height NS 35/7,5	
6.2	72.5	54.5	
I_{max} [A]	U_{max} [V]	max. Ø [mm ²]	AWG (UL)
30	250	0.2 - 4	30-14
IEC 60947-7-1			
IEC	UL / CUL	CSA	IEC/ EN 60079-7
250	300	-	-
24 / 2.5	15 / -	-	-
2.5	-	-	-
24 - 12	30-14	-	-
Rigid	Flexible	Ferrule without/with plastic sleeve	
0.2 - 4	0.2 - 2.5	0.25 - 2.5	0.25 - 2.5
0.2 - 1	0.2 - 1	0.25 - 1	-
-	-	-	0.5 - 1
4	2.5	-	-
8			
M3			
0.5 - 0.6			
PA			
V2			

Technical data			
Width	Length	Height NS 35/7,5	
6.2	72.5	54.5	
I_{max} [A]	U_{max} [V]	max. Ø [mm ²]	AWG (UL)
32	250	0.2 - 4	30-14
IEC 60947-7-1			
IEC	UL / CUL	CSA	IEC/ EN 60079-7
250	300	300	-
24 / 2.5	15 / -	15 / -	-
2.5	-	-	-
24 - 12	30-14	28-14	-
Rigid	Flexible	Ferrule without/with plastic sleeve	
0.2 - 4	0.2 - 2.5	0.25 - 2.5	0.25 - 2.5
0.2 - 1	0.2 - 1	0.25 - 1	-
-	-	-	0.5 - 1
4	2.5	-	-
8			
M3			
0.5 - 0.6			
PA			
V2			

Ordering data			
Type	I_{max}	Order No.	Pcs./Pkt.
DIKD 1,5		2715979	50
DIKD 1,5 BU		2716101	50

Ordering data			
Type	I_{max}	Order No.	Pcs./Pkt.
DIKD 1,5-2D		2716512	50

Ordering data			
Type	I_{max}	Order No.	Pcs./Pkt.
DIKD 1,5-PV		2715092	50
DIKD 1,5-PV BU		2715584	50
DIKD 1,5-PV BK		2715571	50

Accessories			
FBI 10- 6	24 A	0203250	10
EB 10- DIK BU	24 A	2716680	10
EB 10- DIK RD	24 A	2716774	10
EB 10- DIK GY	24 A	2715937	10
EB 80- DIK BU	24 A	2715940	1
EB 80- DIK RD	24 A	2715953	1
EB 80- DIK WH	24 A	2715788	1
ATP-DIKD 1,5		1413285	50
SF-SL 0,6X3,5-100 S-VDE		1212587	10

Accessories			
FBI 10- 6	24 A	0203250	10
EB 10- DIK BU	24 A	2716680	10
EB 10- DIK RD	24 A	2716774	10
EB 10- DIK GY	24 A	2715937	10
EB 80- DIK BU	24 A	2715940	1
EB 80- DIK RD	24 A	2715953	1
EB 80- DIK WH	24 A	2715788	1
ATP-DIKD 1,5		1413285	50
SF-SL 0,6X3,5-100 S-VDE		1212587	10

Accessories			
FBI 10- 6	24 A	0203250	10
EB 10- DIK BU	24 A	2716680	10
EB 10- DIK RD	24 A	2716774	10
EB 10- DIK GY	24 A	2715937	10
EB 80- DIK BU	24 A	2715940	1
EB 80- DIK RD	24 A	2715953	1
EB 80- DIK WH	24 A	2715788	1
ATP-DIKD 1,5		1413285	50
SF-SL 0,6X3,5-100 S-VDE		1212587	10

SK 6,2/3,8 (see Catalog 3)
ZB 6 (see Catalog 3)

SK 6,2/3,8 (see Catalog 3)
ZB 6 (see Catalog 3)

SK 6,2/3,8 (see Catalog 3)
ZB 6 (see Catalog 3)

Terminal blocks – Classic

UK universal modular terminal blocks

Three-level and three-conductor initiator terminal blocks with LED display DIK 1,5 ...

– Terminal blocks with LED displays in red and green are available for optical identification of the initiator and actuator wiring

Notes:
1) Current and voltage are determined by the plug used.
2) Light indicator: Voltage 15 - 30 V DC, current 1 - 2.5 mA.
3) The corresponding accessory is documented, see page 508.

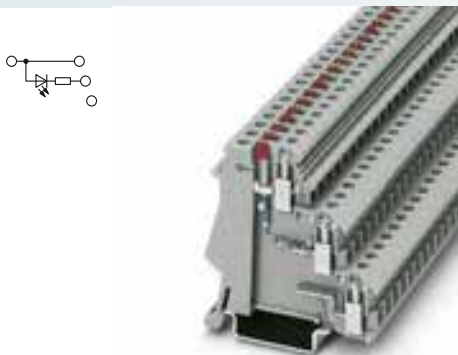

2.5 (4) mm², 26 A, three-conductor terminal block with LED display

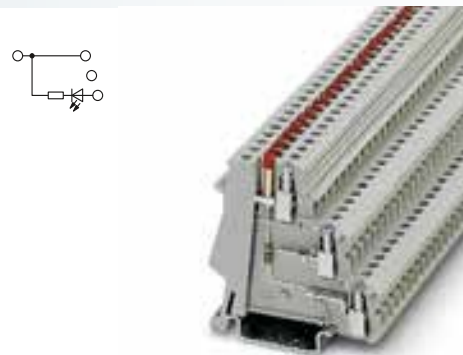

2.5 (4) mm², 26 A, three-conductor terminal block with LED display



Dimensions		[mm]
Maximum electrical data		
Rated data		
Rated voltage	[V]	24
Nominal current / cross section	[A] / [mm ²]	24 / 2.5
Rated cross section	[mm ²]	2.5
Cross section range	AWG	24 - 12
Disconnect level rated data		
Nominal current / cross section	[A] / [mm ²]	- / -
Connection capacity		
1 conductor	[mm ²]	0.2 - 4
2 conductors (of the same type)	[mm ²]	0.2 - 1
2 flexible conductors with a TWIN ferrule	[mm ²]	-
Max. cross section with insertion bridge	[mm ²]	4
General data		
Stripping length	[mm]	8
Screw thread		M3
Tightening torque	[Nm]	0.5 - 0.6
Insulating material		PA
Flammability rating in accordance with UL 94		V2

Technical data				
Width	Length	Height NS 35/7,5		
6.2	55	54.5		
I _{max} [A]	U _{max} [V]	max. Ø [mm ²]	AWG (UL)	
26	24	0.2 - 4	30-14	
IEC	UL / CUL	CSA	IEC/ EN 60079-7	
24	300	300	-	
24 / 2.5	15 / -	15 / -	-	
2.5	-	-	-	
24 - 12	30-14	28-14	-	
IEC	UL / CUL	CSA	IEC/ EN 60079-7	
-	-	-	-	
Rigid	Flexible	Ferrule without/with plastic sleeve		
0.2 - 4	0.2 - 2.5	0.25 - 2.5	0.25 - 2.5	
0.2 - 1	0.2 - 1	0.25 - 1	-	
-	-	-	0.5 - 1	
4	2.5	-	-	

Technical data				
Width	Length	Height NS 35/7,5		
6.2	55	54.5		
I _{max} [A]	U _{max} [V]	max. Ø [mm ²]	AWG (UL)	
26	24	0.2 - 4	30-14	
IEC	UL / CUL	CSA	IEC/ EN 60079-7	
24	300	300	-	
24 / 2.5	15 / -	15 / -	-	
2.5	-	-	-	
24 - 12	30-14	28-14	-	
IEC	UL / CUL	CSA	IEC/ EN 60079-7	
-	-	-	-	
Rigid	Flexible	Ferrule without/with plastic sleeve		
0.2 - 4	0.2 - 2.5	0.25 - 2.5	0.25 - 2.5	
0.2 - 1	0.2 - 1	0.25 - 1	-	
-	-	-	0.5 - 1	
4	2.5	-	-	

Description	No. of pos.	Color
Terminal block , with a red LED between the upper and middle level, for mounting on NS 35... ²⁾		gray
Green LED		gray
Terminal block , with a red LED between the upper and lower level, for mounting on NS 35... ²⁾		gray
Green LED		gray
Terminal block , with three through contacts and a red LED between the upper and middle level, for mounting on NS 35... ²⁾		gray
Green LED		gray
Terminal block , with three through contacts and a red LED between the upper and lower level, for mounting on NS 35... ²⁾		gray
Green LED		gray
Basic terminal block , for mounting on NS 35... ³⁾		gray

Ordering data				
Type	I _{max}	Order No.	Pcs./Pkt.	
DIK 1,5-LA 24RD/O-M		2715856	50	
DIK 1,5-LA 24GN/O-M		2715762	50	

Ordering data				
Type	I _{max}	Order No.	Pcs./Pkt.	
DIK 1,5-LA 24RD/U-O		2715995	50	
DIK 1,5-LA 24GN/U-O		2715733	50	

Insertion bridge, for middle and lower levels		
	80	blue
	80	red
	80	white
Partition plate , 2 mm width		gray
Screwdriver		
Marker strips, for middle and lower level		
Labeling for upper level		

Accessories				
EB 80- DIK BU	24 A	2715940	1	
EB 80- DIK RD	24 A	2715953	1	
EB 80- DIK WH	24 A	2715788	1	
ATP-DIK 1,5		1413272	50	
SF-SL 0,6X3,5-100 S-VDE		1212587	10	
SK 6,2/3,8 (see Catalog 3)				
ZB 6 (see Catalog 3)				

Accessories				
EB 80- DIK BU	24 A	2715940	1	
EB 80- DIK RD	24 A	2715953	1	
EB 80- DIK WH	24 A	2715788	1	
ATP-DIK 1,5		1413272	50	
SF-SL 0,6X3,5-100 S-VDE		1212587	10	
SK 6,2/3,8 (see Catalog 3)				
ZB 6 (see Catalog 3)				

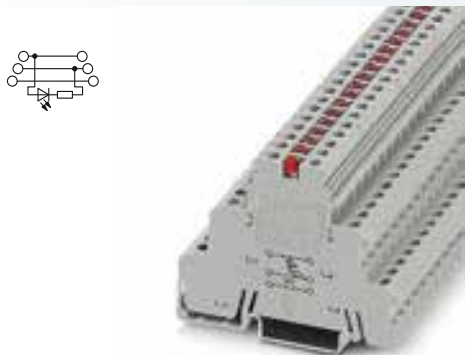

2.5 (4) mm², 30 A, three-level terminal block with LED

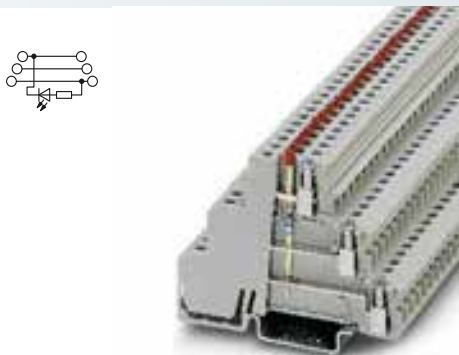

2.5 (4) mm², 30 A, three-level terminal block with LED

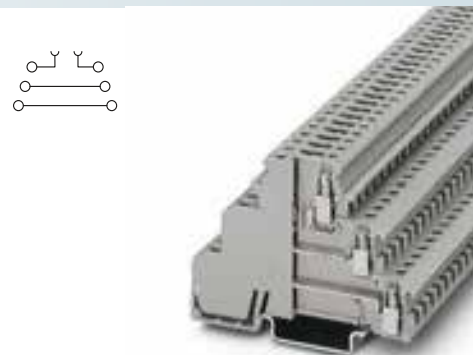

2.5 (4) mm², 15 A, three-level terminal block with disconnect zone



Technical data			
Width	Length	Height NS 35/7,5	
6.2	72.5	54.5	
I _{max} [A]	U _{max} [V]	max. Ø [mm ²]	AWG (UL)
30	250	0.2 - 4	30-14
IEC	UL / CUL	CSA	IEC/ EN 60079-7
250	300	300	-
24 / 2.5	15 / -	15 / -	-
2.5	-	-	-
24 - 12	30-14	28-14	-
IEC	UL / CUL	CSA	IEC/ EN 60079-7
-	-	-	-
Rigid	Flexible	Ferrule without/with plastic sleeve	
0.2 - 4	0.2 - 2.5	0.25 - 2.5	0.25 - 2.5
0.2 - 1	0.2 - 1	0.25 - 1	-
-	-	-	0.5 - 1
4	2.5	-	-
8			
M3			
0.5 - 0.6			
PA			
V2			

Technical data			
Width	Length	Height NS 35/7,5	
6.2	72.5	54.5	
I _{max} [A]	U _{max} [V]	max. Ø [mm ²]	AWG (UL)
30	250	0.2 - 4	30-14
IEC	UL / CUL	CSA	IEC/ EN 60079-7
250	300	300	-
24 / 2.5	15 / -	15 / -	-
2.5	-	-	-
24 - 12	30-14	28-14	-
IEC	UL / CUL	CSA	IEC/ EN 60079-7
-	-	-	-
Rigid	Flexible	Ferrule without/with plastic sleeve	
0.2 - 4	0.2 - 2.5	0.25 - 2.5	0.25 - 2.5
0.2 - 1	0.2 - 1	0.25 - 1	-
-	-	-	0.5 - 1
4	2.5	-	-
8			
M3			
0.5 - 0.6			
PA			
V2			

Technical data			
Width	Length	Height NS 35/7,5	
6.2	72.5	54.5	
I _{max} [A]	U _{max} [V]	max. Ø [mm ²]	AWG (UL)
15 ¹⁾	250 ¹⁾	0.2 - 4	30-14
IEC 60947-7-1			
IEC	UL / CUL	CSA	IEC/ EN 60079-7
250 ¹⁾	300	300	-
15 ¹⁾ / 2.5	15 / -	15 / -	-
2.5	-	-	-
24 - 12	30-14	28-14	-
IEC	UL / CUL	CSA	IEC/ EN 60079-7
15 ¹⁾ / 2.5	-	-	-
Rigid	Flexible	Ferrule without/with plastic sleeve	
0.2 - 4	0.2 - 2.5	0.25 - 2.5	0.25 - 2.5
0.2 - 1	0.2 - 1	0.25 - 1	-
-	-	-	0.5 - 1
4	2.5	-	-
8			
M3			
0.5 - 0.6			
PA			
V2			

Ordering data			
Type	I _{max}	Order No.	Pcs./Pkt.
DIKD 1,5-LA 24RD/O-M		2715814	50
DIKD 1,5-LA 24GN/O-M		2716376	50

Ordering data			
Type	I _{max}	Order No.	Pcs./Pkt.
DIKD 1,5-LA 24RD/U-O		2716279	50
DIKD 1,5-LA 24GN/U-O		2716402	50

Ordering data			
Type	I _{max}	Order No.	Pcs./Pkt.
DIKD 1,5-TG		2774237	50

Accessories			
EB 80- DIK BU	24 A	2715940	1
EB 80- DIK RD	24 A	2715953	1
EB 80- DIK WH	24 A	2715788	1
ATP-DIKD 1,5		1413285	50
SF-SL 0,6X3,5-100 S-VDE		1212587	10
SK 6,2/3,8 (see Catalog 3)			
ZB 6 (see Catalog 3)			

Accessories			
EB 80- DIK BU	24 A	2715940	1
EB 80- DIK RD	24 A	2715953	1
EB 80- DIK WH	24 A	2715788	1
ATP-DIKD 1,5		1413285	50
SF-SL 0,6X3,5-100 S-VDE		1212587	10
SK 6,2/3,8 (see Catalog 3)			
ZB 6 (see Catalog 3)			

Accessories			
EB 80- DIK BU	24 A	2715940	1
EB 80- DIK RD	24 A	2715953	1
EB 80- DIK WH	24 A	2715788	1
ATP-DIKD 1,5		1413285	50
SF-SL 0,6X3,5-100 S-VDE		1212587	10
SK 6,2/3,8 (see Catalog 3)			
ZB 6 (see Catalog 3)			

Terminal blocks – Classic

UK universal modular terminal blocks

Three-level and three-conductor actuator terminal blocks with PE foot DOK 1,5 ...



- Same shape as the three-level initiator terminal blocks DIK ...
- The feed-through connections for the signal line, which can be marked, are in the top level
- The middle level supplies the connected actuators with voltage
- Unlike the DIK terminal blocks, the lower level of these output terminal blocks makes direct contact with the DIN rail and as a PE connection they are marked green-yellow
- Convenient bridging of up to 80 terminal blocks with divisible insertion bridges
- The forks of the insertion bridge can be easily loosened for jumping bridging
- Alternate wiring of an actuator followed by an initiator is easy
- Because the spine of the insertion bridge can be snapped into place with the terminal block housing, all the terminal points can be wired freely and the bridge can be securely positioned
- Terminal blocks with LED displays in red and green are available for optical identification of the initiator and actuator wiring
- The component terminal block DOKD 1,5-TG can accommodate the fuse connector or the isolating connector

Notes:

- 1) Current and voltage are determined by the plug used.
- 2) Light indicator: Voltage 15 - 30 V DC, current 1 - 2.5 mA.
- 3) The corresponding accessory is documented, see page 508.

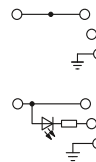

2.5 (4) mm², 26 A, three-conductor actuator terminal block with PE foot



Technical data

Dimensions		Width	Length	Height NS 35/7,5	
		6.2	61.5	54.5	
Maximum electrical data		I _{max} [A]	U _{max} [V]	max. Ø [mm ²]	AWG (UL)
		26	250	0.2 - 4	30-14
Rated data		IEC 60947-7-1/IEC 60947-7-2			
		IEC	UL / CUL	CSA	IEC/EN 60079-7
Rated voltage	[V]	250	300	300	-
Nominal current / cross section	[A] / [mm ²]	24 / 2.5	15 / -	15 / -	-
Rated cross section	[mm ²]	2.5	-	-	-
Cross section range	AWG	24 - 12	30-14	28-14	-
Disconnect level rated data		IEC	UL / CUL	CSA	IEC/EN 60079-7
Nominal current / cross section	[A] / [mm ²]	-	-	-	-
Connection capacity		Rigid	Flexible	Ferrule	
		without/with plastic sleeve			
1 conductor	[mm ²]	0.2 - 4	0.2 - 2.5	0.25 - 2.5	0.25 - 2.5
2 conductors (of the same type)	[mm ²]	0.2 - 1	0.2 - 1	0.25 - 1	-
2 flexible conductors with a TWIN ferrule	[mm ²]	-	-	-	0.5 - 1
Max. cross section with insertion bridge	[mm ²]	4	2.5	-	-
General data					
Stripping length	[mm]	8			
Screw thread		M3			
Tightening torque	[Nm]	0.5 - 0.6			
Insulating material		PA			
Flammability rating in accordance with UL 94		V2			

Ordering data

Description	No. of pos.	Color	Type	I _{max}	Order No.	Pcs./Pkt.
Terminal block, for mounting on NS 35...		gray	DOK 1,5		2717016	50
Terminal block, with red (RD) LED between the upper and middle levels, for mounting on NS 35... ²⁾		gray	DOK 1,5-LA 24RD/O-M		2717029	50
Terminal block, with green (GN) LED between the upper and middle levels, for mounting on NS 35... ²⁾		gray	DOK 1,5-LA 24GN/O-M		2717074	50
Terminal block, with through contacts in the upper and lower levels, for mounting on NS 35...		gray				
Basic terminal block, for mounting on NS 35... ³⁾		gray				

Accessories

Description	No. of pos.	Color	Accessories	I _{max}	Order No.	Pcs./Pkt.
Insertion bridge, for middle and lower levels, fully insulated	10	gray	EB 10- DIK GY	26 A	2715937	10
	10	red	EB 10- DIK RD	26 A	2716774	10
	10	blue	EB 10- DIK BU	26 A	2716680	10
	80	blue	EB 80- DIK BU	26 A	2715940	1
	80	red	EB 80- DIK RD	26 A	2715953	1
	80	white	EB 80- DIK WH	26 A	2715788	1
Fixed bridge, isolated			FBI 10- 6	26 A	0203250	10
Partition plate, 2 mm width		gray	ATP-DIK 1,5		1413272	50
Screwdriver			SF-SL 0,6X3,5-100 S-VDE		1212587	10
Marker strips, for middle and lower level			SK 6,2/3,8 (see Catalog 3)			
Labeling for upper level			ZB 6 (see Catalog 3)			

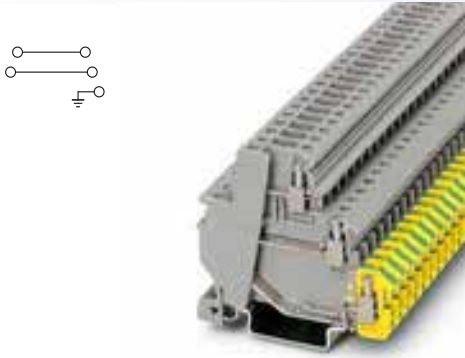

2.5 (4) mm², 26 A, three-level terminal block with PE foot

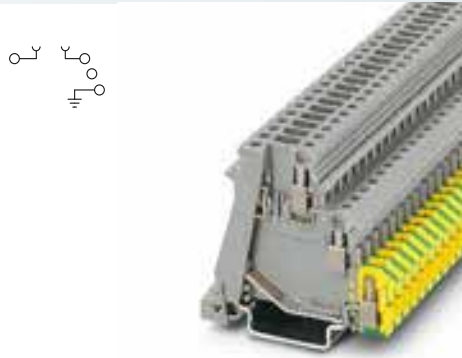

2.5 (4) mm², 16 A, three-conductor actuator terminal block with disconnect zone and PE foot

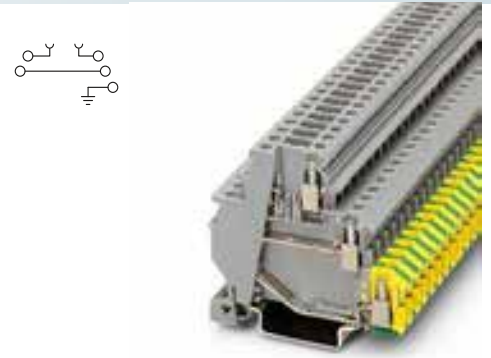

2.5 (4) mm², 26 A, three-level terminal block with disconnect zone and PE foot



Technical data				
Width	Length	Height NS 35/7,5		
6.2	62.5	54.5		
I_{max} [A]	U_{max} [V]	max. Ø [mm ²]	AWG (UL)	
26	250	0.2 - 4	30-14	
IEC 60947-7-1/IEC 60947-7-2				
IEC	UL / CUL	CSA	IEC/ EN 60079-7	
250	300	300	-	
24 / 2.5	15 / -	15 / -	-	
2.5	-	-	-	
24 - 12	30-14	28-14	-	
IEC	UL / CUL	CSA	IEC/ EN 60079-7	
-	-	-	-	
Rigid	Flexible	Ferrule without/with plastic sleeve		
0.2 - 4	0.2 - 2.5	0.25 - 2.5	0.25 - 2.5	
0.2 - 1	0.2 - 1	0.25 - 1	-	
-	-	-	0.5 - 1	
4	2.5	-	-	
8				
M3				
0.5 - 0.6				
PA				
V2				

Technical data				
Width	Length	Height NS 35/7,5		
6.2	61	54.5		
I_{max} [A]	U_{max} [V]	max. Ø [mm ²]	AWG (UL)	
16 ¹⁾	250 ¹⁾	0.2 - 4	30-14	
IEC 60947-7-1/IEC 60947-7-2				
IEC	UL / CUL	CSA	IEC/ EN 60079-7	
250 ¹⁾	300	300	-	
16 ¹⁾ / 1.5	15 / -	15 / -	-	
2.5	-	-	-	
24 - 12	30-14	28-14	-	
IEC	UL / CUL	CSA	IEC/ EN 60079-7	
16 ¹⁾	-	-	-	
Rigid	Flexible	Ferrule without/with plastic sleeve		
0.2 - 4	0.2 - 2.5	0.25 - 2.5	0.25 - 2.5	
0.2 - 1	0.2 - 1	0.25 - 1	-	
-	-	-	0.5 - 1	
4	2.5	-	-	
8				
M3				
0.5 - 0.6				
PA				
V2				

Technical data				
Width	Length	Height NS 35/7,5		
6.2	63	54.5		
I_{max} [A]	U_{max} [V]	max. Ø [mm ²]	AWG (UL)	
26 ¹⁾	250 ¹⁾	0.2 - 4	30-14	
IEC 60947-7-1/IEC 60947-7-2				
IEC	UL / CUL	CSA	IEC/ EN 60079-7	
250 ¹⁾	300	300	-	
24 ¹⁾ / 2.5	15 / -	15 / -	-	
2.5	-	-	-	
24 - 12	30-14	28-14	-	
IEC 60947-7-1	UL / CUL	CSA	IEC/ EN 60079-7	
16 ¹⁾	-	-	-	
Rigid	Flexible	Ferrule without/with plastic sleeve		
0.2 - 4	0.2 - 2.5	0.25 - 2.5	0.25 - 2.5	
0.2 - 1	0.2 - 1	0.25 - 1	-	
-	-	-	0.5 - 1	
4	2.5	-	-	
8				
M3				
0.5 - 0.6				
PA				
V2				

Ordering data			
Type	I_{max}	Order No.	Pcs./Pkt.
DOK 1,5-2D		2717139	50

Ordering data			
Type	I_{max}	Order No.	Pcs./Pkt.
DOK 1,5-TG		2717113	50

Ordering data			
Type	I_{max}	Order No.	Pcs./Pkt.
DOK 1,5-TG		3011054	50

Accessories			
Part No.	Current	Order No.	Pcs./Pkt.
EB 10- DIK GY	26 A	2715937	10
EB 10- DIK RD	26 A	2716774	10
EB 10- DIK BU	26 A	2716680	10
EB 80- DIK BU	26 A	2715940	1
EB 80- DIK RD	26 A	2715953	1
EB 80- DIK WH	26 A	2715788	1
ATP-DIKD 1,5		1413285	50
SF-SL 0,6X3,5-100 S-VDE		1212587	10

Accessories			
Part No.	Current	Order No.	Pcs./Pkt.
EB 10- DIK GY	26 A	2715937	10
EB 10- DIK RD	26 A	2716774	10
EB 10- DIK BU	26 A	2716680	10
EB 80- DIK BU	26 A	2715940	1
EB 80- DIK RD	26 A	2715953	1
EB 80- DIK WH	26 A	2715788	1
ATP-DIK 1,5		1413272	50
SF-SL 0,6X3,5-100 S-VDE		1212587	10

Accessories			
Part No.	Current	Order No.	Pcs./Pkt.
EB 10- DIK GY	26 A	2715937	10
EB 10- DIK RD	26 A	2716774	10
EB 10- DIK BU	26 A	2716680	10
EB 80- DIK BU	26 A	2715940	1
EB 80- DIK RD	26 A	2715953	1
EB 80- DIK WH	26 A	2715788	1
ATP-DIKD 1,5		1413285	50
SF-SL 0,6X3,5-100 S-VDE		1212587	10

SK 6,2/3,8 (see Catalog 3)
ZB 6 (see Catalog 3)

SK 6,2/3,8 (see Catalog 3)
ZB 6 (see Catalog 3)

SK 6,2/3,8 (see Catalog 3)
ZB 6 (see Catalog 3)

Four-conductor initiator and actuator terminal blocks VIOK 1,5 ...

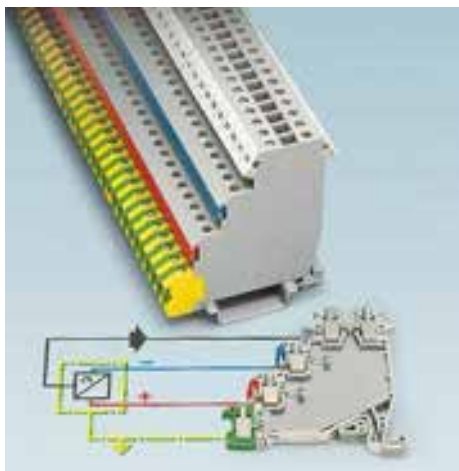

VIOK 1,5

- This terminal block is a combination of a DIK ... and DOK ... terminal block where just one terminal block can be used for initiators and actuators
- The feed-through connections for the signal line, which can be marked, are in the top level
- The two middle terminal points supply potential to the initiator
- The PE connection is on the lower level

VIOK 1,5-2D

- This terminal block has two feed-through levels and two busbar levels
- It is used for programmable or self-monitoring initiators which are additionally controlled via the second feed-through level

VIOK 1,5-D/TG/D/PE

- Here a plug division is integrated in the second level from above. Therefore, the positive potential of the initiator can be transmitted via a fuse plug or – for maintenance and test purposes – via an isolating plug

Notes:
1) Current and voltage are determined by the plug used.
2) When using EB insertion bridges, the nominal voltage is reduced to 250 V.
3) The corresponding accessory is documented, see page 508.

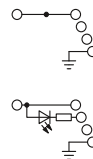

2.5 (4) mm², 26 A, four-conductor actuator terminal block with PE foot



Dimensions	
	[mm]
Maximum electrical data	
Rated voltage	[V]
Nominal current / cross section	[A] / [mm ²]
Rated cross section	[mm ²]
Cross section range	AWG
Disconnect level rated data	
Nominal current / cross section	[A] / [mm ²]
Connection capacity	
1 conductor	[mm ²]
2 conductors (of the same type)	[mm ²]
2 flexible conductors with a TWIN ferrule	[mm ²]
Max. cross section with insertion bridge	[mm ²]
General data	
Stripping length	[mm]
Screw thread	
Tightening torque	[Nm]
Insulating material	
Flammability rating in accordance with UL 94	

Technical data				
Width	Length	Height NS 35/7,5		
6.2	62.5	70		
I _{max} [A]	U _{max} [V]	max. Ø [mm ²]	AWG (UL)	
26	250	0.2 - 4	30-14	
IEC 60947-7-1/IEC 60947-7-2				
IEC	UL / CUL	CSA	IEC/EN 60079-7	
250	300	300	-	
24 / 2.5	15 / -	15 / -	-	
2.5	-	-	-	
24 - 12	30-14	28-14	-	
Disconnect level rated data				
IEC	UL / CUL	CSA	IEC/EN 60079-7	
-	-	-	-	
Connection capacity				
Rigid	Flexible	Ferrule		
		without/with plastic sleeve		
0.2 - 4	0.2 - 2.5	0.25 - 2.5	0.25 - 2.5	-
0.2 - 1	0.2 - 1	0.25 - 1	-	-
-	-	-	-	0.5 - 1
4	2.5	-	-	-
8	M3	0.5 - 0.6	PA	V2

Description	No. of pos.	Color
Terminal block, for mounting on NS 35...		gray
Terminal block, with red (RD) LED between the upper level and the level below it, for mounting on NS 35...		gray
Terminal block, with two through contacts, for mounting on NS 35...		gray
Terminal block, with three through contacts, for mounting on NS 35...		gray
Basic terminal block, with two through contacts, for mounting on NS 35... ³⁾		gray

Ordering data			
Type	I _{max}	Order No.	Pcs./Pkt.
VIOK 1,5		2718015	50
VIOK 1,5-LA 24RD/O-MO		2718028	50

Insertion bridge, for middle and lower levels, fully insulated		
	10	gray
	10	red
	10	blue
	80	blue
	80	red
	80	white

Fixed bridge, isolated	10	silver
Partition plate, 2 mm width		gray
Screwdriver		

Marker strips, for middle and lower level
Labeling for middle levels
Labeling for upper level

Accessories			
EB 10- DIK GY	26 A	2715937	10
EB 10- DIK RD	26 A	2716774	10
EB 10- DIK BU	26 A	2716680	10
EB 80- DIK BU	26 A	2715940	1
EB 80- DIK RD	26 A	2715953	1
EB 80- DIK WH	26 A	2715788	1
FBI 10- 6	26 A	0203250	10
ATP-DIK 1,5		1413272	50
SF-SL 0,6X3,5-100 S-VDE		1212587	10

SK 6,2/3,8 (see Catalog 3)
ZB 6 (see Catalog 3)

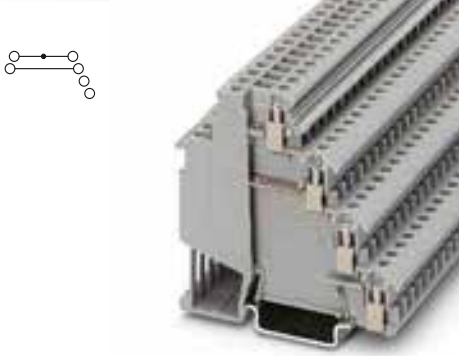

2.5 (4) mm², 26 A, four-conductor terminal block, both upper levels as feed-through levels

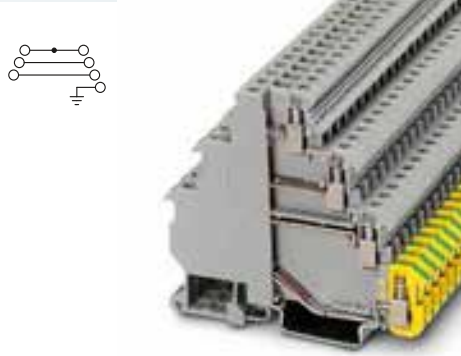

2.5 (4) mm², 26 A, four-level terminal block with PE foot

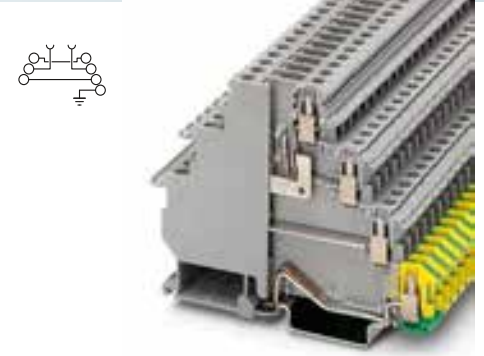

2.5 (4) mm², 24 A, four-level terminal block with PE foot, disconnect zone in third level



Technical data			
Width	Length	Height NS 35/7,5	
6.2	73	70	
I _{max} [A]	U _{max} [V]	max. Ø [mm ²]	AWG (UL)
26	250	0.2 - 4	30-14
IEC 60947-7-1			
IEC	UL / CUL	CSA	IEC/ EN 60079-7
250	300	300	-
24 / 2.5	15 / -	15 / -	-
2.5	-	-	-
24 - 12	30-14	28-14	-
IEC	UL / CUL	CSA	IEC/ EN 60079-7
-	-	-	-
Rigid	Flexible	Ferrule without/with plastic sleeve	
0.2 - 4	0.2 - 2.5	0.25 - 2.5	0.25 - 2.5
0.2 - 1	0.2 - 1	0.25 - 1	-
-	-	-	0.5 - 1
4	2.5	-	-
8			
M3			
0.5 - 0.6			
PA			
V2			

Technical data			
Width	Length	Height NS 35/7,5	
6.2	82.5	70	
I _{max} [A]	U _{max} [V]	max. Ø [mm ²]	AWG (UL)
26	400 ²⁾	0.2 - 4	30-14
IEC 60947-7-1/IEC 60947-7-2			
IEC	UL / CUL	CSA	IEC/ EN 60079-7
400 ²⁾	300	300	-
24 / 2.5	15 / -	15 / -	-
2.5	-	-	-
24 - 12	30-14	28-14	-
IEC	UL / CUL	CSA	IEC/ EN 60079-7
-	-	-	-
Rigid	Flexible	Ferrule without/with plastic sleeve	
0.2 - 4	0.2 - 2.5	0.25 - 2.5	0.25 - 2.5
-	-	-	-
4	2.5	-	-
8			
M3			
0.5 - 0.6			
PA			
V2			

Technical data			
Width	Length	Height NS 35/7,5	
6.2	91.5	70	
I _{max} [A]	U _{max} [V]	max. Ø [mm ²]	AWG (UL)
24 ¹⁾	250 ¹⁾	0.2 - 4	30-14
IEC 60947-7-1/IEC 60947-7-2			
IEC	UL / CUL	CSA	IEC/ EN 60079-7
250 ¹⁾	300	300	-
24 ¹⁾ / 2.5	15 / -	15 / -	-
2.5	-	-	-
24 - 12	30-14	28-14	-
IEC 60947-7-1			
IEC	UL / CUL	CSA	IEC/ EN 60079-7
16 / 1.5	-	-	-
Rigid	Flexible	Ferrule without/with plastic sleeve	
0.2 - 4	0.2 - 2.5	0.25 - 2.5	0.25 - 2.5
-	-	-	-
4	2.5	-	-
8			
M3			
0.5 - 0.6			
PA			
V2			

Ordering data			
Type	I _{max}	Order No.	Pcs./Pkt.
VIOK 1,5-2D		2718196	50

Ordering data			
Type	I _{max}	Order No.	Pcs./Pkt.
VIOK 1,5-3D/PE		2718206	50

Ordering data			
Type	I _{max}	Order No.	Pcs./Pkt.
VIOK 1,5-D/TG/D/PE		3011067	50

Accessories			
Type	I _{max}	Order No.	Pcs./Pkt.
EB 10- DIK GY	26 A	2715937	10
EB 10- DIK RD	26 A	2716774	10
EB 10- DIK BU	26 A	2716680	10
EB 80- DIK BU	26 A	2715940	1
EB 80- DIK RD	26 A	2715953	1
EB 80- DIK WH	26 A	2715788	1
FBI 10- 6	26 A	0203250	10
ATP-DIKD 1,5		1413285	50
SF-SL 0,6X3,5-100 S-VDE		1212587	10

Accessories			
Type	I _{max}	Order No.	Pcs./Pkt.
EB 10- DIK GY	26 A	2715937	10
EB 10- DIK RD	26 A	2716774	10
EB 10- DIK BU	26 A	2716680	10
EB 80- DIK BU	26 A	2715940	1
EB 80- DIK RD	26 A	2715953	1
EB 80- DIK WH	26 A	2715788	1
FBI 10- 6	26 A	0203250	10
ATP-DIK 1,5		1413272	50
SF-SL 0,6X3,5-100 S-VDE		1212587	10

Accessories			
Type	I _{max}	Order No.	Pcs./Pkt.
EB 10- DIK GY	26 A	2715937	10
EB 10- DIK RD	26 A	2716774	10
EB 10- DIK BU	26 A	2716680	10
EB 80- DIK BU	26 A	2715940	1
EB 80- DIK RD	26 A	2715953	1
EB 80- DIK WH	26 A	2715788	1
ATP-DIKD 1,5		1413285	50
SF-SL 0,6X3,5-100 S-VDE		1212587	10

SK 6,2/3,8 (see Catalog 3)
ZB 6 (see Catalog 3)

SK 6,2/3,8 (see Catalog 3)
ZB 6 (see Catalog 3)

SK 6,2/3,8 (see Catalog 3)
ZBF 6 (see Catalog 3)
ZB 6 (see Catalog 3)

Terminal blocks – Classic

UK universal modular terminal blocks

Three and four-level terminal blocks with PE foot SLKK ... and DLK ...



Three-level terminal blocks SLKK 5 ...

- With two laterally offset feed-through levels and ground connection to the DIN rail which acts as a grounding busbar
- This allows space-saving and systematic wiring of 3-wire conductors
- This is of advantage for controllers with external actuators, solenoid valves and limit switches
- The SLKK 5-LA...U-O with integrated LED display optically indicates the voltage condition of the lower feed-through level
- The FBI 10-6 fixed bridge is used on the upper level to connect the return lines for the LED displays and the external loads to form a common busbar

Four-level terminal blocks DLK ...

- The three-conductor terminal blocks DLK 2,5-PE and DLKB 2,5-PE are particularly suited to wiring three-phase current consumers due to their structure with three feed-through levels plus a PE connection
- To reduce the amount of wire used, the DLKB 2,5-PE can also be bridged in the middle and lower levels using the insertion bridges EB...DIK with up to 80 positions

Notes:

¹⁾ The voltage is determined by the LED display (only for SLKK 5-LA...)

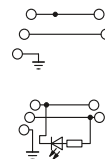

4 (4) mm², 30 A, three-level terminal block with PE foot



Technical data

Dimensions	Width	Length	Height NS 35/7,5	
	6.2	66.5	69.5	
Maximum electrical data	I_{max} [A]	U_{max} [V]	max. \varnothing [mm ²]	AWG (UL)
	30	500 ¹⁾	0.2 - 4	26-10
Rated data	IEC 60947-7-1/IEC 60947-7-2			
	IEC	UL / CUL	CSA	IEC/EN 60079-7
Rated voltage	[V]	500 ¹⁾	600	300
Nominal current / cross section	[A] / [mm ²]	30 / 4	30 / -	25 / -
Rated cross section	[mm ²]	4	-	-
Cross section range	AWG	24 - 10	26-10	28-12
Connection capacity		Rigid	Flexible	Ferrule without/with plastic sleeve
1 conductor	[mm ²]	0.2 - 4	0.2 - 4	0.25 - 4 / 0.25 - 2.5
2 conductors (of the same type)	[mm ²]	0.2 - 1.5	0.2 - 1.5	0.25 - 1.5 / -
2 flexible conductors with a TWIN ferrule	[mm ²]	-	-	- / 0.5 - 1.5
Max. cross section with insertion bridge	[mm ²]	4	2.5	- / -
General data	Stripping length	[mm]	8	
	Screw thread		M3	
	Tightening torque	[Nm]	0.6 - 0.8	
	Insulating material		PA	
	Flammability rating in accordance with UL 94		V0	

Ordering data

Description	No. of pos.	Color	Type	I_{max}	Order No.	Pcs./Pkt.
Double-level terminal block , with protective conductor foot, for mounting on NS 35...		gray	SLKK 5		0461018	50
Double-level terminal block , with protective conductor foot, for mounting on NS 35..., with LED display for 30 ... 60 V AC/DC		gray	SLKK 5-LA 60 RD/U-O		0461034	50
Four-conductor terminal block , for mounting on NS 35...		gray				

Accessories

Cover , width: 2.5 mm	gray		D-UKK 3/5		2770024	50
Spacer cover , compensates for level offset if standard terminal blocks are to be fitted adjacently, 2.5 mm thick	gray		DG-UKK 3/5		2770817	50
Insertion bridge , for middle and lower levels, fully insulated						
	10	gray				
	10	red				
	10	blue				
	80	blue				
	80	red				
	80	white				
Insertion bridge , insulated			EB 2-6	26 A	0201155	100
	2	gray	EB 3-6	26 A	0201142	100
	3	gray	EB 10-6	26 A	0201139	10
	10	gray				
Fixed bridge , isolated			FBI 10-6	32 A	0203250	10
	10	silver	TS-KK 3		2770215	50
Separating disk , for separation of neighboring bridges, can be fitted later, no loss of pitch		gray				
Screwdriver			SF-SL 0,6X3,5-100 S-VDE		1212587	10
Lateral groove labeling			ZB 6 (see Catalog 3)			

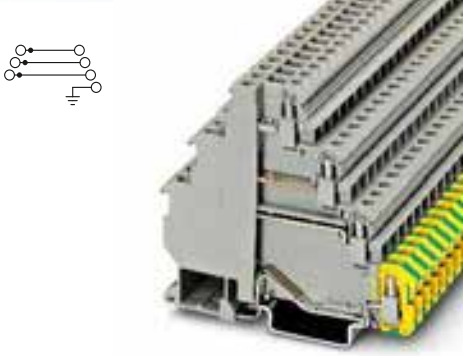

2.5 (4) mm², 24 A, four-level terminal block with PE foot

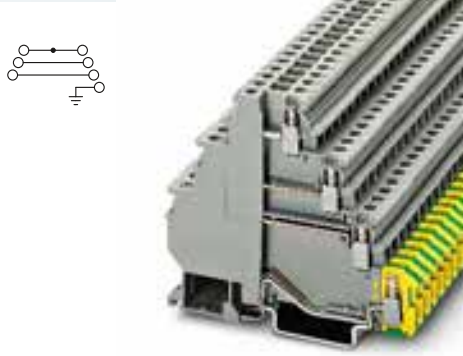

2.5 (4) mm², 24 A, four-level terminal block with PE foot

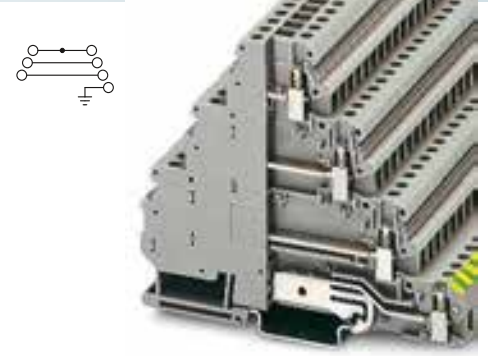

4 (6) mm², 34 A, four-level terminal block with PE foot



Technical data			
Width	Length	Height NS 35/7,5	
6.2	83.5	70	
I _{max} [A]	U _{max} [V]	max. Ø [mm ²]	AWG (UL)
24	400	0.2 - 4	30-14
IEC 60947-7-1/IEC 60947-7-2			
IEC	UL / CUL	CSA	IEC/ EN 60079-7
400	300	300	-
19 / 2.5	15 / -	15 / -	-
2.5	-	-	-
24 - 12	30-14	28-12	-
Rigid	Flexible	Ferrule without/with plastic sleeve	
0.2 - 4	0.2 - 2.5	0.25 - 2.5	0.25 - 2.5
-	-	-	-
-	-	-	-
4	2.5	-	-
8			
M3			
0.5 - 0.6			
PA			
V0			

Technical data			
Width	Length	Height NS 35/7,5	
6.2	83	70	
I _{max} [A]	U _{max} [V]	max. Ø [mm ²]	AWG (UL)
24	400	0.2 - 4	30-14
IEC 60947-7-1/IEC 60947-7-2			
IEC	UL / CUL	CSA	IEC/ EN 60079-7
400	300	300	-
19 / 2.5	15 / -	15 / -	-
2.5	-	-	-
24 - 12	30-14	28-12	-
Rigid	Flexible	Ferrule without/with plastic sleeve	
0.2 - 4	0.2 - 2.5	0.25 - 2.5	0.25 - 2.5
-	-	-	-
-	-	-	-
-	-	-	-
8			
M3			
0.5 - 0.6			
PA			
V0			

Technical data			
Width	Length	Height NS 35/7,5	
6.2	103.5	86.5	
I _{max} [A]	U _{max} [V]	max. Ø [mm ²]	AWG (UL)
34	400	0.2 - 6	30-10
IEC 60947-7-1/IEC 60947-7-2			
IEC	UL / CUL	CSA	IEC/ EN 60079-7
400	600	-	-
32 / 4	30 / -	-	-
4	-	-	-
24 - 10	30-10	-	-
Rigid	Flexible	Ferrule without/with plastic sleeve	
0.2 - 6	0.2 - 4	0.25 - 4	0.25 - 4
-	-	-	-
-	-	-	-
-	-	-	-
8			
M3			
0.5 - 0.6			
PA			
V0			

Ordering data			
Type	I _{max}	Order No.	Pcs./Pkt.
DLKB 2,5-PE		3011038	50

Ordering data			
Type	I _{max}	Order No.	Pcs./Pkt.
DLK 2,5-PE		3011041	50

Ordering data			
Type	I _{max}	Order No.	Pcs./Pkt.
DLK 4-PE		3011999	50

Accessories			
EB 10- DIK GY	26 A	2715937	10
EB 10- DIK RD	26 A	2716774	10
EB 10- DIK BU	26 A	2716680	10
EB 80- DIK BU	26 A	2715940	1
EB 80- DIK RD	26 A	2715953	1
EB 80- DIK WH	26 A	2715788	1
FBI 10- 6	26 A	0203250	10
SF-SL 0,6X3,5-100 S-VDE		1212587	10
ZB 6 (see Catalog 3)			

Accessories			
FBI 10- 6	26 A	0203250	10
SF-SL 0,6X3,5-100 S-VDE		1212587	10
ZB 6 (see Catalog 3)			

Accessories			
FBI 10- 6	30 A	0203250	10
SF-SL 0,6X3,5-100 S-VDE		1212587	10
ZB 6 (see Catalog 3)			

Terminal blocks – Classic

UK universal modular terminal blocks

UK ...-HESI...N fuse/lever-type disconnect terminal blocks

- Compact, space-saving design
- Universal disconnect zone

Notes:
1) If the fuse is faulty, the downstream circuit is not off load.
2) The current is determined by the fuse used, the voltage by the LED display. Observe max. power dissipation.

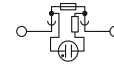
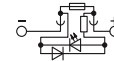
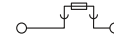

4 (6) mm², 6.3 A, lever-type fuse terminal block, for 5 x 20 mm cartridge fuses



Dimensions	
	[mm]
Dimensions	
	[mm]
Maximum electrical data	
Rated data	
Rated voltage	[V]
Nominal current / cross section	[A] / [mm ²]
Rated cross section	[mm ²]
Cross section range	AWG
Connection capacity	
1 conductor	[mm ²]
2 conductors (of the same type)	[mm ²]
2 flexible conductors with a TWIN ferrule	[mm ²]
Max. cross section with insertion bridge	[mm ²]
General data	
Stripping length	[mm]
Screw thread	
Tightening torque	[Nm]
Insulating material	
Flammability rating in accordance with UL 94	

Technical data			
Width	Length	Height NS 35/7,5	
8.2	58	50	
Width	Length	Height NS 32	
8.2	58	55	
I _{max} [A]	U _{max} [V]	max. Ø [mm ²]	AWG (UL)
6.3 ²⁾	500 ²⁾	0.2 - 6	26-10
IEC 60947-7-3			
IEC	UL / CUL	CSA	IEC/EN 60079-7
Rated voltage	500 ²⁾	600	-
Nominal current / cross section	6.3 ²⁾ / 1.5	16	-
Rated cross section	4	-	-
Cross section range	24 - 10	26-10	-
Connection capacity		Rigid	Flexible
			Ferrule without/with plastic sleeve
1 conductor	[mm ²]	0.2 - 6	0.2 - 4
2 conductors (of the same type)	[mm ²]	0.2 - 1.5	0.2 - 1.5
2 flexible conductors with a TWIN ferrule	[mm ²]	-	-
Max. cross section with insertion bridge	[mm ²]	4	4
Stripping length	[mm]	8	
Screw thread		M3	
Tightening torque	[Nm]	0.6 - 0.8	
Insulating material		PA	
Flammability rating in accordance with UL 94		V0	

Description	No. of pos.	Color
Fuse terminal block , for mounting on NS 35..., for 5 x 20 cartridge fuse inserts		black
with LED for 12 - 30 V AC/DC, 0.7 - 1.95 mA ¹⁾		black
with LED for 30 - 60 V AC/DC, 0.9 - 1.8 mA ¹⁾		black
with LED display for 110 - 250 V AC/DC, 0.1 - 0.5 mA ¹⁾		black
Lever-type disconnect terminal block , same shape as UK 5-HESI N		black/orange
Feed-through terminal block , for mounting on NS 35...		gray/orange

Ordering data			
Type	I _{max}	Order No.	Pcs./Pkt.
UK 5-HESI N		3000539	50
UK 5-HESILED 24 N		3000540	50
UK 5-HESILED 60 N		3000541	50
UK 5-HESILA 250 N		3000542	50

Cover, width: 2.2 mm		
Insertion bridge , divisible, fully insulated		black
	2	gray
	3	gray
	10	gray
Screwdriver		

Accessories			
D-UK 5-HESI N		3000543	50
EBS 2- 8	14 A	3118151	100
EBS 3- 8	14 A	3118148	50
EBS 10- 8	14 A	3118135	10
SF-SL 0,6X3,5-100 S-VDE		1212587	10

Lateral groove labeling
UC-TM 8, UCT-TM 8 or ZB 8 (see Catalog 3)

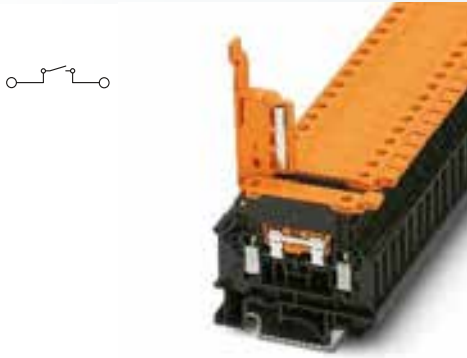

4 (6) mm², 16 A, lever-type disconnect terminal block, same shape

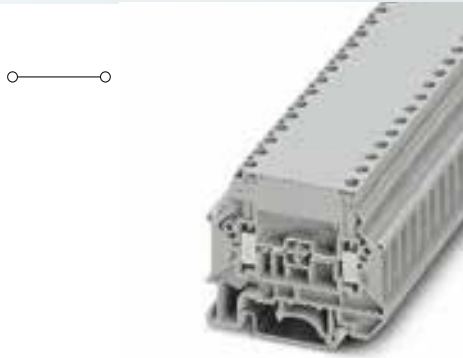

4 (6) mm², 32 A, feed-through terminal block, same shape



Technical data			
Width	Length	Height NS 35/7,5	
8.2	58	50	
Width	Length	Height NS 32	
8.2	58	55	
I _{max} [A]	U _{max} [V]	max. Ø [mm ²]	AWG (UL)
16	500	0.5 - 6	26-10
IEC 60947-7-1			
IEC	UL / CUL	CSA	IEC/ EN 60079-7
500	600	-	-
16 / 1.5	16	-	-
4	-	-	-
20 - 10	26-10	-	-
Rigid	Flexible	Ferrule without/with plastic sleeve	
0.5 - 6	0.5 - 4	0.5 - 4	0.5 - 2.5
0.5 - 1.5	0.5 - 1.5	0.5 - 1.5	-
-	-	-	0.5 - 1.5
4	4	-	-
9			
M3			
0.6 - 0.8			
PA			
V0			

Technical data			
Width	Length	Height NS 35/7,5	
8.2	58	40.3	
Width	Length	Height NS 32	
8.2	58	45.3	
I _{max} [A]	U _{max} [V]	max. Ø [mm ²]	AWG (UL)
32	800	0.2 - 6	20-10
IEC 60947-7-1			
IEC	UL / CUL	CSA	IEC/ EN 60079-7
800	600	-	-
32 / 4	30 / -	-	-
4	-	-	-
24 - 10	20-10	-	-
Rigid	Flexible	Ferrule without/with plastic sleeve	
0.2 - 6	0.2 - 4	0.25 - 4	0.25 - 2.5
0.2 - 1.5	0.2 - 1.5	0.25 - 1.5	-
-	-	-	0.5 - 2.5
4	4	-	-
8			
M3			
0.6 - 0.8			
PA			
V0			

Ordering data			
Type	I _{max}	Order No.	Pcs./Pkt.
UK 5-HEDI N		3000564	50
UK 5-HEDI N GY		3000752	50

Ordering data			
Type	I _{max}	Order No.	Pcs./Pkt.
UK 5-MTD N		3000562	50

Accessories			
D-UK 5-HESI N		3000543	50
EBS 2- 8	14 A	3118151	100
EBS 3- 8	14 A	3118148	50
EBS 10- 8	14 A	3118135	10
SF-SL 0,6X3,5-100 S-VDE		1212587	10
UC-TM 8, UCT-TM 8 or ZB 8 (see Catalog 3)			

Accessories			
D-UK 5-HESI N		3000543	50
EBS 2- 8	30 A	3118151	100
EBS 3- 8	30 A	3118148	50
EBS 10- 8	30 A	3118135	10
SF-SL 0,6X3,5-100 S-VDE		1212587	10
UC-TM 8, UCT-TM 8 or ZB 8 (see Catalog 3)			

Lever-type fuse terminal blocks UKK ...-HESI



- Safety lever locked in end position
- Large area for labeling
- For 5 mm and 6.3 mm cartridge fuse inserts
- Versions with LED display

Notes:
For further technical notes on power dissipation, refer to page 694.
1) If the fuse is faulty, the downstream circuit is not off load.
2) The current is determined by the fuse used, the voltage by the LED display. Observe max. power dissipation.

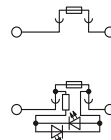

4 (4) mm², 6.3 A, lever-type fuse terminal block for 5 x 20 mm cartridge fuses



Dimensions		[mm]	
Width	8.2	Length	72.5
Height NS 35/7,5	56.5	Height NS 32	61.5
Maximum electrical data			
I _{max} [A]	6.3 ²⁾	U _{max} [V]	800 ²⁾
Rated data			
Rated voltage	[V]	800 ²⁾	600
Nominal current / cross section	[A] / [mm ²]	6.3 ²⁾ / 1	12 / -
Rated cross section	[mm ²]	4	-
Cross section range	AWG	24 - 12	26-10
Connection capacity			
1 conductor	[mm ²]	0.2 - 4	0.2 - 4
2 conductors (of the same type)	[mm ²]	0.2 - 1.5	0.2 - 1.5
2 flexible conductors with a TWIN ferrule	[mm ²]	-	-
Max. cross section with insertion bridge	[mm ²]	4	4
General data			
Fuse type / dimensions	- / [mm]	G / 5 x 20 / 5 x 25 / 5 x 30	
Stripping length	[mm]	8	
Screw thread		M3	
Tightening torque	[Nm]	0.6 - 0.8	
Insulating material		PA	
Flammability rating in accordance with UL 94		V0	

Technical data			
Width	Length	Height NS 35/7,5	
8.2	72.5	56.5	
Width	Length	Height NS 32	
8.2	72.5	61.5	
I _{max} [A]	U _{max} [V]	max. Ø [mm ²]	AWG (UL)
6.3 ²⁾	800 ²⁾	0.2 - 4	26-10
IEC 60947-7-3			
IEC	UL / CUL	CSA	IEC/ EN 60079-7
800 ²⁾	600	600	-
6.3 ²⁾ / 1	12 / -	6.3 / -	-
4	-	-	-
24 - 12	26-10	28-10	-
Connection capacity		Ferrule	
		without/with plastic sleeve	
1 conductor	[mm ²]	0.2 - 4	0.25 - 4
2 conductors (of the same type)	[mm ²]	0.2 - 1.5	0.25 - 1.5
2 flexible conductors with a TWIN ferrule	[mm ²]	-	0.5 - 1.5
Max. cross section with insertion bridge	[mm ²]	4	-

Description	No. of pos.	Color
Fuse terminal block , for mounting on NS 32... or NS 35..., for cartridge fuse inserts 5 x 20, 5 x 25 and 5 x 30 mm		black
with LED for 12-30 V AC/DC		black
with LED for 110-250 V AC/DC ¹⁾		black
Fuse terminal block , for mounting on NS 32... or NS 35..., for cartridge fuse inserts 6.3 x 32 mm.		black
with LED for 12-30 V AC/DC ¹⁾		black
with LED for 110-250 V AC/DC ¹⁾		black

Insertion bridge, divisible, fully insulated		
	2	gray
	3	gray
	10	gray

Screwdriver
Lateral groove labeling
Lever labeling

Ordering data			
Type	I _{max}	Order No.	Pcs./Pkt.
UK 5-HESI		3004100	50
UK 5-HESILED 24		3004126	50
UK 5-HESILA 250		3004142	50

Accessories			
EBS 2- 8	32 A	3118151	100
EBS 3- 8	32 A	3118148	50
EBS 10- 8	32 A	3118135	10
SF-SL 0,6X3,5-100 S-VDE		1212587	10

ZB 8 (see Catalog 3)



16 (16) mm², 10 A, lever-type fuse terminal block for 6.3 x 32 mm cartridge fuses



Technical data

Width	Length	Height NS 35/7,5	
10.2	79	60.5	
Width	Length	Height NS 32	
10.2	79	65.5	
I_{max} [A]	U_{max} [V]	max. Ø [mm ²]	AWG (UL)
10 ²	500 ²	0.5 - 16	26-8
IEC 60947-7-3			
IEC	UL / CUL	CSA	IEC/ EN 60079-7
500 ²	600	600	-
10 ² / 1.5	10 / -	25 / -	-
16	-	-	-
20 - 6	26-8	26-8	-
Rigid	Flexible	Ferrule without/with plastic sleeve	
0.5 - 16	0.5 - 16	0.5 - 10	0.5 - 10
0.5 - 4	0.5 - 4	0.5 - 4	-
-	-	-	0.5 - 6
10	10	-	-

G / 6,3 x 32
12
M4
1.2 - 1.5
PA
V0

Ordering data

Type	I_{max}	Order No.	Pcs./Pkt.
UK 6,3-HESI		3004171	50
UK 6,3-HESILED 24		3004265	50
UK 6,3-HESILA 250		3004249	50

Accessories

EB 2-10	63 A	0203153	100
SZS 1,0X4,0 VDE		1205066	10

ZB 10 (see Catalog 3)

ZB 8 (see Catalog 3)

Terminal blocks – Classic

UK universal modular terminal blocks

Double-level terminal blocks with safety levers UKK ...-HESI

- Compact double-level fuse terminal block
- Safety levers and each terminal point can be individually labeled
- For 5 mm and 6.3 mm cartridge fuse inserts
- Versions with LED display

Notes:
For further technical notes on power dissipation, refer to page 694.
1) If the fuse is faulty, the downstream circuit is not off load.
2) The current is determined by the fuse used, the voltage by the LED display. Observe max. power dissipation.

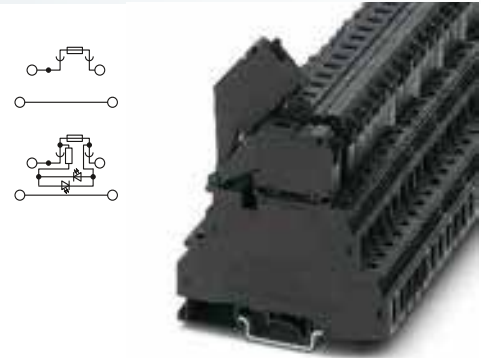

4 (4) mm², 32 A, double-level terminal block with fuse lever for 5 x 20 mm cartridge fuse



Dimensions		
		[mm]
Dimensions		
		[mm]
Maximum electrical data		
Rated data lower level		
Rated voltage	[V]	400 ²⁾
Nominal current / cross section	[A] / [mm ²]	32 ²⁾ / 4
Rated cross section	[mm ²]	4
Cross section range	AWG	24 - 12
Rated data, upper level		
Rated voltage	[V]	400 ²⁾
Nominal current / cross section	[A] / [mm ²]	6.3 ²⁾ / 1
Rated cross section	[mm ²]	4
Cross section range	AWG	24 - 12
Connection capacity		
1 conductor	[mm ²]	0.2 - 4
2 conductors (of the same type)	[mm ²]	0.2 - 1.5
2 flexible conductors with a TWIN ferrule	[mm ²]	-
Max. cross section with insertion bridge	[mm ²]	4
General data		
Fuse type / dimensions	- / [mm]	G / 5 x 20
Stripping length	[mm]	8
Screw thread		M3
Tightening torque	[Nm]	0.5 - 0.8
Insulating material		PA
Flammability rating in accordance with UL 94		V0

Technical data				
Width	Length	Height NS 35/7,5		
8.2	86.5	79		
Width	Length	Height NS 32		
8.2	86.5	84		
I _{max} [A]	U _{max} [V]	max. Ø [mm ²]	AWG (UL)	
32 ²⁾	400 ²⁾	0.2 - 4	26-10	
IEC 60947-7-1				
IEC	UL / CUL	CSA	IEC/EN 60079-7	
Rated voltage	[V]	400 ²⁾	600	300
Nominal current / cross section	[A] / [mm ²]	32 ²⁾ / 4	30 / -	15
Rated cross section	[mm ²]	4	-	-
Cross section range	AWG	24 - 12	26-10	28-10
IEC 60947-7-3				
IEC	UL / CUL	CSA	IEC/EN 60079-7	
Rated voltage	[V]	400 ²⁾	600	300
Nominal current / cross section	[A] / [mm ²]	6.3 ²⁾ / 1	15 / -	15 / -
Rated cross section	[mm ²]	4	-	-
Cross section range	AWG	24 - 12	26-10	28-10
Connection capacity		Rigid	Flexible	Ferrule
		without/with plastic sleeve		
1 conductor	[mm ²]	0.2 - 4	0.2 - 4	0.25 - 4
2 conductors (of the same type)	[mm ²]	0.2 - 1.5	0.2 - 1.5	0.25 - 1.5
2 flexible conductors with a TWIN ferrule	[mm ²]	-	-	0.5 - 1.5
Max. cross section with insertion bridge	[mm ²]	4	2.5	-

Description	No. of pos.	Color
Fuse terminal block , for mounting on NS 32... or NS 35..., for cartridge fuse inserts 5 x 20 mm		black
with LED for 15 - 30 V AC/DC, 0.98 - 2.4 mA ¹⁾		black
Fuse terminal block , for mounting on NS 32... or NS 35..., for cartridge fuse inserts 6.3 x 32 mm		black
with LED for 12 - 30 V DC, 0.31 - 0.95 mA ¹⁾		black

Ordering data			
Type	I _{max}	Order No.	Pcs./Pkt.
UKK 5-HESI (5X20)		3007204	50
UKK 5-HESILED 24 (5X20)		3026654	50

Fixed bridge , isolated	10	silver
Insertion bridge , divisible, fully insulated	2	gray
	3	gray
	10	gray
Screwdriver		
Lateral groove labeling		
Lever labeling		

Accessories			
FBRI 10-8 N	32 A	2772080	10
EBS 2- 8	32 A	3118151	100
EBS 3- 8	32 A	3118148	50
EBS 10- 8	32 A	3118135	10
SF-SL 0,6X3,5-100 S-VDE		1212587	10
ZB 8 (see Catalog 3)			
ZBF 8 (see Catalog 3)			

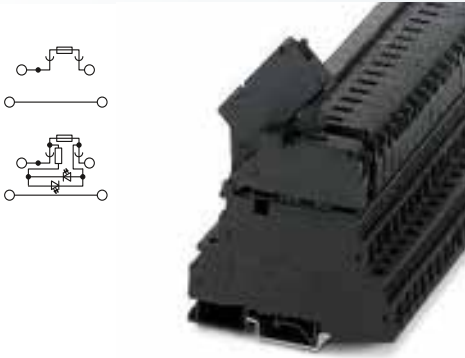

4 (4) mm², 32 A, double-level terminal block with fuse lever for 6.3 x 32 mm cartridge fuse



Technical data

Width	Length	Height NS 35/7,5	
8.2	86.5	79	
Width	Length	Height NS 32	
8.2	86.5	84	
I _{max} [A]	U _{max} [V]	max. Ø [mm ²]	AWG (UL)
32 ²	400 ²	0.2 - 4	26-10
IEC 60947-7-1			
IEC	UL / CUL	CSA	IEC/ EN 60079-7
400 ²	600	300	-
32 ² / 4	30 / -	15	-
4	-	-	-
24 - 12	26-10	28-10	-
IEC 60947-7-3			
IEC	UL / CUL	CSA	IEC/ EN 60079-7
400 ²	600	300	-
10 ² / 1.5	15 / -	15	-
4	-	-	-
24 - 12	26-10	28-10	-
Rigid	Flexible	Ferrule without/with plastic sleeve	
0.2 - 4	0.2 - 4	0.25 - 4	0.25 - 4
0.2 - 1.5	0.2 - 1.5	0.25 - 1.5	-
-	-	-	0.5 - 1.5
4	2.5	-	-

G / 6,3 x 32
8
M3
0.5 - 0.8
PA
V0

Ordering data

Type	I _{max}	Order No.	Pcs./Pkt.
UKK 5-HESI (6,3X32)		3007217	50
UKK 5-HESILED 24 (6,3X32)		0711632	50

Accessories

Accessories	I _{max}	Order No.	Pcs./Pkt.
FBRI 10-8 N	32 A	2772080	10
EBS 2- 8	32 A	3118151	100
EBS 3- 8	32 A	3118148	50
EBS 10- 8	32 A	3118135	10
SF-SL 0,6X3,5-100 S-VDE		1212587	10

ZB 8 (see Catalog 3)

ZBF 8 (see Catalog 3)

Fuse terminal blocks with screw cap UK 10-DREHSI

- Bridgeable with fixed bridge FBI ...
- Fuse terminal block with screw cap for 5 x 20, 5 x 25 or 6.3 x 32 mm fuse inserts
- Versions with LED display for indicating that a fuse has tripped
- When selecting and using cartridge fuse terminal inserts, IEC 60127-6/ DIN EN 60127-6 should be observed
- UK 10-DREHSI/K is suitable for fuse inserts with indicator pins. The transparent screen on the screw cap allows the tripped fuse to be quickly identified in these inserts

Notes:
For further technical notes on power dissipation, refer to page 694
1) If the fuse is faulty, the downstream circuit is not off load.
2) The current is determined by the fuse used, the voltage by the LED display. Observe max. power dissipation.

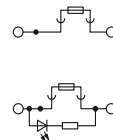

16 (16) mm², 10 A, fuse terminal block for 5 x 20 mm cartridge fuses



Dimensions	
	[mm]
Dimensions	
	[mm]
Maximum electrical data	
Rated data	
Rated voltage	[V]
Nominal current / cross section	[A] / [mm ²]
Rated cross section	[mm ²]
Cross section range	AWG
Connection capacity	
1 conductor	[mm ²]
2 conductors (of the same type)	[mm ²]
2 flexible conductors with a TWIN ferrule	[mm ²]
Max. cross section with insertion bridge	[mm ²]
General data	
Fuse type / dimensions	- / [mm]
Stripping length	[mm]
Screw thread	
Tightening torque	[Nm]
Insulating material	
Flammability rating in accordance with UL 94	

Technical data			
Width	Length	Height NS 35/7,5	
12	62	57.2	
Width	Length	Height NS 32	
12	62	62.2	
I _{max} [A]	U _{max} [V]	max. Ø [mm ²]	AWG (UL)
10 ²	500 ²	0.5 - 16	24-6
IEC 60947-7-3			
IEC	UL / CUL	CSA	IEC/EN 60079-7
Rated voltage	500 ²	300	300
Nominal current / cross section	10 ² / 1.5	20 / -	20 / -
Rated cross section	16	-	-
Cross section range	20 - 6	24-6	22-6
Connection capacity		Rigid	Flexible
1 conductor	[mm ²]	0.5 - 16	0.5 - 16
2 conductors (of the same type)	[mm ²]	0.5 - 4	0.5 - 4
2 flexible conductors with a TWIN ferrule	[mm ²]	-	-
Max. cross section with insertion bridge	[mm ²]	10	10
General data		Ferrule	
Fuse type / dimensions	- / [mm]	without/with plastic sleeve	
Stripping length	[mm]	G / 5 x 20	
Screw thread		11	
Tightening torque	[Nm]	M4	
Insulating material		1.5 - 1.8	
Flammability rating in accordance with UL 94		PA	
		V0	

Description	No. of pos.	Color
Fuse terminal block , for mounting on NS 32... or NS 35..., for cartridge fuse inserts 5 x 20, 5 x 25, 6.3 x 32 mm		black
.../K with indicator pin		black
Fuse terminal block , for mounting on NS 32... or NS 35..., for cartridge fuse inserts 5 x 20, 6.3 x 32 mm, with LED display for 5 - 15 V DC ¹)		black
Fuse terminal block , for mounting on NS 32... or NS 35..., for cartridge fuse inserts 5 x 20, 6.3 x 32 mm, with LED display for 15 - 30 V DC ¹)		black
Fuse terminal block , for mounting on NS 32... or NS 35..., for cartridge fuse inserts 5 x 20, 6.3 x 32 mm, with LED display for 30 - 60 V DC ¹)		black
Fuse terminal block , for mounting on NS 32... or NS 35..., for cartridge fuse inserts 5 x 20, 6.3 x 32 mm, with LED display for 110 - 250 V DC ¹)		black

Ordering data			
Type	I _{max}	Order No.	Pcs./Pkt.
UK 10-DREHSI (5X20)		3005109	50
UK 10-DREHSILED 12 (5X20)		3005112	50
UK 10-DREHSILED 24 (5X20)		3005138	50
UK 10-DREHSILED 60 (5X20)		3005154	50
UK 10-DREHSILA 250 (5X20)		3005170	50

Fixed bridge , isolated	10	silver
Insertion bridge , fully insulated	10	gray
Test socket , for test connection with test plug PS		silver
Test socket , insulated, for UK 6 N, UK 10 N and URTK/SP and USST 10 terminal blocks, M4 thread		transparent
Screwdriver		
Lateral groove labeling		

Accessories			
FBI 10-12	63 A	0203454	10
EB 10-12	63 A	3006137	10
PSB 4/7/6		0303299	10
PSBJ 4/15/6 FARBLOS		0303419	10
SZS 1,0X4,0 VDE		1205066	10
ZB 6 (see Catalog 3)			

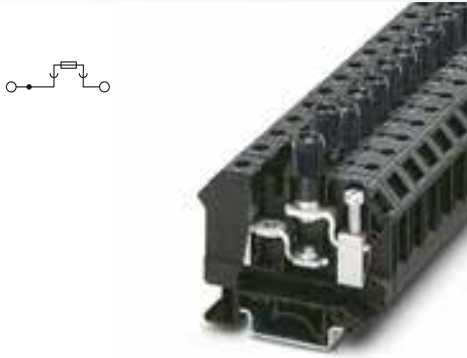

16 (16) mm², 10 A, fuse terminal block
for 5 x 25 mm cartridge fuses with indicating pin

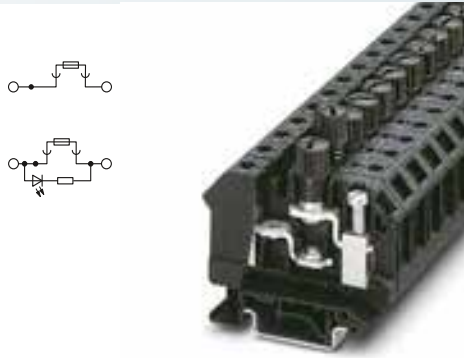

16 (16) mm², 10 A, fuse terminal block
for 6.3 x 32 mm cartridge fuses



Technical data			
Width	Length	Height NS 35/7,5	
12	62	57.2	
Width	Length	Height NS 32	
12	62	62.2	
I_{max} [A]	U_{max} [V]	max. Ø [mm ²]	AWG (UL)
10 ²)	500 ²)	0.5 - 16	24-6
IEC 60947-7-3			
IEC	UL / CUL	CSA	IEC/ EN 60079-7
500 ²)	300	-	-
10 ²) / 1.5	20 / -	-	-
16	-	-	-
20 - 6	24-6	-	-
Rigid	Flexible	Ferrule without/with plastic sleeve	
0.5 - 16	0.5 - 16	0.5 - 10	0.5 - 10
0.5 - 4	0.5 - 4	0.5 - 4	-
-	-	-	0.5 - 10
10	10	-	-
G / 5 x 25			
11			
M4			
1.5 - 1.8			
PA			
V2			

Technical data			
Width	Length	Height NS 35/7,5	
12	62	57.2	
Width	Length	Height NS 32	
12	62	62.2	
I_{max} [A]	U_{max} [V]	max. Ø [mm ²]	AWG (UL)
10 ²)	400 ²)	0.5 - 16	24-6
IEC 60947-7-3			
IEC	UL / CUL	CSA	IEC/ EN 60079-7
400 ²)	300	300	-
10 ²) / 1.5	20 / -	20 / -	-
16	-	-	-
20 - 6	24-6	22-6	-
Rigid	Flexible	Ferrule without/with plastic sleeve	
0.5 - 16	0.5 - 16	0.5 - 10	0.5 - 10
0.5 - 4	0.5 - 4	0.5 - 4	-
-	-	-	0.5 - 10
10	10	-	-
G / 6,3 x 32			
11			
M4			
1.5 - 1.8			
PA			
V2			

Ordering data			
Type	I_{max}	Order No.	Pcs./Pkt.
UK 10-DREHSI/K (5X25)		3005688	50

Ordering data			
Type	I_{max}	Order No.	Pcs./Pkt.
UK 10-DREHSI (6,3X32)		3005507	50
UK 10-DREHSILED 24 (6,3X32)		3005646	50
UK 10-DREHSILA 250 (6,3X32)		3005662	50

Accessories			
FBI 10-12	63 A	0203454	10
EB 10-12	63 A	3006137	10
PSB 4/7/6		0303299	10
PSBJ 4/15/6 FARBLOS		0303419	10
SZS 1,0X4,0 VDE		1205066	10
ZB 6 (see Catalog 3)			

Accessories			
FBI 10-12	63 A	0203454	10
PSB 4/7/6		0303299	10
PSBJ 4/15/6 FARBLOS		0303419	10
SZS 1,0X4,0 VDE		1205066	10
ZB 6 (see Catalog 3)			

Terminal blocks – Classic

UK universal modular terminal blocks

UK-SI and USIG fuse terminal blocks

– In the case of the UK-SI fuse terminal block, the cartridge fuse-links are connected with the integrated connector in the terminal block

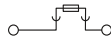

4 (4) mm², 6.3 A, fuse terminal block for 5 x 20 mm and 5 x 25 mm cartridge fuses

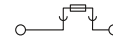

16 (16) mm², 40 A, basic fuse terminal block for cartridge fuse connectors or isolating connectors

Notes:
1) If the fuse is faulty, the downstream circuit is not off load.
2) The current and voltage are determined by the fuse.
For further technical notes on power dissipation, refer to page 694.
Attention: The cartridge fuse holders should be selected in accordance with the maximum power dissipation (self-heating) of the cartridge fuse inserts.
For more insertion bridges, visit phoenixcontact.net/products



Dimensions		[mm]	
Dimensions			
Maximum electrical data			
Rated data			
Rated voltage	[V]	400 ²⁾	300
Nominal current / cross section	[A] / [mm ²]	6.3 ²⁾ / 1	10 / -
Rated cross section	[mm ²]	4	-
Cross section range	AWG	24 - 12	28-12
Connection capacity		Rigid	Flexible
1 conductor	[mm ²]	0.2 - 4	0.2 - 4
2 conductors (of the same type)	[mm ²]	0.2 - 1.5	0.2 - 1.5
2 flexible conductors with a TWIN ferrule	[mm ²]	-	-
General data			
Fuse type / dimensions	- / [mm]	G / 5 x 20 / 5 x 25	
Stripping length	[mm]	9	
Screw thread		M3	
Tightening torque	[Nm]	0.6 - 0.8	
Insulating material		PA	
Flammability rating in accordance with UL 94		V0	

Technical data			
Width	Length	Height NS 35/7,5	
8.2	59.5	58	
Width	Length	Height NS 32	
8.2	59.5	63	
I _{max} [A]	U _{max} [V]	max. Ø [mm ²]	AWG (UL)
6.3 ²⁾	400 ²⁾	0.2 - 4	28-12
IEC 60947-7-3	UL / CUL	CSA	IEC/ EN 60079-7
Rated voltage	300	250	-
Nominal current / cross section	10 / -	10 / -	-
Rated cross section	-	-	-
Cross section range	24 - 14	24 - 14	-
Connection capacity			Ferrule
1 conductor	0.2 - 4	0.25 - 4	0.25 - 4
2 conductors (of the same type)	0.2 - 1.5	0.25 - 1.5	-
2 flexible conductors with a TWIN ferrule	-	-	0.5 - 2.5
General data			
Fuse type / dimensions	G / 5 x 20 / 5 x 25		
Stripping length	9		
Screw thread	M3		
Tightening torque	0.6 - 0.8		
Insulating material	PA		
Flammability rating in accordance with UL 94	V0		

Technical data			
Width	Length	Height NS 35/7,5	
10.2	61	51.6	
Width	Length	Height NS 32	
10.2	61	56.6	
I _{max} [A]	U _{max} [V]	max. Ø [mm ²]	AWG (UL)
40 ²⁾	500 ²⁾	0.5 - 16	18-8
IEC 60947-7-3	UL / CUL	CSA	IEC/ EN 60079-7
Rated voltage	600	600	-
Nominal current / cross section	40 / -	40 / -	-
Rated cross section	-	-	-
Cross section range	20 - 6	18-8	24-8
Connection capacity			Ferrule
1 conductor	0.5 - 16	0.5 - 16	0.5 - 16
2 conductors (of the same type)	0.5 - 4	0.5 - 6	0.5 - 6
2 flexible conductors with a TWIN ferrule	-	-	0.5 - 6
General data			
Fuse type / dimensions	G / 5 x 20 / 5 x 25 / 5 x 30 / 6.3 x 32		
Stripping length	13		
Screw thread	M4		
Tightening torque	1.5 - 1.8		
Insulating material	PA		
Flammability rating in accordance with UL 94	V0		

Description	No. of pos.	Color
Fuse terminal block , for mounting on NS 32... or NS 35..., for cartridge fuse inserts 5 x 20, 5 x 25 mm		black
		blue
Basic fuse terminal block , for mounting on NS 32... or NS 35...		black
		blue

Ordering data			
Type	I _{max}	Order No.	Pcs./Pkt.
UK-SI		3118012	50
UK-SI BU		3118096	50

Ordering data			
Type	I _{max}	Order No.	Pcs./Pkt.
USIG		0920083	50
USIG BU		0920122	50

Accessories		
Insertion bridge, insulated	10	gray
Isolating connector		
Fuse connector , for G fuse inserts, 6.3 x 32 mm, nominal voltage 440 V		black
Fuse connector , with LED display, for cartridge fuse inserts 6.3 x 32 mm, nominal voltage 440 V ¹⁾ for 15 - 30 V AC/DC, 3.2 - 7.5 mA		black
for 110 - 250 V AC/DC, 0.1 - 0.9 mA		black
Fuse connector , for cartridge fuse inserts 5 x 20, 5 x 25, 5 x 30 mm		black
Fuse connector , for G fuse inserts 5 x 20, 5 x 25, 5 x 30 mm, with LED display for 15 - 30 V AC/DC, 3.2 - 7.5 mA, I _{max} 6.3 A ¹⁾		black
for 110 - 250 V AC/DC, 0.1 - 0.9 mA, I _{max} 6.3 A		black
Separating disk, 0.8 mm wide		gray
Screwdriver		
LF-SL 0,6X3,5-100 S-VDE		
LF 8 (see Catalog 3)		

Accessories			
EBS 10-8	32 A	3118135	10
EB 10-10	76 A	0203137	10
ST-T	40 A	0920216	50
ST 1-SI	10 A	0920326	50
ST 1-SILED 24	10 A	0920384	50
ST 1-SILA 250	10 A	0920397	50
ST-SI	6.3 A	0920229	50
ST-SILED 24		0920452	50
ST-SILA250		0920287	50
ATS-GSK		0304227	50
SZS 1,0X4,0 VDE		1205066	10
ZB 10 (see Catalog 3)			

Accessories			
EBS 10-8	32 A	3118135	10
EB 10-10	76 A	0203137	10
ST-T	40 A	0920216	50
ST 1-SI	10 A	0920326	50
ST 1-SILED 24	10 A	0920384	50
ST 1-SILA 250	10 A	0920397	50
ST-SI	6.3 A	0920229	50
ST-SILED 24		0920452	50
ST-SILA250		0920287	50
ATS-GSK		0304227	50
SZS 1,0X4,0 VDE		1205066	10
ZB 10 (see Catalog 3)			

Fuse terminal block UK 6-FSI/C, for type C flat-type fuses



- Compact fuse terminal block for type C automotive flat-type fuses
- Available with LED display for rapid error diagnostics
- Bridgeable with fixed bridge FBI ...
- Large-surface marking options of every terminal point
- Can be used as the basic terminal block for thermal circuit breaker TCP .../DC32V; see Catalog 4
- Type F automotive flat-type fuse terminal blocks are also available in the “PT Push-in connection terminal blocks” section

Notes:

1) If the fuse is faulty, the downstream circuit is not off load.

2) For derating curve, visit phoenixcontact.net/products

3) The current and voltage are determined by the fuse.

For corresponding fuse inserts, see Catalog 4.

The recommended continuous load capacity of the fuse inserts in accordance with DIN 72581/Part 3 is max. 80 percent of their nominal current (at an ambient temperature of 23°C)

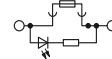
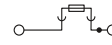

6 (10) mm², 30 A, fuse terminal block for type C flat-type fuses



Technical data

Dimensions		Width	Length	Height NS 35/7,5	
Dimensions [mm]		8.2	64	53.8	
Dimensions [mm]		8.2	64	58.8	
Maximum electrical data					
Maximum electrical data		I_{max} [A]	U_{max} [V]	max. Ø [mm ²]	AWG (UL)
		30 ²⁾	250 ³⁾	0.2 - 10	26-8
Rated data					
Rated data		Rated voltage [V]	250 ³⁾	300	32
		Nominal current / cross section [A] / [mm ²]	30 ¹⁾ / 4	30 / -	30 / -
		Rated cross section [mm ²]	6	-	-
		Cross section range AWG	24 - 8	26-8	26-8
Connection capacity					
Connection capacity		1 conductor [mm ²]	0.2 - 10	0.2 - 6	0.25 - 6
		2 conductors (of the same type) [mm ²]	0.2 - 2.5	0.2 - 2.5	0.25 - 2.5
		2 flexible conductors with a TWIN ferrule [mm ²]	-	-	-
General data					
General data		Fuse type / dimensions - / [mm]	C		
		Stripping length [mm]	10		
		Screw thread	M4		
		Tightening torque [Nm]	1.5 - 1.6		
		Insulating material	PA		
		Flammability rating in accordance with UL 94	V0		

Ordering data

Description	No. of pos.	Color	Type	I_{max}	Order No.	Pcs./Pkt.
Fuse terminal block, for mounting on NS 32... or NS 35...		black	UK 6-FSI/C		3118203	50
Fuse terminal block, for mounting on NS 32... or NS 35..., with LED for 12 V DC, 1.7 mA ¹⁾		black	UK 6-FSI/C-LED12		3001925	50
with LED display for 24 V DC, 1.9 mA ¹⁾		black	UK 6-FSI/C-LED24		3001938	50

Accessories

Fixed bridge, isolated	10	silver	FBI 10- 8	34 A	0203263	10
Insertion bridge, fully insulated	2	gray	EB 2- 8	57 A	0202154	100
	3	gray	EB 3- 8	57 A	0202141	100
	4	gray	EB 4- 8	57 A	0202142	100
	10	gray	EB 10- 8	57 A	0202138	10
Isolator bridge bar, divisible, with 10 screws, for switchable branches with IS-K...	10	silver	ISSBI 10- 8	38 A	0301534	10
Bridge bar isolator, as distance piece for isolator bridge bar		gray	IS-K 10		1303337	100
Separating disk, for separation of neighboring bridges, can be fitted later, no loss of pitch		gray	TS-KK 3		2770215	50
Screwdriver			SZS 1,0X4,0 VDE		1205066	10
Lateral groove labeling			ZB 8 (see Catalog 3)			



Terminal blocks – Classic

UK universal modular terminal blocks

UK 10,3-HESI lever-type fuse terminal blocks

- The UK 10,3-HESI fuse terminal blocks are used for accommodating midjet fuse-links in accordance with IEC 60269 or Class CC fuse-links in accordance with UL 4248-4
- Insertion bridges are available with up to 56 positions
- Tripped fuse-links are signaled via an LED display
- Connection pins for simultaneous switching of two or three positions
- Spacers for higher-temperature applications

Notes:
For detailed information on applications and power dissipation data, see phoenixcontact.net/products
1) If the fuse is faulty, the downstream circuit is not off load.
2) The current and voltage are determined by the fuse.

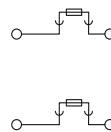

16 (25) mm², 32 A, lever-type fuse terminal block for 10.3 x 38 mm midjet fuses

Dimensions	
	[mm]
Maximum electrical data	
Rated data	
Rated voltage	[V]
Nominal current / cross section	[A] / [mm ²]
Rated cross section	[mm ²]
Cross section range	AWG
Connection capacity	
1 conductor	[mm ²]
2 conductors (of the same type)	[mm ²]
2 flexible conductors with a TWIN ferrule	[mm ²]
Max. cross section with insertion bridge	[mm ²]
General data	
Fuse type / dimensions	- / [mm]
Stripping length	[mm]
Screw thread	
Tightening torque	[Nm]
Insulating material	
Flammability rating in accordance with UL 94	

Technical data				
Width	Length	Height NS 35/7,5		
17.8	80.7	68.3		
I _{max} [A]	U _{max} [V]	max. Ø [mm ²]	AWG (UL)	
32 ²⁾	690 ²⁾	0.75 - 25	-	
IEC 60947-1/-3				
IEC	UL / CUL	CSA	IEC/EN 60079-7	
690 ²⁾	-	-	-	
32 ²⁾ / 16	-	-	-	
16	-	-	-	
16 - 3	-	-	-	
Connection capacity		Ferrule		
	Rigid	Flexible	without/with plastic sleeve	
1 conductor	0.75 - 25	0.75 - 25	0.75 - 16	0.75 - 16
2 conductors (of the same type)	0.75 - 10	0.75 - 10	0.75 - 6	-
2 flexible conductors with a TWIN ferrule	-	-	-	-
Max. cross section with insertion bridge	10	10	-	-
General data		10.3 x 38 mm		
Fuse type / dimensions	- / [mm]	12		
Stripping length	[mm]	M4		
Screw thread		1.5 - 1.8		
Tightening torque	[Nm]	PA		
Insulating material		V0		
Flammability rating in accordance with UL 94				

Description	No. of pos.	Color
Fuse terminal block , for mounting on NS 35..., for 10.3 x 38 mm midjet fuse inserts, 690 V AC/440 V DC		black
with LED display ¹⁾		black
Fuse terminal block , for mounting on NS 35..., for fuse inserts CLASS CC 10.3 x 38 mm		black
2-pos.		black
3-pos.		black
with LED display ¹⁾		black
2-pos.		black
3-pos.		black

Ordering data			
Type	I _{max}	Order No.	Pcs./Pkt.
UK 10,3-HESI A		1045676	10
UK 10,3-HESILED A 690V		1045690	10

Insertion bridge, divisible, insulated spine		
1-phase	gray	
1-phase	gray	
1-phase	gray	
1-phase	gray	
1-phase	gray	
1-phase	gray	
Insertion bridge, width: 22 mm, can be disconnected, comb back isolated		
1-phase	gray	
1-phase	gray	
1-phase	gray	
1-phase	gray	
Insulation cover, for bridges		
	gray	
Connection pin, for connecting several fuse terminal blocks, 2-pos.		
3-pos.	silver	
Spacer for neighboring fuse terminal block, width: 4.5 mm		
	gray	

Accessories			
Type	I _{max}	Order No.	Pcs./Pkt.
EB 2-18 A	76 A	3009310	10
EB 3-18 A	76 A	3009311	10
EB 4-18 A	76 A	3009313	10
EB 8-18 A	76 A	3009314	10
EB 16-18 A	76 A	1006832	10
EB 56-18 A	76 A	3009315	10
EB 4-22 A	76 A	3009316	10
EB 8-22 A	76 A	3009318	10
EB 16-22 A	76 A	1006839	10
EB 56-22 A	76 A	3009319	10
D-EB 18/22 A		3009320	10
VS-UK 10,3-HESI A 2POL		1045725	10
VS-UK 10,3-HESI A 3POL		1045726	10
DP-UK 10,3-HESI A		1045724	10

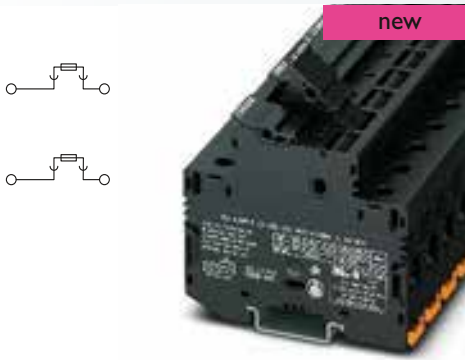

25 (25) mm², 30 A, lever-type fuse terminal block for CLASS CC 10.3 x 38 mm

Technical data

Width	Length	Height NS 35/7,5	
17.8	80.7	68.3	
I_{max} [A]	U_{max} [V]	max. Ø [mm ²]	AWG (UL)
30 ²)	600 ²)	0.75 - 25	-
IEC	UL / CUL	CSA	IEC/ EN 60079-7
600 ²)	-	-	-
30 ²) / 16	-	-	-
16	-	-	-
16 - 3	-	-	-
Rigid	Flexible	Ferrule without/with plastic sleeve	
0.75 - 25	0.75 - 25	0.75 - 16	0.75 - 16
0.75 - 10	0.75 - 10	0.75 - 6	-
-	-	-	-
10	10	-	-
Class CC			
12			
M4			
1.5 - 1.8			
PA			
V0			

Ordering data

Type	I_{max}	Order No.	Pcs./Pkt.
UK 10,3-CC HESI A		1045682	10
UK 10,3-CC HESI A 2POL		1045693	10
UK 10,3-CC HESI A 3POL		1045698	10
UK 10,3-CC HESILED A 600V		1045716	10
UK 10,3-CC HESILED A 600V 2POL		1045718	10
UK 10,3-CC HESILED A 600V 3POL		1045719	10

Accessories

EB 2-18 A	76 A	3009310	10
EB 3-18 A	76 A	3009311	10
EB 4-18 A	76 A	3009313	10
EB 8-18 A	76 A	3009314	10
EB 16-18 A	76 A	1006832	10
EB 56-18 A	76 A	3009315	10
EB 4-22 A	76 A	3009316	10
EB 8-22 A	76 A	3009318	10
EB 16-22 A	76 A	1006839	10
EB 56-22 A	76 A	3009319	10
D-EB 18/22 A		3009320	10
VS-UK 10,3-HESI A 2POL		1045725	10
VS-UK 10,3-HESI A 3POL		1045726	10
DP-UK 10,3-HESI A		1045724	10

Terminal blocks – Classic

UK universal modular terminal blocks

Lever-type fuse terminal blocks for photovoltaics UK 10.3-HESI A 1000 V

- Terminal blocks for protecting PV lines
- Suitable for PV fuse-links in accordance with IEC 60269-6
- Dielectric strength up to 1000 V DC
- Light indicator indicates that a fuse has tripped
- The spacers are used for improved heat dissipation, particularly when installing the fuse terminal blocks in compact control boxes

Fuses

- Fuse with gPV characteristic in accordance with IEC 60269-6
- Use in PV lines with a nominal voltage of up to 1000 V DC
- Safe shutdown even in the event of short-circuit currents that are just above the nominal current

Notes:
For tools for stripping and crimping solar cables and connectors, see Catalog 3.
Disconnect terminal blocks with 1000 V and diode terminal blocks STME ... HV see page 237.
For test disconnect terminal block PTME 6 HV, see page 348.
For detailed information on PV applications and power dissipation data, see phoenixcontact.net/products
For further fuse inserts with UL approval, see phoenixcontact.net/ul
1) If the fuse is faulty, the downstream circuit is not off load.
2) The current and voltage are determined by the fuse.

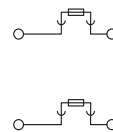

25 (25) mm², 32 A, 1000 V, lever-type fuse terminal block for midget fuses 10.3 x 38 mm

Dimensions		[mm]
Maximum electrical data		
Rated data		
Connection capacity		
General data		

Technical data				
Width	Length	Height NS 35/7,5		
17.8	80.7	68.3		
I _{max} [A]	U _{max} [V]	max. ∅ [mm ²]	AWG (UL)	
32 ²	1000 ²	0.75 - 25	-	
IEC 60269-1/-2				
IEC	UL / CUL	CSA	IEC/EN 60079-7	
Rated voltage	Nominal current / cross section	Rated cross section	Cross section range	
1000 ²	32 / 16	16	16 - 3	
Connection capacity		Ferrule		
		without/with plastic sleeve		
1 conductor	2 conductors (of the same type)	2 flexible conductors with a TWIN ferrule	Max. cross section with insertion bridge	
[mm ²]	[mm ²]	[mm ²]	[mm ²]	
0.75 - 25	0.75 - 10	-	10	
General data				
Fuse type / dimensions	Stripping length	Screw thread	Tightening torque	Insulating material
- / [mm]	[mm]	M4	[Nm]	PA
10:3 x 38 mm	12 - 14		1.5 - 1.8	V0
Flammability rating in accordance with UL 94				

Description	No. of pos.	Color
Fuse terminal block , for mounting on NS 35..., for Midget fuse inserts (10.3 x 38 mm ¹)		black
with LED for 400 - 1000 V DC		black
Midget fuse , 10.3 x 38 mm, nominal current: 2 A		white
Nominal current: 4 A		white
Nominal current: 6 A		white
Nominal current: 8 A		white
Nominal current: 10 A		white
Nominal current: 12 A		white
Nominal current: 16 A		white
Nominal current: 20 A		white
Nominal current: 25 A		white

Ordering data			
Type	I _{max}	Order No.	Pcs./Pkt.
UK 10,3-HESI A 1000V		1045720	10
UK 10,3-HESILED A 1000V		1045723	10



Insertion bridge, divisible, insulated spine		
1-phase		gray
1-phase		gray
1-phase		gray
1-phase		gray
1-phase		gray
1-phase		gray
Insertion bridge , width: 22 mm, can be disconnected, comb back isolated		
1-phase		gray
1-phase		gray
1-phase		gray
1-phase		gray
Insulation cover , for bridges		
		gray
Spacer for neighboring fuse terminal block, width: 4.5 mm		
		gray

Accessories			
Type	I _{max}	Order No.	Pcs./Pkt.
EB 2-18 A	76 A	3009310	10
EB 3-18 A	76 A	3009311	10
EB 4-18 A	76 A	3009313	10
EB 8-18 A	76 A	3009314	10
EB 16-18 A	76 A	1006832	10
EB 56-18 A	76 A	3009315	10
EB 4-22 A	76 A	3009316	10
EB 8-22 A	76 A	3009318	10
EB 16-22 A	76 A	1006839	10
EB 56-22 A	76 A	3009319	10
D-EB 18/22 A		3009320	10
DP-UK 10,3-HESI A		1045724	10



10.3 x 38 mm midget fuse inserts,
2 A – 20 A

ERIC

Technical data

Width	Length	Height NS 35/7,5	
-	38	-	
U _{max.} [V]	max. Ø [mm ²]	AWG (UL)	
1000	-	-	
IEC 60269-6			
IEC	UL / CUL	CSA	IEC/ EN 60079-7
1000	-	-	-
2 / -	-	-	-
-	-	-	-
-	-	-	-
Rigid	Flexible	Ferrule without/with plastic sleeve	
-	-	-	-
-	-	-	-
-	-	-	-
-	-	-	-
V0			

Ordering data

Type	Order No.	Pcs./Pkt.
FUSE 10,3X38 2A PV	3061295	10
FUSE 10,3X38 4A PV	3061305	10
FUSE 10,3X38 6A PV	3061318	10
FUSE 10,3X38 8A PV	3061321	10
FUSE 10,3X38 10A PV	3061334	10
FUSE 10,3X38 12A PV	3061347	10
FUSE 10,3X38 16A PV	3061350	10
FUSE 10,3X38 20A PV	3061363	10
FUSE 10,3X38 25A PV	3061364	10

Accessories

Type	Order No.	Pcs./Pkt.

Terminal blocks – Classic

UK universal modular terminal blocks

UK screw connection lever-type fuse terminal block for photovoltaics, 1500 V

Fuse terminal block

- Terminal block for protecting PV strings in accordance with IEC 60947-3 / IEC 60269
- Suitable for PV fuse-links in accordance with IEC 60269-6
- Dielectric strength up to 1500 V DC
- Generous labeling options for the unique identification of lines

Fuses

- Fuse with gPV characteristic in accordance with IEC 60269-6
- Use in PV lines with a nominal voltage of up to 1500 V DC
- Safe shutdown even in the event of short-circuit currents that are just above the nominal current

Notes:
The rated voltage is 1250 V and the maximum operating voltage is 1500 V.
Higher ambient temperatures are an additional strain on fuse inserts. In applications of this kind, the shift of the rated current should be taken into consideration accordingly.
For tools for stripping and crimping solar cables and connectors, see Catalog 3.
For detailed information on applications and power dissipation data, see phoenixcontact.net/products
¹⁾ The current and voltage are determined by the fuse.
²⁾ Maximum operating voltage 1500 V.

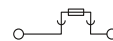

25 (25) mm², 32 A, 1500 V, lever-type fuse terminal block for midget fuses 10.3 x 85 mm

Dimensions			
		[mm]	
Maximum electrical data			
Rated data			
Rated voltage	[V]	1500 ²⁾	
Nominal current / cross section	[A] / [mm ²]	32 ¹⁾ / 16	
Rated cross section	[mm ²]	25	
Cross section range	AWG	14 - 4	
Connection capacity			
1 conductor	[mm ²]	2.5 - 25	
2 conductors (of the same type)	[mm ²]	0.75 - 10	
2 flexible conductors with a TWIN ferrule	[mm ²]	-	
General data			
Fuse type / dimensions	- / [mm]	gG / gPV / 10.3 x 85	
Stripping length	[mm]	14	
Screw thread		M5	
Tightening torque	[Nm]	-2.5	
Insulating material		PA	

Technical data				
Width	Length	Height NS 35/7,5		
23	130	65.5		
I _{max} [A]	U _{max} [V]	max. Ø [mm ²]	AWG (UL)	
32 ¹⁾	1500 ²⁾	2.5 - 25	-	
IEC 60269-1/-2				
IEC	UL / CUL	CSA	IEC/EN 60079-7	
Rated voltage				
1500 ²⁾		-	-	-
Nominal current / cross section				
32 ¹⁾ / 16		-	-	-
Rated cross section				
25		-	-	-
Cross section range				
14 - 4		-	-	-
Connection capacity				
		Rigid	Flexible	Ferrule without/with plastic sleeve
1 conductor		2.5 - 25	2.5 - 25	2.5 - 16 / 2.5 - 16
2 conductors (of the same type)		0.75 - 10	0.75 - 10	0.75 - 10 / -
2 flexible conductors with a TWIN ferrule		-	-	- / -
General data				
Fuse type / dimensions		- / [mm]	gG / gPV / 10.3 x 85	
Stripping length		[mm]	14	
Screw thread			M5	
Tightening torque		[Nm]	-2.5	
Insulating material			PA	

Description	Color
Fuse terminal block , for mounting on NS 35..., for 10 x 85 mm cartridge fuse inserts	black
Midget fuse , 10.3 x 85 mm, 1500 V, nominal current: 2 A	white
Nominal current: 4 A	white
Nominal current: 6 A	white
Nominal current: 8 A	white
Nominal current: 10 A	white
Nominal current: 12 A	white
Nominal current: 16 A	white
Midget fuse , 10.3 x 85 mm, 1200 V, nominal current: 20 A	white
Nominal current: 25 A	white

Ordering data		
Type	Order No.	Pcs./Pkt.
UK 10,3-HESI A 1500V	1069842	5

Partition plate , 2 mm wide	gray
Screwdriver	
Center groove labeling	

Accessories		
TPN-UK	3003062	10
SF-SL 0,6X3,5-100 S-VDE	1212587	10
EML (16,5X5)R (see Catalog 3)		





Fuse insert, 10.3 x 85 mm, 2 - 16 A, 1500 V



Fuse insert, 10.3 x 85 mm, 20 - 25 A, 1200 V

ERC

ERC

Technical data			
Width	Length	Height NS 35/7,5	
-	85	-	
U _{max.} [V]	max. Ø [mm ²]	AWG (UL)	
1500	-	-	
IEC 60269-6			
IEC	UL / CUL	CSA	IEC/ EN 60079-7
1500	-	-	-
2 / -	-	-	-
-	-	-	-
-	-	-	-
Rigid	Flexible	Ferrule without/with plastic sleeve	
-	-	-	-
-	-	-	-
-	-	-	-

Technical data			
Width	Length	Height NS 35/7,5	
-	85	-	
U _{max.} [V]	max. Ø [mm ²]	AWG (UL)	
1200	-	-	
IEC 60269-6			
IEC	UL / CUL	CSA	IEC/ EN 60079-7
1200	-	-	-
20 / -	-	-	-
-	-	-	-
-	-	-	-
Rigid	Flexible	Ferrule without/with plastic sleeve	
-	-	-	-
-	-	-	-
-	-	-	-

Ordering data		
Type	Order No.	Pcs./Pkt.
FUSE 10,3X85 2A PV	3062766	10
FUSE 10,3X85 4A PV	3062767	10
FUSE 10,3X85 6A PV	3062768	10
FUSE 10,3X85 8A PV	3062769	10
FUSE 10,3X85 10A PV	3062770	10
FUSE 10,3X85 12A PV	3062771	10
FUSE 10,3X85 16A PV	3062772	10

Ordering data		
Type	Order No.	Pcs./Pkt.
FUSE 10,3X85 20A PV	3062773	10
FUSE 10,3X85 25A PV	3062774	10

Accessories	

Accessories	

Disconnect terminal blocks



- Disconnect terminal block with universal disconnect zone for accommodating fuse connectors, component connectors, and isolating connectors
- Design width of just 6.2 mm
- The terminal blocks are available in different basic forms
- Mini-strip terminal blocks MBK 5
- Universal terminal blocks UK 5 N
- Double terminal blocks UDK 4
- Double-level terminal blocks UKK 5

Notes:
Three- or four-conductor basic actuator terminal blocks DOK 1,5–TG, DOKD 1,5–TG and VIOK 1,5–D/TG/D/PE with disconnect function can be found on page 485 onwards
For fuse, component and isolating connectors, see page 508.
¹⁾ The current and voltage are determined by the component and fuse connector.



4 (4) mm², 16 A, disconnect terminal block



Dimensions	
Dimensions	[mm]
Dimensions	[mm]
Dimensions	[mm]
Maximum electrical data	
Rated data	
Rated voltage	[V]
Nominal current / cross section	[A] / [mm ²]
Rated cross section	[mm ²]
Cross section range	AWG
Rated data, upper level	
Nominal current / cross section	[A] / [mm ²]
Connection capacity	
1 conductor	[mm ²]
2 conductors (of the same type)	[mm ²]
2 flexible conductors with a TWIN ferrule	[mm ²]
Max. cross section with insertion bridge	[mm ²]
General data	
Stripping length	[mm]
Screw thread	
Tightening torque	[Nm]
Insulating material	
Flammability rating in accordance with UL 94	

Technical data			
Width	Length	Height NS 35/7,5	
6.2	28	-	
Width	Length	Height NS 15	
6.2	28	36	
Width	Length	Height NS 32	
6.2	28	-	
I _{max} [A]	U _{max} [V]	max. Ø [mm ²]	AWG (UL)
16 ¹⁾	500 ¹⁾	0.2 - 4	28-12
IEC 60947-7-1			
IEC	UL / CUL	CSA	IEC/ EN 60079-7
500 ¹⁾	300	300	
16 / 4	20 / -	15 / -	-
4	-	-	-
24 - 12	28-12	28-12	-
IEC UL / CUL CSA IEC/ EN 60079-7			
- / -	- / -	- / -	- / -
Rigid		Flexible	
Ferrule			
without/with plastic sleeve			
0.2 - 4	0.2 - 4	0.25 - 2.5	0.25 - 2.5
0.2 - 1.5	0.2 - 1.5	0.25 - 1.5	-
			0.5 - 1.5
1.5	1.5		
9			
M3			
0.5 - 0.6			
PA			
V2			

Description	No. of pos.	Color
Basic terminal block, for component and fuse connectors		gray
Basic terminal block, with test socket screws on both sides		gray

Cover, width: 1 mm		gray
Cover, width: 1.5 mm		gray
Fixed bridge, isolated	10	silver
Insertion bridge, insulated		
	2	gray
	3	gray
	10	gray
Isolator bridge bar, divisible, with 10 screws, for switchable branches with IS-K...	10	silver
Bridge bar isolator, as distance piece for isolator bridge bar		gray
Screwdriver		
Lateral groove labeling		

Ordering data			
Type	I _{max}	Order No.	Pcs./Pkt.
MBK 5/E-TG		1415089	50

Accessories			
D-MBK 5/E-T		1413706	50
EB 2- 6	16 A	0201155	100
EB 3- 6	16 A	0201142	100
EB 10- 6	16 A	0201139	10
SF-SL 0,6X3,5-100 S-VDE		1212587	10

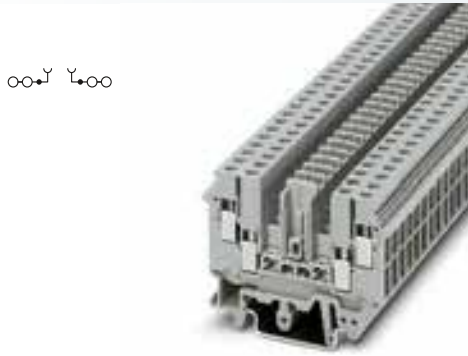
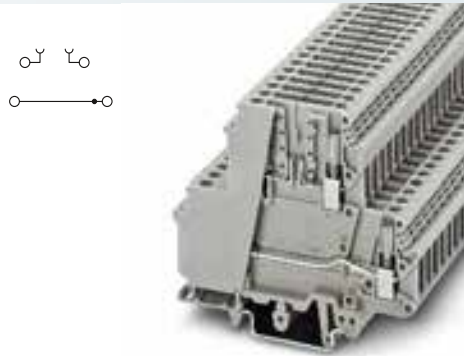
4 (6) mm², 16 A, disconnect terminal block4 (4) mm², 26 A, double-level terminal block with disconnect zone

Technical data			
Width	Length	Height NS 35/7,5	
6.2	63.5	47	
Width	Length	Height NS 15	
6.2	63.5	-	
Width	Length	Height NS 32	
6.2	63.5	52	
I _{max} [A]	U _{max} [V]	max. Ø [mm ²]	AWG (UL)
16 ¹⁾	400	0.2 - 6	30-12
IEC 60947-7-1	UL / CUL	CSA	IEC/ EN 60079-7
400	300	-	-
16 / 4	15 / -	- / -	-
4	-	-	-
24 - 10	30-12	-	-
IEC	UL / CUL	CSA	IEC/ EN 60079-7
- / -	- / -	- / -	- / -
Rigid	Flexible	Ferrule without/with plastic sleeve	
0.2 - 6	0.2 - 4	0.25 - 4	0.25 - 1.5
0.2 - 1	0.2 - 1.5	0.25 - 1.5	-
			0.5 - 1
2.5	2.5		
8			
M3			
0.6 - 0.8			
PA			
V2			

Technical data			
Width	Length	Height NS 35/7,5	
6.2	80	68.5	
Width	Length	Height NS 15	
6.2	80	-	
Width	Length	Height NS 32	
6.2	80	56	
I _{max} [A]	U _{max} [V]	max. Ø [mm ²]	AWG (UL)
26	400 ¹⁾	0.2 - 4	26-12
IEC 60947-7-1	UL / CUL	CSA	IEC/ EN 60079-7
400 ¹⁾	-	300	-
26 / 4	- / -	15 / -	-
4	-	-	-
24 - 12	26-12	28-12	-
IEC	UL / CUL	CSA	IEC/ EN 60079-7
16 / 4	15 / -	- / -	- / -
Rigid	Flexible	Ferrule without/with plastic sleeve	
0.2 - 4	0.2 - 4	0.25 - 4	0.25 - 2.5
0.2 - 1.5	0.2 - 1.5	0.25 - 1.5	-
			0.5 - 2.5
4	4		
8			
M3			
0.6 - 0.8			
PA			
V2			

Ordering data			
Type	I _{max}	Order No.	Pcs./Pkt.
UDK 4-TG		2777014	50

Ordering data			
Type	I _{max}	Order No.	Pcs./Pkt.
UKK 5-TG		3007042	50

Accessories			
D-UDK-RELG		2777027	50
FBI 10- 6	16 A	0203250	10
EB 2- 6	16 A	0201155	100
EB 3- 6	16 A	0201142	100
EB 10- 6	16 A	0201139	10
SF-SL 0,6X3,5-100 S-VDE		1212587	10
ZB 6 (see Catalog 3)			

Accessories			
FBI 10- 6	26 A	0203250	10
EB 2- 6	22 A	0201155	100
EB 3- 6	22 A	0201142	100
EB 10- 6	22 A	0201139	10
ISSBI 10- 6	26 A	0301505	10
IS-K 4		1302338	100
SZG 0,6X3,5 VDE		1205121	10
ZB 6 (see Catalog 3)			

Terminal blocks – Classic

UK universal modular terminal blocks

Connectors for disconnect terminal blocks in the UK series

- The fuse connector ST-SI-UK 4 for 5 x 20 mm cartridge fuse inserts is available with and without a LED display
- The component connector ST-BE is available as an individual connector for two-pos. components and as a double connector



Fuse connector for 5 x 20 mm cartridge fuses



Component connector for 2 and 4-pos. components

Notes:
1) If the fuse is faulty, the downstream circuit is not off load.
2) Integrated: Diode 1N 4007, reverse voltage: 1300 V, maximum continuous current: 1.0 A
3) With single arrangement.
4) Integrated: Rectifier module B 250 C 1500, reverse voltage: 600 V, nominal voltage: 250 V, nominal current: 1.5 A



Rated data	
Rated voltage	[V]
Nominal current / cross section	[A] / [mm ²]
Rated cross section	[mm ²]
Cross section range	AWG
General data	
Insulating material	PA
Flammability rating in accordance with UL 94	V2

Technical data				
IEC	UL / CUL	CSA	IEC/ EN 60079-7	
250	300	300	-	-
6.3 / -	6.3 / -	10 / -	-	-
-	-	-	-	-
-	-	-	-	-
PA				
V2				

Technical data				
IEC	UL / CUL	CSA	IEC/ EN 60079-7	
-	300	-	-	-
16 / -	10 / -	-	-	-
2.5	-	-	-	-
-	30-14	-	-	-
PA				
V0				

Description	Color
Fuse plug , for cartridge fuse inserts 5 x 20 mm, 26.5 mm high, max 6.3 A	black
Fuse connector , for cartridge fuse inserts, 5 x 20 mm, 26.5 mm high, max. 6.3 A, with LED display, for 5 - 15 V AC/DC ¹⁾	black
with LED for 15-30 V AC/DC	black
with LED for 30-60 V AC/DC	black
with LED for 110-250 V AC/DC	black
Component connector , for switching on 2-pos. components in the basic terminal block, fixing at screw terminal points, 19 mm high, max 16 A ³⁾	gray
Component connector , to connect 2-pos. components into the basic terminal block, 19 mm high, with LED for 24 V AC/DC	gray
with LED for 230 V AC/DC	gray
Component connector , to connect 2-pos. components into the basic terminal block, with diode 1N 4007, 19 mm high ²⁾	gray
Component plug , for 4-pos. components, two basic terminal blocks required per plug, with bridge rectifier B 250 C 1500, 19 mm high ⁴⁾	gray
Isolating connector , 13.5 mm high, max. 16 A	gray

Ordering data			
Type	Order No.	Pcs./Pkt.	
ST-SI-UK 4	0921011	50	
ST-SILED 12-UK 4	0921024	50	
ST-SILED 24-UK 4	0921037	50	
ST-SILED 60-UK 4	0921040	50	
ST-SILA250-UK 4	0921053	50	
ST-BE	2802316	10	
ST-BE-LA 24	2802374	10	
ST-BE-LA230	2802387	10	
ST-1N4007	2802329	10	
ST-B250C1500	2802345	10	
ST-K 4	5025462	50	

Ordering data			
Type	Order No.	Pcs./Pkt.	
ST-SI-UK 4	0921011	50	
ST-SILED 12-UK 4	0921024	50	
ST-SILED 24-UK 4	0921037	50	
ST-SILED 60-UK 4	0921040	50	
ST-SILA250-UK 4	0921053	50	
ST-BE	2802316	10	
ST-BE-LA 24	2802374	10	
ST-BE-LA230	2802387	10	
ST-1N4007	2802329	10	
ST-B250C1500	2802345	10	
ST-K 4	5025462	50	

Accessories	
Plug pliers , simplify removing the isolating plug from a closed row of terminal blocks	
Center groove labeling	

Accessories		

Accessories		
TZ	0306704	10
ZB 6 (see Catalog 3)		

Disconnect terminal blocks, isolating and fuse connectors

- Compact, space-saving design
- Universal disconnect zone

Notes:
1) If the fuse is faulty, the downstream circuit is not off load.
2) Observe max. load current.
3) Current and voltage are determined by the plug used.
For corresponding function plugs, see phoenixcontact.net/products.



4 (6) mm², 16 A, disconnect terminal block



Function plug for universal disconnect zone



Dimensions	
Width	[mm]
Dimensions	[mm]
Maximum electrical data	
Rated data	
Rated voltage	[V]
Nominal current / cross section	[A] / [mm²]
Rated cross section	[mm²]
Cross section range	AWG
Connection capacity	
1 conductor	[mm²]
2 conductors (of the same type)	[mm²]
2 flexible conductors with a TWIN ferrule	[mm²]
Max. cross section with insertion bridge	[mm²]
General data	
Stripping length	[mm]
Screw thread	
Tightening torque	[Nm]
Insulating material	
Flammability rating in accordance with UL 94	

Technical data				
Width	Length	Height NS 35/7,5		
6.2	42.5	47		
Width	Length	Height NS 32		
6.2	42.5	52		
I _{max} [A]	U _{max} [V]	max. Ø [mm²]	AWG (UL)	
16 ³⁾	500 ³⁾	0.2 - 6	20-10	
IEC 60947-7-1	UL / CUL	CSA	IEC/ EN 60079-7	
500 ³⁾	600	-	-	
16 ³⁾ / 1.5	15	-	-	
4	-	-	-	
24 - 10	20-10	-	-	
Connection capacity		Ferrule		
Rigid	Flexible	without/with plastic sleeve		
0.2 - 6	0.2 - 4	0.25 - 4	0.25 - 2.5	
0.2 - 1.5	0.2 - 1.5	0.25 - 1.5	-	
-	-	-	0.5 - 2.5	
4	4	-	-	
8				
M3				
0.6 - 0.8				
PA				
V0				

Technical data			
Width	Length	Height NS 35/7,5	
3.5	10.8	-	
Width	Length	Height NS 32	
3.5	10.8	-	
I _{max} [A]		max. Ø [mm²]	AWG (UL)
20		-	-
IEC	UL / CUL	CSA	IEC/ EN 60079-7
- / -	-	15 / -	-
-	-	-	-
-	-	-	-
Connection capacity		Ferrule	
Rigid	Flexible	without/with plastic sleeve	
-	-	-	-
-	-	-	-
-	-	-	-
PA			
V2			

Description	No. of pos.	Color
Disconnect terminal block, for mounting on NS 35 DIN rail		gray
Isolating plug ²⁾		orange
Feed-through connector ²⁾		gray
Component connector, labeled with ZBF 5 or UC-TMF 5		gray
Fuse connector, width: 5.2 mm with LED for 12 - 30 V DC, 0.31 - 0.95 mA ¹⁾		black
30 - 60 V AC/DC, 0.40 - 0.86 mA ¹⁾		black
for 110 - 250 V AC/DC, 0.41 - 0.96 mA		black
Fuse connector, width: 8.2 mm with LED for 12 - 30 V DC, 0.31 - 0.95 mA ¹⁾		black
30 - 60 V AC/DC, 0.40 - 0.86 mA ¹⁾		black
for 110 - 250 V AC/DC, 0.41 - 0.96 mA		black

Ordering data				
Type	I _{max}	Order No.	Pcs./Pkt.	
UK 5 N-TG		3000604	50	

Ordering data		
Type	Order No.	Pcs./Pkt.
P-DI	3036783	50
P-FIX	3038956	50
P-CO	3036796	10
P-FU 5X20-5	3209235	10
P-FU 5X20 LED 24	3036819	10
P-FU 5X20 LED 60	3036822	10
P-FU 5X20 LA 250	3036835	10
P-FU 6,3X32	3046498	10
P-FU 6,3X32 LED 24	3046508	10
P-FU 6,3X32 LED 60	3046511	10
P-FU 6,3X32 LA 250	3046524	10

Accessories		
Cover, width: 1.8 mm	gray	
Insertion bridge, insulated		
	2	gray
	3	gray
	10	gray
Screwdriver		
Lateral groove labeling		

Accessories				
D-UK 4/10		3003020	50	
EB 2-6	16 A	0201155	100	
EB 3-6	16 A	0201142	100	
EB 10-6	16 A	0201139	10	
SF-SL 0,6X3,5-100 S-VDE		1212587	10	
UC-TM 6, UCT-TM 6 or ZB 6 (see Catalog 3)				

Accessories		

Terminal blocks – Classic

UK universal modular terminal blocks

Component connectors, BES 6



- Advantageous when adding any 2-pos. components, such as diodes or varistors, between two neighboring feed-through terminal blocks at a later date
- Is supplied as a set with two female connectors
- The female connectors are screwed into the center thread of the feed-through terminal blocks. They are of different lengths, which determines the correct functional direction (corresponds to the vertically offset multiple-spring wire plugs) and prevents confusion later on
- If several BES 6 connectors are fitted next to each other, separating disks should be provided between the pairs of terminal blocks in order to prevent incorrect plugging
- To insert the components, the upper half of the housing is lifted, thus exposing the connector pins for soldering
- Versions are available with a LED display or diode. These serve as a protective circuit for DC loads

The connector can be used with the terminal blocks:

- MBK 5: Dimension a = 64 mm on DIN rail NS 15
- MBK 5/E-Z: Dimension a = 68 mm on DIN rail NS 15
- UK 5 N: Dimension a = 75 mm on DIN rail NS 35/7,5
- UKK 5: Dimension a = 92 mm on DIN rail NS 35/7,5
- UKKB 5: Dimension a = 92 mm on DIN rail NS 35/7,5
- UVKB 4: Dimension a = 76 mm on DIN rail NS 35/7,5

Notes:

1) Integrated: Diode 1N 4007, reverse voltage: 1300 V, maximum continuous current: 1.0 A



Component connector

ERC

Technical data

PA
V2

Ordering data

Description	Color
Component plug , complete, for connection of components between two neighboring feed-through terminal blocks	gray
Component plug , complete, for connection of components between two neighboring feed-through terminal blocks, with diode 1N 4007 ¹⁾	gray
Component plug , with LED display, 15 - 30 V DC	gray
Component plug , with LED display, 110 - 250 V AC/DC	gray

Type	Order No.	Pcs./Pkt.
BES 6	2802549	10
BES 6-1N4007	2802552	10
BES 6-LA 24	2802565	10
BES 6-LA230	2802578	10

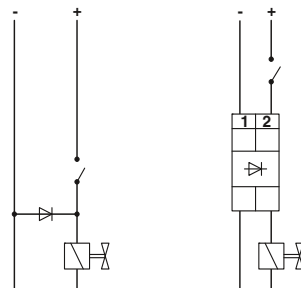

Damping diode with feed-through terminal blocks and BES 6

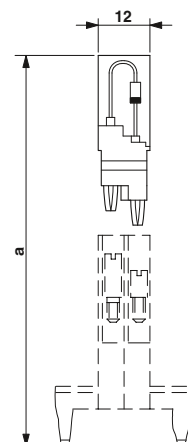

Construction: BES 6

Terminal blocks – Classic

UK universal modular terminal blocks

Knife disconnect terminal blocks MTK ...

For maintenance work or rapid troubleshooting, these disconnect terminal blocks are used in measurement, closed-loop control and single-loop control systems:

- Convenient disconnect knife operation
- Space-saving design
- High current-carrying capacity up to 16 A
- Versions with integrated test socket screws

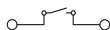

2.5 (4) mm², 16 A, knife disconnect terminal block with test socket screw



2.5 (4) mm², 16 A, knife disconnect terminal block



Dimensions		[mm]
Dimensions		[mm]
Maximum electrical data		
Rated data		
Rated voltage	[V]	400
Nominal current / cross section	[A] / [mm ²]	16 / 2.5
Rated cross section	[mm ²]	2.5
Cross section range	AWG	24 - 12
Connection capacity		
1 conductor	[mm ²]	0.2 - 4
2 conductors (of the same type)	[mm ²]	0.2 - 1.5
2 flexible conductors with a TWIN ferrule	[mm ²]	-
Max. cross section with insertion bridge	[mm ²]	4
General data		
Stripping length	[mm]	7
Screw thread		M3
Tightening torque	[Nm]	0.5 - 0.6
Insulating material		PA
Flammability rating in accordance with UL 94		V0

Technical data				
Width	Length	Height NS 35/7,5		
5.2	46	51.5		
Width	Length	Height NS 32		
5.2	46	56.5		
I _{max} [A]	U _{max} [V]	max. Ø [mm ²]	AWG (UL)	
16	400	0.2 - 4	28-12	
IEC 60947-7-1				
IEC	UL / CUL	CSA	IEC/ EN 60079-7	
400	300	300	-	
16 / 2.5	10 / -	15 / -	-	
2.5	-	-	-	
24 - 12	28-12	28-12	-	
Connection capacity				
	Rigid	Flexible	Ferrule without/with plastic sleeve	
0.2 - 4	0.2 - 2.5	0.25 - 2.5	0.25 - 1.5	
0.2 - 1.5	0.2 - 1.5	0.25 - 1.5	-	
-	-	-	0.5 - 1.5	
4	2.5	-	-	
General data				
Stripping length	[mm]	7		
Screw thread		M3		
Tightening torque	[Nm]	0.5 - 0.6		
Insulating material		PA		
Flammability rating in accordance with UL 94		V0		

Technical data				
Width	Length	Height NS 35/7,5		
5.2	46	51.5		
Width	Length	Height NS 32		
5.2	46	56.5		
I _{max} [A]	U _{max} [V]	max. Ø [mm ²]	AWG (UL)	
16	400	0.2 - 4	28-12	
IEC 60947-7-1				
IEC	UL / CUL	CSA	IEC/ EN 60079-7	
400	300	300	-	
16 / 2.5	10 / -	15 / -	-	
2.5	-	-	-	
24 - 12	28-12	28-12	-	
Connection capacity				
	Rigid	Flexible	Ferrule without/with plastic sleeve	
0.2 - 4	0.2 - 2.5	0.25 - 2.5	0.25 - 1.5	
0.2 - 1.5	0.2 - 1.5	0.25 - 1.5	-	
-	-	-	0.5 - 1.5	
4	2.5	-	-	
General data				
Stripping length	[mm]	7		
Screw thread		M3		
Tightening torque	[Nm]	0.5 - 0.6		
Insulating material		PA		
Flammability rating in accordance with UL 94		V0		

Description	No. of pos.	Color
Knife disconnect terminal block, for mounting on NS 32... or NS 35..., with test socket screws on both sides		gray
		blue
Knife disconnect terminal block, for mounting on NS 32... or NS 35..., with screw connection on both sides		gray
		blue
Feed-through terminal block, without disconnect knife, with test socket screws with screw connection		gray
Knife disconnect terminal block, for mounting on NS 32... or NS 35..., with test socket screws on both sides, bridgeable in both levels		gray
		blue
Without test socket screws		gray
Knife disconnect terminal block, for mounting on NS 35...		gray

Ordering data				
Type	I _{max}	Order No.	Pcs./Pkt.	
MTK-P/P		3104013	50	
MTK-P/P BU		3104097	50	
MTK		3101016	50	
MTK BU		3101197	50	

Ordering data				
Type	I _{max}	Order No.	Pcs./Pkt.	
MTK-P/P		3104013	50	
MTK-P/P BU		3104097	50	
MTK		3101016	50	
MTK BU		3101197	50	

Accessories		
Cover, width: 1 mm	gray	
	blue	
Insertion bridge, insulated		
	2	gray
	3	gray
	10	gray
Partition plate, for visual and electrical separation of terminal groups, 1.0 mm thick		gray
Screwdriver		
Lateral groove labeling		

Accessories				
D-MTK		3101029	50	
D-MTK BU		3101090	50	
EBL 2- 5	12 A	2303145	10	
EBL 3- 5	12 A	2303158	10	
EBL 10- 5	12 A	2303132	10	
ATS-MTK		3101223	50	
SZG 0,6X3,5 VDE		1205121	10	
ZB 5 (see Catalog 3)				

Accessories				
D-MTK		3101029	50	
D-MTK BU		3101090	50	
EBL 2- 5	12 A	2303145	10	
EBL 3- 5	12 A	2303158	10	
EBL 10- 5	12 A	2303132	10	
ATS-MTK		3101223	50	
SF-SL 0,6X3,5-100 S-VDE		1212587	10	
ZB 5 (see Catalog 3)				

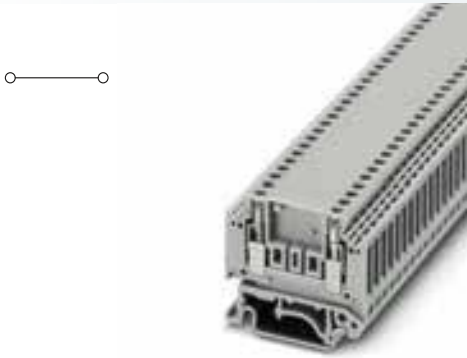

2.5 (4) mm², 16 A, feed-through terminal block, with test socket screw

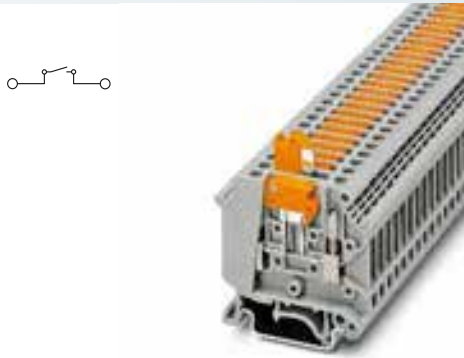

4 (6) mm², 20 A, knife disconnect terminal block with test socket screw



4 (6) mm², 16 A, knife disconnect terminal block



Technical data			
Width	Length	Height NS 35/7,5	
5.2	46.2	39.9	
Width	Length	Height NS 32	
5.2	46.2	44.9	
I _{max} [A]	U _{max} [V]	max. Ø [mm ²]	AWG (UL)
16	400	0.2 - 4	28-12
IEC 60947-7-1			
IEC	UL / CUL	CSA	IEC/ EN 60079-7
400	300	600	-
16 / 2.5	10 / -	20 / -	-
2.5	-	-	-
24 - 12	28-12	28-12	-
Rigid	Flexible	Ferrule without/with plastic sleeve	
0.2 - 4	0.2 - 2.5	0.25 - 2.5	0.25 - 1.5
0.2 - 1.5	0.2 - 1.5	0.25 - 1.5	-
-	-	-	0.5 - 1.5
4	2.5	-	-
7			
M3			
0.5 - 0.6			
PA			
V0			

Technical data			
Width	Length	Height NS 35/7,5	
6.2	51	58.5	
Width	Length	Height NS 32	
6.2	51	63.5	
I _{max} [A]	U _{max} [V]	max. Ø [mm ²]	AWG (UL)
20	500	0.2 - 6	22-12
IEC 60947-7-1			
IEC	UL / CUL	CSA	IEC/ EN 60079-7
500	600	-	-
20 / 2.5	15 / -	-	-
4	-	-	-
24 - 10	22-12	-	-
Rigid	Flexible	Ferrule without/with plastic sleeve	
0.2 - 6	0.2 - 4	0.25 - 4	0.25 - 2.5
0.2 - 1.5	0.2 - 1.5	0.25 - 1.5	-
-	-	-	0.5 - 2.5
4	4	-	-
8			
M3			
0.5 - 0.6			
PA			
V0			

Technical data			
Width	Length	Height NS 35/7,5	
6.2	42.5	48.7	
Width	Length	Height NS 32	
6.2	42.5	53.7	
I _{max} [A]	U _{max} [V]	max. Ø [mm ²]	AWG (UL)
16	500	0.2 - 6	20-10
IEC 60947-7-1			
IEC	UL / CUL	CSA	IEC/ EN 60079-7
500	600	-	-
16 / 1.5	15 / -	-	-
4	-	-	-
24 - 10	20-10	-	-
Rigid	Flexible	Ferrule without/with plastic sleeve	
0.2 - 6	0.2 - 4	0.25 - 4	0.25 - 2.5
0.2 - 1.5	0.2 - 1.5	0.25 - 1.5	-
-	-	-	0.5 - 2.5
4	4	-	-
8			
M3			
0.6 - 0.8			
PA			
V0			

Ordering data			
Type	I _{max}	Order No.	Pcs./Pkt.
MTKD-P/P		3100020	50
MTKD		3100017	50

Ordering data			
Type	I _{max}	Order No.	Pcs./Pkt.
UK 5-MTK-P/P		3004032	50
UK 5-MTK-P/P BU		3004058	50
UK 5-MTK		3004430	50

Ordering data			
Type	I _{max}	Order No.	Pcs./Pkt.
UK 5 N-MT		3000563	50

Accessories			
D-MTK		3101029	50
D-MTK BU		3101090	50
EBL 2-5	12 A	2303145	10
EBL 3-5	12 A	2303158	10
EBL 10-5	12 A	2303132	10
ATS-MTK		3101223	50
SZG 0,6X3,5 VDE		1205121	10

Accessories			
D-UK 4/10		3003020	50
EB 2-6	12 A	0201155	100
EB 3-6	12 A	0201142	100
EB 10-6	12 A	0201139	10
ATP-UK 5-MTK		3004210	50
SZG 0,6X3,5 VDE		1205121	10

Accessories			
D-UK 4/10		3003020	50
D-UK 4/10 BU		3003101	50
EB 2-6	16 A	0201155	100
EB 3-6	16 A	0201142	100
EB 10-6	16 A	0201139	10
SF-SL 0,6X3,5-100 S-VDE		1212587	10

ZB 5 (see Catalog 3)

UC-TM 6, UCT-TM 6 or ZB 6 (see Catalog 3)

UC-TM 6, UCT-TM 6 or ZB 6 (see Catalog 3)

Terminal blocks – Classic

UK universal modular terminal blocks

Knife disconnect terminal blocks

- Convenient disconnect knife operation
- Closed housing of double-level terminal blocks
- The disconnect knife on the associated level is characterized by a slight vertical offset
- Space-saving design just 6.2 mm wide

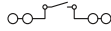

4 (6) mm², 16 A, knife disconnect terminal block, 4 connections, with test socket screw



Technical data				
Width	Length	Height NS 35/7,5		
6.2	63.5	47		
Width	Length	Height NS 32		
6.2	63.5	52		
I_{max} [A]	U_{max} [V]	max. Ø [mm ²]	AWG (UL)	
16	630	0.2 - 6	30-10	
IEC 60947-7-1				
IEC	UL / CUL	CSA	IEC/ EN 60079-7	
Rated voltage	[V]	630	600	600
Nominal current / cross section	[A] / [mm ²]	16 / 4	15 / -	15 / -
Rated cross section	[mm ²]	4	-	-
Cross section range	AWG	24 - 10	30-10	22-10
Rated data, upper level				
IEC	UL / CUL	CSA	IEC/ EN 60079-7	
Nominal current / cross section	[A] / [mm ²]	-	-	-
Connection capacity				
	Rigid	Flexible	Ferrule without/with plastic sleeve	
1 conductor	[mm ²]	0.2 - 6	0.2 - 4	0.25 - 4 0.25 - 1.5
2 conductors (of the same type)	[mm ²]	0.2 - 1	0.2 - 1.5	0.25 - 1.5
2 flexible conductors with a TWIN ferrule	[mm ²]	-	-	0.5 - 1
Max. cross section with insertion bridge	[mm ²]	2.5	2.5	-
General data				
Stripping length	[mm]	8		
Screw thread		M3		
Tightening torque	[Nm]	0.6 - 0.8		
Insulating material		PA		
Flammability rating in accordance with UL 94		V2		

Ordering data						
Description	No. of pos.	Color	Type	I_{max}	Order No.	Pcs./Pkt.
Knife disconnect terminal block, for mounting on NS 32... or NS 35..., with test socket screws on both sides		gray	UDK 4-MTK-P/P		2775210	50
Knife disconnect terminal block, for mounting on NS 32... or NS 35..., with test socket screws on both sides, bridgeable in both levels		blue gray	UDK 4-MTK-P/P BU		2775223	50
Double-level terminal block, for mounting on NS 32... or NS 35..., with disconnect knife and LED display for 12 V DC		gray				
Double-level terminal block, for mounting on NS 32... or NS 35..., with two through contacts, without LED display		gray				

Accessories						
Cover, width: 1.5 mm		gray blue	D-UDK 4 D-UDK 4 BU		2775113 2775197	50 50
Fixed bridge, isolated	10	silver				
Insertion bridge, insulated						
	2	gray	EB 2-6	12 A	0201155	100
	3	gray	EB 3-6	12 A	0201142	100
	10	gray	EB 10-6	12 A	0201139	10
Screwdriver			SF-SL 0,6X3,5-100 S-VDE		1212587	10
Later groove labeling			ZB 6 (see Catalog 3)			

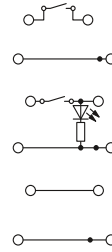

4 (4) mm², 26 A, double-level knife disconnect terminal block, with test socket screw



Technical data				
Width	Length	Height NS 35/7,5		
6.1	80	68		
Width	Length	Height NS 32		
6.1	80	73		
I_{max} [A]	U_{max} [V]	max. Ø [mm ²]	AWG (UL)	
26	400	0.2 - 4	26-12	
IEC 60947-7-1				
IEC	UL / CUL	CSA	IEC/ EN 60079-7	
Rated voltage	[V]	400	300	300
Nominal current / cross section	[A] / [mm ²]	26 / 4	-	15 / -
Rated cross section	[mm ²]	4	-	-
Cross section range	AWG	24 - 12	26-12	22-12
Rated data, upper level				
IEC	UL / CUL	CSA	IEC/ EN 60079-7	
Nominal current / cross section	[A] / [mm ²]	12 / 4	-	-
Connection capacity				
	Rigid	Flexible	Ferrule without/with plastic sleeve	
1 conductor	[mm ²]	0.2 - 4	0.2 - 4	0.25 - 4 0.25 - 2.5
2 conductors (of the same type)	[mm ²]	0.2 - 1.5	0.2 - 1.5	0.25 - 1.5
2 flexible conductors with a TWIN ferrule	[mm ²]	-	-	0.5 - 1.5
Max. cross section with insertion bridge	[mm ²]	-	-	-
General data				
Stripping length	[mm]	8		
Screw thread		M3		
Tightening torque	[Nm]	0.6 - 0.8		
Insulating material		PA		
Flammability rating in accordance with UL 94		V2		

Ordering data						
Description	No. of pos.	Color	Type	I_{max}	Order No.	Pcs./Pkt.
Knife disconnect terminal block, for mounting on NS 32... or NS 35..., with test socket screws on both sides		gray	UKK 5-MTK-P/P		2800004	50
Double-level terminal block, for mounting on NS 32... or NS 35..., with disconnect knife and LED display for 12 V DC		gray	UKK 5-MTK-P/P-LA 24RD/O-U		2800020	50
Double-level terminal block, for mounting on NS 32... or NS 35..., with two through contacts, without LED display		gray	UKK 5-MTKD-P/P		2800017	50

Accessories						
Cover, width: 1.5 mm		gray blue				
Fixed bridge, isolated	10	silver				
Insertion bridge, insulated						
	2	gray				
	3	gray				
	10	gray				
Screwdriver						
Later groove labeling						
			FBI 10-6	22 A	0203250	10
			SZG 0,6X3,5 VDE		1205121	10
			ZB 6 (see Catalog 3)			

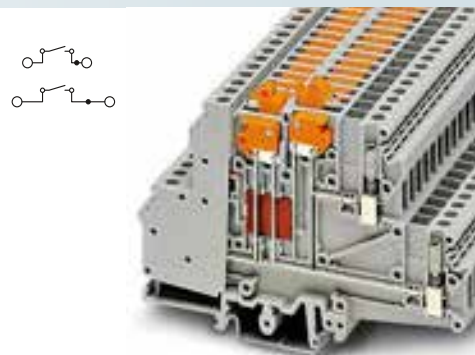
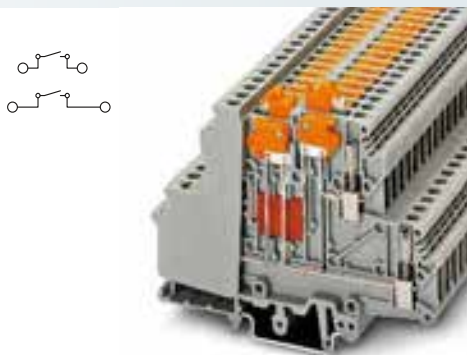
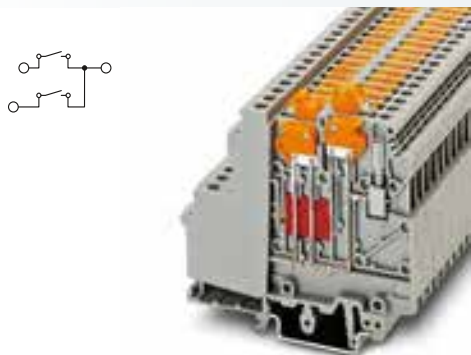

4 (4) mm², 8 A, feed-through terminal block, 3 connections, with two disconnect knives, test socket screw

4 (4) mm², 10 A, double-level terminal block, one disconnect knife per level, test socket screw

4 (4) mm², 10 A, double-level terminal block, one disconnect knife and bridge shaft per level, test socket screw



Technical data			
Width	Length	Height NS 35/7,5	
6.2	76.5	68.5	
Width	Length	Height NS 32	
6.2	76.5	73.5	
I _{max} [A]	U _{max} [V]	max. Ø [mm ²]	AWG (UL)
8	400	0.2 - 4	26-12
IEC 60947-7-1			
IEC	UL / CUL	CSA	IEC/ EN 60079-7
400	300	300	-
8 / 4	8 / -	8 / -	-
4	-	-	-
24 - 12	26-12	28-12	-
IEC	UL / CUL	CSA	IEC/ EN 60079-7
8 / 4	-	-	-
Rigid	Flexible	Ferrule without/with plastic sleeve	
0.2 - 4	0.2 - 4	0.25 - 4	0.25 - 2.5
0.2 - 1.5	0.2 - 1.5	0.25 - 1.5	-
-	-	-	0.5 - 2.5
-	-	-	-
8			
M3			
0.6 - 0.8			
PA			
V2			

Technical data			
Width	Length	Height NS 35/7,5	
6.2	93	68.5	
Width	Length	Height NS 32	
6.2	93	73.5	
I _{max} [A]	U _{max} [V]	max. Ø [mm ²]	AWG (UL)
10	400	0.2 - 4	26-12
IEC 60947-7-1			
IEC	UL / CUL	CSA	IEC/ EN 60079-7
400	300	300	-
10 / 4	10	15 / -	-
4	-	-	-
24 - 12	26-12	28-12	-
IEC	UL / CUL	CSA	IEC/ EN 60079-7
8 / 4	-	-	-
Rigid	Flexible	Ferrule without/with plastic sleeve	
0.2 - 4	0.2 - 4	0.25 - 4	0.25 - 2.5
0.2 - 1.5	0.2 - 1.5	0.25 - 1.5	-
-	-	-	0.5 - 2.5
-	-	-	-
8			
M3			
0.6 - 0.8			
PA			
V2			

Technical data			
Width	Length	Height NS 35/7,5	
6.2	106	68.5	
Width	Length	Height NS 32	
6.2	106	73.5	
I _{max} [A]	U _{max} [V]	max. Ø [mm ²]	AWG (UL)
10	400	0.2 - 4	-
IEC 60947-7-1			
IEC	UL / CUL	CSA	IEC/ EN 60079-7
400	-	-	-
10 / 4	-	-	-
4	-	-	-
24 - 12	-	-	-
IEC	UL / CUL	CSA	IEC/ EN 60079-7
8 / 4	-	-	-
Rigid	Flexible	Ferrule without/with plastic sleeve	
0.2 - 4	0.2 - 4	0.25 - 4	0.25 - 2.5
0.2 - 1.5	0.2 - 1.5	0.25 - 1.5	-
-	-	-	0.5 - 2.5
-	-	-	-
8			
M3			
0.5 - 0.6			
PA			
V2			

Ordering data		
Type	Order No.	Pcs./Pkt.
UDMTK 5-TWIN-P/P	3101126	50
UDMTK 5-TWIN-P/P BU	3101139	50

Ordering data		
Type	Order No.	Pcs./Pkt.
UDMTK 5-P/P	3101087	50
UDMTK 5-P/P BU	3101113	50

Ordering data			
Type	I _{max}	Order No.	Pcs./Pkt.
UDMTKB 5-P/P		3024478	50

Accessories		
SZG 0,6X3,5 VDE	1205121	10
ZB 6 (see Catalog 3)		

Accessories		
SZG 0,6X3,5 VDE	1205121	10
ZB 6 (see Catalog 3)		

Accessories			
FBI 10- 6	10 A	0203250	10
SZG 0,6X3,5 VDE		1205121	10
ZB 6 (see Catalog 3)			

Terminal blocks – Classic

UK universal modular terminal blocks

Slide-type terminal block UGSK/S Disconnect terminal block URTK/SS



- Simple and clear testing in current transformer secondary circuits can be undertaken with the slide-type terminal block UGSK/S for cross switching
- Measurement equipment or protective relays can be individually activated with the aid of bridges and slides
- For this purpose, the slides make contact with the switching bridge depending on the switching task
- The URTK/SS allow the transformer test circuits to be designed to be very compact and clear

Slide-type terminal block UGSK/S

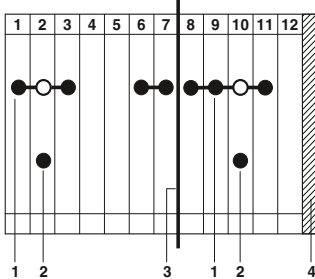

Type	Order no.
1 FB 10-GSK/S	0305174
2 GS-GSK/S	0305116
3 ATS-GSK	0304227
4 D-UGSK	0304023

Disconnect terminal block URTK/SS

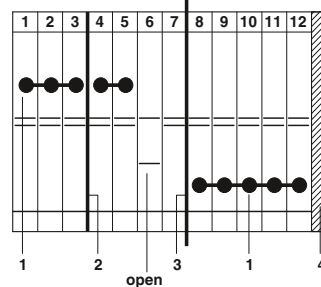

Type	Order no.
1 FBRNI 10-6	2770626
2 TS-URTK/SS	0321213
3 ATS-URTK/SS	0321226
4 D-URTK/SS	0321022

Dimensions

[mm]

Dimensions

[mm]

Maximum electrical data

Rated data

Rated voltage	[V]
Nominal current / cross section	[A] / [mm ²]
Rated cross section	[mm ²]
Cross section range	AWG

Connection capacity

1 conductor	[mm ²]
2 conductors (of the same type)	[mm ²]
2 flexible conductors with a TWIN ferrule	[mm ²]

General data

Stripping length	[mm]
Terminal point: Thread / torque	- / [Nm]

Disconnect slide: Thread / torque	- / [Nm]
-----------------------------------	----------

Insulating material

Flammability rating in accordance with UL 94

Description	No. of pos.	Color
Slide terminal block, for mounting on NS 32... or NS 35...		gray
Without slide		gray
Disconnect terminal block, for mounting on NS 32... or NS 35...		gray

Cover, width: 2.2 mm

gray

Cover, width: 1 mm

gray

Fixed bridge

10

silver

Slide, for switchable connection along with FB 10-GSK/S or FB-GSK

silver

Separating plate, for separation of neighboring bridges in terminal center, width: 0.8 mm

gray

Separating disk, 0.8 mm wide

gray

Slide with a test socket, insulated, for the UGSK/S terminal block, M3.5 thread

transparent

white

red

blue

yellow

green

violet

gray

black

Screwdriver

Lateral groove labeling

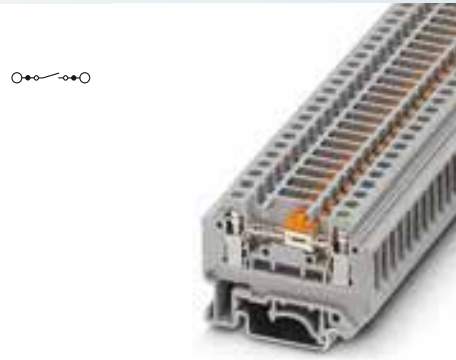
6 (10) mm², 57 A, slide-type terminal block4 (4) mm², 26 A, disconnect terminal block

ERIC

Technical data			
Width	Length	Height NS 35/7,5	
8.2	61	52.7	
Width	Length	Height NS 32	
8.2	61	57.6	
I_{max} [A]	U_{max} [V]	max. Ø [mm ²]	AWG (UL)
57	500	0.5 - 10	-
IEC 60947-7-1			
IEC	UL / CUL	CSA	IEC/ EN 60079-7
500	-	-	-
41 / 6	-	-	-
6	-	-	-
20 - 8	-	-	-
Rigid	Flexible	Ferrule without/with plastic sleeve	
0.5 - 10	0.5 - 6	0.5 - 6	0.5 - 4
0.5 - 1.5	0.5 - 4	0.5 - 4	-
-	-	-	0.5 - 4
11			
M4 / 1.5 - 1.8			
- / -			
PA			
V2			

Technical data			
Width	Length	Height NS 35/7,5	
6.2	56.5	40	
Width	Length	Height NS 32	
6.2	56.5	45	
I_{max} [A]	U_{max} [V]	max. Ø [mm ²]	AWG (UL)
26	400	0.2 - 4	28-12
IEC 60947-7-1			
IEC	UL / CUL	CSA	IEC/ EN 60079-7
400	300	300	-
26 / 4	20 / -	25 / -	-
4	-	-	-
24 - 12	28-12	28-12	-
Rigid	Flexible	Ferrule without/with plastic sleeve	
0.2 - 4	0.2 - 4	0.25 - 4	0.25 - 2.5
0.2 - 1.5	0.2 - 1.5	0.25 - 1.5	-
-	-	-	0.5 - 2.5
7			
M3 / 0.6 - 0.8			
M2,6 / 0.5 - 0.6			
PA			
V0			

Ordering data			
Type	I_{max}	Order No.	Pcs./Pkt.
UGSK/S + GS		0313085	50
UGSK/S		0305080	50

Ordering data			
Type	I_{max}	Order No.	Pcs./Pkt.
URTK/SS		0321019	50

Accessories		
D-UGSK	0304023	50
FB 10- GSK/S	43 A 0305174	10
GS-GSK/S	0305116	100
TS-GSK	0304214	50
ATS-GSK	0304227	50
PSBJ-GSK/S FARBLOS	0305394	10
PSBJ-GSK/S WH	0305310	10
PSBJ-GSK/S RD	0305323	10
PSBJ-GSK/S BU	0305336	10
PSBJ-GSK/S YE	0305349	10
PSBJ-GSK/S GN	0305352	10
PSBJ-GSK/S VT	0305365	10
PSBJ-GSK/S GY	0305378	10
PSBJ-GSK/S BK	0305381	10
SZS 1,0X4,0 VDE	1205066	10

Accessories		
D-URTK/SS	0321022	50
FBRNI 10-6 N	26 A 2770626	10
TS-URTK/SS	0321213	50
ATS-URTK/SS	0321226	100
SF-SL 0,6X3,5-100 S-VDE	1212587	10

ZB 8 (see Catalog 3)

ZB 6 (see Catalog 3)

Terminal blocks – Classic

UK universal modular terminal blocks

Meas. transducer disconnect terminal block URTK/S ...

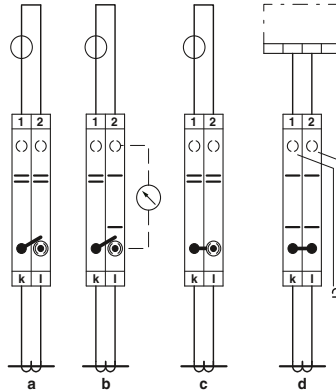

- Easy and clear testing in current transformer secondary circuits can be performed with the test disconnect terminal blocks of the URTK/S range
- On both sides of the disconnect point, the terminal block has a test socket which can also be used to switch across to neighboring terminal blocks
- The URTK/S–BEN ... terminal blocks are provided with test socket screws for test plugs with a 4 mm diameter

- All switching tasks with two terminal blocks per current transformer core can be implemented with the URTK/S and URTK/S-BEN 10 test disconnect terminal blocks
- a Normal operation
- b Measurement checking
- c Transformer short circuit
- d Relay checking

Test disconnect terminal block URTK/S

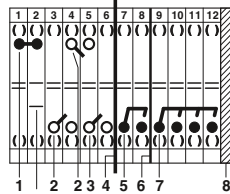

Type	Order no.
1 FB 10-RTK/S	0311171
2 USB 2-RTK/S	0311278
3 ASB 2-RTK/S	0311281
4 ATS-RTK	0310224
5 SB 2-RTK/S	0311236
6 TS-RTK	0310211
7 SB 4-RTK/S	0311265
8 D-URTK	0310020

Test disconnect terminal block URTK/S-BEN 10

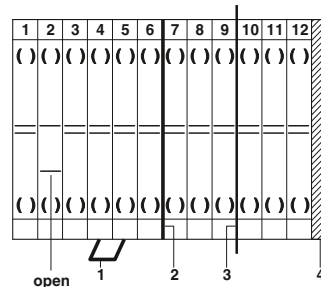

Type	Order no.
1 EB 2-8	0202154
2 TS-RTK-BEN	0308210
3 ATS-RTK-BEN	0308223
4 D-URTK/S-BEN	0308029

Dimensions

[mm]

Dimensions

[mm]

Maximum electrical data

Rated data

Rated voltage [V]
 Nominal current / cross section [A] / [mm²]
 Rated cross section [mm²]
 Cross section range AWG

Connection capacity

1 conductor [mm²]
 2 conductors (of the same type) [mm²]
 2 flexible conductors with a TWIN ferrule [mm²]
 Max. cross section with insertion bridge [mm²]

General data

Stripping length [mm]
 Terminal point: Thread / torque - / [Nm]

Disconnect slide: Thread / torque - / [Nm]

Insulating material

Flammability rating in accordance with UL 94

Description	No. of pos.	Color
-------------	-------------	-------

Terminal block, for mounting on NS 32... or NS 35...		gray
--	--	------

Cover, width: 2.2 mm		gray
----------------------	--	------

Insertion bridge, fully insulated		
-----------------------------------	--	--

	2	gray
	3	gray
	4	gray
	10	gray

Fixed bridge, for cross connections on both sides of the disconnect point, divisible, with 10 screws	10	silver
--	----	--------

Switching bridge for two terminal blocks, usable for both sides of the disconnect point, with 2 screws		
Inward switching	2	silver
Outward switching	2	silver

Switch bar for 2 terminal blocks, with 2 screws	2	silver
---	---	--------

Switching bridge, for 3-phase short-circuiting of linked current transformer sets, with 4 screws	4	silver
--	---	--------

Separating plate, for electrical separation of neighboring bridges at the terminal center		gray
---	--	------

Partition plate, for visual and electrical separation of terminal groups		gray
--	--	------

Switching lock, excludes the possibility of an unintentional operation of the disconnect slide		white
--	--	-------

Screwdriver

Lateral groove labeling

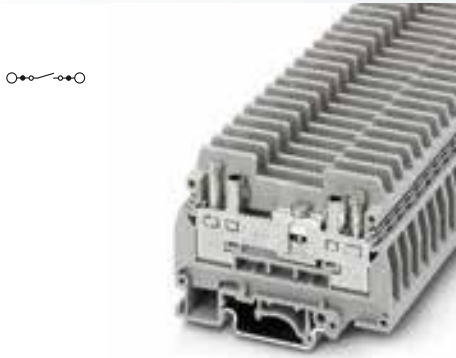

6 (10) mm², 57 A, test disconnect terminal block

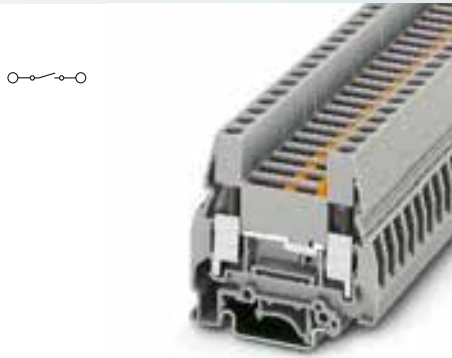

10 (16) mm², 76 A, test disconnect terminal block



Technical data			
Width	Length	Height NS 35/7,5	
8.2	72	51.5	
Width	Length	Height NS 32	
8.2	72	56.5	
I_{max} [A]	U_{max} [V]	max. Ø [mm ²]	AWG (UL)
57	400	0.5 - 10	-
IEC 60947-7-1			
IEC	UL / CUL	CSA	IEC/ EN 60079-7
400	-	300	-
41 / 6	- / -	40 / -	-
6	-	-	-
20 - 8	-	26-10	-
Rigid	Flexible	Ferrule without/with plastic sleeve	
0.5 - 10	0.5 - 6	0.5 - 6	0.5 - 4
0.5 - 2.5	0.5 - 6	0.5 - 4	-
-	-	-	0.5 - 4
-	-	-	-
13			
M4 / 1.2 - 1.5			
M3 / 0.6 - 0.8			
PA			
V0			

Technical data			
Width	Length	Height NS 35/7,5	
8.2	61	58.5	
Width	Length	Height NS 32	
8.2	61	63.5	
I_{max} [A]	U_{max} [V]	max. Ø [mm ²]	AWG (UL)
76	500	0.5 - 16	26-8
IEC 60947-7-1			
IEC	UL / CUL	CSA	IEC/ EN 60079-7
500	600	600	-
57 / 10	50 / -	55 / -	-
10	-	-	-
20 - 6	26-8	26-8	-
Rigid	Flexible	Ferrule without/with plastic sleeve	
0.5 - 16	0.5 - 10	0.5 - 10	0.5 - 6
0.5 - 6	0.5 - 4	0.5 - 6	-
-	-	-	0.5 - 4
10	10	-	-
11			
M4 / 1.5 - 1.8			
M3 / 0.6 - 0.8			
PA			
V0			

Ordering data			
Type	I_{max}	Order No.	Pcs./Pkt.
URTK/S		0311087	50

Ordering data			
Type	I_{max}	Order No.	Pcs./Pkt.
URTK/S-BEN 10		0309109	50

Accessories			
D-URTK		0310020	50
EB 2- 8	41 A	0202154	100
EB 3- 8	41 A	0202141	100
EB 4- 8	41 A	0202142	100
EB 10- 8	41 A	0202138	10
FB 10- RTK/S	41 A	0311171	10
USB 2-RTK/S	35 A	0311278	10
ASB 2-RTK/S	35 A	0311281	10
SB 2-RTK/S	35 A	0311236	10
SB 4-RTK/S	35 A	0311265	10
TS-RTK		0310211	50
ATS-RTK		0310224	50
S		0308359	100
SZS 1,0X4,0 VDE		1205066	10

Accessories			
D-URTK/S-BEN		0308029	50
EB 2- 8	41 A	0202154	100
EB 3- 8	41 A	0202141	100
EB 4- 8	41 A	0202142	100
EB 10- 8	41 A	0202138	10
TS-RTK-BEN		0308210	50
ATS-RTK-BEN		0308223	100
SZG 0,9X6,5 VDE		1205134	10

ZB 8 (see Catalog 3)

ZB 8 (see Catalog 3)

UK universal modular terminal blocks

UK 6-T test disconnect terminal blocks

- Easy and clear testing in the current transformer secondary circuits can be performed using the UK 6-T test disconnect terminal block
- Compact design
- Switching bridges with and without test sockets

PROJECT complete planning enables the quick and convenient planning and configuration of error-free terminal strips.

Notes:

For additional test sockets, bridge bars, and separating disks, visit phoenixcontact.net/products



6 (10) mm², 57 A, disconnect terminal block, with test sockets



Dimensions		
Dimensions		[mm]
Dimensions		[mm]
Maximum electrical data		
Rated data		
Rated voltage	[V]	500
Nominal current / cross section	[A] / [mm ²]	41 / 6
Rated cross section	[mm ²]	6
Cross section range	AWG	20 - 8
Connection capacity		
1 conductor	[mm ²]	0.5 - 10
2 conductors (of the same type)	[mm ²]	0.5 - 2.5
2 flexible conductors with a TWIN ferrule	[mm ²]	-
General data		
Stripping length	[mm]	10
Terminal point: Thread / torque	- / [Nm]	M4 / 1.5 - 1.6
Disconnect slide: Thread / torque	- / [Nm]	M3 / 0.6 - 0.8
Torque: Test socket, fixed bridge, switch bar	[Nm]	0.6 - 0.8
Insulating material		PA
Flammability rating in accordance with UL 94		V0

Technical data			
Width	Length	Height NS 35/7,5	
8.2	66.5	48	
Width	Length	Height NS 32	
8.2	66.5	53	
I _{max} [A]	U _{max} [V]	max. Ø [mm ²]	AWG (UL)
57	500	0.5 - 10	26-8
IEC 60947-7-1			
IEC	UL / CUL	CSA	IEC/EN 60079-7
Rated voltage	600	600	-
Nominal current / cross section	30	30 / -	-
Rated cross section	-	-	-
Cross section range	26-8	26-8	-
Connection capacity		Rigid	Flexible
		Ferrule without/with plastic sleeve	
1 conductor	[mm ²]	0.5 - 10	0.5 - 6
2 conductors (of the same type)	[mm ²]	0.5 - 2.5	0.5 - 2.5
2 flexible conductors with a TWIN ferrule	[mm ²]	-	0.5 - 4

Description	No. of pos.	Color
Disconnect terminal block, with test sockets		gray
Disconnect terminal block		gray
Feed-through terminal block		gray

Ordering data			
Type	I _{max}	Order No.	Pcs./Pkt.
UK 6-T-P		3072800	50

Cover, width: 2.2 mm		gray
Fixed bridge, 10-pos.	10	silver
Isolator bridge bar, 10-pos.	10	silver
Switching bridge	2	orange
	3	orange
	4	orange
Switching bridge, complete with test sockets	2	orange
	3	orange
	4	orange
Test socket		silver
Test socket, insulated		orange
Modular test plug housing, labeling with ZBF 8		red
4 mm Ø		silver
Short-circuit plug, for short circuiting neighboring terminal blocks, fully insulated, 2-pos., I _{max} 20 A		black
4-pos.		black
Screwdriver		

Accessories			
Type	I _{max}	Order No.	Pcs./Pkt.
D-UK 6-T		3072802	50
SCBI 10-8,15	24 A	3245134	10
SCBI 10-8,15 ISO	24 A	3000417	10
SB 6-T 2-8	32 A	3075842	10
SB 6-T 3-8	32 A	3075843	10
SB 6-T 4-8	32 A	3075844	10
SBP 6-T 2-8	32 A	3070321	10
SBP 6-T 3-8	32 A	3070322	10
SBP 6-T 4-8	32 A	3070323	10
TPS 3/20/5		3246586	10
PSBJ 6-T OG		3070320	10
PS-8/2,3MM RD		3048564	10
MPS-MT/ 4MM		3048577	10
KSS 8		0311540	10
KSS 4- 8		0309549	10
SF-SL 0,8X4,0-100 S-VDE		1212588	10

Lateral groove labeling

UC-TM 8, UCT-TM 8 or ZB 8 (see Catalog 3)

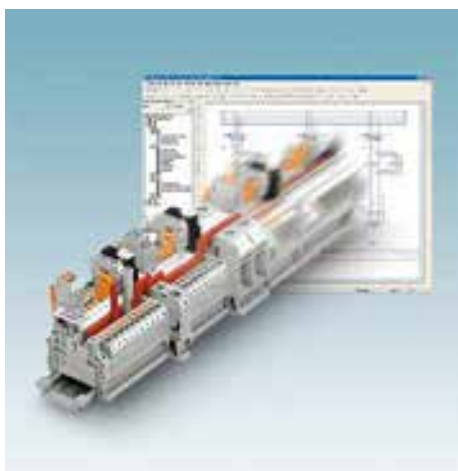

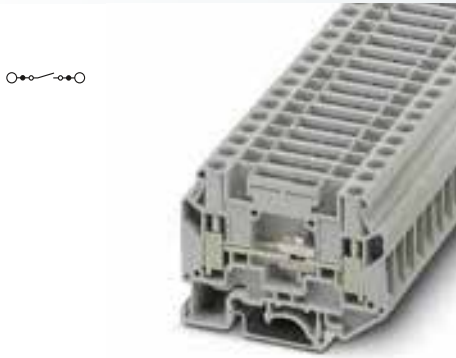

6 (10) mm², 57 A, disconnect terminal block

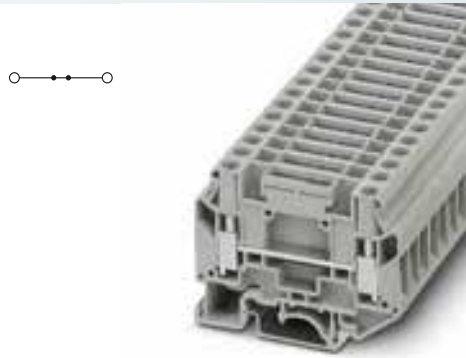

6 (10) mm², 57 A, feed-through terminal block

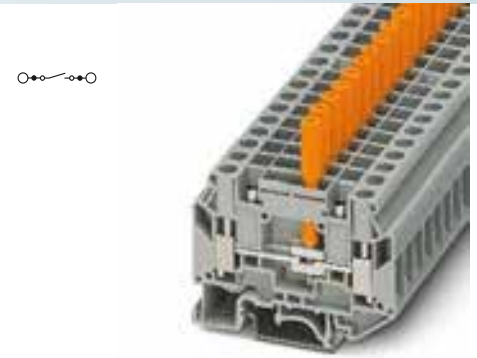

6 (10) mm², 57 A, disconnect terminal block



Technical data			
Width	Length	Height NS 35/7,5	
8.2	66.5	48	
Width	Length	Height NS 32	
8.2	66.5	53	
I _{max} [A]	U _{max} [V]	max. Ø [mm ²]	AWG (UL)
57	500	0.5 - 10	26-8
IEC 60947-7-1			
IEC	UL / CUL	CSA	IEC/ EN 60079-7
500	600	600	-
41 / 6	30	30 / -	-
6	-	-	-
20 - 8	26-8	26-8	-
Rigid	Flexible	Ferrule without/with plastic sleeve	
0.5 - 10	0.5 - 6	0.5 - 6	0.5 - 6
0.5 - 2.5	0.5 - 4	0.5 - 2.5	-
-	-	-	0.5 - 4
10			
M4 / 1.5 - 1.6			
M3 / 0.6 - 0.8			
-			
PA			
V0			

Technical data			
Width	Length	Height NS 35/7,5	
8.2	66.5	48	
Width	Length	Height NS 32	
8.2	66.5	53	
I _{max} [A]	U _{max} [V]	max. Ø [mm ²]	AWG (UL)
57	800	0.5 - 10	26-8
IEC 60947-7-1			
IEC	UL / CUL	CSA	IEC/ EN 60079-7
800	600	600	-
41 / 6	30	30 / -	-
6	-	-	-
20 - 8	26-8	26-8	-
Rigid	Flexible	Ferrule without/with plastic sleeve	
0.5 - 10	0.5 - 6	0.5 - 6	0.5 - 6
0.5 - 2.5	0.5 - 4	0.5 - 2.5	-
-	-	-	0.5 - 4
10			
M4 / 1.5 - 1.6			
- / -			
0.6 - 0.8			
PA			
V0			

Technical data			
Width	Length	Height NS 35/7,5	
8.2	66.5	66	
Width	Length	Height NS 32	
8.2	66.5	71	
I _{max} [A]	U _{max} [V]	max. Ø [mm ²]	AWG (UL)
57	500	0.5 - 10	26-8
IEC 60947-7-1			
IEC	UL / CUL	CSA	IEC/ EN 60079-7
500	600	600	-
41 / 6	30	30 / -	-
6	-	-	-
20 - 8	26-8	26-8	-
Rigid	Flexible	Ferrule without/with plastic sleeve	
0.5 - 10	0.5 - 6	0.5 - 6	0.5 - 6
0.5 - 2.5	0.5 - 4	0.5 - 2.5	-
-	-	-	0.5 - 4
10			
M4 / 1.5 - 1.6			
- / -			
-			
PA			
V0			

Ordering data			
Type	I _{max}	Order No.	Pcs./Pkt.
UK 6-T		3072803	50

Ordering data			
Type	I _{max}	Order No.	Pcs./Pkt.
UKD 6		3072801	50

Ordering data			
Type	I _{max}	Order No.	Pcs./Pkt.
UK 6-TK-P		3072804	50

Accessories			
D-UK 6-T		3072802	50
SCBI 10-8,15	24 A	3245134	10
SCBI 10-8,15 ISO	24 A	3000417	10
SB 6-T 2-8	32 A	3075842	10
SB 6-T 3-8	32 A	3075843	10
SB 6-T 4-8	32 A	3075844	10
SBP 6-T 2-8	32 A	3070321	10
SBP 6-T 3-8	32 A	3070322	10
SBP 6-T 4-8	32 A	3070323	10
TPS 3/20/5		3246586	10
PSBJ 6-T OG		3070320	10
PS-8/2,3MM RD		3048564	10
MPS-MT/ 4MM		3048577	10
KSS 8		0311540	10
KSS 4-8		0309549	10
SF-SL 0,8X4,0-100 S-VDE		1212588	10

Accessories			
D-UK 6-T		3072802	50
SCBI 10-8,15	24 A	3245134	10
SCBI 10-8,15 ISO	24 A	3000417	10
SB 6-T 2-8	32 A	3075842	10
SB 6-T 3-8	32 A	3075843	10
SB 6-T 4-8	32 A	3075844	10
SBP 6-T 2-8	32 A	3070321	10
SBP 6-T 3-8	32 A	3070322	10
SBP 6-T 4-8	32 A	3070323	10
TPS 3/20/5		3246586	10
PSBJ 6-T OG		3070320	10
PS-8/2,3MM RD		3048564	10
MPS-MT/ 4MM		3048577	10
KSS 8		0311540	10
KSS 4-8		0309549	10
SF-SL 0,8X4,0-100 S-VDE		1212588	10

Accessories			
D-UK 6-T		3072802	50
SCBI 10-8,15	24 A	3245134	10
SCBI 10-8,15 ISO	24 A	3000417	10
TPS 3/20/5		3246586	10
PSBJ 6-T OG		3070320	10
PS-8/2,3MM RD		3048564	10
MPS-MT/ 4MM		3048577	10
KSS 8		0311540	10
KSS 4-8		0309549	10
SF-SL 0,8X4,0-100 S-VDE		1212588	10

UC-TM 8, UCT-TM 8 or ZB 8 (see Catalog 3)

UC-TM 8, UCT-TM 8 or ZB 8 (see Catalog 3)

UC-TM 8, UCT-TM 8 or ZB 8 (see Catalog 3)

Terminal blocks – Classic

UK universal modular terminal blocks

Measuring transducers and slide-type terminal blocks URTK 6 / UGSK 6

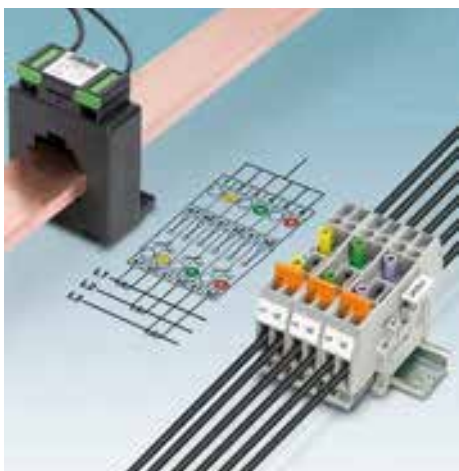

- The URTK 6 test disconnect terminal block and the UGSK 6 slide-type terminal block were developed specifically for use in current transformer secondary circuits
- Can be fitted on both sides with fixed and switchable bridges as well as test sockets with a 4 mm diameter



- The extensive range of accessories of the URTK 6 measuring transducer disconnect terminal blocks with spring-cage connection can also be used for the SRTK 6 measuring transducer disconnect terminal blocks with screw connection.
- For more information and technical data on the spring-cage connection versions, see page 240

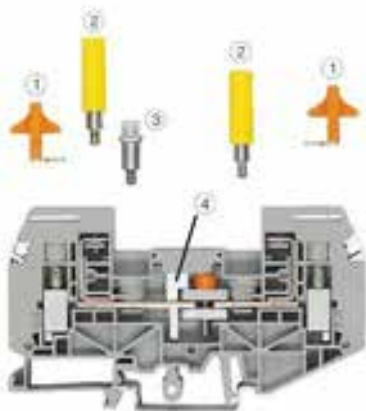

- Only two URTK 6 test disconnect terminal blocks are required for a current transformer measuring circuit
 - Less space required compared to creating circuits with slide-type terminal blocks
- ① SB ... switch bar
 - ② 4 mm Ø test sockets PSBJ-URTK 6 ...
 - ③ Fixed bridge for cross connection FBRI 10-8 N
 - ④ Switching lock S-URTK/SP

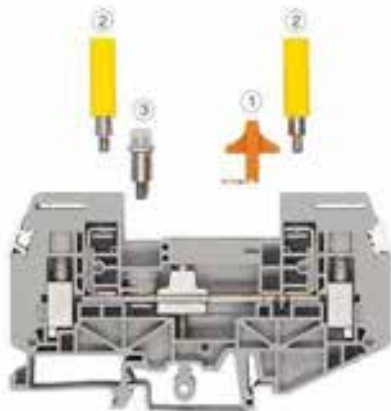

- Several measuring devices or protective relays can be connected individually using the UGSK 6 slide-type terminal block
 - The slide can be connected with the switch bar depending on the switching tasks
- ① SB ... switch bar
 - ② 4 mm Ø test sockets PSBJ-URTK 6 ...
 - ③ Fixed bridge for cross connection FBRI 10-8 N

Notes:

For other test sockets, see page 587

For corresponding AP-ME and AH-ME terminal strip covers, see Catalog 3.

Dimensions

[mm]

Dimensions

[mm]

Maximum electrical data

Rated data

Rated voltage [V]
Nominal current / cross section [A] / [mm²]
Rated cross section [mm²]
Cross section range AWG

Connection capacity

1 conductor [mm²]
2 conductors (of the same type) [mm²]
2 flexible conductors with a TWIN ferrule [mm²]

General data

Stripping length [mm]
Terminal point: Thread / torque - / [Nm]

Disconnect slide: Thread / torque - / [Nm]

Torque: Test socket, fixed bridge, switch bar [Nm]

Insulating material

Flammability rating in accordance with UL 94

Description	No. of pos.	Color
Test disconnect terminal block , for mounting on NS 35 ... and NS 32 ...		gray
Feed-through terminal block , for mounting on NS 32... or NS 35...		gray

Cover, width: 2 mm gray

Switching bridge, complete	No. of pos.	Color
	2	orange
	3	orange
	4	orange
for bridging between non-adjacent terminals	10	orange

Fixed bridge, isolated 10 silver

Switching lock, excludes the possibility of an unintentional operation of the disconnect slide white

Short-circuit plug, for short circuiting neighboring terminal blocks, fully insulated, 2-pos. black

Test socket, insulated	No. of pos.	Color
	2	black
	3	transparent
	4	blue
	5	yellow
	6	green
	7	violet
	8	black

Screwdriver, for the terminal point

Screwdriver, for the female test connector

Lateral groove labeling

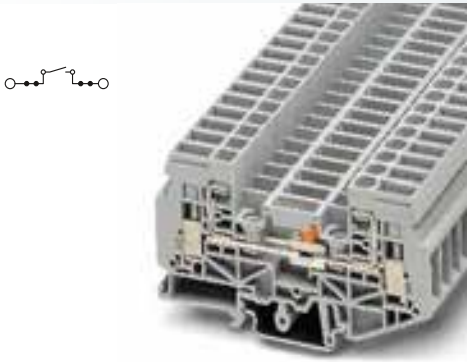

6 (10) mm², 57 A, test disconnect terminal block

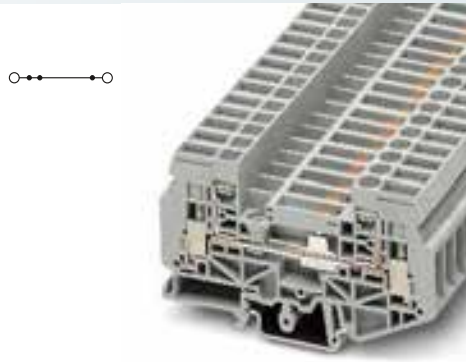

6 (10) mm², 57 A, slide-type terminal block

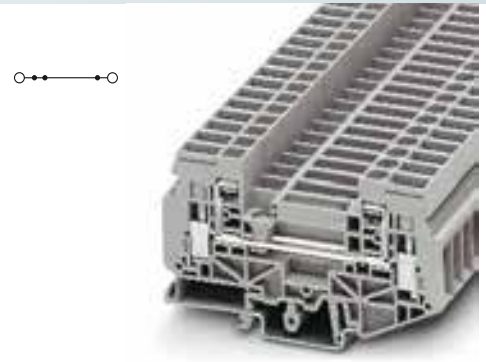

6 (10) mm², 57 A, feed-through terminal block, same shape



Technical data			
Width	Length	Height NS 35/7,5	
8.2	91	51	
Width	Length	Height NS 32	
8.2	91	56	
I_{max} [A]	U_{max} [V]	max. Ø [mm ²]	AWG (UL)
57	500	0.5 - 10	26-8
IEC 60947-7-1			
IEC	UL / CUL	CSA	IEC/ EN 60079-7
500	300	-	-
41 / 6	50 / -	-	-
6	-	-	-
20 - 8	26-8	-	-
Rigid	Flexible	Ferrule without/with plastic sleeve	
0.5 - 10	0.5 - 6	0.5 - 6	0.5 - 6
0.5 - 2.5	0.5 - 4	0.5 - 2.5	-
-	-	-	0.5 - 4
10			
M4 / 1.2 - 1.4			
M3 / 0.6 - 0.8			
0.6 - 0.8			
PA			
V0			

Technical data			
Width	Length	Height NS 35/7,5	
8.2	91	51	
Width	Length	Height NS 32	
8.2	91	-	
I_{max} [A]	U_{max} [V]	max. Ø [mm ²]	AWG (UL)
57	400	0.5 - 10	26-8
IEC 60947-7-1			
IEC	UL / CUL	CSA	IEC/ EN 60079-7
400	300	-	-
41 / 6	50 / -	-	-
6	-	-	-
20 - 8	26-8	-	-
Rigid	Flexible	Ferrule without/with plastic sleeve	
0.5 - 10	0.5 - 6	0.5 - 6	0.5 - 6
0.5 - 2.5	0.5 - 4	0.5 - 2.5	-
-	-	-	0.5 - 4
10			
M4 / 1.2 - 1.4			
- / -			
-			
PA			
V0			

Technical data			
Width	Length	Height NS 35/7,5	
8.2	91	51	
Width	Length	Height NS 32	
8.2	91	56	
I_{max} [A]	U_{max} [V]	max. Ø [mm ²]	AWG (UL)
57	500	0.5 - 10	26-8
IEC 60947-7-1			
IEC	UL / CUL	CSA	IEC/ EN 60079-7
500	300	-	-
41 / 6	50 / -	-	-
6	-	-	-
20 - 8	26-8	-	-
Rigid	Flexible	Ferrule without/with plastic sleeve	
0.5 - 10	0.5 - 6	0.5 - 6	0.5 - 6
0.5 - 2.5	0.5 - 4	0.5 - 2.5	-
-	-	-	0.5 - 4
10			
M4 / 1.2 - 1.4			
- / -			
0.6 - 0.8			
PA			
V0			

Ordering data			
Type	I_{max}	Order No.	Pcs./Pkt.
URTK 6		3026272	50

Ordering data			
Type	I_{max}	Order No.	Pcs./Pkt.
UGSK 6		3026285	50

Ordering data			
Type	I_{max}	Order No.	Pcs./Pkt.
URDK 6		3026706	50

Accessories			
D-URTK 6		3026340	10
SB 2-8-T	41 A	3026366	10
SB 3-8-T	41 A	3026492	10
SB 4-8-T	41 A	3026379	10
SB 10-8-T SO	41 A	3026395	10
FBRI 10-8 N	45 A	2772080	10
S-URTK/SP		0311155	50
KSSI 2-8		3000722	10
KSSI 4-8		3000735	10
PSBJ-URTK 6 FARBLOS		3026450	10
PSBJ-URTK 6 BU		3026434	10
PSBJ-URTK 6 YE		3026405	10
PSBJ-URTK 6 GN		3026418	10
PSBJ-URTK 6 VT		3026421	10
PSBJ-URTK 6 BK		3026447	10
SZS 1,0X4,0 VDE		1205066	10
SF-SL 0,6X3,5-100 S-VDE		1212587	10

Accessories			
D-URTK 6		3026340	10
SB 2-8-T	41 A	3026366	10
SB 3-8-T	41 A	3026492	10
SB 4-8-T	41 A	3026379	10
SB 10-8-T SO	41 A	3026395	10
FBRI 10-8 N	45 A	2772080	10
KSSI 2-8		3000722	10
KSSI 4-8		3000735	10
PSBJ-URTK 6 FARBLOS		3026450	10
PSBJ-URTK 6 BU		3026434	10
PSBJ-URTK 6 YE		3026405	10
PSBJ-URTK 6 GN		3026418	10
PSBJ-URTK 6 VT		3026421	10
PSBJ-URTK 6 BK		3026447	10
SZS 1,0X4,0 VDE		1205066	10
SF-SL 0,6X3,5-100 S-VDE		1212587	10

Accessories			
D-URTK 6		3026340	10
SB 2-8-T	41 A	3026366	10
SB 3-8-T	41 A	3026492	10
SB 4-8-T	41 A	3026379	10
SB 10-8-T SO	41 A	3026395	10
FBRI 10-8 N	45 A	2772080	10
KSSI 2-8		3000722	10
KSSI 4-8		3000735	10
PSBJ-URTK 6 FARBLOS		3026450	10
PSBJ-URTK 6 BU		3026434	10
PSBJ-URTK 6 YE		3026405	10
PSBJ-URTK 6 GN		3026418	10
PSBJ-URTK 6 VT		3026421	10
PSBJ-URTK 6 BK		3026447	10
SZS 1,0X4,0 VDE		1205066	10
SF-SL 0,6X3,5-100 S-VDE		1212587	10

UC-TM 8, UCT-TM 8 or ZB 8 (see Catalog 3)

UC-TM 8, UCT-TM 8 or ZB 8 (see Catalog 3)

UC-TM 8, UCT-TM 8 or ZB 8 (see Catalog 3)

Terminal blocks – Classic

UK universal modular terminal blocks

Meas. transducers disconnect terminal blocks URTK/SP

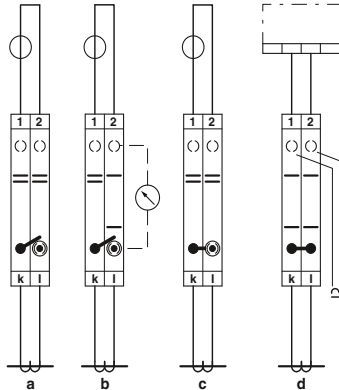
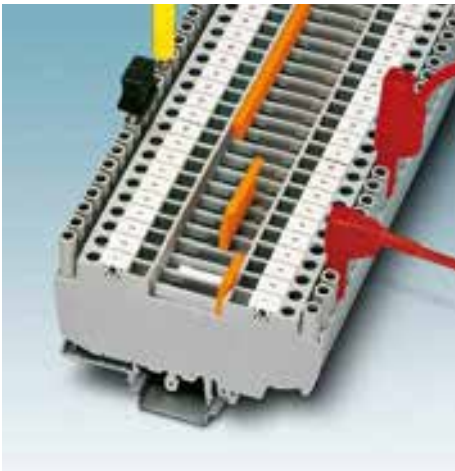

- Test disconnect terminal block URTK/SP should be used for all measurement and test work in the current transformer secondary circuits
- The terminal blocks can be equipped with fixed and switchable bridges on both sides
- Touch-proof test sockets with 4 mm diameter are already permanently integrated
- The URTKD/SP can be used as a feed-through terminal block of the same shape without a disconnect function

- The URTK/SP test disconnect terminal block and the SB 2-URTK/SP 2-pos. switching bridge can be used to perform all switching tasks per current transformer core
- a Normal operation
- b Measurement checking
- c Transformer short circuit
- d Relay checking

Test disconnect terminal block URTK/SP

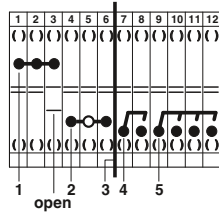

Type	Order no.
1 FBI 10-8	0203263
FB 10-URTK/SP	0311663
2 ISSBI 10-8	0301534
+ IS-K 10	1303337
3 ATP-URTK/SP	0311139
4 SB 2-URTK/SP	0360012
5 SB 4-URTK/SP	0360025

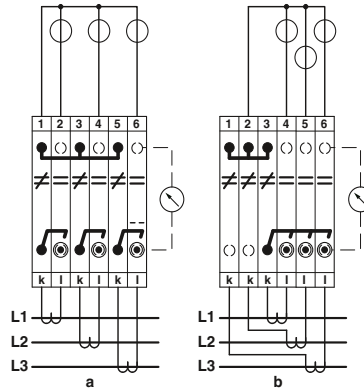

- Circuit example
- a Three-phase current transformer set
 - b Linked three-phase current transformer set

Dimensions	
Dimensions	[mm]
Dimensions	[mm]
Maximum electrical data	
Rated data	
Rated voltage	[V]
Nominal current / cross section	[A] / [mm ²]
Rated cross section	[mm ²]
Cross section range	AWG
Connection capacity	
1 conductor	[mm ²]
2 conductors (of the same type)	[mm ²]
2 flexible conductors with a TWIN ferrule	[mm ²]
General data	
Stripping length	[mm]
Terminal point: Thread / torque	- / [Nm]
Disconnect slide: Thread / torque	- / [Nm]
Insulating material	
Flammability rating in accordance with UL 94	

Description	No. of pos.	Color
Test disconnect terminal block, for mounting on NS 35 ... and NS 32 ...		gray
Feed-through terminal block, for mounting on NS 32... or NS 35...		gray

Fixed bridge, isolated	10	silver
Fixed bridge, for cross connections on both sides of the disconnect point, insulated, divisible, with 10 screws	10	silver
Switching bridge for 2 terminal blocks, for use on both sides of the disconnect point, inward switching movement, with 2 screws	2	silver
	4	silver
Isolator bridge bar, divisible, with 10 screws, for switchable branches with IS-K...	10	silver
Bridge bar isolator, as distance piece for isolator bridge bar		gray
Switching lock, excludes the possibility of an unintentional operation of the disconnect slide		white
Partition plate, 2 mm width		gray
Short-circuit plug, for short circuiting neighboring terminal blocks, fully insulated, 2-pos.		black
4-pos.		black
Screwdriver		
Lateral groove labeling		



6 (10) mm², 50 A, test disconnect terminal block

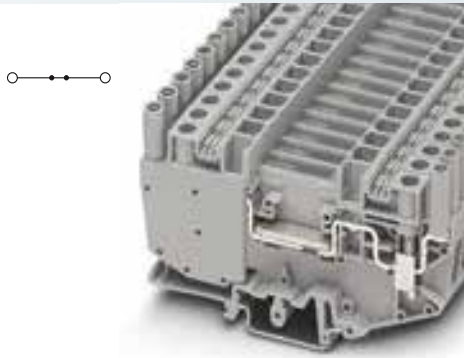

6 (10) mm², 50 A, feed-through terminal block, same shape



Short-circuit connector



Technical data			
Width	Length	Height NS 35/7,5	
8.2	99.5	59	
Width	Length	Height NS 32	
8.2	99.5	64	
I_{max} [A]	U_{max} [V]	max. Ø [mm ²]	AWG (UL)
50	500	0.5 - 10	26-8
IEC 60947-7-1			
IEC	UL / CUL	CSA	IEC/ EN 60079-7
500	300	300	-
41 / 6	45 / -	45 / -	-
6	-	-	-
20 - 8	26-8	26-8	-
Rigid	Flexible	Ferrule without/with plastic sleeve	
0.5 - 10	0.5 - 6	0.5 - 6	0.5 - 6
0.5 - 2.5	0.5 - 4	0.5 - 2.5	-
-	-	-	0.5 - 4
11			
M4 / 1.5 - 1.8			
M3 / 0.6 - 0.8			
PA			
V0			

Technical data			
Width	Length	Height NS 35/7,5	
8.2	99.5	59	
Width	Length	Height NS 32	
8.2	99.5	64	
I_{max} [A]	U_{max} [V]	max. Ø [mm ²]	AWG (UL)
50	500	0.5 - 10	-
IEC 60947-7-1			
IEC	UL / CUL	CSA	IEC/ EN 60079-7
500	-	-	-
41 / 6	-	-	-
6	-	-	-
20 - 8	-	-	-
Rigid	Flexible	Ferrule without/with plastic sleeve	
0.5 - 10	0.5 - 6	0.5 - 6	0.5 - 6
0.5 - 2.5	0.5 - 4	0.5 - 2.5	-
-	-	-	0.5 - 4
11			
M4 / 1.5 - 1.8			
- / -			
PA			
V0			

Technical data			
Width	Length	Height NS 35/7,5	
16.2	11	-	
Width	Length	Height NS 32	
16.2	11	-	
		max. Ø [mm ²]	AWG (UL)
		-	-
IEC			
IEC	UL / CUL	CSA	IEC/ EN 60079-7
-	-	-	-
- / -	-	-	-
-	-	-	-
-	-	-	-
Rigid	Flexible	Ferrule without/with plastic sleeve	
-	-	-	-
-	-	-	-
-	-	-	-
11			
- / -			
- / -			
PA			
V0			

Ordering data			
Type	I_{max}	Order No.	Pcs./Pkt.
URTK/SP		0311126	50

Ordering data			
Type	I_{max}	Order No.	Pcs./Pkt.
URTKD/SP		0311142	50

Ordering data		
Type	Order No.	Pcs./Pkt.

Accessories			
FBI 10- 8	50 A	0203263	10
FB 10- URTK/SP	50 A	0311663	10
SB 2-URTK/SP	35 A	0360012	10
SB 4-URTK/SP	35 A	0360025	10
ISSBI 10- 8	35 A	0301534	10
IS-K 10		1303337	100
S-URTK/SP		0311155	50
ATP-URTK/SP		0311139	10
SZS 1,0X4,0 VDE		1205066	10
ZB 8 (see Catalog 3)			

Accessories			
FBI 10- 8	50 A	0203263	10
FB 10- URTK/SP	50 A	0311663	10
SB 2-URTK/SP	35 A	0360012	10
SB 4-URTK/SP	35 A	0360025	10
ISSBI 10- 8	35 A	0301534	10
IS-K 10		1303337	100
ATP-URTK/SP		0311139	10
SZS 1,0X4,0 VDE		1205066	10
ZB 8 (see Catalog 3)			

Accessories		
KSSI 2-8	3000722	10
KSSI 4-8	3000735	10

Terminal blocks – Classic

UK universal modular terminal blocks

Screw connection test disconnect terminal block with UK 4-SD test isolating plug

This disconnect terminal block offers numerous advantages especially for testing in measuring and signal circuits:

- Simultaneous interruption of individual or multiple neighboring disconnect terminal blocks by using the PS 6-DI-SD isolating plug
- Safe, uninterruptible looping in of measuring devices in the circuit with the aid of the PS 6-CT-SD test isolating plug
- Safe contacting of the potentials after opening the disconnect point through use of the PS 6-VT-SD test isolating plug
- Terminal points in the test isolating plugs allow individual test applications to be wired
- Easy potential distribution in the terminal strip with insertion bridges

PROJECT complete planning enables the quick and convenient planning and configuration of error-free terminal strips.

Circuit examples

- Normal operation: no plug inserted
- Measurement checking: looping in a measuring device with the PS 6-CT-SD test isolating plug
- Current transformer short circuit: measurement split between two positions



4 (6) mm², test disconnect terminal block



Dimensions	
Dimensions	[mm]
Dimensions	[mm]
Maximum electrical data	
Rated data	
Rated voltage	[V]
Nominal current / cross section	[A] / [mm ²]
Rated cross section	[mm ²]
Cross section range	AWG
Connection capacity	
1 conductor	[mm ²]
2 conductors (of the same type)	[mm ²]
2 flexible conductors with a TWIN ferrule	[mm ²]
General data	
Stripping length	[mm]
Screw thread	
Tightening torque	[Nm]
Insulating material	
Flammability rating in accordance with UL 94	

Technical data			
Width	Length	Height NS 35/7,5	
6.2	45.5	47.3	
Width	Length	Height NS 32	
6.2	45.5	52.3	
I _{max} [A]	U _{max} [V]	max. Ø [mm ²]	AWG (UL)
10	500	0.5 - 6	20-10
IEC 60947-7-1			
IEC	UL / CUL	CSA	IEC/ EN 60079-7
Rated voltage	300	-	-
Nominal current / cross section	10 / 4	-	-
Rated cross section	4	-	-
Cross section range	20 - 10	-	-
Connection capacity		Rigid	Flexible
1 conductor	[mm ²]	0.5 - 6	0.5 - 4
2 conductors (of the same type)	[mm ²]	0.5 - 1.5	0.5 - 1.5
2 flexible conductors with a TWIN ferrule	[mm ²]	-	-
		Ferrule without/with plastic sleeve	
		-	0.5 - 4
		-	-
		-	0.5 - 1.5
General data			
Stripping length	[mm]	9	
Screw thread		M3	
Tightening torque	[Nm]	0.6 - 0.8	
Insulating material		PA	
Flammability rating in accordance with UL 94		V0	

Description	No. of pos.	Color
Measuring transducer disconnect terminal block, for mounting on NS 35		gray
Isolating plug		gray
Test isolating plug		green
Test isolating plug		red

Cover, width: 2.2 mm		gray
Insertion bridge, insulated		
	2	gray
	3	gray
	10	gray
Partition plate, 1.5 mm wide		gray
Screwdriver		
Lateral groove labeling		

Ordering data			
Type	I _{max}	Order No.	Pcs./Pkt.
UK 4-SD		3246861	50

Accessories			
D-UK 4-SD		3246862	50
EB 2- 6	11 A	0201155	100
EB 3- 6	11 A	0201142	100
EB 10- 6	11 A	0201139	10
ATP-UK		3003224	50
SF-SL 0,6X3,5-100 S-VDE		1212587	10

UC-TM 6, UCT-TM 6 or ZB 6 (see Catalog 3)

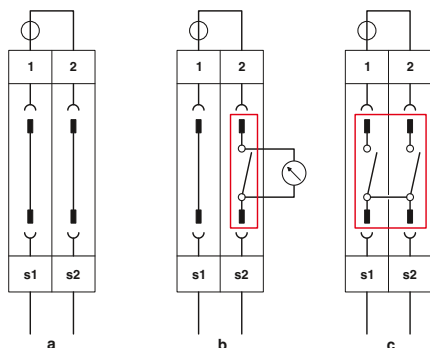



Isolating plug, disconnect function only



2.5 (2.5) mm² test disconnect plug, contacts before the signal isolation



2.5 (2.5) mm² test disconnect plug, contacts after the signal isolation



Technical data			
Width	Length	Height NS 35/7,5	
6.2	39.3	-	
Width	Length	Height NS 32	
6.2	39.3	-	
		max. Ø [mm ²]	AWG (UL)
		-	20-10
IEC	UL / CUL	CSA	IEC/ EN 60079-7
-	300	-	-
- / -	-	-	-
-	-	-	-
-	20-10	-	-
Rigid	Flexible	Ferrule without/with plastic sleeve	
-	-	-	-
-	-	-	-
-	-	-	-
PA			
V0			

Technical data			
Width	Length	Height NS 35/7,5	
6.2	39.3	-	
Width	Length	Height NS 32	
6.2	39.3	-	
I _{max.} [A]	U _{max.} [V]	max. Ø [mm ²]	AWG (UL)
8	250	0.5 - 2.5	20-10
IEC 60947-7-1			
IEC	UL / CUL	CSA	IEC/ EN 60079-7
250	300	-	-
6 / -	10	-	-
2.5	-	-	-
20 - 14	20-10	-	-
Rigid	Flexible	Ferrule without/with plastic sleeve	
0.5 - 2.5	0.5 - 2.5	0.5 - 1.5	0.5 - 1.5
-	-	-	-
-	-	-	-
7			
M3			
0.5 - 0.6			
PA			
V0			

Technical data			
Width	Length	Height NS 35/7,5	
6.2	39.3	-	
Width	Length	Height NS 32	
6.2	39.3	-	
I _{max.} [A]	U _{max.} [V]	max. Ø [mm ²]	AWG (UL)
8	250	0.5 - 2.5	20-10
IEC 60947-7-1			
IEC	UL / CUL	CSA	IEC/ EN 60079-7
250	300	-	-
6 / -	10	-	-
2.5	-	-	-
20 - 14	20-10	-	-
Rigid	Flexible	Ferrule without/with plastic sleeve	
0.5 - 2.5	0.5 - 2.5	0.5 - 1.5	0.5 - 1.5
-	-	-	-
-	-	-	-
7			
M3			
0.5 - 0.6			
PA			
V0			

Ordering data		
Type	Order No.	Pcs./Pkt.
PS 6-DI-SD	3246856	50

Ordering data		
Type	Order No.	Pcs./Pkt.
PS 6-CT-SD	3246857	50

Ordering data		
Type	Order No.	Pcs./Pkt.
PS 6-VT-SD	3246858	50

Accessories		

Accessories		
SZF 1-0,6X3,5	1204517	10

Accessories		
SZF 1-0,6X3,5	1204517	10

UC-TM 6, UCT-TM 6 or ZB 6 (see Catalog 3)

UC-TM 6, UCT-TM 6 or ZB 6 (see Catalog 3)

UC-TM 6, UCT-TM 6 or ZB 6 (see Catalog 3)

Terminal blocks – Classic

UK universal modular terminal blocks

Double-level diode terminal blocks UKK ...

- Double-level diode terminal blocks with various forms of wiring are available for a huge range of applications
- Electronic components can be individually soldered with UKK 5-BE

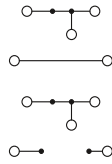

4 (4) mm², 32 A, double-level terminal block for soldering in components

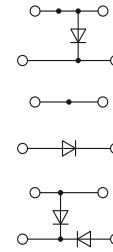

4 (4) mm², 32 A, double-level diode terminal block

Notes:
1) Integrated: Rectifier module B 250 C 1500, reverse voltage: 600 V, nominal voltage: 250 V, nominal current: 1.5 A
2) Max. installation width of components to be soldered in: 5 mm
3) Integrated: Diode 1N 4007, reverse voltage: 1300 V, maximum continuous current: 0.5 A



Technical data				
Width	Length	Height NS 35/7,5		
6.2	56	62		
Width	Length	Height NS 32		
6.2	56	67		
I _{max} [A]	U _{max} [V]	max. Ø [mm ²]	AWG (UL)	
32	500	0.2 - 4	-	
IEC 60947-7-1				
IEC	UL / CUL	CSA	IEC/ EN 60079-7	
Rated voltage [V]	500	-	-	
Nominal current / cross section [A] / [mm ²]	32 / 4	-	-	
Rated cross section [mm ²]	4	-	-	
Cross section range AWG	24 - 12	-	-	
Connection capacity				
	Rigid	Flexible	Ferrule without/with plastic sleeve	
1 conductor [mm ²]	0.2 - 4	0.2 - 4	0.25 - 4	0.25 - 2.5
2 conductors (of the same type) [mm ²]	0.2 - 1.5	0.2 - 1.5	0.25 - 1.5	-
2 flexible conductors with a TWIN ferrule [mm ²]	-	-	-	0.5 - 1.5
General data				
Stripping length [mm]	8			
Screw thread	M3			
Tightening torque [Nm]	0.6 - 0.8			
Insulating material	PA			
Flammability rating in accordance with UL 94	V0			



Technical data				
Width	Length	Height NS 35/7,5		
6.2	56	62		
Width	Length	Height NS 32		
6.2	56	67		
I _{max} [A]	U _{max} [V]	max. Ø [mm ²]	AWG (UL)	
32	500	0.2 - 4	26-10	
IEC 60947-7-1				
IEC	UL / CUL	CSA	IEC/ EN 60079-7	
Rated voltage [V]	500	600	-	
Nominal current / cross section [A] / [mm ²]	32 / 4	30 / -	-	
Rated cross section [mm ²]	4	-	-	
Cross section range AWG	24 - 12	26-10	-	
Connection capacity				
	Rigid	Flexible	Ferrule without/with plastic sleeve	
1 conductor [mm ²]	0.2 - 4	0.2 - 4	0.25 - 4	0.25 - 2.5
2 conductors (of the same type) [mm ²]	0.2 - 1.5	0.2 - 1.5	0.25 - 1.5	-
2 flexible conductors with a TWIN ferrule [mm ²]	-	-	-	0.5 - 1.5
General data				
Stripping length [mm]	8			
Screw thread	M3			
Tightening torque [Nm]	0.6 - 0.8			
Insulating material	PA			
Flammability rating in accordance with UL 94	V0			

Description	No. of pos.	Color
Terminal block, component can be soldered in ²⁾		gray
Terminal block, for soldering in a component from top to bottom left and from bottom right to bottom left ²⁾		gray
Terminal block, with integrated 1N 4007 diode, conducting from top to bottom ³⁾		gray
Terminal block, with integrated 1N 4007 diode, conducting from bottom to top ³⁾		gray
Terminal block, with integrated 1N 4007 diode, conducting from bottom left to bottom right ³⁾		gray
Terminal block, with two integrated 1N 4007 diodes, conducting direction from top to bottom left and from bottom right to bottom left ¹⁾		gray

Ordering data				
Type	I _{max}	Order No.	Pcs./Pkt.	
UKK 5-BE		3048027	50	
UKK 5-2 BE		3048030	50	
UKK 5-DIO/O-U		2791016	50	
UKK 5-DIO/U-O		2791032	50	
UKK 5-DIO/UL-UR		2791029	50	
UKK 5-2DIO/O-UL/UR-UL		2791113	50	

Ordering data				
Type	I _{max}	Order No.	Pcs./Pkt.	
UKK 5-DIO/O-U		2791016	50	
UKK 5-DIO/U-O		2791032	50	
UKK 5-DIO/UL-UR		2791029	50	
UKK 5-2DIO/O-UL/UR-UL		2791113	50	

Accessories		
Cover, width: 2.5 mm	gray	
Spacer plate, compensates for level offsets, width: 2.5 mm	gray	
Fixed bridge, isolated	10	silver
Screwdriver		
Lateral groove labeling		

Accessories				
D-UKK 3/5		2770024	50	
DP-UKK 3/5		2770794	50	
FBI 10- 6	32 A	0203250	10	
SF-SL 0,6X3,5-100 S-VDE		1212587	10	
ZB 6 (see Catalog 3)				

Accessories				
D-UKK 3/5		2770024	50	
DP-UKK 3/5		2770794	50	
FBI 10- 6	32 A	0203250	10	
SF-SL 0,6X3,5-100 S-VDE		1212587	10	
ZB 6 (see Catalog 3)				

Double-level terminal blocks with LED display UKK ...

- The integrated LED display in UKK 5-LA ... indicates the voltage condition of the lower feed-through level
- Available in three voltage levels up to 250 V

Notes:

1) The operating voltage is determined by the LED version.

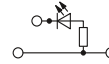

4 (4) mm², 32 A, double-level terminal block with LED



Dimensions		[mm]	
Dimensions			
Dimensions			
Maximum electrical data			
Rated data			
Rated voltage	[V]	500 ¹⁾	600
Nominal current / cross section	[A] / [mm ²]	32 / 4	20 / -
Rated cross section	[mm ²]	4	-
Cross section range	AWG	24 - 12	26-10
Connection capacity			
1 conductor	[mm ²]	0.2 - 4	0.2 - 4
2 conductors (of the same type)	[mm ²]	0.2 - 1.5	0.2 - 1.5
2 flexible conductors with a TWIN ferrule	[mm ²]	-	-
General data			
Stripping length	[mm]	8	
Screw thread		M3	
Tightening torque	[Nm]	0.6 - 0.8	
Insulating material		PA	
Flammability rating in accordance with UL 94		V0	

Technical data				
Width	Length	Height NS 35/7,5		
6.2	56	62		
Width	Length	Height NS 32		
6.2	56	67		
I _{max} [A]	U _{max} [V]	max. Ø [mm ²]	AWG (UL)	
32	500 ¹⁾	0.2 - 4	26-10	
IEC	UL / CUL	CSA	IEC / EN 60079-7	
500 ¹⁾	600	-	-	
32 / 4	20 / -	-	-	
4	-	-	-	
24 - 12	26-10	-	-	
Rigid	Flexible	Ferrule		
			without/with plastic sleeve	
0.2 - 4	0.2 - 4	0.25 - 4	0.25 - 2.5	
0.2 - 1.5	0.2 - 1.5	0.25 - 1.5	-	
-	-	-	0.5 - 1.5	

Description	No. of pos.	Color
Double-level terminal block, with LED display for 12 - 30 V DC, 0.7 - 2.4 mA		gray
with LED display for 110 - 250 V AC/DC, 0.1 - 0.5 mA		gray

Ordering data			
Type	I _{max}	Order No.	Pcs./Pkt.
UKK 5-LA 24 RD/U-O		2791320	50
UKK 5-LA 230		2791359	50

Cover, width: 2.5 mm		gray
Spacer plate, compensates for level offsets, width: 2.5 mm		gray
Fixed bridge, isolated	10	silver
Insertion bridge, insulated	2	gray
	3	gray
	10	gray
Isolator bridge bar, divisible, with 10 screws, for switchable branches with IS-K...	10	silver
Bridge bar isolator, as distance piece for isolator bridge bar		gray
Separating disk, for separation of neighboring bridges, can be fitted later, no loss of pitch		gray
Partition plate, 2.5 mm wide		gray
Screwdriver		
SF-SL 0,6X3,5-100 S-VDE		
Lateral groove labeling		
ZB 6 (see Catalog 3)		

Accessories			
Type	I _{max}	Order No.	Pcs./Pkt.
D-UKK 3/5		2770024	50
DP-UKK 3/5		2770794	50
FBI 10- 6	32 A	0203250	10
EB 2- 6	28 A	0201155	100
EB 3- 6	28 A	0201142	100
EB 10- 6	28 A	0201139	10
ISSBI 10- 6	24 A	0301505	10
IS-K 4		1302338	100
TS-KK 3		2770215	50
ATP-UKK 3/5		2778521	50
SF-SL 0,6X3,5-100 S-VDE		1212587	10
ZB 6 (see Catalog 3)			

Component terminal blocks UDK ...



- The constant current circuits common in process automation transmit the measured values as a load-independent current of 0(4) - 20 mA
- A voltage signal pick-off can be implemented in the measuring line using this terminal block, thus allowing the signal to be used as an analog signal for process computers
- The four-conductor connection permits convenient wiring
- The lower level is assigned to the measuring line while the upper level is used for voltage pick-off via the 249 Ω resistor

Notes:
1) The current is determined by the component used.
Maximum width of components to be soldered in: 5 mm



4 (6) mm², feed-through terminal block, 4 connections, with differential voltage resistor



Dimensions	
Dimensions	[mm]
Dimensions	[mm]
Maximum electrical data	
Rated data	
Rated voltage	[V]
Nominal current / cross section	[A] / [mm ²]
Rated cross section	[mm ²]
Cross section range	AWG
Connection capacity	
1 conductor	[mm ²]
2 conductors (of the same type)	[mm ²]
2 flexible conductors with a TWIN ferrule	[mm ²]
Max. cross section with insertion bridge	[mm ²]
General data	
Stripping length	[mm]
Screw thread	
Tightening torque	[Nm]
Insulating material	
Flammability rating in accordance with UL 94	

Technical data			
Width	Length	Height NS 35/7,5	
6.2	63.5	47	
Width	Length	Height NS 32	
6.2	63.5	52	
I _{max} [A]	U _{max} [V]	max. Ø [mm ²]	AWG (UL)
	630	0.2 - 6	-
IEC	UL / CUL	CSA	IEC/EN 60079-7
630	-	600	-
32 ¹⁾ / 4	-	10 / -	-
4	-	-	-
24 - 10	-	22-10	-
Connection capacity		Rigid	Flexible
		Ferrule without/with plastic sleeve	
1 conductor	[mm ²]	0.2 - 6	0.2 - 4
2 conductors (of the same type)	[mm ²]	0.2 - 1	0.2 - 1.5
2 flexible conductors with a TWIN ferrule	[mm ²]	-	-
Max. cross section with insertion bridge	[mm ²]	2.5	2.5
8			
M3			
0.5 - 0.6			
PA			
V2			

Description	No. of pos.	Color
Differential voltage terminal block, for self-soldering a resistor		gray
with built-in resistor 249 Ω/ ± 1%/ 1 W		gray

Ordering data			
Type	I _{max}	Order No.	Pcs./Pkt.
UDK 4-DUR		2775207	50
UDK 4-DUR 249		2775249	50

Accessories		
Cover, width: 1.5 mm		gray
Fixed bridge, isolated	10	silver
Insertion bridge, insulated	2	gray
	3	gray
	10	gray
Isolator bridge bar, divisible, with 10 screws, for switchable branches with IS-K...	10	silver
Bridge bar isolator, as distance piece for isolator bridge bar		gray
Separating disk, for separation of neighboring bridges, can be fitted later, no loss of pitch		gray
Screwdriver		
Lateral groove labeling		

Accessories			
Type	I _{max}	Order No.	Pcs./Pkt.
D-UDK 4		2775113	50
FBI 10- 6	32 A	0203250	10
EB 2- 6	26 A	0201155	100
EB 3- 6	26 A	0201142	100
EB 10- 6	26 A	0201139	10
ISSBI 10- 6	32 A	0301505	10
IS-K 4		1302338	100
TS-KK 3		2770215	50
SF-SL 0,6X3,5-100 S-VDE		1212587	10
ZB 6 (see Catalog 3)			

UDK ... LED terminal blocks for current

UDK 4-ILA ...

- For the 4 to 500 mA current range
- If a load current flows through the load, this is indicated by the LED

Notes:

- 1) Note load current diagram, see phoenixcontact.net/products
- 2) To neighboring terminal blocks



**4 (6) mm², 0.5 A, feed-through terminal block,
4 connections, with current indicator
up to 1000 mA**



Dimensions	
	[mm]
Dimensions	[mm]
Maximum electrical data	
Rated data	
Rated voltage	[V]
Nominal current / cross section	[A] / [mm ²]
Rated cross section	[mm ²]
Cross section range	AWG
Connection capacity	
1 conductor	[mm ²]
2 conductors (of the same type)	[mm ²]
2 flexible conductors with a TWIN ferrule	[mm ²]
Max. cross section with insertion bridge	[mm ²]
General data	
Stripping length	[mm]
Screw thread	
Tightening torque	[Nm]
Insulating material	
Flammability rating in accordance with UL 94	

Technical data				
Width	Length	Height NS 35/7,5		
6.2	63.5	47		
Width	Length	Height NS 32		
6.2	63.5	52		
I_{max} [A]	U_{max} [V]	max. Ø [mm ²]	AWG (UL)	
0.5 ¹⁾	500 ²⁾	0.2 - 6	30-10	
IEC	UL / CUL	CSA	IEC/ EN 60079-7	
500 ²⁾	600	600	-	
Nominal current / cross section	[A] / [mm ²]	0.5 / -	0.5 / -	
Rated cross section	[mm ²]	4	-	
Cross section range	AWG	24 - 10	30-10	
Connection capacity		Rigid	Flexible	Ferrule without/with plastic sleeve
1 conductor	[mm ²]	0.2 - 6	0.2 - 4	0.25 - 4 / 0.25 - 1.5
2 conductors (of the same type)	[mm ²]	0.2 - 1	0.2 - 1.5	0.25 - 1.5 / -
2 flexible conductors with a TWIN ferrule	[mm ²]	-	-	- / 0.5 - 2.5
Max. cross section with insertion bridge	[mm ²]	2.5	2.5	- / -
Stripping length	[mm]	8		
Screw thread		M3		
Tightening torque	[Nm]	0.5 - 0.6		
Insulating material		PA		
Flammability rating in accordance with UL 94		V2		

Description	No. of pos.	Color
Current indicator terminal block , for mounting on NS 32... or NS 35..., displays the current flow of an auxiliary current circuit using the LED		black

Ordering data			
Type	I_{max}	Order No.	Pcs./Pkt.
UDK 4-ILA 500		2775061	50

Cover , width: 1.5 mm		gray
Fixed bridge , isolated	10	silver
Insertion bridge , insulated	2	gray
	3	gray
	10	gray
Separating disk , for separation of neighboring bridges, can be fitted later, no loss of pitch		gray
Screwdriver		
Lateral groove labeling		

Accessories			
Type	I_{max}	Order No.	Pcs./Pkt.
D-UDK 4		2775113	50
FBI 10- 6	32 A	0203250	10
EB 2- 6	26 A	0201155	100
EB 3- 6	26 A	0201142	100
EB 10- 6	26 A	0201139	10
TS-KK 3		2770215	50
SF-SL 0,6X3,5-100 S-VDE		1212587	10
ZB 6 (see Catalog 3)			

Terminal blocks – Classic

UK universal modular terminal blocks

Thermoelectric voltage terminal block pairs, MTKD-...

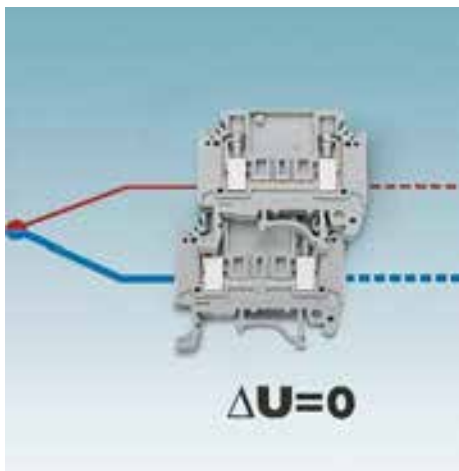

- These special terminal blocks are used to extend thermocouple equalizing conductors in corresponding measuring circuits
- The equalizing conductors are made of materials which, up to temperatures of 200°C, have the same thermal characteristics as the corresponding thermocouples
- This ensures that no false thermoelectric voltages result at the junctions of the thermocouple/terminal block/equalizing conductor and that the basic values in accordance with EN 60584/ DIN EN 60584 are adhered to

Notes:

1) Voltage to the neighboring feed-through terminal MTK.

For table for selecting thermoelectric voltage terminal blocks, visit phoenixcontact.net/products



2.5 (4) mm², feed-through terminal block pair



Technical data

Dimensions		Width		Length		Height NS 35/7,5	
[mm]		10.4	46.2	46.2	39.9		
Dimensions		Width		Length		Height NS 32	
[mm]		10.4	46.2	46.2	44.9		
Maximum electrical data							
I_{max} [A]	U_{max} [V]	max. Ø [mm ²]		AWG (UL)			
1	400 ¹⁾	0.2 - 4		28-12			
Rated data							
Rated voltage	[V]	400 ¹⁾	300	-	-		
Nominal current / cross section	[A] / [mm ²]	1 / -	10 / -	-	-		
Rated cross section	[mm ²]	2.5	-	-	-		
Cross section range	AWG	24 - 12	28-12	-	-		
Connection capacity							
1 conductor	[mm ²]	0.2 - 4	0.2 - 2.5	without/with plastic sleeve		Ferrule	
				0.2 - 1.5	0.2 - 1.5		
General data							
Stripping length	[mm]	7					
Screw thread		M3					
Tightening torque	[Nm]	0.6 - 0.8					
Insulating material		PA					
Flammability rating in accordance with UL 94		V0					

Ordering data

Description	Color	Type	Order No.	Pcs./Pkt.
Thermocouple terminal block pair for CU/CUNI44, Copper/constantan, USA type T	gray	MTKD-CU/CUNI	3100059	50
Thermocouple terminal block pair for FE/CUNI44, Iron/constantan, USA type J	gray	MTKD-FE/CUNI	3100046	50
Thermocouple terminal pair for NICR/CUNI44, Nickel-chrome/constantan, USA type E	gray	MTKD-NICR/CUNI	3100075	50
Thermocouple terminal block pair for NICRSI/NISI, Nickel-chrome silicon/nickel silicon, USA type N	gray	MTKD-NICRSI/NISI	5043321	50
Thermocouple terminal pair for NICR/NI, Nickel-chrome/Nickel, USA type K	gray	MTKD-NICR/NI	3100062	50
Thermocouple terminal block pair for E-CU/A-CU, Copper/Copper nickel, USA type R	gray	MTKD-E-CU/A-CU	3100091	50
Thermocouple terminal block pair for S-CU/E-CU, S-copper/copper, USA type B	gray	MTKD-S-CU/E-CU	3100101	50

Accessories

Cover, width: 1 mm	gray	D-MTK	3101029	50
Partition plate, for visual and electrical separation of terminal groups, 1.0 mm thick	gray	ATS-MTK	3101223	50
Screwdriver		SZS 1,0X4,0 VDE	1205066	10
Lateral groove labeling		ZB 10 (see Catalog 3)		

GTF 76 ground disconnect terminal block

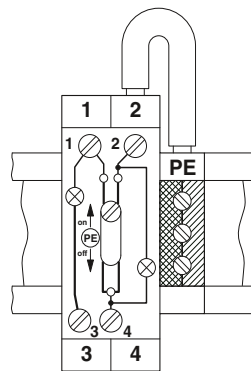

6 (10) mm², 57 A, ground disconnect terminal block

EN 60204-1/VDE 0113-1 “Electrical Equipment of Industrial Machines”, Section 9.4.3.1 states:

- “Ground faults in a control circuit may not lead to an unintentional start-up, to potentially dangerous movements or prevent the stopping of a machine.”
- The ground disconnect terminal block GTF 76 conveniently solves this problem
- When the disconnect slide is closed, switch position “on”, the yellow light signals grounded normal operation
- Once the disconnect slide has been opened to the “off” position, the red light indicates whether there is a ground fault in the control circuit

Note:

- Asymmetries in the cable isolation mean that the red display may easily light up even when there is no ground fault if the disconnect slide is open. This has no impact on functionality and does not affect the protective measure demanded in the VDE requirements

Attention!

- During isolation testing in accordance with EN 60204-1/VDE 0113-1, the GTF 76 should be disconnected or bridged as otherwise the LED display will be destroyed or a short circuit will occur

Notes:
1) 250 V for GTF 76/230

Dimensions	[mm]	22.5	64.5	54
Dimensions	[mm]	22.5	64.5	59
Maximum electrical data		I_{max} [A]	U_{max} [V]	max. \varnothing [mm ²] AWG (UL)
		57	110 ¹⁾	0.5 - 10 26-8
Rated data		Rated voltage [V]	110 ¹⁾	250 - - -
		Nominal current / cross section [A] / [mm ²]	41 / 6	50 / - - -
		Rated cross section [mm ²]	6	- - -
		Cross section range AWG	20 - 8	26-8 - -
Connection capacity		1 conductor [mm ²]	0.5 - 10	0.5 - 6 0.5 - 6 0.5 - 4
		2 conductors (of the same type) [mm ²]	0.5 - 6	0.5 - 6 0.5 - 4 -
		2 flexible conductors with a TWIN ferrule [mm ²]	-	- 0.5 - 4
General data		Stripping length [mm]	12	
		Screw thread	M4	
		Tightening torque [Nm]	1.2 - 1.5	
		Insulating material	PA	
		Flammability rating in accordance with UL 94	V0	



Technical data				
Width	Length	Height NS 35/7,5		
22.5	64.5	54		
Width	Length	Height NS 32		
22.5	64.5	59		
I_{max} [A]	U_{max} [V]	max. \varnothing [mm ²]	AWG (UL)	
57	110 ¹⁾	0.5 - 10	26-8	
IEC	UL / CUL	CSA	IEC/ EN 60079-7	
110 ¹⁾	250	-	-	
41 / 6	50 / -	-	-	
6	-	-	-	
20 - 8	26-8	-	-	
Connection capacity	Rigid	Flexible	Ferrule	
			without/with plastic sleeve	
1 conductor [mm ²]	0.5 - 10	0.5 - 6	0.5 - 6	0.5 - 4
2 conductors (of the same type) [mm ²]	0.5 - 6	0.5 - 6	0.5 - 4	-
2 flexible conductors with a TWIN ferrule [mm ²]	-	-	-	0.5 - 4
General data	Stripping length [mm]	12		
	Screw thread	M4		
	Tightening torque [Nm]	1.2 - 1.5		
	Insulating material	PA		
	Flammability rating in accordance with UL 94	V0		

Description	Color
Basic disconnect terminal block , for mounting on NS 32..., NS 35... or NS 35/15-2,3 for 110 - 250 V AC/DC, current: 0.5 - 1 mA	gray
Basic disconnect terminal block , for mounting on NS 32..., NS 35... or NS 35/15-2,3 for 24 - 48 V AC/DC, current: 3.5 - 8 mA	gray

Ordering data		
Type	Order No.	Pcs./Pkt.
GTF 76/230	3121012	10
GTF 76/ 48	3121025	10

Screwdriver
SZS 1,0X4,0 VDE

Accessories		
SZS 1,0X4,0 VDE	1205066	10
ZB 10 (see Catalog 3)		

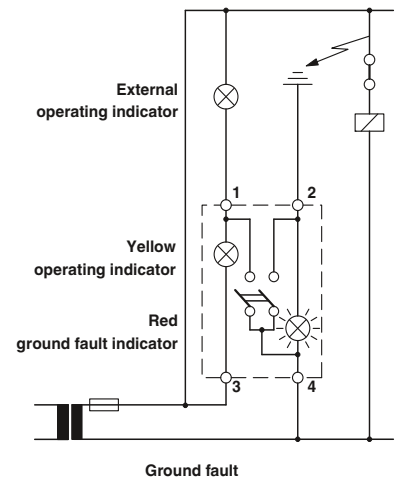
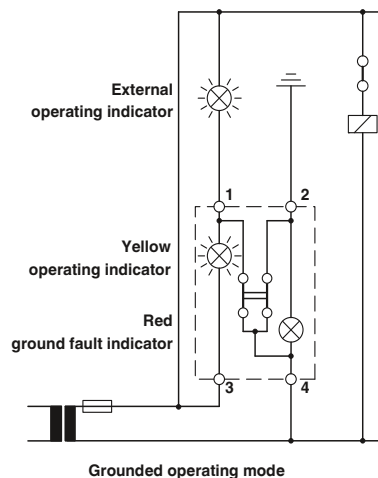

Terminal blocks – Classic

UK universal terminal blocks with special connection

Feed-through terminal blocks with flat plug connection UVKB ... and UHK ...



UVKB terminal blocks

- The front flat plug connection is the optimum wiring design for tight spaces and if cable ducts need moving close to the terminal strip
- The housing walls only protrude slightly beyond the metal parts because it is assumed that fully-isolated plug-in sleeves are connected
- The slotted plugs allow a fully isolated or two bare 2.8 mm plug-in sleeves to be slid on in place of one 6.3 mm flat plug-in sleeve

UHK terminal blocks

- Owing to the characteristic arrangement of three flat connectors on each terminal block side, UHK... terminal blocks prove to be advantageous in technical applications:
- Economical use of terminal blocks and bridge connections
 - Comfortable operation, i. e., free view of the connectors, good connector accessibility and quick connection check
 - The marking is easily visible due to the smart wire guiding in the lateral cable ducts
 - Reading the marking from the front

Notes:
For corresponding slip-on sleeves, see catalog 3.
¹⁾ Current and voltage data for slip-on connections in acc. with EN 61210 are also dependent on nominal size, material, insulation of the receptacle and conductor cross section.



4 (4) mm², 29 A, feed-through terminal block, with screw and slip-on connection



Dimensions		[mm]
Dimensions		[mm]
Maximum electrical data		
Rated data		
Rated voltage	[V]	500 ¹⁾
Nominal current / cross section	[A] / [mm ²]	29 / 4
Rated cross section	[mm ²]	4
Cross section range	AWG	24 - 12
Connection capacity screw connection		
1 conductor	[mm ²]	0.2 - 4
2 conductors (of the same type)	[mm ²]	0.2 - 1.5
2 flexible conductors with a TWIN ferrule	[mm ²]	-
Max. cross section with insertion bridge	[mm ²]	4
General data		
Stripping length	[mm]	8
Screw thread		M3
Tightening torque	[Nm]	0.6 - 0.8
Insulating material		PA
Flammability rating in accordance with UL 94		V2

Technical data				
Width	Length	Height NS 35/7,5		
6.2	68	44		
Width	Length	Height NS 32		
6.2	68	49		
I _{max} [A]	U _{max} [V]	max. Ø [mm ²]	AWG (UL)	
29 ¹⁾	500 ¹⁾	0.2 - 4	28-12	
IEC	UL / CUL	CSA	IEC/ EN 60079-7	
500 ¹⁾	300	-	-	
29 / 4	25 / -	-	-	
4	-	-	-	
24 - 12	28-12	-	-	
Connection capacity screw connection		Rigid	Flexible	Ferrule
				without/with plastic sleeve
1 conductor	[mm ²]	0.2 - 4	0.2 - 4	0.25 - 4 0.25 - 2.5
2 conductors (of the same type)	[mm ²]	0.2 - 1.5	0.2 - 1.5	0.25 - 1.5 -
2 flexible conductors with a TWIN ferrule	[mm ²]	-	-	- 0.5 - 2.5
Max. cross section with insertion bridge	[mm ²]	4	4	- -

Description	No. of pos.	Color
Terminal block, for mounting on NS 32... or NS 35..., with slotted 6.3/2.8 mm flat connectors ¹⁾		gray

Ordering data			
Type	I _{max}	Order No.	Pcs./Pkt.
UVKB 4-FS(6-2,8-0,8)		1954016	50

Accessories		
Cover, width: 2.2 mm		gray
Cover, width: 2.3 mm		gray
Fixed bridge, isolated	10	silver
Insertion bridge, insulated		
	2	gray
	3	gray
	10	gray
Isolator bridge bar, divisible, with 10 screws, for switchable branches with IS-K...	10	silver
Bridge bar isolator, as distance piece for isolator bridge bar		gray
Separating disk, for separation of neighboring bridges, can be fitted later, no loss of pitch		gray
Partition plate, for visual and electrical separation of terminal groups, 2.3 mm thick		gray
Test socket		silver
Test socket, insulated, can be used only with FBI and ISSBI		silver
Screwdriver		
Center groove labeling		

Accessories		
D-UVKB 4		
FBI 10- 6	24 A	0203250 10
EB 2- 6	24 A	0201155 100
EB 3- 6	24 A	0201142 100
EB 10- 6	24 A	0201139 10
ISSBI 10- 6	24 A	0301505 10
IS-K 4		1302338 100
TS-K		1302215 50
PSB 3/10/4		0601292 10
PSBJ 3/13/4		0201304 10
SF-SL 0,6X3,5-100 S-VDE		1212587 10
ZB 6 (see Catalog 3)		

UK universal terminal blocks with special connection



6 (6) mm², 32 A, feed-through terminal block, with spade connection



4 (4) mm², 40 A, feed-through terminal block, with screw and slip-on connection



6 (6) mm², 40 A, feed-through terminal block, with spade connection



Technical data			
Width	Length	Height NS 35/7,5	
6.2	68	44	
Width	Length	Height NS 32	
6.2	68	49	
I _{max} [A]	U _{max} [V]	max. Ø [mm ²]	AWG (UL)
32 ¹⁾	800 ¹⁾	0.5 - 6	-
IEC	UL / CUL	CSA	IEC/ EN 60079-7
800 ¹⁾	300	-	-
32 ¹⁾ / 4	25 / -	-	-
4	-	-	-
20 - 10	-	-	-
Rigid	Flexible	Ferrule without/with plastic sleeve	
0.5 - 6	0.5 - 6	-	0.5 - 6
-	-	-	-
-	-	-	-
-	-	-	-
PA			
V2			

Technical data			
Width	Length	Height NS 35/7,5	
6.2	54	51.5	
Width	Length	Height NS 32	
6.2	54	56.5	
I _{max} [A]	U _{max} [V]	max. Ø [mm ²]	AWG (UL)
40 ¹⁾	800 ¹⁾	0.2 - 4	28-12
IEC	UL / CUL	CSA	IEC/ EN 60079-7
800 ¹⁾	250	600	-
32 ¹⁾ / 4	25 / -	20 / -	-
4	-	-	-
24 - 12	28-12	28-14	-
Rigid	Flexible	Ferrule without/with plastic sleeve	
0.2 - 4	0.2 - 4	0.25 - 4	0.25 - 2.5
0.2 - 1.5	0.2 - 1.5	0.25 - 1.5	-
-	-	-	0.5 - 2.5
4	4	-	-
9			
M3			
0.6 - 0.8			
PA			
V2			

Technical data			
Width	Length	Height NS 35/7,5	
6.2	54	51.5	
Width	Length	Height NS 32	
6.2	54	56.5	
I _{max} [A]	U _{max} [V]	max. Ø [mm ²]	AWG (UL)
40 ¹⁾	800 ¹⁾	0.5 - 6	-
IEC	UL / CUL	CSA	IEC/ EN 60079-7
800 ¹⁾	250	600	-
40 ¹⁾ / -	25 / -	20 / -	-
-	-	-	-
20 - 10	-	22-14	-
Rigid	Flexible	Ferrule without/with plastic sleeve	
0.5 - 6	0.5 - 6	-	0.5 - 6
-	-	-	-
-	-	-	-
-	-	-	-
PA			
V2			

Ordering data			
Type	I _{max}	Order No.	Pcs./Pkt.
UVKB 4-FS/FS(8-2,8-0,8)		1953017	50

Ordering data			
Type	I _{max}	Order No.	Pcs./Pkt.
UHK 4-FS(8-2,8-0,8)		2017237	50

Ordering data			
Type	I _{max}	Order No.	Pcs./Pkt.
UHK 4-FS/FS(12-2,8-0,8)		2017224	50

Accessories			
D-UVKB 4		1920024	50
FBI 10- 6	24 A	0203250	10
ISSBI 10- 6	24 A	0301505	10
IS-K 4		1302338	100
TS-K		1302215	50
PSB 3/10/4		0601292	10
PSBJ 3/13/4		0201304	10

Accessories			
D-HK 4		2002022	50
EB 2- 6	30 A	0201155	100
EB 3- 6	30 A	0201142	100
EB 10- 6	30 A	0201139	10
D-UVK 4		1922022	50
SF-SL 0,6X3,5-100 S-VDE		1212587	10

Accessories			
D-HK 4		2002022	50
D-UVK 4		1922022	50

ZB 6 (see Catalog 3)

ZB 6 (see Catalog 3)

ZB 6 (see Catalog 3)

Terminal blocks – Classic

UK universal terminal blocks with special connection

Feed-through terminal blocks with flat plug connection VBST ... and PVB ...

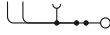

2.5 (4) mm², 32 A, feed-through terminal block, with screw and slip-on connection



6 (6) mm², 30 A, equipotential bonder terminal block with spade connection

Notes:
1) Current and voltage data for slip-on connections in acc. with EN 61210 are also dependent on nominal size, material, insulation of the receptacle and conductor cross section.
2) Nominal current of the module connector per position: 13 A



Dimensions	
	[mm]
Maximum electrical data	
Rated data	
Rated voltage	[V]
Nominal current / cross section	[A] / [mm ²]
Rated cross section	[mm ²]
Cross section range	AWG
Connection capacity screw connection	
1 conductor	[mm ²]
2 conductors (of the same type)	[mm ²]
2 flexible conductors with a TWIN ferrule	[mm ²]
Max. cross section with insertion bridge	[mm ²]
General data	
Stripping length	[mm]
Screw thread	
Tightening torque	[Nm]
Insulating material	
Flammability rating in accordance with UL 94	

Technical data				
Width	Length	Height NS 35/7,5		
6.2	72	39.5		
I _{max} [A]	U _{max} [V]	max. Ø [mm ²]	AWG (UL)	
32 ²⁾	800 ¹⁾	0.2 - 4	30-10	
IEC	UL / CUL	CSA	IEC/ EN 60079-7	
800 ¹⁾	300	600	-	
24 / 2.5	20 / -	20 / -	-	
4	-	-	-	
24 - 12	30-10	30-10	-	
Rigid	Flexible	Ferrule without/with plastic sleeve		
0.2 - 4	0.2 - 2.5	0.25 - 4	0.25 - 2.5	
0.2 - 1.5	0.2 - 1.5	0.25 - 1	-	
-	-	-	0.5 - 1.5	
2.5	2.5	-	-	
Ordering data				
Type	I _{max}	Order No.	Pcs./Pkt.	
VBSTB 4-FS (6-2,8-0,8)		3070435	50	
VBST 4-FS (6-2,8-0,8)		0852012	50	

Technical data				
Width	Length	Height NS 35/7,5		
23.2	80	43.5		
I _{max} [A]	U _{max} [V]	max. Ø [mm ²]	AWG (UL)	
30	800 ¹⁾	0.5 - 6	-	
IEC	UL / CUL	CSA	IEC/ EN 60079-7	
800 ¹⁾	-	-	-	
30 / -	-	-	-	
-	-	-	-	
20 - 10	-	-	-	
Rigid	Flexible	Ferrule without/with plastic sleeve		
0.5 - 6	0.5 - 6	-	0.5 - 6	
-	-	-	-	
-	-	-	-	
-	-	-	-	
PA	PA	-		
V0	V2	-		
Ordering data				
Type	I _{max}	Order No.	Pcs./Pkt.	
PVB 3		0870036	10	

Description	No. of pos.	Color
Terminal block, for mounting on NS 35..., with two slotted 6.3/2.8 mm flat plugs and double function shaft for FBS ...6 plug-in bridges		gray
Terminal block, for mounting on NS 35..., with three slotted 6.3/2.8 mm flat connectors		gray
Equipotential bonder, for mounting on NS 35..., with slotted 6.3/2.8 mm flat connectors, 12 slots, terminal width: 23.2 mm		gray

Accessories				
D-TP-VBS		0851026	50	
EB 2- 6	24 A	0201155	100	
EB 3- 6	24 A	0201142	100	
EB 10- 6	24 A	0201139	10	
SF-SL 0,6X3,5-100 S-VDE		1212587	10	
ZB 6 (see Catalog 3)				

Accessories				
ZB 6 (see Catalog 3)				

Cover and partition plate, width: 2.2 mm		gray
Insertion bridge, insulated		
	2	gray
	3	gray
	10	gray
Screwdriver		
Center groove labeling		

ZB 6 (see Catalog 3)				
----------------------	--	--	--	--

ZB 6 (see Catalog 3)				
----------------------	--	--	--	--

Feed-through terminal blocks with flat plug connection USK ...

Notes:
 1) Current and voltage data for slip-on connections in acc. with EN 61210 are also dependent on nominal size, material, insulation of the receptacle and conductor cross section.
 For corresponding slip-on sleeves, see catalog 3.



4 (4) mm², 32 A, feed-through terminal block, with screw and slip-on connection



6 (6) mm², 32 A, feed-through terminal block, with spade connection



Technical data				
Width	Length	Height NS 35/7,5		
6.2	42.5	45.5		
Width	Length	Height NS 32		
6.2	42.5	50.5		
I_{max} [A]	U_{max} [V]	max. Ø [mm ²]	AWG (UL)	
32 ¹⁾	800 ¹⁾	0.2 - 4	28-12	
IEC	UL / CUL	CSA	IEC/ EN 60079-7	
800 ¹⁾	600	600	-	
Nominal current / cross section [A] / [mm ²]	32 ¹⁾ / 4	20 / -	20 / -	-
Rated cross section [mm ²]	4	-	-	-
Cross section range AWG	24 - 12	28-12	28-12	-
Connection capacity	Rigid	Flexible	Ferrule without/with plastic sleeve	
	1 conductor [mm ²]	0.2 - 4	0.2 - 4	0.25 - 4 / 0.25 - 2.5
	2 conductors (of the same type) [mm ²]	0.2 - 1	0.2 - 1.5	0.25 - 1.5 / -
	2 flexible conductors with a TWIN ferrule [mm ²]	-	-	- / 0.5 - 2.5
	Max. cross section with insertion bridge [mm ²]	2.5	2.5	-
General data				
Stripping length [mm]	9			
Screw thread	M3			
Tightening torque [Nm]	0.6 - 0.8			
Insulating material	PA			
Flammability rating in accordance with UL 94	V2			

Ordering data			
Type	I_{max}	Order No.	Pcs./Pkt.
USK 4-FSR(4-2,8-0,8)		0270018	50

Accessories			
D-USK 4/10		0260028	50
EB 2- 6	24 A	0201155	100
EB 3- 6	24 A	0201142	100
EB 10- 6	24 A	0201139	10
SF-SL 0,6X3,5-100 S-VDE		1212587	10

ZB 6 (see Catalog 3)



Technical data				
Width	Length	Height NS 35/7,5		
6.2	42.5	45.5		
Width	Length	Height NS 32		
6.2	42.5	50.5		
I_{max} [A]	U_{max} [V]	max. Ø [mm ²]	AWG (UL)	
32 ¹⁾	800 ¹⁾	0.5 - 6	-	
IEC	UL / CUL	CSA	IEC/ EN 60079-7	
800 ¹⁾	600	600	-	
Nominal current / cross section [A] / [mm ²]	32 ¹⁾ / 4	20 / -	20 / -	-
Rated cross section [mm ²]	4	-	-	-
Cross section range AWG	20 - 10	-	-	-
Connection capacity	Rigid	Flexible	Ferrule without/with plastic sleeve	
	0.5 - 6	0.5 - 6	-	0.5 - 6
	-	-	-	-
	-	-	-	-
	-	-	-	-
General data				
Stripping length [mm]	-			
Screw thread	M3			
Tightening torque [Nm]	-			
Insulating material	PA			
Flammability rating in accordance with UL 94	V2			

Ordering data		
Type	Order No.	Pcs./Pkt.
USK 4-FS/FS(8-2,8-0,8)	0271017	50

Accessories		
D-USK 4/10		0260028

ZB 6 (see Catalog 3)

Description	No. of pos.	Color
Terminal block, for mounting on NS 32... or NS 35...		gray
Terminal block, for mounting on NS 32... or NS 35..., with slotted 6.3/2.8 mm flat connectors		gray

Accessories	No. of pos.	Color
Cover, width: 1.3 mm		gray
Insertion bridge, insulated	2	gray
	3	gray
	10	gray
Screwdriver		

Center groove labeling

UK universal terminal blocks with special connection

Double-level terminal blocks with screw/flat plug connection UKK ...

Notes:
Important note: The notched partition plate must be removed to bridge the terminal blocks.
For corresponding slip-on sleeves, see catalog 3.
1) Current and voltage data for slip-on connections in acc. with EN 61210 are also dependent on nominal size, material, insulation of the receptacle and conductor cross section.



4 (4) mm², 20 A, double-level terminal block with screw and slip-on connection



Dimensions	
	[mm]
Dimensions	
	[mm]
Maximum electrical data	
Rated data	
Rated voltage	[V]
Nominal current / cross section	[A] / [mm ²]
Rated cross section	[mm ²]
Cross section range	AWG
Connection capacity	
1 conductor	[mm ²]
2 conductors (of the same type)	[mm ²]
2 flexible conductors with a TWIN ferrule	[mm ²]
Max. cross section with insertion bridge	[mm ²]
General data	
Stripping length	[mm]
Screw thread	
Tightening torque	[Nm]
Insulating material	
Flammability rating in accordance with UL 94	

Technical data			
Width	Length	Height NS 35/7,5	
6.2	72	59	
Width	Length	Height NS 32	
6.2	72	64	
I _{max} [A]	U _{max} [V]	max. Ø [mm ²]	AWG (UL)
20 ¹⁾	400 ¹⁾	0.2 - 4	30-10
IEC	UL / CUL	CSA	IEC/ EN 60079-7
400 ¹⁾	300	-	-
20 ¹⁾ / 4	20 / -	-	-
4	-	-	-
24 - 12	30-10	-	-
Rigid	Flexible	Ferrule	
		without/with plastic sleeve	
0.2 - 4	0.2 - 4	0.25 - 4	0.25 - 2.5
0.2 - 1	0.2 - 1.5	0.25 - 1.5	-
-	-	-	0.5 - 1.5
4	2.5	-	-
8			
M3			
0.6 - 0.8			
PA			
V2			

Description	No. of pos.	Color
Double-level terminal block , with disconnect knife, for mounting on NS 32... or NS 35..., with screw connection and slotted 6.3/2.8 mm flat connectors		gray
Double-level terminal block , with disconnect knife, for mounting on NS 32... or NS 35..., with slotted 6.3/2.8 mm flat connectors on both sides		gray

Ordering data			
Type	I _{max}	Order No.	Pcs./Pkt.
UKK 4-FS		2770561	50

Cover , width: 1.5 mm		gray
Fixed bridge , isolated	10	silver
Insertion bridge , insulated	2	gray
	3	gray
	10	gray
	10	gray
Isolator bridge bar , divisible, with 10 screws, for switchable branches with IS-K...	10	silver
Bridge bar isolator , as distance piece for isolator bridge bar		gray
Test socket		silver
Test socket , insulated, can be used only with FBI and ISSBI		silver
Screwdriver		
Lateral groove labeling		

Accessories			
Type	I _{max}	Order No.	Pcs./Pkt.
D-UKK 4		2770558	50
FBI 10- 6	20 A	0203250	10
EB 2- 6	20 A	0201155	100
EB 3- 6	20 A	0201142	100
EB 10- 6	20 A	0201139	10
ISSBI 10- 6	20 A	0301505	10
IS-K 4		1302338	100
PSB 3/10/4		0601292	10
PSBJ 3/13/4		0201304	10
SF-SL 0,6X3,5-100 S-VDE		1212587	10
ZB 6 (see Catalog 3)			

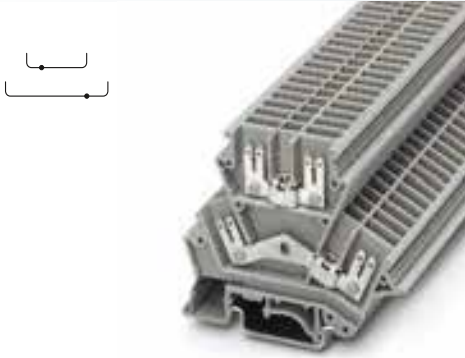

6 (6) mm², 20 A, double-level terminal block with spade connection

ERC 

Technical data

Width	Length	Height NS 35/7,5	
6.2	72	59	
Width	Length	Height NS 32	
6.2	72	64	
I_{max} [A]	U_{max} [V]	max. Ø [mm ²]	AWG (UL)
20 ¹⁾	400 ¹⁾	0.5 - 6	-
IEC	UL / CUL	CSA	IEC/ EN 60079-7
400 ¹⁾	300	-	-
20 ¹⁾ / 4	20 / -	-	-
4	-	-	-
20 - 10	-	-	-
Rigid	Flexible	Ferrule without/with plastic sleeve	
0.5 - 6	0.5 - 6	-	0.5 - 6
-	-	-	-
-	-	-	-
-	-	-	-

-
-
-
PA
V0

Ordering data

Type	I_{max}	Order No.	Pcs./Pkt.
UKK 4-FS/FS		2771133	50

Accessories

D-UKK 4		2770558	50
FBI 10- 6	20 A	0203250	10
ISSBI 10- 6	20 A	0301505	10
IS-K 4		1302338	100
PSB 3/10/4		0601292	10
PSBJ 3/13/4		0201304	10

ZB 6 (see Catalog 3)

Terminal blocks – Classic

SSK high-temperature terminal blocks

Ceramic terminal blocks SSK

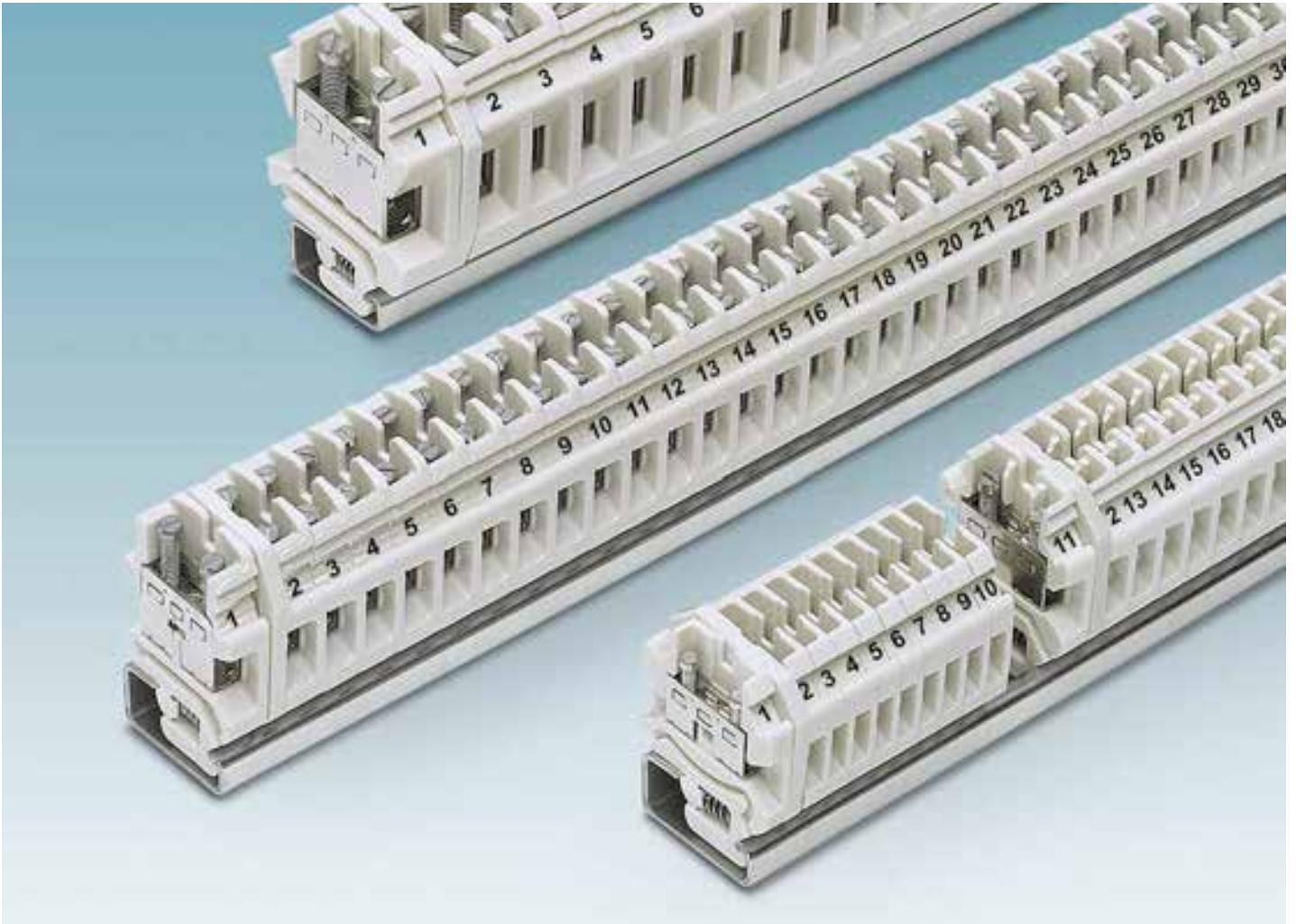

i Your web code: #1403



Safe in all applications

The SSK modular terminal blocks with ceramic isolation approved as standard for areas at risk of explosion are recommended for use anywhere with tough operating conditions, especially in terms of temperature and chemical aggressiveness.



For high-temperature applications

One of the key features of the ceramic terminal blocks is that they can be used continuously at high temperatures of up to 220°C. They are recommended for sites with high thermal requirements and extreme changes in temperature.



Compact design

Given the space-saving design, SSK ceramic terminal blocks are ideally suited to control systems in tight spaces.

Ceramic feed-through terminal blocks SSK ...

- Compact design
- Mounting on G DIN rail NS 32
- Secure snapping into place using snap lock in terminal block foot
- Simple potential distribution, thanks to chain bridging

Notes:

1) For information on installation and using accessories for Ex applications, see page 678.



4 (4) mm², 32 A, feed-through terminal block



Ex: EAC Ex IEC Ex
KIWA 17ATEX0022 U / IECEx KIWA17.0009U

Technical data

Dimensions		Width	Length	Height NS 32	
		6.2	38	48	
Maximum electrical data		I_{max} [A]	U_{max} [V]	max. \varnothing [mm ²]	AWG (UL)
		32	690	0.2 - 4	-
Rated data		IEC 60947-7-1		Ex	
		IEC	UL / CUL	CSA	IEC/EN 60079-7
Rated voltage		[V]	690	-	600
Nominal current / cross section		[A] / [mm ²]	24 / 2.5	-	20 / -
Rated cross section		[mm ²]	2.5	-	28 / 4
Cross section range		AWG	24 - 12	-	22-12
Connection capacity screw connection			Rigid	Flexible	Ferrule without/with plastic sleeve
1 conductor		[mm ²]	0.2 - 4	0.2 - 4	0.25 - 2.5 / 0.25 - 1.5
2 conductors (of the same type)		[mm ²]	0.2 - 1.5	0.2 - 1.5	0.25 - 1.5 / -
2 flexible conductors with a TWIN ferrule		[mm ²]	-	-	- / 0.5 - 1.5
General data					
Stripping length		[mm]	9		
Screw thread			M3		
Tightening torque		[Nm]	0.5 - 0.6		
Material			Ceramics		

Ordering data

Description	No. of pos.	Color	Type	I_{max}	Order No.	Pcs./Pkt.
Terminal block, for mounting on NS 32...		ivory	SSK 0525 KER-EX		0501059	50

Accessories¹⁾

Description	No. of pos.	Color	Type	I_{max}	Order No.	Pcs./Pkt.
Cover, 4 mm width		white	D-SSK 0525 KER		0201061	50
Chain bridge, with screw	1	silver	KB- 6	34 A	0201472	100
End clamp, for DIN rail NS 32		silver	E/1		1201044	100
Screwdriver			SF-SL 0,6X3,5-100 S-VDE		1212587	10
Lateral groove labeling			ZB 6 (see Catalog 3)			

SSK high-temperature terminal blocks

Ceramic feed-through terminal blocks SSK ...

- Compact design
- Mounting on G DIN rail NS 32
- Secure snapping into place using snap lock in terminal block foot
- Simple potential distribution, thanks to chain bridging

Notes:
 1) For information on installation and using accessories for Ex applications, see page 678.



6 (10) mm², 57 A, feed-through terminal block



Ex: EAC Ex IEC RoHS (U)
 KIWA 17ATEX0022 U / IECEx KIWA17.0009U

Dimensions		[mm]	
Maximum electrical data			
Rated data			
Rated voltage	[V]	800	-
Nominal current / cross section	[A] / [mm ²]	41 / 6	-
Rated cross section	[mm ²]	6	-
Cross section range	AWG	20 - 8	-
Connection capacity screw connection			
1 conductor	[mm ²]	0.5 - 10	0.5 - 6
2 conductors (of the same type)	[mm ²]	0.5 - 2.5	0.5 - 2.5
2 flexible conductors with a TWIN ferrule	[mm ²]	-	-
General data			
Stripping length	[mm]	10	
Screw thread		M4	
Tightening torque	[Nm]	1.5 - 1.8	
Material		Ceramics	

Technical data				
Width	Length	Height NS 32		
8.4	38	51		
I _{max} [A]	U _{max} [V]	max. Ø [mm ²]	AWG (UL)	
57	800	0.5 - 10	-	
IEC 60947-7-1				
IEC	UL / CUL	CSA	IEC/EN 60079-7	
800	-	600	440	
41 / 6	-	55 / -	36.5 / 6	
6	-	-	0.5-6	
20 - 8	-	26-8	20 - 8	
Connection capacity screw connection		Rigid	Flexible	Ferrule
		without/with plastic sleeve		
1 conductor	[mm ²]	0.5 - 10	0.5 - 6	0.5 - 6 0.5 - 4
2 conductors (of the same type)	[mm ²]	0.5 - 2.5	0.5 - 2.5	0.5 - 2.5 -
2 flexible conductors with a TWIN ferrule	[mm ²]	-	-	- 0.5 - 2.5

Description	No. of pos.	Color
Terminal block , for mounting on NS 32...		ivory
Cover , 4 mm width		white
Chain bridge , with screw		
	1	silver
End clamp , for DIN rail NS 32		silver
Screwdriver		
Lateral groove labeling		

Ordering data			
Type	I _{max}	Order No.	Pcs./Pkt.
SSK 110 KER-EX		0502058	50

Accessories ¹⁾			
D-SSK 110 KER		0202060	50
KB- 8	43 A	0202206	100
E/1		1201044	100
SF-SL 0,6X3,5-100 S-VDE		1212587	10
ZB 8 (see Catalog 3)			

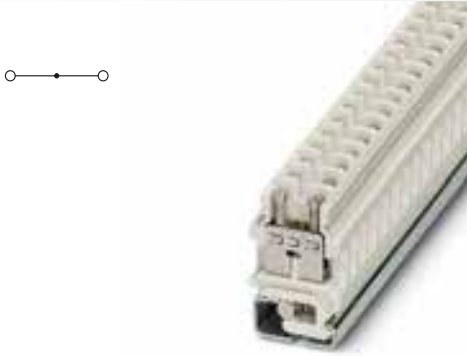
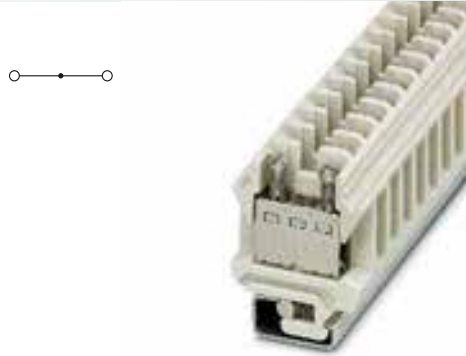
10 (16) mm², 76 A, feed-through terminal block25 (35) mm², 125 A, feed-through terminal block

Ex: EAC Ex IEC Ex UL
KIWA 17ATEX0022 U / IECEx KIWA17.0009U

Ex: EAC Ex IEC Ex UL
KIWA 17ATEX0022 U / IECEx KIWA17.0009U

Technical data			
Width	Length	Height NS 32	
10.4	38	55	
I _{max} [A]	U _{max} [V]	max. Ø [mm ²]	AWG (UL)
76	630	0.5 - 16	-
IEC 60947-7-1			
IEC	UL / CUL	CSA	IEC/ EN 60079-7
630	-	600	440
57 / 10	-	80 / -	55 / 10
10	-	-	0.5-10
20 - 6	-	24-6	20 - 6
Rigid	Flexible	Ferrule	
		without/with plastic sleeve	
0.5 - 16	0.5 - 10	0.5 - 10	0.5 - 6
0.5 - 4	0.5 - 4	0.5 - 4	-
-	-	-	0.5 - 6
11			
M4			
1.5 - 1.8			
Ceramics			

Technical data			
Width	Length	Height NS 32	
15.3	53	67	
I _{max} [A]	U _{max} [V]	max. Ø [mm ²]	AWG (UL)
125	800	1 - 35	-
IEC 60947-7-1			
IEC	UL / CUL	CSA	IEC/ EN 60079-7
800	-	600	550
101 / 35	-	140 / -	101 / 25
35	-	-	1-25
18 - 2	-	14-2	18 - 2
Rigid	Flexible	Ferrule	
		without/with plastic sleeve	
1 - 35	1 - 25	0.75 - 25	0.75 - 16
0.75 - 10	0.75 - 10	0.75 - 10	-
-	-	-	0.75 - 10
16			
M6			
3.2 - 3.7			
Ceramics			

Ordering data			
Type	I _{max}	Order No.	Pcs./Pkt.
SSK 116 KER-EX		0503057	50

Ordering data			
Type	I _{max}	Order No.	Pcs./Pkt.
SSK 135 KER-EX		0505055	10

Accessories ¹⁾			
D-SSK 116 KER		0203069	50
KB- 10	57 A	0203205	100
E/1		1201044	100
SZS 1,0X4,0 VDE		1205066	10

Accessories ¹⁾			
D-SSK 135 KER		0205067	50
KBI- 15	108 A	0205203	10
E/1		1201044	100
SZS 1,0X4,0 VDE		1205066	10

ZB 10 (see Catalog 3)

ZB 15 (see Catalog 3)

Terminal blocks – Classic

USST spring-assisted screw terminal blocks

Spring-assisted screw terminal blocks USST ...

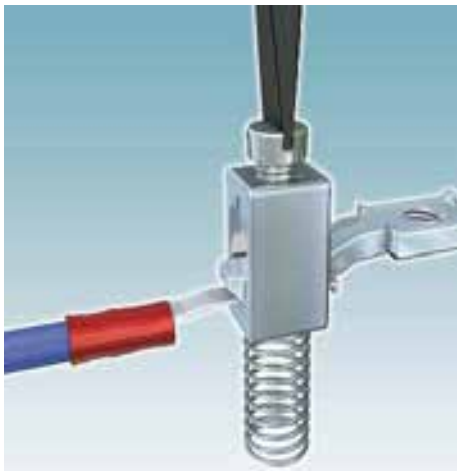

Spring-assisted screw connection

The opened terminal block body is pressed down to make contact with the conductor. Tightening the terminal screw produces the perfect electric connection.



Hooked cable lug

This cable lug is shaped like a hook, allowing it to lock in the spring in the terminal block body for a secure connection.



Test accessories

The familiar test, switching, and bridging accessories from Phoenix Contact are used in the USST modular terminal blocks.

Spring-assisted feed-through terminal blocks USST 4

- The modular terminal blocks USST ... were developed especially for use in the energy supply sector
- When combined with hook-type cable lugs, the spring-assisted screw terminal blocks optimally meet the technical requirements of ENATS 50-18
- Universal foot for mounting on NS 32 and or NS 35 DIN rails
- The bridge bar isolator switching bridges ISSBI ... enable switchable cross connections with IS-K The screw functions as a current-carrying switching element
- Large-surface marking options of every terminal point

Space-saving conductor connection

The flat-ribbon cable lugs with C-BCI ... SO hooks enable vertical crimping (see figure below), which means that conductors in the nominal cross-section can be wired without loss of pitch in a way that saves space. Further information about flat-ribbon cable lugs with hooks can be found at phoenixcontact.net/products.

Notes:
Corresponding flat-ribbon cable lugs with C-BCI ... hooks can be found in Catalog 3 or at phoenixcontact.net/products



4 (6) mm², 41 A, feed-through terminal block



Dimensions		Width		Length		Height NS 35/7,5	
Dimensions [mm]		6.2		59.6		51	
Dimensions [mm]		6.2		59.6		56	
Maximum electrical data		I_{max} [A]	U_{max} [V]	max. Ø [mm ²]		AWG (UL)	
Rated data		41	1000	0.2 - 6		24-10	
Rated voltage		IEC 60947-7-1		UL / CUL		CSA	
Nominal current / cross section		IEC		UL / CUL		IEC/EN 60079-7	
Rated cross section		1000	600	600	-	-	-
Cross section range		32 / 4	30 / -	30 / -	-	-	-
Connection capacity		4	-	-	-	-	-
1 conductor		24 - 10	24-10	24-10	-	-	-
2 conductors (of the same type)		Rigid	Flexible	Ferrule		without/with plastic sleeve	
2 flexible conductors with a TWIN ferrule		0.2 - 6	0.2 - 4	0.25 - 4	0.25 - 2.5	-	-
General data		0.2 - 1.5	0.2 - 1.5	0.25 - 1.5	-	-	0.5 - 2.5
Stripping length		-		-	-	-	-
Screw thread		10		M3		0.6 - 0.8	
Tightening torque		[mm]		[Nm]		PA	
Insulating material		V0		V0		V0	
Flammability rating in accordance with UL 94		-		-		-	

Description	No. of pos.	Color
Terminal block, for mounting on NS 32... or NS 35...		gray

Cover, width: 2.2 mm		gray
Partition plate, 2 mm wide		gray
Fixed bridge, isolated	10	silver
Isolator bridge bar, divisible, with 10 screws, for switchable branches with IS-K...	10	silver
Bridge bar isolator, as distance piece for isolator bridge bar		gray
Separating disk, for separation of neighboring bridges, can be fitted later, no loss of pitch		gray
Test socket		silver
Test socket, insulated, can be used only with FBI and ISSBI		silver
Screwdriver		
Lateral groove labeling		

Ordering data			
Type	I_{max}	Order No.	Pcs./Pkt.
USST 4		3070338	50

Accessories			
Type	I_{max}	Order No.	Pcs./Pkt.
D-USST 4/10		3070370	50
TPNS-UK		0706647	50
FBI 10- 6	38 A	0203250	10
ISSBI 10- 6	30 A	0301505	10
IS-K 4		1302338	100
TS-USST 4/10		3070383	50
PSB 3/10/4		0601292	10
PSBJ 3/13/4		0201304	10
SF-SL 0,6X3,5-100 S-VDE		1212587	10
UC-TM 6, UCT-TM 6 or ZB 6 (see Catalog 3)			



Terminal blocks – Classic

USST spring-assisted screw terminal blocks

Spring-assisted feed-through terminal blocks USST 6 and USST 10

– Terminal blocks USST 4 to USST 10 are of the same shape

Notes:
For other test sockets, see page 587.

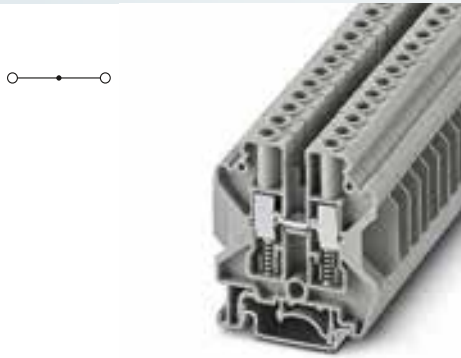

6 (10) mm², 57 A, feed-through terminal block

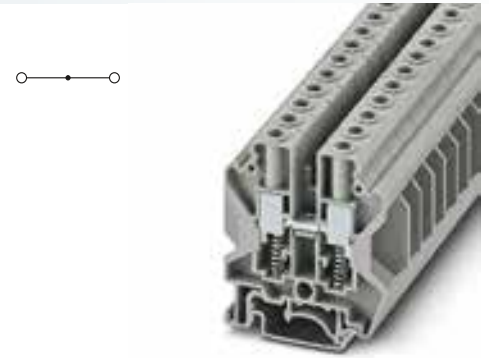

10 (16) mm², 76 A, feed-through terminal block



		Technical data			
Dimensions		Width	Length	Height NS 35/7,5	
	[mm]	8.2	59.6	51	
Dimensions		Width	Length	Height NS 32	
	[mm]	8.2	59.6	56	
Maximum electrical data		I_{max} [A]	U_{max} [V]	max. Ø [mm ²]	AWG (UL)
		57	1000	0.2 - 10	24-10
Rated data		IEC 60947-7-1		IEC/EN 60079-7	
		IEC	UL / CUL	CSA	IEC/EN 60079-7
Rated voltage	[V]	1000	600	600	-
Nominal current / cross section	[A] / [mm ²]	41 / 6	30 / -	30 / -	-
Rated cross section	[mm ²]	6	-	-	-
Cross section range	AWG	24 - 8	24-10	24-10	-
Connection capacity		Rigid	Flexible	Ferrule without/with plastic sleeve	
1 conductor	[mm ²]	0.2 - 10	0.2 - 6	0.25 - 6	0.25 - 6
2 conductors (of the same type)	[mm ²]	0.2 - 2.5	0.2 - 2.5	0.25 - 1.5	-
2 flexible conductors with a TWIN ferrule	[mm ²]	-	-	-	0.5 - 4
General data					
Stripping length	[mm]	12			
Screw thread		M4			
Tightening torque	[Nm]	1.5 - 1.8			
Insulating material		PA			
Flammability rating in accordance with UL 94		V0			

		Technical data			
Dimensions		Width	Length	Height NS 35/7,5	
	[mm]	10.2	59.6	51	
Dimensions		Width	Length	Height NS 32	
	[mm]	10.2	59.6	56	
Maximum electrical data		I_{max} [A]	U_{max} [V]	max. Ø [mm ²]	AWG (UL)
		76	1000	0.5 - 16	20-6
Rated data		IEC 60947-7-1		IEC/EN 60079-7	
		IEC	UL / CUL	CSA	IEC/EN 60079-7
Rated voltage	[V]	1000	600	600	-
Nominal current / cross section	[A] / [mm ²]	57 / 10	65 / -	65 / -	-
Rated cross section	[mm ²]	10	-	-	-
Cross section range	AWG	20 - 6	20-6	20-6	-
Connection capacity		Rigid	Flexible	Ferrule without/with plastic sleeve	
1 conductor	[mm ²]	0.5 - 16	0.5 - 10	0.5 - 10	0.5 - 6
2 conductors (of the same type)	[mm ²]	0.5 - 4	0.5 - 4	0.5 - 2.5	-
2 flexible conductors with a TWIN ferrule	[mm ²]	-	-	-	0.5 - 6
General data					
Stripping length	[mm]	12			
Screw thread		M4			
Tightening torque	[Nm]	1.5 - 1.8			
Insulating material		PA			
Flammability rating in accordance with UL 94		V0			

Description	No. of pos.	Color
Terminal block , for mounting on NS 32... or NS 35...		gray

Ordering data				
Type	I_{max}	Order No.	Pcs./Pkt.	
USST 6		3070341	50	

Ordering data				
Type	I_{max}	Order No.	Pcs./Pkt.	
USST 10		3070354	50	

Accessories		
Cover , width: 2.2 mm	gray	
Partition plate , 2 mm wide	gray	
Fixed bridge , isolated	10	silver
Isolator bridge bar , divisible, with 10 screws, for switchable branches with IS-K...	10	silver
Bridge bar isolator , as distance piece for isolator bridge bar		gray
Separating disk , for separation of neighboring bridges, can be fitted later, no loss of pitch		gray
Test socket , for test connection with test plug PS		silver
Test socket , insulated, for UK 6 N, UK 10 N and URTK/SP and USST 10 terminal blocks, M4 thread		transparent
		blue
		yellow
		white
		black
		red
Short-circuit plug , for short circuiting neighboring terminal blocks, fully insulated, 2-pos., I_{max} 20 A		black
Short-circuit plug , for short circuiting neighboring terminal blocks, can only be used with PSB or PSBJ, with 8.2 mm pitch		black
Screwdriver		
Lateral groove labeling		

Accessories				
Type	I_{max}	Order No.	Pcs./Pkt.	
D-USST 4/10		3070370	50	
TPNS-UK		0706647	50	
FBI 10- 8	52 A	0203263	10	
ISSBI 10- 8	38 A	0301534	10	
IS-K 10		1303337	100	
TS-USST 4/10		3070383	50	
PSB 4/7/6		0303299	10	
KSS 8		0311540	10	
KSS 4- 8		0309549	10	
SZS 1,0X4,0 VDE		1205066	10	
UC-TM 8, UCT-TM 8 or ZB 8 (see Catalog 3)				

Accessories				
Type	I_{max}	Order No.	Pcs./Pkt.	
D-USST 4/10		3070370	50	
TPNS-UK		0706647	50	
FBI 10-10	70 A	0203276	10	
ISSBI 10-10	41 A	0301521	10	
IS-K 10		1303337	100	
TS-USST 4/10		3070383	50	
PSB 4/7/6		0303299	10	
PSBJ 4/15/6 FARBLOS		0303419	10	
PSBJ 4/15/6 BU		0303354	10	
PSBJ 4/15/6 YE		0303367	10	
PSBJ 4/15/6 WH		0303312	10	
PSBJ 4/15/6 BK		0303406	10	
PSBJ 4/15/6 RD		0303325	10	
KSS 10		0310541	10	
KSS 4-10		0308540	10	
SZS 1,0X4,0 VDE		1205066	10	
UC-TM 10, UCT-TM 10 or ZB 10 (see Catalog 3)				

Spring-assisted disconnect and knife disconnect terminal blocks

- Standardized disconnect zone
- Various function plugs are available for use in the disconnect terminal blocks
- For corresponding function plugs, see page 415



4 (6) mm², 20 A, disconnect terminal block, 2 connections



4 (6) mm², 20 A, knife disconnect terminal block, 2 connections

Notes:
 1) U_{max.} 300 V
 Corresponding flat-ribbon cable lugs with C-BCI ... hooks can be found in Catalog 3 or at phoenixcontact.net/products



Technical data				
Dimensions	Width	Length	Height NS 35/7,5	
	6.2	63.4	57.3	
Dimensions	Width	Length	Height NS 32	
	6.2	63.4	62.3	
Maximum electrical data	I _{max.} [A]	U _{max.} [V]	max. Ø [mm ²]	AWG (UL)
	20	500	0.2 - 6	24-10
Rated data	IEC 60947-7-1	UL / CUL	CSA	IEC/ EN 60079-7
	IEC	UL / CUL	CSA	IEC/ EN 60079-7
Rated voltage	[V]	500	600	600
Nominal current / cross section	[A] / [mm ²]	20 / 4	20	20 / -
Rated cross section	[mm ²]	4	-	-
Cross section range	AWG	24 - 10	24-10	24-10
Connection capacity		Rigid	Flexible	Ferrule without/with plastic sleeve
1 conductor	[mm ²]	0.2 - 6	0.2 - 4	0.25 - 4 0.25 - 2.5
2 conductors (of the same type)	[mm ²]	0.2 - 1.5	0.2 - 1.5	0.25 - 1.5 -
2 flexible conductors with a TWIN ferrule	[mm ²]	-	-	- 0.5 - 2.5
General data				
Stripping length	[mm]	10		
Screw thread		M3		
Tightening torque	[Nm]	0.6 - 0.8		
Insulating material		PA		
Flammability rating in accordance with UL 94		V0		



Technical data				
Dimensions	Width	Length	Height NS 35/7,5	
	6.2	63.4	57.3	
Dimensions	Width	Length	Height NS 32	
	6.2	63.4	62.3	
Maximum electrical data	I _{max.} [A]	U _{max.} [V]	max. Ø [mm ²]	AWG (UL)
	20	500	0.2 - 6	24-10
Rated data	IEC 60947-7-1	UL / CUL	CSA	IEC/ EN 60079-7
	IEC	UL / CUL	CSA	IEC/ EN 60079-7
Rated voltage	[V]	500	600	600
Nominal current / cross section	[A] / [mm ²]	20 / 4	20	20 / -
Rated cross section	[mm ²]	4	-	-
Cross section range	AWG	24 - 10	24-10	24-10
Connection capacity		Rigid	Flexible	Ferrule without/with plastic sleeve
1 conductor	[mm ²]	0.2 - 6	0.2 - 4	0.25 - 4 0.25 - 2.5
2 conductors (of the same type)	[mm ²]	0.2 - 1.5	0.2 - 1.5	0.25 - 1.5 -
2 flexible conductors with a TWIN ferrule	[mm ²]	-	-	- 0.5 - 2.5
General data				
Stripping length	[mm]	10		
Screw thread		M3		
Tightening torque	[Nm]	0.6 - 0.8		
Insulating material		PA		
Flammability rating in accordance with UL 94		V0		

Ordering data			
Description	No. of pos.	Type	I _{max.}
Terminal block, for mounting on NS 35... (With test socket screws!)		USST 4-TG	20 A
		USST 4-TG P/P	20 A

Ordering data			
Description	No. of pos.	Type	I _{max.}
Terminal block, for mounting on NS 35... (With test socket screws!)		USST 4-MT	20 A
		USST 4-MT P/P	20 A

Accessories			
Description	No. of pos.	Type	I _{max.}
Cover, width: 2.2 mm		D-USST 4-MT	20 A
Partition plate, 2 mm wide		TPNS-UK	20 A
Fixed bridge, isolated	10	FBI 10- 6	38 A
Isolator bridge bar, divisible, with 10 screws, for switchable branches with IS-K...	10	ISSBI 10- 6	30 A
Bridge bar isolator, as distance piece for isolator bridge bar		IS-K 4	20 A
Separating disk, for separation of neighboring bridges, can be fitted later, no loss of pitch		TS-USST 4/10	20 A
Test socket	silver	PSB 3/10/4	20 A
Test socket, insulated, can be used only with FBI and ISSBI	silver	PSBJ 3/13/4	20 A
Screwdriver		SF-SL 0,6X3,5-100 S-VDE	20 A
Screwdriver, for disconnect slide and test socket		SZG 0,6X3,5 VDE	20 A

Accessories			
Description	No. of pos.	Type	I _{max.}
Cover, width: 2.2 mm		D-USST 4-MT	20 A
Partition plate, 2 mm wide		TPNS-UK	20 A
Fixed bridge, isolated	10	FBI 10- 6	38 A
Isolator bridge bar, divisible, with 10 screws, for switchable branches with IS-K...	10	ISSBI 10- 6	30 A
Bridge bar isolator, as distance piece for isolator bridge bar		IS-K 4	20 A
Separating disk, for separation of neighboring bridges, can be fitted later, no loss of pitch		TS-USST 4/10	20 A
Test socket	silver	PSB 3/10/4	20 A
Test socket, insulated, can be used only with FBI and ISSBI	silver	PSBJ 3/13/4	20 A
Screwdriver		SF-SL 0,6X3,5-100 S-VDE	20 A
Screwdriver, for disconnect slide and test socket		SZG 0,6X3,5 VDE	20 A

UC-TM 6, UCT-TM 6 or ZB 6 (see Catalog 3)

UC-TM 6, UCT-TM 6 or ZB 6 (see Catalog 3)

USST spring-assisted screw terminal blocks

Spring-assisted test disconnect and feed-through terminal blocks

- The USST 6-T test disconnect terminal block has been developed specifically for use in current transformer secondary circuits
- Can be fitted on both sides with fixed bridges as well as test sockets with a 4 mm diameter
- Terminal block and accessories were designed to be touch-proof as per BGV A2

PROJECT complete planning enables the quick and convenient planning and configuration of error-free terminal strips.

Notes:
For more test sockets, visit phoenixcontact.net/products
For more short-circuit plugs, visit phoenixcontact.net/products

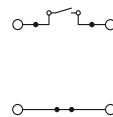

6 (10) mm², 57 A, test disconnect terminal block



Dimensions	
	[mm]
Dimensions	
	[mm]
Maximum electrical data	
Rated data	
Rated voltage	[V]
Nominal current / cross section	[A] / [mm ²]
Rated cross section	[mm ²]
Cross section range	AWG
Connection capacity	
1 conductor	[mm ²]
2 conductors (of the same type)	[mm ²]
2 flexible conductors with a TWIN ferrule	[mm ²]
General data	
Stripping length	[mm]
Screw thread	
Tightening torque	[Nm]
Insulating material	
Flammability rating in accordance with UL 94	

Technical data					
Width	Length	Height NS 35/7,5			
8.2	82	52			
Width	Length	Height NS 32			
8.2	82	57			
I _{max} [A]	U _{max} [V]	max. Ø [mm ²]	AWG (UL)		
57	500	0.2 - 10	24-10		
IEC 60947-7-1					
IEC	UL / CUL	CSA	IEC/EN 60079-7		
Rated voltage	500	600	600	-	
Nominal current / cross section	41 / 6	30 / -	30 / -	-	
Rated cross section	6	-	-	-	
Cross section range	24 - 8	24-10	24-10	-	
Connection capacity		Rigid	Flexible	Ferrule	
1 conductor	[mm ²]	0.2 - 10	0.2 - 6	without/with plastic sleeve	
2 conductors (of the same type)	[mm ²]	0.2 - 2.5	0.2 - 2.5	0.25 - 6 0.25 - 6	
2 flexible conductors with a TWIN ferrule	[mm ²]	-	-	0.25 - 1.5 -	
				- 0.5 - 4	
General data		12			
Stripping length	[mm]	M4			
Screw thread		1.5 - 1.8			
Tightening torque	[Nm]	PA			
Insulating material		V0			
Flammability rating in accordance with UL 94					

Description	No. of pos.	Color
Test disconnect terminal block, for mounting on NS 32... or NS 35...		gray
Feed-through terminal block, for mounting on NS 32... or NS 35...		gray

Ordering data			
Type	I _{max}	Order No.	Pcs./Pkt.
USST 6-T		3070312	50

Cover, width: 2.2 mm		gray
Fixed bridge, isolated	10	silver
Switching lock, excludes the possibility of an unintentional operation of the disconnect slide		white
Test socket, insulated		transparent
		blue
		yellow
		green
		violet
		black
Short-circuit plug, for short circuiting neighboring terminal blocks, fully insulated, 2-pos., I _{max} 20 A		black
Short-circuit plug, for short circuiting neighboring terminal blocks, can only be used with PSB or PSBJ, with 8.2 mm pitch		black
Screwdriver		
Screwdriver, for disconnect slide and test socket		

Accessories			
D-USST 6-T	I _{max}	Order No.	Pcs./Pkt.
D-USST 6-T		3070367	50
FBRI 10-8 N	45 A	2772080	10
S-URTK/SP		0311155	50
PSBJ-URTK 6 FARBLOS		3026450	10
PSBJ-URTK 6 BU		3026434	10
PSBJ-URTK 6 YE		3026405	10
PSBJ-URTK 6 GN		3026418	10
PSBJ-URTK 6 VT		3026421	10
PSBJ-URTK 6 BK		3026447	10
KSS 8		0311540	10
KSS 4-8		0309549	10
SZS 1,0X4,0 VDE		1205066	10
SF-SL 0,6X3,5-100 S-VDE		1212587	10

Lateral groove labeling

UC-TM 8, UCT-TM 8 or ZB 8 (see Catalog 3)



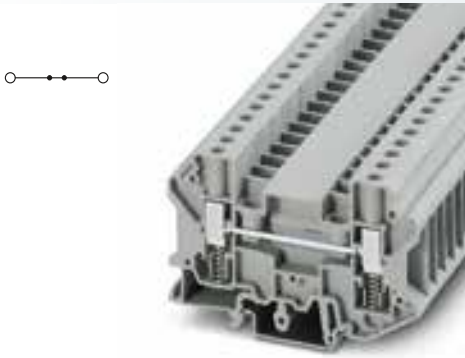

6 (10) mm², 57 A, feed-through terminal block,
same shape



Technical data

Width	Length	Height NS 35/7,5	
8.2	82	52	
Width	Length	Height NS 32	
8.2	82	57	
I_{max} [A]	U_{max} [V]	max. Ø [mm ²]	AWG (UL)
57	500	0.2 - 10	24-10
IEC 60947-7-1			
IEC	UL / CUL	CSA	IEC/ EN 60079-7
500	600	-	-
41 / 6	30 / -	-	-
6	-	-	-
24 - 8	24-10	-	-
Rigid	Flexible	Ferrule without/with plastic sleeve	
0.2 - 10	0.2 - 6	0.25 - 6	0.25 - 6
0.2 - 2.5	0.2 - 2.5	0.25 - 1.5	-
-	-	-	0.5 - 4
12			
M4			
1.5 - 1.8			
PA			
V0			

Ordering data

Type	I_{max}	Order No.	Pcs./Pkt.
USSTD 6		3070325	50

Accessories

D-USST 6-T		3070367	50
FBRI 10-8 N	45 A	2772080	10
PSBJ-URTK 6 FARBLOS		3026450	10
PSBJ-URTK 6 BU		3026434	10
PSBJ-URTK 6 YE		3026405	10
PSBJ-URTK 6 GN		3026418	10
PSBJ-URTK 6 VT		3026421	10
PSBJ-URTK 6 BK		3026447	10
KSS 8		0311540	10
KSS 4- 8		0309549	10
SZS 1,0X4,0 VDE		1205066	10

UC-TM 8, UCT-TM 8 or ZB 8
(see Catalog 3)

USST spring-assisted screw terminal blocks

Spring-assisted test disconnect and feed-through terminal blocks

Notes:
1) When the switching bridge is used, U_{max} is reduced to 400 V.
2) For additional test sockets, visit phoenixcontact.net/products

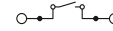

6 (10) mm², 57 A, test disconnect terminal block, for accommodating switching bridges, 2 connections



Dimensions	
	[mm]
Dimensions	
	[mm]
Maximum electrical data	
Rated data	
Rated voltage	[V]
Nominal current / cross section	[A] / [mm ²]
Rated cross section	[mm ²]
Cross section range	AWG
Connection capacity	
1 conductor	[mm ²]
2 conductors (of the same type)	[mm ²]
2 flexible conductors with a TWIN ferrule	[mm ²]
General data	
Stripping length	[mm]
Screw thread	
Tightening torque	[Nm]
Insulating material	
Flammability rating in accordance with UL 94	

Technical data					
Width	Length	Height NS 35/7,5			
8.2	82	52			
Width	Length	Height NS 32			
8.2	82	57			
I_{max} [A]	U_{max} [V]	max. \varnothing [mm ²]	AWG (UL)		
57	500¹⁾	0.2 - 10	24-10		
IEC 60947-7-1					
IEC	UL / CUL	CSA	IEC/ EN 60079-7		
500 ¹⁾	600	-	-		
41 / 6	30 / -	-	-		
6	-	-	-		
24 - 8	24-10	-	-		
Connection capacity		Rigid	Flexible	Ferrule	
		without/with plastic sleeve			
1 conductor	[mm ²]	0.2 - 10	0.2 - 6	0.25 - 6 0.25 - 6	
2 conductors (of the same type)	[mm ²]	0.2 - 2.5	0.2 - 2.5	0.25 - 1.5 -	
2 flexible conductors with a TWIN ferrule	[mm ²]	-	-	- 0.5 - 4	
General data		12			
Stripping length	[mm]	M4			
Screw thread		1.5 - 1.8			
Tightening torque	[Nm]	PA			
Insulating material		V0			

Description	No. of pos.	Color
Test disconnect terminal block , for mounting on NS 32... or NS 35...		gray

Ordering data			
Type	I_{max}	Order No.	Pcs./Pkt.
USST 6-T/SB		3070310	50

Cover , width: 2.2 mm		gray
Switching bridge		
	2	orange
	3	orange
	4	orange
Switching bridge , complete with test sockets		
	2	orange
	3	orange
	4	orange
Fixed bridge	10	silver
Isolator bridge bar	10	silver
Test socket		silver
Test socket , insulated ²⁾		gray
		brown
		black
		red
		orange
		yellow
		green
		violet
Short-circuit plug , for short circuiting neighboring terminal blocks, fully insulated, 2-pos., I_{max} 20 A		black
Screwdriver		
Screwdriver , for disconnect slide and test socket		
Lateral groove labeling		

Accessories			
Type	I_{max}	Order No.	Pcs./Pkt.
D-USST 6-T		3070367	50
SB 6-T 2-8	32 A	3075842	10
SB 6-T 3-8	32 A	3075843	10
SB 6-T 4-8	32 A	3075844	10
SBP 6-T 2-8	20 A	3070321	10
SBP 6-T 3-8	20 A	3070322	10
SBP 6-T 4-8	20 A	3070323	10
SCBI 10-8,15	30 A	3245134	10
SCBI 10-8,15 ISO	24 A	3000417	10
TPS 3/20/5		3246586	10
PSBJ 6-T GY		3070316	10
PSBJ 6-T BN		3070317	10
PSBJ 6-T BK		3070318	10
PSBJ 6-T RD		3070319	10
PSBJ 6-T OG		3070320	10
PSBJ 6-T YE		3070326	10
PSBJ 6-T GN		3070327	10
PSBJ 6-T VT		3070328	10
KSS 8		0311540	10
SZS 1,0X4,0 VDE		1205066	10
SF-SL 0,6X3,5-100 S-VDE		1212587	10
UC-TM 8, UCT-TM 8 or ZB 8 (see Catalog 3)			

Spring-assisted test disconnect and feed-through terminal blocks

Notes:
 1) For additional test sockets, visit phoenixcontact.net/products
 For further separating disks, visit phoenixcontact.net/products

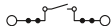

10 (10) mm², 50 A, test disconnect terminal block

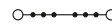

6 (10) mm², 50 A, feed-through terminal block, same shape



Technical data				
Dimensions	Width	Length	Height NS 35/7,5	
	8.2	105.2	53	
Dimensions	Width	Length	Height NS 32	
	8.2	105.2	58	
Maximum electrical data	I _{max} [A]	U _{max} [V]	max. Ø [mm ²]	AWG (UL)
	50	1000	0.2 - 10	20-8
Rated data	IEC 60947-7-1	UL / CUL	CSA	IEC / EN 60079-7
	IEC	UL	CSA	IEC / EN
Rated voltage [V]	1000	600	-	-
Nominal current / cross section [A] / [mm ²]	41 / 6	50	-	-
Rated cross section [mm ²]	6	-	-	-
Cross section range AWG	24 - 8	20-8	-	-
Connection capacity	Rigid	Flexible	Ferrule without/with plastic sleeve	
1 conductor [mm ²]	0.2 - 10	0.2 - 10	0.25 - 6	0.25 - 6
2 conductors (of the same type) [mm ²]	0.2 - 2.5	0.2 - 2.5	0.2 - 1.5	-
2 flexible conductors with a TWIN ferrule [mm ²]	-	-	-	-
General data	Stripping length [mm]	12		
	Screw thread	M4		
	Tightening torque [Nm]	1.5 - 1.8		
	Insulating material	PA		
	Flammability rating in accordance with UL 94	V0		



Technical data				
Dimensions	Width	Length	Height NS 35/7,5	
	8.2	105.2	53	
Dimensions	Width	Length	Height NS 32	
	8.2	105.2	58	
Maximum electrical data	I _{max} [A]	U _{max} [V]	max. Ø [mm ²]	AWG (UL)
	50	1000	0.2 - 10	20-8
Rated data	IEC 60947-7-1	UL / CUL	CSA	IEC / EN 60079-7
	IEC	UL	CSA	IEC / EN
Rated voltage [V]	1000	600	-	-
Nominal current / cross section [A] / [mm ²]	41 / 6	50	-	-
Rated cross section [mm ²]	6	-	-	-
Cross section range AWG	24 - 8	20-8	-	-
Connection capacity	Rigid	Flexible	Ferrule without/with plastic sleeve	
1 conductor [mm ²]	0.2 - 10	0.2 - 6	0.25 - 6	0.25 - 6
2 conductors (of the same type) [mm ²]	0.2 - 2.5	0.2 - 2.5	0.25 - 1.5	-
2 flexible conductors with a TWIN ferrule [mm ²]	-	-	-	-
General data	Stripping length [mm]	12		
	Screw thread	M4		
	Tightening torque [Nm]	1.5 - 1.8		
	Insulating material	PA		
	Flammability rating in accordance with UL 94	V0		

Ordering data						
Description	No. of pos.	Color	Type	I _{max}	Order No.	Pcs./Pkt.
Test disconnect terminal block , for mounting on NS 32... or NS 35...		gray	USST 6-T/SP		3070330	50
Feed-through terminal block , for mounting on NS 32... or NS 35...		gray				

Ordering data						
Description	No. of pos.	Color	Type	I _{max}	Order No.	Pcs./Pkt.
Test disconnect terminal block , for mounting on NS 32... or NS 35...		gray	USST 6-T/SP		3070330	50
Feed-through terminal block , for mounting on NS 32... or NS 35...		gray	USSTD 6/SP		3070331	50

Accessories						
Cover , width: 2.2 mm	gray	D-UT 6-T/SP		3072816	50	
Plug-in bridge		FBS 2-8	41 A	3030284	10	
	2	FBS 3-8	41 A	3030297	10	
	3	FBS 10-8	41 A	3030323	10	
Switching bridge		SB 6-T 2-8	32 A	3075842	10	
	2	SB 6-T 3-8	32 A	3075843	10	
	3	SB 6-T 4-8	32 A	3075844	10	
Switching bridge , complete with test sockets		SBP 6-T 2-8	20 A	3070321	10	
	2	SBP 6-T 3-8	20 A	3070322	10	
	3	SBP 6-T 4-8	20 A	3070323	10	
Isolator bridge bar		SCBI 10-8,15 ISO	24 A	3000417	10	
Test socket		TPS 3/20/5		3246586	10	
Test socket , insulated ¹⁾		PSBJ 6-T GY		3070316	10	
Short-circuit plug , for short circuiting neighboring terminal blocks, fully insulated, 2-pos., I _{max} 20 A		KSS 8		0311540	10	
Short-circuit plug , for short circuiting neighboring terminal blocks, can only be used with PSB or PSBJ, with 8.2 mm pitch 4-pos.		KSS 4-8		0309549	10	
Screwdriver		SZS 1,0X4,0 VDE		1205066	10	
Screwdriver , for disconnect slide and test socket		SF-SL 0,6X3,5-100 S-VDE		1212587	10	

Accessories						
Cover , width: 2.2 mm	gray	D-UT 6-T/SP		3072816	50	
Plug-in bridge		FBS 2-8	41 A	3030284	10	
	2	FBS 3-8	41 A	3030297	10	
	3	FBS 10-8	41 A	3030323	10	
Switching bridge		SB 6-T 2-8	32 A	3075842	10	
	2	SB 6-T 3-8	32 A	3075843	10	
	3	SB 6-T 4-8	32 A	3075844	10	
Switching bridge , complete with test sockets		SBP 6-T 2-8	20 A	3070321	10	
	2	SBP 6-T 3-8	20 A	3070322	10	
	3	SBP 6-T 4-8	20 A	3070323	10	
Isolator bridge bar		SCBI 10-8,15 ISO	24 A	3000417	10	
Test socket		TPS 3/20/5		3246586	10	
Test socket , insulated ¹⁾		PSBJ 6-T GY		3070316	10	
Short-circuit plug , for short circuiting neighboring terminal blocks, fully insulated, 2-pos., I _{max} 20 A		KSS 8		0311540	10	
Short-circuit plug , for short circuiting neighboring terminal blocks, can only be used with PSB or PSBJ, with 8.2 mm pitch 4-pos.		KSS 4-8		0309549	10	
Screwdriver		SZS 1,0X4,0 VDE		1205066	10	
Screwdriver , for disconnect slide and test socket		SF-SL 0,6X3,5-100 S-VDE		1212587	10	

Lateral groove labeling

UC-TM 8, UCT-TM 8 or ZB 8 (see Catalog 3)

UC-TM 8, UCT-TM 8 or ZB 8 (see Catalog 3)

Terminal blocks – Classic

MT and MBK mini screw terminal blocks

Miniature terminal blocks MT ...

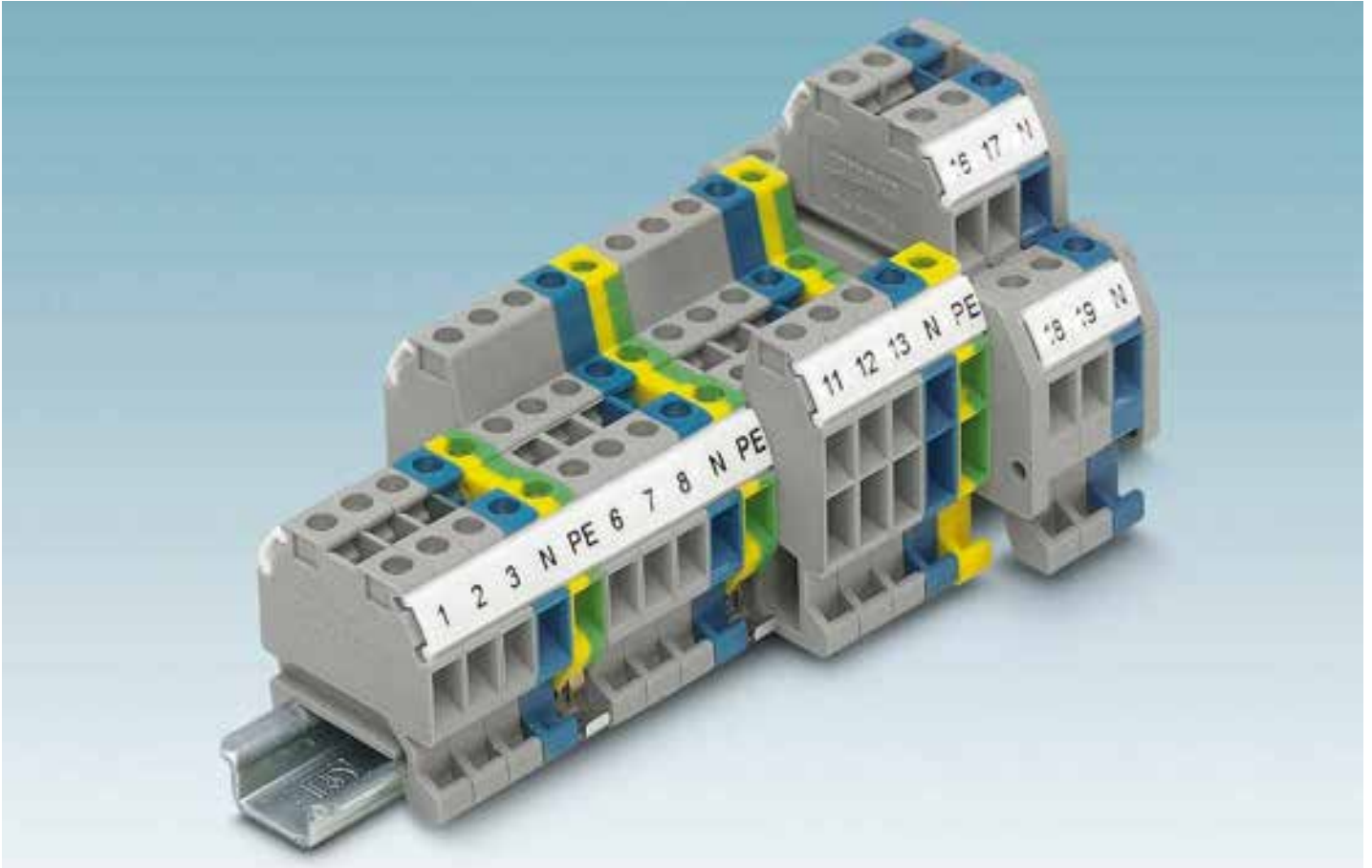

i Your web code: #0059



Miniature modular terminal blocks

The MT miniature screw terminal blocks may be tiny but they can be marked and bridged just like their larger cousins. With a pitch of 4.2 mm and a connection cross section of 1.5 mm², they permit convenient wiring in tight spaces.



Universal and zero-maintenance

The screw connection of the miniature terminal blocks MT is characterized by three main features.

- Global standard
- Multiple conductor connection
- Zero maintenance thanks to Reakdyn principle

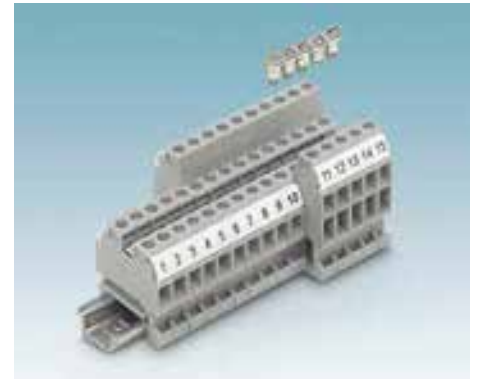

Continuous potential distribution

Potential branching is one of the most common tasks in control unit construction. The MT miniature terminal blocks are available as three-conductor and four-conductor versions. A large number of switching tasks can be undertaken in the terminal strip with the linear bridge shaft.

Miniature feed-through terminal blocks MT ..., for NS 15 DIN rail

Their compact design means that the micro terminals MT 1,5 can keep pace with the growing need for ever smaller switch boxes

The miniature terminal blocks have everything that makes the modular terminal blocks stand out:

- Design width of just 4.2 mm
- Nominal cross section of 1.5 mm²
- Snap-on foot for DIN rails NS 15
- Numerous labeling options
- Bridging facility in terminal center

Potential branching is one of the main tasks of modular terminal blocks in control unit construction.

- The three- or four-conductor terminal blocks MT 1,5-TWIN or MT 1,5-QUATTRO undertake this work in very tight spaces
- The MUT ... miniature terminal blocks can be found in the section on 4 mm² UT screw connection terminal blocks
- The amount of space saved is maximized with the double-level micro terminal MTTB 1,5
- This double-level terminal block contains two feed-through levels which can be bridged independently of one another
- Can be used on both the 15 mm DIN rail NS 15 and the 35 mm DIN rail NS 35

Notes:

For mini screw terminal blocks with plug-in bridges, see page 157



1.5 (1.5) mm², 17.5 A, feed-through terminal block

Ex: EAC Ex

Dimensions		[mm]
Width		4.2
Length		22
Height NS 15		23.5
Maximum electrical data		
I_{max} [A]	U_{max} [V]	max. \varnothing [mm ²] AWG (UL)
17.5	400	0.14 - 1.5 30-14
IEC 60947-7-1		
Rated data		
Rated voltage	[V]	400
Nominal current / cross section	[A] / [mm ²]	17.5 / 1.5
Rated cross section	[mm ²]	1.5
Cross section range	AWG	26 - 16
Connection capacity		
1 conductor	[mm ²]	0.14 - 1.5
2 conductors (of the same type)	[mm ²]	0.14 - 0.5
General data		
Stripping length	[mm]	6
Screw thread		M2
Tightening torque	[Nm]	0.22 - 0.25
Insulating material		PA
Flammability rating in accordance with UL 94		V0

Technical data				
Width	Length	Height NS 15		
4.2	22	23.5		
I_{max} [A]	U_{max} [V]	max. \varnothing [mm ²]	AWG (UL)	
17.5	400	0.14 - 1.5	30-14	
IEC 60947-7-1				
IEC	UL / CUL	CSA	IEC / EN 60079-7	
400	300	300	275	
17.5 / 1.5	15 / -	15 / -	-	
1.5	-	-	-	
Cross section range	AWG	26-14	0.14-1.5	
Connection capacity				
Rigid	Flexible	Ferrule		
		without/with plastic sleeve		
0.14 - 1.5	0.14 - 1.5	0.25 - 0.75	0.25 - 0.75	
0.14 - 0.5	0.14 - 0.5	0.25 - 0.34	-	
General data				
Stripping length	[mm]	6		
Screw thread		M2		
Tightening torque	[Nm]	0.22 - 0.25		
Insulating material		PA		
Flammability rating in accordance with UL 94		V0		

Description	No. of pos.	Color
Terminal block, for mounting on NS 15 in acc. with EN 60715	10	gray
		blue

Cover, width: 1 mm	gray
	blue
Fixed bridge, isolated	10 silver

Screwdriver

Lateral groove labeling

Ordering data			
Type	I_{max}	Order No.	Pcs./Pkt.
MT 1,5		3100305	50
MT 1,5 BU		3003363	50

Accessories			
Accessories		Order No.	Pcs./Pkt.
D-MT 1,5		3100321	50
D-MT 1,5 BU		3025529	50
FBRN 10-4 N	12 A	3001624	10
SZS 0,4X2,5 VDE		1205037	10
ZBF 4 (see Catalog 3)			

Terminal blocks – Classic

MT and MBK mini screw terminal blocks

Miniature feed-through terminal blocks with 3 and 4 connections MT ..., for NS 15 DIN rail

- Design width of just 4.2 mm
- Nominal cross section of 1.5 mm²
- Snap-on foot for DIN rails NS 15
- Numerous labeling options
- Bridging facility in terminal center



1.5 (1.5) mm², 17.5 A, feed-through terminal block, 3 connections

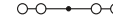

1.5 (1.5) mm², 16 A, feed-through terminal block, 4 connections



		Technical data			
Dimensions		Width	Length	Height NS 15	
		4.2	27.8	24.4	
Maximum electrical data		I_{max} [A]	U_{max} [V]	max. Ø [mm ²]	AWG (UL)
		17.5	400	0.14 - 1.5	30-14
Rated data		IEC 60947-7-1			
		IEC	UL / CUL	CSA	IEC/ EN 60079-7
Rated voltage	[V]	400	300	300	-
Nominal current / cross section	[A] / [mm ²]	17.5 / 1.5	15 / -	15 / -	-
Rated cross section	[mm ²]	1.5	-	-	-
Cross section range	AWG	26 - 16	30-14	28-14	-
Connection capacity		Rigid	Flexible	Ferrule without/with plastic sleeve	
1 conductor	[mm ²]	0.14 - 1.5	0.14 - 1.5	0.25 - 0.75	0.25 - 0.75
2 conductors (of the same type)	[mm ²]	0.14 - 0.5	0.14 - 0.5	0.25 - 0.34	-
General data					
Stripping length	[mm]	6			
Screw thread		M2			
Tightening torque	[Nm]	0.22 - 0.25			
Insulating material		PA			
Flammability rating in accordance with UL 94		V0			

		Technical data			
Dimensions		Width	Length	Height NS 15	
		4.2	33.5	30	
Maximum electrical data		I_{max} [A]	U_{max} [V]	max. Ø [mm ²]	AWG (UL)
		16	400	0.14 - 1.5	30-14
Rated data		IEC 60947-7-1			
		IEC	UL / CUL	CSA	IEC/ EN 60079-7
Rated voltage	[V]	400	300	300	-
Nominal current / cross section	[A] / [mm ²]	16 / 1.5	15 / -	15 / -	-
Rated cross section	[mm ²]	1.5	-	-	-
Cross section range	AWG	26 - 16	30-14	28-14	-
Connection capacity		Rigid	Flexible	Ferrule without/with plastic sleeve	
1 conductor	[mm ²]	0.14 - 1.5	0.14 - 1.5	0.25 - 0.75	0.25 - 0.75
2 conductors (of the same type)	[mm ²]	0.14 - 0.5	0.14 - 0.5	0.25 - 0.34	-
General data					
Stripping length	[mm]	6			
Screw thread		M2			
Tightening torque	[Nm]	0.22 - 0.25			
Insulating material		PA			
Flammability rating in accordance with UL 94		V0			

			Ordering data			
Description	No. of pos.	Color	Type	I_{max}	Order No.	Pcs./Pkt.
Terminal block, for mounting on NS 15 in acc. with EN 60715		gray	MT 1,5-TWIN		3001682	50
		blue	MT 1,5-TWIN BU		3025532	50

			Ordering data			
Description	No. of pos.	Color	Type	I_{max}	Order No.	Pcs./Pkt.
Terminal block, for mounting on NS 15 in acc. with EN 60715		gray	MT 1,5-QUATTRO		3001679	50
		blue	MT 1,5-QUATTRO BU		3025150	50

			Accessories			
Cover, width: 1 mm		gray/blue	D-MT 1,5-TWIN		3002979	50
Fixed bridge, isolated			FBRN 10-4 N	12 A	3001624	10
Screwdriver	10	silver	SZS 0,4X2,5 VDE		1205037	10
Lateral groove labeling			ZBF 4 (see Catalog 3)			

			Accessories			
Cover, width: 1 mm		gray/blue	D-MT 1,5-QUATTRO		3002982	50
Fixed bridge, isolated			D-MT 1,5-QUATTRO BU		3025309	50
Screwdriver	10	silver	FBRN 10-4 N	12 A	3001624	10
			SZS 0,4X2,5 VDE		1205037	10
Lateral groove labeling			ZBF 4 (see Catalog 3)			

Miniature double-level terminal blocks MTTB 1,5

- Design width of just 4.2 mm
- Nominal cross section of 1.5 mm²
- Snap-on foot for DIN rails NS 15 and NS 35
- Numerous labeling options
- Bridging facility on both levels
- Even if fully wired, the level offset offers unobstructed access to the lower connection level

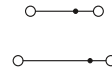

1.5 (1.5) mm², 17.5 A, double-level terminal block



Dimensions			
	[mm]	4.2	44
Dimensions			
	[mm]	4.2	44
Maximum electrical data			
		17.5	400
Rated data			
Rated voltage	[V]	400	-
Nominal current / cross section	[A] / [mm ²]	17.5 / 1.5	- / -
Rated cross section	[mm ²]	1.5	-
Cross section range	AWG	26 - 16	-
Connection capacity			
1 conductor	[mm ²]	0.14 - 1.5	0.14 - 1.5
2 conductors (of the same type)	[mm ²]	0.14 - 0.5	0.14 - 0.5
General data			
Stripping length	[mm]	6	
Screw thread		M2	
Tightening torque	[Nm]	0.22 - 0.25	
Insulating material		PA	
Flammability rating in accordance with UL 94		V0	

Technical data				
Width	Length	Height NS 35/7,5		
4.2	44	41		
Width	Length	Height NS 15		
4.2	44	41		
I_{max} [A]	U_{max} [V]	max. Ø [mm ²]	AWG (UL)	
17.5	400	0.14 - 1.5	-	
IEC 60947-7-1	UL / CUL	CSA	IEC/EN 60079-7	
Rated voltage	[V]	300	-	
Nominal current / cross section	[A] / [mm ²]	15 / -	-	
Rated cross section	[mm ²]	-	-	
Cross section range	AWG	28-14	-	
Connection capacity		Rigid	Flexible	Ferrule without/with plastic sleeve
1 conductor	[mm ²]	0.14 - 1.5	0.14 - 1.5	0.25 - 0.75 / 0.25 - 0.75
2 conductors (of the same type)	[mm ²]	0.14 - 0.5	0.14 - 0.5	0.25 - 0.34 / -

Description	No. of pos.	Color
Double-level terminal block , with universal foot, for mounting on NS 15 or NS 35 in accordance with EN 60715		gray
		blue
Cover , 4 mm width		gray
Spacer cover , compensates for level offset if standard terminal blocks are to be fitted adjacently, 2 mm thick		gray
Spacer plate , compensates for level offset if standard terminal blocks are to be fitted adjacently, 2 mm thick		gray
Fixed bridge , isolated	10	silver
Screwdriver		
Lateral groove labeling		

Ordering data			
Type	I_{max}	Order No.	Pcs./Pkt.
MTTB 1,5		1414129	50
MTTB 1,5 BU		3000926	50

Accessories			
D-MTTB 1,5		3002665	50
DG-MTTB 1,5		3002678	50
DP-MTTB 1,5		3002681	50
FBRN 10-4 N	12 A	3001624	10
SZS 0,4X2,5 VDE		1205037	10
ZBF 4 (see Catalog 3)			

Terminal blocks – Classic

MT and MBK mini screw terminal blocks

Miniature ground terminal blocks MT ...-PE, for NS 15 DIN rails

- Same shape and pitch as the feed-through terminal blocks
- The MT ...-PE fulfill all requirements of the IEC 60947-7-2 standard
These are in particular:
 - Low contact resistances
 - Green-yellow housing
 - Corrosion-proof terminal points
 - Captive clamping screws

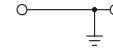

1.5 (1.5) mm², ground terminal block

Ex: EAC Ex

Dimensions		Technical data			
		Width	Length	Height NS 15	
		4.2	22	23.5	
Maximum electrical data				max. Ø [mm ²]	AWG (UL)
				0.14 - 1.5	30-14
Rated data		IEC 60947-7-2			
		IEC	UL / CUL	CSA	IEC/EN 60079-7
Rated voltage	[V]	-	-	-	-
Nominal current / cross section	[A] / [mm ²]	- / -	-	- / -	-
Rated cross section	[mm ²]	1.5	-	-	-
Cross section range	AWG	26 - 16	30-14	28-14	0.14-1.5
Connection capacity		Rigid	Flexible	Ferrule	
		without/with plastic sleeve			
1 conductor	[mm ²]	0.14 - 1.5	0.14 - 1.5	0.25 - 0.75	0.25 - 0.75
2 conductors (of the same type)	[mm ²]	-	-	-	-
General data					
Stripping length	[mm]	6			
Screw thread		M2			
Tightening torque	[Nm]	0.22 - 0.25			
Insulating material		PA			
Flammability rating in accordance with UL 94		V0			
Description		Ordering data			
		Type	Order No.	Pcs./Pkt.	
Ground terminal block, for mounting on NS 15	green-yellow	MT 1,5-PE	3100318	50	
Screwdriver		Accessories			
		SZS 0,4X2,5 VDE	1205037	10	
Lateral groove labeling		ZBF 4 (see Catalog 3)			

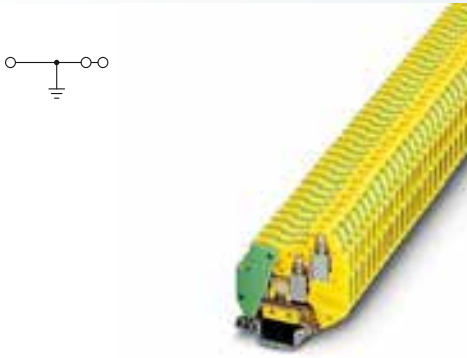

1.5 (1.5) mm², ground terminal block,
3 connections

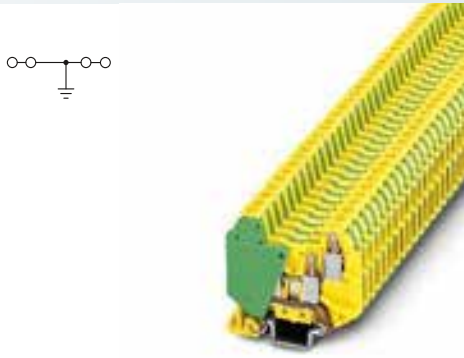

1.5 (1.5) mm², ground terminal block,
4 connections



Technical data			
Width	Length	Height NS 15	
4.2	28	30	
		max. Ø [mm ²]	AWG (UL)
		0.14 - 1.5	30-14
IEC 60947-7-2			
IEC	UL / CUL	CSA	IEC/ EN 60079-7
-	-	-	-
- / -	-	- / -	-
1.5	-	-	-
26 - 16	30-14	28-14	-
Rigid	Flexible	Ferrule without/with plastic sleeve	
0.14 - 1.5	0.14 - 1.5	0.25 - 0.75	0.25 - 0.75
-	-	-	-
6			
M2			
0.22 - 0.25			
PA			
V0			

Technical data			
Width	Length	Height NS 15	
4.2	33.5	30	
		max. Ø [mm ²]	AWG (UL)
		0.14 - 1.5	30-14
IEC 60947-7-2			
IEC	UL / CUL	CSA	IEC/ EN 60079-7
-	-	-	-
- / -	-	- / -	-
1.5	-	-	-
26 - 16	30-14	28-14	-
Rigid	Flexible	Ferrule without/with plastic sleeve	
0.14 - 1.5	0.14 - 1.5	0.25 - 0.75	0.25 - 0.75
-	-	-	-
6			
M2			
0.22 - 0.25			
PA			
V0			

Ordering data		
Type	Order No.	Pcs./Pkt.
MT 1,5-TWIN-PE	3001705	50

Ordering data		
Type	Order No.	Pcs./Pkt.
MT 1,5-QUATTRO-PE	3001695	50

Accessories		
SZS 0,4X2,5 VDE	1205037	10
ZBF 4 (see Catalog 3)		

Accessories		
SZS 0,4X2,5 VDE	1205037	10
ZBF 4 (see Catalog 3)		

MT and MBK mini screw terminal blocks

Miniature feed-through terminal blocks MBK ...

- The MBK ... and MSLKG ... terminal blocks represent the top end of the mini terminal block range for 15 mm NS 15 DIN rails
- MBK ... terminal blocks can be bridged in the terminal center
- Lateral marking with ZB zack marker strip terminal marking for tall marker groove
- Cross sections of up to 6 mm² can be easily wired
- Extensive bridging material, such as fixed bridges, insertion bridges and switchable bridges, enable simple and reliable potential branching
- A separating disk, partition plate, and test socket complete the range of accessories
- The MUT ... miniature terminal blocks can be found in the section on 4 mm² UT screw connection terminal blocks

Notes:
For 2.5 mm ² mini screw terminal blocks with bridges, see page 157.
For 4 mm ² mini screw terminal blocks with bridges, see page 171.
1) For information on installation and using accessories for Ex applications, see page 678.

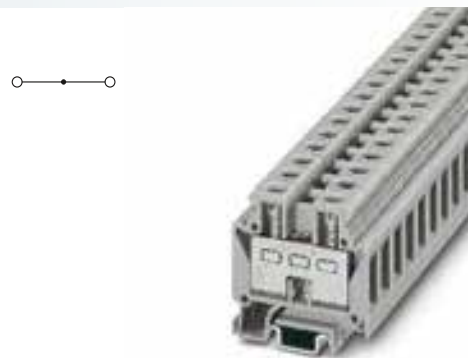

6 (10) mm², 57 A, feed-through terminal block

Ex: EAC Ex IEC Ex KEMA 01ATEX2134U / IECEx KEM 07.0008U

Dimensions		
		[mm]
Maximum electrical data		
Rated data		
Rated voltage	[V]	500
Nominal current / cross section	[A] / [mm ²]	41 / 6
Rated cross section	[mm ²]	6
Cross section range	AWG	20 - 8
Connection capacity		
1 conductor	[mm ²]	0.5 - 10
2 conductors (of the same type)	[mm ²]	0.5 - 2.5
2 flexible conductors with a TWIN ferrule	[mm ²]	-
Max. cross section with insertion bridge	[mm ²]	6
General data		
Stripping length	[mm]	10
Screw thread		M4
Tightening torque	[Nm]	1.5 - 1.8
Insulating material		PA
Flammability rating in accordance with UL 94		V2

Technical data				
Width	Length	Height NS 15		
8.2	35	36		
I _{max} [A]	U _{max} [V]	max. Ø [mm ²]	AWG (UL)	
57	500	0.5 - 10	26-8	
IEC 60947-7-1				
IEC	UL / CUL	CSA	IEC/EN 60079-7	
500	600	300	275	
41 / 6	50 / -	50 / -	37 / 6	
6	-	-	0.5-6	
20 - 8	26-8	26-8	20 - 8	
Connection capacity		Ferrule		
Rigid	Flexible	without/with plastic sleeve		
0.5 - 10	0.5 - 6	0.25 - 6	0.25 - 6	
0.5 - 2.5	0.5 - 2.5	0.5 - 2.5	-	
-	-	-	0.5 - 2.5	
6	4	-	-	

Description	No. of pos.	Color
Terminal, for mounting on NS 15		gray
Ground terminal block, for mounting on NS 15		green-yellow

Ordering data			
Type	I _{max}	Order No.	Pcs./Pkt.
MBK 6/E		0552024	50

Accessories ¹⁾		
Cover, width: 1.5 mm		gray
Insertion bridge, fully insulated		
	2	gray
	3	gray
	4	gray
	10	gray
Fixed bridge, isolated		
	10	silver
Switching bridge for 2 terminal blocks, complete, mounted with short or long link in accordance with required separation		
	2	silver
Bridge bar isolator, as distance piece for isolator bridge bar		gray
Separating disk, for separation of neighboring bridges, can be fitted later, no loss of pitch		gray
Partition plate, for visual and electrical separation of terminal groups, 2.5 mm thick		gray
Test socket, for test connection with test plug PS		silver
Screwdriver		
Lateral groove labeling		

Accessories ¹⁾			
D-MBK 6/E		Order No.	Pcs./Pkt.
		1413049	50
EB 2- 8	43 A	0202154	100
EB 3- 8	43 A	0202141	100
EB 4- 8	43 A	0202142	100
EB 10- 8	43 A	0202138	10
FBI 10- 8	48 A	0203263	10
SB 2- 8/13	43 A	0202235	1
IS-K 10		1303337	100
TS-KK 3		2770215	50
ATP-MBK		1413227	50
PSB 4/7/6		0303299	10
SZS 1,0X4,0 VDE		1205066	10
ZB 8 (see Catalog 3)			

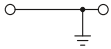
6 (10) mm², ground terminal block

Ex: EAC Ex IEC Ex
KEMA 01ATEX2134U / IECEx KEM 07.0008U

Technical data

Width	Length	Height NS 15	
8.2	39	36	
		max. Ø [mm ²]	AWG (UL)
		0.5 - 10	26-8
IEC 60947-7-2			
(Ex)			
IEC	UL / CUL	CSA	IEC/ EN 60079-7
-	-	-	-
- / -	-	- / -	- / 6
6	-	-	0.5-6
20 - 8	26-8	26-8	20 - 8
Rigid	Flexible	Ferrule	
without/with plastic sleeve			
0.5 - 10	0.5 - 6	0.5 - 6	0.5 - 6
0.5 - 2.5	0.2 - 2.5	0.5 - 1.5	-
-	-	-	0.5 - 2.5
-	-	-	-

10
M4
1.5 - 1.8
PA
V2

Ordering data

Type	Order No.	Pcs./Pkt.
MSLKG 6	1410505	50

Accessories¹⁾

SZS 1,0X4,0 VDE	1205066	10
ZB 8 (see Catalog 3)		

Terminal blocks – Classic

MT and MBK mini screw terminal blocks

Mini double-level terminal blocks MBKKB 2,5 ...

- The miniature double-level terminal block is characterized by its space-saving, low height and offset levels
- Fixed bridges and test sockets can be inserted on both levels

Notes:
1) For information on installation and using accessories for Ex applications, see page 678.

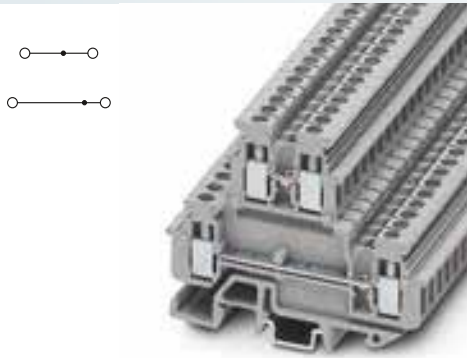

2.5 (4) mm², 24 A, double-level terminal block

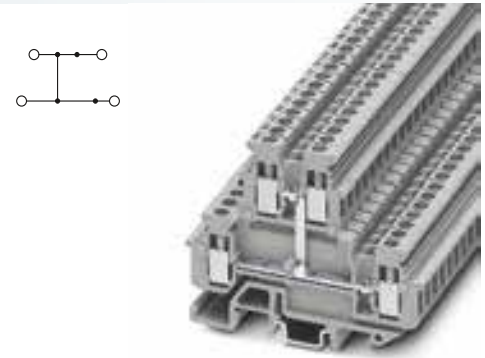

2.5 (4) mm², 24 A, double-level terminal block, internally connected levels

Ex: EAC Ex IEC EN UL CSA VDE TÜV KEMA

 KEMA 03ATEX2082 U / IECEx KEM 07.0018U

Dimensions		[mm]
Dimensions		[mm]
Maximum electrical data		
Rated data		
Rated voltage	[V]	500
Nominal current / cross section	[A] / [mm ²]	24 / 2.5
Rated cross section	[mm ²]	2.5
Cross section range	AWG	24 - 12
Connection capacity		
1 conductor	[mm ²]	0.2 - 4
2 conductors (of the same type)	[mm ²]	0.2 - 1.5
2 flexible conductors with a TWIN ferrule	[mm ²]	-
Max. cross section with insertion bridge	[mm ²]	2.5
General data		
Stripping length	[mm]	7
Screw thread		M3
Tightening torque	[Nm]	0.5 - 0.6
Insulating material		PA
Flammability rating in accordance with UL 94		V2

Technical data				
Width	Length	Height NS 35/7,5		
5.2	62	48		
Width	Length	Height NS 15		
5.2	62	47.5		
I _{max} [A]	U _{max} [V]	max. Ø [mm ²]	AWG (UL)	
24	500	0.2 - 4	30-12	
IEC 60947-7-1				
IEC	UL / CUL	CSA	IEC/ EN 60079-7	
500	300	300	275	
24 / 2.5	20 / -	20 / -	21 / 2.5	
2.5	-	-	0.2-2.5	
24 - 12	30-12	28-12	24 - 12	
Connection capacity				
Rigid	Flexible	Ferrule		
		without/with plastic sleeve		
0.2 - 4	0.2 - 2.5	0.25 - 2.5	0.25 - 1.5	
0.2 - 1.5	0.2 - 1.5	0.25 - 1.5	-	
-	-	-	0.5 - 1	
2.5	2.5	-	-	
General data				
Stripping length	[mm]	7		
Screw thread		M3		
Tightening torque	[Nm]	0.5 - 0.6		
Insulating material		PA		
Flammability rating in accordance with UL 94		V2		

Technical data				
Width	Length	Height NS 35/7,5		
5.2	62	48		
Width	Length	Height NS 15		
5.2	62	47.5		
I _{max} [A]	U _{max} [V]	max. Ø [mm ²]	AWG (UL)	
24	500	0.2 - 4	30-12	
IEC 60947-7-1				
IEC	UL / CUL	CSA	IEC/ EN 60079-7	
500	300	-	-	
24 / 2.5	20 / -	-	-	
2.5	-	-	-	
24 - 12	30-12	-	-	
Connection capacity				
Rigid	Flexible	Ferrule		
		without/with plastic sleeve		
0.2 - 4	0.2 - 2.5	0.25 - 2.5	0.25 - 1.5	
0.2 - 1.5	0.2 - 1.5	0.25 - 1.5	-	
-	-	-	0.5 - 1	
2.5	2.5	-	-	
General data				
Stripping length	[mm]	7		
Screw thread		M3		
Tightening torque	[Nm]	0.5 - 0.6		
Insulating material		PA		
Flammability rating in accordance with UL 94		V2		

Description	No. of pos.	Color
Double-level terminal block, with universal foot, for mounting on NS 15 or NS 35... in accordance with EN 60715		gray
		blue
		gray
Double-level terminal block, with universal foot, for mounting on NS 15 or NS 35... in accordance with EN 60715, with equipotential bonding between the levels		blue

Ordering data				
Type	I _{max}	Order No.	Pcs./Pkt.	
MBKKB 2,5		1414064	50	
MBKKB 2,5 BU		1414077	50	

Ordering data				
Type	I _{max}	Order No.	Pcs./Pkt.	
MBKKB 2,5-PV		2800583	50	
MBKKB 2,5-PV BU		1414132	50	

Accessories ¹⁾		
Cover, width: 5 mm	gray	
	blue	
Spacer plate, compensates for level offsets, width: 2.5 mm	gray	
Fixed bridge, isolated		
	2	silver
	3	silver
	4	silver
	10	silver
Insertion bridge, for 5.2 mm pitch, fully insulated		
	2	gray
	3	gray
	10	gray
Separating disk, for separation of neighboring bridges, can be fitted later, no loss of pitch		gray
Test socket		silver
Screwdriver		
Lateral groove labeling		

Accessories ¹⁾				
Type	I _{max}	Order No.	Pcs./Pkt.	
D-MBKKB 2,5		1413052	50	
D-MBKKB 2,5 BU		1413081	50	
DP-MBKKB 2,5		1413065	50	
FBRNI 2-5 N	22 A	3000175	10	
FBRNI 3-5 N	22 A	3000162	10	
FBRNI 4-5 N	22 A	3000159	10	
FBRNI 10-5 N	22 A	2770639	10	
EB 2- 5	20 A	1401158	100	
EB 3- 5	20 A	1401145	100	
EB 10- 5	20 A	1401132	10	
TS-KK 3 SO		2778534	50	
PSB 3/10/4		0601292	10	
SF-SL 0,6X3,5-100 S-VDE		1212587	10	
ZB 5 (see Catalog 3)				

Accessories ¹⁾				
Type	I _{max}	Order No.	Pcs./Pkt.	
D-MBKKB 2,5		1413052	50	
D-MBKKB 2,5 BU		1413081	50	
DP-MBKKB 2,5		1413065	50	
FBRNI 2-5 N	22 A	3000175	10	
FBRNI 3-5 N	22 A	3000162	10	
FBRNI 4-5 N	22 A	3000159	10	
FBRNI 10-5 N	22 A	2770639	10	
EB 2- 5	20 A	1401158	100	
EB 3- 5	20 A	1401145	100	
EB 10- 5	20 A	1401132	10	
TS-KK 3 SO		2778534	50	
PSB 3/10/4		0601292	10	
SF-SL 0,6X3,5-100 S-VDE		1212587	10	
ZB 5 (see Catalog 3)				

Mini double-level terminal blocks with diode, MBKKB 2,5...

- Thanks to the different versions of double-level diode terminal blocks, it is possible to carry out a great variety of switching tasks
- The following can be realized in tight spaces: Free-wheeling diode circuits, lamp test circuits, reporting and fault reporting circuits

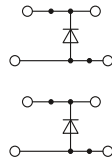

2.5 (4) mm², 24 A, double-level terminal block, with built-in 1N 4007 diode

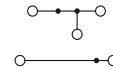

2.5 (4) mm², 24 A, double-level terminal block for soldering in components

Notes:

¹⁾ Data is based on the dielectric strength of adjacent terminal blocks or of the DIN rail.

²⁾ Integrated: Diode 1N 4007, reverse voltage: 1300 V, maximum continuous current: 0.5 A

ERC

ERC

Dimensions	
Dimensions	[mm]
Dimensions	[mm]
Maximum electrical data	
Rated data	
Rated voltage	[V]
Nominal current / cross section	[A] / [mm ²]
Rated cross section	[mm ²]
Cross section range	AWG
Connection capacity	
1 conductor	[mm ²]
2 conductors (of the same type)	[mm ²]
2 flexible conductors with a TWIN ferrule	[mm ²]
Max. cross section with insertion bridge	[mm ²]
General data	
Stripping length	[mm]
Screw thread	
Tightening torque	[Nm]
Insulating material	
Flammability rating in accordance with UL 94	

Technical data				
Width	Length	Height NS 35/7,5		
5.2	62	48		
Width	Length	Height NS 15		
5.2	62	47.5		
I _{max} [A]	U _{max} [V]	max. Ø [mm ²]	AWG (UL)	
24	500 ¹⁾	0.2 - 4	-	
IEC 60947-7-1	UL / CUL	CSA	IEC/ EN 60079-7	
IEC	UL / CUL	CSA	IEC/ EN 60079-7	
500 ¹⁾	-	-	-	
24 / 2.5	-	-	-	
2.5	-	-	-	
24 - 12	-	-	-	
Connection capacity	Rigid	Flexible	Ferrule without/with plastic sleeve	
1 conductor	0.2 - 4	0.2 - 2.5	0.25 - 2.5	0.25 - 2.5
2 conductors (of the same type)	0.2 - 1	0.2 - 1.5	0.25 - 1.5	-
2 flexible conductors with a TWIN ferrule	-	-	-	0.5 - 1.5
Max. cross section with insertion bridge	2.5	2.5	-	-
General data	7	M3	0.5 - 0.6	PA
Stripping length	[mm]			
Screw thread				
Tightening torque	[Nm]			
Insulating material				
Flammability rating in accordance with UL 94				

Technical data				
Width	Length	Height NS 35/7,5		
5.2	62	48		
Width	Length	Height NS 15		
5.2	62	47.5		
I _{max} [A]	U _{max} [V]	max. Ø [mm ²]	AWG (UL)	
24	500 ¹⁾	0.2 - 4	-	
IEC 60947-7-1	UL / CUL	CSA	IEC/ EN 60079-7	
IEC	UL / CUL	CSA	IEC/ EN 60079-7	
500 ¹⁾	-	-	-	
24 / 2.5	-	-	-	
2.5	-	-	-	
24 - 12	-	-	-	
Connection capacity	Rigid	Flexible	Ferrule without/with plastic sleeve	
1 conductor	0.2 - 4	0.2 - 2.5	0.25 - 2.5	0.25 - 2.5
2 conductors (of the same type)	0.2 - 1	0.2 - 1.5	0.25 - 1.5	-
2 flexible conductors with a TWIN ferrule	-	-	-	0.5 - 1.5
Max. cross section with insertion bridge	2.5	2.5	-	-
General data	7	M3	0.5 - 0.6	PA
Stripping length	[mm]			
Screw thread				
Tightening torque	[Nm]			
Insulating material				
Flammability rating in accordance with UL 94				

Description	No. of pos.	Color
Terminal block, with integrated diode, conducting from top to bottom ²⁾		gray
Terminal block, with integrated diode, conducting from bottom to top ²⁾		gray
Terminal block, component can be soldered in		gray

Ordering data				
Type	I _{max}	Order No.	Pcs./Pkt.	
MBKKB 2,5-DIO/O-U		2800567	50	
MBKKB 2,5-DIO/U-O		2800570	50	

Ordering data				
Type	I _{max}	Order No.	Pcs./Pkt.	
MBKKB 2,5-BE		1414103	50	

Accessories		
Cover, width: 5 mm	gray	
Spacer plate, compensates for level offsets, width: 2.5 mm	gray	
Fixed bridge, isolated		
	2	silver
	3	silver
	4	silver
	10	silver
Screwdriver		

Accessories				
D-MBKKB 2,5	DP-MBKKB 2,5	FBRNI 2-5 N	FBRNI 3-5 N	FBRNI 4-5 N
		22 A	22 A	22 A
		3000175	3000162	3000159
		2770639	1212587	

Accessories				
D-MBKKB 2,5	DP-MBKKB 2,5	FBRNI 2-5 N	FBRNI 3-5 N	FBRNI 4-5 N
		22 A	22 A	22 A
		3000175	3000162	3000159
		2770639	1212587	

Lateral groove labeling

ZB 5 (see Catalog 3)

ZB 5 (see Catalog 3)

Terminal blocks – Classic

OTTA bolt connection terminal blocks

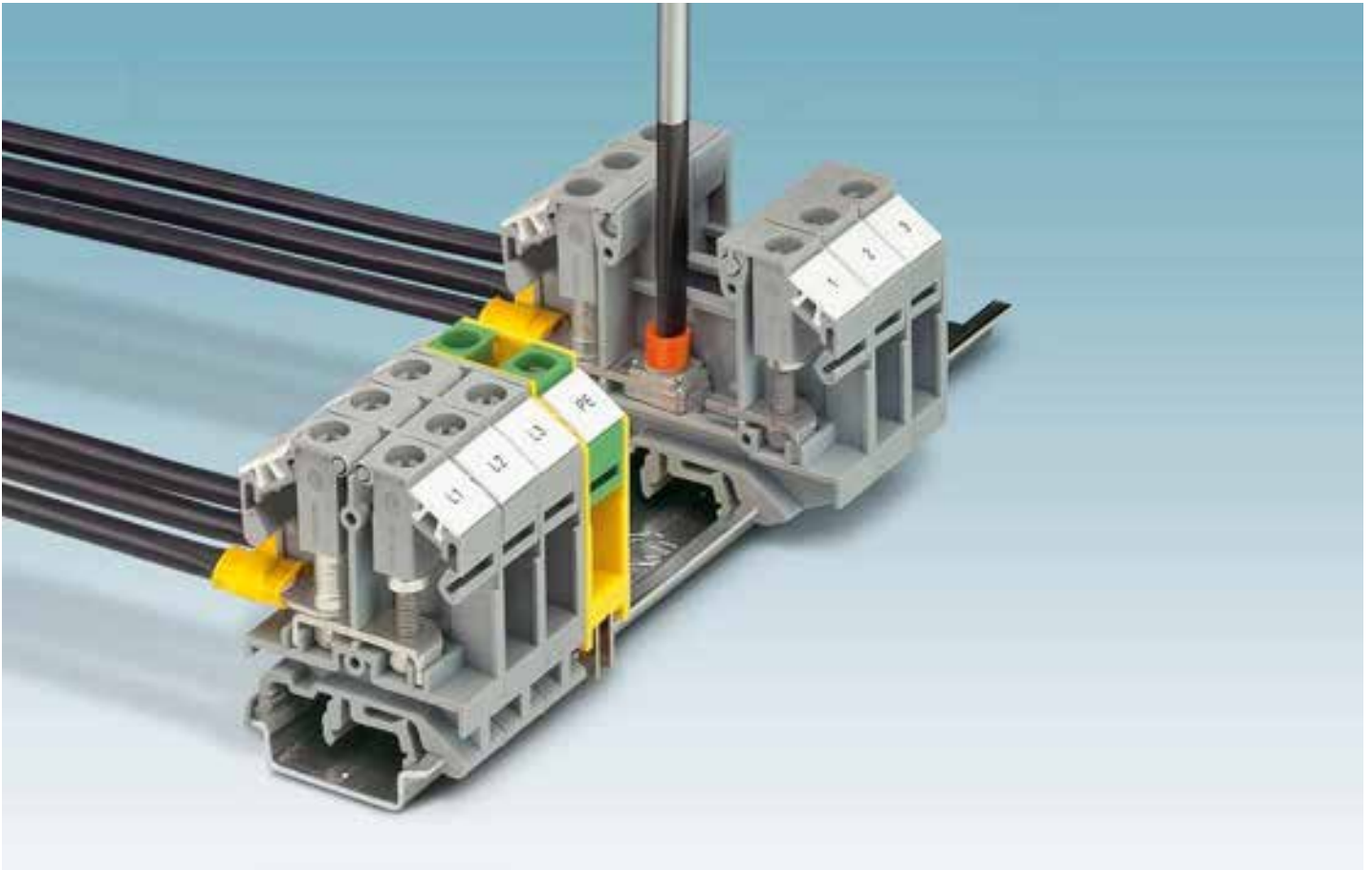

i Your web code: #1401



Space-saving design

Thanks to their compact type, OTTA bolt connection terminal blocks are ideally suited for switchgear, in which space is limited.



Fast, convenient conductor connection

The key feature of this range is the hinged cover which can be swiveled open and which features a captive cap nut. This guarantees quick and easy ring cable lug wiring.



Integrated shock protection

In addition to securing the cap nuts, the hinged cover offers simultaneous shock protection when using insulated ring cable lugs.

OTTA ... feed-through and ground terminal blocks

- Convenient and fast conductor connection with captive cap nuts
- Safe use, even in applications which are subject to the most stringent requirements regarding shock and vibration
- Space-saving, compact design
- Integrated screw locking

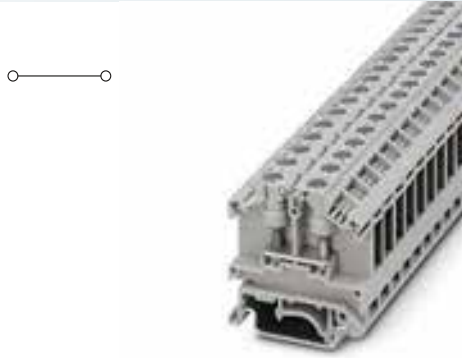

2.5 (2.5) mm², 24 A, feed-through terminal block

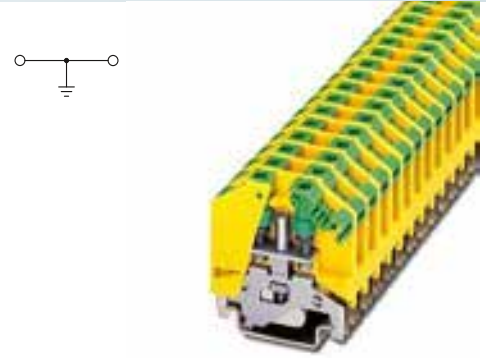

2.5 (2.5) mm², ground terminal block



Technical data

Dimensions	Width	Length	Height NS 35/7,5	
	9	43.5	45.5	
Dimensions	Width	Length	Height NS 32	
	9	43.5	50.5	
Maximum electrical data	I _{max.} [A]	U _{max.} [V]	max. Ø [mm ²]	AWG (UL)
	24	800	0.1 - 2.5	-
Rated data	IEC 60947-7-1	UL / CUL	CSA	IEC / EN 60079-7
Rated voltage [V]	800	600	600	-
Nominal current / cross section [A] / [mm ²]	24 / 2.5	20 / -	20 / -	-
Rated cross section [mm ²]	2.5	-	-	-
Cross section range AWG	26 - 14	-	22-14	-
Connection capacity, DIN 46234	0.1 - 2.5			
Cable lugs, DIN 46234 [mm ²]	3 / 3.2 / 7.6			
Connection bolt / hole diameter / width [mm]	1.50 mm ²			
Color code	blue			
Connection capacity, DIN 46237	0.5 - 2.5			
Cable lugs DIN 46237 [mm ²]	3 / 3.2 / 7.6			
General data	M3			
Screw thread	0.6 - 0.8			
Tightening torque [Nm]	PA			
Insulating material	V0			
Flammability rating in accordance with UL 94				

Ordering data

Description	No. of pos.	Color	Type	I _{max.}	Order No.	Pcs./Pkt.
Terminal block, for mounting on NS 35...		gray	OTTA 2,5		0790530	50
With test socket screws		gray	OTTA 2,5-P/P		0790543	50
Ground terminal block, for mounting on NS 35...		green-yellow				

Accessories

Cover, width: 1.5 mm	gray	D-OTTA 2,5		0790569	50
Insertion bridge		EB 2-OTTA 2,5	24 A	3026065	10
	2	EB 3-OTTA 2,5	24 A	3026078	10
	3	EB 4-OTTA 2,5	24 A	3026081	10
	4	EB 5-OTTA 2,5	24 A	3026094	10
	5	EB 6-OTTA 2,5	24 A	3026104	10
	6	EB 7-OTTA 2,5	24 A	3026117	10
	7	EB 10-OTTA 2,5	24 A	3026120	10
	10	ATP-OTTA 2,5		0790572	50
Partition plate, for visual and electrical separation of terminal groups, 1,5 mm thick	gray				
Screwdriver		SZS 0,6X3,5		1205053	10
Lateral groove labeling		ZB 8 (see Catalog 3)			



Technical data

Dimensions	Width	Length	Height NS 35/7,5	
	10	43.5	45.5	
Dimensions	Width	Length	Height NS 32	
	10	43.5	50.5	
Maximum electrical data	I _{max.} [A]	U _{max.} [V]	max. Ø [mm ²]	AWG (UL)
	24	800	0.1 - 2.5	-
Rated data	IEC 60947-7-2	UL / CUL	CSA	IEC / EN 60079-7
Rated voltage [V]	500	-	-	-
Nominal current / cross section [A] / [mm ²]	17.5 / -	-	- / -	-
Rated cross section [mm ²]	2.5	-	-	-
Cross section range AWG	26 - 14	-	22-14	-
Connection capacity, DIN 46234	0.1 - 2.5			
Cable lugs, DIN 46234 [mm ²]	3 / 3.2 / 7.6			
Connection bolt / hole diameter / width [mm]	1.50 mm ²			
Color code	2.50 mm ²			
Connection capacity, DIN 46237	0.5 - 2.5			
Cable lugs DIN 46237 [mm ²]	3 / 3.2 / 7.6			
General data	M3			
Screw thread	0.6 - 0.8			
Tightening torque [Nm]	PA			
Insulating material	V2			
Flammability rating in accordance with UL 94				

Ordering data

Description	No. of pos.	Color	Type	I _{max.}	Order No.	Pcs./Pkt.
Ground terminal block, for mounting on NS 35...		green-yellow	OTTA 2,5-PE		0790556	50

Accessories

Cover, width: 1.5 mm	gray	D-OTTA 2,5		0790569	50
Insertion bridge		EB 2-OTTA 2,5	24 A	3026065	10
	2	EB 3-OTTA 2,5	24 A	3026078	10
	3	EB 4-OTTA 2,5	24 A	3026081	10
	4	EB 5-OTTA 2,5	24 A	3026094	10
	5	EB 6-OTTA 2,5	24 A	3026104	10
	6	EB 7-OTTA 2,5	24 A	3026117	10
	7	EB 10-OTTA 2,5	24 A	3026120	10
	10	ATP-OTTA 2,5		0790572	50
Partition plate, for visual and electrical separation of terminal groups, 1,5 mm thick	gray				
Screwdriver		SZS 0,6X3,5		1205053	10
Lateral groove labeling		ZB 8 (see Catalog 3)			

Terminal blocks – Classic

OTTA bolt connection terminal blocks

OTTA ... feed-through and ground terminal blocks

- Convenient and fast conductor connection with captive cap nuts
- Safe use, even in applications which are subject to the most stringent requirements regarding shock and vibration
- Space-saving, compact design
- Integrated screw locking

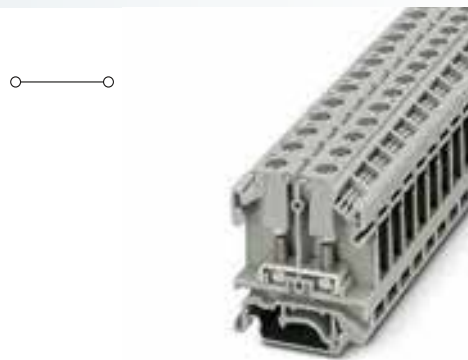

6 (6) mm², 41 A, feed-through terminal block



Dimensions	
	[mm]
Dimensions	
	[mm]
Maximum electrical data	
Rated data	
Rated voltage	[V]
Nominal current / cross section	[A] / [mm ²]
Rated cross section	[mm ²]
Cross section range	AWG
Connection capacity, DIN 46234	
Cable lugs, DIN 46234	[mm ²]
Connection bolt / hole diameter / width	[mm]
Color code	
	red
	blue
	yellow
Connection capacity, DIN 46237	
Cable lugs DIN 46237	[mm ²]
Connection bolt / hole diameter / width	[mm]
General data	
Screw thread	
Tightening torque	[Nm]
Insulating material	
Flammability rating in accordance with UL 94	

Technical data			
Width	Length	Height NS 35/7,5	
11	43.5	52	
Width	Length	Height NS 32	
11	43.5	57	
I _{max} [A]	U _{max} [V]	max. Ø [mm ²]	AWG (UL)
41	800	0.1 - 6	-
IEC 60947-7-1			
IEC	UL / CUL	CSA	IEC/EN 60079-7
800	600	600	-
41 / 6	30 / -	30 / -	-
6	-	-	-
26 - 10	-	22-10	-
Connection capacity, DIN 46234			
Cable lugs, DIN 46234	[mm ²]	0.1 - 6	
Connection bolt / hole diameter / width	[mm]	4 / 4.3 / 9.6	
Color code		red 1.50 mm ²	
		blue 2.50 mm ²	
		yellow 6.00 mm ²	
Connection capacity, DIN 46237			
Cable lugs DIN 46237	[mm ²]	0.5 - 2.5	
Connection bolt / hole diameter / width	[mm]	4 / 4.3 / 9.6	
General data			
Screw thread		M4	
Tightening torque	[Nm]	1.5 - 1.8	
Insulating material		PA	
Flammability rating in accordance with UL 94		V0	

Description	No. of pos.	Color
Terminal block , for mounting on NS 35...		gray
With test socket screws		gray
Ground terminal block , for mounting on NS 35...		green-yellow
Terminal block , for mounting on NS 35...		gray
with M6 screws		gray

Cover , width: 1.5 mm		gray
Cover , width: 2 mm		gray
Insertion bridge		
	2	gray
	3	gray
	4	gray
	5	gray
	7	gray
	10	gray
Partition plate , for visual and electrical separation of terminal groups, 1,5 mm thick		gray

Screwdriver		
Lateral groove labeling		

Ordering data			
Type	I _{max}	Order No.	Pcs./Pkt.
OTTA 6		0790433	50
OTTA 6-P/P		0790404	50

Accessories			
D-OTTA 6		0790417	50
EB 2-OTTA 6	41 A	0790608	10
EB 3-OTTA 6	41 A	3026036	10
EB 4-OTTA 6	41 A	3026049	10
EB 5-OTTA 6	41 A	3026050	10
EB 7-OTTA 6	41 A	3026052	10
EB 10- OTTA 6	41 A	0790420	10
ATP-OTTA 6		0790475	50
SZS 1,0X6,5 VDE		1205079	10
ZB 8 (see Catalog 3)			

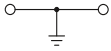
6 (6) mm², ground terminal block25 (25) mm², 101 A, feed-through terminal block

Technical data

Width	Length	Height NS 35/7,5	
12	43.5	52	
Width	Length	Height NS 32	
12	43.5	57	
I_{max} [A]	U_{max} [V]	max. Ø [mm ²]	AWG (UL)
41	800	0.1 - 6	-
IEC 60947-7-2			
IEC	UL / CUL	CSA	IEC/ EN 60079-7
800	600	-	-
41 / 6	-	- / -	-
6	-	-	-
26 - 10	-	22-10	-

0.1 - 6
4 / 4.3 / 9.6
1.50 mm²
2.50 mm²
6.00 mm²

0.5 - 2.5
4 / 4.3 / 9.6

M4
1.5 - 1.8
PA
V0

Technical data

Width	Length	Height NS 35/7,5	
18	60	64.5	
Width	Length	Height NS 32	
18	60	69.5	
I_{max} [A]	U_{max} [V]	max. Ø [mm ²]	AWG (UL)
101	800	0.1 - 25	-
IEC 60947-7-1			
IEC	UL / CUL	CSA	IEC/ EN 60079-7
800	-	600	-
101 / 25	- / -	100 / -	-
25	-	-	-
26 - 4	-	18-4	-

0.1 - 25
5 / 5.3 / 16

1 - 6
5 / 5.3 / 16

M5
2.5 - 3
PA
V0

Ordering data

Type	Order No.	Pcs./Pkt.
OTTA 6-PE	0790527	50

Accessories

EB 2-OTTA 6	0790608	10
EB 3-OTTA 6	3026036	10
EB 4-OTTA 6	3026049	10
EB 5-OTTA 6	3026050	10
EB 7-OTTA 6	3026052	10
EB 10- OTTA 6	0790420	10
SZS 1,0X6,5 VDE	1205079	10
ZB 8 (see Catalog 3)		

Ordering data

Type	Order No.	Pcs./Pkt.
OTTA 25-M5	0790488	50
OTTA 25-M6	0790491	50

Accessories

D-OTTA 25	0790514	50
ATP-OTTA 25	0790501	50
SZS 1,0X6,5 VDE	1205079	10
ZB 10 (see Catalog 3)		

OTTA bolt connection terminal blocks

OTTA 6-T ... test disconnect terminal blocks



- Easy and clear testing in measuring transducer secondary circuits can be performed using the OTTA 6-T... test disconnect terminal blocks
- Compact design
- Switching bridges with and without test sockets



6 (6) mm², 36 A, test disconnect terminal block



Dimensions		[mm]	
Dimensions			
Width	11	Length	69
Height NS 35/7,5	52	Height NS 32	57
Maximum electrical data			
I _{max} [A]	36	U _{max} [V]	800
IEC 60947-7-1		max. Ø [mm ²]	0.1 - 6
IEC		AWG (UL)	-
Rated data			
Rated voltage	[V]	800	600
Nominal current / cross section	[A] / [mm ²]	36 / 6	30 / -
Rated cross section	[mm ²]	6	-
Cross section range	AWG	26 - 10	-
CSA			22-10
IEC/EN 60079-7			-
Connection capacity, DIN 46234			
Cable lugs, DIN 46234	[mm ²]	0.1 - 6	
Connection bolt / hole diameter / width	[mm]	4 / 4.3 / 9.6	
Color code		red	1.50 mm ²
		blue	2.50 mm ²
		yellow	6.00 mm ²
Connection capacity, DIN 46237			
Cable lugs DIN 46237	[mm ²]	0.5 - 2.5	
Connection bolt / hole diameter / width	[mm]	4 / 4.3 / 9.6	
General data			
Terminal point: Thread / torque	- / [Nm]	M4 / 1.5 - 1.8	
Disconnect slide: Thread / torque	- / [Nm]	M4 / 0.6 - 0.8	
Insulating material		PA	
Flammability rating in accordance with UL 94		V0	

Technical data			
Width	Length	Height NS 35/7,5	
11	69	52	
Width	Length	Height NS 32	
11	69	57	
I _{max} [A]	U _{max} [V]	max. Ø [mm ²]	AWG (UL)
36	800	0.1 - 6	-
IEC 60947-7-1			
IEC	UL / CUL	CSA	IEC/EN 60079-7
800	600	600	-
36 / 6	30 / -	25 / -	-
6	-	-	-
26 - 10	-	22-10	-
Ordering data			
Type	I _{max}	Order No.	Pcs./Pkt.
OTTA 6-T		0790446	50
Accessories			
D-OTTA 6-T		0790459	50
EB 2-OTTA 6	36 A	0790608	10
EB 3-OTTA 6	36 A	3026036	10
EB 4-OTTA 6	36 A	3026049	10
EB 5-OTTA 6	36 A	3026050	10
EB 7-OTTA 6	36 A	3026052	10
EB 10- OTTA 6	36 A	0790420	10
S-OTTA 6-T		0311199	50
SZS 1,0X6,5 VDE		1205079	10
ZB 10 (see Catalog 3)			

Description	No. of pos.	Color
Disconnect terminal block, for mounting on NS 35...		gray
Disconnect terminal block, with test socket screws, for mounting on NS 35...		gray
Disconnect terminal block, with test socket screws, for accommodating switching bridges, for mounting on NS 35...		gray
Feed-through terminal block, with test socket screws, for accommodating switching bridges, for mounting on NS 35...		gray

Cover, width: 2 mm		gray
Insertion bridge		
	2	gray
	3	gray
	4	gray
	5	gray
	7	gray
	10	gray
Switching bridge		
	2	silver
Switching lock, plug-in		white
Screwdriver		
Lateral groove labeling		

OTTA bolt connection terminal blocks

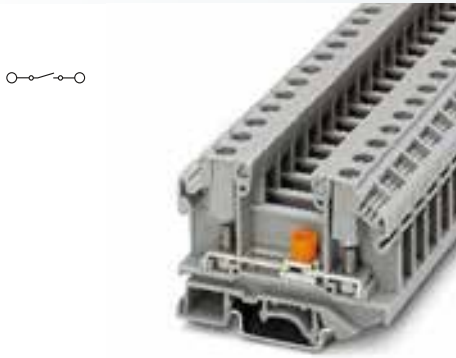

6 (6) mm², 36 A, test disconnect terminal block, with test socket screws

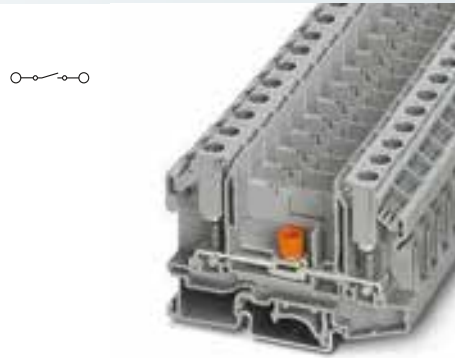

6 (6) mm², 41 A, test disconnect terminal block, with test socket screws, for accommodating switching bridges

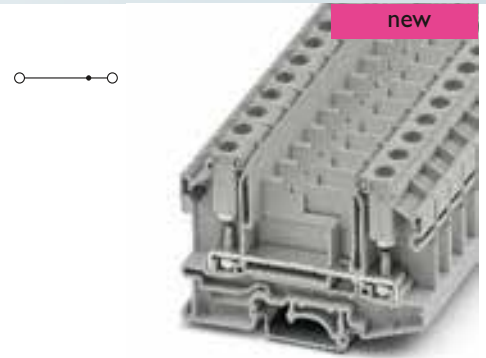

6 (6) mm², 41 A, feed-through terminal block, with test socket screws, for accommodating switching bridges



Technical data			
Width	Length	Height NS 35/7,5	
11	69	52	
Width	Length	Height NS 32	
11	69	57	
I_{max} [A]	U_{max} [V]	max. Ø [mm ²]	AWG (UL)
36	800	0.1 - 6	-
IEC 60947-7-1	UL / CUL	CSA	IEC/ EN 60079-7
800	600	600	-
36 / 6	30 / -	25 / -	-
6	-	-	-
26 - 10	-	22-10	-
0.1 - 6			
4 / 4.3 / 9.6			
1.50 mm ²			
2.50 mm ²			
6.00 mm ²			
0.5 - 2.5			
4 / 4.3 / 9.6			
M4 / 1.5 - 1.8			
M4 / 1.2 - 1.4			
PA			
V0			

Technical data			
Width	Length	Height NS 35/7,5	
11	79.2	52	
Width	Length	Height NS 32	
11	79.2	57	
I_{max} [A]	U_{max} [V]	max. Ø [mm ²]	AWG (UL)
41	1000	0.1 - 6	-
IEC 60947-7-1	UL / CUL	CSA	IEC/ EN 60079-7
1000	600	-	-
41 / 6	30 / -	-	-
6	-	-	-
26 - 10	-	-	-
0.1 - 6			
4 / 4.3 / 9.6			
1.50 mm ²			
2.50 mm ²			
6.00 mm ²			
0.5 - 2.5			
4 / 4.3 / 9.6			
M4 / 1.5 - 1.8			
M4 / 1.2 - 1.4			
PA			
V0			

Technical data			
Width	Length	Height NS 35/7,5	
11	79.2	52	
Width	Length	Height NS 32	
11	79.2	57	
I_{max} [A]	U_{max} [V]	max. Ø [mm ²]	AWG (UL)
41	1000	0.1 - 6	-
IEC 60947-7-1	UL / CUL	CSA	IEC/ EN 60079-7
1000	600	-	-
41 / 6	30	-	-
6	-	-	-
26 - 12	-	-	-
0.1 - 6			
4 / 4.3 / 9.6			
1.50 mm ²			
2.50 mm ²			
6.00 mm ²			
0.5 - 2.5			
4 / 4.3 / 9.6			
M4 / 1.5 - 1.8			
- / -			
PA			
V0			

Ordering data			
Type	I_{max}	Order No.	Pcs./Pkt.
OTTA 6-T-P/P		0790462	50

Ordering data			
Type	I_{max}	Order No.	Pcs./Pkt.
OTTA 6-T/SB-P/P		3001269	50

Ordering data			
Type		Order No.	Pcs./Pkt.
OTTAD 6/SB-P/P		1033182	50

Accessories			
D-OTTA 6-T		0790459	50
EB 2-OTTA 6	36 A	0790608	10
EB 3-OTTA 6	36 A	3026036	10
EB 4-OTTA 6	36 A	3026049	10
EB 5-OTTA 6	36 A	3026050	10
EB 7-OTTA 6	36 A	3026052	10
EB 10- OTTA 6	36 A	0790420	10
S-OTTA 6-T		0311199	50
SZS 1,0X6,5 VDE		1205079	10

Accessories			
D-OTTA/RBO-SB		3001355	50
EB 2-OTTA 6	36 A	0790608	10
EB 3-OTTA 6	36 A	3026036	10
EB 4-OTTA 6	36 A	3026049	10
EB 5-OTTA 6	36 A	3026050	10
EB 7-OTTA 6	36 A	3026052	10
EB 10- OTTA 6	36 A	0790420	10
USBR 2-11		3001356	50
SZS 1,0X6,5 VDE		1205079	10

Accessories			
D-OTTA/RBO-SB		3001355	50
EB 2-OTTA 6		0790608	10
EB 3-OTTA 6		3026036	10
EB 4-OTTA 6		3026049	10
EB 5-OTTA 6		3026050	10
EB 7-OTTA 6		3026052	10
EB 10- OTTA 6		0790420	10
USBR 2-11		3001356	50
SZS 1,0X6,5 VDE		1205079	10

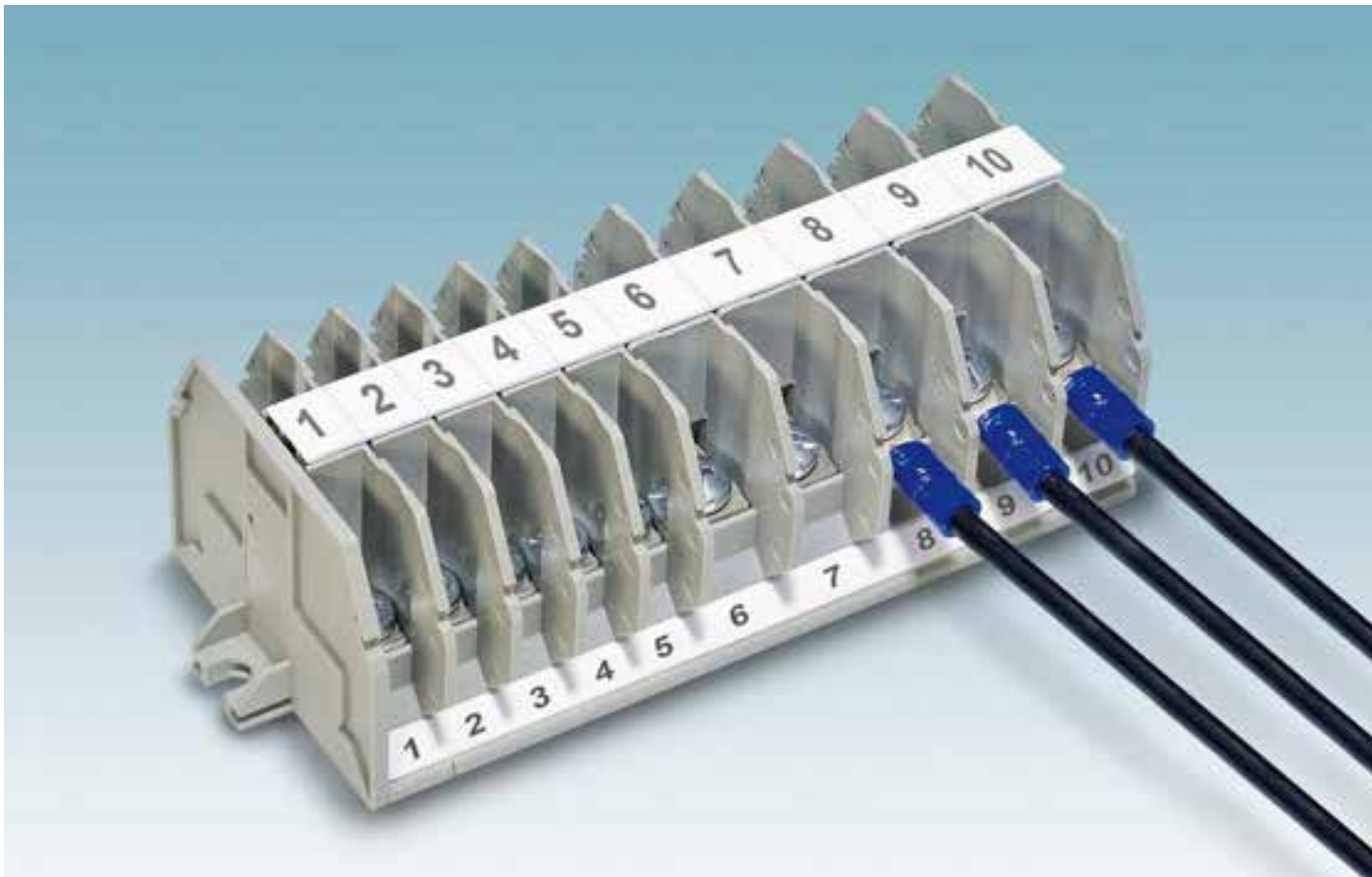

i Your web code: #1401



Extensive program

The RBO product range offers a suitable compact terminal block with bolt connection from M5 to M16 for every conductor connection from 0.5 - 300 mm²

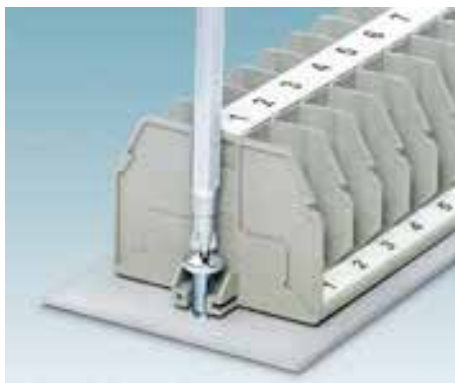

Flexible assembly

The bolt connection terminal blocks offer two mounting options:

- Can be snapped onto the conventional EN DIN rails
- Direct mounting on mounting plates



Modular shock protection

Using the extensive range of accessories, modular shock protection can be implemented easily and in accordance with application requirements.

RSC ... screw terminal blocks, for M4 and M5 ring and fork-type cable lugs

- Compact screw connection of ring and fork-type cable lugs
- Bridge shaft for potential distribution using standard screw bridges
- The isolator bridge bar supports switchable cross connections; the bridge screw therefore has the function of a live contact



4 (6) mm², 32 A, feed-through terminal block



4 (6) mm², 32 A, feed-through terminal block, for direct mounting

Notes:
 1) Rated voltage for 630 V open disconnect point



Dimensions		[mm]	
Dimensions			
Dimensions			
Dimensions			
Maximum electrical data			
Rated data			
Rated voltage	[V]	800	600
Nominal current / cross section	[A] / [mm²]	32 / 4	30 / -
Rated cross section	[mm²]	4	-
Cross section range	AWG	26 - 10	-
Connection capacity, DIN 46234			
Cable lugs, DIN 46234	[mm²]	0.1 - 6	
Connection bolt / hole diameter / width	[mm]	4 / 4.3 / 8	
Connection capacity, DIN 46237			
Cable lugs DIN 46237	[mm²]	0.5 - 2.5	
Connection bolt / hole diameter / width	[mm]	4 / 4.3 / 8	
Color code		red 1.00 mm²	
		blue 2.50 mm²	
		yellow	
General data			
Bolt thread		M4	
Tightening torque	[Nm]	1.2 - 1.4	
Insulating material		PA	
Flammability rating in accordance with UL 94		V0	

Technical data			
Width	Length	Height NS 35/7,5	
9	53.3	47.1	
Width	Length	Height NS 32	
9	53.3	52.1	
Width	Length	Height	
9	53.3	-	
I _{max} [A]	U _{max} [V]	max. Ø [mm²]	AWG (UL)
32	800	0.1 - 6	-
IEC 60947-7-1			
IEC	UL / CUL	CSA	IEC/ EN 60079-7

Technical data			
Width	Length	Height NS 35/7,5	
9	53.3	-	
Width	Length	Height NS 32	
9	53.3	-	
Width	Length	Height	
9	53.3	37	
I _{max} [A]	U _{max} [V]	max. Ø [mm²]	AWG (UL)
32	800 ¹⁾	0.1 - 6	-
IEC 60947-7-1			
IEC	UL / CUL	CSA	IEC/ EN 60079-7

Description	No. of pos.	Color
Bolt connection terminal , for mounting on NS 32... or NS 35...		gray
Bolt connection/flange terminal block , for direct mounting		gray
Block, 4-pos.		gray
Block, 6-pos.		gray
Block, 8-pos.		gray
Block, 12-pos.		gray

Ordering data			
Type	I _{max}	Order No.	Pcs./Pkt.
RSC 4		3058127	50

Ordering data			
Type	I _{max}	Order No.	Pcs./Pkt.
RSC 4-F		3058130	50
RSC 4-F/4		3059171	1
RSC 4-F/6		3059184	1
RSC 4-F/8		3059197	1
RSC 4-F/12		3059207	1

Cover, width: 2.2 mm	gray
Fixed bridge, isolated	
	10 silver
Isolator bridge bar, can be separated, with 10 screws	
	10 silver
Separating disk, for separation of neighboring bridges, can be fitted later, no loss of pitch	gray
Cover profile, supply length 1 m	transparent
Screwdriver	

Accessories			
D-RSC 5		3058020	50
FB 10-9	32 A	3059113	10
FB 10-9 ISO	24 A	3059650	10
TS-KK 3		2770215	50
AP RSC		3058017	10
SZS 1,0X6,5 VDE		1205079	10
SZK PH2 VDE		1205163	10

Accessories			
D-RSC 5-F		3059647	50
FB 10-9	32 A	3059113	10
FB 10-9 ISO	24 A	3059650	10
TS-KK 3		2770215	50
AP RSC		3058017	10
SZS 1,0X6,5 VDE		1205079	10
SZK PH2 VDE		1205163	10

Center groove labeling
Lateral groove labeling

ZB 9 (see Catalog 3)
ZBF 9 (see Catalog 3)

ZB 9 (see Catalog 3)
ZBF 9 (see Catalog 3)

Terminal blocks – Classic

RSC bolt connection terminal blocks

RSC ... screw terminal blocks, for M4 and M5 ring and fork-type cable lugs



- Compact screw connection of ring and fork-type cable lugs
- Bridge shaft for potential distribution using standard screw bridges
- The isolator bridge bar supports switchable cross connections; the bridge screw therefore has the function of a live contact
- Mounting on standard DIN rails or directly in control boxes
- Cover profile that can be snapped directly onto the terminal blocks provides touch-proof protection
- Large-surface, seamless external and center labeling
- Screw nuts and current bars are latched in the insulating housing and cannot be removed

Notes:

1) 57 A for continuous bridging, 41 A for bridging between non-adjacent terminal blocks



10 (10) mm², 57 A, feed-through terminal block



Technical data

Dimensions	Width [mm]	Length [mm]	Height NS 35/7,5 [mm]	
Dimensions	13	53.3	47.1	
Dimensions	13	53.3	52.1	
Dimensions	13	53.3	-	
Maximum electrical data	I_{max} [A]	U_{max} [V]	max. \varnothing [mm ²]	AWG (UL)
	57	800	0.1 - 10	-
Rated data	Rated voltage [V]	Nominal current / cross section [A] / [mm ²]	Rated cross section [mm ²]	Cross section range AWG
	800	57 / 10	10	26 - 8
Connection capacity, DIN 46234	Cable lugs, DIN 46234 [mm ²]	Connection bolt / hole diameter / width [mm]		
	0.1 - 10	5 / 5.3 / 10		
Connection capacity, DIN 46237	Cable lugs DIN 46237 [mm ²]	Connection bolt / hole diameter / width [mm]		
	0.5 - 6	5 / 5.3 / 10		
	Color code	red	1.00 mm ²	
		blue	2.50 mm ²	
		yellow	6.00 mm ²	
General data	Bolt thread	M5		
	Tightening torque [Nm]	2 - 2.2		
	Insulating material	PA		
	Flammability rating in accordance with UL 94	V0		

Ordering data

Description	No. of pos.	Color	Type	I_{max}	Order No.	Pcs./Pkt.
Bolt connection terminal , for mounting on NS 35...		gray	RSC 5		3058143	50
Bolt connection/flange terminal block , for direct mounting		gray				
Block, 4-pos.		gray				
Block, 6-pos.		gray				
Block, 8-pos.		gray				
Block, 12-pos.		gray				

Accessories

Cover , width: 2.2 mm		gray	D-RSC 5		3058020	50
Fixed bridge , isolated	10	silver	FB 10-13	57 A ¹⁾	3059126	10
Isolator bridge bar , can be separated, with 10 screws	10	silver	FB 10-13 ISO	24 A	3059663	10
Separating disk , for separation of neighboring bridges, can be fitted later, no loss of pitch		gray	TS-KK 3		2770215	50
Cover profile , supply length 1 m		transparent	AP RSC		3058017	10
Screwdriver			SZS 1,0X6,5 VDE		1205079	10
			SZK PH2 VDE		1205163	10

Center groove labeling	ZB 13 (see Catalog 3)
Lateral groove labeling	ZBF 13 (see Catalog 3)



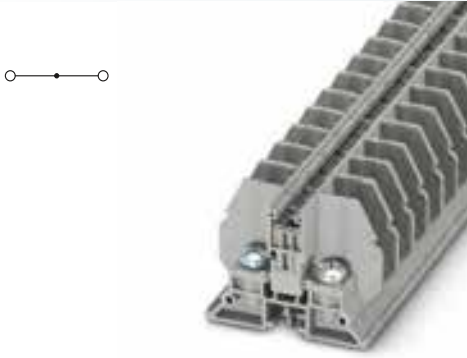

10 (10) mm², 57 A, feed-through terminal block,
for direct mounting



Technical data

Width	Length	Height NS 35/7,5	
13	53.3	-	
Width	Length	Height NS 32	
13	53.3	-	
Width	Length	Height	
13	53.3	37	
I _{max} [A]	U _{max} [V]	max. Ø [mm ²]	AWG (UL)
57	800	0.1 - 10	-
IEC 60947-7-1			
IEC	UL / CUL	CSA	IEC/ EN 60079-7
800	600	-	-
57 / 10	45 / -	-	-
10	-	-	-
26 - 8	-	-	-

0.1 - 10
5 / 5.3 / 10

0.5 - 6
5 / 5.3 / 10
1.00 mm²
2.50 mm²
6.00 mm²

M5
2 - 2.2
PA
V0

Ordering data

Type	I _{max}	Order No.	Pcs./Pkt.
RSC 5-F		3058156	50
RSC 5-F/4		3059210	1
RSC 5-F/6		3059223	1
RSC 5-F/8		3059236	1
RSC 5-F/12		3059249	1

Accessories

D-RSC 5-F		3059647	50
FB 10-13	57 A ¹⁾	3059126	10
FB 10-13 ISO	24 A	3059663	10
TS-KK 3		2770215	50
AP RSC		3058017	10
SZS 1,0X6,5 VDE		1205079	10
SZK PH2 VDE		1205163	10

ZB 13 (see Catalog 3)
ZBF 13 (see Catalog 3)

Terminal blocks – Classic

RSC bolt connection terminal blocks

Screw terminal blocks RSC 6 ..., M6 and measuring transducer disconnect terminal blocks RSC 5-T ..., M5

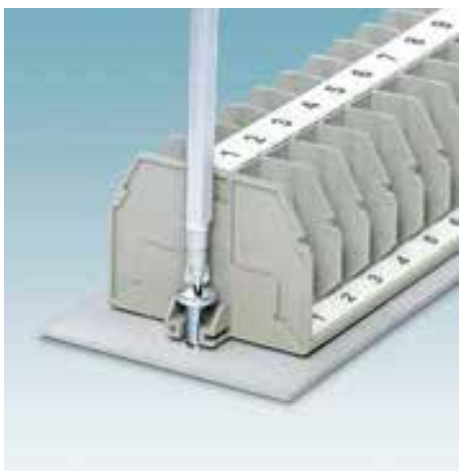

- Flange terminal blocks for direct mounting in control boxes
- Compact screw connection of ring and fork-type cable lugs
- Bridge shaft for potential distribution using standard screw bridges
- The isolator bridge bar supports switchable cross connections; the bridge screw therefore has the function of a live contact
- Cover profile that can be snapped directly onto the terminal blocks provides touch-proof protection
- Large-surface, seamless external and center labeling
- Screw nuts and current bars are latched in the insulating housing and cannot be removed
- Easy grouping of flange terminal blocks, see figure below



Notes:
1) 57 A for continuous bridging, 41 A for bridging between non-adjacent terminal blocks
2) Rated voltage for 630 V open disconnect point



35 (35) mm², 125 A, feed-through terminal block



Dimensions		[mm]
Dimensions		[mm]
Dimensions		[mm]
Maximum electrical data		
Rated data		
Rated voltage	[V]	800
Nominal current / cross section	[A] / [mm ²]	125 / 35
Rated cross section	[mm ²]	35
Cross section range	AWG	12 - 2
Connection capacity, DIN 46234		
Cable lugs, DIN 46234	[mm ²]	6 - 35
Connection bolt / hole diameter / width	[mm]	6 / 6.5 / 15
Connection capacity, DIN 46237		
Cable lugs DIN 46237	[mm ²]	2.5 - 6
Connection bolt / hole diameter / width	[mm]	6 / 6.5 / 11
Color code		red blue yellow
General data		
Disconnect slide: Thread / torque	- / [Nm]	- / -
Bolt thread		M6
Tightening torque	[Nm]	3.2 - 3.7
Insulating material		PA
Flammability rating in accordance with UL 94		V0

Technical data			
Width	Length	Height NS 35/7,5	
17	80.8	49.8	
Width	Length	Height NS 32	
17	80.8	54.8	
Width	Length	Height	
17	80.8	-	
I _{max} [A]	U _{max} [V]	max. Ø [mm ²]	AWG (UL)
125	800	2.5 - 35	-
IEC 60947-7-1			
IEC	UL / CUL	CSA	IEC / EN 60079-7

Description	No. of pos.	Color
Bolt connection terminal, for mounting on NS 32... or NS 35...		gray
Bolt connection/flange terminal block, for direct mounting		gray
Test disconnect terminal block, for mounting on NS 35 and NS 32		gray
Test disconnect terminal block, with flange, for direct mounting		gray

Ordering data			
Type	I _{max}	Order No.	Pcs./Pkt.
RSC 6		3075870	40

Cover, width: 2.2 mm		gray
Fixed bridge, isolated		
Isolator bridge bar, can be separated, with 10 screws	10	silver
Separating disk, for separation of neighboring bridges, can be fitted later, no loss of pitch	10	silver
Cover profile, supply length 1 m		transparent
Screwdriver		

Accessories			
Type	I _{max}	Order No.	Pcs./Pkt.
D-RSC 6		3213098	50
FB 10-17	57 A	3075951	10
FB 10-17 ISO	57 A	3213085	10
TS-KK 3		2770215	50
AP RSC-T		3059139	10

Center groove labeling	ZB 17 (see Catalog 3)
Lateral groove labeling	ZBF 17 (see Catalog 3)

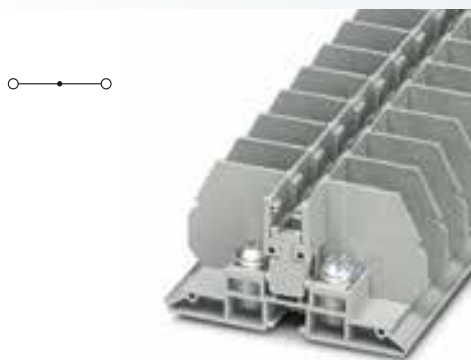

35 (35) mm², 125 A, feed-through terminal block, for direct mounting

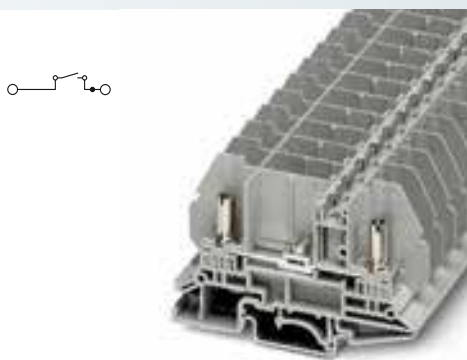

10 (10) mm², 50 A, test disconnect terminal block

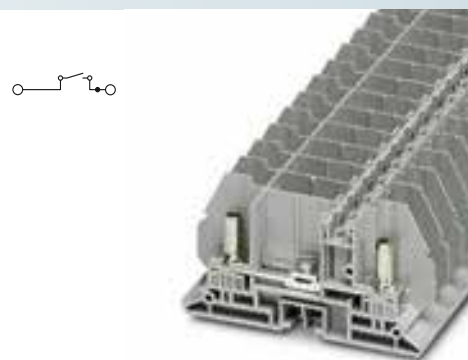

10 (10) mm², 50 A, test disconnect terminal block



Technical data			
Width	Length	Height NS 35/7,5	
17	80.8	-	
Width	Length	Height NS 32	
17	80.8	-	
Width	Length	Height	
17	80.8	39.7	
I _{max} [A]	U _{max} [V]	max. Ø [mm ²]	AWG (UL)
125	800	2.5 - 35	-
IEC 60947-7-1			
IEC	UL / CUL	CSA	IEC/ EN 60079-7
800	600	600	-
125 / 35	115 / -	115 / -	-
35	-	-	-
12 - 2	-	12-2	-
6 - 35			
6 / 6.5 / 15			
2.5 - 6			
6 / 6.5 / 11			
2.50 mm ²			
6.00 mm ²			
- / -			
M6			
3.2 - 3.7			
PA			
V0			

Technical data			
Width	Length	Height NS 35/7,5	
13	79.9	49.8	
Width	Length	Height NS 32	
13	79.9	54.8	
Width	Length	Height	
13	79.9	-	
I _{max} [A]	U _{max} [V]	max. Ø [mm ²]	AWG (UL)
50	800 ²⁾	0.1 - 10	-
IEC 60947-7-1			
IEC	UL / CUL	CSA	IEC/ EN 60079-7
800 ²⁾	600	-	-
50 / 10	45 / -	-	-
10	-	-	-
26 - 8	-	-	-
0.1 - 10			
5 / 5.3 / 10			
0.5 - 6			
5 / 5.3 / 10			
1.00 mm ²			
2.50 mm ²			
6.00 mm ²			
M4 / 1.2 - 1.4			
M5			
2 - 2.2			
PA			
V0			

Technical data			
Width	Length	Height NS 35/7,5	
13	79.9	-	
Width	Length	Height NS 32	
13	79.9	-	
Width	Length	Height	
13	79.9	39.7	
I _{max} [A]	U _{max} [V]	max. Ø [mm ²]	AWG (UL)
50	800 ²⁾	0.1 - 10	-
IEC 60947-7-1			
IEC	UL / CUL	CSA	IEC/ EN 60079-7
800 ²⁾	600	-	-
50 / 10	45 / -	-	-
10	-	-	-
26 - 8	-	-	-
0.1 - 10			
5 / 5.3 / 10			
0.5 - 6			
5 / 5.3 / 10			
1.00 mm ²			
2.50 mm ²			
6.00 mm ²			
M4 / 1.2 - 1.4			
M5			
2 - 2.2			
PA			
V0			

Ordering data			
Type	I _{max}	Order No.	Pcs./Pkt.
RSC 6-F		3075919	40

Ordering data			
Type	I _{max}	Order No.	Pcs./Pkt.
RSC 5-T		3058172	50

Ordering data			
Type	I _{max}	Order No.	Pcs./Pkt.
RSC 5-T-F		3058334	50

Accessories			
D-RSC 6-F		3213108	50
FB 10-17	57 A	3075951	10
FB 10-17 ISO	57 A	3213085	10
TS-KK 3		2770215	50
AP RSC-T		3059139	10

Accessories			
D-RSC 5-T		3058046	50
FB 10-13	57 A ¹⁾	3059126	10
FB 10-13 ISO	24 A	3059663	10
TS-KK 3		2770215	50
AP RSC-T		3059139	10
SZG 0,9X6,5 VDE		1205134	10

Accessories			
D-RSC 5-T-F		3059346	50
FB 10-13	57 A ¹⁾	3059126	10
FB 10-13 ISO	24 A	3059663	10
TS-KK 3		2770215	50
AP RSC-T		3059139	10
SZG 0,9X6,5 VDE		1205134	10

ZB 17 (see Catalog 3)
ZBF 17 (see Catalog 3)

ZB 13 (see Catalog 3)
ZBF 13 (see Catalog 3)

ZB 13 (see Catalog 3)
ZBF 13 (see Catalog 3)

Terminal blocks – Classic

UHV high-current connectors

High-current connectors UHV ...

- The high-current connectors UHV ... are available in several versions
- Versions are available with a cable lug or direct connection and there is a mixed version of both connection types
- The comprehensive range of accessories ensures safe and user-friendly wiring of conductors up to 240 mm²

Notes:
 In the case of UHV 240..., the BG/F flat bracket must be mounted.
 Further technical notes and connection conditions are to be found on page 682.



25 (25) mm², 101 A, feed-through terminal block

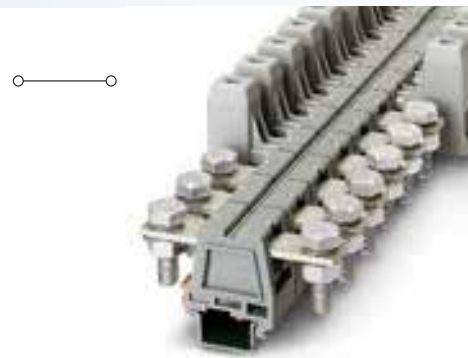

50 (50) mm², 150 A, feed-through terminal block



Dimensions [mm]

Maximum electrical data

Rated data

Rated voltage [V]	1000
Nominal current / cross section [A] / [mm ²]	101 / 25
Rated cross section [mm ²]	25
Cross section range AWG	-

Terminal sleeve connection capacity

1 conductor [mm ²]	10 - 25
2 conductors (of the same type) [mm ²]	2.5 - 10

Connection capacity, bolt connection

Bolt diameter [mm]	8 mm
Hole diameter / power rail [mm]	8.4 / 15 mm x 3 mm
Cable lugs, DIN 46234 [mm ²]	2.5 - 25
Cable lugs DIN 46235 [mm ²]	16 - 25

General data

Stripping length [mm]	21
Terminal sleeve: Thread / torque - / [Nm]	M8 / 15 - 20
Screw set AS: Screw thread / torque - / [Nm]	M8 / 15 - 20

Insulating material	PA-F
Flammability rating in accordance with UL 94	V0

Technical data

Width	Length	Height NS 35/15	
26	95	72	
I _{max} [A]	U _{max} [V]	max. Ø [mm ²]	AWG (UL)
101	1000	10 - 25	6-4
IEC 60947-7-1			
IEC	UL / CUL	CSA	IEC/ EN 60079-7
1000	600	600	-
150 / 50	150 / -	100 / -	-
50	-	-	-
-	6-1/0	6-1/0	-
Rigid Flexible Ferrule without/with plastic sleeve			
10 - 25	10 - 25	10 - 25	
2.5 - 10	4 - 10	2.5 - 10	-

Technical data

Width	Length	Height NS 35/15	
32	104	78	
I _{max} [A]	U _{max} [V]	max. Ø [mm ²]	AWG (UL)
150	1000	25 - 50	6
IEC 60947-7-1			
IEC	UL / CUL	CSA	IEC/ EN 60079-7
1000	600	600	-
150 / 50	150 / -	125 / -	-
50	-	-	-
-	6-1/0	6-1/0	-
Rigid Flexible Ferrule without/with plastic sleeve			
25 - 50	25 - 50	50	25 - 50
10 - 16	10 - 16	10 - 16	-

Ordering data

Description	No. of pos.	Color
High current connector, with terminal sleeve KH on one side, and screw set AS on the other side		gray
High current connector, screw set AS on both sides, for rail or cable lug connection		gray
High current connector, with terminal sleeves KH on both sides, for direct cable connection		gray

Ordering data

Type	Order No.	Pcs./Pkt.
UHV 25-KH/AS	2130101	10
UHV 25-AS/AS	2130004	10
UHV 25-KH/KH	2130156	10

Ordering data

Type	Order No.	Pcs./Pkt.
UHV 50-KH/AS	2130114	10
UHV 50-AS/AS	2130017	10
UHV 50-KH/KH	2130169	10

Covering hood, as retrofit snap-on shock protection for cable lug connection

Connection rail, for cross connection

Separating plate

Insertion profile, levels out the prism-shaped sleeve when using flat-ribbon conductors

End piece, to be fitted at both sides of the terminal strip, 7.2 mm wide

Screwdriver

T-handle screwdriver, for Allen screws, ergonomically shaped handle, matt chrome-plated

Accessories

Type	Order No.	Pcs./Pkt.
UHV 25-AH	2130431	10
UHV 25-VS 2	2130541	10
UHV 25-VS 3	2130554	10
UHV -TP1	2130402	10
UHV -E	2130428	10
SZS 1,0X6,5 VDE	1205079	10

Accessories

Type	Order No.	Pcs./Pkt.
UHV 50-AH	2130444	10
UHV 50-VS 2	5030897	10
UHV 50-VS 3	2130622	10
UHV -TP1	2130402	10
UKH 50 EP	3009228	10
UHV -E	2130428	10
SZS 1,2X8,0 VDE	1205082	10

Center groove labeling

UC-TM 10 (see Catalog 3)

UC-TM 10 (see Catalog 3)



95 (95) mm², 232 A, feed-through terminal block



150 (150) mm², 309 A, feed-through terminal block



240 (240) mm², 415 A, feed-through terminal block



Technical data			
Width	Length	Height NS 35/15	
40	114	86	
I_{max} [A]	U_{max} [V]	max. Ø [mm ²]	AWG (UL)
232	1000	35 - 95	2
IEC 60947-7-1			
IEC	UL / CUL	CSA	IEC/EN 60079-7
1000	600	600	-
232 / 95	230 / -	200 / -	-
95	-	-	-
-	2-4/0	2-4/0	-
Rigid	Flexible	Ferrule without/with plastic sleeve	
35 - 95	35 - 95	95	35 - 95
-	-	16 - 35	-
12 mm			
13 / 30 mm x 5 mm			
10 - 95			
25 - 95			
29			
M12 / 25 - 30			
M12 / 25 - 30			
PA-F			
V0			

Technical data			
Width	Length	Height NS 35/15	
46	119	100	
I_{max} [A]	U_{max} [V]	max. Ø [mm ²]	AWG (UL)
309	1000	50 - 150	2-300
IEC 60947-7-1			
IEC	UL / CUL	CSA	IEC/EN 60079-7
1000	600	600	-
309 / 150	285 / -	275 / -	-
150	-	-	-
-	2-300	2-300	-
Rigid	Flexible	Ferrule without/with plastic sleeve	
50 - 150	50 - 150	150	50 - 150
25 - 50	35 - 50	25 - 50	-
12 mm			
13 / 35 mm x 5 mm			
10 - 150			
25 - 150			
34			
M12 / 25 - 30			
M12 / 25 - 30			
PA-F			
V2			

Technical data			
Width	Length	Height NS 35/15	
53	126.5	105.5	
I_{max} [A]	U_{max} [V]	max. Ø [mm ²]	AWG (UL)
415	1000	70 - 240	500
IEC 60947-7-1			
IEC	UL / CUL	CSA	IEC/EN 60079-7
1000	600	600	-
415 / 240	380 / -	400 / -	-
240	-	-	-
-	2/0-500	1/0-500	-
Rigid	Flexible	Ferrule without/with plastic sleeve	
70 - 240	70 - 240	185	70 - 185
35 - 95	50 - 95	35 - 50	-
16 mm			
17 / 40 mm x 5 mm			
25 - 240			
50 - 240			
34			
M16 / 30 - 35			
M16 / 30 - 35			
PA-F			
V2			

Ordering data		
Type	Order No.	Pcs./Pkt.
UHV 95-KH/AS	2130127	10
UHV 95-AS/AS	2130020	10
UHV 95-KH/KH	2130172	10

Ordering data		
Type	Order No.	Pcs./Pkt.
UHV150-KH/AS	2130130	10
UHV150-AS/AS	2130033	10
UHV150-KH/KH	2130185	10

Ordering data		
Type	Order No.	Pcs./Pkt.
UHV240-KH/AS	2130143	5
UHV240-AS/AS	2130046	5
UHV240-KH/KH	2130198	5

Accessories		
UHV 95-AH	2130457	10
UHV 95-VS 2	2130635	10
UHV 95-VS 3	2130648	10
UHV -TP2	2130415	10
UKH 95 EP	3009231	10
UHV -E	2130428	10
SF-THEX 8-200	1212643	5

Accessories		
UHV150-AH	2130460	10
UHV150-VS 2	2130651	10
UHV150-VS 3	2130664	10
UHV -TP2	2130415	10
UKH 150/240 EP	3009244	10
UHV -E	2130428	10
SF-THEX 8-200	1212643	5

Accessories		
UHV240-AH	2130473	10
UHV240-VS 2	2130677	10
UHV240-VS 3	2130680	10
UHV -TP2	2130415	10
UKH 150/240 EP	3009244	10
UHV -E	2130428	10
SF-THEX 8-200	1212643	5

UC-TM 10 (see Catalog 3)

UC-TM 10 (see Catalog 3)

UC-TM 10 (see Catalog 3)

Terminal blocks – Classic

G device terminal blocks

Device terminal blocks



i Your web code: #1404



For direct rail-free use

Compact device terminal blocks fitted free of rails are mainly used in network connections for electric and electronic equipment and in small terminal boxes.



Safe conductor connection

The device terminal blocks are designed for very stringent requirements. The screw connection familiar from standard modular terminal blocks offers:

- Maintenance-free conductor connection
- Simple multiple conductor connection
- Conductor connection with or without ferrule



Extensive program

The device terminal block range is available up to a nominal cross section of 35 mm² and 125 A with various numbers of positions. The terminal blocks are clearly and easily identified with the marking material.

G 5 and G 10 device terminal blocks for direct mounting

- Finger protection
- The housing ribs engage with one another below on both sides for simple attachment
- Mounting with two screws per block (apart from the 2-pos. version)

Notes:

For drawings and dimensions, visit phoenixcontact.net/products



4 (4) mm², 32 A, terminal block base, multi-position



10 (16) mm², 76 A, terminal block base, multi-position



Technical data

Dimensions	Technical data			
	Width	Length	Height	
	20	22	24	
Maximum electrical data	I_{max} [A]	U_{max} [V]	max. Ø [mm ²]	AWG (UL)
	32	500	0.2 - 4	26-10
Rated data	IEC 60947-7-1/IEC 60998			
	IEC	UL / CUL	CSA	IEC/EN 60079-7
Rated voltage [V]	500	300	300	-
Nominal current / cross section [A] / [mm ²]	32 / 4	30 / -	30 / -	-
Rated cross section [mm ²]	4	-	-	-
Cross section range AWG	24 - 12	26-10	26-10	-
Connection capacity	Rigid	Flexible	Ferrule without/with plastic sleeve	
	1 conductor [mm ²]	0.2 - 4	0.2 - 4	0.25 - 4
2 conductors (of the same type) [mm ²]	0.2 - 1.5	0.2 - 1.5	0.25 - 1.5	-
2 flexible conductors with a TWIN ferrule [mm ²]	-	-	-	0.5 - 1
General data	Stripping length [mm]	8		
	Screw thread	M3		
	Tightening torque [Nm]	0.6 - 0.8		
	Insulating material	PA		
	Flammability rating in accordance with UL 94	V0		

Ordering data

Description	Color	Type	Order No.	Pcs./Pkt.
Device terminal block, for direct mounting, 2-pos.	gray	G 5/2	2716020	50
3-pos.	gray	G 5/3	2716033	50
4-pos.	gray	G 5/4	2716046	50
5-pos.	gray	G 5/6	2716062	50
6-pos.	gray	G 5/12	2716127	50
12-pos.	gray	G 5/2 B	2716305	50
Device terminal block, for direct mounting, bridged, 2-pos.	orange			

Accessories

Warning label	Color	Accessories	Order No.	Pcs./Pkt.
	yellow	WS-G5/3	2720032	10
	yellow	WS-G5/4	2716499	10
Marker pin, unprinted, made of plastic, for individual labeling with B-STIFT or X-PEN	white	BN WH	1401404	100
Screwdriver		SF-SL 0,6X3,5-100 S-VDE	1212587	10

Technical data

Dimensions	Technical data			
	Width	Length	Height	
	29	33	31	
Maximum electrical data	I_{max} [A]	U_{max} [V]	max. Ø [mm ²]	AWG (UL)
	76	800	0.5 - 16	24-6
Rated data	IEC 60947-7-1/IEC 60998			
	IEC	UL / CUL	CSA	IEC/EN 60079-7
Rated voltage [V]	800	600	600	-
Nominal current / cross section [A] / [mm ²]	57 / 10	65 / -	65 / -	-
Rated cross section [mm ²]	10	-	-	-
Cross section range AWG	20 - 6	24-6	24-6	-
Connection capacity	Rigid	Flexible	Ferrule without/with plastic sleeve	
	0.5 - 16	0.5 - 10	0.5 - 16	0.5 - 16
0.5 - 6	0.5 - 6	0.5 - 6	-	
-	-	-	0.5 - 6	
General data	Stripping length [mm]	12		
	Screw thread	M4		
	Tightening torque [Nm]	1.5 - 1.8		
	Insulating material	PA		
	Flammability rating in accordance with UL 94	V2		

Ordering data

Description	Color	Type	Order No.	Pcs./Pkt.
Device terminal block, for direct mounting, 2-pos.	gray	G 10/2	2716703	10
3-pos.	gray	G 10/3	2716716	10
4-pos.	gray	G 10/4	2716729	10
5-pos.	gray	G 10/5	2716732	10

Accessories

Warning label	Color	Accessories	Order No.	Pcs./Pkt.
	yellow	BN WH	1401404	100
	yellow	SZS 1,0X4,0 VDE	1205066	10

Terminal blocks – Classic

G device terminal blocks

Device terminal blocks for direct mounting GE 35...

- Finger protection
- Mounting with two screws per block
- Large-surface marking options on terminal points



35 (35) mm², 125 A, terminal block base, 2-pos.

ERC

Dimensions	
	[mm]
Maximum electrical data	
Rated data	
Rated voltage	[V]
Nominal current / cross section	[A] / [mm ²]
Rated cross section	[mm ²]
Cross section range	AWG
Connection capacity	
1 conductor	[mm ²]
2 conductors (of the same type)	[mm ²]
2 flexible conductors with a TWIN ferrule	[mm ²]
General data	
Stripping length	[mm]
Screw thread	
Tightening torque	[Nm]
Insulating material	
Flammability rating in accordance with UL 94	

Technical data				
Width	Length	Height		
34.8	83.7	44.9		
I _{max.} [A]	U _{max.} [V]	max. Ø [mm ²]	AWG (UL)	
125	630	0.75 - 35	-	
IEC 60947-7-1/IEC 60998				
IEC	UL / CUL	CSA	IEC/EN 60079-7	
Rated voltage	630	-	-	-
Nominal current / cross section	125 / 35	-	-	-
Rated cross section	35	-	-	-
Cross section range	18 - 2	-	-	-
Connection capacity		Rigid	Flexible	Ferrule without/with plastic sleeve
1 conductor	0.75 - 35	0.75 - 35	0.75 - 35	0.75 - 35
2 conductors (of the same type)	0.75 - 10	0.75 - 10	0.75 - 10	-
2 flexible conductors with a TWIN ferrule	-	-	-	0.75 - 6

Description	Color
Device terminal block, for direct mounting, 2-pos.	blue
Device terminal block, for direct mounting, bridged, 2-pos.	blue

Ordering data		
Type	Order No.	Pcs./Pkt.
GE 35/2 BU	3071078	25

Screwdriver
Lateral groove labeling

Accessories		
SZS 1,0X4,0 VDE	1205066	10
UC-TM 12, UCT-TM 12 or ZB 12 (see Catalog 3)		



**35 (35) mm², 125 A, terminal block base,
2-pos., internally connected**

ERIC

Technical data

Width	Length	Height	
34.8	83.7	44.9	
I_{max} [A]	U_{max} [V]	max. Ø [mm ²]	AWG (UL)
125	630	0.75 - 35	-
IEC 60947-7-1/IEC 60998			
IEC	UL / CUL	CSA	IEC/ EN 60079-7
630	-	-	-
125 / 35	-	-	-
35	-	-	-
18 - 2	-	-	-
Rigid	Flexible	Ferrule without/with plastic sleeve	
0.75 - 35	0.75 - 35	0.75 - 35	0.75 - 35
0.75 - 10	0.75 - 10	0.75 - 10	-
-	-	-	0.75 - 6

16
M6
3.5 - 4
PA
V2

Ordering data

Type	Order No.	Pcs./Pkt.
GE 35/2-B BU	2701570	25

Accessories

SZS 1,0X4,0 VDE	1205066	10
UC-TM 12, UCT-TM 12 or ZB 12 (see Catalog 3)		

Terminal blocks – Classic

UDB trunk line branch terminal blocks

UDB ... trunk line branch terminal blocks



- The branch terminal blocks from the UDB ... series are suitable for the simple voltage pick-off of main supply cables up to 35 mm²
- The UDB ... blocks are used in counter and marshalling cabinets
- They meet the requirements of DIN VDE 0603-2/EN 60998-1
- The touch-proof blocks can be snapped together in a modular fashion depending on the application and attached to NS 35 DIN rails in accordance with EN 60715
- Available in two terminal block versions up to 25 mm² or up to 35 mm²
- Available in the five current conductor colors, e.g., for three-phase cables



25 (25) mm², 101 A, trunk line branch terminal block, 2x16 mm² feeders

ERC

Dimensions				
		[mm]		
Maximum electrical data				
Rated data				
Rated voltage		[V]	400	-
Nominal current / cross section		[A] / [mm ²]	101 / 25	- / -
Rated cross section		[mm ²]	25	-
Cross section range		AWG	8 - 2	-
Supply connection capacity			Rigid	Flexible
1 conductor		[mm ²]	1.5 - 25	10 - 25
Branch connection capacity			Rigid	Flexible
1 conductor		[mm ²]	1.5 - 16	-
General data				
Stripping length		[mm]	16	
Insulating material			PA	
Flammability rating in accordance with UL 94			V0	

Technical data				
Width	Length	Height NS 35/7,5		
23	46	42		
I _{max} [A]	U _{max} [V]	max. Ø [mm ²]	AWG (UL)	
101	400	1.5 - 25	-	
IEC 60998-1				
IEC	UL	CSA	IEC/EN 60079-7	
Ferrule				
without/with plastic sleeve				
1 conductor		1.5 - 16	1.5 - 10	1.5 - 10
Ferrule				
without/with plastic sleeve				
1 conductor		1.5 - 10	1.5 - 6	1.5 - 6

Description	Color
Terminal block, for mounting on NS 35...	gray black brown blue green

Ordering data		
Type	Order No.	Pcs./Pkt.
UDB 2X25/16 GY	3071355	5
UDB 2X25/16 BK	3071356	5
UDB 2X25/16 BN	3071357	5
UDB 2X25/16 BU	3071358	5
UDB 2X25/16 GN	3071359	5

Screwdriver
Marking
SF-PZSL 1-80 S-VDE
0815677 EML (15X9)R

Accessories		
SF-PZSL 1-80 S-VDE	1212699	10
0815677 EML (15X9)R		





25 (35) mm², 125 A, trunk line branch terminal block, 2x25 mm² outlets

ERIC

Technical data

Width	Length	Height NS 35/7,5	
27	55	46	
I_{max} [A]	U_{max} [V]	max. Ø [mm ²]	AWG (UL)
125	400	10 - 35	-
IEC 60998-1			
IEC	UL	CSA	IEC/ EN 60079-7
400	-	-	-
125 / 35	- / -	- / -	-
35	-	-	-
8 - 2	-	-	-
Rigid	Flexible	Ferrule without/with plastic sleeve	
10 - 35	10 - 25	10 - 25	10 - 16
Rigid	Flexible	Ferrule without/with plastic sleeve	
1.5 - 25	-	1.5 - 16	1.5 - 10
25			
PA			
V0			

Ordering data

Type	Order No.	Pcs./Pkt.
UDB 2X35/25 GY	3071350	5
UDB 2X35/25 BK	3071351	5
UDB 2X35/25 BN	3071352	5
UDB 2X35/25 BU	3071353	5
UDB 2X35/25 GN	3071354	5

Accessories

SF-PZSL 2-100 S-VDE	1212700	10
0815677 EML (15X9)R		

Terminal blocks – Classic

UBAL universal terminal blocks for aluminum conductors



The universal UBAL terminal blocks are suitable for the connection of aluminum and copper wire. Four cross-section sizes enable the connection of aluminum conductors from 6 to 240 mm² and copper wires from 2.5 to 240 mm².

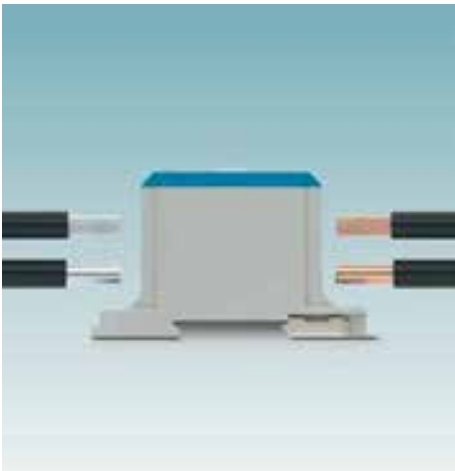

The metal parts of the universal terminal blocks are produced from high-quality aluminum alloys. A lead-free tin coating on the clamping parts and screws enable the connection of aluminum and copper wires. The terminal blocks are suitable for both rigid and multi-stranded conductors.



The contact chambers are coated with an antioxidant, simplifying the aluminum conductor mounting process. Another advantage is that the screws do not need to be tightened, meaning that the terminal blocks are maintenance-free.



The universal terminal blocks are certified for the connection of aluminum conductors in accordance with EN 61238-1 (Class A). Furthermore, they are approved in accordance with IEC 60947-7-1 and are suited in particular for photovoltaic applications. Therefore, the terminal blocks are tested for an operating temperature of 90°C.

UBAL universal terminal blocks for aluminum conductors

UBAL terminal blocks
for aluminum conductors

- Touch-protection caps cover the clamping space and the screw opening of the universal terminal blocks. The inadvertent touching of metal parts or opening of the terminal points is thus prevented
- A large area of the universal terminal blocks can be marked, thus enabling clear wiring
- PROJECT complete combines CAE software with the planning and marking processes. Thus, markings can be created simply and conveniently with the printing system from Phoenix Contact

Notes:

- 1) The maximum electrical data relates to the use of copper wires here.
- 2) The values for aluminum conductors relate to multi-stranded conductors in accordance with EN 60228.



new



145 A, feed-through terminal block

		Technical data			
Dimensions	[mm]	Width	Length	Height NS 35/7,5	
		19.2	82.5	51	
Dimensions	[mm]	Width	Length	Height NS 35/15	
		19.2	82.5	58.5	
Dimensions	[mm]	Width	Length	Height	
		19.2	82.5	51	
Maximum electrical data 1)		I_{max} [A]	U_{max} [V]	max. Ø [mm ²]	AWG (UL)
		145	1000	6 - 50	-
Al conductor rated data		IEC 60947-7-1			
		IEC	UL / CUL	CSA	IEC/ EN 60079-7
Rated voltage	[V]	1000	-	-	-
Nominal current / cross section	[A] / [mm ²]	145 / 50	-	-	-
Rated cross section	[mm ²]	50	-	-	-
Cross section range	AWG	6 - 1/0	-	-	-
Cu wire rated data		IEC 60947-7-1			
		IEC	UL / CUL	CSA	IEC/ EN 60079-7
Rated voltage	[V]	1000	-	-	-
Nominal current / cross section	[A] / [mm ²]	160 / 50	-	-	-
Rated cross section	[mm ²]	50	-	-	-
Cross section range	AWG	6 - 1/0	-	-	-
Al conductor connection capacity 2)		Rigid	Flexible	Ferrule without/with plastic sleeve	
1 conductor	[mm ²]	6 - 35	6 - 50	-	-
2 conductors (of the same type)	[mm ²]	-	-	-	-
Cu wire connection capacity		Rigid	Flexible	Ferrule without/with plastic sleeve	
1 conductor	[mm ²]	2.5 - 16	2.5 - 35	2.5 - 35	-
2 conductors (of the same type)	[mm ²]	-	1.5 - 16	-	-
General data					
Stripping length	[mm]	23			
Screw thread		M6			
Tightening torque		4 Nm (2,5 ... 4 mm ²), 12 Nm (6 ... 50 mm ²)			
Insulating material		PA			
Flammability rating in accordance with UL 94		V0			

		Ordering data		
Description	Color	Type	Order No.	Pcs./Pkt.
Terminal block	gray	UBAL 50	1086465	20
	blue	UBAL 50 BU	1086466	20
	green	UBAL 50 GN	1086468	20
	brown	UBAL 50 BN	1086470	20
	black	UBAL 50 BK	1086469	20
	yellow	UBAL 50 FE	1086471	20

		Accessories		
Cover, for conductor shaft	yellow	CEC UBAL 50	1086473	25
Center groove labeling		UCT-TM 5 or ZB 5 (see Catalog 3)		



Terminal blocks – Classic

UBAL universal terminal blocks for aluminum conductors

UBAL terminal blocks for aluminum conductors



- The universal terminal blocks are mounted conveniently on the 35 mm DIN rail or directly on the mounting plate
- Allen screws reliably transfer the various torques for aluminum and copper wires

Notes:

- 1) The maximum electrical data relates to the use of copper wires here.
- 2) The values for aluminum conductors relate to multi-stranded conductors in accordance with EN 60228.



245 A, feed-through terminal block

Dimensions		
Dimensions		[mm]
Dimensions		[mm]
Dimensions		[mm]
Maximum electrical data 1)		
Al conductor rated data		
Rated voltage	[V]	1000
Nominal current / cross section	[A] / [mm ²]	220 / 95
Rated cross section	[mm ²]	95
Cross section range	AWG	4 - 4/0
Cu wire rated data		
Rated voltage	[V]	1000
Nominal current / cross section	[A] / [mm ²]	245 / 95
Rated cross section	[mm ²]	95
Cross section range	AWG	4 - 4/0
Al conductor connection capacity 2)		
1 conductor	[mm ²]	16 - 35
2 conductors (of the same type)	[mm ²]	-
Cu wire connection capacity		
1 conductor	[mm ²]	- 95
2 conductors (of the same type)	[mm ²]	-
General data		
Stripping length	[mm]	27
Screw thread		M8
Tightening torque		20 Nm
Insulating material		PA
Flammability rating in accordance with UL 94		V0

Technical data			
Width	Length	Height NS 35/7,5	
25.1	93.6	58	
Width	Length	Height NS 35/15	
25.1	93.6	65.5	
Width	Length	Height	
25.1	93.6	58	
I _{max} [A]	U _{max} [V]	max. Ø [mm ²]	AWG (UL)
245	1000	16 - 95	-
IEC 60947-7-1			
IEC	UL / CUL	CSA	IEC / EN 60079-7
Rated voltage	[V]	-	-
Nominal current / cross section	[A] / [mm ²]	-	-
Rated cross section	[mm ²]	-	-
Cross section range	AWG	-	-
IEC	UL / CUL	CSA	IEC / EN 60079-7
Rated voltage	[V]	-	-
Nominal current / cross section	[A] / [mm ²]	-	-
Rated cross section	[mm ²]	-	-
Cross section range	AWG	-	-
Rigid	Flexible	Ferrule without/with plastic sleeve	
16 - 35	16 - 95	-	
-	-	-	
Rigid	Flexible	Ferrule without/with plastic sleeve	
- 95	16 - 70	16 - 70	
-	16 - 35	-	
PA			
V0			

Description	Color
Terminal block	gray
	blue
	green
	brown
	black
	yellow

Ordering data		
Type	Order No.	Pcs./Pkt.
UBAL 95	1086475	10
UBAL 95 BU	1086476	10
UBAL 95 GN	1086477	10
UBAL 95 BN	1086479	10
UBAL 95 BK	1086478	10
UBAL 95 FE	1086480	10



Cover, for conductor shaft	yellow
Center groove labeling	

Accessories		
CEC UBAL 50	1086473	25
UCT-TM 8 or ZB 8 (see Catalog 3)		

UBAL universal terminal blocks for aluminum conductors

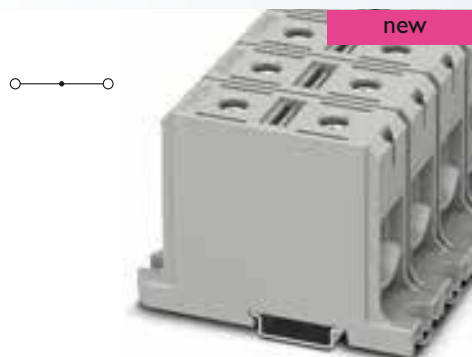

320 A, feed-through terminal block

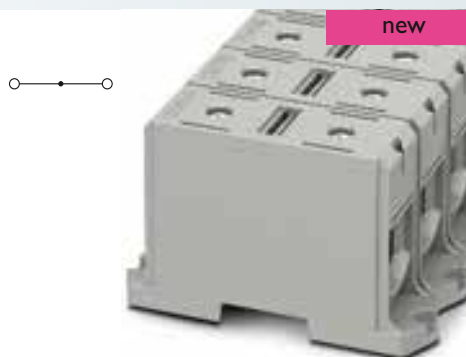

425 A, feed-through terminal block

Technical data			
Width	Length	Height NS 35/7,5	
30.5	105.5	67	
Width	Length	Height NS 35/15	
30.5	105.5	74.5	
Width	Length	Height	
30.5	105.5	67	
I_{max} [A]	U_{max} [V]	max. \varnothing [mm ²]	AWG (UL)
320	1000	35 - 150	-
IEC 60947-7-1			
IEC	UL / CUL	CSA	IEC/ EN 60079-7
1000	-	-	-
290 / 150	-	-	-
150	-	-	-
300 - 2	-	-	-
IEC	UL / CUL	CSA	IEC/ EN 60079-7
1000	-	-	-
320 / 150	-	-	-
150	-	-	-
300 - 2	-	-	-
Rigid	Flexible	Ferrule without/with plastic sleeve	
-	35 - 150	-	-
-	-	-	-
Rigid	Flexible	Ferrule without/with plastic sleeve	
-	35 - 120	35 - 120	-
-	35 - 50	-	-
30			
M10			
20 Nm (35 ... 50 mm ²), 30 Nm (120 ... 150 mm ²)			
PA			
V0			

Technical data			
Width	Length	Height NS 35/7,5	
37.5	130	-	
Width	Length	Height NS 35/15	
37.5	130	-	
Width	Length	Height	
37.5	130	70	
I_{max} [A]	U_{max} [V]	max. \varnothing [mm ²]	AWG (UL)
425	1000	35 - 240	-
IEC 60947-7-1			
IEC	UL / CUL	CSA	IEC/ EN 60079-7
1000	-	-	-
380 / 240	-	-	-
240	-	-	-
500 - 3/0	-	-	-
IEC	UL / CUL	CSA	IEC/ EN 60079-7
1000	-	-	-
425 / 240	-	-	-
240	-	-	-
500 - 3/0	-	-	-
Rigid	Flexible	Ferrule without/with plastic sleeve	
-	35 - 240	-	-
-	-	-	-
Rigid	Flexible	Ferrule without/with plastic sleeve	
-	35 - 185	35 - 185	-
-	35 - 70	-	-
43			
M12			
12 Nm (35 ... 70 mm ²), 45 Nm (95 ... 240 mm ²)			
PA			
V0			

Ordering data		
Type	Order No.	Pcs./Pkt.
UBAL 150	1086498	10
UBAL 150 BU	1086499	10
UBAL 150 GN	1086501	10
UBAL 150 BN	1086503	10
UBAL 150 BK	1086502	10
UBAL 150 FE	1086504	10

Ordering data		
Type	Order No.	Pcs./Pkt.
UBAL 240	1086505	5
UBAL 240 BU	1086506	5
UBAL 240 GN	1086507	5
UBAL 240 BN	1086509	5
UBAL 240 BK	1086508	5
UBAL 240 FE	1086510	5

Accessories		
CEC UBAL 150	1086474	25
UCT-TM 10 or ZB 10 (see Catalog 3)		

Accessories		
CEC UBAL 240	1090037	25
UCT-TM 12 or ZB 12 (see Catalog 3)		

Terminal blocks – Classic

Accessories

Test sockets PSBJ ...

- The test sockets are tailored to the special applications encountered in the energy supply industry
- The test socket PSBJ... is used in place of the normal bridge screw and ensures the voltage tap on a bridged group of terminal blocks



4 mm test socket, for URTK/S test disconnect terminal blocks



4 mm test socket, for UK terminal blocks with M4 bridge thread

ERC

ERC

Ordering data

Ordering data

Description	Color	Type	Order No.	Pcs./Pkt.	Type	Order No.	Pcs./Pkt.
Test socket , insulated, for the URTK/S terminal block, M3.5 thread							
	transparent	PSBJ 3,5/18/6 FARBLOS	0311391	10			
	white	PSBJ 3,5/18/6 WH	0311317	10			
	red	PSBJ 3,5/18/6 RD	0311320	10			
	blue	PSBJ 3,5/18/6 BU	0311333	10			
	yellow	PSBJ 3,5/18/6 YE	0311346	10			
	green	PSBJ 3,5/18/6 GN	0311359	10			
	violet	PSBJ 3,5/18/6 VT	0311362	10			
	gray	PSBJ 3,5/18/6 GY	0311375	10			
	black	PSBJ 3,5/18/6 BK	0311388	10			
Test socket , insulated, can be used only with FBI and ISSBI							
	silver				PSBJ 3/13/4	0201304	10
Test socket , insulated, for UK 6 N, UK 10 N and URTK/SP and USST 10 terminal blocks, M4 thread							
	transparent				PSBJ 4/15/6 FARBLOS	0303419	10
	white				PSBJ 4/15/6 WH	0303312	10
	red				PSBJ 4/15/6 RD	0303325	10
	blue				PSBJ 4/15/6 BU	0303354	10
	yellow				PSBJ 4/15/6 YE	0303367	10
	gray				PSBJ 4/15/6 GY	0303396	10
	black				PSBJ 4/15/6 BK	0303406	10
Test socket , fully isolated, for safety test plugs							
For the UK 5 N terminal block, thread M3	gray						
For the UK 6 N terminal block, thread M4	gray						
Can be used only with FBI 10-6, thread M3	gray						
Can be used only with FBI 10-8, thread M4	gray						
Test socket , insulated							
	transparent						
	red						
	blue						
	yellow						
	green						
	violet						
	black						
	gray						
	brown						
Test socket , fully insulated, touch-proof in accordance with BGV A 2, for 4 mm Ø safety measuring leads, for universal test disconnect terminal block URTK/S, M3.5 thread							
	red						
	blue						
	yellow						
	green						
	violet						
	black						



4 mm test socket, for safety test plugs,
for UK terminal blocks



4 mm test socket, for SRTK 6 and
URTK 6 test disconnect terminal blocks,
M3 thread



4 mm test socket, for safety test plugs,
for URTK/S test disconnect terminal blocks

ERC

ERC

Ordering data			Ordering data			Ordering data		
Type	Order No.	Pcs./Pkt.	Type	Order No.	Pcs./Pkt.	Type	Order No.	Pcs./Pkt.
PSBJ 3/52/6 GY	3048085	10						
PSBJ 4/41/8 GY	3206186	10						
PSBJ 3/50/6 GY	3048098	10						
PSBJ 4/51/8 GY	3206173	10						
			PSBJ-URTK 6 FARBLOS	3026450	10			
			PSBJ-URTK 6 RD	3026719	10			
			PSBJ-URTK 6 BU	3026434	10			
			PSBJ-URTK 6 YE	3026405	10			
			PSBJ-URTK 6 GN	3026418	10			
			PSBJ-URTK 6 VT	3026421	10			
			PSBJ-URTK 6 BK	3026447	10			
			PSBJ-URTK 6 GY	3026612	10			
			PSBJ-URTK 6 BN	3026971	10			
						PSBJ-URTK/S RD	0311744	10
						PSBJ-URTK/S BU	0311757	10
						PSBJ-URTK/S YE	0311731	10
						PSBJ-URTK/S GN	0311760	10
						PSBJ-URTK/S VT	0311773	10
						PSBJ-URTK/S BK	0311728	10

Test sockets PSBJ ...

Notes:
1) For additional test sockets, visit phoenixcontact.net/products

- Test sockets are also available for the UGSK/S switchable slide-type terminal blocks for testing tasks with 4 mm Ø safety measuring cables



		Ordering data		
Description	Color	Type	Order No.	Pcs./Pkt.
Test socket	orange	PSBJ-GSK/S-N OG	3032890	10
	yellow	PSBJ-GSK/S-N YE	3032891	10
	green	PSBJ-GSK/S-N GN	3032892	10
	violet	PSBJ-GSK/S-N VT	3032893	10
	blue	PSBJ-GSK/S-N BU	3032894	10
	Test socket, insulated¹⁾	gray		
brown				
black				
red				
orange				
yellow				
green				
violet				
blue				



Ordering data

Type	Order No.	Pcs./Pkt.
PSBJ 6-T GY	3070316	10
PSBJ 6-T BN	3070317	10
PSBJ 6-T BK	3070318	10
PSBJ 6-T RD	3070319	10
PSBJ 6-T OG	3070320	10
PSBJ 6-T YE	3070326	10
PSBJ 6-T GN	3070327	10
PSBJ 6-T VT	3070328	10
PSBJ 6-T BU	3070329	10

Test sockets PSB ...



- Test sockets PSB ... are used for a reliable test connection
- All test sockets are screwed into the bridge shaft
- With the PSB 3/10/4, the test connection is provided by the MPS miniature test plug with 2.3 mm diameter
- With the PSB 6/5/6 and PSB 4/7/6, the test plug with 4 mm diameter is used



Test sockets for UK terminal blocks

ERIC

Ordering data

Description	Color	Type	Order No.	Pcs./Pkt.
Test socket For UK 2,5 N, UK 3 N, UK 5 N, URTK/SS terminal blocks, M3 thread	silver	PSB 3/10/4	0601292	10
For the UK 6 N, UK 10 N, UK 16 N terminal blocks, M4 thread	silver	PSB 4/7/6	0303299	10
For UK 35 terminal block, M6 thread	silver	PSB 6/5/6	0205290	10

Modular test plugs PS-...

- The modular test plugs PS-...2,3MM can be used to put together individual test adapters
- The test plug reliably makes contact in the bridge shaft and in all test sockets with a 2.3 mm or 4 mm diameter
- The modular test plugs PS-UK ... are simply placed on the bridge shaft of the corresponding terminal block and latched by pressing down the locking pin



2.3 mm test plugs



ERC

General data				Technical data		
Material						
Flammability rating in accordance with UL 94						
Temperature range			[°C]			
Ordering data				Technical data		
Description	No. of pos.	Width	Color	Type	Order No.	Pcs./Pkt.
Test plug metal part, 2.3 mm Ø	1		gray	MPS-MT	0201744	10
		5 mm	white	MPS-IH WH	0201663	10
Insulating sleeve, for MPS metal part		5 mm	red	MPS-IH RD	0201676	10
		5 mm	blue	MPS-IH BU	0201689	10
		5 mm	yellow	MPS-IH YE	0201692	10
		5 mm	green	MPS-IH GN	0201702	10
		5 mm	gray	MPS-IH GY	0201728	10
		5 mm	black	MPS-IH BK	0201731	10
Test plug, consisting of: Metal part for 4 mm Ø socket hole and 4 mm Ø	1		silver	MPS-MT/ 4MM	3048577	10
Modular test plug housing, for MPS metal part, can be marked with ZB 5	1	5.2 mm	red	PS-5/2,3MM RD	3038723	10
Modular test plug housing, for MPS metal part, can be labeled with ZBF 6	1	6.2 mm	red	PS-6/2,3MM RD	3038736	10
Modular test plug housing, labeling with ZBF 7,5	1	7.5 mm	red	PS-7,5/2,3MM RD	3038749	10
Modular test plug housing, labeling with ZBF 8	1	8 mm	red	PS-8/2,3MM RD	3048564	10
Individual test plug, delivery: 1-pos.	1	5 mm	red			
Modular test plug, delivery: set of 10 with connection pin						
Pitch 5.2 mm	1	5 mm	red			
Modular test plug, delivery: set of 10 with connection pin						
Pitch 6.2 mm	1	5 mm	red			
Individual double-level test plug, contacts in the upper and lower level simultaneously, delivery: 1-pos., for UTTB ...						
	1	7.6 mm	red			
Modular double-level test plug, contacts in the upper and lower level simultaneously, delivery: 10-pos. blocks with 2 connection pins, for UTTB 2,5						
	10	54.6 mm	red			
Modular double-level test plug, contacts in the upper and lower level simultaneously, delivery: 10-pos. blocks with 2 connection pins, for UTTB 4						
	10	64.6 mm	red			

ERC

General data			Technical data			
Material						
Flammability rating in accordance with UL 94						
Temperature range			[°C]			
Ordering data			Technical data			
Description	No. of pos.	Width	Color	Type	Order No.	Pcs./Pkt.
PS-UK 2,5 B/E					3001132	10
PS-UK 2,5 B/Z-5					3001226	1
PS-UK 2,5 B/Z-6					3001239	1
PS-UKK/E					3000641	10
PS-UKK 3					3000638	1
PS-UKK 5					3000625	1

Short-circuit plugs KSS ...



- Short-circuit plugs allow two or more neighboring terminal blocks, fitted with the test sockets PSB ... or PSBJ ..., to be easily short circuited
- The short-circuit plugs KSSI ... are suitable for use on isolated 4 mm test sockets for safety test plugs



2-, 3- and 4-pos. short-circuit plugs

ERC

General data

Material
Copper
Flammability rating in accordance with UL 94
V2

Technical data

Ordering data

Description	No. of pos.	Color
Short-circuit plug , for short circuiting neighboring terminal blocks, can only be used with PSB or PSBJ		
Pitch 5.2 mm	2	black
Pitch 6.2 mm	2	black
Pitch 8.2 mm	2	black
Pitch 10.2 mm	2	black
Short-circuit plug , for short circuiting neighboring terminal blocks, can only be used with PSB or PSBJ, with 6.2 mm pitch		
	3	black
Short-circuit plug , for short circuiting neighboring terminal blocks, can only be used with PSB or PSBJ, with 8.2 mm pitch		
	4	black
Short-circuit plug , for short circuiting neighboring terminal blocks, fully insulated		
	2	black
	4	black

Type	Order No.	Pcs./Pkt.
KSS 5	2303543	10
KSS 6	0301547	10
KSS 8	0311540	10
KSS 10	0310541	10
KSS 3- 6	0309523	10
KSS 4- 8	0309549	10
KSSI 2-8	3000722	10
KSSI 4-8	3000735	10



Warning labels WS ...



- Network connection terminal blocks are reliably covered and labeled using warning labels
- This prevents accidental actuation of the terminal points
- The warning labels are secured in the bridge shafts of the UK ... modular terminal blocks using plastic screws



Warning labels for UK feed-through terminal blocks

		Ordering data		
Description	Color	Type	Order No.	Pcs./Pkt.
Warning label, with 2 plastic screws, pitch 5 mm				
covers 3 terminal blocks	yellow/black	WS 3- 5	0805357	10
covers 4 terminal blocks	yellow/black	WS 4- 5	0805344	10
covers 5 terminal blocks	yellow/black	WS 5- 5	0805331	10
Warning label, with 2 plastic screws, pitch 6 mm				
covers 3 terminal blocks	yellow/black	WS 3- 6	1004115	10
covers 4 terminal blocks	yellow/black	WS 4- 6	1004209	10
covers 5 terminal blocks	yellow/black	WS 5- 6	1004403	10
Warning label, with 2 plastic screws, pitch 8 mm				
covers 3 terminal blocks	yellow/black	WS 3- 8	1004128	10
covers 4 terminal blocks	yellow/black	WS 4- 8	1004212	10
covers 5 terminal blocks	yellow/black	WS 5- 8	1004416	10
Warning label, with 2 plastic screws, pitch 10 mm				
covers 4 terminal blocks	yellow/black	WS 4-10	1004225	10
covers 5 terminal blocks	yellow/black	WS 5-10	1004429	10
Warning label, with 2 plastic screws, pitch 12 mm				
covers 4 terminal blocks	yellow/black	WS 4-12	0805328	10
covers 5 terminal blocks	yellow/black	WS 5-12	0805315	10
Warning label, with two plastic screws, pitch 15 mm				
covers 4 terminal blocks	orange	WS 4-15	1004241	10
covers 5 terminal blocks	orange	WS 5-15	1004445	10

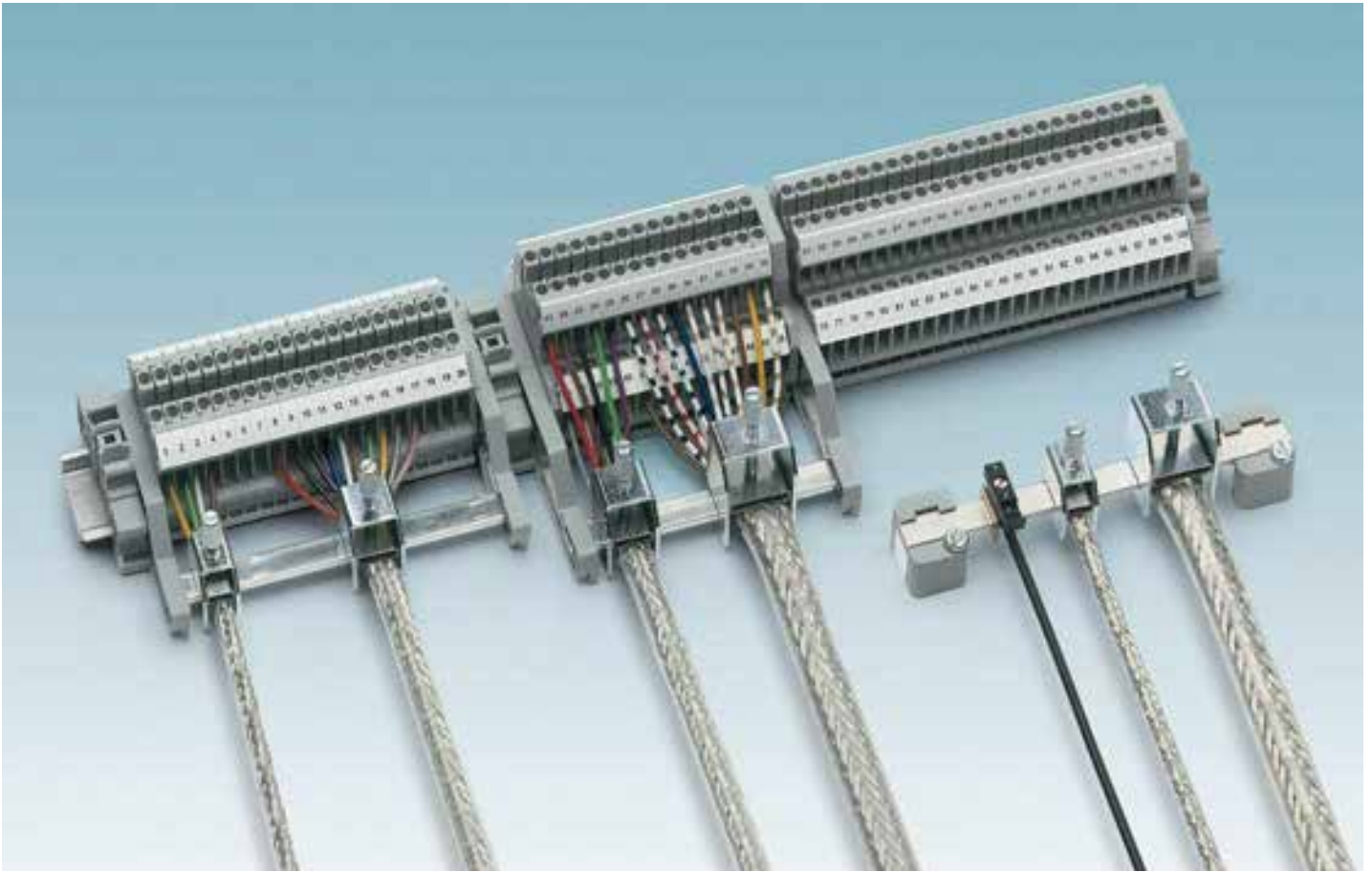

i Your web code: [#0845](#)



Large shield support

Shield connection terminal blocks are suitable for all standard cable shields and allow for EMC-compliant wiring through large surfaces and low-impedance and low-resistance contact transitions.



Easy to install

The shield connection clamps offer optimum wiring convenience. Only once the terminal strip has been wired is the shield connection terminal block mounted by simply pivoting it into place.



Safe contact

Phoenix Contact support brackets for shield connection clamps are easily snapped onto the mounting rail. The integrated contact metals allow the ground potential to be automatically connected to the busbar.



Conductors with a diameter of 2 to 35 mm can make optimum contact with the shield connection clamps from the SK series without any special tools and are available for various types of mounting.



The single-sided shield support brackets AB-SK are particularly well suited to space-saving conductor connection for terminal blocks and devices with cable entry at the side.

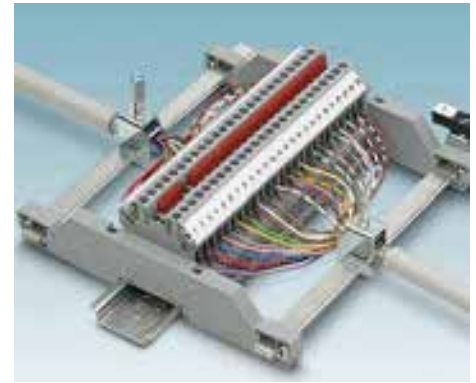

The double support bracket offers simple handling with optimum EMC properties for the two-sided support of a shielded cable. Either an isolated or grounded structure can be used.

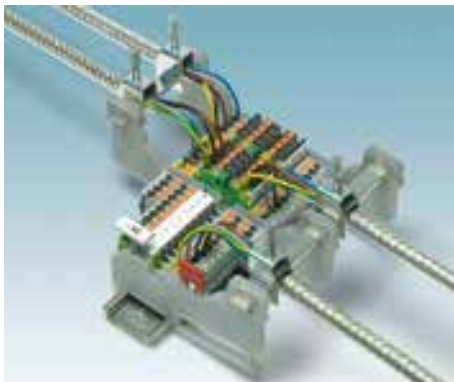

The easiest way to wire terminal blocks with a front connection is using support brackets AB-SK TOP located above the blocks. The NLS rail can be mounted in the support brackets vertically, horizontally or at a 45° angle for optimum conductor placing.



The 3 x 10 mm PEN conductor busbar can also be quickly and safely snapped into the contact zone. The ground potential is thereby automatically connected to the busbar.



Having the same design as the SK series, shield supports with terminal blocks SK ...-D can also be realized directly on the mounting plate or back wall. The terminal blocks are simply pivoted into the two slots above the conductor.



Support brackets with a lateral metal insert for the PEN conductor busbar or T-shaped compact support brackets AB-SK/E are used to freely position the shield connection clamps on the mounting plate.



Alternatively, the shielding can also be connected to ground potential isolated from protective earth ground. An appropriate contact to the PEN conductor busbar is established using a pick-off terminal block.



The easiest way to wire terminal blocks with a front connection is using support brackets located above the blocks. This method also allows multi-level terminal blocks with short wiring paths to be connected in compliance with EMC requirements.

Terminal blocks – Classic

SK shield connection clamps

Shield connection clamps SK ...

The screw-type shield connection clamps of the SK series are characterized by:

- Simple handling
- Knurled screw
- Spring-loaded, large pressure piece
- Suitable for direct and busbar mounting

Notes:
Dimensional drawings can be found on page 605.



Shield connection clamps for busbar mounting



Shield connection clamps for direct mounting

ERC

ERC

Description	Color
Shield connection clamp , for applying the shield to busbars, contact resistance < 1 mΩ	
Ø 2-5 mm, tightening torque 0.4 Nm	silver
Ø 3-8 mm, tightening torque 0.6 Nm	silver
Ø 3-14 mm, tightening torque 0.8 Nm	silver
Ø 5-20 mm, tightening torque 0.8 Nm	silver
Ø 5 - 28 mm, tightening torque 1 Nm	silver
Ø 20-35 mm, tightening torque 1.2 Nm	silver
Shield connection clamp , for applying the shield directly to the conductive mounting plates, plate thickness 1 - 2 mm	
Ø 2-5 mm, tightening torque 0.4 Nm	silver
Ø 3-8 mm, tightening torque 0.6 Nm	silver
Ø 3-14 mm, tightening torque 0.8 Nm	silver
Ø 5-20 mm, tightening torque 0.8 Nm	silver
Ø 5 - 28 mm, tightening torque 1 Nm	silver
Ø 20-35 mm, tightening torque 1.2 Nm	silver

Ordering data		
Type	Order No.	Pcs./Pkt.
SK 5	3025338	10
SK 8	3025163	10
SK 14	3025176	10
SK 20	3025189	10
SK 28	3026997	10
SK 35	3026463	10

Ordering data		
Type	Order No.	Pcs./Pkt.
SK 5-D	3025406	10
SK 8-D	3026861	10
SK 14-D	3026874	10
SK 20-D	3026887	10
SK 28-D	3027006	10
SK 35-D	3026890	10

Accessories	
PEN conductor busbar, 3 x 10 mm, 1 m long, material: Copper, tin-plated, nominal current: 140 A	

Accessories		
Type	Order No.	Pcs./Pkt.
NLS-CU 3/10 SN 1000MM	0402174	10

Accessories		
Type	Order No.	Pcs./Pkt.

Shield connection clamps SKS ...

- The spring shield connection clamps SKS ... are available for cable and conductor diameters of between 3 and 20 mm
- Three different forms of mounting are possible: on NS 35 DIN rails, on busbars or directly on conductive mounting plates

Notes:

Dimensional drawings can be found on page 605.



Shield connection clamps
for busbar and direct mounting



Shield connection clamps
for DIN rail mounting

ERC

		Ordering data		
Description	Color	Type	Order No.	Pcs./Pkt.
Shield connection clamp , for applying the shield to busbars, contact resistance < 1 mΩ				
Ø 3-8 mm	silver	SKS 8	3240210	10
Ø 3-14 mm	silver	SKS 14	3240211	10
Ø 5-20 mm	silver	SKS 20	3240212	10
Shield connection clamp , for directly applying the shield to conductive mounting plates, metal thickness 1 - 2 mm, with fastening screw M4				
Ø 3-8 mm	silver	SKS 8-D	3240213	10
Ø 3-14 mm	silver	SKS 14-D	3240214	10
Ø 5-20 mm	silver	SKS 20-D	3240215	10
Shield connection clamp , with screwfix, mounting on DIN rail NS 35..., for shield support on busbars				
Ø 3-8 mm	silver			
Ø 3-14 mm	silver			
Ø 5-20 mm	silver			
Shield connection clamp , with snap-on foot, mounting on DIN rail NS 35..., for shield support on busbars				
Ø 3-8 mm	silver			
Ø 3-14 mm	silver			
Ø 5-20 mm	silver			

Accessories

		Accessories		
Description		Type	Order No.	Pcs./Pkt.
PEN conductor busbar , 3 x 10 mm, 1 m long, material: Copper, tin-plated, nominal current: 140 A		NLS-CU 3/10 SN 1000MM	0402174	10

ERC

		Ordering data		
Description	Color	Type	Order No.	Pcs./Pkt.
Shield connection clamp , for applying the shield to busbars, contact resistance < 1 mΩ				
Ø 3-8 mm	silver	SKS 8-NS35	3240216	10
Ø 3-14 mm	silver	SKS 14-NS35	3240217	10
Ø 5-20 mm	silver	SKS 20-NS35	3240218	10
Shield connection clamp , for directly applying the shield to conductive mounting plates, metal thickness 1 - 2 mm, with fastening screw M4				
Ø 3-8 mm	silver	SKS 8-SNS35	3062786	10
Ø 3-14 mm	silver	SKS 14-SNS35	3062799	10
Ø 5-20 mm	silver	SKS 20-SNS35	3062809	10

Accessories

		Accessories		
Description		Type	Order No.	Pcs./Pkt.
PEN conductor busbar , 3 x 10 mm, 1 m long, material: Copper, tin-plated, nominal current: 140 A		NLS-CU 3/10 SN 1000MM	0402174	10

Terminal blocks – Classic

SK shield connection clamps

Support bracket for shield support on one side



AB-SK TOP

- For convenient shield connection, especially for single- and multi-level terminal blocks and devices with a front connection
- The 3 x 10 mm rail can be mounted in the support brackets vertically, horizontally and at a 45° angle for optimum conductor placing
- Compact design in a 5.2 mm pitch
- Can be marked with zack marker strip and KLM ... terminal strip markers
- Parking facility for plug-in bridges FBS
- End bracket function
- For mounting shield connection clamps SK and SKS

AB-SK

- The single-sided shield support brackets AB-SK are particularly well suited to space-saving conductor connection for terminal blocks and devices with cable entry at the side
- Available in two lengths
- For mounting shield connection clamps SK

AB-SKS

- For convenient shield connection, especially for single- and multi-level terminal blocks and devices with a front connection
- Isolated to DIN rail
- End bracket function
- For mounting shield connection clamps SK and SKS



Support bracket, tall, for shield connection clamps SK and SKS

Dimensions	[mm]
Width	5.2
Length	102.4
Height NS 35/7,5	63.2

General data	
Material	PA

Description	Color
Support bracket with end holder function, for mounting on NS 35..., direct contact with NS 35..., for accommodating 3 x 10 mm busbars, shield connection clamps SK and SKS	gray
Support bracket with end holder function, for mounting on NS 35..., isolated to NS 35..., for accommodating 3 x 10 mm busbars, for shield connection clamps SK and SKS	gray
Support bracket, for mounting on NS 35..., direct contact with NS 35..., for accommodating 3 x 10 mm busbars, shield connection clamps SK	gray
Support bracket, 65 mm, for mounting on NS 35..., direct contact with NS 35..., for accommodating 3 x 10 mm busbars, shield connection clamps SK	gray
Support bracket with end holder function, for mounting on NS 35..., isolated to NS 35..., for accommodating 3 x 10 mm busbars, for shield connection clamps SK and SKS	gray

PEN conductor busbar, 3 x 10 mm, 1 m long, material: Copper, tin-plated, nominal current: 140 A	silver
---	--------

Lateral groove labeling
Lateral groove labeling

Technical data		
Width	Length	Height NS 35/7,5
5.2	102.4	63.2

Ordering data

Type	Order No.	Pcs./Pkt.
AB-SK TOP	3062090	10
AB-SK TOP INSULATED	3062074	10

Accessories

NLS-CU 3/10 SN 1000MM	0402174	10
UC-TM 5, UCT-TM 5 or ZB 5 (see Catalog 3)		
UC-TMF 5, UCT-TMF 5 or ZBF 5 (see Catalog 3)		

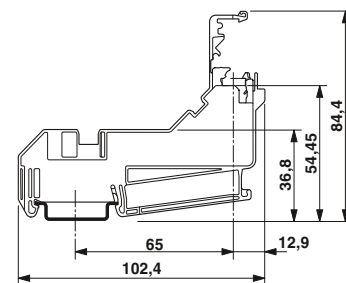

AB-SK TOP



Support bracket,
for shield connection clamps SK



Support bracket, 65 mm long,
for shield connection clamps SK



Isolated support bracket, tall,
for shield connection clamps SK and SKS

Technical data		
Width	Length	Height NS 35/7,5
6.2	77.35	28.7
PA		

Technical data		
Width	Length	Height NS 35/7,5
6.2	95.5	28.7
PA		

Technical data		
Width	Length	Height NS 35/7,5
9.5	97.8	46.9
PA		

Ordering data		
Type	Order No.	Pcs./Pkt.
AB-SK	3025341	10

Ordering data		
Type	Order No.	Pcs./Pkt.
AB-SK 65	3026489	10

Ordering data		
Type	Order No.	Pcs./Pkt.
AB-SKS 60	3240223	10

Accessories		
NLS-CU 3/10 SN 1000MM	0402174	10

Accessories		
NLS-CU 3/10 SN 1000MM	0402174	10

Accessories		
NLS-CU 3/10 SN 1000MM	0402174	10

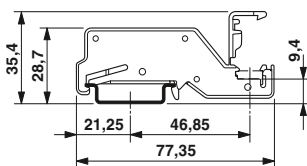

AB-SK

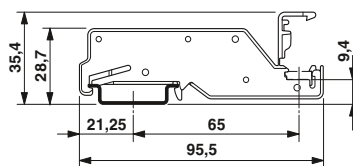

AB-SK 65

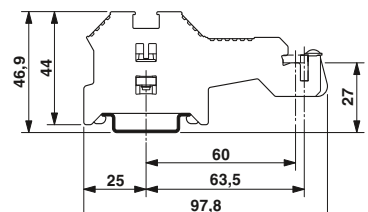

AB-SKS 60

Terminal blocks – Classic

SK shield connection clamps

Double support bracket for shield support on both sides

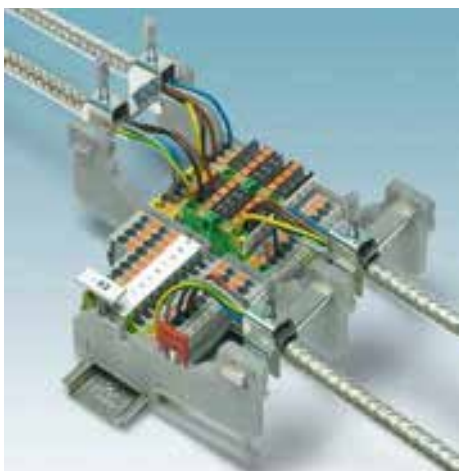

AB-SK-D TOP

- For convenient shield connection, especially for single- and multi-level terminal blocks and devices with a front connection
- The 3 x 10 mm rail can be mounted in the support brackets vertically, horizontally and at a 45° angle for optimum conductor placing
- Compact design in a 5.2 mm pitch
- Can be marked with zack marker strip and KLM ... terminal strip markers
- Parking facility for bridges and connectors
- For mounting shield connection terminal blocks SK and SKS

AB-SK 65-D

- The double shield support brackets are particularly well suited to space-saving conductor connections for terminal blocks and devices with cable entry at the side
- Available in two lengths
- For mounting shield connection terminal blocks SK



Double support bracket, tall, for shield connection clamps SK and SKS

Dimensions	[mm]
Width	5.2
Length	155.8
Height NS 35/7,5	-

General data	
Material	PA

Description	Color
Double support bracket with end bracket function, for mounting on NS 35..., direct contact with NS 35..., for accommodating 3 x 10 mm busbars, shield connection terminal blocks SK and SKS	gray

Double support bracket with end bracket function, for mounting on NS 35..., isolated to NS 35..., for accommodating 3 x 10 mm busbars, for shield connection clamps SK and SKS	gray
---	------

Double support bracket, for mounting on NS 35..., direct contact with NS 35..., for accommodating 3 x 10 mm busbars, shield connection clamps SK	gray
---	------

Double support bracket, 65 mm, for mounting on NS 35..., isolated to NS 35... for accommodating 3 x 10 mm busbars, shield connection clamps SK	gray
---	------

PEN conductor busbar, 3 x 10 mm, 1 m long, material: Copper, tin-plated, nominal current: 140 A	silver
--	--------

Lateral groove labeling
Lateral groove labeling

Technical data

Width	Length	Height NS 35/7,5
5.2	155.8	-

Material	PA
----------	----

Ordering data

Type	Order No.	Pcs./Pkt.
AB-SK-D TOP	3062100	10

--	--	--

--	--	--

--	--	--

Accessories

NLS-CU 3/10 SN 1000MM	0402174	10
-----------------------	---------	----

UC-TM 5, UCT-TM 5 or ZB 5 (see Catalog 3)
--

UC-TMF 5, UCT-TMF 5 or ZBF 5 (see Catalog 3)

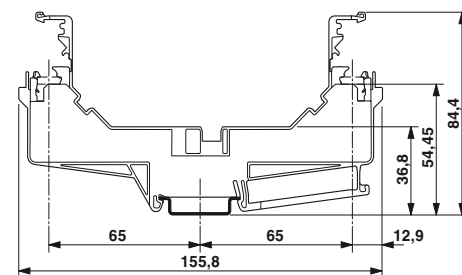
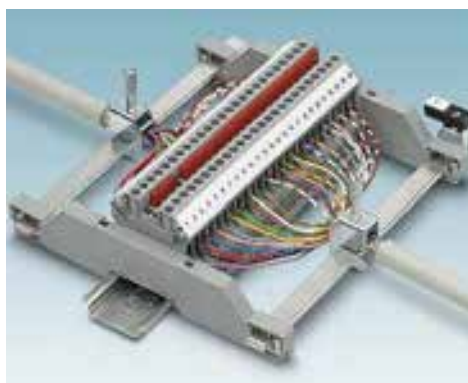

AB-SK-D TOP



Isolated, double support bracket, tall, for shield connection clamps SK and SKS



Double support bracket, tall, for shield connection clamps SK



Isolated, double support bracket, tall, for shield connection clamps SK

Technical data		
Width	Length	Height NS 35/7,5
5.2	155.8	-
PA		

Technical data		
Width	Length	Height NS 35/7,5
8.2	150	28.7
PA		

Technical data		
Width	Length	Height NS 35/7,5
8.2	150	28.7
PA		

Ordering data		
Type	Order No.	Pcs./Pkt.

Ordering data		
Type	Order No.	Pcs./Pkt.

Ordering data		
Type	Order No.	Pcs./Pkt.

AB-SK-D TOP INSULATED	3062087	10
-----------------------	---------	----

AB-SK 65-D	3026900	10
------------	---------	----

AB-SK 65-D INSULATED	3040889	10
----------------------	---------	----

Accessories		
NLS-CU 3/10 SN 1000MM	0402174	10

Accessories		
NLS-CU 3/10 SN 1000MM	0402174	10

Accessories		
NLS-CU 3/10 SN 1000MM	0402174	10

UC-TM 5, UCT-TM 5 or ZB 5
(see Catalog 3)
UC-TMF 5, UCT-TMF 5 or ZBF 5
(see Catalog 3)

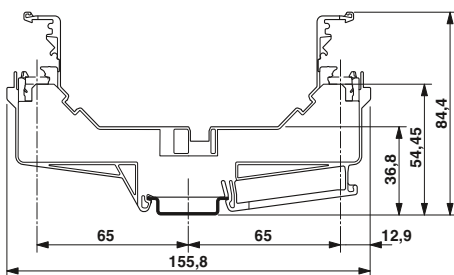

AB-SK-D TOP INSULATED

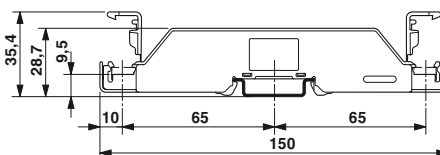

AB-SK 65-D

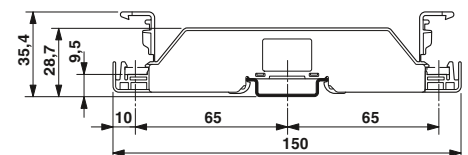

AB-SK 65-D INSULATED

Terminal blocks – Classic

SK shield connection clamps

Support bracket for direct mounting

The support brackets are available in the following versions:

- AB/SS for isolated installation on the mounting plate and
- AB/SS-M for non-isolated installation on the mounting plate
- For mounting shield connection terminal blocks SK and SKS

Notes:
For dimensional drawings, see phoenixcontact.net/products



Support bracket for shield connection clamps SK



Support bracket for shield connection clamps SK & SKS

General data		Technical data			Technical data		
Material		PA			PA		
Description		Ordering data			Ordering data		
	Color	Type	Order No.	Pcs./Pkt.	Type	Order No.	Pcs./Pkt.
Support bracket , insulated, with retaining screw, for 3 x 10 mm or 6 x 6 mm busbars	gray	AB/SS	0404428	10			
Support bracket , with contact to the mounting plate, with retaining screw, for 3 x 10 mm busbars	gray	AB/SS-M	3025888	10			
Support bracket , insulated, for 3 x 10 mm or 6 x 6 mm busbars	gray				AB/SKS	3240224	10
	gray						
PEN conductor busbar, 3 x 10 mm, 1 m long, material: Copper, tin-plated, nominal current: 140 A		Accessories			Accessories		
	silver	NLS-CU 3/10 SN 1000MM	0402174	10	NLS-CU 3/10 SN 1000MM	0402174	10

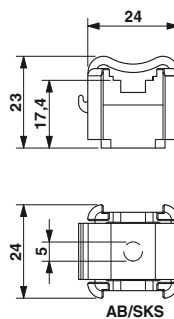
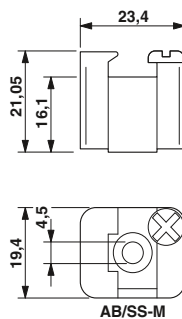
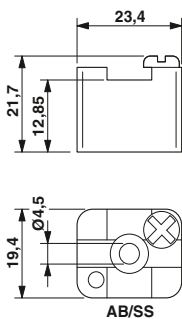

Multi-level support bracket for direct mounting



- Double and triple support brackets for different busbars
- Type allows for an extremely compact design using large amounts of wiring, e. g., for multi-level front connection terminal blocks
- Support brackets are isolated
- Direct mounting



Support bracket, multi-level, insulated

General data	
Material	PA

Description	Color
Double support bracket , insulating material, can be optionally used for either 3 x 10 mm or 6 x 6 mm neutral busbar	gray
Height 48 mm	gray
Height 36.8 mm	gray
Triple support bracket , made from isolation material	gray

PEN conductor busbar , 3 x 10 mm, 1 m long, material: Copper, tin-plated, nominal current: 140 A	silver
PEN conductor busbar , in accordance with DIN VDE 0611-4, 6 x 6 mm, 1 m long, material: Copper, tin-plated, nominal current: 140 A	silver

Technical data		
----------------	--	--

Ordering data		
Type	Order No.	Pcs./Pkt.
AB2/SS	0404431	10
ABN 2/SS	0404460	10
AB3/SS	0800086	10

Accessories		
NLS-CU 3/10 SN 1000MM	0402174	10
NLS-CU 6/6 SN 1000MM	0402161	10

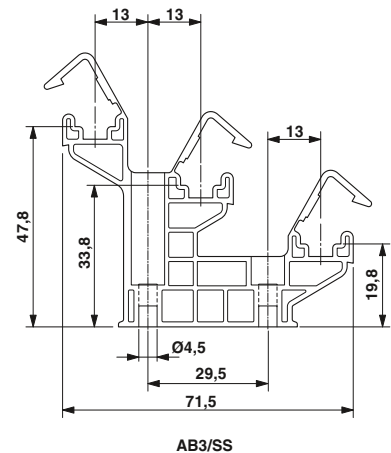
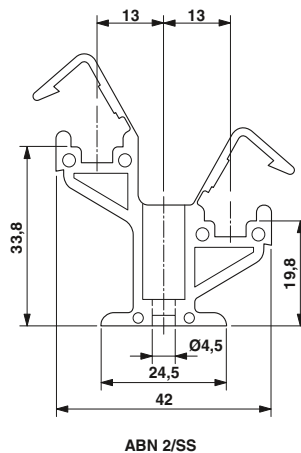
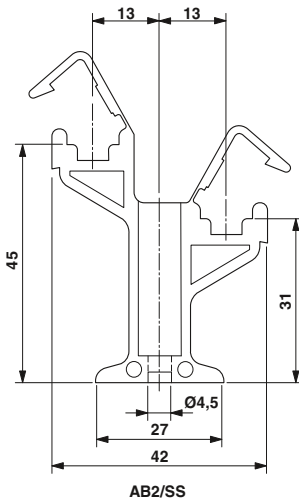

Terminal blocks – Classic

SK shield connection clamps

Support bracket for direct and DIN rail mounting



- T-shaped support brackets for space-saving direct mounting and free positioning on the mounting plate
- Suitable for shield connection clamps SK 5 to SK 14, SKS 8 and SKS 14
- Version for NS 35 DIN rail mounting



Support bracket

General data	
Material	Aluminum
Description	Color
Support bracket , for direct mounting with contacting on the mounting surface	silver
Support bracket , for mounting on NS 35 DIN rails	silver

Technical data		
Ordering data		
Type	Order No.	Pcs./Pkt.
AB-SK/E	3026476	10
AB-SK/E-NS 35	3213111	10

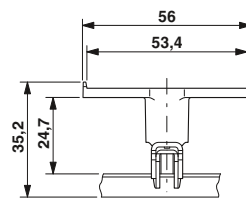

AB-SK/E-NS 35

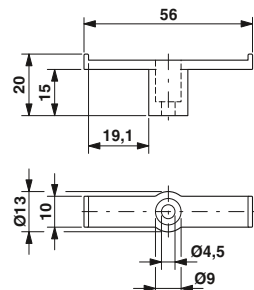

AB-SK/E

SK shield connection clamps

Terminal block	Dimensions [mm]				
	a	b	c	d	e
SK 5	6.5	19.5	46.8	9	6
SK 8	6.5	19.5	48.7	12	9
SK 14	6.5	19.5	59.3	17	14
SK 20	6.5	19.5	75	24	21
SK 28	6.5	20	93	32	28
SK 35	6.5	20	106.5	40	36
SK 5-D	6.5	19.5	46.8	9	6
SK 8-D	6.5	19.5	47.2	12	9
SK 14-D	6.5	19.5	57.8	17	14
SK 20-D	6.5	19.5	73.5	24	21
SK 28-D	6.5	20	91.5	32	28
SK 35-D	6.5	20	105.0	41	36

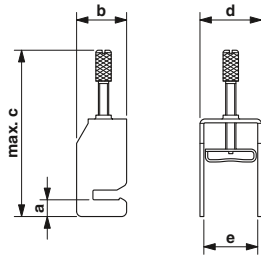

SK ...

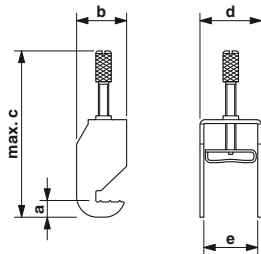

SK ...-D

SKS shield connection clamps

Terminal block	Dimensions [mm]					
	a	b	c	d	e	f
SKS 8	–	18	26	12.4	–	–
SKS 14	–	21	32	19	–	–
SKS 20	–	27	40.5	24.7	–	–
SKS 8-D	–	18	26	12.4	–	–
SKS 14-D	–	21	32	19	–	–
SKS 20-D	–	27	40.5	24.7	–	–
SKS 8-NS35	6	18	26	12.4	52	54
SKS 14-NS35	6	21	32	19	52	60
SKS 20-NS35	6	27	40.5	24.7	52	68.4

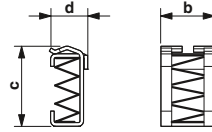

SKS ...

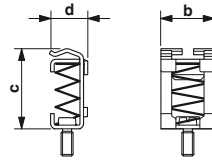

SKS ...-D

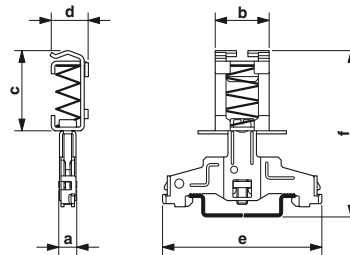

SKS ...-NS35

Drilling and punching patterns for SK ...-D

Punching template

Drilling diagram

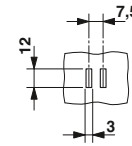

SK 5-D

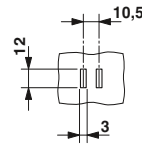
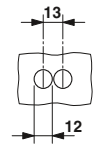

SK 8-D

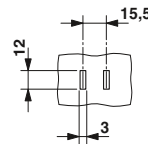
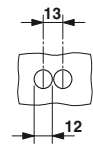

SK 14-D

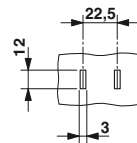
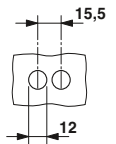

SK 20-D

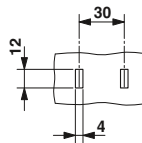
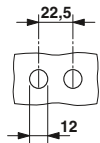

SK 28-D

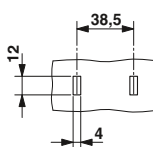
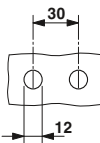

SK 35-D

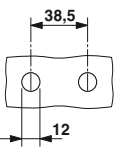

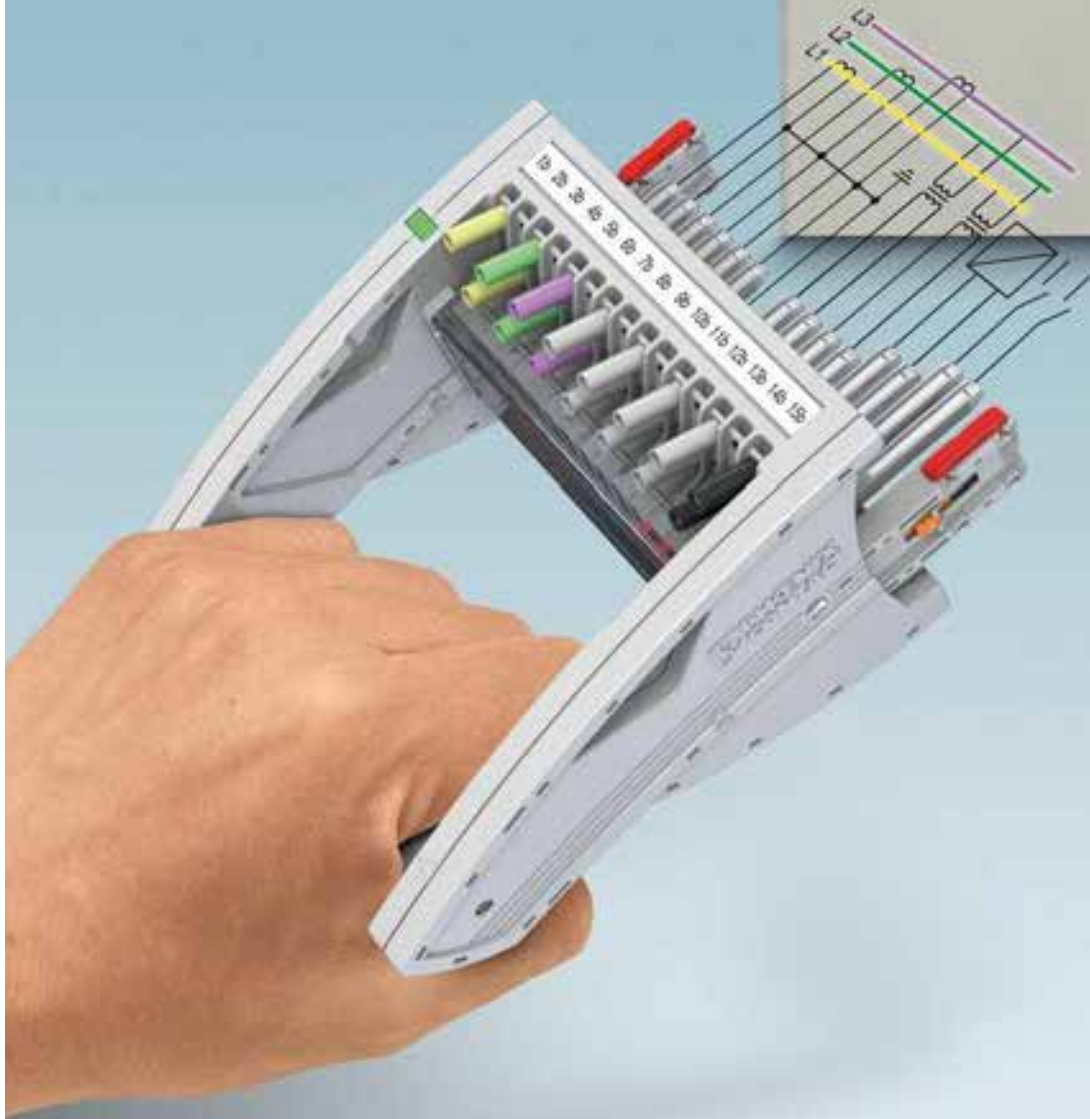
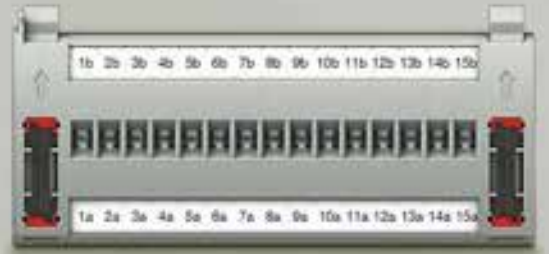

Sector-specific solutions

With CLIPLINE complete, the right terminal block system is available for every industry. The various connection technologies cover the requirements of all applications and uses. Numerous international approvals and comprehensive standard tests ensure safe usage in all branches of industry. Special requirements, such as those affecting the rail industry, shipbuilding or explosion-protected areas in process technology and process engineering, are also taken into account.

We also offer innovative solutions for industry-specific requirements, such as:

- Modular products with system accessories for current transformer test circuits in energy technology
- Marshalling terminals for space-saving, clear wiring in process technology
- Tailor-made solutions to satisfy the requirements of photovoltaics and building installation

Product range overview

Solutions for protection and control engineering	608
Test disconnect terminal blocks for DIN rail mounting	608
Modular plug-in test system with operating plug and transformer short circuit in the plug-in test socket	610
Modular plug-in test system without operating plug and transformer short circuit in the test plug	618
Modular plug-in test system without operating plug and transformer short circuit in the plug-in test socket	632
Snap-Lock plug-in test system	642
Modular 19" plug-in test system without operating plug and transformer short circuit in the plug-in test socket	646
Solutions for process technology	656
Solutions for photovoltaics	658
Solutions for building installation	660

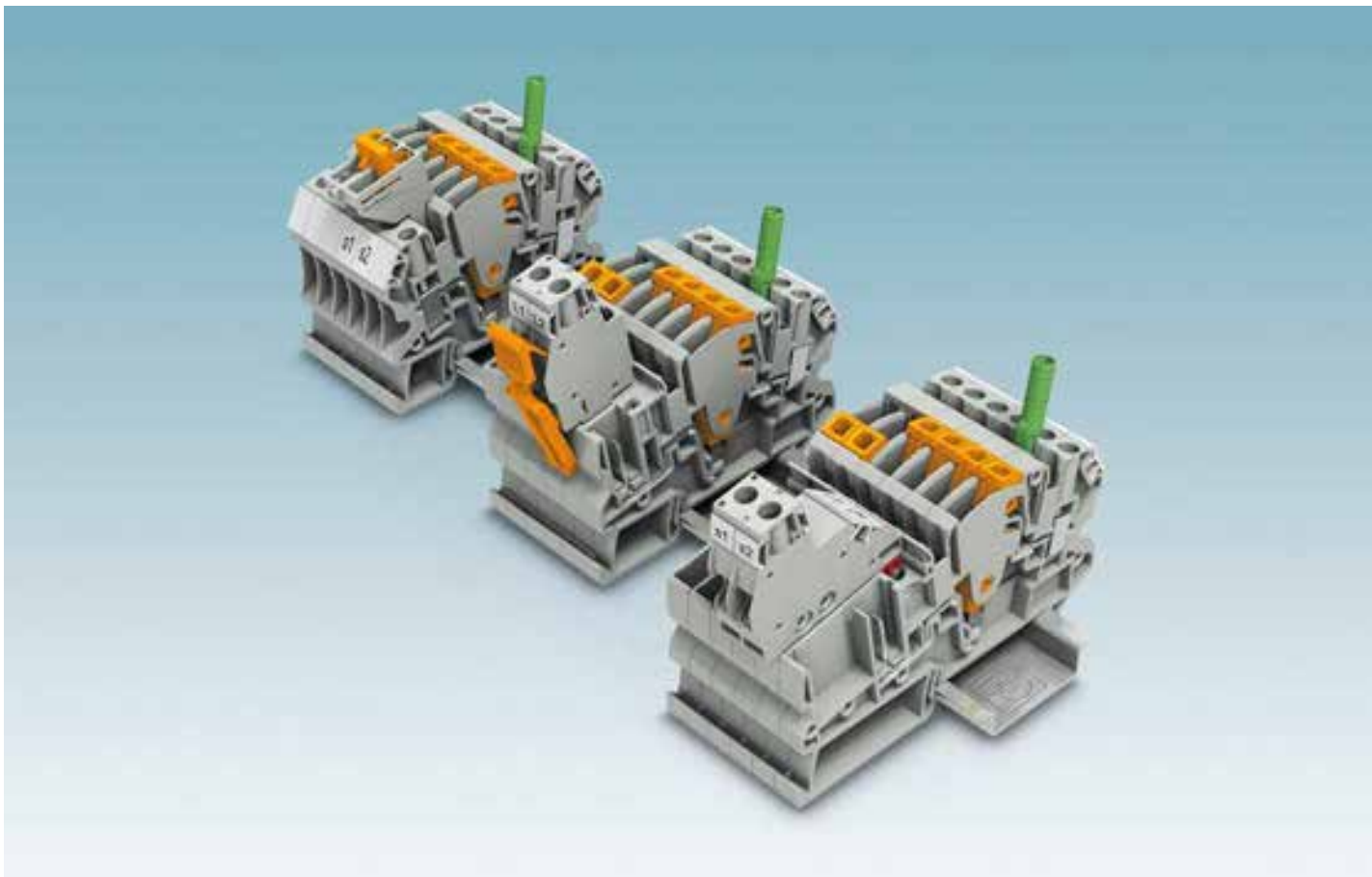

Phoenix Contact has provided the power supply sector with test disconnect terminal blocks for all current transformer and voltage transducer applications for many decades. In addition to the standard modular terminal blocks, the test disconnect terminal blocks are an integral part of the Phoenix Contact product portfolio.

The new ME series test disconnect terminal blocks from the CLIPLINE complete system enable the easy and individual structuring of measuring transducer sets. The plug-in accessories for testing and short circuiting the current transformers as well as the potential distribution can be placed within the terminal strip in accordance with the application. All switching statuses within the terminal strip are clearly visible.

Consistent use of plug-in CLIPLINE complete system accessories helps to reduce mounting and storage costs. This series is also available with Push-in, spring-cage, and screw-connection technology. The current and voltage transformers are particularly easy to wire thanks to the plug-in measuring transducer disconnect terminal blocks. When the patented current transformer plugs are removed, an automatically leading short circuit is ensured. Use of appropriate coding and strain relief accessories also allows the modular and plug-in connection of measuring transducers.

This means that these test disconnect terminal blocks are ideally suited to control and measuring technology – from the counter (smart metering) right through to the secondary technology of switchgear and power stations.

The measuring transducer disconnect terminal blocks can be found in the relevant sections on the respective connection technologies.

i Your web code: [#1095](#)



The triple function shaft on both sides of the longitudinal disconnect point enables the manual placement of bridging, testing, and switching accessories. Non-adjacent plug-in bridges allow the star point to be formed conveniently within the terminal strip, without the need for additional wire bridges.

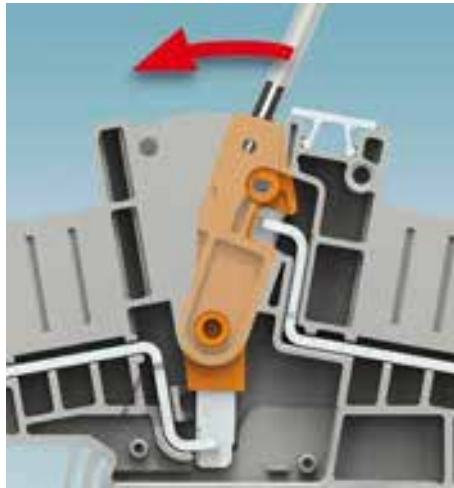

The lengthwise disconnector reliably makes contact and latches with a swiveling movement in the respective switching state. Switching symbols and optional switching locks also ensure a clear overview within the measuring transducer terminal strip.



The plug-in current transformer short-circuit bridges can be used individually, based on the switching task, in the function shafts of the terminal blocks. The switching bridge disconnect element is operated with a screwdriver, which means that the switching operation is only ever activated intentionally.



Feed-through and PE terminal blocks of the same shape are also available for the measuring transducer disconnect terminal blocks. They simplify the addition of attachments to the terminal strip and also enable convenient star point grounding within the terminal strip.



The plug-in current transformer disconnect terminal blocks and plugs also enable the safe plug-in wiring of current transformers. When the transformer plug is removed, a leading current transformer short circuit is automatically ensured. Additional encoding accessories prevent the polarity of the plug from being reversed.

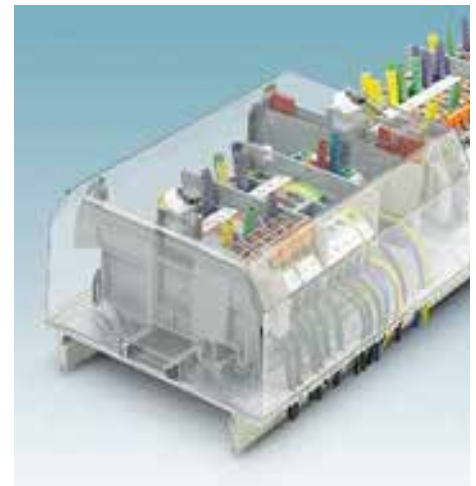

Cover profiles and covering hoods are available as accessories. These can be mounted and sealed on the measuring transducer strip in a way which protects them against external influences and manipulation.

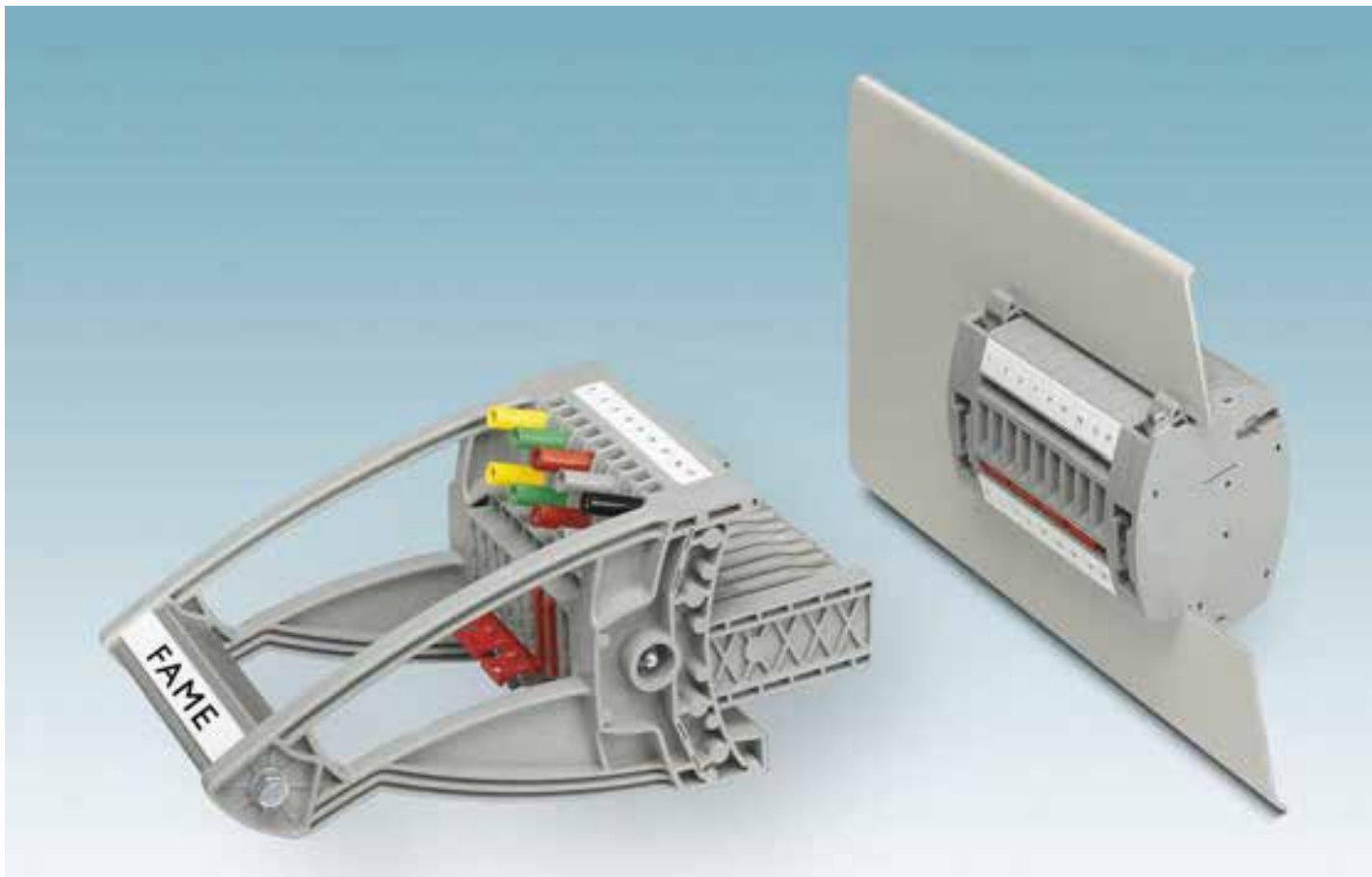

FAME 1 combines complex switching operations for function tests of current and voltage transformers, as well as tripping and signal contacts, in separate compact and space-saving blocks. The system operates in accordance with the N/O contact principle. In normal operation, an operating plug is required. The automatic transformer short circuit function is ensured with plug-in bridges in the test disconnect socket.

Measuring transducer disconnect terminal blocks are specifically tailored to the test circuits in current and voltage transformer secondary circuits. Manual switching operations short circuit current transformers prior to measurements being taken.

The FAME test disconnect system represents the further development of these switchable terminal blocks. FAME is the innovative test disconnect system for all measuring and testing tasks in network protection technology for medium and high-voltage switchgear. The system consists of a test disconnect socket built into the control cabinet panel and the associated operating and test plugs. With this modular system, you can now perform manual testing operations automatically, safely, and more quickly. Suitable for every application, the modular system can be directly integrated into the control cabinet panel. Thanks to its modular, configurable design, FAME is a flexible system which can be used to implement different number of positions. This means that the right solution is available for every circuit diagram.

The FAME test disconnect system is designed for touch proofness for the IP20 degree of protection. Wall mounting enables installation in the control cabinet door. This allows tests to be carried out without having to access the inside of the control cabinet (wiring level), which eliminates the possibility of modifications or manipulation.

The transformer short circuit is at the heart of the system and, when the short-circuit bridge is pre-installed, it is implemented automatically when the operating or test plug is removed. This significantly improves the safety levels during testing and saves time as well.

The system is configured for current transformer and voltage transducer applications using accessories from the CLIPLINE complete system.

i Your web code: #0131



The compact and modular design of the system provides an extensive range of options for every application with positions from 4 to 13. This applies to both the plugs and the test disconnect sockets.

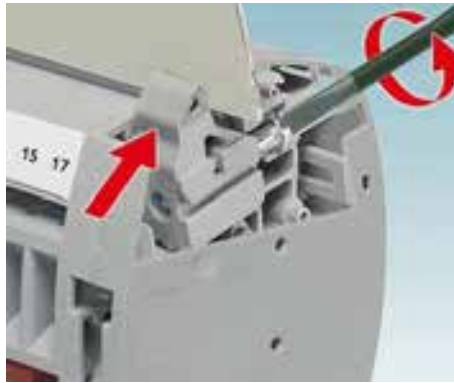

The patented wall fastening is easy to use and has a robust design. Large tolerances in the plate cutout of up to 4 mm are compensated for by the eccentric tappet function.



Thanks to the optional use of plug-in bridges, all test circuits can be implemented in the plug. Staggered test sockets enable the use of safety test leads in a confined space.



The transducer block offers two function shafts for short-circuit bridging configuration on the control cabinet exterior.



In addition to the two marking grooves, the test disconnect sockets for wall mounting also offer two function shafts inside the control cabinet for forming and grounding the star point.



The robust latching of the power plug can only be released with two-hand operation.



The operating plug is protected against unauthorized actuation thanks to the optional seal. The operating plug safely covers the short-circuit bridges and plug openings in normal operation.



Large-surface labeling options on the inside and outside of the control cabinet enable the clear identification of each terminal point.



The pre-assembled test terminal strips can be mounted in a space-saving way in the control cabinet by simply snapping the E-UTWE 6 adapter onto standard NS 35 DIN rails.

FAME 1

Modular plug-in test system with operating plug and transformer short circuit in the plug-in test socket

The switch contact in the plug-in test socket is an N/O contact. In normal operation, the operating plug closes the contact.

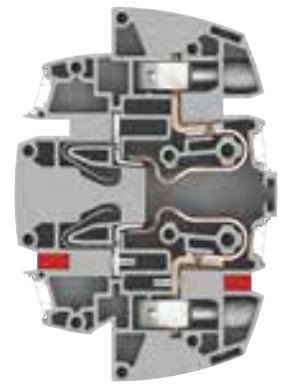

Normal operation

Auxiliary contact open

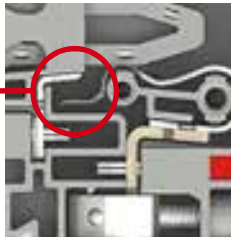

Transformer short circuit

Auxiliary contact closed



Test operation

Auxiliary contact open

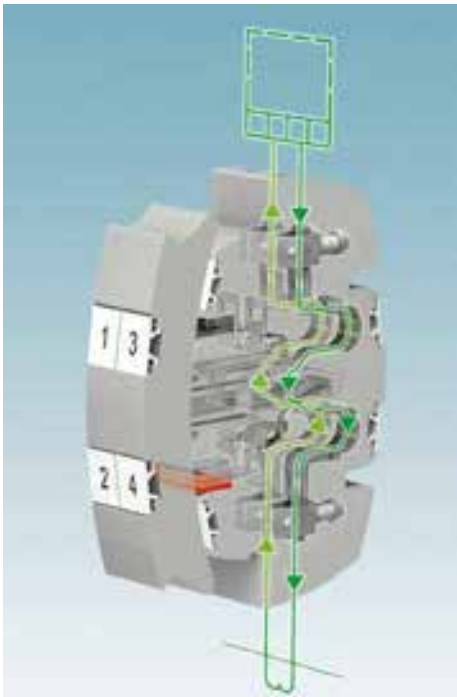
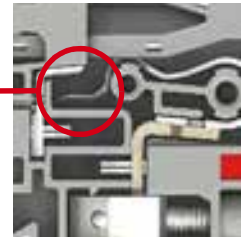

Normal operation

When the operating plug is used, the transformer short circuit is automatically overridden and the measuring transducer operates safely.

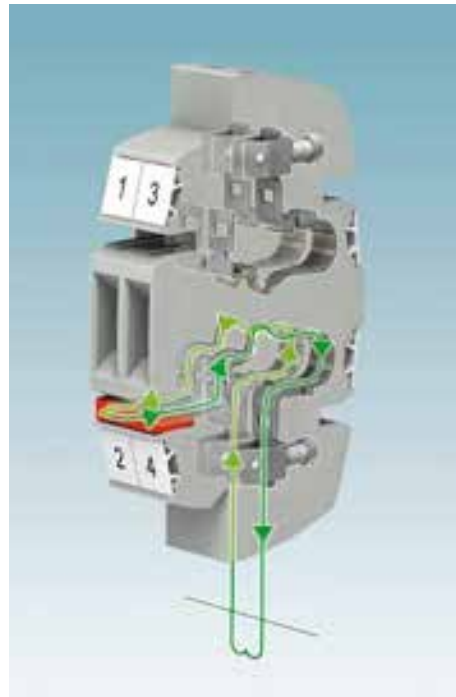

Transformer short circuit

If the plug is removed, the integrated auxiliary contact automatically triggers a leading short circuit when short-circuit bridges are plugged in.

Connected measuring transducers are safely protected against damage.

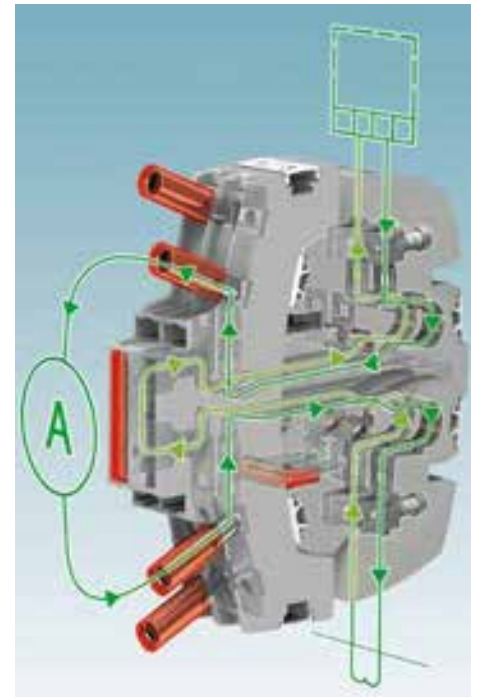

Test operation

When inserting the test plug, the ammeter connected to the test plug is first of all looped into the circuit. Then the transformer short circuit is automatically overridden.

Mains protection – Switching example with sequential switching sequence

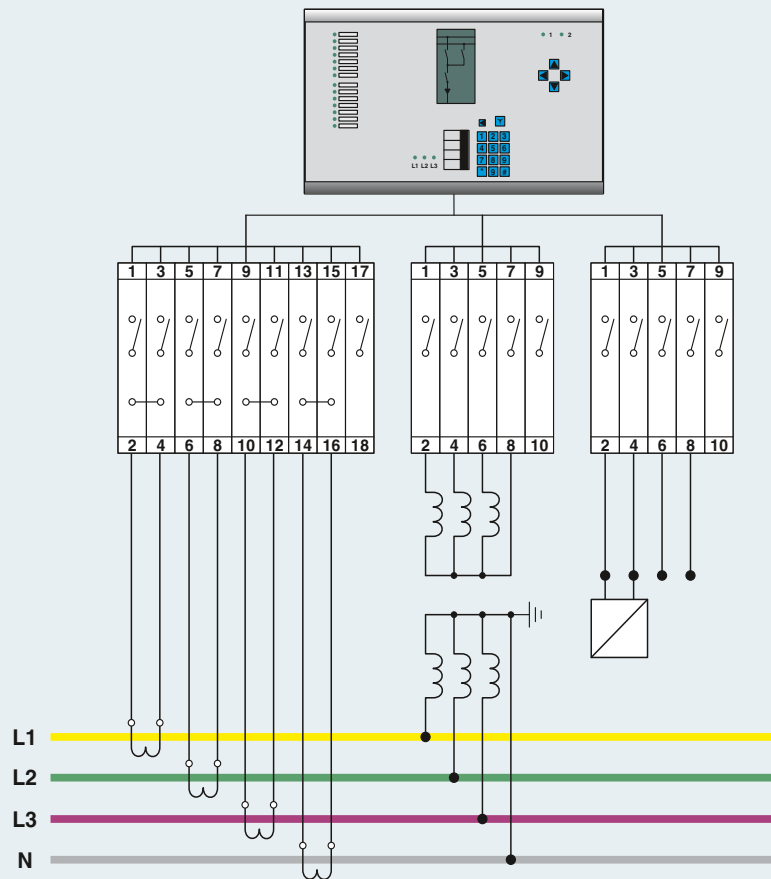

**Plug-in test socket
for current transformers**



**Plug-in test socket
for voltage transducers**



**Plug-in test socket for signal
and tripping contacts**



Plug-in test socket, operating plug, test plug

Type	Order No.	Required quantity
UTWE 6/8+1	3069064	1
FWP 8+1	3069297	1
FTP 8+1	3069242	1
Plug-in bridge		
FBS 2-8	3030284	4

Type	Order No.	Required quantity
UTWE 6/4+1	3069048	1
FWP 4+1	3069271	1
FTP 4+1	3069223	1

Type	Order No.	Required quantity
UTWE 6/4+1	3069048	1
FWP 4+1	3069271	1
FTP 4+1	3069223	1

Measuring transducer block, with connector

Notes:
For further test adapters, test sockets, and connectors for use with screw test sockets, visit phoenixcontact.net/products .
Derating curve on request.
To create panel cutouts, see phoenixcontact.net/products .
1) FAME 6/...BI test blocks are available for standard panel cutouts.



10 (10) mm², 30 A, plug-in test socket, wall mounting



30 A, operating plug



		Technical data			
Maximum electrical data		I _{max} [A]	U _{max} [V]	max. Ø [mm ²]	AWG (UL)
		30	400	0.2 - 10	24-8
Rated data		IEC 60947-7-1			
		IEC	UL / CUL	CSA	IEC/ EN 60079-7
Rated voltage	[V]	400	300	300	-
Nominal current / cross section	[A] / [mm ²]	24 / 6	10	10 / -	-
Rated cross section	[mm ²]	6	-	-	-
Cross section range	AWG	24 - 8	24-8	24-8	-
Connection capacity		Rigid	Flexible	Ferrule	
		without/with plastic sleeve			
1 conductor	[mm ²]	0.2 - 10	0.2 - 10	0.25 - 6	0.25 - 6
2 conductors (of the same type)	[mm ²]	0.2 - 2.5	0.2 - 2.5	0.25 - 1.5	-
2 flexible conductors with a TWIN ferrule	[mm ²]	-	-	-	0.5 - 2.5
General data					
Stripping length	[mm]	10			
Screw thread		M4			
Tightening torque	[Nm]	1.5 - 1.8			
Tightening torque for wall fastening	[Nm]	0.8 - 1			
Panel thickness	[mm]	1 - 4			
Tightening torque: test socket screw	[Nm]	-			
Insulating material		PA			
Flammability rating in accordance with UL 94		V0			

		Technical data			
Maximum electrical data		I _{max} [A]	U _{max} [V]	max. Ø [mm ²]	AWG (UL)
		30	400	-	-
Rated data		IEC 60947-7-1			
		IEC	UL / CUL	CSA	IEC/ EN 60079-7
Rated voltage	[V]	400	-	-	-
Nominal current / cross section	[A] / [mm ²]	24 / 6	-	-	-
Rated cross section	[mm ²]	6	-	-	-
Cross section range	AWG	-	-	-	-
Connection capacity		Rigid	Flexible	Ferrule	
		without/with plastic sleeve			
1 conductor	[mm ²]	-	-	-	-
2 conductors (of the same type)	[mm ²]	-	-	-	-
2 flexible conductors with a TWIN ferrule	[mm ²]	-	-	-	-
General data					
Stripping length	[mm]	-			
Screw thread		-			
Tightening torque	[Nm]	-			
Tightening torque for wall fastening	[Nm]	-			
Panel thickness	[mm]	-			
Tightening torque: test socket screw	[Nm]	-			
Insulating material		PA			
Flammability rating in accordance with UL 94		V0			

Description	No. of pos.	Color
Plug-in test system, 4-pos.		gray
Plug-in test system, 5-pos.		gray
Plug-in test system, 5-pos. ¹⁾		gray
Plug-in test system, 6-pos.		gray
Plug-in test system, 7-pos.		gray
Plug-in test system, 7-pos. ¹⁾		gray
Test disconnect system, 8-pos.		gray
Plug-in test system, 9-pos.		gray
Plug-in test system, 10-pos.		gray
Plug-in test system, 11-pos.		gray
Plug-in test system, 12-pos.		gray
Plug-in test system, 13-pos.		gray

Ordering data			
Type	I _{max}	Order No.	Pcs./Pkt.
UTWE 6/3+1		3069047	5
UTWE 6/4+1		3069048	5
UTWE 6/4+1 BI		3070008	5
UTWE 6/5+1		3069049	5
UTWE 6/6+1		3069051	5
UTWE 6/6+1 BI		3069996	5
UTWE 6/7+1		3069065	5
UTWE 6/8+1		3069064	5
UTWE 6/9+1		1029711	5
UTWE 6/10+1		1029712	5
UTWE 6/11+1		1029713	5
UTWE 6/12+1		3069077	5

Ordering data			
Type	Order No.	Pcs./Pkt.	
FWP 3+1	3069270	5	
FWP 4+1	3069271	5	
FWP 4+1	3069271	5	
FWP 5+1	3069272	5	
FWP 6+1	3069284	5	
FWP 6+1	3069284	5	
FWP 7+1	3069298	5	
FWP 8+1	3069297	5	
FWP 9+1	1029715	5	
FWP 10+1	1029716	5	
FWP 11+1	1029717	5	
FWP 12+1	3069307	5	

Accessories		
Description	No. of pos.	Color
Plug-in bridge	2	red
	3	red
	5	red
Pre-assembled bridge, labeled		
3-pos., positions 1, 3	3	red
4-pos., positions 1, 4	4	red
5-pos., positions 1, 3, 5	5	red
10-pos., positions 1, 4, 7, 10	10	red
Test socket, insulated		transparent
		red
		blue
		yellow
		green
Fork-type cable lug, non-isolated DIN 46234		silver
		silver
Fork-type cable lug, insulated, in accordance with UL		red
		blue
Screwdriver		

Accessories			
Type	I _{max}	Order No.	Pcs./Pkt.
FBS 2-8	24 A	3030284	10
FBS 3-8	24 A	3030297	10
FBS 5-8	24 A	3030310	10
FBS 1/3-8	24 A	3032363	10
FBS 1/4-8	24 A	3032376	10
FBS 1/3/5-8	24 A	3032389	10
FBS 1/4/7/10-8	24 A	3032402	10
SF-SL 0.8X4,0-100		1212551	10

Accessories			
Type	Order No.	Pcs./Pkt.	
UC-TM 8, UCT-TM 8 or ZB 8 (see Catalog 3)			

UC-TM 8, UCT-TM 8 or ZB 8 (see Catalog 3)

UC-TM 8, UCT-TM 8 or ZB 8 (see Catalog 3)

DIN rail adapters



The pre-assembled terminal block bases reduce mounting and storage costs. The right terminal block base is available for every function.

- The DIN rail adapters have a robust metal foot
- Secure connection to the DIN rail by simply screwing tight

		Ordering data		
Description	Color	Type	Order No.	Pcs./Pkt.
DIN rail adapter	gray	E-UTWE 6	3069055	10

Covers

- The AP RSC-T cover profile can be mounted from the inside of the control cabinet using the FAME 1 test terminal strip
- Terminal block screws are protected against unauthorized operation
- The APH-UTWE 6 cover profile carrier is mounted by simply snapping it onto the test disconnect socket on the right and left-hand side



		Ordering data			Ordering data		
Description	Color	Type	Order No.	Pcs./Pkt.	Type	Order No.	Pcs./Pkt.
Cover profile, supply length 1 m	transparent	AP RSC-T	3059139	10			
Cover profile carrier, can be snapped into place and sealed	gray				APH-UTWE 6	3069056	10

Cable ties for securing test cables



- WT-D HF 7,5x200 removable cable ties can be used to easily secure test cables to an FTP FAME 1 test plug
- The cable tie base is simply unscrewed at the grip. The knurled screw is removed and then secured together with the base



		Ordering data		
Description	Color	Type	Order No.	Pcs./Pkt.
Cable tie base , for cable ties of up to 9 mm width, screwable, 5 mm fixing hole, dimensions: 14.6 x 22 mm	transparent	WT-BASE HF 9	3240704	100
Cable tie , maximum bundle Ø [mm]/minimum tensile strength [N]	transparent	WT-D HF 7,5X200	3240712	100
50 / 220	transparent			

Colored PSBJ ... test sockets



- 4 mm safety test leads with fixed insulation in accordance with EN 61010-031 CAT III and CAT IV up to 1000 V can be coded in true color
- Additional test leads, assembled with ring and fork-type cable lugs (see accessories, e.g., page 624) can be attached with test sockets



		Ordering data		
Description	Color	Type	Order No.	Pcs./Pkt.
Test socket , insulated	transparent	PSBJ-URTK 6 FARBLOS	3026450	10
	red	PSBJ-URTK 6 RD	3026719	10
	blue	PSBJ-URTK 6 BU	3026434	10
	yellow	PSBJ-URTK 6 YE	3026405	10
	green	PSBJ-URTK 6 GN	3026418	10
	violet	PSBJ-URTK 6 VT	3026421	10
	black	PSBJ-URTK 6 BK	3026447	10
	gray	PSBJ-URTK 6 GY	3026612	10
	brown	PSBJ-URTK 6 BN	3026971	10
	white	PSBJ-URTK 6 WH	3026448	10



FAME 2, the test disconnect system without operating plug, combines complex switching operations for function tests of current transformers and voltage transducers, as well as tripping and signal contacts, into just one compact and space-saving block. The system operates in accordance with the N/C contact principle. An operating plug is not required. Plug-in bridges in the test plug ensure an automatic transducer short-circuit function.

i Your web code: #0131



The test plug is completely inserted and engaged, the display window turns red. All test contacts are contacted in accordance with the test setup.



The rotary handle is turned upward as far as it will go, the display window turns yellow. Test contacts with short contact tab lengths (e.g., current transformers) are once again through-connected to the protective device.



The rotary handle is turned back to its starting position. Now the mechanism releases the plug so it can be fully removed. The display window turns green.



Programmed short-circuit and switching operations depend on consistent insertion and removal of the test plug. Undefined contact states are effectively avoided, thanks to the rotary handle mechanism.

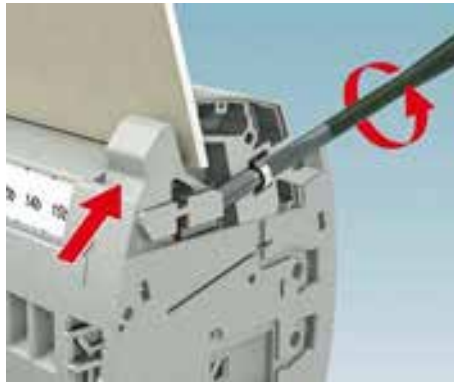

The patented wall fastening is easy to use and has a robust design. Large tolerances in the sheet metal cutout of up to 4 mm are compensated for by the eccentric tappet function.

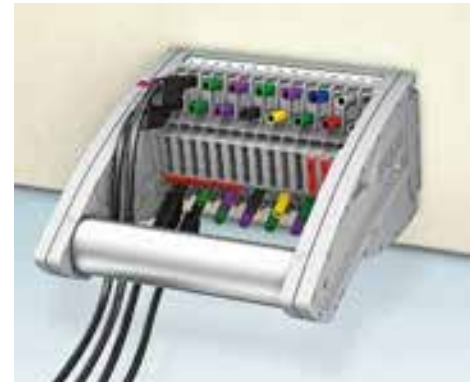

The offset test socket arrangement enables the use of CAT III and CAT IV/1000 V safety test leads in accordance with EN 61010-031 in a confined space.



FAME test terminal strips have an IP20 design. Blind plugs without switching function can be inserted and secured with seals. These can only be released with two-hand operation.



In addition to the two marking grooves, the test terminal strips for wall mounting also offer two function shafts, or six function shafts in the case of the DIN rail version, inside the control cabinet for forming and grounding the star point.



The compact and modular design of the system provides an extensive range of options for every application with positions from 4 to 25. This applies to both the plugs and the test disconnect sockets.



The test plug provides three function shafts between the 4 mm test contacts. Horizontally aligned, as leading short-circuit bridge – vertically aligned as through connection in the plug.



The coding profiles are applied by the user in accordance with their application. VDE-compliant versions are pre-coded on delivery. This ensures maximum safety.



All applications which do not involve testing through the closed door, as well as the open rack mounting, can be implemented with the DIN rail version. Terminal points and plug-in zone can be operated from one direction.

FAME 2

Modular plug-in test system without operating plug and transformer short circuit in the test plug

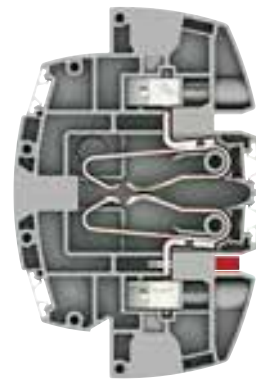

The switch contact in the plug-in test socket is a N/C contact. In normal operation the contact is closed.

Thanks to the FAME 2 system's opening function, additional operating plugs are not required for normal operation.

Normal operation

Closed switch contact

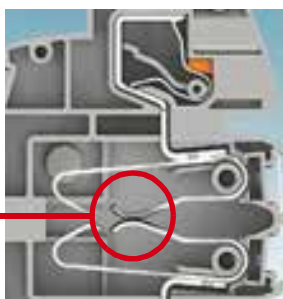

Transformer short circuit

Leading short circuit by means of auxiliary contact

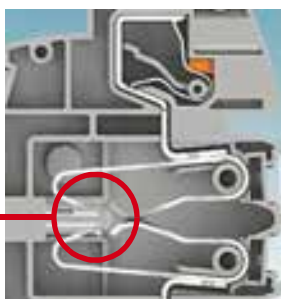

Test operation

Switch contact connected via test socket

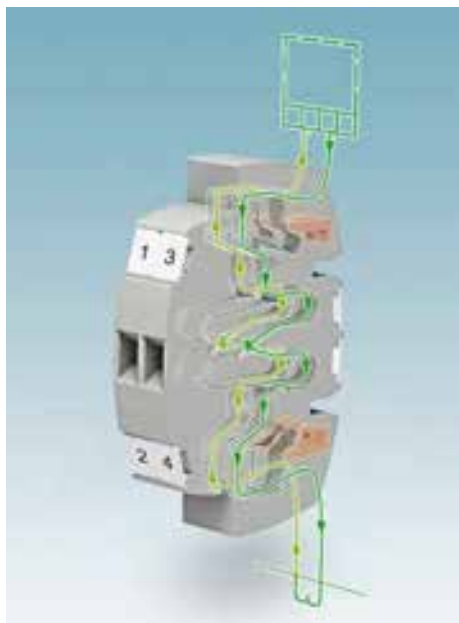

Normal operation

Additional operating plugs are not required for normal operation; the measuring transducer operates safely and reliably. If desired, the plug-in zone can be covered and sealed with a blind plug to prevent unauthorized access.

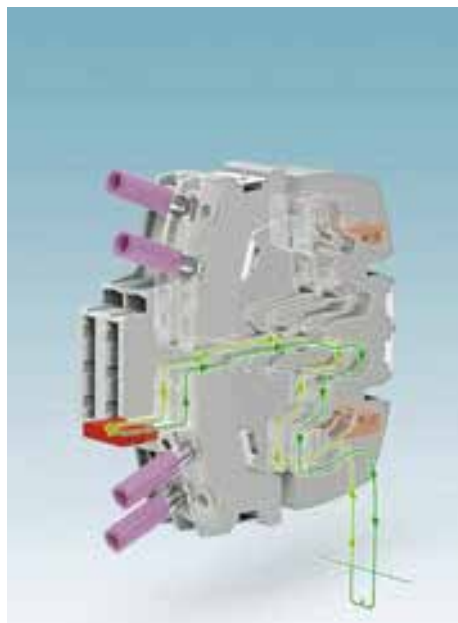

Transformer short circuit

When replacing the protective device or in the case of a relay test, the current transformer can be short circuited upstream of the signal splitting by inserting a plug-in bridge crossways.

Connected measuring transducers are safely protected against damage.

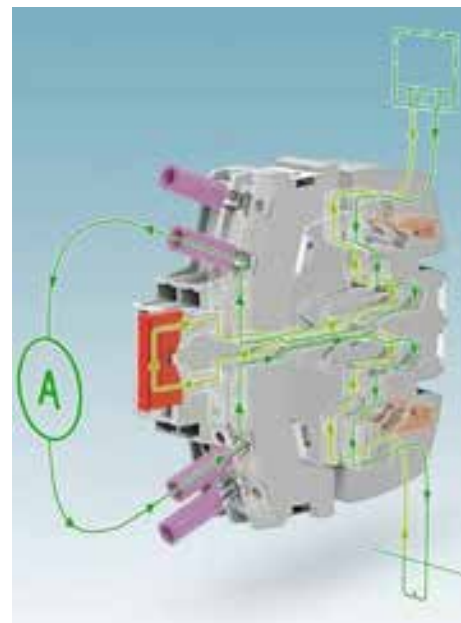

Test operation

With the bridge inserted lengthways in the test plug, test equipment can be looped into the current path via the 4 mm test sockets.

Mains protection – Circuit example with star point grounding in the plug-in test socket

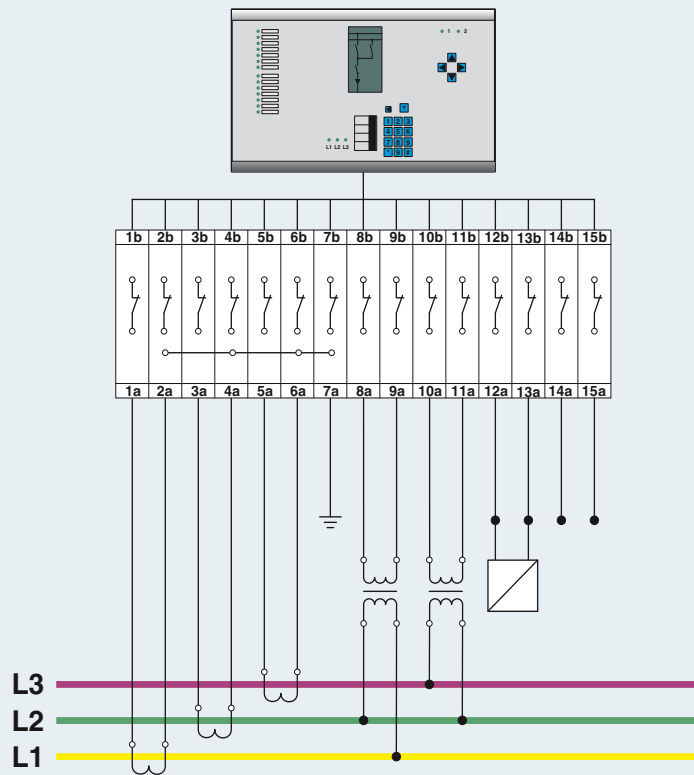

Plug-in test socket for DIN rail mounting with current transformer, voltage transducer, and signals

Test plug with current transformer, voltage transducer, and signals

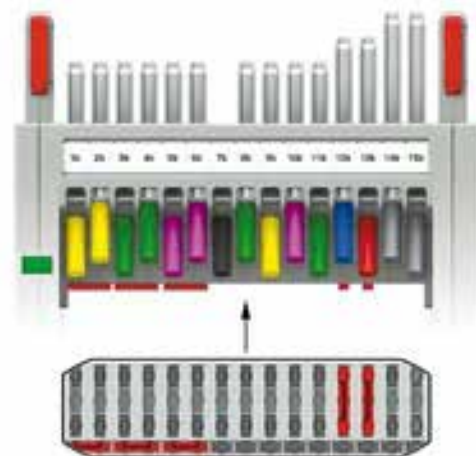
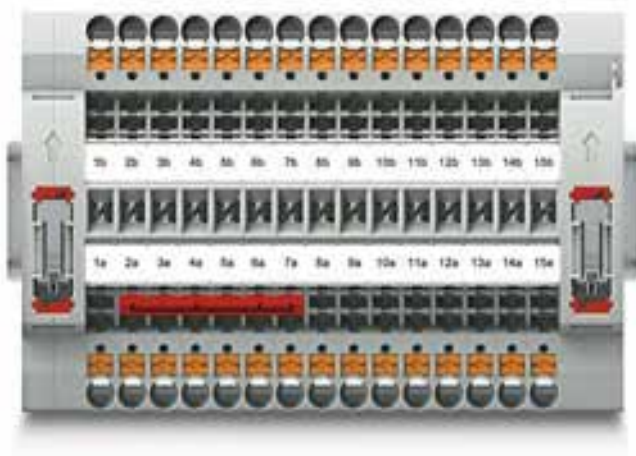

Plug-in test socket, blind plug

Type	Order No.	Required quantity
PTRE 6-2/15	3069864	1
FBP 2/15	3069886	1
Plug-in bridge		
FBS 6-8	3032470	1

Test plug

Type	Order No.	Required quantity
FTPR 2/15	3001693	1
Plug-in bridge		
FBS 2-8	3030284	3
FBS 1/3-8	3032363	2

Test terminal strip, with Push-in connection or screw connection



The modular FAME measuring transducer test system enables all transformer testing tasks to be carried out quickly and safely. The transformer is short-circuited and the test device is looped in automatically when inserted.

- The test terminal strips can be used universally for current and voltage transducers
- The test disconnect socket is mounted in the control cabinet door or on the DIN rail
- Signal and status messages can be wired in combination in a test terminal strip
- The correct switching sequence when removing the test plug is ensured by a locking device and a mechanical drive in the rotary handle
- All test signals are connected with touch-proof safety test cables (CAT III and CAT IV/1000 V in accordance with EN 61010-031)
- All versions listed can be equipped with coding for the matching test plug
- Star points of the current transformers can easily be created with FBS ... plug-in bridges on the rear of the plug-in test socket
- You can find corresponding accessories from page 627

Notes:
To create panel cutouts, see phoenixcontact.net/products.
For further plug-in bridges, see page 628.
1) Derating curve available on request.
2) Test surge voltage 5 kV.

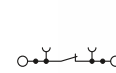

6 (10) mm², 30 A, 4 ... 25-pos. test terminal strip, for wall mounting, Push-in connection



Maximum electrical data	
Rated data	
Rated voltage	[V] 400 ²⁾
Nominal current / cross section	[A] / [mm ²] 24 ¹⁾ / 6
Rated cross section	[mm ²] 6
Cross section range	AWG 20 - 8
Connection capacity	
1 conductor	[mm ²] 0.5 - 10
2 conductors (of the same type)	[mm ²] -
2 flexible conductors with a TWIN ferrule	[mm ²] -
Connection cross sections directly plug-in	[mm ²] 1 - 10
General data	
Stripping length	[mm] 12
Screw thread	-
Tightening torque	[Nm] -
Tightening torque for wall fastening	[Nm] 0.8 - 1
Panel thickness	[mm] 1 - 4
Insulating material	PA
Flammability rating in accordance with UL 94	V0

Technical data			
I _{max} [A]	U _{max} [V]	max. Ø [mm ²]	AWG (UL)
30	400 ²⁾	0.5 - 10	20-8
IEC 60947-7-1			
IEC	UL / CUL	CSA	IEC/EN 60079-7
Connection capacity		Ferrule	
Rigid	Flexible	without/with plastic sleeve	
0.5 - 10	0.5 - 6	0.5 - 6	0.5 - 6
-	-	-	-
-	-	-	0.5 - 1.5
1 - 10	-	1 - 6	1 - 6

Description	Color
Test terminal strip, 4-pos.	gray
5-pos.	gray
6-pos.	gray
7-pos.	gray
8-pos.	gray
9-pos.	gray
10-pos.	gray
11-pos.	gray
12-pos.	gray
13-pos.	gray
14-pos.	gray
15-pos.	gray
16-pos.	gray
17-pos.	gray
18-pos.	gray
19-pos.	gray
20-pos.	gray
21-pos.	gray
22-pos.	gray
23-pos.	gray
24-pos.	gray
25-pos.	gray

Ordering data		
Type	Order No.	Pcs./Pkt.
PTWE 6-2/4	3069827	1
PTWE 6-2/5	3069828	1
PTWE 6-2/6	3069829	1
PTWE 6-2/7	3069830	1
PTWE 6-2/8	3069831	1
PTWE 6-2/9	3069832	1
PTWE 6-2/10	3069833	1
PTWE 6-2/11	3069834	1
PTWE 6-2/12	3069835	1
PTWE 6-2/13	3069836	1
PTWE 6-2/14	3069837	1
PTWE 6-2/15	3069838	1
PTWE 6-2/16	3069839	1
PTWE 6-2/17	3069840	1
PTWE 6-2/18	3069841	1
PTWE 6-2/19	3069842	1
PTWE 6-2/20	3069843	1
PTWE 6-2/21	3069844	1
PTWE 6-2/22	3069845	1
PTWE 6-2/23	3069846	1
PTWE 6-2/24	3069847	1
PTWE 6-2/25	3069848	1

Cover profile , supply length 1 m	transparent
Cover profile holder , can be snapped on and sealed	gray
Cover profile , supply length 1 m	transparent
Cover profile carrier , sealable, for AP-ME cover profile	gray
Cover profile carrier , for AP-ME	gray
Screwdriver	

Accessories		
AP RSC-T	3059139	10
APH-UTWE 6-2	3069057	10
SF-SL 0,8X4,0-100	1212551	10

Lateral groove labeling

UC-TM 8, UCT-TM 8, ZB 8 or TMT (EX9,5)R (see Catalog 3)

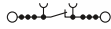

6 (10) mm², 30 A, 4 ... 25-pos. test terminal strip, for DIN rail mounting, Push-in connection

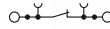

10 (10) mm², 30 A, 4 ... 25-pos. plug-in test socket, for wall mounting, screw connection



10 (10) mm², 30 A, 4 ... 25-pos. plug-in test socket, for DIN rail mounting, screw connection



Technical data			
I _{max} [A]	U _{max} [V]	max. Ø [mm ²]	AWG (UL)
30	400 ²⁾	0.5 - 10	20-8
IEC 60947-7-1			
IEC		UL / CUL	CSA
			IEC/ EN 60079-7
400 ²⁾	300	600	-
24 ¹⁾ / 6	10	20 / -	-
6	-	-	-
20 - 8	20-8	20-8	-
Rigid	Flexible	Ferrule	
without/with plastic sleeve			
0.5 - 10	0.5 - 6	0.5 - 6	0.5 - 6
-	-	-	-
-	-	-	0.5 - 1.5
1 - 10	-	1 - 6	1 - 6
12			
-			
-			
-			
-			
PA			
V0			

Technical data			
I _{max} [A]	U _{max} [V]	max. Ø [mm ²]	AWG (UL)
30	400 ²⁾	0.2 - 10	24-8
IEC 60947-7-1			
IEC		UL / CUL	CSA
			IEC/ EN 60079-7
400 ²⁾	300	300	-
24 ¹⁾ / 6	10	10 / -	-
6	-	-	-
24 - 8	24-8	24-8	-
Rigid	Flexible	Ferrule	
without/with plastic sleeve			
0.2 - 10	0.2 - 10	0.25 - 6	0.25 - 6
0.2 - 2.5	0.2 - 2.5	0.25 - 1.5	-
-	-	-	0.5 - 2.5
-	-	-	-
12			
M4			
1.5 - 1.8			
0.8 - 1			
1 - 4			
PA			
V0			

Technical data			
I _{max} [A]	U _{max} [V]	max. Ø [mm ²]	AWG (UL)
30	400 ²⁾	0.2 - 10	24-8
IEC 60947-7-1			
IEC		UL / CUL	CSA
			IEC/ EN 60079-7
400 ²⁾	300	300	-
24 ¹⁾ / 6	10	10 / -	-
6	-	-	-
24 - 8	24-8	24-8	-
Rigid	Flexible	Ferrule	
without/with plastic sleeve			
0.2 - 10	0.2 - 10	0.25 - 6	0.25 - 6
0.2 - 2.5	0.2 - 2.5	0.25 - 1.5	-
-	-	-	0.5 - 2.5
-	-	-	-
10			
M4			
1.5 - 1.8			
-			
-			
PA			
V0			

Ordering data		
Type	Order No.	Pcs./Pkt.
PTRE 6-2/4	3069849	1
PTRE 6-2/5	3069850	1
PTRE 6-2/6	3069851	1
PTRE 6-2/7	3069852	1
PTRE 6-2/8	3069853	1
PTRE 6-2/9	3069854	1
PTRE 6-2/10	3069855	1
PTRE 6-2/11	3069860	1
PTRE 6-2/12	3069861	1
PTRE 6-2/13	3069862	1
PTRE 6-2/14	3069863	1
PTRE 6-2/15	3069864	1
PTRE 6-2/16	3069865	1
PTRE 6-2/17	3069866	1
PTRE 6-2/18	3069867	1
PTRE 6-2/19	3069868	1
PTRE 6-2/20	3069869	1
PTRE 6-2/21	3069870	1
PTRE 6-2/22	3069871	1
PTRE 6-2/23	3069872	1
PTRE 6-2/24	3069873	1
PTRE 6-2/25	3069874	1

Ordering data		
Type	Order No.	Pcs./Pkt.
UTWE 6-2/4	3069650	1
UTWE 6-2/5	3069651	1
UTWE 6-2/6	3069652	1
UTWE 6-2/7	3069654	1
UTWE 6-2/8	3069655	1
UTWE 6-2/9	3069656	1
UTWE 6-2/10	3069658	1
UTWE 6-2/11	3069659	1
UTWE 6-2/12	3069660	1
UTWE 6-2/13	3069662	1
UTWE 6-2/14	3069663	1
UTWE 6-2/15	3069664	1
UTWE 6-2/16	3069666	1
UTWE 6-2/17	3069667	1
UTWE 6-2/18	3069668	1
UTWE 6-2/19	3069672	1
UTWE 6-2/20	3069673	1
UTWE 6-2/21	3069800	1
UTWE 6-2/22	3069801	1
UTWE 6-2/23	3069802	1
UTWE 6-2/24	3069803	1
UTWE 6-2/25	3069804	1

Ordering data		
Type	Order No.	Pcs./Pkt.
UTRE 6-2/4	3069805	1
UTRE 6-2/5	3069806	1
UTRE 6-2/6	3069807	1
UTRE 6-2/7	3069808	1
UTRE 6-2/8	3069809	1
UTRE 6-2/9	3069810	1
UTRE 6-2/10	3069811	1
UTRE 6-2/11	3069812	1
UTRE 6-2/12	3069813	1
UTRE 6-2/13	3069814	1
UTRE 6-2/14	3069815	1
UTRE 6-2/15	3069816	1
UTRE 6-2/16	3069817	1
UTRE 6-2/17	3069818	1
UTRE 6-2/18	3069819	1
UTRE 6-2/19	3069820	1
UTRE 6-2/20	3069821	1
UTRE 6-2/21	3069822	1
UTRE 6-2/22	3069823	1
UTRE 6-2/23	3069824	1
UTRE 6-2/24	3069825	1
UTRE 6-2/25	3069826	1

Accessories			
		Order No.	Pcs./Pkt.
AP-ME	METER	3034361	10
APH-ME		3034374	10
APT-ME		3034358	10
SF-SL 0,8X4,0-100		1212551	10

Accessories			
		Order No.	Pcs./Pkt.
AP RSC-T		3059139	10
APH-UTWE 6-2		3069057	10
SF-SL 0,8X4,0-100		1212551	10

Accessories			
		Order No.	Pcs./Pkt.
AP-ME	METER	3034361	10
APH-ME		3034374	10
APT-ME		3034358	10
SF-SL 0,8X4,0-100		1212551	10

UC-TM 8, UCT-TM 8, ZB 8 or TMT (EX9,5)R (see Catalog 3)

UC-TM 8, UCT-TM 8, ZB 8 or TMT (EX9,5)R (see Catalog 3)

UC-TM 8, UCT-TM 8, ZB 8 or TMT (EX9,5)R (see Catalog 3)

Sector-specific solutions

Solutions for protection and control engineering

Test plug, multi-position, freely-configurable contact tabs FTPR ... and FTP ...

- The test plugs can be easily configured and ordered with just a click of the mouse in the product area on our website at phoenixcontact.net/products
- To order via fax or e-mail, please use the ordering data as shown in the ordering example on the following page

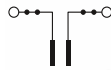

24 A, test plug with twist grip, 4 mm test sockets

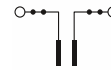

24 A, test plug without rotary handle, 4 mm test sockets



Technical data				
Maximum electrical data				
I_{max} [A]	U_{max} [V]	max. Ø [mm ²]	AWG (UL)	
24	400	0.5 - 2.5	-	
Rated data				
IEC	UL / CUL	CSA	IEC/ EN 60079-7	
400	-	-	-	
Nominal current / cross section [A] / [mm ²]	24 / 2.5	-	-	
Rated cross section [mm ²]	6	-	-	
Cross section range AWG	20 - 14	-	-	
Connection capacity				
1 conductor [mm ²]	Rigid	Flexible	Ferrule without/with plastic sleeve	
-	-	0.5 - 2.5	-	
General data				
Tightening torque: test socket screw [Nm]	0.5 - 0.6			
Insulating material	PA			
Flammability rating in accordance with UL 94	V0			



Technical data				
Maximum electrical data				
I_{max} [A]	U_{max} [V]	max. Ø [mm ²]	AWG (UL)	
24	400	0.5 - 2.5	-	
Rated data				
IEC	UL / CUL	CSA	IEC/ EN 60079-7	
400	-	-	-	
Nominal current / cross section [A] / [mm ²]	24 / 2.5	-	-	
Rated cross section [mm ²]	6	-	-	
Cross section range AWG	20 - 14	-	-	
Connection capacity				
1 conductor [mm ²]	Rigid	Flexible	Ferrule without/with plastic sleeve	
-	-	0.5 - 2.5	-	
General data				
Tightening torque: test socket screw [Nm]	0.5 - 0.6			
Insulating material	PA			
Flammability rating in accordance with UL 94	V0			

Ordering data				
Description	Color	Type	Order No.	Pcs./Pkt.
Test plug	gray	FTPR-2/4	3001681	1
5-pos.	gray	FTPR-2/5	3001683	1
6-pos.	gray	FTPR-2/6	3001684	1
7-pos.	gray	FTPR-2/7	3001685	1
8-pos.	gray	FTPR-2/8	3001686	1
9-pos.	gray	FTPR-2/9	3001687	1
10-pos.	gray	FTPR-2/10	3001688	1
11-pos.	gray	FTPR-2/11	3001689	1
12-pos.	gray	FTPR-2/12	3001690	1
13-pos.	gray	FTPR-2/13	3001691	1
14-pos.	gray	FTPR-2/14	3001692	1
15-pos.	gray	FTPR-2/15	3001693	1
16-pos.	gray	FTPR-2/16	3001694	1
17-pos.	gray	FTPR-2/17	3001696	1
18-pos.	gray	FTPR-2/18	3001697	1
19-pos.	gray	FTPR-2/19	3001698	1
20-pos.	gray	FTPR-2/20	3001699	1
21-pos.	gray	FTPR-2/21	3001700	1
22-pos.	gray	FTPR-2/22	3001701	1
23-pos.	gray	FTPR-2/23	3001702	1
24-pos.	gray	FTPR-2/24	3001703	1
25-pos.	gray	FTPR-2/25	3001704	1

Ordering data				
Description	Color	Type	Order No.	Pcs./Pkt.
Test plug	gray	FTP-2/4	3001706	1
5-pos.	gray	FTP-2/5	3001707	1
6-pos.	gray	FTP-2/6	3001708	1
7-pos.	gray	FTP-2/7	3001709	1
8-pos.	gray	FTP-2/8	3001710	1
9-pos.	gray	FTP-2/9	3001711	1
10-pos.	gray	FTP-2/10	3001712	1
11-pos.	gray	FTP-2/11	3001713	1
12-pos.	gray	FTP-2/12	3001714	1
13-pos.	gray	FTP-2/13	3001715	1
14-pos.	gray	FTP-2/14	3001716	1
15-pos.	gray	FTP-2/15	3001717	1
16-pos.	gray	FTP-2/16	3001719	1
17-pos.	gray	FTP-2/17	3001720	1
18-pos.	gray	FTP-2/18	3001722	1
19-pos.	gray	FTP-2/19	3001723	1
20-pos.	gray	FTP-2/20	3001724	1
21-pos.	gray	FTP-2/21	3001725	1
22-pos.	gray	FTP-2/22	3001726	1
23-pos.	gray	FTP-2/23	3001727	1
24-pos.	gray	FTP-2/24	3001728	1
25-pos.	gray	FTP-2/25	3001729	1

Accessories				
Description	Color	Type	Order No.	Pcs./Pkt.
Fork-type cable lug , insulated, in accordance with UL	red	C-FCI 1,5/M3	3240032	100
	blue	C-FCI 2,5/M3	3240037	100
Ring cable lug , insulated, in accordance with UL	red	C-RCI 1,5/M3	3240016	100
	blue	C-RCI 2,5/M3	3240021	100

Accessories				
Description	Color	Type	Order No.	Pcs./Pkt.
Fork-type cable lug , insulated, in accordance with UL	red	C-FCI 1,5/M3	3240032	100
	blue	C-FCI 2,5/M3	3240037	100
Ring cable lug , insulated, in accordance with UL	red	C-RCI 1,5/M3	3240016	100
	blue	C-RCI 2,5/M3	3240021	100

Marking	
	UC-TM 8, UCT-TM 8, ZB 8 or TMT (EX9,5)R (see Catalog 3)

Marking	
	UC-TM 8, UCT-TM 8, ZB 8 or TMT (EX9,5)R (see Catalog 3)

Order example: Configurable test plug with rotary handle function

To ensure that your order is correct, you need a defined view of how everything is counted.

This is achieved when the status window in the top view is located on the left-hand side.

Position 1 then is on the left.

Each position of a test plug is described by a contact tab feature that is to be selected.

The following features are possible:

S	Short contact tab, gray
M	Medium contact tab, gray
L	Long contact tab, gray
LGN	Long contact tab, green
N	No contact tab, gray

Each position with a contact tab comes fitted with two gray test sockets.

Ordering example:

A 15-pos. test plug with rotary handle needs to be configured as follows:

Pos. 1	Short contact tab, gray
Pos. 2	Short contact tab, gray
Pos. 3	Short contact tab, gray
Pos. 4	Short contact tab, gray
Pos. 5	Short contact tab, gray
Pos. 6	Short contact tab, gray
Pos. 7	Short contact tab, gray
Pos. 8	No contact tab, gray

Pos. 9	No contact tab, gray
Pos. 10	Medium contact tab, gray
Pos. 11	Medium contact tab, gray
Pos. 12	Medium contact tab, gray
Pos. 13	Medium contact tab, gray
Pos. 14	Long contact tab, green
Pos. 15	Long contact tab, green

The order data for this ordering example is therefore:

Order No.	Pos. 1	Pos. 2	Pos. 3	Pos. 4	Pos. 5	Pos. 6	Pos. 7	Pos. 8	Pos. 9	Pos. 10	Pos. 11	Pos. 12	Pos. 13	Pos. 14	Pos. 15
3001693	S	S	S	S	S	S	S	N	N	M	M	M	M	LGN	LGN

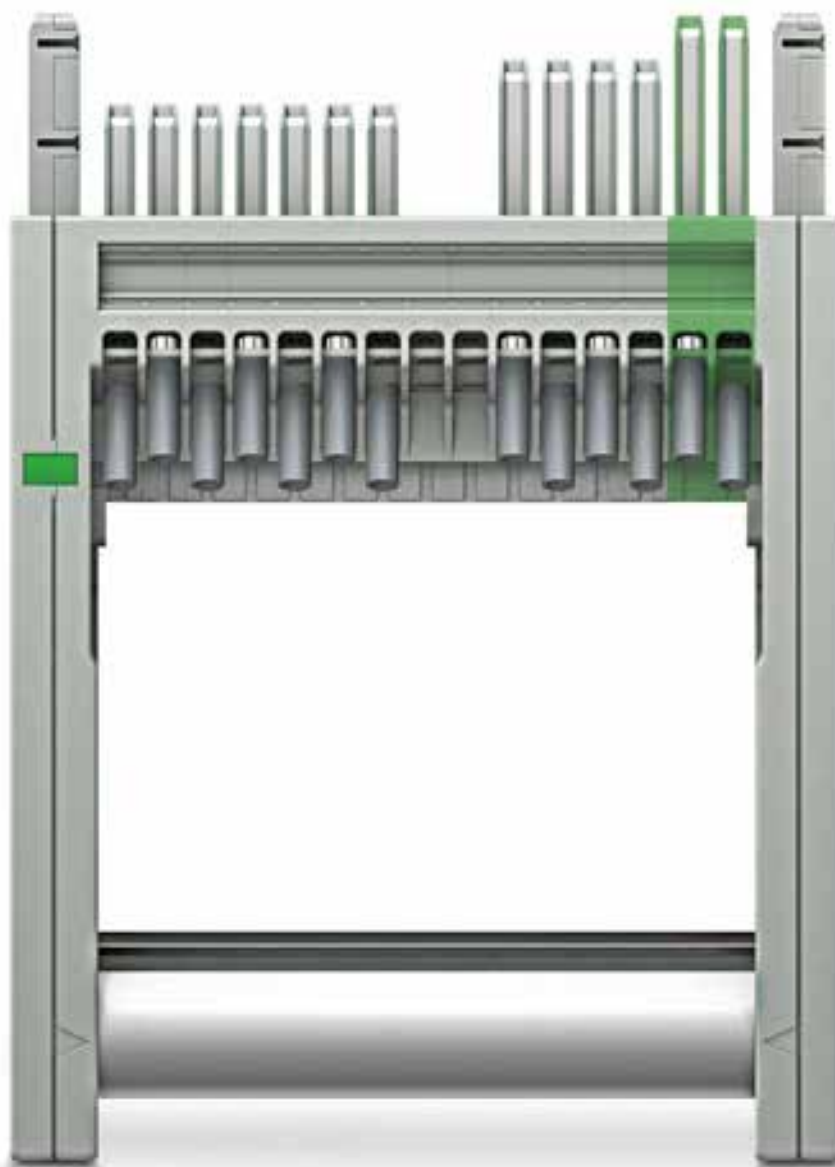

Sector-specific solutions

Solutions for protection and control engineering

Service test plugs, FBP-2/... blind plugs

- The service test plug is available in 1-pos. and 4-pos. versions without side flanges
- Free positioning on the test terminal strip for special measuring tasks
- Additional assembly with bridges and test sockets
- During normal operation, the blind plug acts as a protective cover for the test terminal strip and can be sealed as an option

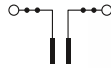

Service test plug 1 ... 4-pos.



Blind plug 4 ... 25-pos.



Maximum electrical data	Technical data				Technical data			
	I_{max} [A]	U_{max} [V]	max. \varnothing [mm ²]	AWG (UL)			max. \varnothing [mm ²]	AWG (UL)
Rated data	24	400	0.5 - 2.5	-			-	-
	IEC	UL / CUL	CSA	IEC/ EN 60079-7	IEC	UL / CUL	CSA	IEC/ EN 60079-7
Rated voltage [V]	400	-	-	-	-	-	-	-
Nominal current / cross section [A] / [mm ²]	24 / 2.5	-	-	-	- / -	-	-	-
Rated cross section [mm ²]	6	-	-	-	-	-	-	-
Cross section range AWG	20 - 14	-	-	-	-	-	-	-
Connection capacity	Rigid	Flexible	Ferrule without/with plastic sleeve		Rigid	Flexible	Ferrule without/with plastic sleeve	
1 conductor [mm ²]	-	0.5 - 2.5	-	-	-	-	-	-
General data								
Tightening torque: test socket screw [Nm]	0.5 - 0.6				-			
Insulating material	PA				PA			
Flammability rating in accordance with UL 94	V0				V0			

Description	Color	Ordering data			Ordering data		
		Type	Order No.	Pcs./Pkt.	Type	Order No.	Pcs./Pkt.
Service test plug, 1-pos., with test sockets	red	FTP-2/1 SERVICE	3069469	1			
2-pos., without test sockets	red	FTP-2/2 SERVICE	3069464	1			
3-pos., without test sockets	red	FTP-2/3 SERVICE	3069465	1			
4-pos., without test sockets	red	FTP-2/4 SERVICE	3069468	1			
Blind plug, 4-pos.	gray				FBP-2/4	3069875	1
5-pos.	gray				FBP-2/5	3069876	1
6-pos.	gray				FBP-2/6	3069877	1
7-pos.	gray				FBP-2/7	3069878	1
8-pos.	gray				FBP-2/8	3069879	1
9-pos.	gray				FBP-2/9	3069880	1
10-pos.	gray				FBP-2/10	3069881	1
11-pos.	gray				FBP-2/11	3069882	1
12-pos.	gray				FBP-2/12	3069883	1
13-pos.	gray				FBP-2/13	3069884	1
14-pos.	gray				FBP-2/14	3069885	1
15-pos.	gray				FBP-2/15	3069886	1
16-pos.	gray				FBP-2/16	3069887	1
17-pos.	gray				FBP-2/17	3069888	1
18-pos.	gray				FBP-2/18	3069889	1
19-pos.	gray				FBP-2/19	3069890	1
20-pos.	gray				FBP-2/20	3069891	1
21-pos.	gray				FBP-2/21	3069892	1
22-pos.	gray				FBP-2/22	3069893	1
23-pos.	gray				FBP-2/23	3069894	1
24-pos.	gray				FBP-2/24	3069895	1
25-pos.	gray				FBP-2/25	3069896	1
Isolating plug, 1-pos.	green	FIP-3/1 SERVICE	3069921	1			

Accessories		Accessories	
Lateral groove labeling	UC-TM 8, UCT-TM 8, ZB 8 or TMT (EX9,5)R (see Catalog 3)	UC-TM 8, UCT-TM 8, ZB 8 or TMT (EX9,5)R (see Catalog 3)	

PC ...-TRI coding profile set

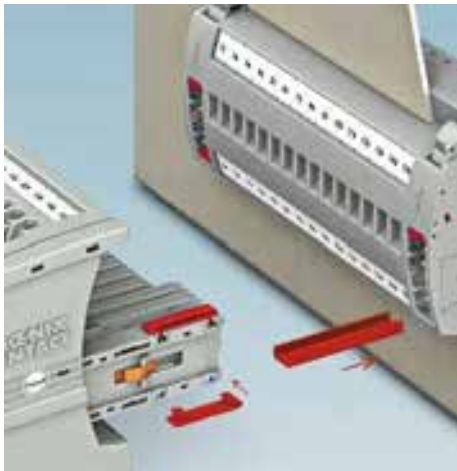

- The coding profile set can be used to assign test terminal strips and test plugs in accordance with the specific application
- Maximum safety is therefore ensured for all testing tasks

**General data**

Material
Flammability rating in accordance with UL 94

Technical data

PA
V0

Ordering data

Description	Color
Coding profile set, for test terminal strip	red
Coding profile set, for FTP-2 and FTPR-2 test plugs and FBP-2 blind plugs	red

Type	Order No.	Pcs./Pkt.
PC-UTWE-TRI	3069897	50
PC-FTP-TRI	3069898	50

Colored PSBJ ... test sockets



- 4 mm safety test leads with fixed insulation in accordance with EN 61010-031 CAT III and CAT IV up to 1000 V can be coded in true color
- Additional test leads, assembled with ring and fork-type cable lugs (see accessories, e.g., page 624) can be attached with test sockets



Description	Color
Test socket, insulated	transparent
	red
	blue
	yellow
	green
	violet
	black
	gray
	brown
	white

Ordering data

Type	Order No.	Pcs./Pkt.
PSBJ-URTK 6 FARBLOS	3026450	10
PSBJ-URTK 6 RD	3026719	10
PSBJ-URTK 6 BU	3026434	10
PSBJ-URTK 6 YE	3026405	10
PSBJ-URTK 6 GN	3026418	10
PSBJ-URTK 6 VT	3026421	10
PSBJ-URTK 6 BK	3026447	10
PSBJ-URTK 6 GY	3026612	10
PSBJ-URTK 6 BN	3026971	10
PSBJ-URTK 6 WH	3026448	10

Sector-specific solutions

Solutions for protection and control engineering

Bridge, red, 8.2 mm pitch, FBS ...

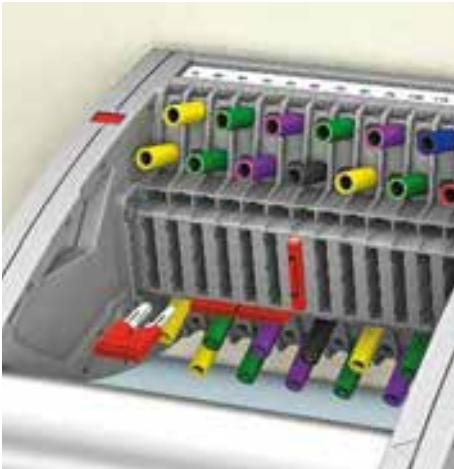

– The FBS ...-8 plug-in bridges are used for short-circuiting, as star-point bridges, and also to establish grounding in connection with a PE modular terminal block on the terminal strip

When using bridges in conjunction with the FAME plug-in test system, the maximum permissible bridge current is 24 A.



Description	Ordering data		
	Type	Order No.	Pcs./Pkt.
Plug-in bridge			
2-pos.	FBS 2-8	3030284	10
3-pos.	FBS 3-8	3030297	10
4-pos.	FBS 4-8	3030307	10
5-pos.	FBS 5-8	3030310	10
6-pos.	FBS 6-8	3032470	10
10-pos.	FBS 10-8	3030323	10

Plug-in bridge with and without extraction tool, red, 8.2 mm pitch, FBSRH ...

– The FBSRH ...-8 bridges have a molded extraction tool which means that they can be used conveniently and without tools for individual bridging tasks. This enables a transformer short circuit to be created in measuring transducer disconnect terminal blocks, for example

When using bridges in conjunction with the FAME plug-in test system, the maximum permissible bridge current is 24 A.



Plug-in bridge, with and without extraction tool

Description	Ordering data		
	Type	Order No.	Pcs./Pkt.
Bridge, with extraction tool			
2-pos.	FBSRH 2-8	3033802	10
3-pos.	FBSRH 3-8	3033803	10
4-pos.	FBSRH 4-8	3033804	10
Plug-in bridge			
2-pos.	FBSR 2-8	3033808	10
3-pos.	FBSR 3-8	3001597	10
4-pos.	FBSR 4-8	3000585	10
5-pos.	FBSR 5-8	3033809	10
10-pos.	FBSR 10-8	3001599	10
16-pos.	FBSR 16-8	3033816	10

Pre-assembled bridge, red, 8.2 mm pitch

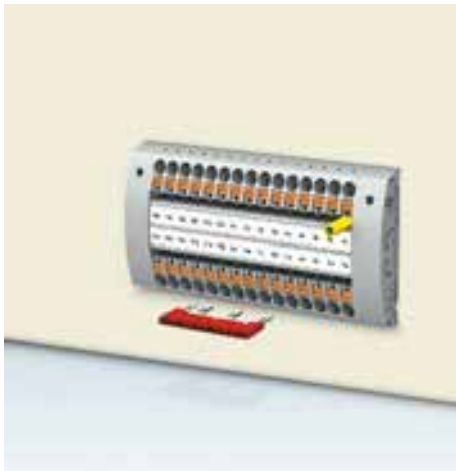

- Plug-in star-point bridges or bridges for bridging several positions can be supplied pre-configured without additional expense
- The bridges are printed and provide unique identification for bridging between non-adjacent terminal blocks

When using bridges in conjunction with the FAME plug-in test system, the maximum permissible bridge current is 24 A.



Description
Pre-assembled bridge , labeled
3-pos., positions 1, 3
4-pos., positions 1, 4
5-pos., positions 1, 3, 5
10-pos., positions 1, 4, 7, 10

Ordering data			
Type	Order No.	Pcs./Pkt.	
FBS 1/3-8	3032363	10	
FBS 1/4-8	3032376	10	
FBS 1/3/5-8	3032389	10	
FBS 1/4/7/10-8	3032402	10	

Cover profiles for test plug or test terminal strip mounted on DIN rail



- The AP-FTP cover profile prevents undesired changes to the star point, feed-through, and short-circuit bridges on the completely assembled test plug
- To mount, gently release the side screw connection of the plug and snap the profile into place
- The APH-ME cover profile carrier is used in conjunction with the AP-ME cover for the DIN rail mounted test disconnect socket



General data	
Material	

Technical data			
PVC			

Description	Color
Cover profile , supply length 1 m	transparent
Cover profile , supply length 1 m	transparent
Cover profile , supply length 1 m	transparent
Cover profile carrier , sealable, for AP-ME cover profile	gray
Cover profile holder , can be snapped on and sealed	gray

Ordering data			
Type	Order No.	Pcs./Pkt.	
AP-FTP METER	3069899	1	
AP-ME METER	3034361	10	
AP RSC-T	3059139	10	
APH-ME	3034374	10	
APH-UTWE 6-2	3069057	10	

Test disconnect sockets and test plugs, VDE-coded

Notes:
To create panel cutouts, see phoenixcontact.net/products.
For circuit diagrams of the test plugs, visit phoenixcontact.net/products.
¹⁾ Derating curve available on request.
²⁾ Test surge voltage 5 kV.

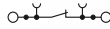

6 (10) mm², 30 A, test disconnect socket, for wall mounting, VDE-coded



6 (10) mm², 30 A, test disconnect socket, for DIN rail mounting, VDE-coded



Maximum electrical data	Technical data				I _{max.} [A]	U _{max.} [V]	max. Ø [mm ²]	AWG (UL)
	I _{max.} [A]	U _{max.} [V]	max. Ø [mm ²]	AWG (UL)				
	30	400 ²⁾	0.5 - 10	20-8	30	400 ²⁾	0.5 - 10	20-8
	IEC 60947-7-1				IEC 60947-7-1			
	IEC	UL / CUL	CSA	IEC/ EN 60079-7	IEC	UL / CUL	CSA	IEC/ EN 60079-7
Rated data								
Rated voltage [V]	400 ²⁾	300	600	-	400 ²⁾	300	600	-
Nominal current / cross section [A] / [mm ²]	24 ¹⁾ / 6	10	20 / -	-	24 ¹⁾ / 6	10	20 / -	-
Rated cross section [mm ²]	6	-	-	-	6	-	-	-
Cross section range AWG	20 - 8	20-8	20-8	-	20 - 8	20-8	20-8	-
Connection capacity								
	Rigid	Flexible	Ferrule without/with plastic sleeve		Rigid	Flexible	Ferrule without/with plastic sleeve	
1 conductor [mm ²]	0.5 - 10	0.5 - 6	0.5 - 6	0.5 - 6	0.5 - 10	0.5 - 6	0.5 - 6	0.5 - 6
2 flexible conductors with a TWIN ferrule [mm ²]	-	-	-	0.5 - 1.5	-	-	-	0.5 - 1.5
Connection cross sections directly plug-in [mm ²]	1 - 10	-	1 - 6	1 - 6	1 - 10	-	1 - 6	1 - 6
General data								
Stripping length [mm]	12				12			
Tightening torque for wall fastening [Nm]	0.8 - 1				-			
Panel thickness [mm]	1 - 4				-			
Tightening torque: test socket screw [Nm]	-				-			
Insulating material	PA				PA			
Flammability rating in accordance with UL 94	V0				V0			

Description	Color	Ordering data			Type	Order No.	Pcs./Pkt.	Type	Order No.	Pcs./Pkt.
		Type	Order No.	Pcs./Pkt.						
Push-in connection, A7	gray	PTWE 6-2/A7	3069436	1	PTRE 6-2/A7	3069449	1			
B7	gray	PTWE 6-2/B7	3069437	1	PTRE 6-2/B7	3069450	1			
E7	gray	PTWE 6-2/E7	3069438	1	PTRE 6-2/E7	3069451	1			
A14	gray	PTWE 6-2/A14	3069439	1	PTRE 6-2/A14	3069452	1			
B14	gray	PTWE 6-2/B14	3069440	1	PTRE 6-2/B14	3069453	1			
C14	gray	PTWE 6-2/C14	3069441	1	PTRE 6-2/C14	3069454	1			
B19	gray	PTWE 6-2/B19	3069442	1	PTRE 6-2/B19	3069455	1			
C19	gray	PTWE 6-2/C19	3069443	1	PTRE 6-2/C19	3069456	1			
D19	gray	PTWE 6-2/D19	3069444	1	PTRE 6-2/D19	3069457	1			
F19	gray	PTWE 6-2/F19	3069445	1	PTRE 6-2/F19	3069458	1			
G19	gray	PTWE 6-2/G19	3069446	1	PTRE 6-2/G19	3069459	1			
H19	gray	PTWE 6-2/H19	3069447	1	PTRE 6-2/H19	3069460	1			
I19	gray	PTWE 6-2/I19	3069448	1	PTRE 6-2/I19	3069461	1			
Screw connection, A7	gray	UTWE 6-2/A7	3069410	1	UTRE 6-2/A7	3069423	1			
B7	gray	UTWE 6-2/B7	3069411	1	UTRE 6-2/B7	3069424	1			
E7	gray	UTWE 6-2/E7	3069412	1	UTRE 6-2/E7	3069425	1			
A14	gray	UTWE 6-2/A14	3069413	1	UTRE 6-2/A14	3069426	1			
B14	gray	UTWE 6-2/B14	3069414	1	UTRE 6-2/B14	3069427	1			
C14	gray	UTWE 6-2/C14	3069415	1	UTRE 6-2/C14	3069428	1			
B19	gray	UTWE 6-2/B19	3069416	1	UTRE 6-2/B19	3069429	1			
C19	gray	UTWE 6-2/C19	3069417	1	UTRE 6-2/C19	3069430	1			
D19	gray	UTWE 6-2/D19	3069418	1	UTRE 6-2/D19	3069431	1			
F19	gray	UTWE 6-2/F19	3069419	1	UTRE 6-2/F19	3069432	1			
G19	gray	UTWE 6-2/G19	3069420	1	UTRE 6-2/G19	3069433	1			
H19	gray	UTWE 6-2/H19	3069421	1	UTRE 6-2/H19	3069434	1			
I19	gray	UTWE 6-2/I19	3069422	1	UTRE 6-2/I19	3069435	1			
Service test plug, 1-pos., with test sockets	red									

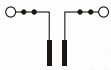

24 A, test plug, with rotary handle,
VDE-coded

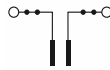

24 A, test plug, with standard handle,
VDE-coded



Blind plug, sealable,
VDE-coded



Technical data			
$I_{max.}$ [A]	$U_{max.}$ [V]	max. \varnothing [mm ²]	AWG (UL)
24	400	0.5 - 2.5	-
IEC	UL / CUL	CSA	IEC/ EN 60079-7
400	-	-	-
24 / 2.5	-	-	-
6	-	-	-
20 - 14	-	-	-
Rigid	Flexible	Ferrule without/with plastic sleeve	
-	0.5 - 2.5	-	-
-	-	-	-
-	-	-	-
0.5 - 0.6	-	-	-
PA	-	-	-
V0	-	-	-

Technical data			
$I_{max.}$ [A]	$U_{max.}$ [V]	max. \varnothing [mm ²]	AWG (UL)
24	400	0.5 - 2.5	-
IEC	UL / CUL	CSA	IEC/ EN 60079-7
400	-	-	-
24 / 2.5	-	-	-
6	-	-	-
20 - 14	-	-	-
Rigid	Flexible	Ferrule without/with plastic sleeve	
-	0.5 - 2.5	-	-
-	-	-	-
-	-	-	-
0.5 - 0.6	-	-	-
PA	-	-	-
V0	-	-	-

Technical data			
		max. \varnothing [mm ²]	AWG (UL)
		-	-
IEC	UL / CUL	CSA	IEC/ EN 60079-7
-	-	-	-
- / -	-	-	-
-	-	-	-
-	-	-	-
Rigid	Flexible	Ferrule without/with plastic sleeve	
-	-	-	-
-	-	-	-
-	-	-	-
PA	-	-	-
V0	-	-	-

Ordering data		
Type	Order No.	Pcs./Pkt.
FTP-2/A7	3069484	1
FTP-2/B7	3069485	1
FTP-2/E7	3069486	1
FTP-2/A14	3069487	1
FTP-2/B14	3069488	1
FTP-2/C14	3069489	1
FTP-2/B19	3069490	1
FTP-2/C19	3069491	1
FTP-2/D19	3069492	1
FTP-2/F19	3069493	1
FTP-2/G19	3069494	1
FTP-2/H19	3069495	1
FTP-2/I19	3069496	1
FTP-2/A7	3069484	1
FTP-2/B7	3069485	1
FTP-2/E7	3069486	1
FTP-2/A14	3069487	1
FTP-2/B14	3069488	1
FTP-2/C14	3069489	1
FTP-2/B19	3069490	1
FTP-2/C19	3069491	1
FTP-2/D19	3069492	1
FTP-2/F19	3069493	1
FTP-2/G19	3069494	1
FTP-2/H19	3069495	1
FTP-2/I19	3069496	1

Ordering data		
Type	Order No.	Pcs./Pkt.
FTP-2/A7	3069470	1
FTP-2/B7	3069471	1
FTP-2/E7	3069472	1
FTP-2/A14	3069474	1
FTP-2/B14	3069475	1
FTP-2/C14	3069476	1
FTP-2/B19	3069477	1
FTP-2/C19	3069478	1
FTP-2/D19	3069479	1
FTP-2/F19	3069480	1
FTP-2/G19	3069481	1
FTP-2/H19	3069482	1
FTP-2/I19	3069483	1
FTP-2/A7	3069470	1
FTP-2/B7	3069471	1
FTP-2/E7	3069472	1
FTP-2/A14	3069474	1
FTP-2/B14	3069475	1
FTP-2/C14	3069476	1
FTP-2/B19	3069477	1
FTP-2/C19	3069478	1
FTP-2/D19	3069479	1
FTP-2/F19	3069480	1
FTP-2/G19	3069481	1
FTP-2/H19	3069482	1
FTP-2/I19	3069483	1
FTP-2/1 SERVICE	3069469	1

Ordering data		
Type	Order No.	Pcs./Pkt.
FBP-2/A7	3069497	1
FBP-2/B7	3069498	1
FBP-2/E7	3069499	1
FBP-2/A14	3069500	1
FBP-2/B14	3069501	1
FBP-2/C14	3069502	1
FBP-2/B19	3069503	1
FBP-2/C19	3069504	1
FBP-2/D19	3069671	1
FBP-2/F19	3069675	1
FBP-2/G19	3069676	1
FBP-2/H19	3069677	1
FBP-2/I19	3069678	1
FBP-2/A7	3069497	1
FBP-2/B7	3069498	1
FBP-2/E7	3069499	1
FBP-2/A14	3069500	1
FBP-2/B14	3069501	1
FBP-2/C14	3069502	1
FBP-2/B19	3069503	1
FBP-2/C19	3069504	1
FBP-2/D19	3069671	1
FBP-2/F19	3069675	1
FBP-2/G19	3069676	1
FBP-2/H19	3069677	1
FBP-2/I19	3069678	1

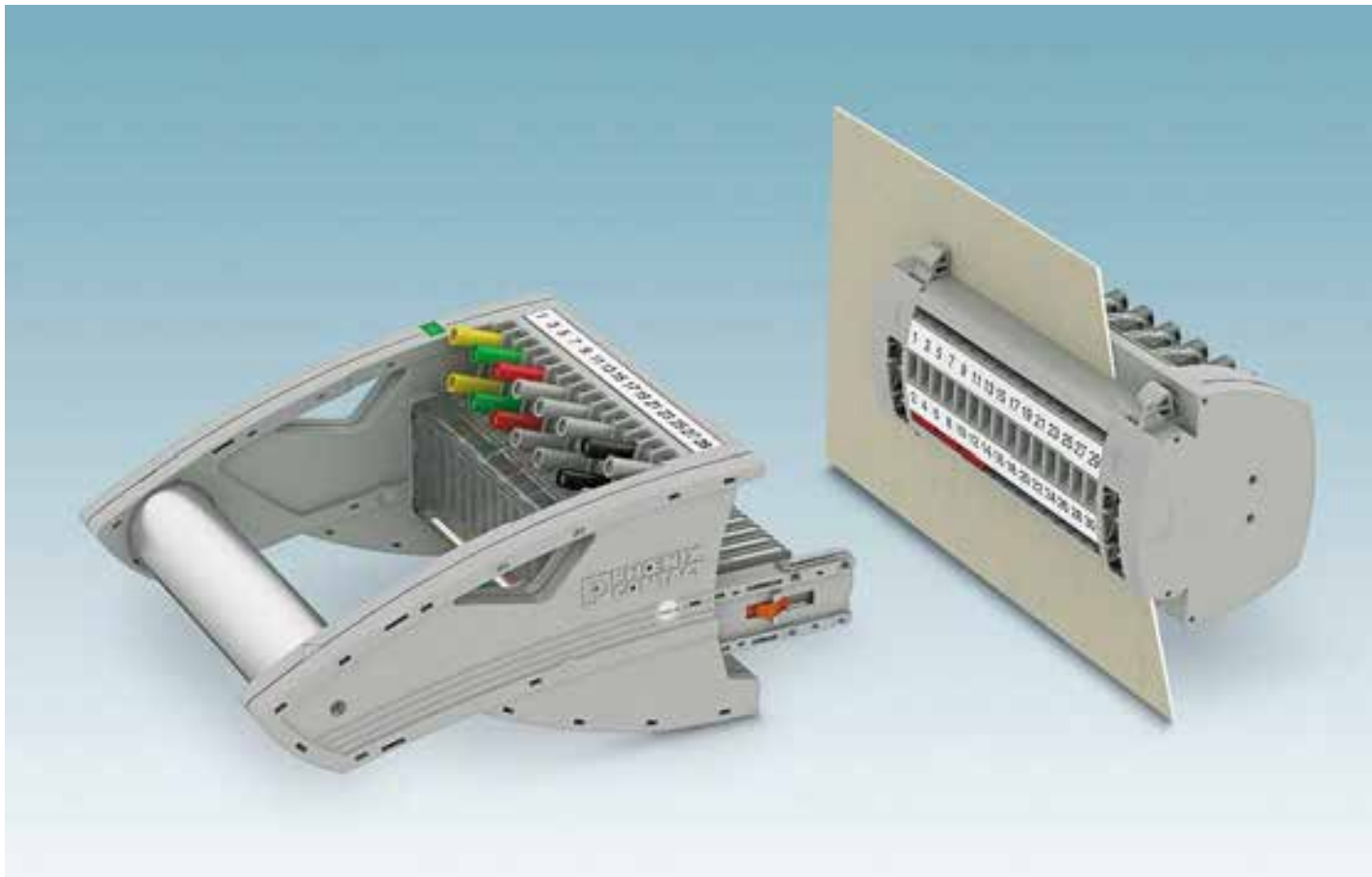

FAME 3 combines complex switching operations for function tests of current and voltage transformers, as well as tripping and signal contacts, in separate compact and space-saving blocks. The system operates in accordance with the N/C contact principle. An operating plug is not required. The automatic transformer short circuit function is ensured with plug-in bridges in the test disconnect socket.

i Your web code: [#0131](#)



The test plug is inserted fully and engages securely. The display window turns red. All test contacts are contacted in accordance with the test setup.



The rotary handle is turned upward as far as it will go. The display window turns yellow. The test contacts are once again through-connected to the protective device.



The rotary handle must be turned back to its starting position. The display window turns green. Now the mechanism releases the plug so it can be fully removed.



Defined, mechanically supported removal of the patented test plug from the test block. Optical display and forced locking in the various switch positions.



Automatic, leading transformer short circuit implemented with standard plug-in bridges in the test disconnect socket. Short-circuit bridges are designed to be touch-proof. Their positioning on the outside of the control cabinet is clearly visible.

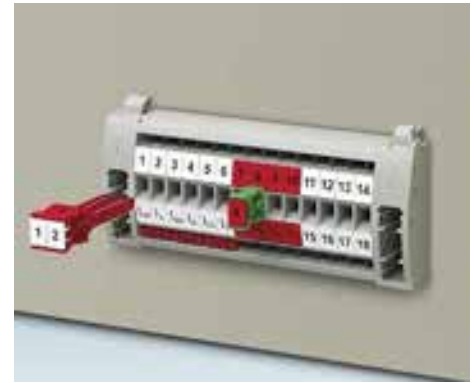

Service connectors are available with varying numbers of positions for special switching operations. A sealable, transparent cover protects against unauthorized actuation.



For special test processes you will receive service connectors with 4 mm test sockets with various numbers of positions. The test sockets can be used to connect equipment with safety test cables, e.g., measuring instruments.



Space saving, thanks to offset test socket arrangements. The test cables can be easily fixed in place with cable ties.

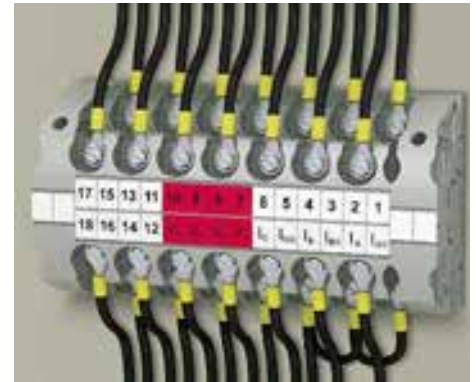

The test disconnect sockets feature screw connection technology for ring and fork-type cable lugs.

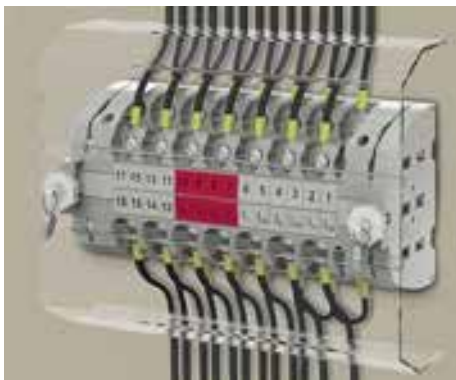

The test disconnect socket can be optionally protected against unauthorized actuation inside the control cabinet by means of a sealable cover.



Star point bridging is easily implemented by means of wire bridges on the inside of the control cabinet.



The robust latching of the cover for the test disconnect sockets can only be released with two-hand operation. The optional seal protects against unauthorized actuation.

FAME 3

Modular plug-in test system without operating plug and transformer short circuit in the plug-in test socket

The switch contact in the plug-in test socket is a N/C contact. In normal operation the contact is closed.



Normal operation

Closed switch contact

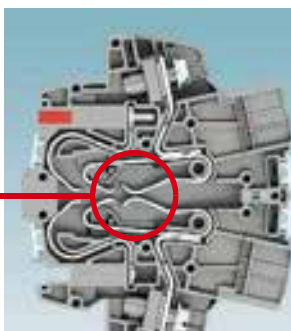

Transformer short circuit

Leading short circuit by means of auxiliary contact

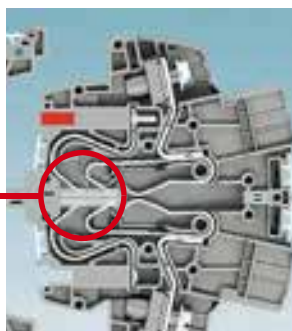

Test operation

Switch contact connected via test socket

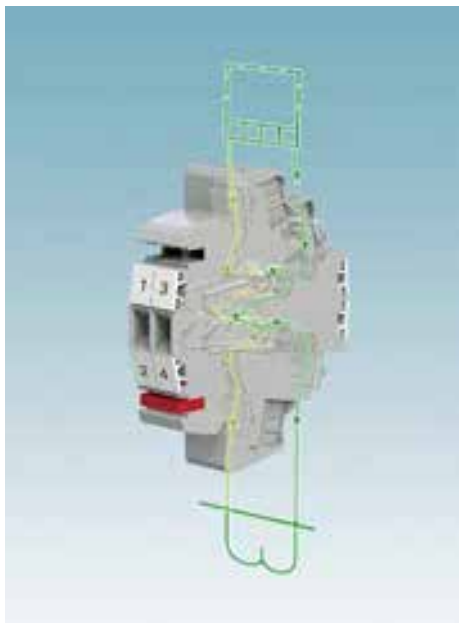
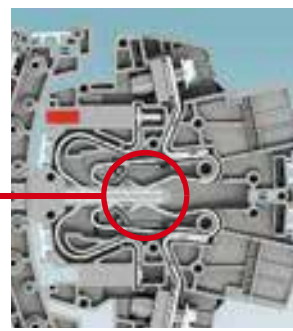

Normal operation

The N/C contact function enables normal operation without an additional operating plug. If desired, the plug-in zone can be covered and sealed with a blind plug to prevent unauthorized access.

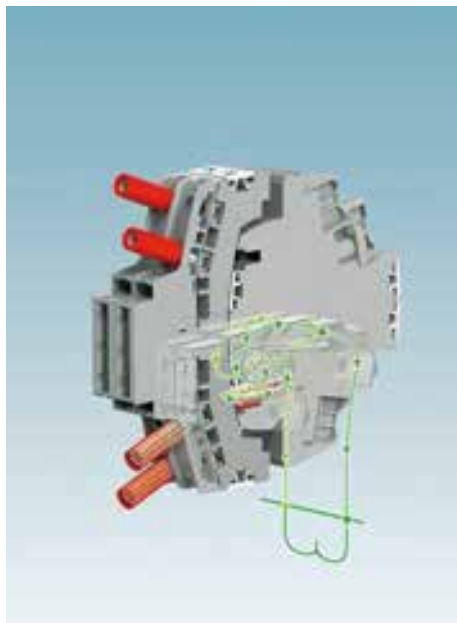

Transformer short circuit

When replacing the protective device or in the case of a relay test, the current transformer can be short circuited upstream of the signal splitting by inserting a plug-in bridge in the plug-in test socket crossways. The short circuit occurs automatically when the test plug is inserted.

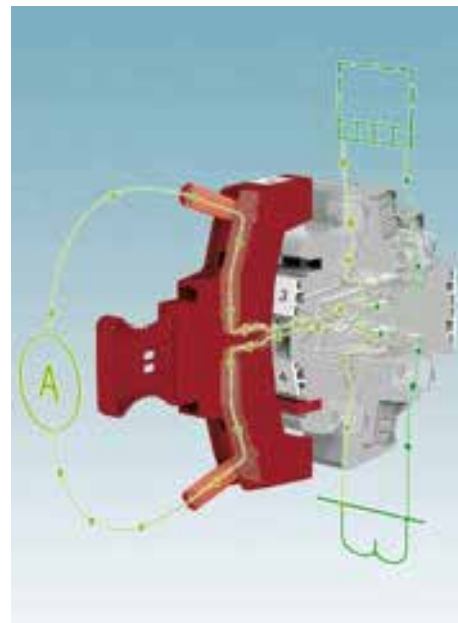

Test operation

If you use the single-position service plug, you can simply loop the test equipment into the current path via the 4 mm test sockets.

Mains protection – Circuit example with star point grounding in the plug-in test socket

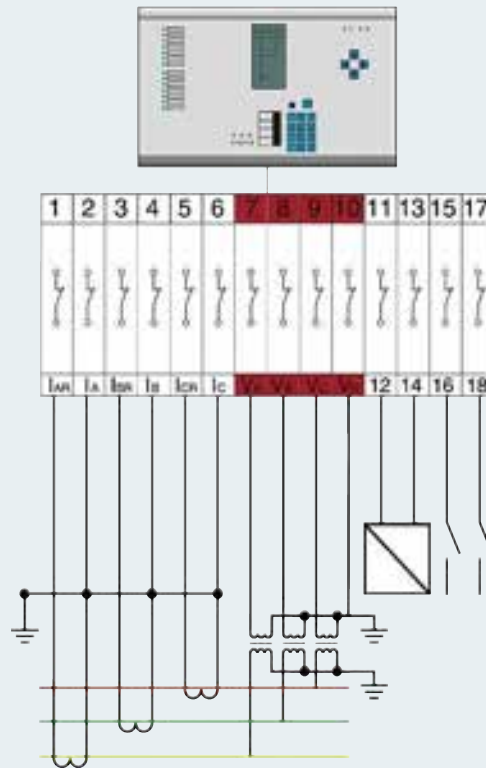

Plug-in test socket with current transformer, voltage transducer, and signals

Test plug with current transformer, voltage transducer, and signals

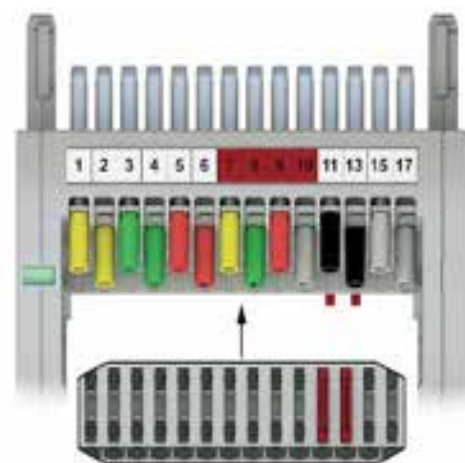
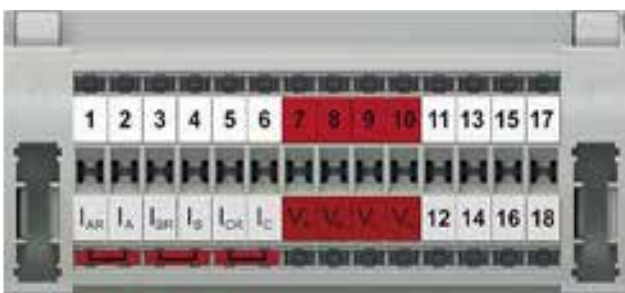

Plug-in test socket, blind plug

Type	Order No.	Required quantity
RSCWE 6-3/14	3969928	1
FBP 2/15	3069885	1
Plug-in bridge		
FBS 2-8	3030284	3

Test plug

Type	Order No.	Required quantity	
Rotary handle	FTP 3/14S	3069957	1
Standard handle	FTP 3/14S	3069953	1
Plug-in bridge			
FBS 3-8	3030297	2	

Test disconnect sockets and test plugs, with ring cable lug connection

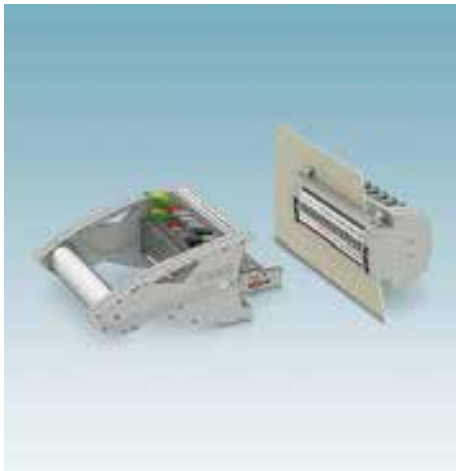

The modular FAME measuring transducer test system enables all transformer testing tasks to be carried out quickly and safely. The transformer is short-circuited and the test device is looped in automatically when inserted.

- The test terminal strips can be used universally for current and voltage transducers
- The test disconnect socket is mounted in the control cabinet door to save space
- Signal and status messages can be wired in combination in a test terminal strip
- The correct switching sequence when removing the test plug is ensured by a locking device and a mechanical drive in the rotary handle
- All test signals are connected with touch-proof safety test cables (CAT III and CAT IV/1000 V in accordance with EN 61010-031)
- Star points of the current transformers can easily be created with wire bridges on the rear of the test disconnect socket
- You can find corresponding accessories from page 638

Notes:
1) Derating curve available on request.
2) Test surge voltage 5 kV.



30 A, plug-in test socket, wall mounting



Maximum electrical data	
Rated data	
Rated voltage	[V] 400 ²⁾
Nominal current / cross section	[A] / [mm ²] 24 ¹⁾ / 6
Rated cross section	[mm ²] 6
Cross section range	AWG 24 - 8
Connection capacity, DIN 46234	
Cable lugs, DIN 46234	[mm ²] 0.5 - 10
Connection bolt / hole diameter / width	[mm] 4.1 / 4.3 / 8
Connection capacity, DIN 46237	
Cable lugs DIN 46237	[mm ²] 0.5 - 10
Connection bolt / hole diameter / width	[mm] 4.1 / 4.3 / 8
Color code	red 1.00 mm ² blue 2.50 mm ² yellow 6.00 mm ²
General data	
Stripping length	[mm] 12
Tightening torque	[Nm] 1.5 - 1.8
Tightening torque for wall fastening	[Nm] 0.8 - 1
Panel thickness	[mm] 1 - 4
Tightening torque: test socket screw	[Nm] -
Insulating material	PA
Flammability rating in accordance with UL 94	V0

Technical data			
I _{max} [A]	U _{max} [V]	max. Ø [mm ²]	AWG (UL)
30	400 ²⁾	0.5 - 10	20-8
IEC 60947-7-1	UL / CUL	CSA	IEC / EN 60079-7
400 ²⁾	600	600	-
24 ¹⁾ / 6	31	31 / -	-
6	-	-	-
24 - 8	20-8	20-8	-
Ordering data			
Type	Order No.	Pcs./Pkt.	
RSCWE 6-3/2	3969917	1	
RSCWE 6-3/3	3969918	1	
RSCWE 6-3/4	3969920	1	
RSCWE 6-3/5	3969921	1	
RSCWE 6-3/6	3969922	1	
RSCWE 6-3/7	3969923	1	
RSCWE 6-3/8	3969924	1	
RSCWE 6-3/9	3969925	1	
RSCWE 6-3/10	3969926	1	
RSCWE 6-3/11	3969915	1	
RSCWE 6-3/12	3969927	1	
RSCWE 6-3/13	3969916	1	
RSCWE 6-3/14	3969928	1	
RSCWE 6-3/3X10	3969929	1	
Accessories			
DP-RSCWE 6-3	3069314	1	
SF-SL 0,8X4,0-100	1212551	10	
Lateral groove labeling			
UC-TM 8, UCT-TM 8, ZB 8 or TMT (EX9,5)R (see Catalog 3)			

Description	Color
Test disconnect socket, 2-pos.	gray
3-pos.	gray
4-pos.	gray
5-pos.	gray
6-pos.	gray
7-pos.	gray
8-pos.	gray
9-pos.	gray
10-pos.	gray
11-pos.	gray
12-pos.	gray
13-pos.	gray
14-pos.	gray
3 x 10-pos.	gray

Spacer plate, width: 8.2 mm	gray
Shoulder bag, for FAME connectors	black
Screwdriver	

Lateral groove labeling	UC-TM 8, UCT-TM 8, ZB 8 or TMT (EX9,5)R (see Catalog 3)
-------------------------	---

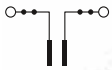

20 A, test plug with rotary handle,
4 mm test sockets

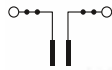

20 A, test plug without rotary handle,
4 mm test socket

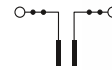

20 A, test plug, compact, incl. two test sockets
per position



Technical data			
I_{max} [A]	U_{max} [V]	max. Ø [mm ²]	AWG (UL)
20	400	0.5 - 2.5	-
IEC	UL / CUL	CSA	IEC/ EN 60079-7
400	-	-	-
20 / 2.5	-	-	-
6	-	-	-
20 - 14	-	-	-
-	-	-	-
- / - / -	-	-	-
-	-	-	-
- / - / -	-	-	-
-	-	-	-
- / - / -	-	-	-
-	-	-	-
-	-	-	-
-	-	-	-
0.5 - 0.6	-	-	-
PA	-	-	-
V0	-	-	-

Technical data			
I_{max} [A]	U_{max} [V]	max. Ø [mm ²]	AWG (UL)
20	400	0.5 - 2.5	-
IEC	UL / CUL	CSA	IEC/ EN 60079-7
400	-	-	-
20 / 2.5	-	-	-
6	-	-	-
20 - 14	-	-	-
-	-	-	-
- / - / -	-	-	-
-	-	-	-
- / - / -	-	-	-
-	-	-	-
- / - / -	-	-	-
-	-	-	-
-	-	-	-
0.5 - 0.6	-	-	-
PA	-	-	-
V0	-	-	-

Technical data			
I_{max} [A]	U_{max} [V]	max. Ø [mm ²]	AWG (UL)
20	400	0.5 - 2.5	-
IEC	UL / CUL	CSA	IEC/ EN 60079-7
400	-	-	-
20 / 2.5	-	- / -	-
6	-	-	-
20 - 14	-	-	-
-	-	-	-
- / - / -	-	-	-
-	-	-	-
- / - / -	-	-	-
-	-	-	-
-	-	-	-
0.5 - 0.6	-	-	-
PA	-	-	-
V0	-	-	-

Ordering data		
Type	Order No.	Pcs./Pkt.
FTPR-3/4S	3069954	1
FTPR-3/5S	3069965	1
FTPR-3/6S	3069966	1
FTPR-3/7S	3069967	1
FTPR-3/8S	3069968	1
FTPR-3/9S	3069969	1
FTPR-3/10S	3069955	1
FTPR-3/11S	3069970	1
FTPR-3/12S	3069956	1
FTPR-3/13S	3069971	1
FTPR-3/14S	3069957	1

Ordering data		
Type	Order No.	Pcs./Pkt.
FTP-3/4S	3069950	1
FTP-3/5S	3069958	1
FTP-3/6S	3069959	1
FTP-3/7S	3069960	1
FTP-3/8S	3069961	1
FTP-3/9S	3069962	1
FTP-3/10S	3069951	1
FTP-3/11S	3069963	1
FTP-3/12S	3069952	1
FTP-3/13S	3069964	1
FTP-3/14S	3069953	1

Ordering data		
Type	Order No.	Pcs./Pkt.
FTPC-3/4S	3069930	1
FTPC-3/5S	3069935	1
FTPC-3/6S	3069936	1
FTPC-3/7S	3069937	1
FTPC-3/8S	3069938	1
FTPC-3/9S	3069939	1
FTPC-3/10S	3069931	1
FTPC-3/11S	3069940	1
FTPC-3/12S	3069933	1
FTPC-3/13S	3069941	1
FTPC-3/14S	3069932	1

Accessories		
Accessories	Order No.	Pcs./Pkt.
FAME-BAG 260	3069520	1

Accessories		
Accessories	Order No.	Pcs./Pkt.
FAME-BAG 260	3069520	1

Accessories		
Accessories	Order No.	Pcs./Pkt.
FAME-BAG 260	3069520	1

UC-TM 8, UCT-TM 8, ZB 8 or TMT (EX9,5)R
(see Catalog 3)

UC-TM 8, UCT-TM 8, ZB 8 or TMT (EX9,5)R
(see Catalog 3)

UC-TM 8, UCT-TM 8, ZB 8 or TMT (EX9,5)R
(see Catalog 3)

Isolating and service test plugs

Specific test operations can be performed using service plugs

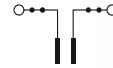

Isolating plug 1- ... 4-pos.



Service test plug 1- ... 4-pos.



	Technical data				Technical data				
Maximum electrical data	I_{max} [A]	U_{max} [V]	max. Ø [mm ²]	AWG (UL)	I_{max} [A]	U_{max} [V]	max. Ø [mm ²]	AWG (UL)	
	20	400	-	-	24	400	0.5 - 2.5	-	
Rated data	IEC	UL / CUL	CSA	IEC/ EN 60079-7	IEC	UL / CUL	CSA	IEC/ EN 60079-7	
Rated voltage [V]	400	-	-	-	400	-	-	-	
Nominal current / cross section [A] / [mm ²]	20 / -	-	-	-	24 / 2.5	-	-	-	
Rated cross section [mm ²]	-	-	-	-	6	-	-	-	
Cross section range AWG	-	-	-	-	20 - 14	-	-	-	
Connection capacity	Rigid	Flexible	Ferrule without/with plastic sleeve		Rigid	Flexible	Ferrule without/with plastic sleeve		
1 conductor [mm ²]	-	-	-	-	-	0.5 - 2.5	-	-	
General data									
Tightening torque: test socket screw [Nm]	-				0.5 - 0.6				
Insulating material	PA				PA				
Flammability rating in accordance with UL 94	V0				V0				
Ordering data					Ordering data				
Description	Color	Type	Order No.	Pcs./Pkt.	Type	Order No.	Pcs./Pkt.		
Isolating plug, 1-pos.	green	FIP-3/1 SERVICE	3069921	1					
2-pos.	red	FIP-3/2 SERVICE	3069920	1					
3-pos.	red	FIP-3/3 SERVICE	3069312	1					
4-pos.	red	FIP-3/4 SERVICE	3069313	1					
Service test plug, 1-pos., with test sockets	red				FTP-2/1 SERVICE	3069469	1		
2-pos., without test sockets	red				FTP-2/2 SERVICE	3069464	1		
3-pos., without test sockets	red				FTP-2/3 SERVICE	3069465	1		
4-pos., without test sockets	red				FTP-2/4 SERVICE	3069468	1		
Accessories					Accessories				
Lateral groove labeling	UC-TM 8, UCT-TM 8, ZB 8 or TMT (EX9,5)R (see Catalog 3)								

Cover profile and blind plugs

The sealable cover protects against unauthorized actuation



Transparent cover profile
for use with isolating plugs



Blind plug 4- ... 14-pos.

General data		Technical data			Technical data		
		Ordering data			Ordering data		
Description	Color	Type	Order No.	Pcs./Pkt.	Type	Order No.	Pcs./Pkt.
Insulating material		PVC			PA		
Flammability rating in accordance with UL 94		V0			V0		
Cover profile, sealable, 2-pos.		transparent	FBP-3/2 TR	3069926	1		
3-pos.		transparent	FBP-3/3 TR	3069927	1		
4-pos.		transparent	FBP-3/4 TR	3069922	1		
5-pos.		transparent	FBP-3/5 TR	3069928	1		
6-pos.		transparent	FBP-3/6 TR	3069929	1		
7-pos.		transparent	FBP-3/7 TR	3069945	1		
8-pos.		transparent	FBP-3/8 TR	3069946	1		
9-pos.		transparent	FBP-3/9 TR	3069947	1		
10-pos.		transparent	FBP-3/10 TR	3069924	1		
11-pos.		transparent	FBP-3/11 TR	3069948	1		
12-pos.		transparent	FBP-3/12 TR	3069923	1		
13-pos.		transparent	FBP-3/13 TR	3069934	1		
14-pos.		transparent	FBP-3/14 TR	3069925	1		
Blind plug, 4-pos.		gray			FBP-2/4	3069875	1
5-pos.		gray			FBP-2/5	3069876	1
6-pos.		gray			FBP-2/6	3069877	1
7-pos.		gray			FBP-2/7	3069878	1
8-pos.		gray			FBP-2/8	3069879	1
9-pos.		gray			FBP-2/9	3069880	1
10-pos.		gray			FBP-2/10	3069881	1
11-pos.		gray			FBP-2/11	3069882	1
12-pos.		gray			FBP-2/12	3069883	1
13-pos.		gray			FBP-2/13	3069884	1
14-pos.		gray			FBP-2/14	3069885	1
Lateral groove labeling		Accessories			Accessories		
		UC-TM 8, UCT-TM 8, ZB 8 or TMT (EX9,5)R (see Catalog 3)			UC-TM 8, UCT-TM 8, ZB 8 or TMT (EX9,5)R (see Catalog 3)		

Cover profile carrier



The test disconnect socket can be optionally protected against unauthorized actuation inside the control cabinet by means of a sealable cover.



Description		Color	Ordering data		
Cover profile carrier, sealable		gray	Type	Order No.	Pcs./Pkt.
Cover profile, supply length 1 m		transparent	APH-RSCWE 6-3 CARRIER	3069058	10
Cover profile, supply length 1 m		transparent	AP-ME METER	3034361	10
Cover profile, supply length 1 m		transparent	AP RSC-T	3059139	10

Cover profiles for test plug or test terminal strip mounted on DIN rail



- The AP-FTP cover profile prevents undesired changes to the star point, feed-through, and short-circuit bridges on the completely assembled test plug
- To mount, gently release the side screw connection of the plug and snap the profile into place
- The APH-ME cover profile carrier is used in conjunction with the AP-ME cover for the DIN rail mounted test disconnect socket

General data		Technical data			
Material		PVC			
Description		Color	Ordering data		
Cover profile, supply length 1 m		transparent	Type	Order No.	Pcs./Pkt.
Cover profile, supply length 1 m		transparent	AP-FTP METER	3069899	1
Cover profile, supply length 1 m		transparent	AP-ME METER	3034361	10
Cover profile carrier, sealable, for AP-ME cover profile		gray	AP RSC-T	3059139	10
Cover profile holder, can be snapped on and sealed		gray	APH-ME	3034374	10
			APH-UTWE 6-2	3069057	10

Spacer plate



The optional latching panel inserts allow the test disconnect sockets to be installed in existing panel cutouts.

		Ordering data		
Description	Color	Type	Order No.	Pcs./Pkt.
Spacer plate, width: 8.2 mm	gray	DP-RSCWE 6-3	3069314	1

Colored PSBJ ... test sockets



- 4 mm safety test leads with fixed insulation in accordance with EN 61010-031 CAT III and CAT IV up to 1000 V can be coded in true color
- Additional test leads, assembled with ring and fork-type cable lugs (see accessories, e.g., page 624) can be attached with test sockets

		Ordering data		
Description	Color	Type	Order No.	Pcs./Pkt.
Test socket, insulated	transparent	PSBJ-URTK 6 FARBLOS	3026450	10
	red	PSBJ-URTK 6 RD	3026719	10
	blue	PSBJ-URTK 6 BU	3026434	10
	yellow	PSBJ-URTK 6 YE	3026405	10
	green	PSBJ-URTK 6 GN	3026418	10
	violet	PSBJ-URTK 6 VT	3026421	10
	black	PSBJ-URTK 6 BK	3026447	10
	gray	PSBJ-URTK 6 GY	3026612	10
	brown	PSBJ-URTK 6 BN	3026971	10
	white	PSBJ-URTK 6 WH	3026448	10

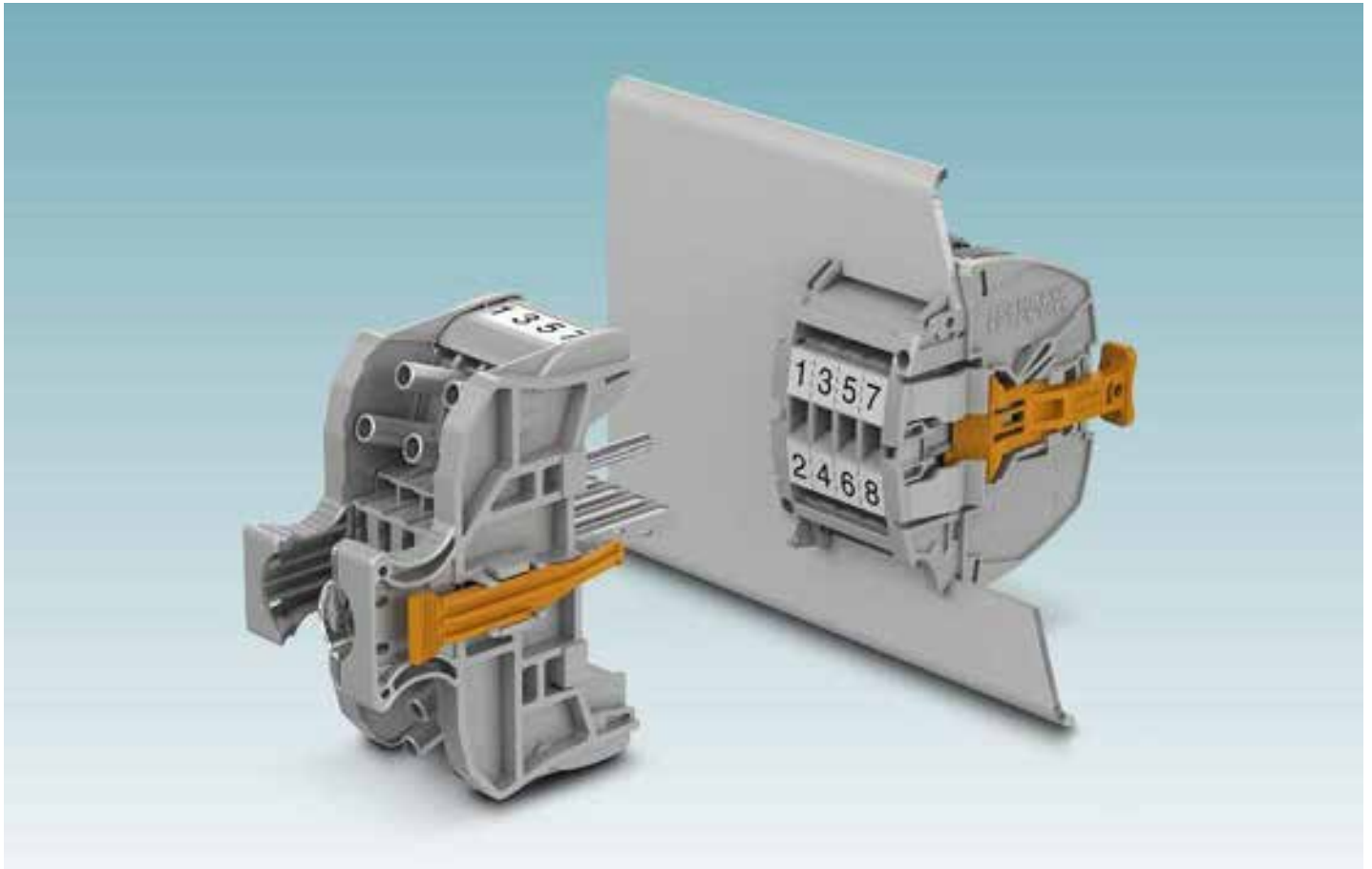

FAME 3 SL combines complex switching operations for function tests of current and voltage transformers, as well as tripping and signal contacts, in separate space-saving blocks of various colors. The system operates in accordance with the N/C contact principle. An operating plug is not required. The automatic transformer short circuit function is ensured with plug-in bridges in the plug-in test socket.

i Your web code: #0131



The plug-in test socket positioned in the cutout is latched in place without screws by pressing on the two orange actuating elements.

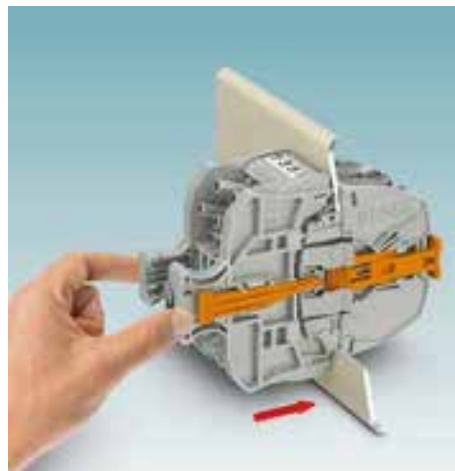

By plugging in and latching the test plug, all test contacts are securely contacted in accordance with the test setup.



The latching is released by actuating the orange lever. Unplugging the test plug will restore the original signal connections.

Mains protection – Switching example with sequential switching sequence

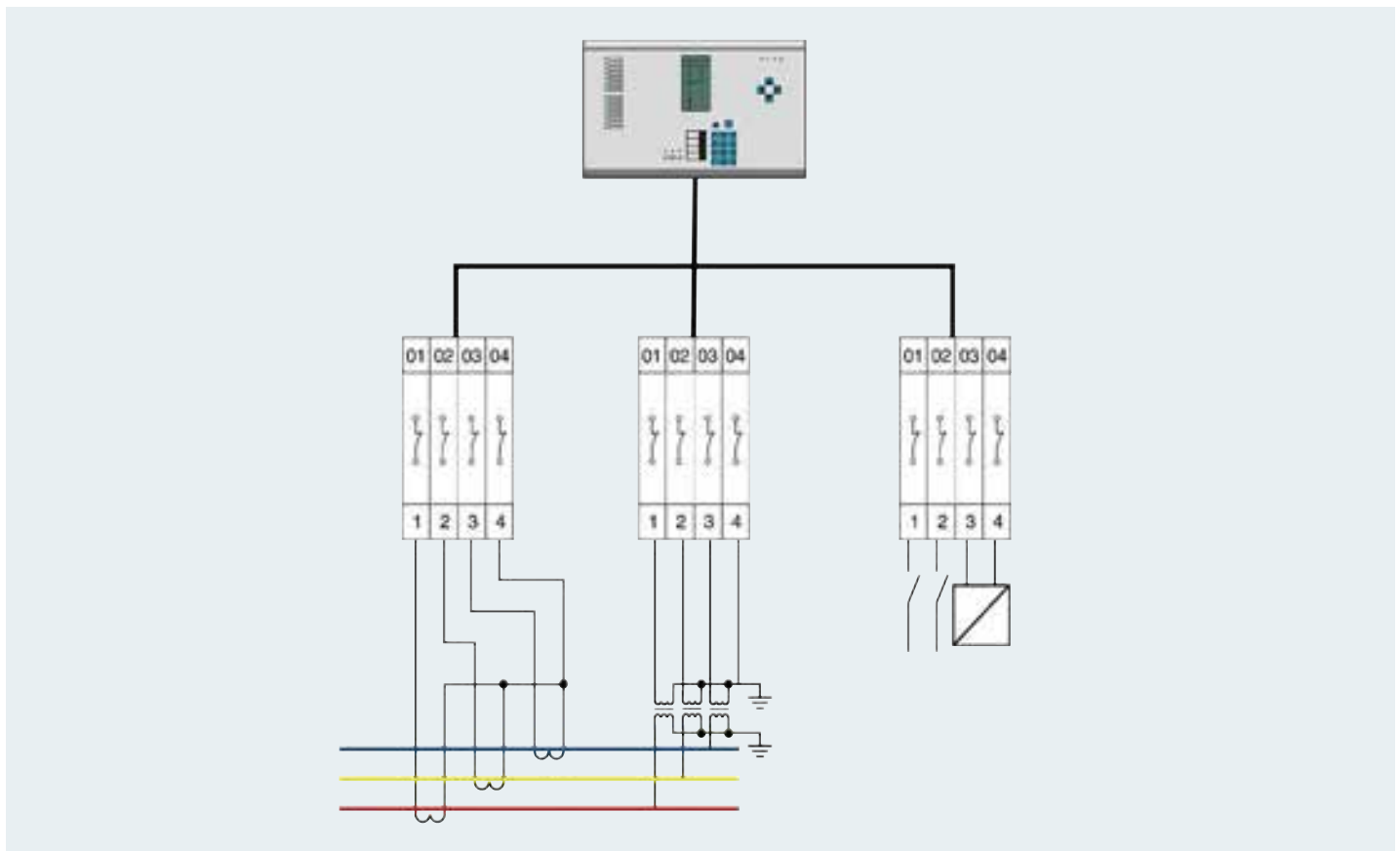

Plug-in test socket for current transformer connection

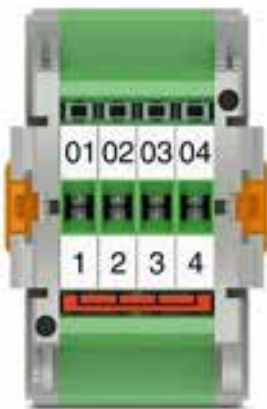

Plug-in test socket for voltage transducers



Plug-in test socket for power supply and signals



Plug-in test socket, test plug, cover

Type	Order No.	Required quantity	Type	Order No.	Required quantity	Type	Order No.	Required quantity
RSCWE 6-3/4SL GN	1029997	1	RSCWE 6-3/4SL	1029994	1	RSCWE 6-3/4SL	1029994	1
FTP-3/4SL GN	1030003	1	FTP-3/4SL	1030004	1	FTP-3/4SL	1030004	1
FBP-3/4SL	1030010	1	FBP-3/4SL	1030010	1	FBP-3/4SL	1030010	1
Plug-in bridge								
FBS 4-8	3030307	1						

Snap-Lock plug-in test system



- Quick and simple realization of even small-position protection and measurement applications
- Contact technology identical to that of the FAME 3 system
- SL versions feature simple, screw-free mounting combined with a compact design
- Ideal safety during operation thanks to coded protection against reverse polarity
- Current transformer applications are realized with green plug-in test socket, voltage transformer circuits with the gray versions
- Simple disconnection at all times for service and maintenance work

Notes:
1) Derating curve available on request.
2) Test surge voltage 5 kV.

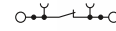

new

30 A, plug-in test socket, wall mounting



Maximum electrical data	
Rated data	
Rated voltage	[V] 400 ²⁾
Nominal current / cross section	[A] / [mm ²] 24 ¹⁾ / 6
Rated cross section	[mm ²] 6
Cross section range	AWG 24 - 8
Connection capacity, DIN 46234	
Cable lugs, DIN 46234	[mm ²] 0.5 - 10
Connection bolt / hole diameter / width	[mm] 4.1 / 4.3 / 8
Connection capacity, DIN 46237	
Cable lugs DIN 46237	[mm ²] 0.5 - 10
Connection bolt / hole diameter / width	[mm] 4.1 / 4.3 / 8
Color code	red 1.00 mm ² blue 2.50 mm ² yellow 6.00 mm ²
General data	
Stripping length	[mm] 12
Tightening torque	[Nm] 1.5 - 1.8
Panel thickness	[mm] 1 - 4
Tightening torque: test socket screw	[Nm] -
Insulating material	PA
Flammability rating in accordance with UL 94	V0

Technical data			
I _{max} [A]	U _{max} [V]	max. Ø [mm ²]	AWG (UL)
30	400²⁾	0.5 - 10	20-8
IEC 60947-7-1	UL / CUL	CSA	IEC / EN 60079-7
IEC	UL / CUL	CSA	IEC / EN 60079-7

Description	Color
Test terminal strip, 4-pos.	gray
4-pos.	green
6-pos.	Green/blue
6-pos.	transparent

Isolating plug, 1-pos.	
2-pos.	green
3-pos.	red
4-pos.	red

Service test plug, 1-pos., with test sockets	
2-pos., without test sockets	red
3-pos., without test sockets	red
4-pos., without test sockets	red
Shoulder bag, for FAME connectors	black
Screwdriver	

Lateral groove labeling	
UC-TM 8, UCT-TM 8, ZB 8 or TMT (EX9,5)R (see Catalog 3)	

Ordering data		
Type	Order No.	Pcs./Pkt.
RSCWE 6-3/4SL	1029994	1
RSCWE 6-3/4SL GN	1029997	1
RSCWE 6-3/6SL GN/BU	1090786	1

Accessories		
FIP-3/1 SERVICE	3069921	1
FIP-3/2 SERVICE	3069920	1
FIP-3/3 SERVICE	3069312	1
FIP-3/4 SERVICE	3069313	1
FTP-2/1 SERVICE	3069469	1
FTP-2/2 SERVICE	3069464	1
FTP-2/3 SERVICE	3069465	1
FTP-2/4 SERVICE	3069468	1
SF-SL 0,8X4,0-100	1212551	10

new

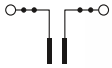

20 A, test plug, 4 mm test socket

new



Transparent cover profile



Technical data			
I_{max} [A]	U_{max} [V]	max. Ø [mm ²]	AWG (UL)
20	400	0.5 - 2.5	-
IEC	UL / CUL	CSA	IEC/ EN 60079-7
400	600	-	-
20 / 2.5	31	-	-
6	-	-	-
20 - 14	-	-	-
-	-	-	-
- / - / -	-	-	-
-	-	-	-
- / - / -	-	-	-
-	-	-	-
-	-	-	-
0.5 - 0.6	-	-	-
PA	-	-	-
V0	-	-	-

Technical data			
		max. Ø [mm ²]	AWG (UL)
		-	-
IEC	UL / CUL	CSA	IEC/ EN 60079-7
-	-	-	-
- / -	-	-	-
-	-	-	-
-	-	-	-
-	-	-	-
- / - / -	-	-	-
-	-	-	-
- / - / -	-	-	-
-	-	-	-
-	-	-	-
-	-	-	-
PVC	-	-	-
V0	-	-	-

Ordering data		
Type	Order No.	Pcs./Pkt.
FTP-3/4SL	1030004	1
FTP-3/4SL GN	1030003	1
FTP-3/6SL GN/BU	1090787	1

Ordering data		
Type	Order No.	Pcs./Pkt.
FBP-3/4SL	1030010	1
FBP-3/6SL	1090788	1

Accessories		
FAME-BAG 260	3069520	1

Accessories		

UC-TM 8, UCT-TM 8, ZB 8 or TMT (EX9,5)R
(see Catalog 3)



FAME 3 Rack, the plug-in test system without operating plug, combines complex switching operations for function tests of current transformers and voltage transducers, as well as tripping and signal contacts, into just one compact and space-saving block. The system operates in accordance with the N/C contact principle. An operating plug is not required. The automatic transformer short circuit function is ensured with plug-in bridges in the plug-in test socket. The design is intended for easy mounting in 19" racks in accordance with IEC 60927-3-101 in two, three and four rack units. One 19" rack can accommodate up to eight plug-in test sockets with a width of 50 mm.



By plugging in and latching the test plug, all test contacts are securely contacted in accordance with the test setup.



The test plug is unlatched by rotating the handle through 45° up to the stop. The test plug can then be pulled out to the intermediate position. The current converter contacts are reconnected with the protective device.



Only after springing the rotary handle back into the starting position can the plug be pulled out completely. The original signal connections are reestablished.

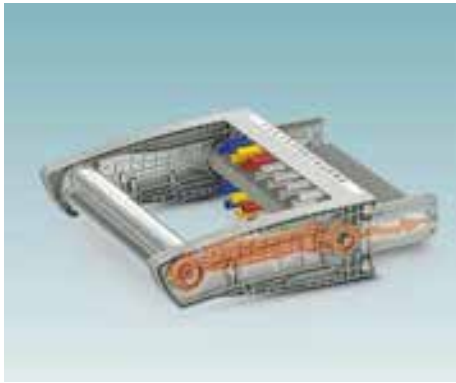

Programmed short-circuit and switching operations are generated by consistent insertion and removal of the test plug. Undefined contact states are effectively avoided thanks to the rotary handle mechanism.



Automatic, leading transformer short circuit implemented with standard plug-in bridges in the plug-in test socket. Short-circuit bridges are designed to be touch-proof. Their positioning on the outside of the control cabinet is clearly visible.



The short-circuit bridge can be covered and marked with standard marking material as an option.



Space saving, thanks to offset test socket arrangements. The test cables can be easily fixed in place with cable ties.

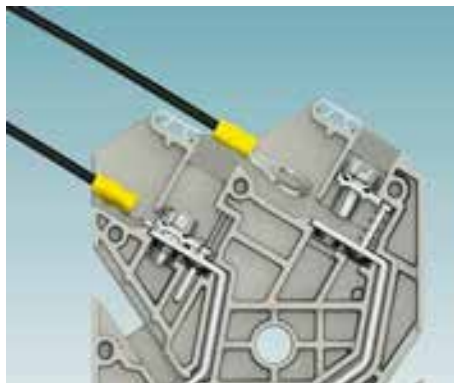

The plug-in test sockets feature BT connection technology with captive screws for ring and fork-type cable lugs.

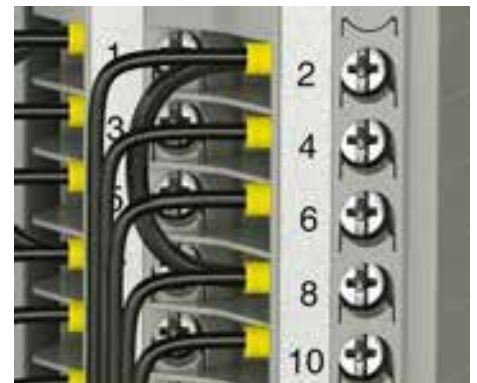

A 2-conductor connection can be realized on the plug-in test socket contacts.



The star point bridges are realized with multi-position standard bridges from the CLIPLINE complete system



A sealable cover with screw connection protects against soiling and unauthorized access to the plug-in test socket.



An optional cover with status contact provides monitoring for the presence of a cover. Removing the cover interrupts the monitoring signal.

Modular 19" plug-in test system without operating plug and transformer short circuit in the plug-in test socket

The switch contact in the plug-in test socket is an N/C contact. In normal operation the contact is closed.



Normal operation

Closed switch contact

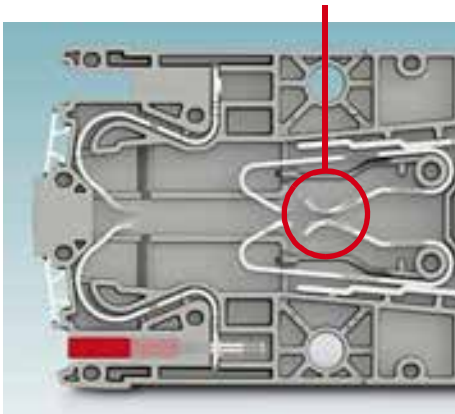

Transformer short circuit

Leading short circuit via auxiliary contact

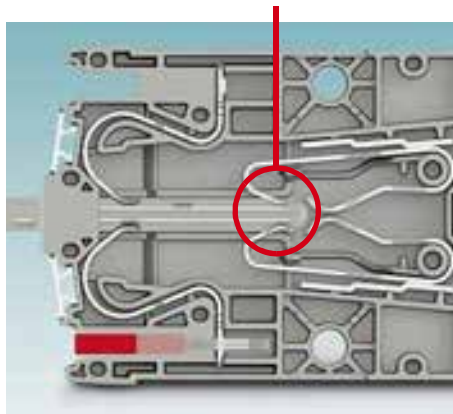

Test operation

Switch contact connected via test socket

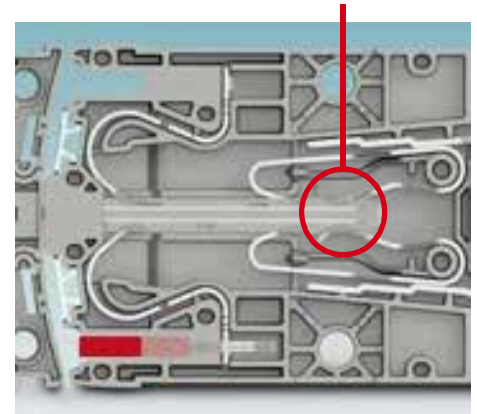

Configurable switching point

Early switching point

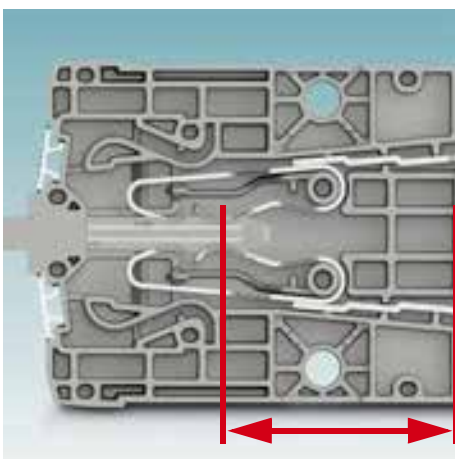

Contact in the top position (L-plate)

Due to the long clearance to the connection contact, "L-plates" are switched without delay when inserted.

Delayed switching point

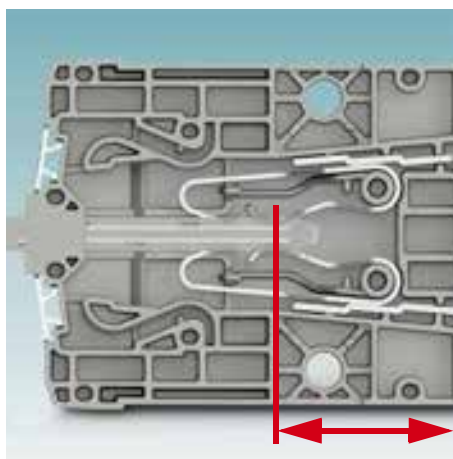

Contact in the middle position (M-plate)

Due to the medium clearance to the connection contact, "M-plates" are switched with a medium delay when inserted.

Late switching point

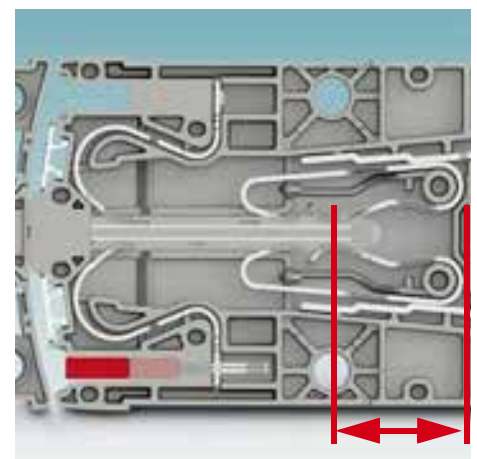

Contact in the bottom position (S-plate)

Due to the short clearance to the connection contact, "S-plates" are switched last with a large delay when inserted.

Mains protection – Circuit example with star point grounding in the plug-in test socket

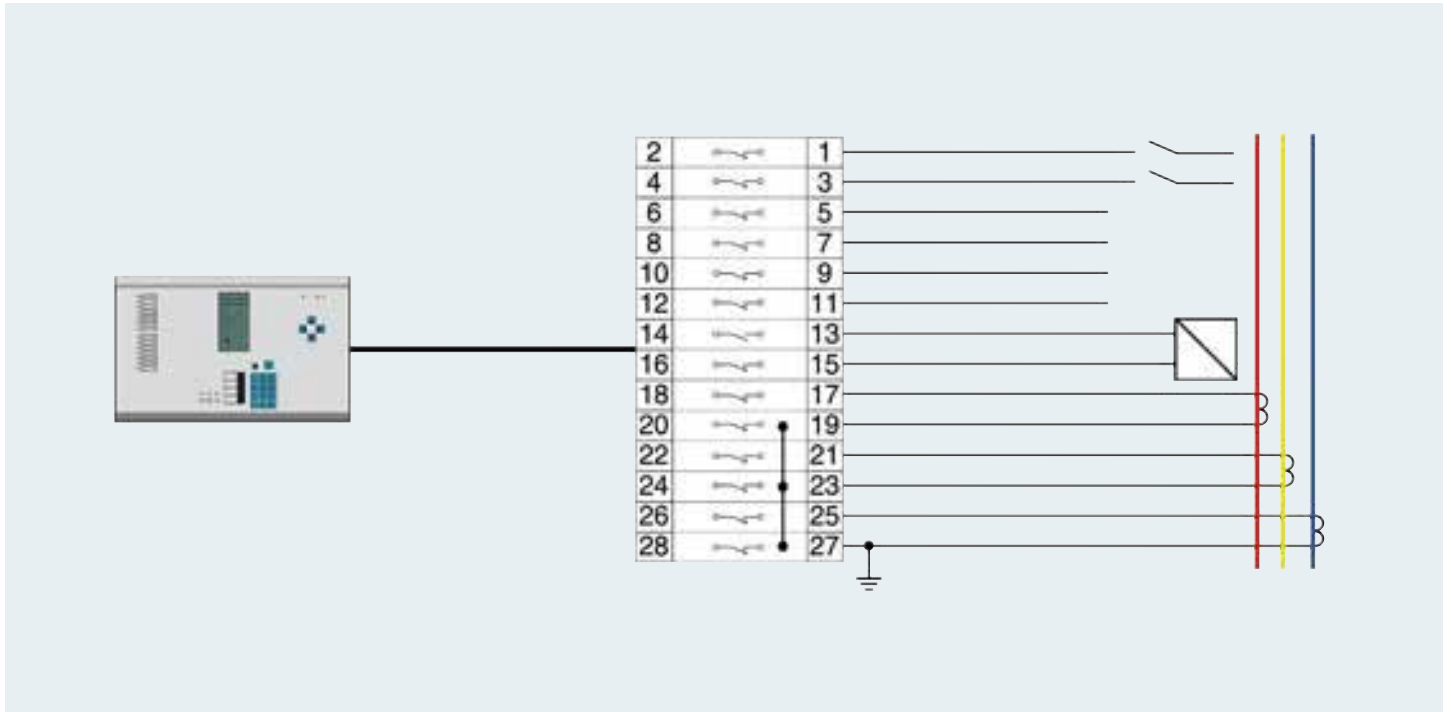

Plug-in test socket for 19" mounting with current transformer, power supply, and signal contacts

Test plug with current transformer, power supply, and signal contacts

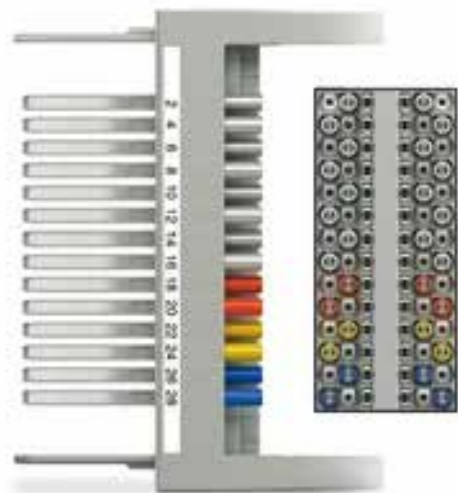

Plug-in test socket, blind plug

Type	Order No.	Required quantity
BTFE 6-3/14 4U AUX	1029025	1
FBP-3F/14 4U AUX	1029339	1

Plug-in bridge

FBS 1/3/5-8	3032389	1
FBS 2-8	3030284	3

Test plug

Type	Order No.	Required quantity
FTP-3/14 4U	1029268	1

19" plug-in test sockets and test plugs

new

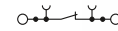

24 A, plug-in test socket, rack mounting

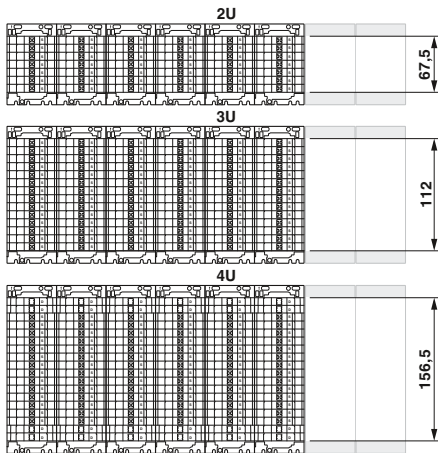

- Thanks to the modularity of the FAME 3 rack system, plug-in test sockets with two rack units and up to seven positions can be replicated
- Up to 12 positions with three rack units, up to 18 positions with four rack units
- Unused contacts are filed with dummy disks
- Dummy disks are not necessary when mounting directly in front plates or doors outside of the 19" format
- Extremely flexible plug-in test system with an overall width of just 50 mm

Maximum electrical data	
Rated data	
Rated voltage	[V] 400
Nominal current / cross section	[A] / [mm ²] 24 / 6
Rated cross section	[mm ²] 4
Cross section range	AWG 24 - 10
Connection capacity, DIN 46234	
Cable lugs, DIN 46234	[mm ²] 0.5 - 6
Connection bolt / hole diameter / width	[mm] 3.5 / 3.7 / 6.8
Connection capacity, DIN 46237	
Cable lugs DIN 46237	[mm ²] 0.5 - 6
Connection bolt / hole diameter / width	[mm] 3.5 / 3.7 / 6.8
Color code	red 1.00 mm ² blue 2.50 mm ² yellow 6.00 mm ²
General data	
Tightening torque	[Nm] 1 - 1.3
Tightening torque: test socket screw	[Nm] -
Insulating material	PC
Flammability rating in accordance with UL 94	V0

Technical data			
I_{max} [A]	U_{max} [V]	max. \varnothing [mm ²]	AWG (UL)
24	400	0.5 - 6	-
IEC 60947-7-1			
IEC	UL / CUL	CSA	IEC / EN 60079-7

Description	Color
Plug-in test socket, 7-pos., 2 rack units	gray
8-pos.	gray
12-pos., 3 rack units	gray
12-pos., 3 rack units, with status contact	gray
14-pos.	gray
14-pos., 4 rack units	gray
14-pos., with status contact	gray
14-pos., 4 rack units, with status contact	gray
18-pos., 4 rack units	gray

Ordering data		
Type	Order No.	Pcs./Pkt.
BTFE 6-3/7 2U	1029245	1
BTFE 6-3/8	1029246	1
BTFE 6-3/12 3U	1029249	1
BTFE 6-3/12 3U AUX	1029250	1
BTFE 6-3/14	1029252	1
BTFE 6-3/14 4U	1029251	1
BTFE 6-3/14 AUX	1029253	1
BTFE 6-3/14 4U AUX	1029025	1
BTFE 6-3/18 4U	1029255	1

Shoulder bag, for FAME connectors	black
Screwdriver	

Accessories		
Part No.	Order No.	Pcs./Pkt.
SF-SL 0,8X4,0-100	1212551	10

Marking	
----------------	--

UC-TM 8, UCT-TM 8, ZB 8 or TMT (EX9,5)R (see Catalog 3)
UC-TMF 8, UCT-TMF 8, ZBF 8 or TMT (EX6,2)R (see Catalog 3)



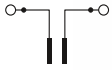

new



20 A, test plug, 4 mm test sockets

new



Blind plug, 7- to 18-pos.



new



24 A, blind plug, with status contact

Technical data			
I_{max} [A]	U_{max} [V]	max. Ø [mm ²]	AWG (UL)
20	400	0.5 - 2.5	-
IEC	UL / CUL	CSA	IEC/ EN 60079-7
400	-	-	-
20 / 2.5	-	-	-
4	-	-	-
24 - 10	-	-	-
-	-	-	-
- / - / -	-	-	-
-	-	-	-
- / - / -	-	-	-
-	-	-	-
- / - / -	-	-	-
-	-	-	-
0.5 - 0.6	-	-	-
PC	-	-	-
V0	-	-	-

Technical data			
		max. Ø [mm ²]	AWG (UL)
		-	-
IEC	UL / CUL	CSA	IEC/ EN 60079-7
-	-	-	-
- / -	-	-	-
-	-	-	-
-	-	-	-
-	-	-	-
- / - / -	-	-	-
-	-	-	-
- / - / -	-	-	-
-	-	-	-
-	-	-	-
- / - / -	-	-	-
-	-	-	-
PC	-	-	-
V0	-	-	-

Technical data			
I_{max} [A]	U_{max} [V]	max. Ø [mm ²]	AWG (UL)
24	250	-	-
IEC	UL / CUL	CSA	IEC/ EN 60079-7
250	-	-	-
24 / 6	-	-	-
-	-	-	-
-	-	-	-
-	-	-	-
- / - / -	-	-	-
-	-	-	-
- / - / -	-	-	-
-	-	-	-
- / - / -	-	-	-
-	-	-	-
PC	-	-	-
V0	-	-	-

Ordering data		
Type	Order No.	Pcs./Pkt.
FTP-3F/7 2U	1029262	1
FTP-3F/8	1029263	1
FTP-3F/12 3U	1029267	1
FTP-3F/14	1029269	1
FTP-3F/14 4U	1029268	1
FTP-3F/18 4U	1029273	1

Ordering data		
Type	Order No.	Pcs./Pkt.
FBP-3F 2U	1029275	1
FBP-3F/8	1029278	1
FBP-3F 3U	1029276	1
FBP-3F/14	1029280	1
FBP-3F 4U	1029279	1

Ordering data		
Type	Order No.	Pcs./Pkt.
FBP-3F/12 3U AUX	1029337	1
FBP-3F/14 AUX	1029338	1
FBP-3F/14 4U AUX	1029339	1

Accessories		
FAME-BAG 260	3069520	1

Accessories		
FAME-BAG 260	3069520	1

Accessories		
FAME-BAG 260	3069520	1

UC-TMF 8, UCT-TMF 8, ZBF 8 or TMT (EX6,2)R (see Catalog 3)

UC-TM 8, UCT-TM 8, ZB 8 or TMT (EX9,5)R (see Catalog 3)
UC-TMF 8, UCT-TMF 8, ZBF 8 or TMT (EX6,2)R (see Catalog 3)

UC-TM 8, UCT-TM 8, ZB 8 or TMT (EX9,5)R (see Catalog 3)
UC-TMF 8, UCT-TMF 8, ZBF 8 or TMT (EX6,2)R (see Catalog 3)

PT-WE ... panel feed-through terminal blocks

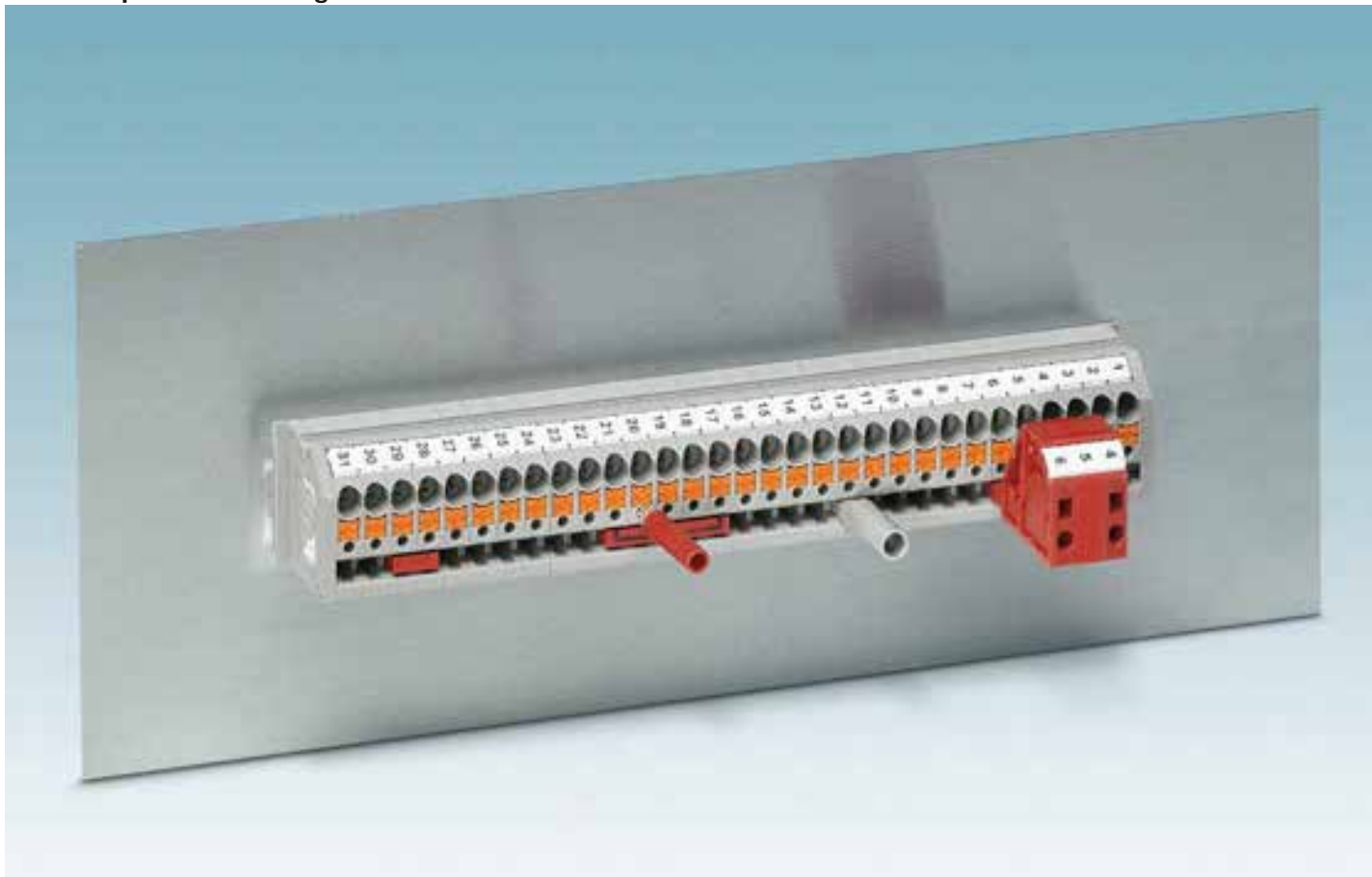

i Your web code: #0456

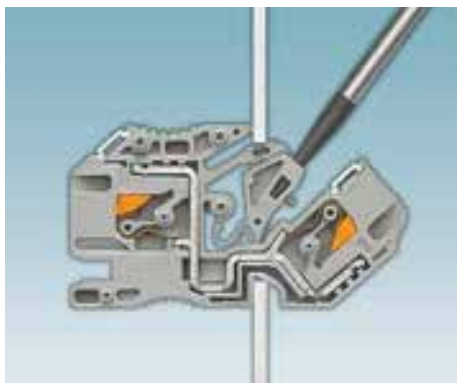

Feed-through terminal blocks in miniature format

The compact PT 4-WE feed-through terminal blocks are tailored towards the cramped conditions in network protection devices. The connection cross section of 4 mm² is achieved with an internal dimension of just 22 mm. The patented latching principle is used in the panel cutout for easy fastening.



Universal thanks to modular design

PT 4-WE feed-through terminal blocks have a modular design. They can be easily connected to form terminal strips with different numbers of positions. They are finished off with cover elements which cover the rest of the opening in the panel cutout. Alternatively, pre-assembled terminal strips with up to 20 positions are also available.



Push-in connection technology

The conductor connection is established directly, quickly, and easily. This saves a huge amount of time, particularly when carrying out internal device wiring at the factory. The Push-in connection also provides tangible benefits when it comes to the outside of the device. Furthermore, operation is easier thanks to the standardized accessories from the CLIPLINE complete system.

PT 4-WE feed-through terminal blocks

The PT 4-WE series of feed-through terminal blocks is designed for the requirements that arise when connecting current and voltage transformers.

- Primarily intended for network protection devices
- Can be installed in all panel cutouts with a sheet thickness of up to 2.5 mm
- Quick and easy fastening thanks to the patented latch
- Actuation with standard screwdriver



Dimensions	
	[mm]
Maximum electrical data	
Rated data	
Rated voltage	[V]
Nominal current / cross section	[A] / [mm ²]
Rated cross section	[mm ²]
Cross section range	AWG
Connection capacity	
1 conductor	[mm ²]
2 flexible conductors with a TWIN ferrule	[mm ²]
Connection cross sections directly plug-in	[mm ²]
General data	
Stripping length	[mm]
Panel thickness	[mm]
Insulating material	PA
Flammability rating in accordance with UL 94	V0

Technical data				
Width	Length	Height		
7.6	51.1	26.9		
I_{max} [A]	U_{max} [V]	max. \varnothing [mm ²]	AWG (UL)	
30	500	0.14 - 4	24-10	
IEC 60947-7-1				
IEC	UL / CUL	CSA	IEC / EN 60079-7	
500	300	300	-	
24 / 4	25	25 / -	-	
2.5	-	-	-	
26 - 12	24-10	24-10	-	
Rigid		Flexible		
		Ferrule without/with plastic sleeve		
0.14 - 4	0.14 - 4	0.14 - 2.5	0.14 - 2.5	
-	-	-	0.5 - 0.5	
0.34 - 4	-	0.34 - 2.5	0.34 - 2.5	
10 - 12				
1 - 2.5				
PA				
V0				

Description	Color
Panel feed-through terminal block	gray
Terminal block, with cover on both sides, 1-pos.	gray
2-pos.	gray
3-pos.	gray
4-pos.	gray
5-pos.	gray
6-pos.	gray
7-pos.	gray
8-pos.	gray
9-pos.	gray
10-pos.	gray
11-pos.	gray
12-pos.	gray
13-pos.	gray
14-pos.	gray
15-pos.	gray
16-pos.	gray
17-pos.	gray
18-pos.	gray
19 pos.	gray
20-pos.	gray

Ordering data			
Type	Order No.	Pcs./Pkt.	
PT 4-WE	3044900	50	
PT 4-WE/1	3044906	25	
PT 4-WE/2	3044907	25	
PT 4-WE/3	3044908	25	
PT 4-WE/4	3044909	25	
PT 4-WE/5	3044910	25	
PT 4-WE/6	3044911	10	
PT 4-WE/7	3044912	10	
PT 4-WE/8	3044913	10	
PT 4-WE/9	3044914	10	
PT 4-WE/10	3044915	10	
PT 4-WE/11	3044916	5	
PT 4-WE/12	3044917	5	
PT 4-WE/13	3044918	5	
PT 4-WE/14	3044919	5	
PT 4-WE/15	3044920	5	
PT 4-WE/16	3044921	5	
PT 4-WE/17	3044922	5	
PT 4-WE/18	3044923	5	
PT 4-WE/19	3044924	5	
PT 4-WE/20	3044925	5	

Cover, 5 mm width, alignable left and right	gray
Lateral groove labeling	

Accessories		
D-PT 4-WE	3044902	25
UC-TMF 5, UCT-TMF 5 or ZBF 5 (see Catalog 3)		

Line and cable routing for the control cabinet door



The swivel arm of the cable guiding system makes it particularly easy and safe to install your conductors, cables, and cable harnesses for the control cabinet door or swivel mounting frame. This solution saves time, as the patent-pending swivel joints can be opened and pre-assembled cables can be fed through or pulled through without using any tools.

i Your web code: #1146



Tool-free opening and closing of swivel joints

The orange swivel link allows you to open the swivel joints without using any tools. Installing and pulling through cables is quite simple.



Easy cable routing of pre-assembled data cables

The cable guiding system is designed for standard data cables. The wires will not be damaged, even after opening and closing 2000 times. This is made possible by using large bending radii and defined movements.



Safe cable routing for test disconnect sockets

To enable monitoring and operation from outside, devices and test disconnect sockets like FAME are mounted in the control cabinet door in protection and control engineering applications.

CGS cable guiding system



The cable guiding system makes it particularly easy and safe to install your conductors, cables, and cable harnesses for the control cabinet door or swivel mounting frame.

- Subsequent wiring can be performed quickly and easily via the rotating blisters which can be operated without tools
- Cable routing for the control cabinet door can be planned with the CAD system using the defined installation space and swivel range
- Quick and easy mounting, thanks to integrated flanges with strain relief
- Mechanical cable protection and bundling, thanks to covering hoods that can be attached without tools
- Secure with M5 tapping screws



Dimensions	
	[mm]
General data	
Cable entry opening	[mm]
Number of cables	
Insulating material	
Flammability rating in accordance with UL 94	

Description	Color
Cable guiding system, with swivel joint for opening	gray
Cable entry opening, with closed swivel joint	gray

Covering hood	Color
CGS-AH 50 SET	gray

Technical data		
Width	Length	Height
68	218	140.5
42		
100 for 1.5 mm ²		
-		
V0		

Ordering data		
Type	Order No.	Pcs./Pkt.
CGSA 50	3071401	1
CGS 50	3071400	1

Accessories		
CGS-AH 50 SET	Order No.	Pcs./Pkt.
CGS-AH 50 SET	3071410	1

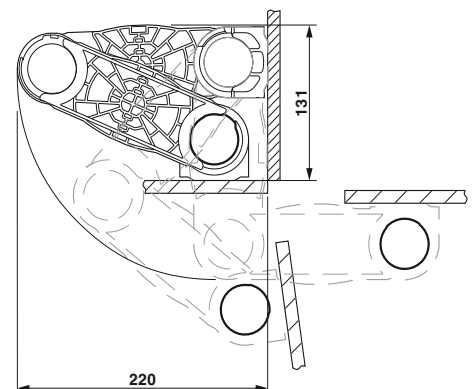
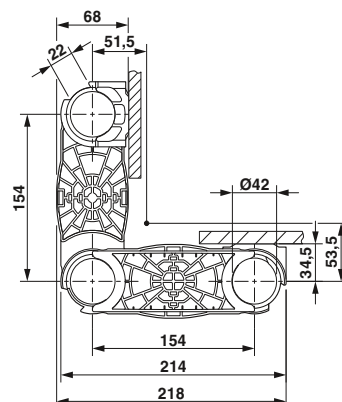
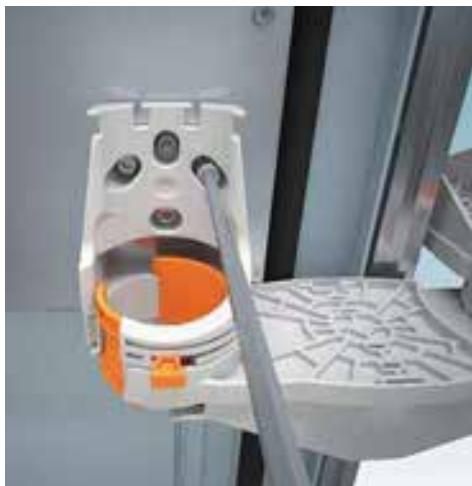



The PT 1,5/S series enables the space-saving and time-saving wiring of signals. With a terminal width of just 3.5 mm, solutions that can be disconnected and plugged in are available in addition to the wide range of feed-through terminal blocks.



With double-level knife disconnect terminal blocks, you can fit up to 572 signals in one meter. The clear color assignment of the disconnect element to the wiring level prevents errors that could occur if the wrong signal circuit were opened.



The comprehensive range of disconnect and fuse terminal blocks offers numerous solutions for potentially explosive areas. All common protection concepts are included.



In addition to being used in applications with increased safety (Ex e), Phoenix Contact terminal blocks can also be used in intrinsically safe circuits. Blue versions are available for identification. Intrinsically safe and non-intrinsically safe circuits can be separated using corresponding partition plates.



The PTRV ... marshalling terminal is designed for signal and potential distribution applications with increased packing density. Due to its compact length and color-coded design, it is the ideal basis for user-friendly wiring.

For marshalling terminals, see from page 46.



For efficient wall and DIN rail mounting, the modular system of the PTMC marshalling patchboard enables customer-specific and color-true marshalling with any number of positions.

For marshalling patchboards, see from page 57.

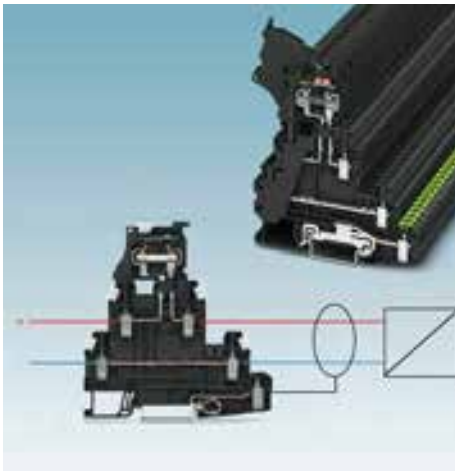

By combining the fuse lever, feed-through, and PE foot, shielded signal circuits can be reliably wired in a single terminal block.

Find out more with the web code

Detailed information on these products can be found on our website. Simply enter # followed by the numbers in the search field.



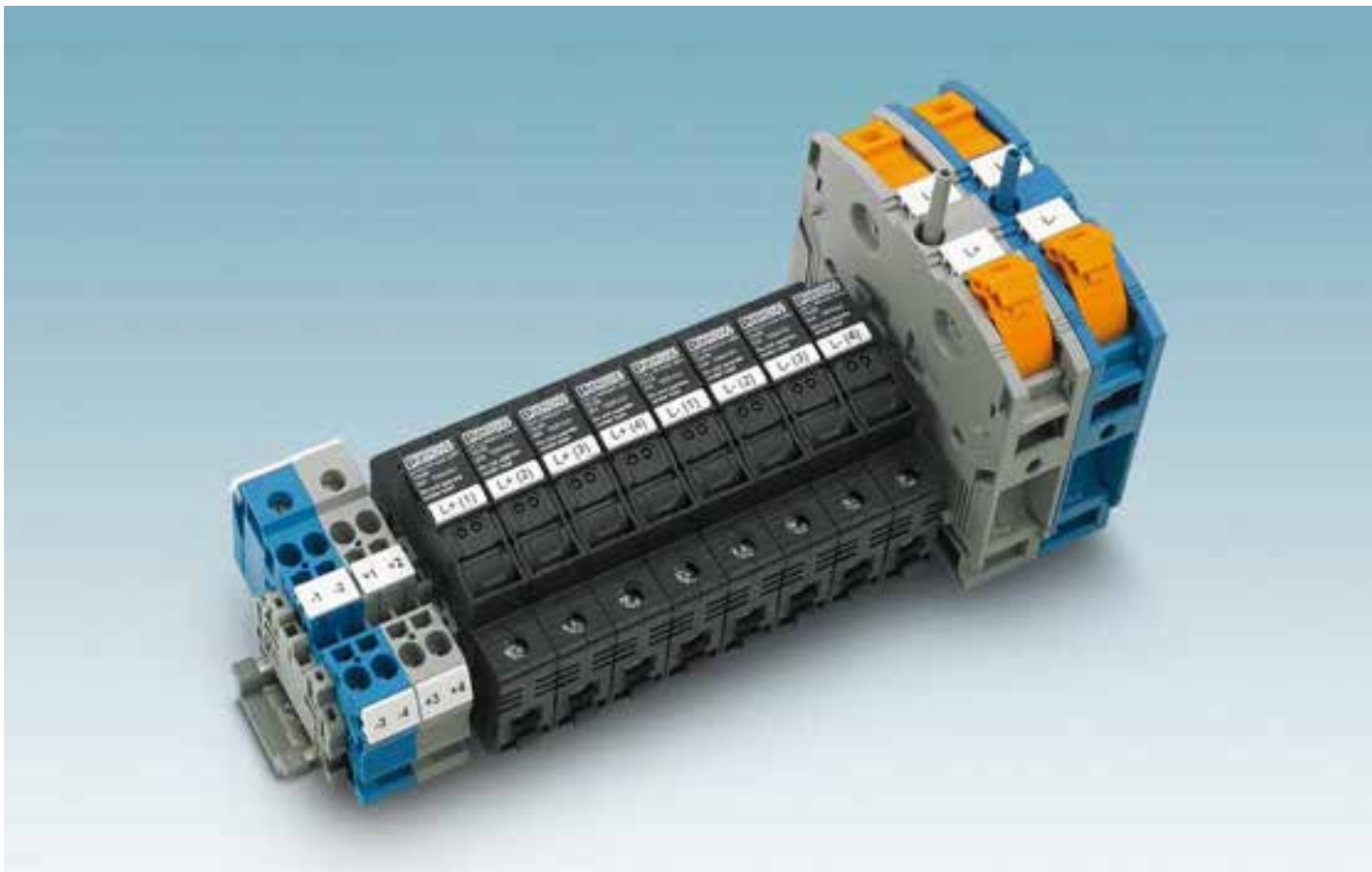

In the mix of renewable energies consisting of wind power, hydropower, biomass, and geothermal energy, solar power in Germany, for example, has taken the leading position. Throughout the world, solar power generation offers the greatest potential and has enjoyed the most widespread acceptance.

While standard products can be used in the AC area of a solar system, a more specific approach is required for the DC area as a result of its special structure and characteristics.

In order to keep cable losses to a minimum, PV panels are connected to strings, thereby increasing the system voltage. Off-load voltages of PV systems can reach up to 1000 V DC / 1500 V DC.

These high DC voltages place particular demands on the components used.

In contrast to AC voltage, the DC voltage that is present allows creepage distances to be created very easily on the surface of insulating elements. The components used in this area must therefore have increased air clearances and creepage distances.

In order to limit reverse currents which can occur in the event of a short circuit, the individual strings are protected. With crystalline modules, fuses are primarily used for this, while with thin-film modules, blocking diodes are installed in the circuit.

Modular terminal blocks and fuses from Phoenix Contact cleverly meet the special requirements of photovoltaic systems. You will find a summary of all components in the “Components and systems for photovoltaics” brochure.

The photovoltaic terminal blocks can be found in the relevant sections on the respective connection technologies.

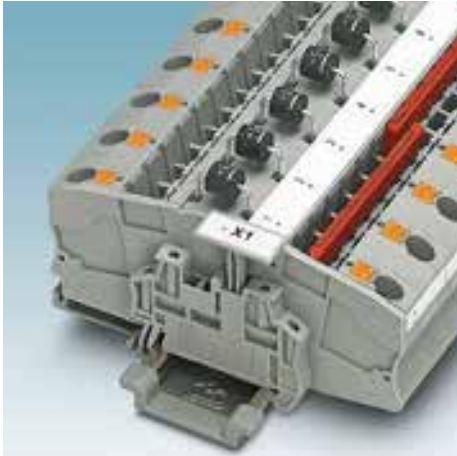

The STME 6-DIO HV and PTME 6-DIO HV diode terminal blocks serve as line diodes and are used in thin-film photovoltaic systems to prevent reverse currents. This means that the often sensitive thin-film modules are ideally protected to provide long-term stability.



Conductors with larger cross sections are used for the connection between device connection boxes and inverters due to their higher currents and longer cable lengths. UKH ... and RBO ... terminal blocks can accommodate conductors with a cross section of up to 300 mm².



The individual strings can be connected quickly while also saving space using potential collective terminals. The output side of the terminal blocks accommodates up to 35 mm² of conductor in a screw terminal point.



The DC line fuses have specially tailored, ultra-fast gPV characteristics. They can safely and continuously transmit at system voltages of 1000 V DC or 1500 V DC and up to 25 A, and protect strings against reverse currents in the event of an error.

Find out more with the web code

Detailed information on these products can be found on our website. Simply enter # followed by the numbers in the search field.





Electrical installations in communal facilities such as schools, hospitals, assembly points, restaurants, and all public buildings must fulfil special normative requirements. Insulation resistances must be measured during startup or when servicing the system in accordance with DIN VDE 0108-100 (EN 50172) without directly disconnecting the neutral conductor. Installation terminal blocks from Phoenix Contact are precisely tailored to the requirements of electrical installations and distributor construction.

The neutral conductor can be conveniently separated for test purposes by means of a screwless, spring-loaded disconnect metal. Contact with the 3 x 10 mm standard profile can be achieved by simply swinging this open using a standard screwdriver. The disconnect slide locks into the end positions and the switching states are clearly signaled. These are sound prerequisites for the quick and safe testing of all versions. Potential can be multiplied easily, thanks to the double function shafts. Clearly visible marking surfaces and testing facilities at every terminal point ensure clarity, regardless of the mounting position.

Numerous versions with screw, spring-cage or Push-in technology are available for all applications, and all versions are completely compatible.

The installation terminal blocks can be found in the relevant sections on the respective connection technologies.



The screwless disconnect slide makes contact when it is simply slid onto the neutral busbar using a standard screwdriver. The switch position of the disconnect slide is clearly signaled.

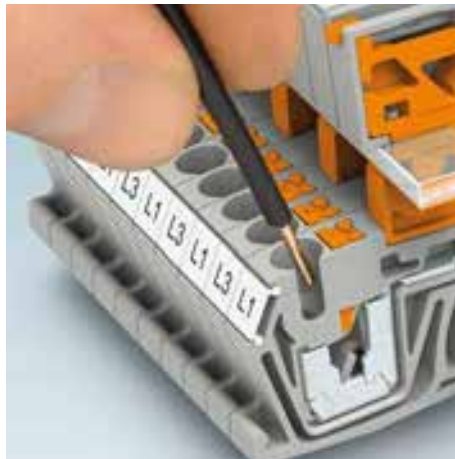

PTI installation terminal blocks with Push-in connection can be wired without tools. Strip the conductors, plug them in, and you're done. This represents a clear advantage in terms of the time it takes to perform wiring. The terminal blocks can be released using the actuation lever made from insulation material.



All installation terminal blocks are equipped with test openings on every level. All measurements and testing can therefore be carried out quickly and easily, even when all function shafts are occupied.

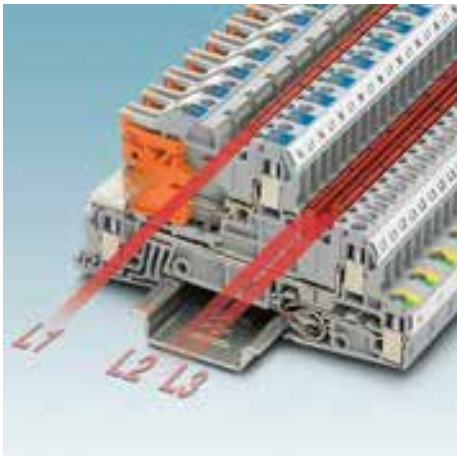

Double function shafts on each level provide comprehensive potential distribution. Even three-phase connections can be implemented conveniently and in a compact space with an overall width of just 10 mm. Lateral distribution is performed with FBS ... plug-in bridges.

Find out more with the web code

Detailed information on these products can be found on our website. Simply enter # followed by the numbers in the search field.





Configuration software, services for terminal strips, housings and markings

The CLIPLINE complete terminal block product range is complimented with the PROJECT complete marking software as well as an extended range of products and services for perfect control cabinets and switchgear.

PROJECT complete combines terminal strip configuration with a high-performance marking tool. The direct data exchange with all conventional CAE programs, as well as the creation of complete project documentation and the simple ordering option makes this software unique.

i Your web code: #1093

Along with terminal strip production, the range of services also includes services from the CLIPSAFE housing solutions range. The plastic or metal housings are available for the Ex or non-Ex area as empty enclosures, processed empty enclosures, or assembled with your terminal strips.

i Your web code: #0140

The range of services is rounded out with various mounting services and the option of delivering individual, pre-scheduled material sets.

The following product ranges can be found in Catalog 3

MARKING system marking systems
TOOL fox tools
CABINET add-on mounting material

The comprehensive solution for your control cabinet

Easy planning, intuitive installation
COMPLETE line is a system comprising technologically leading and coordinated hardware and software products, consulting services, and system solutions that help you to optimize your processes in control cabinet manufacturing. Engineering, purchasing, installation, and operation become significantly easier for you.

Product range overview

Planning and marking software	664
Terminal strip service	668
Junction boxes and empty enclosures service	670
Marking service	672

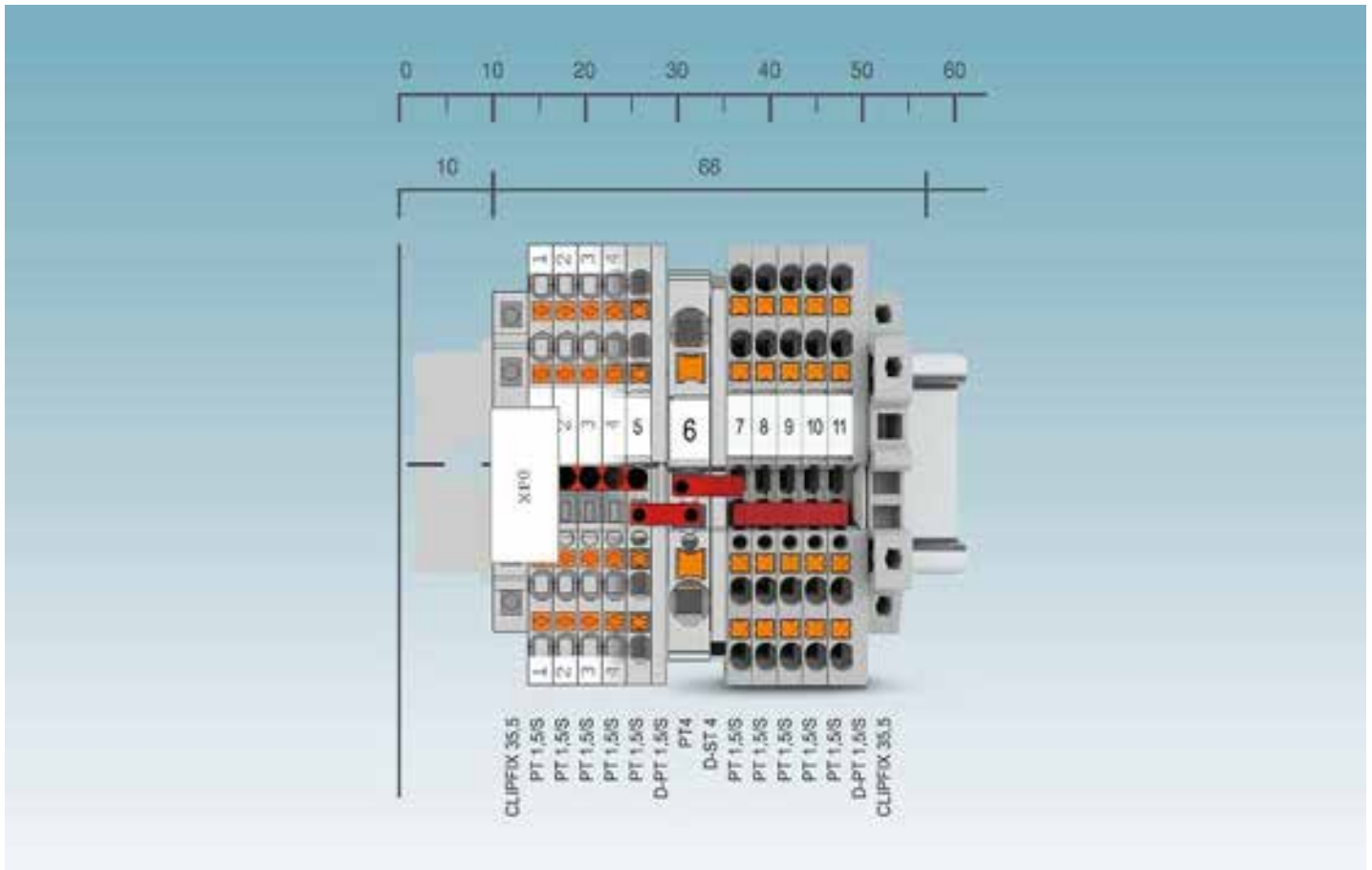

i Your web code: #1093



The intuitively arranged home page provides you with a quick start guide of your recent projects, features helpful templates, and informs you of the latest updates.

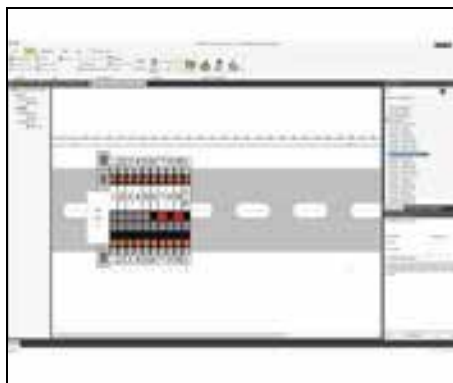

Operate PROJECT complete with ease via the intuitively designed functions. Easily customize the menu bars to your individual needs via drag-and-drop using the mouse.



Import projects directly from electrical plans. PROJECT complete includes interfaces to all conventional CAE programs.

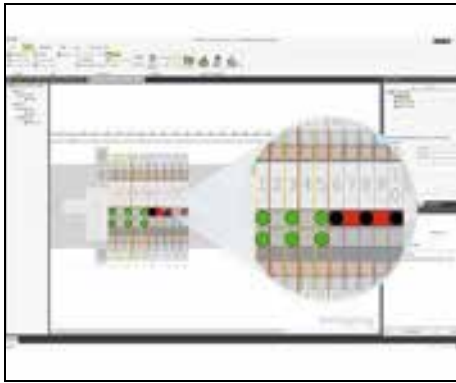

PROJECT complete automates many steps and reduces the effort involved. Manually bridging or planning individual markings is no longer necessary.



Create the right markings for your projects with PROJECT complete. The software controls all marking systems from Phoenix Contact.



The intelligent search function in PROJECT complete selects the appropriate material using filters, reliably directing you to the perfect solution for your application.

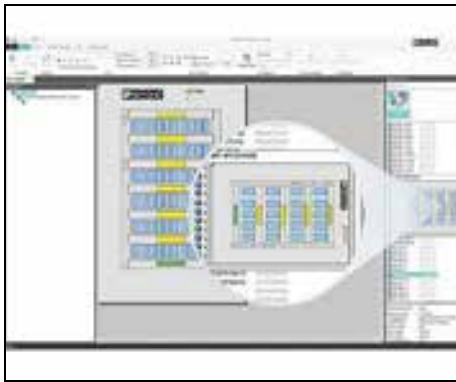

In the template preview, you can see the breakdown of a material immediately and thus find the right product for your application faster.



PROJECT complete processes different file formats for the custom design of your marking.



Send your project to your personal solution area on the Phoenix Contact homepage at the touch of a button and submit your order straightaway.



The "My Solutions" area on the Phoenix Contact website lists all the available projects that you have created and sent using PROJECT complete.



Select one of your projects and receive a quote based on your personal price terms, plus information regarding product availability, without delay.



Order your projects online without any intermediate steps and track the status of your delivery at any time.

PROJECT complete

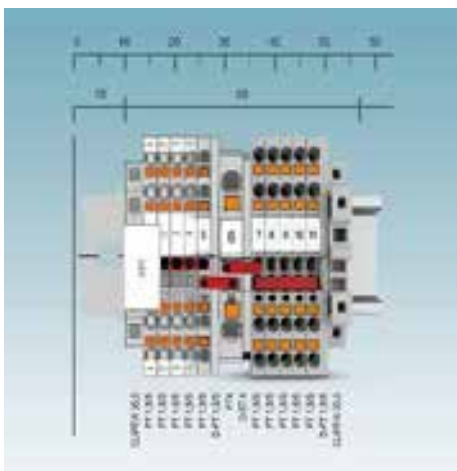

PROJECT complete enables the quick planning and configuration of terminal strips for the control cabinet and field. It is also possible to create individual markings for terminal blocks, cables and lines, devices, and systems:

- The automatic correction function performs a logical test of the terminal strips and automatically adds the necessary accessories such as covers and end brackets
- The terminal strip configurator enables the distributed arrangement of individual terminal strips on different DIN rails
- 3D preview and complete documentation of the assembled DIN rails, such as order and mounting lists
- High-performance import of labeling information and extensive design options for the creation of individualized marking
- Numerous sorting and filter functions for efficient organization of your print jobs
- Support for all marking materials and output devices from Phoenix Contact
- Automatic Internet update
- Intuitive user interface

To reduce input effort and improve data quality, PROJECT complete enables the exchange of data with electrical planning systems in both directions:

- The necessary products are chosen automatically based on the circuit diagram and all of the product data is written back to the parts lists
- The marking information is automatically exported and assigned to the desired marking materials
- In order to ensure unique assignment of the marking even in the case of large projects, the project structure tree is transferred from the CAE system to PROJECT complete. This also enables the marking to be output in sub-projects

General data

Software interface

System requirements

Operating system

Description

PROJECT complete, planning and marking software for the configuration of terminal blocks and for the professional marking of marking materials for terminal strips, conductors, cables, devices, and systems, German/English/French/Dutch, Italian/Spanish/Russian/Polish/Hungarian/Czech/Turkish/Portuguese/Chinese, and Japanese

new



Technical data

EPLAN Electric P8
 AUCOTEC ELCAD
 AUCOTEC Engineering Base
 AUCOTEC RUPLAN
 ZUKEN E³
 Bentley Promis-e
 WSCAD
 IGE XAO
 PC-Schematic AUTOMATION
 SDProget SPAC

MS Windows 7 (32/64-bit), MS Windows 8 (32/64-bit),
 MS Windows 8.1 (32/64-bit), MS Windows 10 (32/64-bit)

Ordering data

Type	Order No.	Pcs./Pkt.
PROJECT COMPLETE	1050453	1



The perfect solution for every application. This applies from simple printed marking labels, through individual DIN rails and terminal strips created fully ready for installation, right through to assembled, connection-ready housings. The Phoenix Contact service portfolio also includes installation solutions on mounting plates and customer-specific sets for simplified ordering and logistics sequences. You will benefit from optimized, electronic order management right through to production, as well comprehensive product or project documentation, including electronic data for CAD, ERP and classification systems.

Our staff will be happy to work with you to create the ideal solution for your application on site or support you in taking the best advantage of our services.

- Our services at a glance:
- Professional advice and optimized order and project management
 - PROJECT complete – free planning and marking software
 - High-performance terminal strip and marking production
 - Housing and mounting solutions
 - Individual material sets
 - Electronic product, project and solution documentation including all relevant data
 - Contacts available worldwide
 - Simple electronic ordering options

Make the most of our comprehensive product portfolio and range of services to create your optimum solution.



PROJECT complete is the central software suite for the creation of customer-specific projects. Take advantage of the following range of services directly from within the software, via the Phoenix Contact e-shop, or via direct, personal contact.

If necessary, you will be accompanied by one of our specialists during the planning and realization of terminal strips and housing solutions.

Our terminal strip service provides you with help in managing order peaks flexibly, and enables you to deliver terminal strips just-in-time for your series production batches.



We create the markings for your terminal blocks and terminal strips, cables and conductors, as well as housings and systems in accordance with your specifications.

Housings will be processed in accordance with your requirements and mounted ready for wiring with configured terminal strips or other products from the Phoenix Contact portfolio.

We will produce DIN rails in special lengths, with mounting-optimized hole grids, as well as with affixed impact nuts or threaded bolts.



We will supply individual, pre-scheduled material sets meaning that you can reduce effort and expenditure in material and stock management.



i Your web code: #0140



Ex stainless steel empty enclosures

The stainless steel Ex enclosure product range provides comprehensive protection for your applications in industrial environments and in process technology. The product range consists of standardized enclosures in sizes up to 1000 mm x 1000 mm x 300 mm. On request, we can expand the enclosures into ATEX- and IECEx-approved junction boxes.



Ex polyester empty enclosure

The comprehensive range of polyester Ex enclosures provides comprehensive protection for your applications in Ex areas. On request, we can expand the enclosures into ATEX- and IECEx-approved junction boxes.



Polyester empty enclosure

The extensive standard polyester enclosure range provides robust standard enclosures for industrial environments as well as for non-potentially explosive areas in the process industry. The enclosures are expanded in line with your requirements into junction boxes and control boxes.



Empty enclosure

Select the ideal enclosure for your application. Custom dimensions and surface treatments are available on request. For applications in the Ex area, the enclosures are supplied with corresponding component approval in accordance with ATEX or IECEx.



Empty enclosures customized in accordance with customer specifications

We can customize the enclosures in accordance with your specifications with threads, bore holes, and rectangular cutouts. The Ex standards in accordance with ATEX and IECEx are taken into consideration. The enclosures are supplied with corresponding component approval.



Junction boxes assembled in accordance with customer specifications

If desired, you can obtain the CLIPSAFE empty enclosure completely equipped with components and cable glands. For use in potentially explosive areas, the junction boxes are supplied with corresponding equipment approval in accordance with ATEX and IECEx.



Customer-specific solutions

To obtain a quick quote for your customized junction box and enclosure solution, please fill out the request form on the website. You can easily describe your requirements using the form. We will then prepare an individual quote based on the information provided. Just enter the web code into the search field on our website.

i Your web code: #0851

Find out more with the web code

Detailed information on these products can be found on our website. Simply enter # followed by the numbers in the search field.



Easy ordering via PROJECT complete

Create customer-specific markings quickly and easily with PROJECT complete and then order them online.

Color printed marking solutions

You can use marking materials in UniCard and UniSheet format as well as metal labels for color printing.

We mark marking materials in accordance with your requirements

All materials which can be marked in accordance with customer requirements are indicated with this symbol. The ordering process is described for you on the following page.

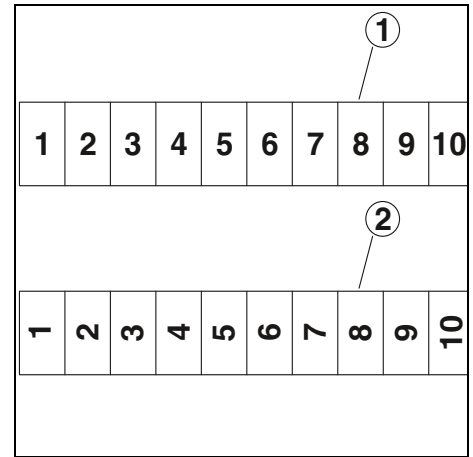
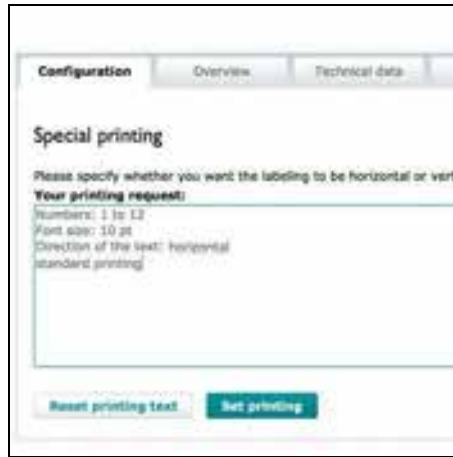

Ordering special labeling, step 1

All marking materials are available on our website. Order your custom printing. Search for the item you want on our website. Choose materials with the ending CUS.

Ordering special labeling, step 2

Configuration of the selected CUS item: under the **Configuration** category, you can enter the required marking data in the free text field.

Tasks required:

- Marking text
- Font size
- Read direction "horizontal" (1) or "vertical" (2)
- Normal or bold print
- Please send special characters, symbols, and logos as an image file

Ordering special labeling, step 3

- Zack marker strip (ZB ...): 1 strip
- Card material (US-...): 1 card
- Plastic sheet (e.g., UC(T)-...): 1 sheet
- Sheet material (e.g., BMKL ...): 1 sheet
- Rolls (e.g., EML (...x...)R): 1 strip (row)
- Metal labels for the BLUEMARK ID COLOR (e.g., EMP-AL ...): 1 label



Individually marked in accordance with customer requirements:

You will receive your marking materials, custom-marked in accordance with the marking requirements you have provided, as quickly as possible.

Find out more with the web code

Detailed information on these products can be found on our website. Simply enter # followed by the numbers in the search field.



Quality in quantity

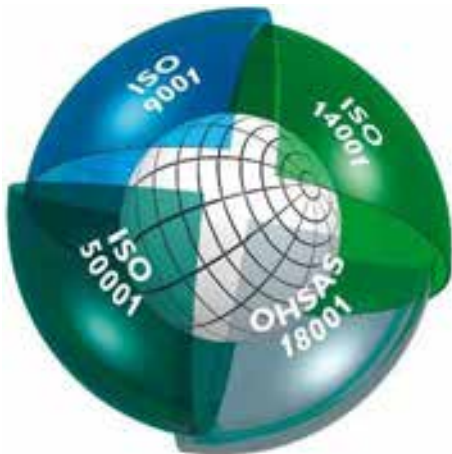

Integrated management system

The objective of the Phoenix Contact integrated management system is to integrate all requirements pertaining to products, processes, and the organization.

Statutory and regulatory requirements, as well as those of international standards and our customers, are met and, in some cases, even exceeded in all phases of the product lifecycle.

The Phoenix Contact management system is monitored by internationally recognized independent bodies each year to ensure that quality, environmental protection, energy efficiency, and occupational safety have been integrated in conformance with the relevant requirements. Certification in accordance with international standards ISO 9001, ISO 14001, ISO 50001, and BS OHSAS 18001 is the result of our corporate philosophy of meeting the needs of our customers, staff, and environment as best as possible. This serves as the basis for innovative products with the familiar high Phoenix Contact quality standard, actively practiced environmental protection through efficient production and products that conserve resources, and responsibility in the field of occupational health and safety. It goes without saying that we integrate all further requirements of standards, international approvals or special customer requirements into our company processes.

The result of this system is a building block for the success of the Phoenix Contact Group as well as its products and services.

CE marking

CE marking was introduced as an important instrument for the free movement of goods and services within the single European market. By applying the mark to a product, the manufacturer confirms its compliance with all EU directives applicable to this product. The EU directives describe the product characteristics with regard to device safety and the avoidance of risks. They have been incorporated in national legislation. Compliance with the requirements is a **condition for placing the product on the market within the EU.**

Where applicable, our products currently fall within the scope of the following directives in particular:

- 2014/35/EU
Electrical equipment designed for use within certain voltage limits (Low Voltage Directive)
- 2014/30/EU
Electromagnetic compatibility (EMC Directive)
- 2014/32/EU
Measuring instruments
- 2006/42/EC
Safety of machinery (Machinery Directive)
- 2014/34/EU
Equipment and protective systems intended for use in potentially explosive atmospheres (ATEX Directive)
- 2014/53/EU
Radio equipment (RED)
- 2011/65/EU
Restriction of the use of certain hazardous substances (RoHS Directive)
- 2012/19/EU
Waste electrical and electronic equipment (WEEE Directive)

The standards used as the basis for the aforementioned directives have been at the heart of our development standard for some time as a way of ensuring compliance with European directives. The numbers of the directives indicate their version at the time of publication. In the event of changes to directives and/or standards, our products will undergo conformity assessment again in good time and a new declaration of conformity will be issued promptly. The current declarations for each product can also be found in our download area.

Among the aforementioned European directives, the EMC Directive plays a particularly important role. It uses a directive enshrined in national legislation as the basis for defining electromagnetic compatibility as a fundamental device property. European legislation therefore places great emphasis on the electromagnetic compatibility of devices and systems as a basic prerequisite for the error-free operation of machines and systems. As an international leader in the field of surge protection, Phoenix Contact has extensive expertise in EMC. This expertise and the experience gained over many years in the development and application of industrial interface and communication technology have resulted in an extremely high standard of quality for our products when it comes to electromagnetic compatibility. Our independent laboratory, Phoenix Testlab, was founded in order to share this expertise with other companies. Phoenix Testlab GmbH is an accredited service company, which carries out EMC testing in compliance with European standards. At Phoenix Testlab, devices are

also tested with regard to their electrical safety, mechanical influences, and their behavior in relation to environmental influences. Phoenix Testlab is also a notified body in accordance with EMC Directive 2014/30/EU and Radio Equipment Directive (RED) 2014/53/EU. As a certification body (TCB, FCB, and RCB), Phoenix Testlab is also able to approve these products for the markets in the USA, Canada, and Japan.

Standards and regulations

All relevant standards and regulations are used as the basis for the development and maintenance of our products.

International standards are subject to continuous changes as a result of harmonization and new developments. In line with this process, the current version of all standards that are relevant to our products is documented in the product area on our website at phoenixcontact.net/products.

Online product information service on the world wide web















































Phoenix Contact is continuously extending its product range.

Within the scope of our product monitoring obligation, all products are subject to an improvement process.

The Internet is an ideal platform to quickly communicate new product developments and improvements to the market.

You can quickly access the relevant Phoenix Contact website for your region via phoenixcontact.com. There you will always find an up-to-date overview of products, solutions, and services from Phoenix Contact. This includes technical documents such as data sheets and user manuals, current driver and demo software, and a direct link to the relevant contact person.

Certification authorities and marks

Certification authorities and approvals	Country code	Explosion protection	Country code	Marine classification societies	Country code
 IECEx CB Scheme (in combination with certifying body)	International	 International Electrotechnical Commission	International	 DNV GL - MARITIME	DE
 CENELEC Certification Agreement (CCA inspection report) (in combination with certifying body)	EU	 ATEX Directive	EU	 Bureau Veritas	FR
 Canadian Standards Association (CSA)	CA	 Canadian Standards Association (CSA)	CA	 Lloyd's Register of Shipping	GB
 Canadian Standards Association (CSA) - CSA approval for the USA -	US	 Canadian Standards Association (CSA) - CSA approval for the USA -	US	 Nippon Kaiji Kyokai	JP
 Canadian Standards Association (CSA) combined logo - CSA approval for Canada and the USA -	CA US	 Canadian Standards Association (CSA) combined logo - CSA approval for Canada and the USA -	CA US	 Polski Rejestr Statków	PL
 Underwriters Laboratories Inc. (UL)	US	 Underwriters Laboratories Inc. (UL)	US	 Russian Maritime Register of Shipping	RU
 Underwriters Laboratories Inc. (UL) - UL approval for Canada -	CA	 Underwriters Laboratories Inc. (UL) - UL approval for Canada -	CA	 Korean Register of Shipping	KR
 Underwriters Laboratories Inc. (UL) combined logo - UL approval for the USA and Canada -	US CA	 Underwriters Laboratories Inc. (UL) combined logo - UL approval for the USA and Canada -	US CA	 American Bureau of Shipping	US
 INSIEME PER LA QUALITA'E LA SICUREZZA	IT	 FM Approvals	US	 Registro Italiano Navale	IT
 Eurasian Conformity	EAEU	 FM Approvals - FM approval for Canada -	CA		
 DEKRA Certification B.V.	NL	 FM Approvals - FM approval for the USA and Canada -	US CA		
 Österreichischer Verband für Elektrotechnik	AT	 Eurasian Conformity for Ex-products	EAEU		
 Eurofins Electrosuisse Product Testing AG SEV certification scheme	CH	 Korean Certification Mark for Ex-products	KR		
 Verband Deutscher Elektrotechniker e.V. (VDE) - Approval of drawings - Reports with production monitoring	DE	 National Institute of Metrology, Standardization and Industrial Quality	BR		
 Berufsgenossenschaft (BG) GS - Geprüfte Sicherheit (tested safety)	DE	 National Supervision and Inspection Center for Explosion Protection and Safety of Instrumentation	CN		
 Intertek ETL Listed - Approval for the USA -	US	 Corp. Centro de Investigación y Desarrollo Tecnológico del Sector Eléctrico	CO		
 Intertek ETL Listed - Approval for Canada -	CA				
 Intertek ETL Listed - Approval for the USA and Canada -	US CA				
 TÜV Rheinland Industrie Service GmbH	DE				
 China Compulsory Certification	CN				
 Korean Certification Mark	KR				

Technical information

Terminal block standards and regulations

Competence in connection technology

CLIPLINE complete

Thanks to the implementation of appropriate design measures and the use of high-grade materials, the terminal blocks from Phoenix Contact exceed the requirements imposed by standards.

The terminal blocks undergo tests which exceed the terminal block standard and which permit their use in all industries. The most prominent of these are energy supply, transportation technology, and process engineering, particularly in the chemical, petrochemical, and shipbuilding industries.

The following industry-specific standard tests are performed on the terminal blocks.





Standard



ATEX

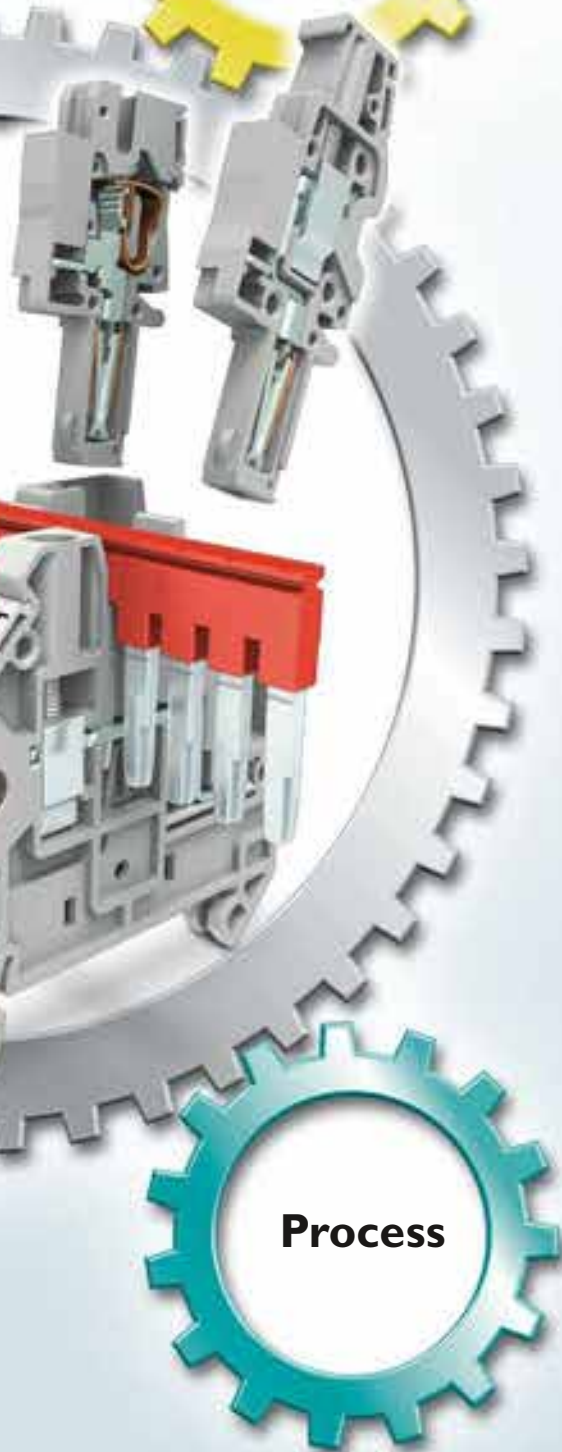

Process



Terminal blocks for potentially explosive areas



Phoenix Contact provides a comprehensive range of Ex-approved connection technology for process engineering. Thanks to the high-quality contact and insulation materials, the terminal blocks are particularly suitable for harsh, potentially explosive industrial applications. The terminal blocks from Phoenix Contact which have been approved for potentially explosive areas are mainly standard terminal blocks. In addition to the usual approvals, the terminal blocks also have an IECEx and ATEX certificate from one of the EU-authorized testing centers (PTB, DEKRA, KIWA ...) in accordance with the IEC/EN 60079-7 standard.

It is not necessary with terminal blocks from Phoenix Contact to differentiate between Ex and non-Ex terminal blocks in the warehouse. The advantages are clear.

Ex e type of protection

When the installation instructions are followed, the terminal blocks listed on the website stated in the following satisfy the requirements for the “increased safety” degree of protection Ex eb or Ex ec. The terminal blocks with Ex eb type of protection are therefore approved for installation in wiring spaces of zone 2 and, in particular, zone 1. The housings for installing the terminal blocks must also be approved for Ex e type of protection and must have at least IP54 degree of protection.

The terminal blocks approved for Ex eb type of protection are divided into the following groups:

- Push-in connection terminal blocks
- Screw connection terminal blocks
- Spring-cage connection terminal blocks
- Fast connection terminal blocks
- Miniature terminal blocks
- Terminal blocks for specialized applications.

Along with the feed-through terminal blocks, function terminals – i.e. safety terminal blocks and test-disconnect terminal blocks – are available with Ex ec type of protection for use in zone 2 areas.

Ex i type of protection

No special approval is required for terminal blocks in applications with the Ex i “intrinsic safety” type of protection. In addition to Ex-e approved terminal blocks, other standard terminal blocks are also



used here. The increased requirements for air clearances and creepage distances

- Between adjacent terminal blocks
- Between terminal blocks and grounded metal parts

as well as distances through rigid insulation are specified in IEC/EN 60079-11.

Detailed information on terminal blocks in the Ex “e” and Ex “i” area are available in the product area on our website at: phoenixcontact.net/products as a download for the approved product.

You will find detailed information here, including certificates, declarations of conformity, and application notes or installation instructions with the following content:

- Technical data in accordance with IEC/EN 60079
- Approved accessories
- Important installation instructions and mounting diagrams

Marking

The explosion-protected equipment must be marked in such a way as to ensure that it is used correctly in accordance with its safety characteristics.

The marking of equipment is described in the harmonized standard IEC/EN 60079. Terminal blocks with an “increased safety” type of protection must be appropriately marked. An example of the marking is shown in the adjacent table.

Marking in accordance with the ATEX 2014/34/EU directive	
Manufacturer or trademark	
Address of the manufacturer	D-32823 Blomberg
Number of the notified body	0344
Common marking in the EU	
Equipment group	II
Equipment category	2
Use in atmospheres	
Gas and/or	G
Dust	D
Marking in accordance with IEC/EN 60079-0 and IEC/EN 60079-7 for increased safety	
Manufacturer or trademark	
Type Description	PT 2,5 ...
Abbreviation of the explosion protection	Ex
Type of protection	eb
Equipment group	II
Equipment protection level	Gb
ID of the notified body	PTB
ATEX certificate no.	09 ATEX 1111 U
IECEx certificate no.	IECEx PTB 10.0021 U

Worldwide explosion protection

IEC 60079

Explosion protection around the world is mainly based on the IEC 60079 series of international standards and on European and American standards and directives.

In North America, the basis for this is the National Electric Code (NEC) in the USA and the Canadian Electrical Code (CEC) in Canada. Directive 2014/34/EU is of particular importance to manufacturers of devices and protective systems within CENELEC countries of the European Union and beyond. We meet international requirements with IECEx certificates. This means that use with the “increased safety” Ex eb type of protection is permitted in zone 1 and 2 and with Ex ec in zone 2.

However, this is only under the condition that the terminal blocks are installed in housings that are qualified and certified for the respective type of protection.

Requirements on terminal blocks

The types of protection “d” – flameproof enclosure, “p” – pressurized enclosure, “m”, “q”, and “o” (molded, sand or oil immersion) do not place any special requirements on terminal blocks. The protection principle of the increased safety “e” type of protection (IEC/EN 60079-7) is essentially based on stricter design measures. The most important of these for terminal blocks are:

- Air clearances and creepage distances
- Terminal blocks must be secured against loosening and they must be attached and designed such that the cables cannot come loose or become impermissibly damaged by the terminal point
- No transfer of clamping pressure via insulated parts
- Terminal blocks that are intended for the connection of multi-stranded conductors must be fitted with an elastic intermediate element

These requirements and the technical data are checked by an independent testing institute (notified body, e.g. PTB, DEKRA, KIWA, ...) and certified by the appropriate certificate. Proof of the following tests via type test:

- Type test in accordance with IEC 60947-7-1/-2
- Proof of air clearances and creepage distances and dielectric test
 - Aging test:
 - Stored for 14 days at 95°C and 95% humidity
 - Stored for 14 additional days in dry heat, level of TI value of insulation material



Components such as terminal blocks for use in potentially explosive areas must be marked, as shown in the example.

- Stored for 24 hours at a low temperature of -65°C with subsequent conductor pull-out test.

Ex e-approved terminal blocks from Phoenix Contact are standard modular terminal blocks. These terminals are individually tested in accordance with IEC/EN 60079 during the manufacturing process, including a dielectric test.

Note

Detailed information and installation notes for terminal blocks in the Ex area are available in the product area of the website at phoenixcontact.net/products.



The certificates certify that the testing was carried out by the respective notified body.

Connection capacity

IEC 60947-7-1/-2

This mechanical test defines the connection of standard conductors in accordance with the manufacturer's information.

Terminal blocks must be designed in such a way that conductors with the documented rated cross section and the rated connecting capacity can be connected. The specifications are documented by the manufacturer in metric [mm²] and American AWG values.

Rated cross section means:

Value of the maximum possible cross section of all connectable conductors (flexible and single or multi-stranded) that certain thermal, mechanical, and electrical requirements refer to.

Rated connection capacity means:

The range encompassing the largest to the smallest connectable cross section (reduced by at least two increments) and the number of connectable conductors for which the terminal block is designed.

During the test, the terminal blocks are connected with the rated cross section and the rated connection capacity.

Alternatively, the rated cross section can also be verified using gauges, see illustrations.

It must be possible to freely insert conductors or gauges into or connect them to the open terminal point.

Terminal blocks from Phoenix Contact offer dimensions for the defined rated cross section that are well above those required by the standard. Thanks to appropriate design measures, the rated cross sections can also be connected with a ferrule and insulating collar for all terminal blocks from the CLIPLINE complete system.

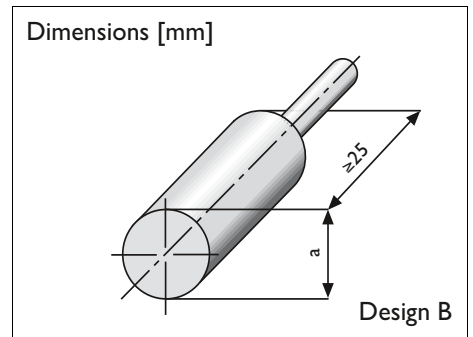
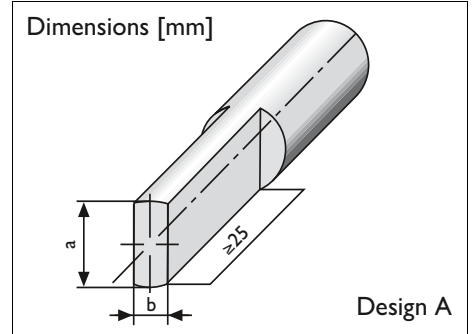

Gauges (internal cylindrical gauge) of design A and B in accordance with IEC 60947-1

Structure and dimensions of connecting cables

Cross section	Single-Flexible		Multi-stranded		Fine-Flexible		Gauge no.	American Wire Gauge					
	Diameter max. dimension	Number of strands	Diameter max. dimension	Number of strands (minimum)	Diameter max. dimension	Number of strands (guide value)		Rigid conductors*			Flexible conductors*		
[mm ²]	[mm]		[mm]		[mm]		AWG	[Ø mm]	[Circ. mil]	[mm ²]	[Ø mm]	[Circ. mil]	[mm ²]
0.2	0.5	1	-	-	-	-	24	0.51	404	0.21	-	-	-
0.5	0.9	1	1.1	7	1.1	16	20	0.81	1022	0.52	0.97	1111	0.56
0.75	1.0	1	1.2	7	1.3	24	18	1.02	1620	0.82	1.16	1600	0.82
1	1.2	1	1.4	7	1.5	32	(17)	1.15	2050	1.04	-	-	-
-	-	-	-	-	-	-	16	1.29	2580	1.31	1.50	2580	1.32
1.5	1.5	1	1.7	7	1.8	30	(15)	1.45	3260	1.65	-	-	-
-	-	-	-	-	-	-	14	1.63	4110	2.08	1.85	4100	2.09
2.5	1.9	1	2.2	7	2.3	50	(13)	1.83	5180	2.63	-	-	-
-	-	-	-	-	-	-	12	2.05	6530	3.31	2.41	6500	3.32
4	2.4	1	2.7	7	2.9	56	(11)	2.30	8230	4.17	-	-	-
-	-	-	-	-	-	-	10	2.59	10380	5.26	2.95	10530	5.37
6	2.9	1	3.3	7	3.9	84	(9)	2.91	13100	6.63	-	-	-
-	-	-	-	-	-	-	8	3.26	16510	8.37	3.73	16625	8.48
10	3.7	1	4.2	7	5.1	80	(7)	3.67	20800	10.56	4.15	20820	10.55
-	-	-	-	-	-	-	6	4.12	26240	13.30	4.67	26250	13.39
16	4.6	1	5.3	7	6.3	126	(5)	4.62	33100	16.77	5.24	33100	16.77
-	-	-	-	-	-	-	4	5.19	41740	21.15	5.90	41650	21.24
25	-	-	6.6	7	7.8	196	3	5.83	52600	26.67	6.61	52630	26.67
35	-	-	7.9	7	9.2	276	2	6.54	66360	33.62	7.42	66150	33.74
-	-	-	-	-	-	-	1	7.35	83690	42.41	8.33	83706	42.69
50	-	-	9.1	19	11	396	1/0	8.25	105600	53.51	9.35	104640	53.36
70	-	-	11	19	13.1	360	2/0	9.27	133100	67.44	10.52	132300	67.47
95	-	-	12.9	19	15.1	475	3/0	10.40	167800	85.03	11.79	172500	87.98
-	-	-	-	-	-	-	4/0	11.08	211600	107.22	13.26	210400	107.30
120	-	-	14.5	37	17	608	250 kcmil	-	250 MCM	127	14.62	250000	127.00
150	-	-	16.2	37	19	756	300 kcmil	-	300 MCM	152	16.00	300000	152.00
185	-	-	18	37	21	925	350 kcmil	-	350 MCM	177	17.30	350000	177.00
240	-	-	20.6	61	24	1224	500 kcmil	-	500 MCM	253	20.66	500000	253.00
300	-	-	23.1	61	27	1525	600 kcmil	-	600 MCM	304	-	-	-
400	-	-	26.1	61	31	-	-	-	-	-	-	-	-

* 1000 Circular mil = 1 MCM = 1 kcmil

Connecting aluminum conductors

UT and UKH series screw terminal blocks are suitable for the direct connection of aluminum conductors in accordance with the guidelines governing conductor pretreatment. Under pressure, aluminum yields more easily than copper due to a lower modulus of elasticity. It is said to “flow”. Furthermore, after stripping the aluminum conductor, an oxide layer forms on the conductor surface due to its reaction with air. This oxide layer leads to increased contact resistance between the aluminum conductor and the terminal point. The oxide layer must therefore be removed before wiring. In addition, the maximum current carrying capacity of aluminum conductors is lower than that of copper

wires. In general, if the same current carrying capacity is required of the aluminum conductor, the selected cross section will be larger than for a copper wire. Based on the properties specified, UT ... and UKH ... series screw connection terminal blocks from Phoenix Contact have been qualified for the use of aluminum conductors through extensive tests. An important quality feature of this qualification is the 1000-hour current cycling test in accordance with IEC 61545. As part of this test, current is applied to the terminal block and aluminum conductor combination for an hour and is then switched off for an hour. The cycle is repeated 500 times. During this 1000-hour period, temperature measurements are taken at the

terminal points in accordance with a defined schedule. The measured values must not exceed defined limit values. The table below lists all Phoenix Contact screw connection terminal blocks that have undergone these tests.

Approved combinations of screw connection terminal blocks with aluminum conductors

Color versions of terminal block series are included in the approval.

Terminal block	Conductor cross section [mm ²]														Recommended tightening torque [Nm]	
	2.5	4	6	10	16	25	35	50	70	95	120	150	185	250		
UT 2,5 (-PE)	RE	RE														0.6
UT 4 (-PE)	RE	RE	RE													0.8
UT 6 (-PE)	RE	RE	RE	RE												1.8
UT 10 (-PE)	RE	RE	RE	RE	RE											1.8
UT 16 (-PE)	RE	RE	RE	RE	RE	RE										3.0
UT 35 (-PE)	RE	RE	RE	RE	RE	RE	RE									3.7
UKH 25			RE	RE	RE	RE										4.5
UKH 50							RE	SE								8
UKH 70								SE	SE							10
UKH 95									SE	SE						20
UKH 150											SE	SE				30
UKH 240													SE	SE		30

RE Round, single-strand, Class 1, approved

SE Sector-shaped, single-strand, Class 1, $\alpha = 90^\circ$, approved



Single-strand aluminum conductors in round (RE) form up to 35 mm² with the relevant approved cross section can be connected directly to the above-listed feed-through terminal blocks with screw connections. When connecting aluminum conductors that are 50 mm² and above, only sector-shaped, rigid conductors (SE) may be used and inserted in accordance with the adjacent graphic.

When directly connecting aluminum conductors to UT ... and UKH ... series feed-through terminal blocks from Phoenix Contact, the following guidelines on conductor pretreatment must be followed:

- Remove the oxide layer from the stripped end of the aluminum conductor using a

blade (suitable knife, e.g. the WIREFOX-D 13 stripping tool)

- Immerse immediately in non-acid and non-alkali neutral Vaseline.
- The installation location must be kept free of humidity and aggressive atmospheres.
- When using an aluminum conductor, tighten the screw in the clamping part of the screw terminal block with the recommended tightening torque of the respective terminal block. There is no need to tighten the terminal point. (See torque screwdriver, Catalog 3)
- The pretreatment must be repeated when reconnecting the conductors.

Mount sector-shaped aluminum conductors in accordance with the graphic in the terminal point of UKH terminal blocks. The rounded section of the conductor should be at the top so that the right-angled area of the aluminum conductor is positioned on the prism-shaped base of the terminal sleeve.

Accessories, for example, bi-metal cable lugs (Al/Cu compression cable lug), can be

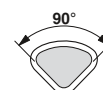
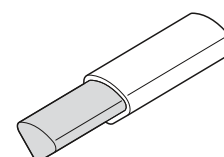
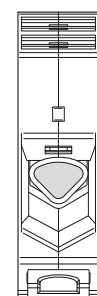

Example for UKH ...: Connecting sector-shaped, single-strand aluminum conductors

used to connect multi-stranded aluminum conductors. See phoenixcontact.net/products

Technical information

Bolt connection terminal blocks and high-current connectors

Bolt connection terminal blocks are available as single-bolt or double-bolt versions or with a screw/bolt mixed connection. The latter have high-current connectors with a terminal sleeve connection on one side and a screw set for the connection of cable lugs on the other side. The dimensions of the various types are shown in the following drawings and tables.

Secure cable lug connection

Cable lugs are securely connected in UHV ..., HV ..., and RT ... high-current terminal blocks using a screw set. In this case screw locking is achieved with a spring washer. You can connect cable lugs in accordance with DIN 46234, DIN 46235, and DIN 46237. A 2-conductor connection is also possible. In this case connect one conductor under the current bar using a cable lug and the other on top of the current bar. See diagram below right.

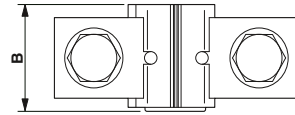
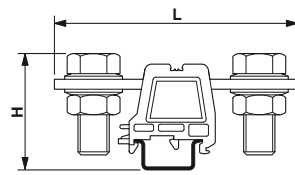

UHV ...AS/AS

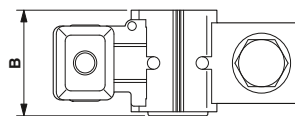
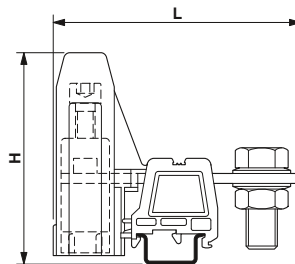

UHV ...KH/AS

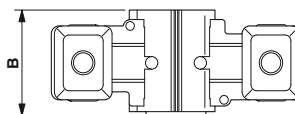
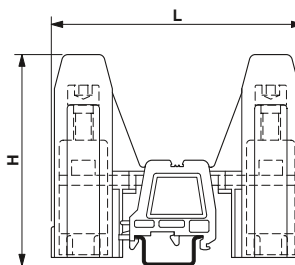

UHV ...KH/KH

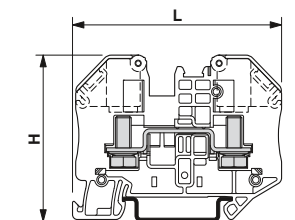

RT ... and RTO ...

UHV ... high-current connectors with bolt connection

Type	H [mm] / [inch]	L [mm] / [inch]	W [mm] / [inch]
UHV 25-AS/AS	53 / 2.087	88 / 3.456	26 / 1.024
UHV 25-KH/AS	72 / 2.835	95 / 3.74	26 / 1.024
UHV 25-KH/KH	72 / 2.835	102,5 / 4.035	26 / 1.024
UHV 50-AS/AS	54,5 / 2.146	95 / 3.74	32 / 1.26
UHV 50-KH/AS	78 / 3.071	104 / 4.094	32 / 1.26
UHV 50-KH/KH	78 / 3.071	113,5 / 4.469	32 / 1.26
UHV 95-AS/AS	56 / 2.205	110 / 4.331	40 / 1.575
UHV 95-KH/AS	86 / 3.386	114 / 4.488	40 / 1.575
UHV 95-KH/KH	86 / 3.386	118,5 / 4.665	40 / 1.575
UHV 150-AS/AS	56 / 2.205	110 / 4.331	46 / 1.811
UHV 150-KH/AS	100 / 3.937	119 / 4.685	46 / 1.811
UHV 150-KH/KH	100 / 3.937	128,5 / 5.059	46 / 1.811
UHV 240-AS/AS	58 / 2.283	125 / 4.921	53 / 2.087
UHV 240-KH/AS	105,5 / 4.154	126,5 / 4.980	53 / 2.087
UHV 240-KH/KH	105,5 / 4.154	128,5 / 5.059	53 / 2.087

RT ... bolt connection terminal blocks

Type	H [mm] / [inch]	L [mm] / [inch]	W [mm] / [inch]
RT 3	51 / 2.007	66 / 2.598	12,3 / 0.484
RT 4-T-TC	51 / 2.007	82,4 / 3.244	12,3 / 0.484
RT 5	51 / 2.007	66 / 2.598	16,3 / 0.641
RT 5-T	51 / 2.007	91,4 / 3.598	16,3 / 0.641
RT 8	63,8 / 2.511	84 / 3.307	20,3 / 0.799

RTO ... bolt connection terminal blocks

Type	H [mm] / [inch]	L [mm] / [inch]	W [mm] / [inch]
RTO 3	49,9 / 1.965	66 / 2.598	12,3 / 0.484
RTO 4-T-TC	51 / 2.007	82,4 / 3.244	12,3 / 0.484
RTO 5	49,9 / 1.965	66 / 2.598	16,3 / 0.641
RTO 5-T	49,9 / 1.965	91,4 / 3.598	16,3 / 0.641
RTO 8	62,2 / 2.449	84 / 3.307	20,3 / 0.799

Safe Cu multi-layer conductor connection

Cu multi-layer conductors are reliably and safely clamped in the high-current terminal blocks UKH ... and UHV ... with the insertion profile (UKH ...EP). The insertion profile levels out the prism-shaped terminal sleeve base. This ensures that the Cu multi-layer conductor is contacted over a large area.

Clamping suitability of Cu multi-layer conductors

Qty	Dimensions [mm]	Conductor current [A]	Type	
			UHV 50-KH/AS	UHV 95-KH/AS
3 x	9 x 0.8	100	X	X
6 x	9 x 0.8	160	X ¹⁾	X
4 x	16 x 0.8	200	-	X
6 x	16 x 0.8	250	-	X ¹⁾
10 x	16 x 0.8	400	-	X ¹⁾
11 x	21 x 0.8	630	-	-

Qty	Dimensions [mm]	Conductor current [A]	Type	
			UHV 150-KH/AS	UHV 240-KH/AS
3 x	9 x 0.8	100	-	-
6 x	9 x 0.8	160	X	-
4 x	16 x 0.8	200	X	X
6 x	16 x 0.8	250	X	X
10 x	16 x 0.8	400	X ¹⁾	X
11 x	21 x 0.8	630	-	X ¹⁾

¹⁾ Observe nominal current of terminal blocks.

Internal dimensions of terminal sleeves

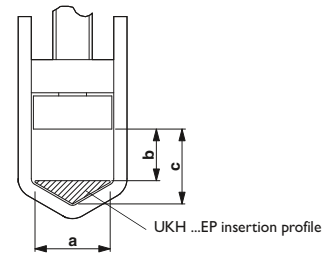

Internal dimensions in [mm] / [inch]

Type	a	b	c
UKH 25 / UHV 25-KH/...	9 / 0.354	- / -	8,5 / 0.335
UKH 50 / UHV 50-KH/...	11 / 0.433	7,5 / 0.295	12 / 0.472
UKH 95 / UHV 95-KH/...	15 / 0.591	11 / 0.433	15 / 0.591
UKH 150 / UHV 150-KH/...	19,5 / 0.768	11 / 0.433	18 / 0.709
UKH 240 / UHV 240-KH/...	24 / 0.945	19 / 0.748	26 / 1.024

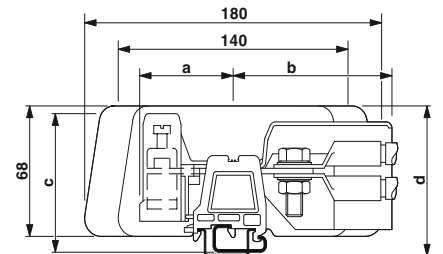

Dimensions for covering hoods and partition plates [mm] / [inch]

Type	a	b	c	d
UHV 25	51 / 2.008	82 / 3.228	70 / 2.756	63 / 2.48
UHV 50	57 / 2.244	97 / 3.819	76 / 2.992	68 / 2.677
UHV 95	59 / 2.323	112 / 4.409	84 / 3.307	75 / 2.953
UHV 150	64 / 2.52	125 / 4.921	98 / 3.858	81 / 3.189
UHV 240	64 / 2.52	143 / 5.63	103 / 4.055	87 / 3.425

Bolt connection terminal blocks and high-current connectors

Cable lugs			DIN 46234				DIN 46235				DIN 46237			
	Conductor cross section		Hole diameter d2		Width d3		Hole diameter d2		Width d3		Hole diameter d2		Width d3	
	[mm²] / [AWG]		[mm] / [inch]		[mm] / [inch]		[mm] / [inch]	[mm] / [inch]		[mm] / [inch]	[mm] / [inch]		[mm] / [inch]	
M3	0.5	20	3.2	0.126	5	0.197	-	-	-	-	-	-	-	
	1	17	3.2	0.126	6	0.236	-	-	-	-	3.2	0.126	6	0.236
	2.5	14	3.2	0.126	6	0.236	-	-	-	-	3.2	0.126	6	0.236
M5	0.5	20	5.3	0.208	8	0.315	-	-	-	-	-	-	-	
	1	17	5.3	0.208	10	0.394	-	-	-	-	5.3	0.208	10	0.394
	2.5	14	5.3	0.208	10	0.394	-	-	-	-	5.3	0.208	10	0.394
	6	10	5.3	0.208	10	0.394	5.3	0.208	8.5	0.335	5.3	0.208	10	0.394
	10	8	5.3	0.208	11	0.433	5.3	0.208	9	0.354	-	-	-	-
	16	6	5.3	0.208	11	0.433	-	-	-	-	-	-	-	-
M6	1.5	16	6.4	0.252	10	0.394	-	-	-	-	-	-	-	
	2.5	14	6.4	0.252	11	0.433	-	-	-	-	6.5	0.256	11	0.433
	6	10	6.4	0.252	11	0.433	6.4	0.252	8.5	0.335	6.5	0.256	11	0.433
	10	8	6.4	0.252	11	0.433	6.4	0.252	9	0.354	-	-	-	-
	16	6	6.4	0.252	11	0.433	6.4	0.252	12	0.472	-	-	-	-
	25	3	6.4	0.252	12	0.472	6.4	0.252	14	0.551	-	-	-	-
	35	2	6.4	0.252	16	0.63	-	-	-	-	-	-	-	-
	50	0	6.4	0.252	18	0.709	-	-	-	-	-	-	-	-
M8	2.5	14	8.4	0.331	14	0.551	-	-	-	-	8.4	0.331	14	0.551
	6	10	8.4	0.331	14	0.551	-	-	-	-	8.4	0.331	14	0.551
	10	8	8.4	0.331	14	0.551	-	-	-	-	-	-	-	-
	16	6	8.4	0.331	14	0.551	8.4	0.331	13	0.512	-	-	-	-
	25	3	8.4	0.331	16	0.63	8.4	0.331	16	0.63	-	-	-	-
	35	2	8.4	0.331	16	0.63	8.4	0.331	17	0.669	-	-	-	-
	50	0	8.4	0.331	18	0.709	8.4	0.331	20	0.787	-	-	-	-
	70	00	8.4	0.331	22	0.866	8.4	0.331	24	0.945	-	-	-	-
	95	000	8.4	0.331	24	0.945	-	-	-	-	-	-	-	-
M10	6	10	10.5	0.413	18	0.709	-	-	-	-	10.5	0.413	18	0.709
	10	8	10.5	0.413	18	0.709	-	-	-	-	-	-	-	-
	16	6	10.5	0.413	18	0.709	10.5	0.413	17	0.669	-	-	-	-
	25	3	10.5	0.413	18	0.709	10.5	0.413	17	0.669	-	-	-	-
	35	2	10.5	0.413	18	0.709	10.5	0.413	19	0.748	-	-	-	-
	50	20	10.5	0.413	18	0.709	10.5	0.413	22	0.866	-	-	-	-
	70	00	10.5	0.413	22	0.866	10.5	0.413	24	0.945	-	-	-	-
	95	000	10.5	0.413	24	0.945	10.5	0.413	28	1.102	-	-	-	-
	120	250 kcmil	10.5	0.413	24	0.945	10.5	0.413	32	1.26	-	-	-	-
	150	300 kcmil	10.5	0.413	30	1.181	10.5	0.413	34	1.339	-	-	-	-
	185	350 kcmil	10.5	0.413	36	1.417	10.5	0.413	37	1.457	-	-	-	-
M12	10	8	13	0.512	22	0.866	-	-	-	-	-	-	-	
	16	6	13	0.512	22	0.866	-	-	-	-	-	-	-	
	25	3	13	0.512	22	0.866	13	0.512	19	0.748	-	-	-	
	35	2	13	0.512	22	0.866	13	0.512	21	0.827	-	-	-	
	50	0	13	0.512	22	0.866	13	0.512	24	0.945	-	-	-	
	70	00	13	0.512	22	0.866	13	0.512	24	0.945	-	-	-	
	95	000	13	0.512	24	0.945	13	0.512	28	1.102	-	-	-	
	120	250 kcmil	13	0.512	24	0.945	13	0.512	32	1.26	-	-	-	
	150	300 kcmil	13	0.512	30	1.181	13	0.512	34	1.339	-	-	-	
M16	25	3	17	0.669	28	1.102	-	-	-	-	-	-	-	
	35	2	17	0.669	28	1.102	-	-	-	-	-	-	-	
	50	0	17	0.669	28	1.102	17	0.669	28	1.102	-	-	-	
	70	00	17	0.669	28	1.102	17	0.669	30	1.181	-	-	-	
	95	000	17	0.669	28	1.102	17	0.669	32	1.26	-	-	-	
	120	250 kcmil	17	0.669	28	1.102	17	0.669	32	1.26	-	-	-	
	150	300 kcmil	17	0.669	30	1.181	17	0.669	34	1.339	-	-	-	

Cable lug
DIN 46234: 1980-03

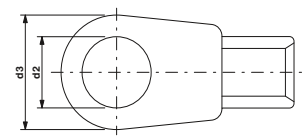

Cable lug
DIN 46235: 1980-07

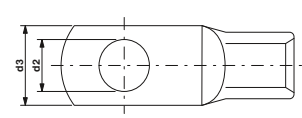

Cable lug
DIN 46237

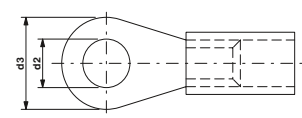

Mechanical strength

IEC 60947-7-1/-2

The mechanical strength of the terminal point is checked in a practical test. For this purpose, the terminal points of the terminal blocks must be repeatedly connected without loss of quality of the terminal connection.

Rigid conductors of the rated cross section are inserted into and removed from two terminal points of the central of five terminal blocks five times. If screw terminal blocks are being used, the terminal points must be tightened to the torque in accordance with the manufacturer's information. Before and after the test, the terminal block must pass a voltage-drop test. The terminal point must withstand repeated reconnection

without sustaining noticeable damage.

The voltage drop before and after the test must not exceed 3.2 mV nor must it exceed 1.5 times the value measured before the test. Terminal blocks from Phoenix Contact are suitable for repeated connection without any recognizable loss of quality. The extent of possible connections and disconnections can reach up to 5000 cycles, depending on the connection technology.

Bending test – flexion test

IEC 60947-7-1/-2

Correctly wired terminal blocks must offer a high degree of mechanical safety. This includes the reliable clamping of the conductor. Therefore, tests are performed with rigid and flexible wires with the minimum cross section, with the rated cross section, and with the maximum cross section. A vertically fixed terminal block is connected to a conductor. A test weight corresponding to the cross section is attached at the end of the conductor. The conductor is fed through a central 37.5 mm aperture in a rotating disk and turned about its own axis 135 times. This procedure must not damage the clamping area on the conductor. Afterwards, the contact must pass a conductor pull-out test. Terminal blocks from Phoenix Contact are designed to ensure that the conductor makes contact in the clamping area without causing damage. The conductor and contact point remain

Cross section		Distance H	Load
[mm ²]	AWG	[mm]	[kg]
0.2	24	260	0.2
to	to	to	to
4	12	280	0.9
to	to	to	to
240	500 kcmil	464	20.0

unaffected and retain the same properties even after repeated clamping.

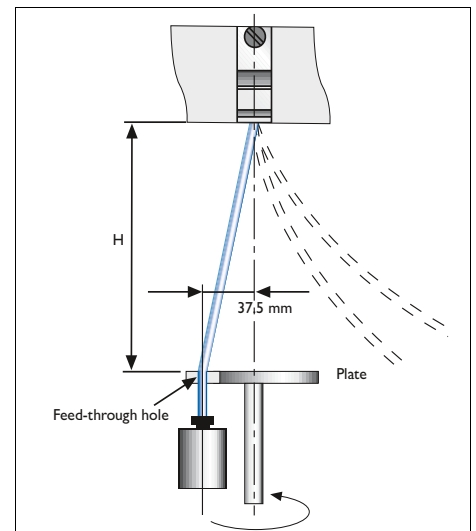

Test equipment in accordance with the standard

Conductor pull-out test

IEC 60947-7-1/-2

Tensile forces can affect the terminal point during wiring or operation. Correctly wired terminal blocks must therefore offer a high degree of mechanical safety. To test the tensile load capacity of a terminal point, the terminal point must withstand a given tensile force based on the cross section for over 60 seconds. This test is performed after the flexion test. Performing these two tests directly one after the other intensifies the requirements. The tensile force exerts stress on the conductor at the terminal point. The conductor must be held within the terminal point without sustaining damage. The test results for terminal blocks from Phoenix Contact are up to 150% above the required minimum values.

Conductor pull-out forces in accordance with IEC 60999 / EN 60999 / VDE 0609-1, Table III (up to 300 mm²)

Conductor cross section		Tensile force
[mm ²]	AWG	[N]
0.2	24	10
0.34	22	15
0.5	20	20
0.75	18	30
1.0	–	35
1.5	16	40
2.5	14	50
4.0	12	60
6.0	10	80
10	8	90
16	6	100
25	4	135
–	3	156
35	2	190
–	1	236
50	0	236
70	00	285
95	000	351
–	0000	427
120	250 kcmil	427
150	300 kcmil	427
185	350 kcmil	503
–	400 kcmil	503
240	500 kcmil	578
300	600 kcmil	578

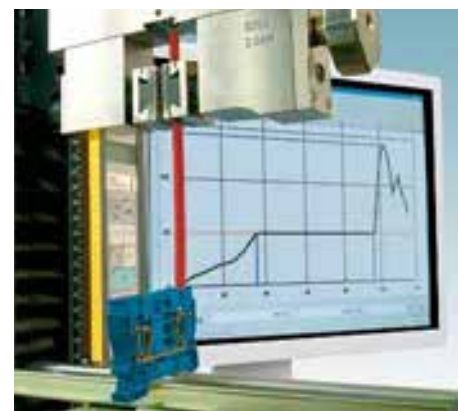

Absorption of tensile force on a 10 mm² spring-cage terminal block

Tight fit of the terminal block

IEC 60947-7-1/-2

Besides the reliable contacting of the conductor, the terminal block itself must be able to withstand forces without coming loose from its support. Furthermore, no unacceptable damage may occur. To test whether the fit is tight, a terminal block is mounted on a standard DIN rail in accordance with the manufacturer's information. Then steel rods with a length of 150 mm are clamped into the terminal points. Tensile and pressure forces based on the cross section are exerted on the terminal points and the latching of the terminal block with a lever distance of 100 mm. The terminal block must not come loose or break off the rail. The structural design of the terminal blocks from Phoenix Contact ensures a reliable tight fit on different DIN rail systems.

Cross section	Cross section	Force	Diameter of the steel bar
[mm ²]	AWG	[N]	[mm]
0.75	18	1	1.0
1		1	1.0
1.5	16	1	1.0
2.5	14	1	1.0
4	12	1	1.0
6	10	5	2.8
10	8	5	2.8
35	2	10	5.7
50	0	10	5.7
240	500 kcmil	20	20.5

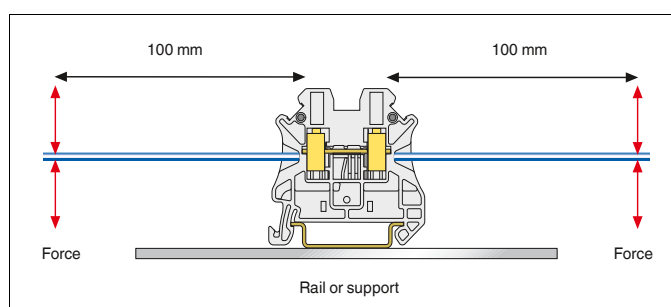

DIN rails

DIN rails/protective conductor busbars

Extract from IEC 60947-7-2 / EN 60947-7-2 / DIN EN 60947-7-2 / VDE 0611-3

Phoenix Contact type	Rail profile	Material	Short-circuit current rating ≅ E CU conductor [mm ²]*	Short-time withstand current 1 s [kA]	Maximum permissible thermal nominal current for PEN function [A]
NS 15 UNPERF 2000MM	DIN rail, in acc. with EN 60715 – 15 x 5.5	Steel	10	1.2	**
NS 15 PERF 2000MM	DIN rail, in acc. with EN 60715 – 15 x 5.5	Steel	10	1.2	**
NS 15-AL PERF 2000MM	DIN rail, dimensions in acc. with EN 60715 – 15 x 5.5	Aluminum	16	1.92	76
NS 32 UNPERF 2000MM	G-profile rail, in acc. with EN 60715 – G 32	Steel	35	4.2	**
NS 32 PERF 2000MM	G-profile rail, in acc. with EN 60715 – G 32	Steel	35	4.2	**
NS 32-CU/35 QMM UNPERF 2000MM	G-profile rail, dimensions in acc. with EN 60715 – G 32	Copper	120	14.4	269
NS 32-CU/120 QMM UNPERF 2000MM	G-profile rail, similar to EN 60715 – G 32	Copper	150	18.0	309
NS 35/7,5 UNPERF 2000MM	DIN rail, in acc. with EN 60715 – 35 x 7.5	Steel	16	1.92	**
NS 35/7,5 PERF 2000MM	DIN rail, in acc. with EN 60715 – 35 x 7.5	Steel	16	1.92	**
NS 35/7,5 ZN UNPERF 2000MM	DIN rail, similar to EN 60715 – 35 x 7.5	Steel	16	1.92	**
NS 35/7,5 ZN PERF 2000MM	DIN rail, similar to EN 60715 – 35 x 7.5	Steel	16	1.92	**
NS 35/7,5 V2A UNPERF 2000MM	DIN rail, similar to EN 60715 – 35 x 7.5	Steel	16	1.92	**
NS 35/7,5-CU UNPERF 2000MM	DIN rail, similar to EN 60715 – 35 x 7.5	Copper	50	6.0	150
NS 35/7,5-AL UNPERF 2000MM	DIN rail, similar to EN 60715 – 35 x 7.5	Aluminum	35	4.2	125
NS 35/15-2,3 UNPERF 2000MM	DIN rail, in acc. with EN 60715 – 35 x 15	Steel	50	6.0	**
NS 35/15 UNPERF 2000MM	DIN rail, similar to EN 60715 – 35 x 15	Steel	25	3.0	**
NS 35/15 PERF 2000MM	DIN rail, similar to EN 60715 – 35 x 15	Steel	25	3.0	**
NS 35/15 ZN UNPERF 2000MM	DIN rail, similar to EN 60715 – 35 x 15	Steel	25	3.0	**
NS 35/15 ZN PERF 2000MM	DIN rail, similar to EN 60715 – 35 x 15	Steel	25	3.0	**
NS 35/15-CU UNPERF 2000MM	DIN rail, similar to EN 60715 – 35 x 15	Copper	95	11.4	232
NS 35/15-AL UNPERF 2000MM	DIN rail, similar to EN 60715 – 35 x 15	Aluminum	70	8.4	192

* Cross sections calculated in acc. with IEC 60439-1 / EN 60439-1 / DIN EN 60439-1 / VDE 0660-500.

** Protective conductor busbars made of steel must not be used for PEN function.

Air clearances and creepage distances

IEC 60947-7-1 / UL 1059

Carrying out a dimensional check of air clearances and creepage distances verifies that electrical insulation properties are adequate with respect to the following:

– Application

– Expected contamination

– Ambient conditions

The minimum distances are defined in IEC 60947-1 and UL 1059.

The distance is verified by measuring between two adjacent terminal blocks and the support, taking into account the shortest distances.

For the clearance, this means:

The clearance is the shortest distance in the air between two conductive parts. The deciding factors for rating the minimum clearance values are the rated surge voltage and the overvoltage category of the terminal block.

For the creepage distances, this means:

The creepage distance is the shortest distance along the insulating body between

two conductive parts. The deciding factors for determining the minimum creepage distance are the rated voltage, the pollution degree, and the insulation material group of the terminal block.

The minimum values can be taken from the tables of the relevant standards.

IEC 60947-7-1

Phoenix Contact terminal blocks are designed with overvoltage category III and pollution degree 3 with the required distances.

UL 1059

Phoenix Contact terminal blocks are generally designed for a nominal voltage of 600 V in Use Group C.

Detailed information can be found in the data sheets or the catalog documentation.

UL Use Group	Definition	Maximum voltage [V]
A	Operating elements, consoles, and similar devices	150 300 600
B	Conventional devices, including office and electronic data processing equipment, and similar devices	150 300 600
C	Industrial applications, without restrictions	150 300 600
D	Industrial applications, equipment with limited rating	300 600

Insulation coordination for electrical equipment in low-voltage systems

Rating of air clearances and creepage distances in accordance with DIN EN 60664-1 / VDE 0110-1.

This part of the standard is based on IEC 60664. It contains the specifications for insulation coordination for equipment in low-voltage systems. This part is applicable for equipment for use up to an altitude of up to 2000 m above sea level. This basic safety standard is primarily aimed at technical committees. If suitable product directives are not available for a piece of equipment, the standard can be applied at the responsibility of the user. International and European product standards are cited in this catalog. These standards contain specifications for insulation coordination in accordance with DIN EN 60664 / VDE 0110-1.

Insulation coordination

Insulation coordination includes the selection of electrical insulation properties for equipment depending on the intended application and ambient conditions. Separate requirements must be applied for air clearances and creepage distances and for fixed insulation. The surge voltages to be expected, the characteristics of surge protective devices, and the pollution levels at the intended site must be considered when dimensioning clearances. Clearances are to be dimensioned in accordance with the external or internal surge voltages to be expected. Different overvoltages, grouped into categories, with a numerical value that determines an impulse withstand voltage, determine the required clearance directly. These overvoltage categories (I to IV) are used for equipment that is directly supplied by low-voltage grids. They are primarily based on a statistical study. Definitions of the individual categories are listed below as an extract of the DIN EN 60664 / VDE 0110-1 standards.

The clearances can be calculated in accordance with Table 2, Minimum clearances, depending on the homogeneity level of the field between the electrodes (case A – non-homogeneous field, case B – homogeneous field).

Clearances in accordance with case A are capable of withstanding the assigned impulse voltages under all conditions. Equipment rated in accordance with case a can therefore be used without further testing. Clearance values in accordance with case B are based on ideal conditions. Clearance values falling between case A and case B must be verified via an impulse voltage test.

The voltages present, the properties of the insulation materials, the pollution levels to be expected, and safety measures against pollution are considered when dimensioning creepage distances.

The effect of pollution is considered when determining the air clearances and creepage distances in accordance with three degrees of severity (pollution degree 1 to 3).

The creepage distances are based on the rated voltage, which is derived from the working voltage or nominal mains voltage. The minimum creepage distances are assigned to the rated voltages in accordance with the pollution degree in Table 4.

If the respective product descriptions do not contain any additional specifications, the products listed in this catalog are rated for overvoltage category III and pollution degree 3 in accordance with this provision (DIN EN 60664-1 / VDE 0110-1).

Overvoltage categories I to IV

– Equipment in **overvoltage category IV** can be used at the terminal point of the installation.

Note: Examples of this kind of equipment include electricity meters and primary overcurrent protection devices.

– Equipment in **overvoltage category III** can be used in fixed installations and in cases where there are special requirements on the reliability and availability of the equipment.

Note: Examples of this kind of equipment include switches in fixed installations and equipment for industrial use that is permanently connected to the fixed installation.

– Equipment in **overvoltage category II** is energy-consuming equipment fed by the fixed installation.

Note: Examples of this kind of equipment include household appliances, portable tools, other domestic appliances, and similar devices.

– Equipment in **overvoltage category I** can be connected to circuits in which measures have been taken to limit the transient overvoltages to a suitably low value.

Pollution degrees 1 to 4

The following four pollution degrees have been defined for the micro-environment in order to determine air clearances and creepage distances:

– Pollution degree 1

No pollution or only dry, non-conductive pollution occurs. The pollution does not have an effect.

– Pollution degree 2

Only non-conductive pollution occurs. However, temporary conductivity due to condensation is to be expected.

– Pollution degree 3

Conductive pollution occurs or dry, non-conductive pollution which becomes conductive, since condensation is to be expected.

– Pollution degree 4

Permanent conductivity occurs, caused by conductive dust, rain or moisture.

Insulation material

DIN EN 60664 / VDE 0110-1 classifies insulation materials into four groups depending on their CTI values obtained using solution A in accordance with IEC 60112.

Insulation material group I: $600 \leq \text{CTI}$
 Insulation material group II: $400 \leq \text{CTI} \leq 600$
 Insulation material group III a: $175 \leq \text{CTI} < 400$
 Insulation material group III b: $100 \leq \text{CTI} < 175$.

The comparative tracking index of the creepage distance formation must have been determined based on suitable samples using test solution A in accordance with DIN IEC 60112.

The proof tracking index of the creepage distance formation (PTI) is used as proof of the creepage current properties of insulation materials.

Dimensioning of clearances

Schematic for determining clearances

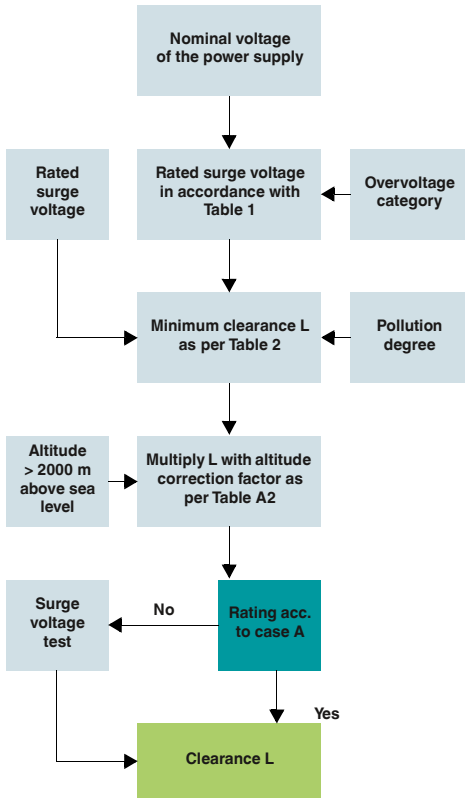

Rated surge voltages for equipment that is directly supplied by the low-voltage network (extract from Table 1)

Nominal voltage of the power supply system ¹⁾ (mains) as per IEC 60038 ³⁾		Conductor-neutral conductor voltage derived from the total nominal AC voltage or nominal DC voltage	Rated surge voltage ²⁾ [V]			
Three-phase [V]	Single-phase [V]		Overvoltage category ⁴⁾			
			I	II	III	IV
		50	330	500	800	1500
		100	500	800	1500	2500
		150	800	1500	2500	4000
230/400	277/480	300	1500	2500	4000	6000
		600	2500	4000	6000	8000
		1000	4000	6000	8000	12000

¹⁾ Refer to Annex B for application in existing deviating low-voltage networks and their nominal voltages.

²⁾ Equipment with this rated surge voltage may be used in systems in accordance with IEC 60364-4-443.

³⁾ The slash, i.e., /, indicates a three-phase four-conductor system. The lower value is the conductor-to-neutral-conductor voltage, whereas the higher value is the conductor-to-conductor voltage. When only one value is specified, it refers to a three-phase three-conductor system, and indicates the conductor-to-conductor voltage.

⁴⁾ Refer to 2.2.2.1.1 for an explanation of overvoltage categories.

Minimum clearances for transient overvoltages (extract from Table 2)

Required impulse withstand voltage ¹⁾ ⁵⁾ [kV]	Condition A Non-homogeneous field (refer to 3.15)			Condition B Homogeneous field (refer to 3.14)		
	Pollution degree ⁶⁾			Pollution degree ⁶⁾		
	1 [mm]	2 [mm]	3 [mm]	1 [mm]	2 [mm]	3 [mm]
0.33 ²⁾	0.01	0.2 ³⁾ ⁴⁾	0.8 ⁴⁾	0.01	0.2 ³⁾ ⁴⁾	0.8 ⁴⁾
0.40	0.02			0.02		
0.5 ²⁾	0.04			0.04		
0.60	0.06			0.06		
0.80 ²⁾	0.10			0.10		
1.0	0.15			0.15		
1.2	0.25	0.25		0.2		
1.5 ²⁾	0.5	0.5		0.3	0.3	
2.0	1.0	1.0	1.0	0.45	0.45	
2.5 ²⁾	1.5	1.5	1.5	0.6	0.6	
3.0	2.0	2.0	2.0	0.8	0.8	
4.0 ²⁾	3	3	3	1.2	1.2	1.2
5.0	4	4	4	1.5	1.5	1.5
6.0 ²⁾	5.5	5.5	5.5	2	2	2
8.0 ²⁾	8	8	8	3	3	3
10	11	11	11	3.5	3.5	3.5
12 ²⁾	14	14	14	4.5	4.5	4.5
15	18	18	18	5.5	5.5	5.5
20	25	25	25	8	8	8
25	33	33	33	10	10	10
30	40	40	40	12.5	12.5	12.5
40	60	60	60	17	17	17
50	75	75	75	22	22	22
60	90	90	90	27	27	27
80	130	130	130	35	35	35
100	170	170	170	45	45	45

¹⁾ This voltage is:

- For function insulation: the highest surge voltage expected for the clearance
- For basic insulation, if influenced directly or considerably by transient overvoltages from the low-voltage network: the rated surge voltage of the equipment
- For a different basic insulation: the highest surge voltage possible in the circuit.

²⁾ Preferred values

³⁾ For PCBs, the values of pollution degree 1 are applicable, except that no deviation below the value of 0.04 mm is permitted, as specified in Table 4.

⁴⁾ Minimum clearances for pollution degrees 2 and 3 are based on the corresponding creepage distances. This resistance is reduced due to the effects of humidity.

⁵⁾ Values can be interpolated for parts or circuits within equipment that are subjected to surge voltages.

⁶⁾ The distances for pollution degree 4 are equal to those for pollution degree 3, except that the minimum clearance is 1.6 mm.

Altitude correction factors (extract from Table A.2)

Altitude [m]	Normal air pressure [kPa]	Multiplication factor for distances
2000	80.0	1.00
3000	70.0	1.14
4000	62.0	1.29
5000	54.0	1.48
6000	47.0	1.70
7000	41.0	1.95
8000	35.5	2.25
9000	30.5	2.62
10000	26.5	3.02
15000	12.0	6.67
20000	5.5	14.50

Dimensioning of creepage distances

Schematic for determining creepage distances

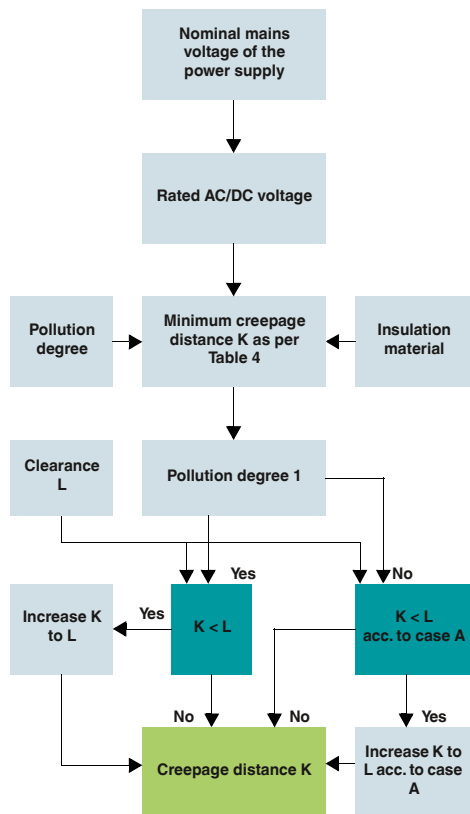

Nominal voltage of the power supply system (mains) *)	Voltages for Table 4	
	For conductor-to-conductor insulation 1)	For conductor-to-ground insulation 1)
	All systems	Three-conductor systems center point grounded
[V]	[V]	[V]
12.5	12.5	-
24	25	-
25	32	-
30	32	-
42	50	-
48	50	-
50 **)	50	-
60	63	-
30-60	63	32
100 **)	100	-
110	125	-
120	125	-
150 **)	160	-
220	250	-
110-220	250	125
220-240	250	125
300 **)	320	-
220-440	500	250
600 **)	630	-
480-960	1000	500
1000 **)	1000	-

1) Conductor-to-ground insulation levels for non-grounded systems or those grounded through impedance correspond to conductor-to-conductor insulation levels as the operating voltage of every conductor to ground can, in practice, reach the conductor-to-conductor voltage. This is based on the fact that the actual voltage to ground is determined by the insulation resistance and capacitive reactance of each conductor to ground. Therefore, a low (but permissible) insulation resistance of a conductor can practically ground this and raise the two others to conductor-to-conductor voltage to ground.

*) Refer to 2.2.1 for correlation with the rated voltage.

**) These values correspond to the values in Table 1.

Three-phase four or three-conductor AC voltage systems (extract from Table 3 b)

Nominal voltage of the power supply system (mains) *)	Voltages for Table 4		
	For conductor-to-conductor insulation	Insulation for conductor to ground	
		Three-phase four-conductor systems with grounded neutral conductor 2)	Three-phase three-conductor systems non-grounded 1) or conductor grounded
[V]	[V]	[V]	[V]
60	63	32	63
110/120/127	125	80	125
150 **)	160	-	160
208	200	125	200
220/230/240	250	160	250
300 **)	320	-	320
380/400/415	400	250	400
440	500	250	400
480/500	500	320	500
575	630	400	630
600 **)	630	-	630
660/690	630	400	630
720/830	800	500	800
960	1000	630	1000
1000 **)	1000	-	1000

1) Conductor-to-ground insulation levels for non-grounded systems or those grounded through impedance correspond to conductor-to-conductor insulation levels as the operating voltage of every conductor to ground can, in practice, reach the conductor-to-conductor voltage. This is based on the fact that the actual voltage to ground is determined by the insulation resistance and capacitive reactance of each conductor to ground. Therefore, a low (but permissible) insulation resistance of a conductor can practically ground this and raise the two others to conductor-to-conductor voltage to ground.

2) For equipment designed for use in three-phase four-conductor and three-phase three-conductor systems, grounded as well as non-grounded, only the values for three-conductor systems may be used.

*) Refer to 2.2.1 for correlation with the rated voltage.

**) These values correspond to the values in Table 1.

Creepage distances to prevent failures occurring due to creepage (extract from Table 4)

Voltage 1) r.m.s. value [V]	Minimum creepage distances											
	Printed circuits			Pollution degree								
	Pollution degree			1			2			3		
	All insulation material groups	All insulation material groups except III b	All insulation material groups	Insulation material group			Insulation material group					
[mm]	[mm]	[mm]	I	II	III	I	II	III 2)	I	II	III 2)	
10	0.025	0.04	0.08	0.4	0.4	0.4	1.00	1.00	1.00			
12.5	0.025	0.04	0.09	0.42	0.42	0.42	1.05	1.05	1.05			
16	0.025	0.04	0.10	0.45	0.45	0.45	1.10	1.10	1.10			
20	0.025	0.04	0.110	0.48	0.48	0.48	1.20	1.20	1.20			
25	0.025	0.04	0.125	0.5	0.5	0.5	1.25	1.25	1.25			
32	0.025	0.04	0.140	0.53	0.53	0.53	1.30	1.30	1.30			
40	0.025	0.04	0.16	0.56	0.8	1.1	1.4	1.6	1.8			
50	0.025	0.04	0.18	0.6	0.85	1.2	1.5	1.7	1.9			
63	0.040	0.63	0.20	0.63	0.9	1.25	1.6	1.8	2.0			
80	0.063	0.10	0.22	0.67	0.95	1.3	1.7	1.9	2.1			
100	0.10	0.16	0.25	0.71	1.0	1.4	1.8	2.0	2.2			
125	0.16	0.25	0.28	0.75	1.05	1.5	1.9	2.1	2.4			
160	0.25	0.4	0.32	0.8	1.1	1.6	2.0	2.2	2.5			
200	0.40	0.63	0.42	1.0	1.4	2.0	2.5	2.8	3.2			
250	0.56	1.0	0.56	1.25	1.8	2.5	3.2	3.6	4.0			
320	0.75	1.6	0.75	1.6	2.2	3.2	4.0	4.5	5.0			
400	1.0	2.0	1.00	2.0	2.8	4.0	5.0	5.6	6.3			
500	1.3	2.5	1.30	2.5	3.6	5.0	6.3	7.1	8.0			
630	1.8	3.2	1.80	3.2	4.5	6.3	8.0	9	10.0			
800	2.4	4.0	2.40	4.0	5.6	8.0	10.0	11	12.5			
1000	3.2	5.0	3.20	5.0	7.1	10	12.5	14	16.0			
1250			4.20	6.3	9	12.5	16	18	20			
1600			5.60	8	11	16	20	22	25			
2000			7.50	10	14	20	25	28	32			
2500			10	12.5	18	25	32	36	40			
3200			12.5	16	22	32	40	45	50			
4000			16	20	28	40	50	56	63			
5000			20	25	36	50	63	71	80			
6300			25	32	45	63	80	90	100			
8000			32	40	56	80	100	110	125			
10000			40	50	71	100	125	140	160			

1) This voltage is:
a) For function insulation: the working voltage.
b) For basic and additional insulation of a circuit supplied directly by the low-voltage network: either the voltage selected from Table 3 a or 3 b on the basis of the rated voltage of the equipment or the rated insulation voltage.
c) For basic and additional insulation of systems, equipment, and internal circuits which are not supplied directly from the mains: the highest r.m.s. value of the voltage that, within the bounds of the rated data, can occur in the system, the equipment or the internal circuit, when supplied with rated voltage and in the case of the most unfavorable combination of operating conditions.

2) With pollution degree 3, insulation material group III b is not recommended for use if voltages are greater than 630 V.

Dielectric test

IEC 60947-7-1/-2/UL 1059

This electrical test is used to demonstrate adequate creepage distances.

To test that the distances between the potentials of two neighboring terminal blocks and between a terminal block and the DIN rail are sufficient, an appropriate test voltage is applied.

Rated insulation voltage (U_i)

The r.m.s. or DC voltage value that is permanently acceptable as a maximum when correctly used.

The test voltage must be applied over 60 seconds. The assignment illustrated in the table is to be used as the basis for this.

Rated insulation voltage U_i [V]	Test voltage (effective) [V]
$U_i \leq 60$	1000
$60 < U_i \leq 300$	1500
$300 < U_i \leq 690$	1890
$690 < U_i \leq 800$	2000
$800 < U_i \leq 1000$	2200
$1000 < U_i \leq 1500$	

IEC 60947-7-1/-2

No sparkover or disruptive discharge may occur during testing. Creepage currents must stay below 100 mA.

UL 1059

Up to 600 V:

Test voltage = $1000 \text{ V} + 2 \times \text{rated insulation voltage } U_i$.

601 V ... 1500 V:

Test voltage = $2000 \text{ V} + 2.25 \times \text{rated insulation voltage } U_i$.

Surge voltage test

IEC 60947-7-1/-2

Proof of sufficiently large clearances between two neighboring potentials is provided by means of the surge voltage test.

The test with the surge voltage is carried out five times at intervals of at least 1 s. The test is carried out for each polarity depending on the rated insulation voltage.

The distance between neighboring terminal blocks or between the terminal block and rail is examined.

There must be no unintentional sparkovers during the test.

Rated surge voltages for Phoenix Contact terminal blocks are between 6 and 8 kV. Operationally safe use of the documented operating voltages of the terminal blocks is thereby effectively confirmed.

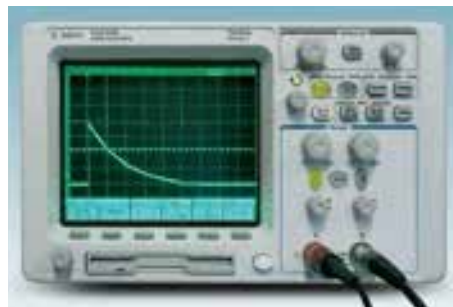

The oscilloscope shows the time curve for a surge voltage pulse

Voltage-drop test

IEC 60947-7-1/-2

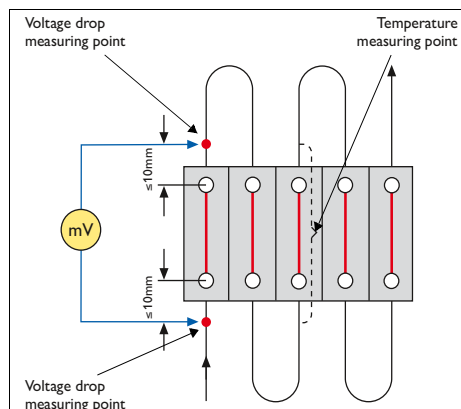

Voltage pick-off on a screw terminal block

In every terminal point of a terminal block, one or more conductors are connected – depending on the connection technology. Current transfer is strongly affected by the electrical resistance between the conductor and the current bar. High-quality contacts create a gas-tight connection. This is the only way to ensure a permanently reliable connection. This electrical test therefore determines the voltage drop on a terminal block (two terminal points). Conclusions can therefore be made regarding the contact resistance and the contact quality.

The terminal blocks are wired with the rated cross section. For measuring purposes, a direct test current corresponding to 0.1 times the current carrying capacity of the rated cross section is applied to the terminal blocks. The voltage drop is picked off at a distance of $\leq 10\text{ mm}$ from the middle of the terminal point (see diagram).

At a room temperature of $\sim 20^\circ\text{C}$, the voltage drop must not exceed 3.2 mV per terminal block before and after the test, nor must it exceed 1.5 times the value measured at the start of the test.

Terminal blocks from Phoenix Contact are up to 60% below the limit values required by standards.

Rated cross section [mm ²]	Current carrying capacity [A]	Rated cross section AWG	Current carrying capacity [A]
0.2	4	24	4
0.5	6	20	8
0.75	9	18	10
1	13.5	-	-
1.5	17.5	16	16
2.5	24	14	22
4	32	12	29
6	41	10	38
10	57	8	50
16	76	6	67
35	125	2	121
50	150	0	162
95	232	0000	217
150	309	00000	309
240	415	500 MCM	415

Temperature-rise test

IEC 60947-7-1/-2 / UL 1059 / IEC 61984

The rise in temperature of a terminal block must be kept to an absolute minimum.

The contact resistance must therefore be as low as possible. This test is used to document the rise in temperature (at room temperature) that occurs during exposure to a test current.

IEC 60947-7-1/-2

Five terminal blocks are horizontally mounted on a rail and connected in series using 1 or 2 m conductor loops with the rated cross section. The terminal blocks and protective conductor terminal blocks (from a rated cross section of 10 mm²) in combination with or without an isolating support are exposed to a test current that is as high as the current carrying capacity of the rated cross section. A reduction of the test current (I_{TH}) is permitted for multi-level terminal blocks and test disconnect terminal blocks. The rise in temperature of the middle terminal block is documented (see figure: Voltage-drop test, page 621).

Furthermore, protective conductor terminal blocks (from a rated cross section of 10 mm²) are subjected to a temperature-

rise test in combination with an electrically conductive support (not steel).

Assuming a room temperature of ~20°C, a maximum rise in temperature of 45 K is permitted in the terminal block. Additionally, a voltage-drop test must be performed on all five terminals prior to and following the temperature-rise test.

UL 1059

The process basically corresponds to the IEC test, only the conductor lengths differ. Three terminal blocks are horizontally mounted adjacent to one another. The measurement is taken at an ambient temperature of 25°C, whereby a maximum rise in temperature of 30 K (measured as close as possible to the terminal point) is permitted. Due to the high-quality contact materials used in terminal blocks from Phoenix Contact, all connection technologies offer lower temperature-rise values than required by the specified standards.

IEC 61984

The contacts of the connectors with various numbers of positions (e.g. 5-, 10-, and 15-pos.) are connected with 0.5 m or

1 m long conductor loops of the maximum permitted connection cross section in accordance with IEC 60512-5-1. After applying the test current in accordance with the derating curve (base curve) and taking the ambient temperature, reaching the temperature balance, and subsequent one-hour current load into consideration, the temperature rise on the contacts may not exceed the upper limiting temperature.

Base and derating curve, test setup, ambient temperature

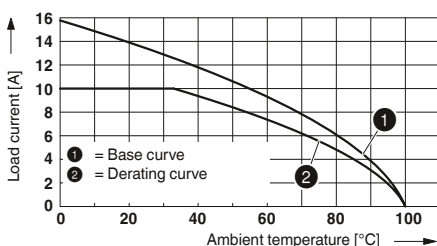

To determine the current carrying capacity of plug-in terminal blocks, arrangements with a variety of positions are selected, which are electrically connected in series using conductors with the same cross section. For practical determination of the derating curves, the current carrying capacity of the plug-in terminal blocks is determined in accordance with DIN EN 61984 and DIN EN 60512-5-1. Here, after applying various currents (e.g., 10 A, 17.5 A, 24 A,

and 32 A) and setting the temperature balance, the maximum temperature increase that occurs on the test objects is measured.

When the upper limiting temperature of the insulation material and of the contact system – here, always assumed to be 100°C – is taken into account, these values yield a derating curve dependent on the ambient temperature: the “base curve”.

An adjusted capacity curve – the “derating curve” – is generated in accordance with DIN EN 60512-5-2. In accordance with this standard, the permissible load current is 0.8 times the respective base current.

The derating factor “...takes into account manufacturing tolerances in the connector contact system, as well as uncertainties in the temperature measurement and the measuring arrangement”. For the majority of items in this catalog, derating curves are

provided for 2, 5, 10, and 15-pos. arrangements.

SCCR – Short-circuit current rating

SCCR – Short-circuit current rating

As of April 2006, the NEC (National Electrical Code) requires the short-circuit current rating of industrial controllers to be specified. These SCCR values (short-circuit current rating) can be calculated with the help of UL 508A. In the USA, the calculation must be summarized on the rating plate of all industrial switchgear, for all main circuits as well as for the feed-in of the control voltage supply. Standard values for non-specified components are listed in UL 508A – Table SB 4.1. A value of 10 kA is assumed

for terminal blocks. Phoenix Contact produces a wide range of products with considerably higher SCCR values than this. The terminal blocks in the CLIPLINE complete system are all documented as having SCCR values of 100 kA.

The SCCR values for terminal blocks from Phoenix Contact are listed in detail in UL file number E60425. The UL file is stored in and can be retrieved from the UL database via the following link:

<http://database.ul.com/cgi-bin/XYV/template/LISEXT/1FRAME/index.html>

Current carrying capacity

The standard IEC 60947-7-1 / EN 60947-7-1 / DIN VDE 0611-1 specifies the test currents for the individual conductor cross sections listed in the adjacent table. The corresponding currents are listed with the connection data for the individual terminal blocks. The type testing of terminal blocks is based on this data.

The current carrying capacity of connectors in accordance with DIN EN 61984 is dependent on the number of positions and is to be found in the product-specific documentation.

Test currents in accordance with IEC 60947-7-1/EN 60947-7-1, Table 5

Rated cross section	[mm ²]	0.2	0.5	0.75	1.0	1.5	2.5	4	6	10	16
Test current	[A]	4	6	9	13.5	17.5	24	32	41	57	76

Rated cross section	[mm ²]	25	35	50	70	95	120	150	185	240	300
Test current	[A]	101	125	150	192	232	269	309	353	415	520

Short-time withstand current

IEC 60947-7-1/-2

Terminal blocks must, in practice, also be capable of resisting short-circuit currents until the relevant safety equipment cuts off the current without sustaining any damage. This can take up to several tenths of a second.

For testing purposes, a terminal block is mounted on the support and wired to a conductor with the rated cross section.

Protective conductor terminal blocks are subjected in three stages of one second each to a current density of 120 A/mm² of the rated cross section.

The requirements are met if, after the test, the individual parts are undamaged and their further use is guaranteed.

Before and after the test, the terminal block must pass the voltage drop test. The

voltage drop before and after the test must not exceed 3.2 mV per terminal block nor must it exceed 1.5 times the value measured before the test.

In the case of a 240 mm² high-current terminal block from Phoenix Contact, a test current of 28,800 A is passed through the terminal block for one second without loss of quality.



Maximum contact reliability, even under extreme overload. A plug-in spring-cage terminal block is shown here.

Technical notes – fuse terminal blocks

The standard DIN EN 60947-7-3 for fuse terminal blocks does not just contain the requirements for terminal blocks for mounting on DIN rails, it also takes the specifications for cartridge fuse-links in accordance with IEC 60127-1 and IEC 60127-2 into consideration. A link between the two standards is established by adding (adapting) the basic specifications for cartridge fuse-links (rated current, rated voltage, maximum voltage drop, and maximum power dissipation of cartridge fuse-links with the dimensions 5 x 20 mm or 6.3 x 32 mm with their various tripping characteristics) to the requirements of IEC 60947-7-1 for terminal blocks. With this, it is possible to assess the quality of the “fuse terminal block” products.

An important fact when using such cartridge fuse-links for fuse terminal blocks is that fuses heat up under rated load far less than during overload. The rated load is determined from the rated current and the maximum voltage drop. In the event of overload, however, a considerably higher power loss results at the same maximum power dissipation in accordance with IEC 60127-2.

In industrial applications, individual fuse terminal blocks are used in an arrangement with terminal blocks, or many of these alone form an arrangement. This means that the same current and fuse-link leads to different heat dissipation values. Furthermore, it should be taken into consideration that regardless of the general overall fusing (for overload

and short-circuit protection), some fuse terminal blocks are used exclusively as short-circuit protection in accordance with IEC 60364-4-43, for example in control circuits where overloads do not occur (e.g. coils in safety control circuits, LED displays and similar devices).

Consequently, four different application quadrants exist, which are listed in the table.

(Reference: Low-Voltage Switchgear Part 7-3 Auxiliary Equipment - Safety Requirements for Fuse Terminal Blocks (IEC 60947-7-3: 2009); German version EN 60947-7-3: 2009 translated to English)

Fuse terminal blocks in compound arrangement

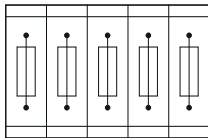

Block consisting of five fuse terminal blocks

Separate arrangement with fuse terminal block

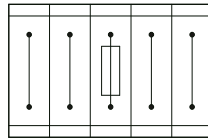

Block consisting of one fuse terminal block and four feed-through terminal blocks

Attention:

The cartridge fuse holders should be selected in accordance with the maximum power dissipation (self-heating) of the cartridge fuse-links. The thermal conditions in closed fuse holders should be checked in accordance with the application and installation.

Higher ambient temperatures are an additional strain on fuse-links. Take into account the corresponding shift in the rated current in this kind of application.

Max. power dissipation at 23°C in accordance with DIN EN 60947-7-3: 2009-4

When selecting cartridge fuse-links, please ensure that the maximum power dissipation specified below is not exceeded. Details can be obtained from the fuse manufacturers.

5 x 20 mm cartridge fuse-links in accordance with DIN EN 60947-7-3:2009-4

Technical data on the power dissipation of further fuse terminal block types can be found at phoenixcontact.net/products
 *) The rated operating voltage is determined by the selected cartridge fuse-link.

Terminal block or connector	U ¹⁾ [V]	Overload protection		Short-circuit protection only		I _{max.} [A]
		Individual	Combination	Individual	Combination	
P-FU 5X20-5	400	1.6 W	1.6 W	4.0 W	2.5 W	6.3
P-FU 5X20	400	1.6 W	1.6 W	4.0 W	2.5 W	6.3
PT 4-HESI (5X20)	400	1.6 W	1.6 W	4.0 W	2.5 W	6.3
PT 4-PE/L-HESI	500	1.6 W	1.6 W	4.0 W	2.5 W	6.3
PTTB 4-HESI	500	1.6 W	1.6 W	4.0 W	2.5 W	6.3
PT 6-DREHSI (5X20)	1000	4.0 W	2.5 W	2.0 W	1.3 W	10
UT 4-HESI (5X20)	500	1.6 W	1.6 W	4.0 W	2.5 W	10
ST 4-HESI (5X20)	500	1.6 W	1.6 W	4.0 W	2.5 W	6.3
ZFK 6-DREHSI (5X20)	800	4.0 W	2.5 W	4.0 W	4.0 W	6.3
QTC 2,5-HESI (5X20)	500	1.6 W	1.6 W	4.0 W	2.5 W	6.3
UK 10-DREHSI	800	4.0 W	2.5 W	4.0 W	4.0 W	10
USIG with ST-SI	500	2.5 W	2.5 W	4.0 W	4.0 W	6.3
UK-SI	400	1.6 W	1.6 W	4.0 W	2.5 W	6.3
UK 5-HESI	800	2.5 W	2.5 W	4.0 W	2.5 W	6.3
UKK 5-HESI (5X20)	400	2.5 W	1.6 W	4.0 W	2.5 W	6.3
UK 4-TG with ST-SI-UK 4	250	1.6 W	1.6 W	4.0 W	1.6 W	6.3

6.3 x 32 mm cartridge fuse-links in accordance with DIN EN 60947-7-3:2009-4

Technical data on the power dissipation of further fuse terminal block types can be found at phoenixcontact.net/products

P-FU 6,3X32	630	2.5 W	2.5 W	4.0 W	2.5 W	10
PT 6-HESI (6,3X32)	630	2.5 W	2.5 W	4.0 W	2.5 W	10
UT 6-HESI (6,3X32)	630	2.5 W	2.5 W	4.0 W	2.5 W	10
ST 4-HESI (6,3X32)	500	2.5 W	2.5 W	4.0 W	2.5 W	10
ZFK 6-DREHSI (6,3X32)	500	2.5 W	2.5 W	4.0 W	2.5 W	10
UK 10-DREHSI	400	2.5 W	2.5 W	4.0 W	2.5 W	10
USIG with ST1-SI	500	2.5 W	2.5 W	4.0 W	2.5 W	10
UK 6,3-HESI	500	2.5 W	1.6 W	4.0 W	2.5 W	10
UKK 5-HESI (6,3X32)	400	2.5 W	1.6 W	4.0 W	2.5 W	10

Aging test

IEC 60947-7-1/-2

From the point of view of long lifecycles of the terminal blocks, the aging behavior also plays an important role.

In this test, the contact quality is verified by means of simulated aging.

To simulate several years of use, five terminal blocks are mounted horizontally on a rail and connected in series using conductors with the rated cross section. The voltage drop is measured at each terminal block. These terminal blocks are connected by conductors with a minimum length of 300 mm. The minimum temperature in the climate cabinet is set to 20°C and the maximum temperature to 75°C. During the heating phase and the 10-minute pause phase with maximum temperature, the rated current flows. As a result, the maximum permissible operating temperature of the test object (120°C maximum) is reached. This is followed by the cooling phase. The voltage drop is always measured after 24 cycles in the cooled down state (approximately 20°C). The test consists of a total of 192 cycles.

The voltage drop must not exceed 3.2 mV initially. During or after testing, it must not exceed 4.8 mV or 1.5 times the value measured after the 24th cycle.

Terminal blocks from Phoenix Contact are designed for extreme durability even under difficult temperature conditions. Plastic as well as metal parts provide sufficient safety reserves.

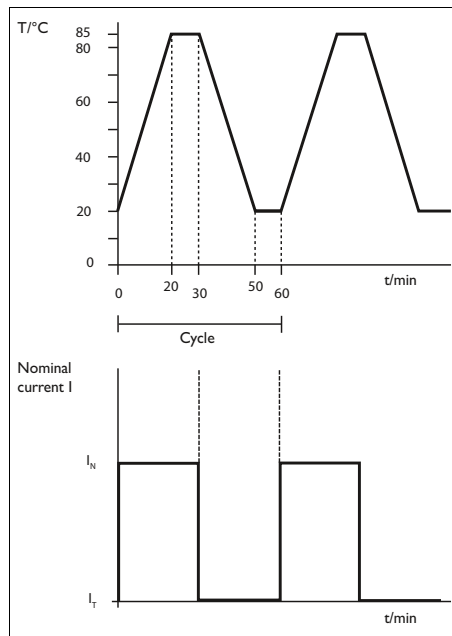

Current and temperature in relation to time

Corrosion test

DIN 50018

The pivotal role of the metal parts of electrical connections becomes particularly apparent in aggressive environments. Corrosion-free contact areas are a prerequisite for low-resistance and therefore high-performance connections. This test method describes a corrosion test in condensation climates with an atmosphere that contains sulfur dioxide. Acidic compounds < Ph 7 form during the test and attack the metal surfaces. Two liters of distilled water and one liter of SO₂ gas are introduced into the test chamber. At a test temperature of 40°C, sulfurous acid forms during the test.

After eight hours of testing, the test objects dry for 16 hours in the ventilated test chamber. At the end of the test, the test objects are visually inspected and the

contact resistance is measured in order to show the influence of this corrosion test on the contact point in more detail. Phoenix Contact terminal blocks create high-quality gas-tight connections. Even aggressive media cannot impact the connection.

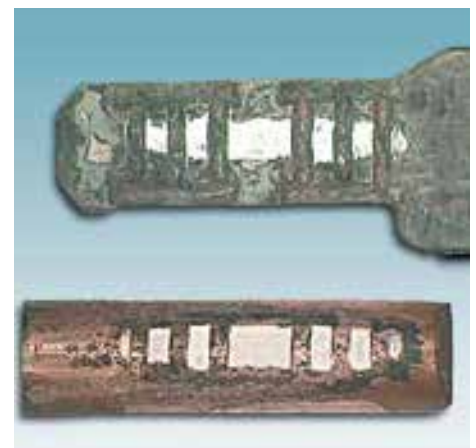

Environmental testing methods

IEC 60068-2-42/43

The mechanical and electrical service life of terminal blocks is directly dependent on the metal parts and insulation materials used. To evaluate the climatic effects on electrical connections, terminal blocks are subjected to various environmental simulation tests. The conductor contact points, the knife disconnect points, and the test contacts are included in these tests. The contact resistance values, the secure fit of the conductor, and the visual assessment of the contact points after each test serve as evaluation criteria.

– 10-day storage in aggressive SO₂ industrial atmospheres at 25°C and 75% humidity

– 4-day storage in aggressive H₂S atmospheres at 25°C and 75% humidity.

After the test has been completed, the contact resistance must not exceed 1.5 times the initial value. The function of the terminal block must be ensured without any limitation. The high standard of quality of Phoenix Contact terminal blocks is achieved by using corrosion-resistant, high-grade copper alloys.

Salt spray

IEC 60068-2-11

Particularly in shipbuilding, technical components have to function continuously in corrosive atmospheres. The salt content of the air combined with the increased humidity places high demands on the metal parts used. The impact of the climate at sea can be simulated on the basis of the above standard.

The resistance of the materials is tested with salt spray in corrosive atmospheres. The test objects are placed in the test chamber and subjected to a fine spray of 5% sodium chloride solution (NaCl; pH value 6.5 - 7.2) at a temperature of 35°C for a period of 96 hours.

At the end of the test, the test objects are visually inspected and an electrical test is performed to show the influence of this corrosion test on the contact point in more detail.

All Phoenix Contact terminal blocks, whatever their connection technology, create gas-tight connections. This means that the contact point is protected against corrosion even under extreme climatic conditions.



Temperature shock test

DIN EN 60352 T4

As mentioned earlier, rapid changes in temperature frequently occur near process-related sources of heat and cold in process engineering. This test verifies that the contact quality of the terminal points remains consistently high even in the case of rapid changes in temperature.

For testing purposes, five terminal blocks are mounted on the support and wired to a conductor with the rated cross section. The structure is subjected to rapid temperature changes using a two-chamber method. The temperatures lie close to the upper and lower limiting temperatures of the terminal block. This is generally a temperature range of -60°C to $+100^{\circ}\text{C}$. The dwell time in each climatic chamber is 45 minutes, whereby the change takes place within a few seconds. This change is performed for 100 cycles.

The requirements are met if, after the test, the individual parts are undamaged and their further use is guaranteed.



After the terminal block has cooled down to room temperature, it must undergo a voltage-drop test. Phoenix Contact terminal blocks exhibit consistently good temperature behavior thanks to high-quality materials.

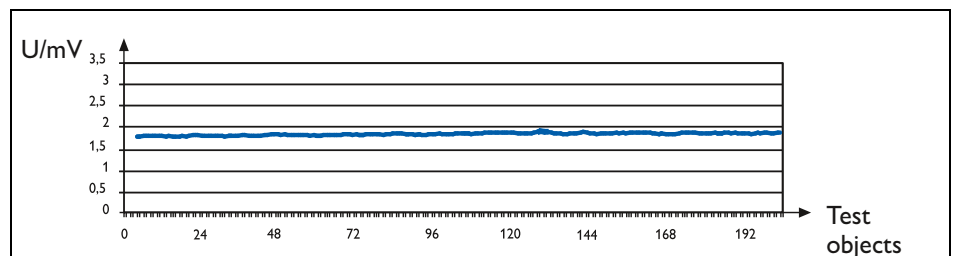

Voltage-drop test on more than 200 test objects after the test

Vibration test

DIN EN 61373 – broadband noise (degree of severity in accordance with DIN EN 50155)

In transportation technology, terminal blocks are exposed to constant vibrations and shocks. These vibrations occur particularly in the vicinity of engines, rotating drives, and axes.

For a practical simulation of the vibration stress, the test objects are subjected to broadband noise-induced vibrations. This means that realistic accelerations are generated at the terminal block and the connected conductor.

During the category 1 B test, the objects are exposed to a frequency range of 5 Hz to 150 Hz. The r.m.s. value of the acceleration is up to 5.72 m/s^2 . The test objects are tested on each of the three axes (x, y, z) for 5 hours.

In addition to the vibrations, the electrical contact is monitored during the test to make it more difficult.



No damage may occur to the terminal blocks that would impair their further use. In addition, no contact interruptions $>1 \mu\text{s}$ are permitted during the test.

All Phoenix Contact terminal blocks, whatever their connection technology, meet this high vibration requirement.

Shock testing

IEC 60068-2-27

This test is performed to test and document the resistance of a terminal connection to irregular shocks with varying energy content. Degrees of severity from DIN EN 50155 and DIN EN 61373 (European standard for railway applications) are used to simulate the load in rail transport.

Acceleration and duration are specified in order to define the shock. IEC 60068-2-27 prescribes three positive and negative shocks on each of the three spatial axes (X, Y, Z). The simulated accelerations reach 50 m/s^2 with a shock duration of 30 ms.

No damage may occur at the terminal connection that would impair further use. The contact behavior on the test objects is monitored during the test. When the railway standard is applied, no contact interruptions of $>1 \mu\text{s}$ are permitted.

Phoenix Contact terminal blocks achieve this shock resistance and are suitable for applications with the most extreme vibrations.

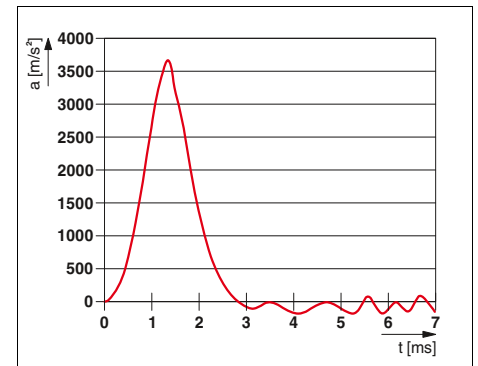

Shock diagram with 3 ms/350 g

Vibration test

IEC 60068-2-6

This test demonstrates the vibration resistance of a terminal connection subjected to permanent vibrations. Harmonic, sinusoidal vibrations are applied to the test object to simulate rotating, pulsating or oscillating forces. The test is performed on each of the three spatial axes (X, Y, Z). The test is performed over a frequency range of 5 Hz to 150 Hz. This equates to a speed of one octave per minute. The r.m.s. value of the acceleration is up to 40 m/s^2 . The test objects are tested on each of the three axes (x, y, z) for 2 hours.

No damage may occur to the terminal blocks that would impair their further use. In addition, no contact interruptions of $>1 \mu\text{s}$ are permitted during the test. The

contact resistance is measured before and after the test.

All connection technologies meet the requirements of the standard with no interruption of the electrical contact. They are therefore particularly suitable for challenging applications in which the reliable function of the terminal connection must be ensured, even when subjected to vibrations.



Quality characteristics of insulation materials

Thermoplastics

The majority of our insulating housing is made from thermoplastic materials. Roughly speaking, these can be divided into amorphous and semi-crystalline substances. Thermoplastics are processed using the efficient and environmentally-friendly injection molding process. They have good recycling and re-use properties. Electrical and electronic modules, devices, and systems are highly demanding in terms of mechanical, thermal, and electrical characteristics. A variety of differently modified materials fulfil these requirements. Thermoplastics are halogen-free. This means that combustion does not cause fumes that can lead to corrosive condensation alone or in conjunction with humidity. It also contains no silicone compounds, formaldehyde, PCB or PCT.

Behavior of plastics under the influence of temperature (operating temperatures)

Plastics undergo a process referred to as thermal aging when they are subjected to heat over long periods. This process causes changes in the mechanical and electrical properties of the material. External influences, e.g., radiation, additional mechanical, chemical or electrical stresses, amplify this effect. Special tests on samples yield characteristic data which provides a good means of drawing comparisons between different plastics. However, applying these characteristics to an evaluation of molded plastic parts is only possible to a limited extent, and only gives the designer a rough guide when it comes to selecting a plastic material. IEC 60947-7-1/ EN 60947-7-1 states an approved temperature increase for terminal blocks of 45 K at nominal load. Terminal blocks from Phoenix Contact meet this requirement.

Inflammability characteristics of plastics (UL 94)

The inflammability tests for plastics are defined by the Underwriters Laboratories (USA) in regulation UL 94. This regulation applies to all areas of application, particularly in electrical engineering. A horizontal or vertical test is carried out at the test laboratory to determine the inflammability of the plastic material with a naked flame. In order of increasing flame-retardant behavior, the evaluation classes are HB, V1, V2, V0. The test results are listed in what are referred to as "Yellow Cards". The results appear annually in the **Recognized Component Directory**.

Thermoplastics: non-reinforced polyamide, PA

We use the modern, semi-crystalline insulation material, polyamide, which is now an essential component in electrical engineering and electronics. Polyamide has led this field for a long time. It is authorized for use by the relevant approval authorities such as the CSA, KEMA, PTB, SEV, UL, VDE, etc.

Polyamide has excellent electrical, mechanical, and chemical properties, even at high operating temperatures. Brief peak temperatures of up to approximately 200°C are permitted as a result of heat aging stabilization. Depending on the type (PA 4.6, 6.6, 6.10, etc.), its melting point is in the region of 215°C to 295°C.

Polyamide absorbs an average of 2.8% of moisture from its surroundings. This is not the embedded water of crystallization, however, but rather chemically bound H₂O groups in the molecular structure. This makes the plastic flexible and resistant to breakage, even at temperatures as low as -40°C. PA has a flammability rating of V2 to V0 in accordance with UL 94.

Thermoplastics: fiber-reinforced polyamide, PA-F

Fiber-reinforced polyamide is characterized by strong rigidity and hardness. Operating temperatures are even higher than those of non-reinforced materials. This means that fiber-reinforced polyamides are also suitable for use in applications such as surge protection.

Reinforced polyamide absorbs less moisture than the non-reinforced material. Otherwise, the properties are largely the same. In accordance with UL 94, fiber-reinforced polyamide has a flammability rating of HB to V0, although V0 materials are usually only available in black.

Thermoplastics: ABS

We use the thermoplastic molding compound ABS for products which need good impact and notched impact properties plus high mechanical stability and rigidity. These products are resistant to stress cracking and chemicals due to their special surface quality and hardness.

Their characteristic thermal properties provide good dimensional stability at both low and high temperatures. Products made of ABS can be coated with metallic surfaces, e.g., nickel.

We use molding compounds with a flammability rating of HB to V0 in accordance with UL 94.

Thermoplastics: polyvinyl chloride, PVC

PVC is resistant to salt solutions, diluted and concentrated lyes, and to most diluted and concentrated acids except for fuming sulfuric acid and concentrated nitric acid.

PVC is flame-retardant even without fire protection equipment (B1 in accordance with DIN 4102 to UL 94 V0).

Properties	Unit/ level	Polyamide PA	Polyamide PA	Polyamide PA-GF	Polyamide PA-GF	Polycarbonate PC-GF
Continuous temperature, DIN IEC 60216	[°C]	≤ 130	≤ 125	120	120	130
Minimum temperature for use (without mechanical load)	[°C]	-60	-60	-60	-60	-60
Electric strength, IEC 60243-1/DIN VDE 0303-21	[kV/cm]	600	600	330	400	300
Resistance to creepage, IEC 60112/DIN VDE 0303-1	CTI...	600	600	550	475	175
Tropical and termite resistance		Good	Good	Good	Good	Good
Specific contact resistance IEC 60093 / VDE 0303-30; IEC 60167 / VDE 0303-31	[Ω cm]	10 ¹²	10 ¹²	10 ¹²	10 ¹²	> 10 ¹⁴
Surface resistance IEC 60093/VDE 0303-30; IEC 60167/VDE 0303-31	[W]	10 ¹⁰	10 ¹⁰	10 ¹²	10 ¹²	> 10 ¹⁴
Flammability rating UL 94		V0	V2	V0	HB	V0

Insulation material properties

IEC 60210-1 / UL 746 B

In the following tests, an increased load on the terminal block is simulated over a longer period of time. The behavior of plastics at constantly higher temperatures is described with respect to their tensile strength and insulation properties. IEC 60216 and UL 746 B specify a temperature index that allows conclusions to be drawn regarding the service life of plastics under thermal loads. Characteristic values are specified for both properties:

- Mechanically as a TI value in accordance with IEC 60216
- Electrically as an RTI value in accordance with UL 746 B

IEC 60216 – TI value

The tensile strength is measured over 5,000 hours and the result is extrapolated to 20,000 hours. After 20,000 hours, the temperature at which the tensile strength has decreased by half is recorded.

UL 746 B – RTI value

The RTI value indicates the highest operating temperature before a disruptive discharge occurs under certain test conditions. The polyamides used by Phoenix Contact are classified as follows:

	UL 94 V2	UL 94 V0
TI	105°C	125°C
RTI	125°C	130°C

Ceramic terminal blocks, for example, are available for use at higher temperatures.

Surface inflammability

ASTM E 162

The spread of a fire under the influence of heat is tested and evaluated in the above standard.

To evaluate the surface inflammability of plastics, a “flame spread index” is devised in accordance with ASTM E 162 to provide information on flame propagation under given test conditions.

For this purpose, a sample (152 x 457 x maximum 25.4 mm) is irradiated with a heat source (815°C) at an angle of 30° and ignited with a naked flame at the top end. During the 15 minute duration of the test, the time in which the flame front reaches two measuring points that are 76 mm apart is determined. The product of this flame propagation time and a calculated heat development factor yields the “flame spread index”.

In the American railroad sector, the maximum limit value is 35. The drip

behavior of the plastic is also observed and evaluated during the test.

Terminal blocks from Phoenix Contact achieve a flame spread index of 5 and produce non-burning droplets. The terminal blocks therefore lie well below the approved maximum values of the Federal Railroad Administration (FRA) of the US Department of Transportation.

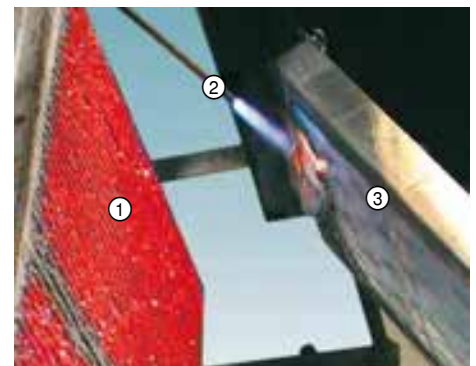

- ① Radiant heater
- ② Flame
- ③ Plastic sample

Smoke gas development

ASTM E 662

The standard ASTM E 662 specifies a procedure for evaluating the specific optical density of the smoke (smoke opacity) during an open fire or a smoldering fire. For this purpose, the percentage of light transmitted in relation to the burning chamber volume is observed. Testing is carried out on a sample (76 x 76 x maximum 25 mm) in a smoke density chamber defined by the NBS (National Bureau of Standards) (see figure). The test object is irradiated with a heat of 2.5 W/cm². The following processes are then simulated for 20 minutes:

1. Burning with a naked flame
2. Smoldering fire, avoidance of a naked flame

There are special limit values for the optical smoke density of both processes

that are recorded after 1.5 and 4 minutes.

- a. Specific optical smoke density (Ds1.5) – limit value 100
- b. Specific optical smoke density (Ds4) – limit value 200
- c. Maximum smoke density (Dm) during the 20 minutes

The polyamides used for Phoenix Contact terminal blocks meet all the requirements of the Federal Railroad Administration (FRA) of the US Department of Transportation in accordance with ASTM E 662.

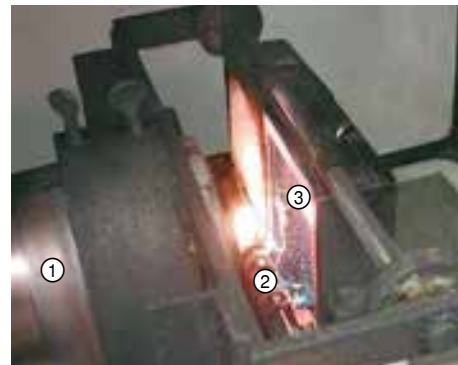

- ① Radiant heater
- ② Flame
- ③ Plastic sample

Smoke gas toxicity

SMP 800-C

SMP 800-C describes the maximum permissible values of poisonous smoke gases when a plastic is burned. In comparison with BSS 7239 (Boeing standard), this standard specifies more precise measuring methods for the qualitative and quantitative determination of toxic smoke gases that result when a test object is completely burned. The smoke gases of these measurements are taken from the NBS test chamber of the ASTM E 662 test. The same time scheme as in ASTM E 662 is valid here.

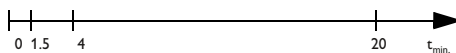

Data is recorded over 20 minutes.
SMP 800-C limit values of toxic smoke gases in [ppm]:

Carbon monoxide (CO)	3500
Carbon dioxide (CO ₂)	90.000
Nitrogen oxides (NO _x)	100
Sulfur dioxide (SO ₂)	100
Hydrochloric acid (HCl)	500
Hydrobromic acid (HBr)	100
Hydrofluoric acid (HF)	100
Hydrocyanic acid (HCN)	100

The polyamides used by Phoenix Contact are many times below the critical concentrations.

Halogen-free flame protection

DIN EN ISO 1043-4

Halogens are the chemical elements fluorine, chlorine, bromine, and iodine. One property of halogen compounds is the reduction in the degree of inflammability when used in plastics. The relationship between released toxic gases and halogens has been defined in fire safety investigations.

Terminal blocks from the CLIPLINE complete system are made of polyamide 6.6 (PA 6.6) with fire protection classification UL 94 V0. Melamine cyanurates are used instead of flame protection agents that contain halogen. Phoenix Contact terminal blocks are therefore, without exception, entirely free of halogens.



Comparative tracking index (CTI)

DIN EN 60112

Humidity and contamination facilitate the formation of creepage distances on the plastic surface. The formation of creepage distances refers to the occurrence of conductive connections between neighboring potentials. Consideration is given to the dependence of the potentials on their voltage differences under electrolytic influences. The CTI value of a plastic indicates the extent to which this creepage distance formation is prevented. Two platinum electrodes are placed 4 mm apart on a test piece measuring 20 mm x 20 mm x 3 mm. A test voltage in accordance with standard specifications is applied to both electrodes. A test solution

is then dripped onto the electrodes by a test apparatus at a rate of one drop every 30 seconds.

The test evaluates the maximum voltage value at which 50 drops are applied without a short-circuit current > 0.5 A. The plastics used by Phoenix Contact are classified in the highest test voltage category with a CTI value of 600.

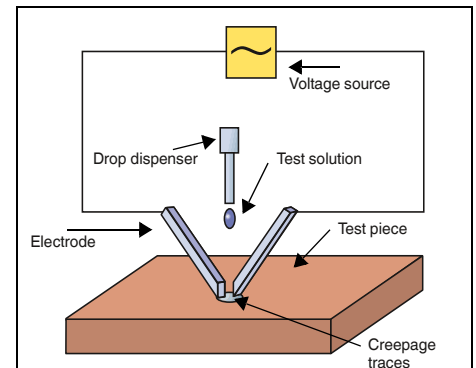

Glow-wire test

IEC 60695-2-11

In the event of overload, conductive metal parts of the terminal block or connected conductors can heat up considerably. This additional heat affects the plastic housing. The glow-wire test simulates this source of danger for electrical components. A glow wire is heated to a specific temperature of 550°C, 650°C, 750°C, 850°C or 960°C. As shown in the figure, the glow wire is then pressed onto the thinnest point of the test object housing at a right angle. The force is 1 N. The test is deemed to be passed:

– When no flame or glowing process occurs during the test

- When the flames or glowing processes are extinguished within 30 seconds of the glow wire being removed
- When the tracing paper beneath the glow wire does not ignite due to drops of burning substances falling down

The polyamides used by Phoenix Contact as housing materials all meet the requirements of the glow-wire test at 960°C (highest level).

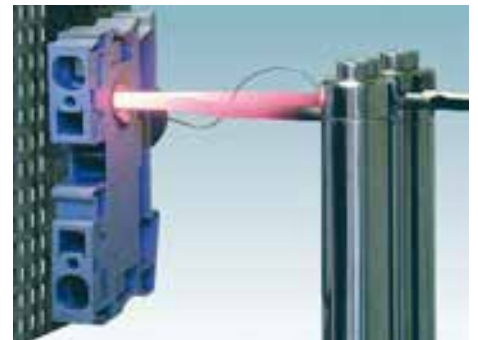

Needle flame test

IEC 60947-7-1/-2

As far as the use of terminal blocks is concerned, fire behavior when in direct contact with a source of ignition is a major criterion. Such sources of ignition could be electric arcs, e.g., across a creepage distance. Terminal blocks must not aid or accelerate fires and the plastics must have self-extinguishing properties.

This fire test simulates the behavior of the components when directly subjected to an external source of ignition.

In the test, a naked flame fed with butane gas is held to an edge or surface of the test object at an angle of 45° for 10 seconds (see figure). The behavior of the test object without a source of ignition is then observed.

- The test is deemed to be passed:
- When the flames or glowing processes are extinguished within 30 seconds of the flame being removed.
 - When the tracing paper beneath the test object is not ignited by falling drops of burning substances.
- All Phoenix Contact terminal blocks pass the needle flame test thanks to the high-grade plastics used and their structural design.



Calorific value of plastic

DIN 51900-2/ASTM E 1354

Due to experience with catastrophic fires, technical systems are increasingly also classified according to the amount of heat dissipation in the case of fire. The reason for this is to limit heat generation in relation to the area.

Fire load

The fire load is defined as the amount of energy released over a particular area during burning. The fire load value is usually expressed in MJ/m². The higher the calorific value and the presence of a substance, the greater the amount of energy released during burning. The calorific values of polyamides are relatively high. For this reason, the calorific values of terminal blocks are also increasingly included in the fire load determination. Calorific values of the plastics used by Phoenix Contact in accordance with:

DIN 51900-2:

Polyamide 66 V2
Polyamide 66 V0

Approx. 30 MJ/kg
Approx. 32 MJ/kg

ASTM E 1354:

Polyamide 66 V2
Polyamide 66 V0

Approx. 22 MJ/kg
Approx. 24 MJ/kg

For comparison:
Heating oil

Approx. 44 MJ/kg

To calculate the fire load of individual components, the calorific value of each polyamide must be multiplied by the weight of the part.

Inflammability classification

UL 94

UL 94 describes inflammability tests that have gained particular importance in the field of electrical engineering. Fire behavior is the main focus. Items are classified in accordance with either UL 94 HB (Horizontal Burn) or UL 94 V (Vertical Burn). The test setup is such that the 94 V0/1/2 classifications are stricter than the 94 HB classification.

UL 94 V0/1/2

After conditioning, the test bar is vertically clamped and flame-treated several times for 10 seconds at a time. In between the flame treatments, the time until the test bar is extinguished is measured.

Afterwards, the afterburning times and the drip behavior are evaluated.

The plastic used for Phoenix Contact terminal blocks satisfies the higher-grade criteria for classification as a V0 material.

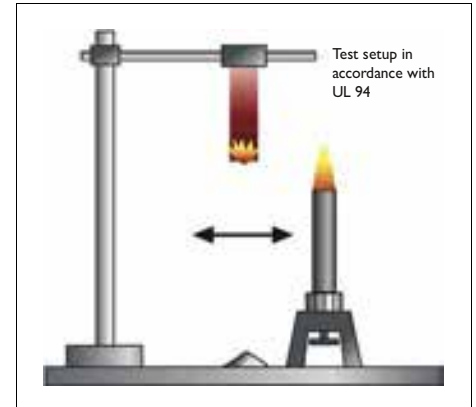

Classification	UL 94 V0	UL 94 V1	UL 94 V2
Burning time after each flame treatment	≤10 s	≤30 s	≤30 s
Total burning time after 10 flame treatments	≤50 s	≤250 s	≤250 s
Glowing time after the 2nd flame treatment	≤30 s	≤60 s	≤60 s
Complete burn-off	No	No	No
Ignition of the absorbent cotton under the sample	No	No	No

Touch protection

IEC 60529 / DIN EN 50274

Electrical installations and systems must also afford service technicians a high level of safety. This applies for all measurements and testing as well as for servicing.

BGV A3 prescribes the voltage-free state of the affected low-voltage system or system parts up to 1000 V AC and 1500 V DC when working in the vicinity of live parts. To prevent electric shock, live parts must be secured against direct contact through the use of covers or barriers.

In electrical systems that are only accessible to electrically skilled persons or electrically instructed persons, terminal blocks from Phoenix Contact provide touch protection based on EN 50274. During testing based on EN 50274, the test probes are led from the operating direction to the test object. Electrical contact between the test probes and live parts is not permitted with a test force of 10 N for proof of touch-proof safety and 50 N for back of hand safety.

Phoenix Contact terminal blocks are designed primarily in accordance with DIN EN 50274. More detailed information is provided in the product documentation.



Touch-proof safety
Test finger with 12.5 mm diameter



Back of hand safety
Test ball with 50 mm diameter

Color designations

Color	Code
White	WH
Red	RD
Blue	BU
Green	GN
Yellow	YE
Gray	GY
Brown	BN
Orange	OG
Black	BK
Turquoise	TQ
Ivory	IV
Beige	BE
Olive	OL
Rose	RS
Pink	PK

Type	Order No.	Page	Type	Order No.	Page	Type	Order No.	Page	Type	Order No.	Page
D-QTCU 2,5-TWIN-MT	3050511	265	D-UK 5-HESI N	3000543	490	DLK 4-PE	3011999	489	EB 3-18 A	3009311	500
D-QTTCB 1,5	3205187	258	D-UK 6-T	3072802	520	DLKB 2,5-PE	3011038	489	EB 3-20/PT	3260068	136
D-QTTCCB 1,5/2P	3206306	287	D-UKK 3/5	2770024	472	DOK 1,5	2717016	484	EB 3-25/PT	3260160	138
D-QTTCCS 1,5	3206335	261	D-UKK 3/5 BU	2770105	472	DOK 1,5-2D	2717139	485	EB 3-31/PT	3215058	140
D-QTTTCBU 1,5	3050536	260	D-UKK 4	2770558	538	DOK 1,5-LA 24GN/O-M	2717074	484	EB 4-18 A	3009313	500
D-RSC 5	3058020	387	D-UKKB 3/5	2771023	472	DOK 1,5-LA 24RD/O-M	2717029	484	EB 4-22 A	3009316	500
D-RSC 5-F	3059647	387	D-UKKB 3/5 BU	2771104	472	DOK 1,5-TG	2717113	485	EB 4-25/PT	3260161	138
D-RSC 5-T	3058046	388	D-UKKB 10	3001394	474	DOKD 1,5-TG	3011054	485	EB 56-18 A	3009315	500
D-RSC 5-F-T	3059346	388	D-URTK	0310020	519	DP PS-3,5	3031011	38	EB 56-22 A	3009319	500
D-RSC 6	3213098	389	D-URTK 6	3026340	523	DP PS-4	3036712	206	EB 8-18 A	3009314	500
D-RSC 6-F	3213108	389	D-URTK/S-BEN	0308029	519	DP PS-5	3036725	70	EB 8-22 A	3009318	500
D-RT 3/5	3049097	379	D-URTK/SS	0321022	517	DP PS-6	3036738	98	EB 80- DIK BU	2715940	480
D-RT 4-T	3000606	383	D-USK 4/10	0260028	537	DP PS-8	3036741	110	EB 80- DIK RD	2715953	480
D-RT 5-T	3049291	382	D-USST 4-MT	3070304	547	DP-CP-H 2,5-4L	3012319	294	EB 80- DIK WH	2715788	480
D-RT 8	3049194	385	D-USST 4/10	3070370	545	DP-MBKB 2,5	1413065	560	EBL 2-5	2303145	466
D-SC 2,5	3042243	313	D-USST 6-T	3070367	548	DP-MTTB 1,5	3002681	555	EBL 3-5	2303158	466
D-SC 4	3043307	341	D-UT 16	3047206	185	DP-PT 10,3-HESI	3062155	122	EBL 10-5	2303132	459
D-SRFTK 6	3029981	240	D-UT 2,5-3L	3214314	150	DP-PT 2,5-HEXA/3P	3040060	291	EBS 2-8	3118151	490
D-SSK 0525 KER	0201061	541	D-UT 2,5/10	3047028	149	DP-PT 6-T P/P HV-1,8	1028592	114	EBS 3-8	3118148	490
D-SSK 110 KER	0202060	542	D-UT 2,5/1P	3047154	303	DP-PTRV 4	3270163	46	EBS 10-8	3118135	490
D-SSK 116 KER	0203069	543	D-UT 2,5/4-QUATTRO	3047170	149	DP-PTRV 8	3270166	50	ESB 2-MZDB	3029703	222
D-SSK 135 KER	0205067	543	D-UT 2,5/4-TWIN	3047141	149	DP-RSCWE 6-3	3069314	641			
D-ST 1,5/S-QUATTRO	3213166	208	D-UT 4-QUATTRO HV	3048852	160	DP-STMED 6	3035690	115			
D-ST 10	3036644	243	D-UT 4-QUATTRO/2P	3045648	329	DP-UK 10,3-HESI A	1045724	500			
D-ST 10-TWIN	3035315	243	D-UT 4-TWIN HV	3000710	159	DP-UKK 3/5	2770794	472			
D-ST 16	3036657	247	D-UT 4-TWIN/1P	3045237	303	DP-UKKB 3/5	2770804	472			
D-ST 16-TWIN	3035357	247	D-UT 4/1P-H	3001382	329	DP-UTT 2,5/4	3044677	151			
D-ST 2,5	3030417	71	D-UT 6-3L	3046707	173	DP-UTTB 2,5/4	3047303	149			
D-ST 2,5-0,8 OG	3030511	71	D-UT 6-QUATTRO/2P	3060607	355	DS-PTIO 1,5/S	1045987	42	FAME-BAG 260	3069520	637
D-ST 2,5-3L	3036660	213	D-UT 6-T-HV	3070147	176				FB 10- GSK/S	0305174	517
D-ST 2,5-4L/1P	3041930	311	D-UT 6-T/SP	3072816	176				FB 10- RTK/S	0311171	519
D-ST 2,5-4L/2P	3041927	311	D-UTI 6/3	1025464	178				FB 10- URTK/SP	0311663	525
D-ST 2,5-PE/3L	3036673	213	D-UTI/3	3076036	154				FB 10-13	3059126	387
D-ST 2,5-QUATTRO	3030514	71	D-UTME 4	3047491	169				FB 10-13 ISO	3059663	387
D-ST 2,5-QUATTRO-0,8 OG	3030513	71	D-UTME 4-CT/1P	3057445	332				FB 10-17	3075951	389
D-ST 2,5-QUATTRO-MT	3038590	76	D-UTME 4/1P	3057429	331				FB 10-17 ISO	3213085	389
D-ST 2,5-QUATTRO/2P	3040083	291	D-UTME 6	3047426	177	E-UTWE 6	3069055	616	FB 10-9	3059113	569
D-ST 2,5-QUATTRO/4P	3042175	293	D-UTN 2,5/10	3245079	154	E/1	1201044	541	FB 10-9 ISO	3059650	569
D-ST 2,5-TWIN	3030488	71	D-UTT 2,5/4	3044676	151	E/AL-NS 35	1201662	390	FBI 2-15	0201333	461
D-ST 2,5-TWIN-0,8 OG	3030512	71	D-UTTB 2,5/4	3047293	149	EB 2-5	1401158	560	FBI 2-20	0201346	188
D-ST 4	3030420	99	D-UTTB 2,5/4 2P	3060393	303	EB 2-6	0201155	467	FBI 3-20	0201317	188
D-ST 4-QUATTRO	3030527	229	D-UTTB 4 HV	3000709	160	EB 2-8	0202154	117	FBI 10-6	0203250	459
D-ST 4-QUATTRO/2P	3043747	339	D-UVK 4	1922022	535	EB 2-10	0203153	493	FBI 10-8	0203263	460
D-ST 4-QUATTRO/4CP	3042739	340	D-UVKB 4	1920024	534	EB 2-25/UKH	0201362	194	FBI 10-10	0203276	460
D-ST 4-TWIN	3030491	229	DF-CP 2,5-4L	3012327	294	EB 2-31/UKH	0201388	196	FBI 10-12	0203454	461
D-ST 6	3030433	237	DF-PTMC-2-ZB	3270406	57	EB 2-36/UKH	0201401	198	FBI 2-20 N	3213195	190
D-ST 6-TWIN	3036767	237	DF-PTMC-3-ZB	3270405	57	EB 2-OTTA 2,5	3026065	563	FBI 3-20 N	3213205	190
D-STIO 2,5/3	3209112	214	DF-PTMC-NS	3270403	57	EB 2-OTTA 6	0790608	564	FBP 10+1	1029719	615
D-STIO 2,5/4	3209125	215	DF-PTMC-O	3270400	57	EB 3-5	1401145	560	FBP 11+1	1029720	615
D-STS 2,5	3031762	84	DF-PTMC-U	3270401	57	EB 3-6	0201142	467	FBP 12+1	3069408	615
D-STS 4	3031704	233	DF-PTMC-ZB	3270410	57	EB 3-8	0202141	117	FBP 3+1	3069399	615
D-STS 4-TWIN/L	3036770	234	DF-SP-H 2,5	3209824	372	EB 3-25/UKH	0201375	194	FBP 4+1	3069405	615
D-STS 6	3038189	239	DF-UP 4	3060348	372	EB 3-31/UKH	0201391	196	FBP 5+1	3069409	615
D-STS 6-TWIN	3038202	239	DF-UP 6	3060856	372	EB 3-36/UKH	0201414	198	FBP 6+1	3069406	615
D-STTB 2,5	3030459	206	DF-UPBV 2,5/4	3060432	372	EB 3-OTTA 2,5	3026078	563	FBP 7+1	3069400	615
D-STTB 2,5-TWIN	3038558	212	DFS-CP 2,5-4L	3012321	294	EB 3-OTTA 6	3026036	564	FBP 8+1	3069407	615
D-STTB 2,5/2P	3040096	292	DFS-CP-H 2,5-4L	3012317	294	EB 4-8	0202142	117	FBP 9+1	1029718	615
D-STTB 2,5/4P	3061538	293	DFS-SP-H 2,5	3061431	371	EB 4-OTTA 2,5	3026081	563	FBP-2/10	3069881	626
D-STTB 4	3030462	99	DFS-SPB 2,5	3061444	371	EB 4-OTTA 6	3026049	564	FBP-2/11	3069882	626
D-STTBS 2,5	3038503	85	DFS-SPDB 2,5	3061457	371	EB 5-OTTA 2,5	3026094	563	FBP-2/12	3069883	626
D-STTBS 4	3035098	234	DG-MTTB 1,5	3002678	555	EB 5-OTTA 6	3026050	564	FBP-2/13	3069884	626
D-STTBS 4-MT	3035548	235	DG-UKK 3/5	2770817	488	EB 6-OTTA 2,5	3026104	563	FBP-2/14	3069885	626
D-STTBU 4	3033207	233	DIK 1,5	2715966	480	EB 7-OTTA 2,5	3026117	563	FBP-2/15	3069886	626
D-STU 10/4X2,5	3033197	244	DIK 1,5 BU	2716059	480	EB 7-OTTA 6	3026052	564	FBP-2/16	3069887	626
D-STU 2,5-TWIN	3033045	84	DIK 1,5-LA 24GN/O-M	2715762	482	EB 10-5	1401132	560	FBP-2/17	3069888	626
D-STU 4-TWIN	3033087	233	DIK 1,5-LA 24GN/U-O	2715733	482	EB 10-6	0201139	459	FBP-2/18	3069889	626
D-TP-VBS	0851026	536	DIK 1,5-LA 24RD/O-M	2715856	482	EB 10-8	0202138	117	FBP-2/19	3069890	626
D-UDK 4	2775113	470	DIK 1,5-LA 24RD/U-O	2715995	482	EB 10- DIK BU	2716680	480	FBP-2/20	3069891	626
D-UDK 4 BU	2775197	470	DIKD 1,5	2715979	481	EB 10- DIK GY	2715937	480	FBP-2/21	3069892	626
D-UDK-RELG	2777027	507	DIKD 1,5 BU	2716101	481	EB 10- DIK RD	2716774	480	FBP-2/22	3069893	626
D-UGSK	0304023	517	DIKD 1,5-2D	2716512	481	EB 10- OTTA 6	0790420	564	FBP-2/23	3069894	626
D-UHSK 2000	0704021	460	DIKD 1,5-LA 24GN/O-M	2716376	483	EB 10-10	0203137	461	FBP-2/24	3069895	626
D-UK 2,5	3001022	458	DIKD 1,5-LA 24GN/U-O	2716402	483	EB 10-12	3006137	461	FBP-2/25	3069896	626
D-UK 2,5 BU	3001103	458	DIKD 1,5-LA 24RD/O-M	2715814	483	EB 10-OTTA 2,5	3026120	563	FBP-2/4	3069875	626
D-UK 4/10	3003020	459	DIKD 1,5-LA 24RD/U-O	2716279	483	EB 16-18 A	1006832	500	FBP-2/5	3069876	626
D-UK 4/10 BU	3003101	459	DIKD 1,5-PV	2715092	481	EB 16-22 A	1006839	500	FBP-2/6	3069877	626
D-UK 5-TWIN	1923034	466	DIKD 1,5-PV BK	2715571	481	EB 2-18 A	3009310	500	FBP-2/7	3069878	626
D-UK 5-TWIN BU	1923050	466	DIKD 1,5-PV BU	2715584	481	EB 2-20/PT	3260067	136	FBP-2/8	3069879	626
D-UK 16	3006027	461	DIKD 1,5-TG	2774237	483	EB 2-25/PT	3260157	138	FBP-2/9	3069880	626
D-UK 4-SD	3246862	526	DLK 2,5-PE	3011041	489	EB 2-31/PT	3215057	140	FBP-2/A14	3069500	631

F

Index

Alphabetical

Type	Order No.	Page	Type	Order No.	Page	Type	Order No.	Page	Type	Order No.	Page
FBP-2/A7	3069497	631	FBS 4-4	3030132	206	FBS-PV UT	3047358	404	FTMC 1,5-2 /YE	3270457	57
FBP-2/B14	3069501	631	FBS 4-4 BU	3030133	403	FBS-C	3012325	402	FTMC 1,5-3 /BK	3270444	57
FBP-2/B19	3069503	631	FBS 4-4 GY	3030134	403	FBSL 10-8	3030328	178	FTMC 1,5-3 /BN	3270443	57
FBP-2/B7	3069498	631	FBS 4-5	3030187	70	FBSL 2-8	3030324	178	FTMC 1,5-3 /BU	3270440	57
FBP-2/C14	3069502	631	FBS 4-5 BU	3036893	403	FBSL 3-8	3030325	178	FTMC 1,5-3 /GN	3270442	57
FBP-2/C19	3069504	631	FBS 4-5 GY	3038985	403	FBSL 4-8	3030326	178	FTMC 1,5-3 /GY	3270340	57
FBP-2/D19	3069671	631	FBS 4-6	3030255	98	FBSL 5-8	3030327	178	FTMC 1,5-3 /OG	3270446	57
FBP-2/E7	3069499	631	FBS 4-6 BU	3036958	403	FBSR 2-5	3033702	70	FTMC 1,5-3 /PK	3270448	57
FBP-2/F19	3069675	631	FBS 4-6 GY	3032279	403	FBSR 2-6	3033715	98	FTMC 1,5-3 /RD	3270441	57
FBP-2/G19	3069676	631	FBS 4-8	3030307	110	FBSR 2-8	3033808	110	FTMC 1,5-3 /VT	3270445	57
FBP-2/H19	3069677	631	FBS 4-8 BU	3032583	403	FBSR 3-8	3001597	110	FTMC 1,5-3 /WH	3270341	57
FBP-2/I19	3069678	631	FBS 4-8 CT	3033832	403	FBSR 5-8	3033809	110	FTMC 1,5-3 /YE	3270447	57
FBP-3/4 SL	1030010	644	FBS 4-8 GY	3032635	403	FBSR 10-5	3033710	70	FTMC 1,5/32-2	3270354	60
FBP-3/6 SL	1090788	644	FBS 5-10	3005948	120	FBSR 10-6	3033716	98	FTMC 1,5/32-2 /BU	3270355	60
FBP-3/10 TR	3069924	639	FBS 5-4	3030145	206	FBSR 10-8	3001599	110	FTMC 1,5/32-2H /BU 19Z	3270357	64
FBP-3/11 TR	3069948	639	FBS 5-4 BU	3030146	403	FBSR 16-8	3033816	110	FTMC 1,5/32-2H 19Z	3270356	64
FBP-3/12 TR	3069923	639	FBS 5-4 GY	3030147	403	FBSR 3-5	3001591	70	FTMC 1,5/32-3	3270350	58
FBP-3/13 TR	3069934	639	FBS 5-5	3030190	70	FBSR 3-6	3001594	98	FTMC 1,5/32-3 /BU	3270352	58
FBP-3/14 TR	3069925	639	FBS 5-5 BU	3036903	403	FBSR 4-5	3001592	70	FTMC 1,5/32-3 /BU 19Z	3270353	62
FBP-3/2 TR	3069926	639	FBS 5-5 GY	3038998	403	FBSR 4-6	3001595	98	FTMC 1,5/32-3 19Z	3270351	62
FBP-3/3 TR	3069927	639	FBS 5-6	3030349	98	FBSR 4-8	3000585	110	FTMC 1,5/48-2	3270362	61
FBP-3/4 TR	3069922	639	FBS 5-6 BU	3036961	403	FBSR 5-5	3001593	70	FTMC 1,5/48-2 /BU	3270363	61
FBP-3/5 TR	3069928	639	FBS 5-6 GY	3032266	403	FBSR 5-6	3001596	98	FTMC 1,5/48-3	3270358	59
FBP-3/6 TR	3069929	639	FBS 5-8	3030310	110	FBSRH 2-6	3033812	407	FTMC 1,5/48-3 /BU	3270360	59
FBP-3/7 TR	3069945	639	FBS 5-8 BU	3032596	403	FBSRH 2-8	3033802	407	FTMC 1,5/48-3 /BU 19Z	3270361	63
FBP-3/8 TR	3069946	639	FBS 5-8 GY	3032648	403	FBSRH 3-8	3033803	407	FTMC 1,5/48-3 19Z	3270359	63
FBP-3/9 TR	3069947	639	FBS 6-8	3032470	402	FBSRH 4-8	3033804	407	FTMC 1,5/80-2	3270368	61
FBP-3F 2U	1029275	651	FBS 6-8 BU	3032677	403	FBST 500-PLC GY	2966838	48	FTMC 1,5/80-2 /BU	3270369	61
FBP-3F 3U	1029276	651	FBS 6-8 GY	3032664	403	FBST 500-PLC RD	2966786	48	FTMC 1,5/80-3	3270364	59
FBP-3F 4U	1029279	651	FBS 1,5/S-PV	3216263	404	FBSW 2-5/110MM	3030171	405	FTMC 1,5/80-3 /BU	3270366	59
FBP-3F/12 3U AUX	1029337	651	FBS 1/2/4/6-8	3032378	402	FBSW 2-5/250MM	3030172	405	FTMC 1,5/80-3 /BU 19Z	3270367	63
FBP-3F/14	1029280	651	FBS 10-3,5	3213056	38	FBSW 2-5/60MM	3030170	405	FTMC 1,5/80-3 19Z	3270365	63
FBP-3F/14 4U AUX	1029339	651	FBS 10-3,5 BU	3213125	403	FC 4-PCB/10	3208736	334	FTP 10+1	1029708	615
FBP-3F/14 AUX	1029338	651	FBS 10-3,5 GY	3213196	403	FC 4-PCB/8	3208694	334	FTP 11+1	1029709	615
FBP-3F/8	1029278	651	FBS 10-4	3030158	206	FIP-3/1 SERVICE	3069921	626	FTP 12+1	3069255	615
FBRI 2-5 N	3000227	470	FBS 10-4 BU	3036851	403	FIP-3/2 SERVICE	3069920	638	FTP 3+1	3069222	615
FBRI 3-5 N	3000201	470	FBS 10-4 GY	3030160	403	FIP-3/3 SERVICE	3069312	638	FTP 4+1	3069223	615
FBRI 4-5 N	3000191	470	FBS 10-5	3030213	70	FIP-3/4 SERVICE	3069313	638	FTP 5+1	3069241	615
FBRI 10-5 N	2770642	459	FBS 10-5 BU	3036916	403	FTMC 1,5 /1-2-DF	3001984	68	FTP 6+1	3069239	615
FBRI 10-8 N	2772080	240	FBS 10-5 GY	3039007	403	FTMC 1,5 /1-2-NS	3001965	68	FTP 7+1	3069243	615
FBRN 10-4 N	3001624	458	FBS 10-6	3030271	98	FTMC 1,5 /1-3-DF	3001975	68	FTP 8+1	3069242	615
FBRN 2-5 N	3000175	472	FBS 10-6 BU	3032198	403	FTMC 1,5 /1-3-NS	3001957	68	FTP 9+1	1029706	615
FBRN 3-5 N	3000162	472	FBS 10-6 GY	3032253	403	FTMC 1,5 /2-2-DF	3001985	68	FTP-2/1 SERVICE	3069469	626
FBRN 4-5 N	3000159	472	FBS 10-8	3030323	110	FTMC 1,5 /2-2-NS	3001966	68	FTP-2/10	3001712	624
FBRN 10-5 N	2770639	472	FBS 10-8 BU	3032606	403	FTMC 1,5 /2-3-DF	3001976	68	FTP-2/11	3001713	624
FBRN 10-6 N	2770626	517	FBS 10-8 CT	3033833	403	FTMC 1,5 /2-3-NS	3001958	68	FTP-2/12	3001714	624
FBS 1/3-8	3032363	402	FBS 10-8 GY	3032651	403	FTMC 1,5 /3-2-DF	3001986	68	FTP-2/13	3001715	624
FBS 1/3-5-8	3032389	402	FBS 2-3,5	3213014	38	FTMC 1,5 /3-2-NS	3001968	68	FTP-2/14	3001716	624
FBS 1/4-8	3032376	402	FBS 2-3,5 BU	3213086	403	FTMC 1,5 /3-3-DF	3001977	68	FTP-2/15	3001717	624
FBS 1/4/7/10-8	3032402	402	FBS 2-3,5 GY	3213153	403	FTMC 1,5 /3-3-NS	3001959	68	FTP-2/16	3001719	624
FBS 1/5-8	3032381	176	FBS 20-3,5	3213069	38	FTMC 1,5 /4-2-DF	3001987	68	FTP-2/17	3001720	624
FBS 2-10	3005947	120	FBS 20-3,5 BU	3213138	403	FTMC 1,5 /4-2-NS	3001969	68	FTP-2/18	3001722	624
FBS 2-12	3005950	124	FBS 20-3,5 GY	3213206	403	FTMC 1,5 /4-3-DF	3001978	68	FTP-2/19	3001723	624
FBS 2-16	3005963	134	FBS 20-4	3030352	206	FTMC 1,5 /4-3-NS	3001960	68	FTP-2/2 SERVICE	3069464	626
FBS 2-4	3030116	206	FBS 20-4 BU	3030353	403	FTMC 1,5 /5-2-DF	3001988	68	FTP-2/20	3001724	624
FBS 2-4 BU	3030117	403	FBS 20-4 GY	3030354	403	FTMC 1,5 /5-2-NS	3001971	68	FTP-2/21	3001725	624
FBS 2-4 GY	3030118	403	FBS 20-5	3030226	70	FTMC 1,5 /5-3-DF	3001979	68	FTP-2/22	3001726	624
FBS 2-5	3030161	70	FBS 20-5 BU	3036929	403	FTMC 1,5 /5-3-NS	3001961	68	FTP-2/23	3001727	624
FBS 2-5 BU	3036877	403	FBS 20-5 GY	3038671	403	FTMC 1,5 /6-2-DF	3001989	68	FTP-2/24	3001728	624
FBS 2-5 GY	3038969	403	FBS 20-6	3030365	98	FTMC 1,5 /6-2-NS	3001972	68	FTP-2/25	3001729	624
FBS 2-6	3030336	98	FBS 20-6 BU	3032208	403	FTMC 1,5 /6-3-DF	3001980	68	FTP-2/3 SERVICE	3069465	626
FBS 2-6 BU	3036932	403	FBS 3-3,5	3213027	38	FTMC 1,5 /6-3-NS	3001962	68	FTP-2/4	3001706	624
FBS 2-6 GY	3032237	403	FBS 3-3,5 BU	3213099	403	FTMC 1,5 /7-2-DF	3001990	68	FTP-2/4 SERVICE	3069468	626
FBS 2-8	3030284	110	FBS 3-3,5 GY	3213167	403	FTMC 1,5 /7-2-NS	3001973	68	FTP-2/5	3001707	624
FBS 2-8 BU	3032567	403	FBS 4-3,5	3213030	38	FTMC 1,5 /7-3-DF	3001981	68	FTP-2/6	3001708	624
FBS 2-8 CT	3033830	403	FBS 4-3,5 BU	3213109	403	FTMC 1,5 /7-3-NS	3001963	68	FTP-2/7	3001709	624
FBS 2-8 GY	3032621	403	FBS 4-3,5 GY	3213180	403	FTMC 1,5 /8-2-DF	3001991	68	FTP-2/8	3001710	624
FBS 3-4	3030129	206	FBS 5-3,5	3213043	38	FTMC 1,5 /8-2-NS	3001974	68	FTP-2/9	3001711	624
FBS 3-4 BU	3030130	403	FBS 5-3,5 BU	3213112	403	FTMC 1,5 /8-3-DF	3001982	68	FTP-2/A14	3069474	631
FBS 3-4 GY	3030131	403	FBS 5-3,5 GY	3213183	403	FTMC 1,5 /8-3-NS	3001964	68	FTP-2/A7	3069470	631
FBS 3-5	3030174	70	FBS 50-3,5	3000706	402	FTMC 1,5-2 /BK	3270454	57	FTP-2/B14	3069475	631
FBS 3-5 BU	3036880	403	FBS 50-3,5 BU	3000708	403	FTMC 1,5-2 /BN	3270453	57	FTP-2/B19	3069477	631
FBS 3-5 GY	3038972	403	FBS 50-3,5 GY	3000707	403	FTMC 1,5-2 /BU	3270450	57	FTP-2/B7	3069471	631
FBS 3-6	3030242	98	FBS 50-5	3038930	402	FTMC 1,5-2 /GN	3270452	57	FTP-2/C14	3069476	631
FBS 3-6 BU	3036945	403	FBS 50-5 BU	3032114	403	FTMC 1,5-2 /GY	3270342	57	FTP-2/C19	3069478	631
FBS 3-6 GY	3032240	403	FBS 50-5 GY	3032127	403	FTMC 1,5-2 /OG	3270456	57	FTP-2/D19	3069479	631
FBS 3-8	3030297	110	FBS 50-6	3032224	402	FTMC 1,5-2 /PK	3270458	57	FTP-2/E7	3069472	631
FBS 3-8 BU	3032570	403	FBS 50-6 BU	3032211	403	FTMC 1,5-2 /RD	3270451	57	FTP-2/F19	3069480	631
FBS 3-8 CT	3033831	403	FBS-PV	3032185	404	FTMC 1,5-2 /VT	3270455	57	FTP-2/G19	3069481	631
FBS 3-8 GY	3032622	403	FBS-PV PT 2,5-4L	3012318	404	FTMC 1,5-2 /WH	3270343	57	FTP-2/H19	3069482	631

Type	Order No.	Page	Type	Order No.	Page	Type	Order No.	Page	Type	Order No.	Page
FTP-2/I19	3069483	631	FTPR-3/I3S	3069971	637	G 10/ 4	2716729	577	K		
FTP-3/I10S	3069951	637	FTPR-3/I4S	3069957	637	G 10/ 5	2716732	577			
FTP-3/I11S	3069963	637	FTPR-3/4S	3069954	637	GBS 5-25X12	0810588	419			
FTP-3/I2S	3069952	637	FTPR-3/6S	3069965	637	GBS 5-25X5	0829126	419			
FTP-3/I3S	3069964	637	FTPR-3/6S	3069966	637	GBS-ZB/26X6	0809298	419	KB- 6	0201472	541
FTP-3/I4S	3069953	637	FTPR-3/7S	3069967	637	GE 35/2 BU	3071078	578	KB- 8	0202206	542
FTP-3/4S	3069950	637	FTPR-3/8S	3069968	637	GE 35/2-B BU	2701570	579	KB- 10	0203205	474
FTP-3/4SL	1030004	645	FTPR-3/9S	3069969	637	GS-GSK/S	0305116	517	KBI- 15	0205203	543
FTP-3/4SL GN	1030003	645	FTRV 4 /COL-COL	3001883	54	GTF 76/ 48	3121025	533	KLM 2	0807575	428
FTP-3/5S	3069958	637	FTRV 4 /COL-RD	3001760	54	GTF 76/230	3121012	533	KLM 3	0811969	428
FTP-3/6S	3069959	637	FTRV 4 /COL-WH	3001880	54				KLM 3-L	0814788	391
FTP-3/6SL GN/BU	1090787	645	FTRV 4 /RD	3270175	46				KSS 3- 6	0309523	592
FTP-3/7S	3069960	637	FTRV 4 /RD-COL	3001881	54				KSS 4- 8	0309549	592
FTP-3/8S	3069961	637	FTRV 4 /WH	3270169	46				KSS 4-10	0308540	546
FTP-3/9S	3069962	637	FTRV 4 /WH-COL	3001882	54				KSS 5	2303543	592
FTP-3F/12 3U	1029267	651	FTRV 4 BU/BU	3270172	46				KSS 6	0301547	592
FTP-3F/14	1029269	651	FTRV 4 BU/RD	3270174	46	HC-RBO 10	3247970	391	KSS 8	0311540	117
FTP-3F/14 4U	1029268	651	FTRV 4 BU/WH	3270173	46	HC-RBO 10 BU	3247972	391	KSS 10	0310541	592
FTP-3F/18 4U	1029273	651	FTRV 4-FE /BKYE	3270185	47	HC-RBO 10-FE	3247971	391	KSSI 2-8	3000722	117
FTP-3F/7 2U	1029262	651	FTRV 4-FE /YEBK	3270184	47	HC-RBO 12	3247983	391	KSSI 4-8	3000735	592
FTP-3F/8	1029263	651	FTRV 4-PV /BK	3270178	47	HC-RBO 12 BU	3247985	391			
FTP-3F/10+1	3069266	615	FTRV 4-PV BU/BK	3270181	47	HC-RBO 12-FE	3247984	391			
FTP-3F/11+1	3069267	615	FTRV 8 /COL-COL	3001888	54	HC-RBO 16	3247996	391			
FTP-3F/12+1	3069268	615	FTRV 8 /COL-RDWH	3001852	54	HC-RBO 16 BU	3247998	391			
FTPC 3+1	3069259	615	FTRV 8 /COL-WHRD	3001884	54	HC-RBO 16-FE	3247997	391	MBK 5/E-TG	1415089	506
FTPC 4+1	3069260	615	FTRV 8 /RDWH	3270193	50	HC-RBO 8	3247967	390	MBK 6/E	0552024	558
FTPC 5+1	3069261	615	FTRV 8 /RDWH-COL	3001885	54	HC-RBO 8 BU	3247969	390	MBKKB 2,5	1414064	560
FTPC 6+1	3069262	615	FTRV 8 /WHRD	3270187	50	HC-RBO 8-FE	3247968	390	MBKKB 2,5 BU	1414077	560
FTPC 7+1	3069263	615	FTRV 8 /WHRD-COL	3001887	54	HSH-METALL	3210910	367	MBKKB 2,5-BE	1414103	561
FTPC 8+1	3069264	615	FTRV 8 BU/BU	3270190	50	HSH-METALL-6/8	3000770	367	MBKKB 2,5-DIO/O-U	2800567	561
FTPC 9+1	3069265	615	FTRV 8 BU/RDWH	3270192	50	HSR	3212031	367	MBKKB 2,5-DIO/U-O	2800570	561
FTPC-3/10S	3069931	637	FTRV 8 BU/WHRD	3270191	50	HSR 6/8	3000769	367	MBKKB 2,5-PV	2800583	560
FTPC-3/11S	3069940	637	FTRV 8-FE /BKYE	3270204	51	HV M10/1	3049408	397	MBKKB 2,5-PV BU	1414132	560
FTPC-3/12S	3069933	637	FTRV 8-FE /YEBK	3270202	51	HV M10/1 M6/1-STL2	3071081	395	MP 1,5	3248150	45
FTPC-3/13S	3069941	637	FTRV 8-PV /BK	3270194	51	HV M10/1-AP	3049495	395	MPS-IH BK	0201731	410
FTPC-3/14S	3069932	637	FTRV 8-PV BU/BK	3270196	51	HV M10/1-VS 2	3049466	395	MPS-IH BU	0201689	410
FTPC-3/4S	3069930	637	FTRVB 4-FI /BK	3270208	48	HV M10/1-VS 3	3049479	395	MPS-IH GN	0201702	410
FTPC-3/5S	3069935	637	FTRVB 4-PV /BK	3270207	48	HV M10/2	3049563	395	MPS-IH GY	0201728	410
FTPC-3/6S	3069936	637	FTRVB 8-FI /BK	3270210	52	HV M12/1	3049505	397	MPS-IH RD	0201676	38
FTPC-3/7S	3069937	637	FTRVB 8-PV /BK	3270209	52	HV M12/1-TP	3049602	396	MPS-IH WH	0201663	410
FTPC-3/8S	3069938	637	FUSE 10,3X38 10A PV	3061334	503	HV M12/1-VS 2	3049631	397	MPS-IHYE	0201692	410
FTPC-3/9S	3069939	637	FUSE 10,3X38 12A PV	3061347	503	HV M12/1-VS 3	3049644	397	MPS-MT	0201744	38
FTP-2/10	3001688	624	FUSE 10,3X38 16A PV	3061350	503	HV M12/2-TP	3049709	395	MPS-MT 1-S	1944372	428
FTP-2/11	3001689	624	FUSE 10,3X38 20A PV	3061363	503	HV M5/1	3049107	396	MPS-MT 1-S4-B RD	1982800	428
FTP-2/12	3001690	624	FUSE 10,3X38 25A PV	3061364	503	HV M5/1-AP	3049806	396	MPS-MT SN	3212251	438
FTP-2/13	3001691	624	FUSE 10,3X38 2A PV	3061295	503	HV M5/1-VS 2	3049437	396	MPS-MT/ 4MM	3048577	410
FTP-2/14	3001692	624	FUSE 10,3X38 4A PV	3061305	503	HV M5/1-VS 3	3049440	396	MPT 1,5/S	3248100	45
FTP-2/15	3001693	624	FUSE 10,3X38 6A PV	3061318	503	HV M6/1	3049204	396	MPT 1,5/S-PE	3248110	45
FTP-2/16	3001694	624	FUSE 10,3X38 8A PV	3061321	503	HV M6/1-AP	3049903	395	MPT 1,5/S/1P	3248115	278
FTP-2/17	3001696	624	FUSE 10,3X85 10A PV	3062770	505	HV M6/1-VS 2	3049262	395	MPT 1,5/S/1P BU	3248116	278
FTP-2/18	3001697	624	FUSE 10,3X85 12A PV	3062771	505	HV M6/1-VS 3	3049275	395	MPT 1,5/S/1P-PE	3248117	278
FTP-2/19	3001698	624	FUSE 10,3X85 16A PV	3062772	505	HV M6/2	3049547	395	MPT 2,5	3248125	97
FTP-2/20	3001699	624	FUSE 10,3X85 20A PV	3062773	505	HV M8/1	3049301	397	MPT 2,5 BU	3248126	97
FTP-2/21	3001700	624	FUSE 10,3X85 25A PV	3062774	505	HV M8/1 M6/1-STL	3071094	395	MPT 2,5-PE	3248130	97
FTP-2/22	3001701	624	FUSE 10,3X85 2A PV	3062766	505	HV M8/1-AP	3049398	395	MSB 1,5/S	3244012	222
FTP-2/23	3001702	624	FUSE 10,3X85 4A PV	3062767	505	HV M8/1-VS 2	3049369	395	MSB 2,5 BU	3244025	222
FTP-2/24	3001703	624	FUSE 10,3X85 6A PV	3062768	505	HV M8/1-VS 3	3049372	395	MSB 2,5-F	3244041	223
FTP-2/25	3001704	624	FUSE 10,3X85 8A PV	3062769	505	HV M8/2	3049550	395	MSB 2,5-F BU	3244054	223
FTP-2/4	3001681	624	FWP 10+1	1029716	614				MSB 2,5-M	3244067	223
FTP-2/5	3001683	624	FWP 11+1	1029717	614				MSB 2,5-M BU	3244070	223
FTP-2/6	3001684	624	FWP 12+1	3069307	614				MSB 2,5-NS 35	3244119	223
FTP-2/7	3001685	624	FWP 3+1	3069270	614				MSB 2,5-NS 35 BU	3244122	223
FTP-2/8	3001686	624	FWP 4+1	3069271	614				MSB 2,5-NS 35-PE	3244148	223
FTP-2/9	3001687	624	FWP 5+1	3069272	614				MSB 2,5-PE	3244151	222
FTP-2/A14	3069487	631	FWP 6+1	3069284	614	IS-K 4	1302338	459	MSB 2,5-RZ	3244164	224
FTP-2/A7	3069484	631	FWP 7+1	3069298	614	IS-K 10	1303337	460	MSB 2,5-RZ BU	3244177	224
FTP-2/B14	3069488	631	FWP 8+1	3069297	614	ISH 1,5/0,2	3206131	206	MSBV 2,5	3249017	225
FTP-2/B19	3069490	631	FWP 9+1	1029715	614	ISH 1,5/0,5	3031034	206	MSBV 2,5 BU	3249020	225
FTP-2/B7	3069485	631									
FTP-2/C14	3069489	631									
FTP-2/C19	3069491	631									
FTP-2/D19	3069492	631	G								
FTP-2/E7	3069486	631	G 5/ 2	2716020	577	ISH 2,5/0,2	3002843	70	MSBV 2,5-M	3249062	226
FTP-2/F19	3069493	631	G 5/ 2 B	2716305	577	ISH 2,5/0,5	3002856	70	MSBV 2,5-M BU	3249075	226
FTP-2/G19	3069494	631	G 5/ 3	2716033	577	ISH 2,5/1,0	3002869	70	MSBV 2,5-NS 35	3249088	225
FTP-2/H19	3069495	631	G 5/ 4	2716046	577	ISH 4/0,5	3002885	98	MSBV 2,5-NS 35 BU	3249091	225
FTP-2/I19	3069496	631	G 5/ 6	2716062	577						
FTP-3/10S	3069955	637	G 5/12	2716127	577	ISH 4/1,0	3002898	98	MSDB 2,5	3244216	222
FTP-3/11S	3069970	637	G 10/ 2	2716703	577	ISSBI 10- 6	0301505	459	MSDB 2,5 BU	3244229	222
FTP-3/12S	3069956	637	G 10/ 3	2716716	577	ISSBI 10- 8	0301534	460	MSDB 2,5-F	3244232	224
						ISSBI 10-10	0301521	474	MSDB 2,5-F BU	3244245	224
									MSDB 2,5-M	3244258	224
									MSDB 2,5-M BU	3244261	224
									MSDB 2,5-NS 35	3244300	223
									MSDB 2,5-NS 35 BU	3244313	223

Index

Alphabetical

Type	Order No.	Page	Type	Order No.	Page	Type	Order No.	Page	Type	Order No.	Page
MSDB 2,5-RZ	3244339	224	P-FU 5X20 LA 250-EX	3036836	163	PH 2,5/15	3209811	366	PP-H 2,5/1-M	3210091	299
MSDB 2,5-RZ BU	3244342	224	P-FU 5X20 LED 24	3036819	414	PH 4/10	3000743	366	PP-H 2,5/1-M BU	3210101	299
MSDBV 2,5	3249143	225	P-FU 5X20 LED 24-5	3209248	414	PH 4/2	3000734	366	PP-H 2,5/1-M GNYE	3210114	299
MSDBV 2,5 BU	3249156	225	P-FU 5X20 LED 24-EX	3036821	163	PH 4/3	3000736	366	PP-H 2,5/1-R	3210127	299
MSDBV 2,5-M	3249198	226	P-FU 5X20 LED 250-5	3209264	414	PH 4/4	3000737	366	PP-H 2,5/1-R BU	3210130	299
MSDBV 2,5-M BU	3249208	226	P-FU 5X20 LED 60	3036822	414	PH 4/5	3000738	366	PP-H 2,5/1-R GNYE	3210143	299
MSDBV 2,5-NS 35	3249211	225	P-FU 5X20 LED 60-5	3209251	414	PH 4/6	3000739	366	PP-H 2,5/10	3209950	298
MSDBV 2,5-NS 35 BU	3249224	225	P-FU 5X20 LED 60-EX	3036823	163	PH 4/7	3000740	366	PP-H 2,5/11	3209963	298
MSLKG 6	1410505	559	P-FU 5X20-5	3209235	414	PH 4/8	3000741	366	PP-H 2,5/12	3209976	298
MT 1,5	3100305	553	P-FU 5X20-EX	3036807	163	PH 4/9	3000742	366	PP-H 2,5/13	3209989	298
MT 1,5 BU	3003363	553	P-FU 6,3X32	3046498	414	PH 6/2	3000680	366	PP-H 2,5/14	3209992	298
MT 1,5-PE	3100318	556	P-FU 6,3X32 LA 250	3046524	414	PH 6/3	3000681	366	PP-H 2,5/15	3210004	298
MT 1,5-QUATTRO	3001679	554	P-FU 6,3X32 LA 250-EX	3046525	174	PH 6/4	3000682	366	PP-H 4/ 1	3212010	327
MT 1,5-QUATTRO BU	3025150	554	P-FU 6,3X32 LED 24	3046508	414	PH 6/5	3000683	366	PP-H 4/ 1 BU	3212077	327
MT 1,5-QUATTRO-PE	3001695	557	P-FU 6,3X32 LED 24-EX	3046509	174	PH 6/6	3000684	366	PP-H 4/ 1 GNYE	3212088	327
MT 1,5-TWIN	3001682	554	P-FU 6,3X32 LED 60	3046511	414	PH 6/7	3000685	366	PP-H 4/ 1-L	3211948	327
MT 1,5-TWIN BU	3025532	554	P-FU 6,3X32 LED 60-EX	3046512	174	PP 2,5/ 1	3211280	300	PP-H 4/ 1-L BU	3211951	327
MT 1,5-TWIN-PE	3001705	557	P-FU 6,3X32-EX	3046499	174	PP 2,5/ 1-L	3211271	301	PP-H 4/ 1-L GNYE	3211958	327
MTK	3101016	512	PAI-4	3030925	412	PP 2,5/ 1-L BU	3211272	301	PP-H 4/ 1-M	3211965	327
MTK BU	3101197	512	PAI-4-FIX BK	3032774	116	PP 2,5/ 1-L GNYE	3211273	301	PP-H 4/ 1-M BU	3211964	327
MTK-P/P	3104013	512	PAI-4-FIX BN	3032787	116	PP 2,5/ 1-M	3211274	301	PP-H 4/ 1-M GNYE	3211971	327
MTK-P/P BU	3104097	512	PAI-4-FIX BU	3032729	116	PP 2,5/ 1-M BU	3211275	301	PP-H 4/ 1-R	3211977	327
MTKD	3100017	513	PAI-4-FIX GN	3032758	116	PP 2,5/ 1-M GNYE	3211276	301	PP-H 4/ 1-R BU	3211980	327
MTKD-CU/CUNI	3100059	532	PAI-4-FIX GY	3032790	116	PP 2,5/ 1-R	3211277	301	PP-H 4/ 1-R GNYE	3211987	327
MTKD-E-CU/A-CU	3100091	532	PAI-4-FIX OG	3034455	116	PP 2,5/ 1-R BU	3211278	301	PP-H 4/ 2	3212016	327
MTKD-FE/CUNI	3100046	532	PAI-4-FIX RD	3032732	116	PP 2,5/ 1-R GNYE	3211279	301	PP-H 4/ 3	3212022	327
MTKD-NICR/CUNI	3100075	532	PAI-4-FIX VT	3032761	116	PP 2,5/ 2	3211281	300	PP-H 4/ 4	3212029	327
MTKD-NICR/NI	3100062	532	PAI-4-FIX WH	3032797	116	PP 2,5/ 3	3211282	300	PP-H 4/ 5	3212035	327
MTKD-NICRS/INISI	5043321	532	PAI-4-FIX YE	3032745	116	PP 2,5/ 4	3211283	300	PP-H 4/ 6	3212041	327
MTKD-P/P	3100020	513	PAI-4-FIX-5/6 BK	3035980	105	PP 2,5/ 5	3211284	300	PP-H 4/ 7	3212048	327
MTKD-S-CU/E-CU	3100101	532	PAI-4-FIX-5/6 BN	3035981	105	PP 2,5/ 6	3211285	300	PP-H 4/ 8	3212054	327
MTTB 1,5	1414129	555	PAI-4-FIX-5/6 BU	3035975	105	PP 2,5/ 7	3211286	300	PP-H 4/ 9	3212061	327
MTTB 1,5 BU	3000926	555	PAI-4-FIX-5/6 GN	3035978	105	PP 2,5/ 8	3211287	300	PP-H 4/10	3212067	327
MUT 2,5	3248030	157	PAI-4-FIX-5/6 GY	3035982	105	PP 2,5/ 9	3211288	300	PP-H 4/11	3212074	327
MUT 2,5 BU	3248031	157	PAI-4-FIX-5/6 OG	3035974	105	PP 2,5/10	3211289	300	PP-H 4/12	3212080	327
MUT 2,5-PE	3248032	157	PAI-4-FIX-5/6 RD	3035976	105	PP 2,5/11	3211290	300	PP-H 4/13	3212087	327
MUT 4	3248035	171	PAI-4-FIX-5/6 VT	3035979	105	PP 2,5/12	3211291	300	PP-H 4/14	3212093	327
MUT 4 BU	3248036	171	PAI-4-FIX-5/6 WH	3035983	105	PP 2,5/13	3211292	300	PP-H 4/15	3212100	327
MUT 4-PE	3248037	171	PAI-4-FIX-5/6 YE	3035977	105	PP 2,5/14	3211293	300	PP-H 6/ 1	3061541	352
			PAI-4-N GY	3032871	70	PP 2,5/15	3211294	300	PP-H 6/ 1 BU	3061554	352
			PAI-ST 35/1000MM	3029994	134	PP-H 1,5/S/1	3212484	284	PP-H 6/ 1 GNYE	3061567	352
			PAIS-4-FIX BK	3032792	413	PP-H 1,5/S/1 BU	3212497	284	PP-H 6/ 1-L	3061664	352
			PAIS-4-FIX BU	3032798	413	PP-H 1,5/S/1 GNYE	3212507	284	PP-H 6/ 1-L BU	3061677	352
			PAIS-4-FIX GN	3032801	413	PP-H 1,5/S/1-L	3212659	285	PP-H 6/ 1-L GNYE	3061680	352
NLS-CU 3/10 SN 1000MM	0402174	596	PAIS-4-FIX GY	3032791	413	PP-H 1,5/S/1-L BU	3212662	285	PP-H 6/ 1-M	3061693	352
NLS-CU 6/ 6 SN 1000MM	0402161	603	PAIS-4-FIX RD	3032793	413	PP-H 1,5/S/1-L GNYE	3212675	285	PP-H 6/ 1-M BU	3061703	352
			PAIS-4-FIX VT	3032802	413	PP-H 1,5/S/1-M	3212688	285	PP-H 6/ 1-M GNYE	3061716	352
			PAIS-4-FIX YE	3032799	413	PP-H 1,5/S/1-M BU	3212691	285	PP-H 6/ 1-R	3061729	352
			PC	3040588	276	PP-H 1,5/S/1-M GNYE	3212701	285	PP-H 6/ 1-R BU	3061732	352
			PC-CT 6/2	3212308	332	PP-H 1,5/S/1-R	3212714	285	PP-H 6/ 1-R GNYE	3061745	352
			PC-FTP-TRI	3069898	627	PP-H 1,5/S/1-R BU	3212727	285	PP-H 6/ 2	3061570	352
			PC-UTWE-TRI	3069897	627	PP-H 1,5/S/1-R GNYE	3212730	285	PP-H 6/ 3	3061583	352
OTTA 2,5	0790530	563	PDZ/2	3040562	362	PP-H 1,5/S/10	3212594	284	PP-H 6/ 4	3061596	352
OTTA 2,5-P/P	0790543	563	PDZ/4	3040575	362	PP-H 1,5/S/11	3212604	284	PP-H 6/ 5	3061606	352
OTTA 2,5-PE	0790556	563	PH 1,5/S/10	3212824	366	PP-H 1,5/S/12	3212617	284	PP-H 6/ 6	3061619	352
OTTA 6	0790433	564	PH 1,5/S/11	3212837	366	PP-H 1,5/S/13	3212620	284	PP-H 6/ 7	3061622	352
OTTA 6-P/P	0790404	564	PH 1,5/S/12	3212840	366	PP-H 1,5/S/14	3212633	284	PP-H 6/ 8	3061635	352
OTTA 6-PE	0790527	565	PH 1,5/S/13	3212853	366	PP-H 1,5/S/15	3212646	284	PP-H 6/ 9	3061648	352
OTTA 6-T	0790446	566	PH 1,5/S/14	3212866	366	PP-H 1,5/S/2	3212510	284	PP-H 6/10	3061651	352
OTTA 6-T-P/P	0790462	567	PH 1,5/S/15	3212879	366	PP-H 1,5/S/3	3212523	284	PPC 1,5/S-NS/1-L	3213700	283
OTTA 25-M5	0790488	565	PH 1,5/S/3	3212756	366	PP-H 1,5/S/4	3212536	284	PPC 1,5/S/ 2	3213386	282
OTTA 25-M6	0790491	565	PH 1,5/S/4	3212769	366	PP-H 1,5/S/5	3212549	284	PPC 1,5/S/ 3	3213399	282
OTTA 6-T/SB-P/P	3001269	567	PH 1,5/S/5	3212772	366	PP-H 1,5/S/6	3212552	284	PPC 1,5/S/ 4	3213409	282
OTTAD 6/SB-P/P	1033182	567	PH 1,5/S/6	3212785	366	PP-H 1,5/S/7	3212565	284	PPC 1,5/S/ 5	3213412	282
			PH 1,5/S/7	3212798	366	PP-H 1,5/S/8	3212578	284	PPC 1,5/S/ 6	3213425	282
			PH 1,5/S/8	3212808	366	PP-H 1,5/S/9	3212581	284	PPC 1,5/S/ 7	3213438	282
			PH 1,5/S/9	3212811	366	PP-H 2,5/ 1	3209866	298	PPC 1,5/S/ 8	3213441	282
			PH 2,5/ 2	3209691	366	PP-H 2,5/ 1 BU	3210017	298	PPC 1,5/S/ 9	3213454	282
P-CO	3036796	416	PH 2,5/ 3	3209701	366	PP-H 2,5/ 1 GNYE	3210020	298	PPC 1,5/S/1-L	3213357	282
P-CO 1N4007/L-R	3032460	416	PH 2,5/ 4	3209714	366	PP-H 2,5/ 2	3209879	298	PPC 1,5/S/1-L BU	3213360	282
P-CO 1N4007/R-L	3032457	416	PH 2,5/ 5	3209727	366	PP-H 2,5/ 3	3209882	298	PPC 1,5/S/1-L GNYE	3213373	282
P-CO XL	3036797	417	PH 2,5/ 6	3209730	366	PP-H 2,5/ 4	3209895	298	PPC 1,5/S/10	3213467	282
P-CO XL SKN	3036798	417	PH 2,5/ 7	3209743	366	PP-H 2,5/ 5	3209905	298	PPC 1,5/S/11	3213470	282
P-CO XL-UT	3036799	417	PH 2,5/ 8	3209756	366	PP-H 2,5/ 6	3209918	298	PPC 1,5/S/12	3213483	282
P-DI	3036783	415	PH 2,5/ 9	3209507	366	PP-H 2,5/ 7	3209921	298	PPC 1,5/S/13	3213496	282
P-DI HV	1028594	114	PH 2,5/10	3209769	366	PP-H 2,5/ 8	3209934	298	PPC 1,5/S/14	3213506	282
P-DI-MP HV	1028600	114	PH 2,5/11	3209772	366	PP-H 2,5/ 9	3209947	298	PPC 1,5/S/15	3213519	282
P-FIX	3038956	416	PH 2,5/12	3209785	366	PP-H 2,5/1-L	3210062	299	PPC 2,5-NS/1-L	3000652	296
P-FU 5X20	3036806	414	PH 2,5/13	3209798	366	PP-H 2,5/1-L BU	3210075	299	PPC 2,5/1-L	3000653	295
P-FU 5X20 LA 250	3036835	414	PH 2,5/14	3209808	366	PP-H 2,5/1-L GNYE	3210088	299	PPC 2,5/1-L BU	3000654	295

Alphabetical

Type	Order No.	Page	Type	Order No.	Page	Type	Order No.	Page	Type	Order No.	Page
PPC 2,5/1-L GNVE	3000655	295	PSBJ 4/15/6 YE	0303367	586	PT 1,5/S/1P	3208582	277	PT 2,5/S-QUATTRO-PE	3211025	71
PPC 2,5/10	3000664	295	PSBJ 4/41/8 GY	3206186	587	PT 1,5/S/1P BU	3208595	277	PT 2X10/9X4	3002369	123
PPC 2,5/11	3000665	295	PSBJ 4/51/8 GY	3206173	587	PT 1,5/S/1P-PE	3212332	277	PT 2X10/9X4 BU	3002368	123
PPC 2,5/12	3000666	295	PSBJ 6-T BK	3070318	589	PT 1,5/S/2P	3213784	278	PT 4	3211757	99
PPC 2,5/13	3000667	295	PSBJ 6-T BN	3070317	589	PT 1,5/S/2P BU	3213797	278	PT 4 BU	3211760	99
PPC 2,5/14	3000668	295	PSBJ 6-T BU	3070329	589	PT 1,5/S/2P-PE	3213810	278	PT 4-FSI/F	3208943	102
PPC 2,5/15	3000669	295	PSBJ 6-T GN	3070327	589	PT 10	3212120	121	PT 4-FSI/F-LED 12	3208951	102
PPC 2,5/2	3000656	295	PSBJ 6-T GY	3070316	589	PT 10 BU	3212123	121	PT 4-FSI/F-LED 24	3208964	102
PPC 2,5/3	3000657	295	PSBJ 6-T OG	3070320	117	PT 10,3-HESI 1000V	3062142	122	PT 4-HESI (5X20)	3211861	101
PPC 2,5/4	3000658	295	PSBJ 6-T RD	3070319	589	PT 10,3-HESI/LED 1000V	3062143	122	PT 4-HESI/LED 250 (5X20)	3211907	101
PPC 2,5/5	3000659	295	PSBJ 6-T VT	3070328	589	PT 10-PE	3212131	121	PT 4-HESI/LED 24 (5X20)	3211903	101
PPC 2,5/6	3000660	295				PT 10-TWIN	3208746	121	PT 4-HESI/LED 60 (5X20)	3207908	101
PPC 2,5/7	3000661	295	PSBJ 6-T YE	3070326	589	PT 10-TWIN BU	3208747	121	PT 4-L	3002616	100
PPC 2,5/8	3000662	295	PSBJ-GSK/S BK	0305381	517	PT 10-TWIN-PE	3208745	121	PT 4-L/HESI (5X20)	3002608	102
PPC 2,5/9	3000663	295	PSBJ-GSK/S BU	0305336	517	PT 16 N	3212138	125	PT 4-L/HESI/LED 24 (5X20)	3002609	102
PPC 6-NS/1-L	3000689	351	PSBJ-GSK/S FARBLOS	0305394	517	PT 16 N BU	3212142	125	PT 4-L/HESI/LED 250 (5X20)	3002612	102
PPC 6/1-L	3000690	350	PSBJ-GSK/S GN	0305352	517	PT 16 N-PE	3212147	125	PT 4-L/HESI/LED 60 (5X20)	3002611	102
PPC 6/1-L BU	3000691	350	PSBJ-GSK/S GY	0305378	517	PT 16-TWIN N	3208760	125	PT 4-L	3002615	100
PPC 6/1-L GNVE	3000692	350	PSBJ-GSK/S RD	0305323	517	PT 16-TWIN N BU	3208773	125	PT 4-MT	3211933	103
PPC 6/10	3000702	350	PSBJ-GSK/S VT	0305365	517	PT 16-TWIN N-PE	3208786	125	PT 4-MT BU	3211934	103
PPC 6/2	3000693	350	PSBJ-GSK/S WH	0305310	517	PT 2,5	3209510	71	PT 4-PE	3211766	99
PPC 6/3	3000694	350	PSBJ-GSK/S YE	0305349	517	PT 2,5 BU	3209523	71	PT 4-PE/3L	3210442	100
PPC 6/4	3000695	350	PSBJ-GSK/S-N BU	3032894	588	PT 2,5-3L	3210499	73	PT 4-PE/L/HESI (5X20)	3002602	102
PPC 6/5	3000697	350	PSBJ-GSK/S-N GN	3032892	588	PT 2,5-3L BU	3210509	73	PT 4-PE/L/HESI/LED 24 (5X20)	3002603	102
PPC 6/6	3000698	350	PSBJ-GSK/S-N OG	3032890	588	PT 2,5-3PE	3210525	73	PT 4-PE/L/HESI/LED 250 (5X20)	3002605	102
PPC 6/7	3000699	350	PSBJ-GSK/S-N VT	3032893	588	PT 2,5-3PV	3210512	73	PT 4-PE/L/HESI/LED 60 (5X20)	3002604	102
PPC 6/8	3000700	350	PSBJ-GSK/S-N YE	3032891	588	PT 2,5-4L/1P	3012300	294	PT 4-PE/L/L	3002613	100
PPC 6/9	3000701	350	PSBJ-URTK 6 BK	3026447	587	PT 2,5-4L/1P-F	3012326	294	PT 4-PE/L/MT	3002617	104
PPCT 6/2	3212304	348	PSBJ-URTK 6 BN	3026971	587	PT 2,5-4L/1P-FS	3012302	294	PT 4-PE/L/N	3002614	100
PPCT 6/3	3212305	348	PSBJ-URTK 6 BU	3026434	587	PT 2,5-4L/2P	3012310	294	PT 4-PE/L/TG	3002618	104
PR	3040559	363	PSBJ-URTK 6 FARBLOS	3026450	587	PT 2,5-4L/2P-FS	3012312	294	PT 4-QUATTRO	3211797	99
PR 1,5/S	3212882	363	PSBJ-URTK 6 GN	3026418	587	PT 2,5-DIO/L-R	3210224	81	PT 4-QUATTRO BU	3211802	99
PR 1,5/S/2	3212895	363	PSBJ-URTK 6 GY	3026612	587	PT 2,5-DIO/R-L	3210237	81	PT 4-QUATTRO-DIO 1N 5408/L-R	3211919	104
PR/2	3040630	363	PSBJ-URTK 6 RD	3026719	587	PT 2,5-HEXA/3P	3040044	291	PT 4-QUATTRO-DIO 1N 5408/R-L	3211921	104
PROJECT COMPLETE	1050453	667	PSBJ-URTK 6 VT	3026421	587	PT 2,5-HEXA/3P BU	3040048	291	PT 4-QUATTRO-PE	3211809	99
PRT/2	3040631	363	PSBJ-URTK 6 WH	3026448	617	PT 2,5-HEXA/3P-PE	3040052	291	PT 4-QUATTRO/2P	3211991	325
PRV/2	3041862	363	PSBJ-URTK 6 YE	3026405	587	PT 2,5-MT	3210156	78	PT 4-QUATTRO/2P BU	3212000	325
PRZ	3040614	363	PSBJ-URTK/S BK	0311728	587	PT 2,5-MT BU	3211650	78	PT 4-QUATTRO/2P-PE	3211999	325
PRZ 1,5/S	3212905	363	PSBJ-URTK/S BU	0311757	587	PT 2,5-MTB	3210157	78	PT 4-TG	3211922	103
PS 6-CT-SD	3246857	527	PSBJ-URTK/S GN	0311760	587	PT 2,5-MTB BU	3210163	78	PT 4-TWIN	3211771	99
PS 6-DI-SD	3246856	527	PSBJ-URTK/S RD	0311744	587	PT 2,5-PE	3209536	71	PT 4-TWIN BU	3211775	99
PS 6-VT-SD	3246858	527	PSBJ-URTK/S VT	0311773	587	PT 2,5-PE/3L	3210542	73	PT 4-TWIN-PE	3211780	99
PS-3,5	3031010	38	PSBJ-URTK/S YE	0311731	587	PT 2,5-PE/3L/2P	3012316	294	PT 4-TWIN/1P	3212200	325
PS-3,5/E	3031012	411	PSH 3-6	3040591	364	PT 2,5-PE/L/L	3210541	73	PT 4-TWIN/1P BU	3212201	325
PS-4	3030970	206	PSH 3-6 500MM	3061525	364	PT 2,5-PE/L/N	3210538	73	PT 4-TWIN/1P-PE	3212202	325
PS-4/E	3036709	411	PSH 5-10	3040601	364	PT 2,5-QUATTRO	3209578	71	PT 4-WE	3044900	653
PS-5	3030983	70	PT 1,5/S	3208100	39	PT 2,5-QUATTRO BU	3209581	71	PT 4-WE/1	3044906	653
PS-5/2,3MM RD	3038723	410	PT 1,5/S BU	3208126	39	PT 2,5-QUATTRO-DIO/L-R	3210266	81	PT 4-WE/10	3044915	653
PS-6	3030996	98	PT 1,5/S-3L	3213713	40	PT 2,5-QUATTRO-DIO/R-L	3210279	81	PT 4-WE/11	3044916	653
PS-6/2,3MM RD	3038736	410	PT 1,5/S-3L BU	3213726	40	PT 2,5-QUATTRO-MT	3210172	79	PT 4-WE/12	3044917	653
PS-7,5/2,3MM RD	3038749	591	PT 1,5/S-3PE	3213739	40	PT 2,5-QUATTRO-MT BU	3211676	79	PT 4-WE/13	3044918	653
PS-8	3031005	110	PT 1,5/S-3PV	3213742	40	PT 2,5-QUATTRO-MTB	3210184	79	PT 4-WE/14	3044919	653
PS-8/2,3MM RD	3048564	410	PT 1,5/S-MT	3210301	42	PT 2,5-QUATTRO-MTB BU	3210191	79	PT 4-WE/15	3044920	653
PS-UK 2,5 B/E	3001132	410	PT 1,5/S-MT BU	3210302	42	PT 2,5-QUATTRO-PE	3209594	71	PT 4-WE/16	3044921	653
PS-UK 2,5 B/Z-5	3001226	410	PT 1,5/S-MTD	3210308	42	PT 2,5-QUATTRO-TG	3210208	76	PT 4-WE/17	3044922	653
PS-UK 2,5 B/Z-6	3001239	410	PT 1,5/S-MTD BU	3210309	42	PT 2,5-QUATTRO-TGB	3210194	76	PT 4-WE/18	3044923	653
PS-UKK 3	3000638	411	PT 1,5/S-PE	3208139	39	PT 2,5-QUATTRO/2P	3209662	291	PT 4-WE/19	3044924	653
PS-UKK 5	3000625	411	PT 1,5/S-PE/L/L	3213768	40	PT 2,5-QUATTRO/2P BU	3209675	291	PT 4-WE/2	3044907	653
PS-UKK/E	3000641	411	PT 1,5/S-PE/L/N	3213755	40	PT 2,5-QUATTRO/2P-PE	3209688	291	PT 4-WE/20	3044925	653
PSB 3/10/4	0601292	590	PT 1,5/S-QUATTRO	3208197	39	PT 2,5-TG	3210185	74	PT 4-WE/3	3044908	653
PSB 4/7/6	0303299	590	PT 1,5/S-QUATTRO BU	3208208	39	PT 2,5-TGB	3210192	74	PT 4-WE/4	3044909	653
PSB 6/5/6	0205290	590	PT 1,5/S-QUATTRO-MT	3210321	43	PT 2,5-TWIN	3209549	71	PT 4-WE/5	3044910	653
PSBJ 3,5/18/6 BK	0311388	586	PT 1,5/S-QUATTRO-MT BU	3210322	43	PT 2,5-TWIN BU	3209552	71	PT 4-WE/6	3044911	653
PSBJ 3,5/18/6 BU	0311333	586	PT 1,5/S-QUATTRO-MTD	3210328	43	PT 2,5-TWIN-DIO/L-R	3210240	81	PT 4-WE/7	3044912	653
PSBJ 3,5/18/6 FARBLOS	0311391	586	PT 1,5/S-QUATTRO-MTD BU	3210329	43	PT 2,5-TWIN-DIO/R-L	3210253	81	PT 4-WE/8	3044913	653
PSBJ 3,5/18/6 GN	0311359	586	PT 1,5/S-QUATTRO-PE	3208333	39	PT 2,5-TWIN-MT	3210169	79	PT 4-WE/9	3044914	653
PSBJ 3,5/18/6 GY	0311375	586	PT 1,5/S-QUATTRO-U	3208359	39	PT 2,5-TWIN-MT BU	3211663	79	PT 4/1P	3211937	325
PSBJ 3,5/18/6 RD	0311320	586	PT 1,5/S-QUATTRO/2P	3212390	277	PT 2,5-TWIN-MTB	3210170	79	PT 4/1P BU	3212007	325
PSBJ 3,5/18/6 VT	0311362	586	PT 1,5/S-QUATTRO/2P BU	3212400	277	PT 2,5-TWIN-MTB BU	3210177	79	PT 4/1P-PE	3211942	325
PSBJ 3,5/18/6 WH	0311317	586	PT 1,5/S-QUATTRO/2P-PE	3212413	277	PT 2,5-TWIN-PE	3209565	71	PT 6	3211813	111
PSBJ 3,5/18/6 YE	0311346	586	PT 1,5/S-TWIN	3208155	39	PT 2,5-TWIN-TG	3210198	75	PT 6 BU	3211819	111
PSBJ 3/13/4	0201304	586	PT 1,5/S-TWIN BU	3208168	39	PT 2,5-TWIN-TGB	3210193	75	PT 6-DREHSI (5X20)	3025042	113
PSBJ 3/50/6 GY	3048098	587	PT 1,5/S-TWIN-MT	3210311	42	PT 2,5-TWIN/1P	3209633	291	PT 6-DREHSILA 250 (5X20)	3025044	113
PSBJ 3/52/6 GY	3048085	587	PT 1,5/S-TWIN-MT BU	3210312	42	PT 2,5-TWIN/1P BU	3209646	291	PT 6-DREHSI/LED 24 (5X20)	3025046	113
PSBJ 4/15/6 BK	0303406	586	PT 1,5/S-TWIN-MTD	3210317	42	PT 2,5-TWIN/1P-PE	3209659	291	PT 6-FSI/C	3212166	112
PSBJ 4/15/6 BU	0303354	586	PT 1,5/S-TWIN-MTD BU	3210319	42	PT 2,5/1P	3210033	291	PT 6-FSI/C-LED 12	3212169	112
PSBJ 4/15/6 FARBLOS	0303419	586	PT 1,5/S-TWIN-PE	3208171	39	PT 2,5/1P BU	3210046	291	PT 6-FSI/C-LED 24	3212172	112
PSBJ 4/15/6 GY	0303396	586	PT 1,5/S-TWIN/1P	3212358	277	PT 2,5/1P-PE	3210059	291	PT 6-FSI/C-LED 48	3212175	112
PSBJ 4/15/6 RD	0303325	586	PT 1,5/S-TWIN/1P BU	3212361	277	PT 2,5/S-QUATTRO	3211019	71	PT 6-HESI (6,3X32)	3211870	112
PSBJ 4/15/6 WH	0303312	586	PT 1,5/S-TWIN/1P-PE	3212374	277	PT 2,5/S-QUATTRO BU					

Index

Alphabetical

Type	Order No.	Page	Type	Order No.	Page	Type	Order No.	Page	Type	Order No.	Page
PT 6-HESILED 250 (6,3X32)	3212133	112	PTFIX 10/12X4-NS35A BK	3273760	453	PTFIX 10/6X4-G RD	3273992	452	PTFIX 12X2,5-G GN	3273424	440
PT 6-HESILED 60 (6,3X32)	3211868	112	PTFIX 10/12X4-NS35A BN	3273756	453	PTFIX 10/6X4-G VT	3274004	452	PTFIX 12X2,5-G GY	3273416	440
PT 6-MT	3212940	113	PTFIX 10/12X4-NS35A BK	3273748	453	PTFIX 10/6X4-G WH	3274000	452	PTFIX 12X2,5-G OG	3273434	440
PT 6-MT-P/P HV	1028591	114	PTFIX 10/12X4-NS35A GN	3273754	453	PTFIX 10/6X4-G YE	3273994	452	PTFIX 12X2,5-G PK	3273433	440
PT 6-PE	3211822	111	PTFIX 10/12X4-NS35A GY	3273746	453	PTFIX 10/6X4-NS35 BK	3273606	453	PTFIX 12X2,5-G RD	3273420	440
PT 6-QUATTRO	3212934	111	PTFIX 10/12X4-NS35A OG	3273764	453	PTFIX 10/6X4-NS35 BN	3273602	453	PTFIX 12X2,5-G VT	3273432	440
PT 6-QUATTRO BU	3212947	111	PTFIX 10/12X4-NS35A PK	3273763	453	PTFIX 10/6X4-NS35 BU	3273594	453	PTFIX 12X2,5-G WH	3273428	440
PT 6-QUATTRO-PE	3212950	111	PTFIX 10/12X4-NS35A RD	3273750	453	PTFIX 10/6X4-NS35 GN	3273600	453	PTFIX 12X2,5-G YE	3273422	440
PT 6-QUATTRO/2P	3061826	347	PTFIX 10/12X4-NS35A VT	3273762	453	PTFIX 10/6X4-NS35 GY	3273592	453	PTFIX 12X2,5-NS15A BK	3274136	441
PT 6-QUATTRO/2P BU	3061839	347	PTFIX 10/12X4-NS35A WH	3273758	453	PTFIX 10/6X4-NS35 OG	3273610	453	PTFIX 12X2,5-NS15A BN	3274132	441
PT 6-QUATTRO/2P-PE	3061842	347	PTFIX 10/12X4-NS35A YE	3273752	453	PTFIX 10/6X4-NS35 PK	3273609	453	PTFIX 12X2,5-NS15A BU	3274124	441
PT 6-T P/P HV	1028589	114	PTFIX 10/12X4-NS35A-FE	3273766	453	PTFIX 10/6X4-NS35 RD	3273596	453	PTFIX 12X2,5-NS15A GN	3274130	441
PT 6-TG	3212163	113	PTFIX 10/18X4 BK	3273914	451	PTFIX 10/6X4-NS35 VT	3273608	453	PTFIX 12X2,5-NS15A GY	3274122	441
PT 6-TWIN	3211929	111	PTFIX 10/18X4 BN	3273910	451	PTFIX 10/6X4-NS35 WH	3273604	453	PTFIX 12X2,5-NS15A OG	3274140	441
PT 6-TWIN BU	3211485	111	PTFIX 10/18X4 BU	3273902	451	PTFIX 10/6X4-NS35 YE	3273598	453	PTFIX 12X2,5-NS15A PK	3274139	441
PT 6-TWIN-PE	3211498	111	PTFIX 10/18X4 GN	3273908	451	PTFIX 10/6X4-NS35-FE	3273612	453	PTFIX 12X2,5-NS15A RD	3274126	441
PT 6/1P	3061758	347	PTFIX 10/18X4 GY	3273900	451	PTFIX 10/6X4-NS35A BK	3273738	453	PTFIX 12X2,5-NS15A VT	3274138	441
PT 6/1P BU	3061761	347	PTFIX 10/18X4 OG	3273918	451	PTFIX 10/6X4-NS35A BN	3273734	453	PTFIX 12X2,5-NS15A WH	3274134	441
PT 6/1P-PE	3061774	347	PTFIX 10/18X4 PK	3273917	451	PTFIX 10/6X4-NS35A BU	3273726	453	PTFIX 12X2,5-NS15A YE	3274128	441
PTB 2,5-PE/LL	3210547	96	PTFIX 10/18X4 RD	3273904	451	PTFIX 10/6X4-NS35A GN	3273732	453	PTFIX 12X2,5-NS15A-FE	3274142	441
PTB 2,5-PE/LMT	3210549	95	PTFIX 10/18X4 VT	3273916	451	PTFIX 10/6X4-NS35A GY	3273724	453	PTFIX 12X2,5-NS35 BK	3273036	441
PTB 2,5-PE/LNTG	3210545	95	PTFIX 10/18X4 WH	3273912	451	PTFIX 10/6X4-NS35A OG	3273742	453	PTFIX 12X2,5-NS35 BN	3273032	441
PTB 2,5-PE/LTG	3210539	95	PTFIX 10/18X4 YE	3273906	451	PTFIX 10/6X4-NS35A PK	3273741	453	PTFIX 12X2,5-NS35 BU	3273024	441
PTC 2,5-MT	3270079	78	PTFIX 10/18X4-FE	3273920	451	PTFIX 10/6X4-NS35A RD	3273728	453	PTFIX 12X2,5-NS35 GN	3273030	441
PTC 2,5-MTD	3270106	74	PTFIX 10/18X4 FE-G	3274052	452	PTFIX 10/6X4-NS35A VT	3273740	453	PTFIX 12X2,5-NS35 GY	3273022	441
PTC 2,5-MTD BU	3270109	74	PTFIX 10/18X4-G BK	3274046	452	PTFIX 10/6X4-NS35A WH	3273736	453	PTFIX 12X2,5-NS35 OG	3273040	441
PTC 2,5-QUATTRO-MT	3270085	80	PTFIX 10/18X4-G BU	3274042	452	PTFIX 10/6X4-NS35A YE	3273730	453	PTFIX 12X2,5-NS35 PK	3273039	441
PTC 2,5-QUATTRO-TG	3270094	76	PTFIX 10/18X4-G GN	3274034	452	PTFIX 10/6X4-NS35A-FE	3273744	453	PTFIX 12X2,5-NS35 RD	3273026	441
PTC 2,5-TG	3270088	74	PTFIX 10/18X4-G GN	3274040	452	PTFIX 12X1,5 BK	3002782	429	PTFIX 12X2,5-NS35 VT	3273038	441
PTC 2,5-TWIN-MT	3270082	78	PTFIX 10/18X4-G GY	3274032	452	PTFIX 12X1,5 BN	3002776	429	PTFIX 12X2,5-NS35 WH	3273034	441
PTC 2,5-TWIN-MTD	3270110	75	PTFIX 10/18X4-G OG	3274050	452	PTFIX 12X1,5 BU	3002763	429	PTFIX 12X2,5-NS35 YE	3273028	441
PTC 2,5-TWIN-TGD BU	3270111	75	PTFIX 10/18X4-G PK	3274049	452	PTFIX 12X1,5 GN	3002772	429	PTFIX 12X2,5-NS35-FE	3273042	441
PTC 2,5-TWIN-TG	3270091	75	PTFIX 10/18X4-G RD	3274036	452	PTFIX 12X1,5 GY	3002758	429	PTFIX 12X2,5-NS35A BK	3273168	441
PTC 4-HESI (5X20)	3270200	101	PTFIX 10/18X4-G VT	3274048	452	PTFIX 12X1,5 OG	3002793	430	PTFIX 12X2,5-NS35A BN	3273164	441
PTC 4-HESILA 250 (5X20)	3270197	101	PTFIX 10/18X4-G WH	3274044	452	PTFIX 12X1,5 PK	3002789	429	PTFIX 12X2,5-NS35A BU	3273156	441
PTC 4-HESILED 24 (5X20)	3270203	101	PTFIX 10/18X4-G YE	3274038	452	PTFIX 12X1,5 RD	3002766	429	PTFIX 12X2,5-NS35A GN	3273162	441
PTC 4-HESILED 60 (5X20)	3270205	101	PTFIX 10/18X4-NS35 BK	3273650	453	PTFIX 12X1,5 VT	3002785	429	PTFIX 12X2,5-NS35A GY	3273154	441
PTFIX 1,5-F	1049503	428	PTFIX 10/18X4-NS35 BN	3273646	453	PTFIX 12X1,5 WH	3002779	429	PTFIX 12X2,5-NS35A OG	3273172	441
PTFIX 1,5-NS15A	1049500	428	PTFIX 10/18X4-NS35 BU	3273638	453	PTFIX 12X1,5 YE	3002769	429	PTFIX 12X2,5-NS35A PK	3273171	441
PTFIX 1,5-NS15A-FIX	1049501	428	PTFIX 10/18X4-NS35 GN	3273644	453	PTFIX 12X1,5 FE	3002796	430	PTFIX 12X2,5-NS35A RD	3273158	441
PTFIX 1,5-NS35	1049497	428	PTFIX 10/18X4-NS35 GY	3273636	453	PTFIX 12X1,5-G BK	3002894	432	PTFIX 12X2,5-NS35A VT	3273170	441
PTFIX 1,5-NS35AD	1049498	428	PTFIX 10/18X4-NS35 OG	3273654	453	PTFIX 12X1,5-G BN	3002888	432	PTFIX 12X2,5-NS35A WH	3273166	441
PTFIX 1,5-NS35AD-FIX	1049499	428	PTFIX 10/18X4-NS35 PK	3273653	453	PTFIX 12X1,5-G BU	3002865	432	PTFIX 12X2,5-NS35A YE	3273160	441
PTFIX 1,5-RZF	1050613	428	PTFIX 10/18X4-NS35 RD	3273640	453	PTFIX 12X1,5-G GN	3002884	432	PTFIX 12X2,5-NS35A-FE	3273174	441
PTFIX 10/12X4 BK	3273892	451	PTFIX 10/18X4-NS35 VT	3273652	453	PTFIX 12X1,5-G GY	3002799	432	PTFIX 12X4 BK	3273826	447
PTFIX 10/12X4 BN	3273888	451	PTFIX 10/18X4-NS35 WH	3273648	453	PTFIX 12X1,5-G OG	3002904	432	PTFIX 12X4 BN	3273822	447
PTFIX 10/12X4 BU	3273880	451	PTFIX 10/18X4-NS35 YE	3273642	453	PTFIX 12X1,5-G PK	3002901	432	PTFIX 12X4 BU	3273814	447
PTFIX 10/12X4 GN	3273886	451	PTFIX 10/18X4-NS35-FE	3273656	453	PTFIX 12X1,5-G RD	3002878	432	PTFIX 12X4 GN	3273820	447
PTFIX 10/12X4 GY	3273878	451	PTFIX 10/18X4-NS35A BK	3273782	453	PTFIX 12X1,5-G VT	3002897	432	PTFIX 12X4 GY	3273812	447
PTFIX 10/12X4 OG	3273896	451	PTFIX 10/18X4-NS35A BN	3273778	453	PTFIX 12X1,5-G WH	3002891	432	PTFIX 12X4 OG	3273830	447
PTFIX 10/12X4 PK	3273895	451	PTFIX 10/18X4-NS35A BU	3273770	453	PTFIX 12X1,5-G YE	3002881	432	PTFIX 12X4 PK	3273829	447
PTFIX 10/12X4 RD	3273882	451	PTFIX 10/18X4-NS35A GN	3273776	453	PTFIX 12X1,5-G FE	3002907	432	PTFIX 12X4 RD	3273816	447
PTFIX 10/12X4 VT	3273894	451	PTFIX 10/18X4-NS35A GY	3273768	453	PTFIX 12X1,5-NS15A BK	3002968	433	PTFIX 12X4 VT	3273828	447
PTFIX 10/12X4 WH	3273890	451	PTFIX 10/18X4-NS35A OG	3273786	453	PTFIX 12X1,5-NS15A BN	3002971	433	PTFIX 12X4 WH	3273824	447
PTFIX 10/12X4 YE	3273884	451	PTFIX 10/18X4-NS35A PK	3273785	453	PTFIX 12X1,5-NS15A BU	3002922	433	PTFIX 12X4 YE	3273818	447
PTFIX 10/12X4-FE	3273898	451	PTFIX 10/18X4-NS35A RD	3273772	453	PTFIX 12X1,5-NS15A GN	3002964	433	PTFIX 12X4-FE	3273832	447
PTFIX 10/12X4-FE-G	3274030	452	PTFIX 10/18X4-NS35A VT	3273784	453	PTFIX 12X1,5-NS15A GY	3002914	433	PTFIX 12X4-FE-G	3273964	448
PTFIX 10/12X4-G BK	3274024	452	PTFIX 10/18X4-NS35A WH	3273780	453	PTFIX 12X1,5-NS15A OG	3002949	433	PTFIX 12X4-G BK	3273958	448
PTFIX 10/12X4-G BN	3274020	452	PTFIX 10/18X4-NS35A YE	3273774	453	PTFIX 12X1,5-NS15A PK	3002977	433	PTFIX 12X4-G BN	3273954	448
PTFIX 10/12X4-G BU	3274012	452	PTFIX 10/18X4-NS35A-FE	3273788	453	PTFIX 12X1,5-NS15A RD	3002931	433	PTFIX 12X4-G BU	3273946	448
PTFIX 10/12X4-G GN	3274018	452	PTFIX 10/6X4 BK	3273870	451	PTFIX 12X1,5-NS15A VT	3002974	433	PTFIX 12X4-G GN	3273952	448
PTFIX 10/12X4-G GY	3274010	452	PTFIX 10/6X4 BN	3273866	451	PTFIX 12X1,5-NS15A WH	3002941	433	PTFIX 12X4-G GY	3273944	448
PTFIX 10/12X4-G OG	3274028	452	PTFIX 10/6X4 BU	3273858	451	PTFIX 12X1,5-NS15A YE	3002958	433	PTFIX 12X4-G OG	3273962	448
PTFIX 10/12X4-G PK	3274027	452	PTFIX 10/6X4 GN	3273864	451	PTFIX 12X1,5-NS15A-FE	3002981	433	PTFIX 12X4-G PK	3273961	448
PTFIX 10/12X4-G RD	3274014	452	PTFIX 10/6X4 GY	3273856	451	PTFIX 12X2,5 BK	3273300	439	PTFIX 12X4-G RD	3273948	448
PTFIX 10/12X4-G VT	3274026	452	PTFIX 10/6X4 OG	3273874	451	PTFIX 12X2,5 BN	3273296	439	PTFIX 12X4-G VT	3273960	448
PTFIX 10/12X4-G WH	3274022	452	PTFIX 10/6X4 PK	3273873	451	PTFIX 12X2,5 BU	3273288	439	PTFIX 12X4-G WH	3273956	448
PTFIX 10/12X4-G YE	3274016	452	PTFIX 10/6X4 RD	3273860	451	PTFIX 12X2,5 GN	3273294	439	PTFIX 12X4-G YE	3273950	448
PTFIX 10/12X4-NS35 BK	3273628	453	PTFIX 10/6X4 VT	3273872	451	PTFIX 12X2,5 GY	3273286	439	PTFIX 12X4-NS35 BK	3273562	449
PTFIX 10/12X4-NS35 BN	3273624	453	PTFIX 10/6X4 WH	3273868	451	PTFIX 12X2,5 OG	3273304	439	PTFIX 12X4-NS35 BN	3273558	449
PTFIX 10/12X4-NS35 BU	3273616	453	PTFIX 10/6X4 YE	3273862	451	PTFIX 12X2,5 PK	3273303	439	PTFIX 12X4-NS35 BU	3273550	449
PTFIX 10/12X4-NS35 GN	3273622	453	PTFIX 10/6X4-FE	3273876	451	PTFIX 12X2,5 RD	3273290	439	PTFIX 12X4-NS35 GN	3273556	449
PTFIX 10/12X4-NS35 GY	3273614	453	PTFIX 10/6X4 FE-G	3274008	452						

Alphabetical

Type	Order No.	Page	Type	Order No.	Page	Type	Order No.	Page	Type	Order No.	Page
PTFIX 12X4-NS35A BK	3273694	449	PTFIX 18X2,5-G RD	3273442	440	PTFIX 18X4-NS35A GY	3273702	449	PTFIX 4/18X1,5 BK	1047424	435
PTFIX 12X4-NS35A BN	3273690	449	PTFIX 18X2,5-G VT	3273454	440	PTFIX 18X4-NS35A OG	3273720	449	PTFIX 4/18X1,5 BN	1047421	435
PTFIX 12X4-NS35A BU	3273682	449	PTFIX 18X2,5-G WH	3273450	440	PTFIX 18X4-NS35A PK	3273719	449	PTFIX 4/18X1,5 BU	1047419	435
PTFIX 12X4-NS35A GN	3273688	449	PTFIX 18X2,5-G YE	3273444	440	PTFIX 18X4-NS35A RD	3273706	449	PTFIX 4/18X1,5 GN	1047422	435
PTFIX 12X4-NS35A GY	3273690	449	PTFIX 18X2,5-NS15A BK	3274158	441	PTFIX 18X4-NS35A VT	3273718	449	PTFIX 4/18X1,5 GY	1047418	435
PTFIX 12X4-NS35A OG	3273698	449	PTFIX 18X2,5-NS15A BN	3274154	441	PTFIX 18X4-NS35A WH	3273714	449	PTFIX 4/18X1,5 OG	1047427	435
PTFIX 12X4-NS35A PK	3273697	449	PTFIX 18X2,5-NS15A BU	3274146	441	PTFIX 18X4-NS35A YE	3273708	449	PTFIX 4/18X1,5 PK	1047428	435
PTFIX 12X4-NS35A RD	3273684	449	PTFIX 18X2,5-NS15A GN	3274152	441	PTFIX 18X4-NS35A-FE	3273722	449	PTFIX 4/18X1,5 RD	1047420	435
PTFIX 12X4-NS35A VT	3273696	449	PTFIX 18X2,5-NS15A GY	3274144	441	PTFIX 2X1,5 BK	1045937	429	PTFIX 4/18X1,5 VT	1047426	435
PTFIX 12X4-NS35A WH	3273692	449	PTFIX 18X2,5-NS15A OG	3274162	441	PTFIX 2X1,5 BN	1045935	429	PTFIX 4/18X1,5 WH	1047425	435
PTFIX 12X4-NS35A YE	3273686	449	PTFIX 18X2,5-NS15A PK	3274161	441	PTFIX 2X1,5 BU	1045925	429	PTFIX 4/18X1,5 YE	1047423	435
PTFIX 12X4-NS35A-FE	3273700	449	PTFIX 18X2,5-NS15A RD	3274148	441	PTFIX 2X1,5 GN	1045932	429	PTFIX 4/18X1,5-FE	1047429	435
PTFIX 18X1,5 BK	3002783	429	PTFIX 18X2,5-NS15A VT	3274160	441	PTFIX 2X1,5 GY	1045923	429	PTFIX 4/18X1,5-G BK	1047436	436
PTFIX 18X1,5 BN	3002777	429	PTFIX 18X2,5-NS15A WH	3274156	441	PTFIX 2X1,5 OG	1045939	430	PTFIX 4/18X1,5-G BN	1047433	436
PTFIX 18X1,5 BU	3002764	429	PTFIX 18X2,5-NS15A YE	3274150	441	PTFIX 2X1,5 PK	1045941	429	PTFIX 4/18X1,5-G BU	1047431	436
PTFIX 18X1,5 GN	3002773	429	PTFIX 18X2,5-NS15A-FE	3274164	441	PTFIX 2X1,5 RD	1045929	429	PTFIX 4/18X1,5-G GN	1047434	436
PTFIX 18X1,5 GY	3002760	429	PTFIX 18X2,5-NS35 BK	3273058	441	PTFIX 2X1,5 VT	1045940	429	PTFIX 4/18X1,5-G GY	1047430	436
PTFIX 18X1,5 OG	3002794	430	PTFIX 18X2,5-NS35 BN	3273054	441	PTFIX 2X1,5 WH	1045936	429	PTFIX 4/18X1,5-G OG	1047439	436
PTFIX 18X1,5 PK	3002790	429	PTFIX 18X2,5-NS35 BU	3273046	441	PTFIX 2X1,5 YE	1045931	429	PTFIX 4/18X1,5-G PK	1047440	436
PTFIX 18X1,5 RD	3002767	429	PTFIX 18X2,5-NS35 GN	3273052	441	PTFIX 2X1,5-FE	1045933	430	PTFIX 4/18X1,5-G RD	1047432	436
PTFIX 18X1,5 VT	3002786	429	PTFIX 18X2,5-NS35 GY	3273044	441	PTFIX 2X2,5 BK	1028074	439	PTFIX 4/18X1,5-G VT	1047438	436
PTFIX 18X1,5 WH	3002780	429	PTFIX 18X2,5-NS35 OG	3273062	441	PTFIX 2X2,5 BN	1028072	439	PTFIX 4/18X1,5-G WH	1047437	436
PTFIX 18X1,5 YE	3002770	429	PTFIX 18X2,5-NS35 PK	3273061	441	PTFIX 2X2,5 BU	1028068	439	PTFIX 4/18X1,5-G YE	1047435	436
PTFIX 18X1,5-FE	3002797	430	PTFIX 18X2,5-NS35 RD	3273048	441	PTFIX 2X2,5 GN	1028071	439	PTFIX 4/18X1,5-G-FE	1047441	436
PTFIX 18X1,5-G BK	3002895	432	PTFIX 18X2,5-NS35 VT	3273060	441	PTFIX 2X2,5 GY	1028067	439	PTFIX 4/18X1,5-NS15A BK	1047448	437
PTFIX 18X1,5-G BN	3002889	432	PTFIX 18X2,5-NS35 WH	3273056	441	PTFIX 2X2,5 OG	1028077	439	PTFIX 4/18X1,5-NS15A BN	1047445	437
PTFIX 18X1,5-G BU	3002876	432	PTFIX 18X2,5-NS35 YE	3273050	441	PTFIX 2X2,5 PK	1028076	439	PTFIX 4/18X1,5-NS15A BU	1047443	437
PTFIX 18X1,5-G GN	3002886	432	PTFIX 18X2,5-NS35-FE	3273064	441	PTFIX 2X2,5 RD	1028069	439	PTFIX 4/18X1,5-NS15A GN	1047446	437
PTFIX 18X1,5-G GY	3002804	432	PTFIX 18X2,5-NS35A BK	3273190	441	PTFIX 2X2,5 VT	1028075	439	PTFIX 4/18X1,5-NS15A GY	1047442	437
PTFIX 18X1,5-G OG	3002905	432	PTFIX 18X2,5-NS35A BN	3273186	441	PTFIX 2X2,5 WH	1028073	439	PTFIX 4/18X1,5-NS15A OG	1047451	437
PTFIX 18X1,5-G PK	3002902	432	PTFIX 18X2,5-NS35A BU	3273178	441	PTFIX 2X2,5 YE	1028070	439	PTFIX 4/18X1,5-NS15A PK	1047452	437
PTFIX 18X1,5-G RD	3002879	432	PTFIX 18X2,5-NS35A GN	3273184	441	PTFIX 2X2,5-FE	1028078	439	PTFIX 4/18X1,5-NS15A RD	1047444	437
PTFIX 18X1,5-G VT	3002899	432	PTFIX 18X2,5-NS35A GY	3273176	441	PTFIX 2X4 BK	1028367	447	PTFIX 4/18X1,5-NS15A VT	1047450	437
PTFIX 18X1,5-G WH	3002892	432	PTFIX 18X2,5-NS35A OG	3273194	441	PTFIX 2X4 BN	1028365	447	PTFIX 4/18X1,5-NS15A WH	1047449	437
PTFIX 18X1,5-G YE	3002882	432	PTFIX 18X2,5-NS35A PK	3273193	441	PTFIX 2X4 BU	1028361	447	PTFIX 4/18X1,5-NS15A YE	1047447	437
PTFIX 18X1,5-G-FE	3002909	432	PTFIX 18X2,5-NS35A RD	3273180	441	PTFIX 2X4 GN	1028364	447	PTFIX 4/18X1,5-NS15A-FE	1047453	437
PTFIX 18X1,5-NS15A BK	3002969	433	PTFIX 18X2,5-NS35A VT	3273192	441	PTFIX 2X4 GY	1028360	447	PTFIX 4/18X1,5-NS35 BK	1047460	437
PTFIX 18X1,5-NS15A BN	3002972	433	PTFIX 18X2,5-NS35A WH	3273188	441	PTFIX 2X4 OG	1028370	447	PTFIX 4/18X1,5-NS35 BN	1047457	437
PTFIX 18X1,5-NS15A BU	3002926	433	PTFIX 18X2,5-NS35A YE	3273182	441	PTFIX 2X4 PK	1028369	447	PTFIX 4/18X1,5-NS35 BU	1047455	437
PTFIX 18X1,5-NS15A GN	3002965	433	PTFIX 18X2,5-NS35A-FE	3273196	441	PTFIX 2X4 RD	1028362	447	PTFIX 4/18X1,5-NS35 GN	1047458	437
PTFIX 18X1,5-NS15A GY	3002917	433	PTFIX 18X4 BK	3273848	447	PTFIX 2X4 VT	1028368	447	PTFIX 4/18X1,5-NS35 GY	1047454	437
PTFIX 18X1,5-NS15A OG	3002952	433	PTFIX 18X4 BN	3273844	447	PTFIX 2X4 WH	1028366	447	PTFIX 4/18X1,5-NS35 OG	1047463	437
PTFIX 18X1,5-NS15A PK	3002978	433	PTFIX 18X4 BU	3273836	447	PTFIX 2X4 YE	1028363	447	PTFIX 4/18X1,5-NS35 PK	1047464	437
PTFIX 18X1,5-NS15A RD	3002934	433	PTFIX 18X4 GN	3273842	447	PTFIX 2X4-FE	1028371	447	PTFIX 4/18X1,5-NS35 RD	1047456	437
PTFIX 18X1,5-NS15A VT	3002975	433	PTFIX 18X4 GY	3273834	447	PTFIX 4/12X1,5 BK	1046967	435	PTFIX 4/18X1,5-NS35 VT	1047462	437
PTFIX 18X1,5-NS15A WH	3002944	433	PTFIX 18X4 OG	3273852	447	PTFIX 4/12X1,5 BN	1046964	435	PTFIX 4/18X1,5-NS35 WH	1047461	437
PTFIX 18X1,5-NS15A YE	3002961	433	PTFIX 18X4 PK	3273851	447	PTFIX 4/12X1,5 BU	1046962	435	PTFIX 4/18X1,5-NS35 YE	1047459	437
PTFIX 18X1,5-NS15A-FE	3002983	433	PTFIX 18X4 RD	3273838	447	PTFIX 4/12X1,5 GN	1046965	435	PTFIX 4/18X1,5-NS35-FE	1047465	437
PTFIX 18X1,5-NS35 BK	1046955	433	PTFIX 18X4 VT	3273850	447	PTFIX 4/12X1,5 GY	1046961	435	PTFIX 4/6X1,5 BK	1047472	435
PTFIX 18X1,5-NS35 BN	1046952	433	PTFIX 18X4 WH	3273846	447	PTFIX 4/12X1,5 OG	1046969	435	PTFIX 4/6X1,5 BN	1047469	435
PTFIX 18X1,5-NS35 BU	1046950	433	PTFIX 18X4 YE	3273840	447	PTFIX 4/12X1,5 PK	1046970	435	PTFIX 4/6X1,5 BU	1047467	435
PTFIX 18X1,5-NS35 GN	1046953	433	PTFIX 18X4-FE	3273854	447	PTFIX 4/12X1,5 RD	1046963	435	PTFIX 4/6X1,5 GN	1047470	435
PTFIX 18X1,5-NS35 GY	1046949	433	PTFIX 18X4-FE-G	3273986	448	PTFIX 4/12X1,5 VT	1046968	435	PTFIX 4/6X1,5 GY	1047466	435
PTFIX 18X1,5-NS35 OG	1046958	433	PTFIX 18X4-G BK	3273980	448	PTFIX 4/12X1,5 WH	1046972	435	PTFIX 4/6X1,5 OG	1047475	435
PTFIX 18X1,5-NS35 PK	1046959	433	PTFIX 18X4-G BN	3273976	448	PTFIX 4/12X1,5 YE	1046966	435	PTFIX 4/6X1,5 PK	1047476	435
PTFIX 18X1,5-NS35 RD	1046951	433	PTFIX 18X4-G BU	3273968	448	PTFIX 4/12X1,5-FE	1046971	435	PTFIX 4/6X1,5 RD	1047468	435
PTFIX 18X1,5-NS35 VT	1046957	433	PTFIX 18X4-G GY	3273974	448	PTFIX 4/12X1,5-G BK	1046979	436	PTFIX 4/6X1,5 VT	1047474	435
PTFIX 18X1,5-NS35 WH	1046956	433	PTFIX 18X4-G GN	3273966	448	PTFIX 4/12X1,5-G BN	1046976	436	PTFIX 4/6X1,5 WH	1047473	435
PTFIX 18X1,5-NS35 YE	1046954	433	PTFIX 18X4-G OG	3273984	448	PTFIX 4/12X1,5-G BU	1046974	436	PTFIX 4/6X1,5 YE	1047471	435
PTFIX 18X1,5-NS35-FE	1046960	433	PTFIX 18X4-G PK	3273983	448	PTFIX 4/12X1,5-G GN	1046977	436	PTFIX 4/6X1,5-FE	1047477	435
PTFIX 18X2,5 BK	3273322	439	PTFIX 18X4-G RD	3273970	448	PTFIX 4/12X1,5-G GY	1046973	436	PTFIX 4/6X1,5-G BK	1047484	436
PTFIX 18X2,5 BN	3273318	439	PTFIX 18X4-G VT	3273982	448	PTFIX 4/12X1,5-G OG	1046982	436	PTFIX 4/6X1,5-G BN	1047481	436
PTFIX 18X2,5 BU	3273310	439	PTFIX 18X4-G WH	3273978	448	PTFIX 4/12X1,5-G PK	1046983	436	PTFIX 4/6X1,5-G BU	1047479	436
PTFIX 18X2,5 GN	3273316	439	PTFIX 18X4-G YE	3273972	448	PTFIX 4/12X1,5-G RD	1046975	436	PTFIX 4/6X1,5-G GN	1047482	436
PTFIX 18X2,5 GY	3273308	439	PTFIX 18X4-NS35 BK	3273584	449	PTFIX 4/12X1,5-G VT	1046981	436	PTFIX 4/6X1,5-G GY	1047478	436
PTFIX 18X2,5 OG	3273326	439	PTFIX 18X4-NS35 BN	3273580	449	PTFIX 4/12X1,5-G WH	1046980	436	PTFIX 4/6X1,5-G OG	1047487	436
PTFIX 18X2,5 PK	3273325	439	PTFIX 18X4-NS35 BU	3273572	449	PTFIX 4/12X1,5-G YE	1046978	436	PTFIX 4/6X1,5-G PK	1047488	436
PTFIX 18X2,5 RD	3273312	439	PTFIX 18X4-NS35 GN	3273578	449	PTFIX 4/12X1,5-G-FE	1046984	436	PTFIX 4/6X1,5-G RD	1047480	436
PTFIX 18X2,5 VT	3273324	439	PTFIX 18X4-NS35 GY	3273570	449	PTFIX 4/12X1,5-NS15A BK	1046991	437	PTFIX 4/6X1,5-G VT	1047486	436
PTFIX 18X2,5 WH	3273320	439	PTFIX 18X4-NS35 OG	3273588	449	PTFIX 4/12X1,5-NS15A BN	1046988	437	PTFIX 4/6X1,5-G WH	1047485	436
PTFIX 18X2,5 YE	3273314	439	PTFIX 18X4-NS35 PK	3273587	449	PTFIX 4/12X1,5-NS15A BU	1046986	437	PTFIX 4/6X1,5-G YE	1047483	436
PTFIX 18X2,5-FE	3273328	439	PTFIX 18X4-NS35 RD	3273574	449	PTFIX 4/12X1,5-NS15A GN	1046989	437	PTFIX 4/6X1,5-G-FE	1047489	436
PTFIX 18X2,5-FE-G	3273458	440	PTFIX 18X4-NS35 VT	3273586	449	PTFIX 4/12X1,5-NS15A GY	1046985	437	PTFIX 4/6X1,5-NS15A BK	1047496	437
PTFIX 18X2,5-G BK	3273452	440	PTFIX 18X4-NS35 WH	3273582	449	PTFIX 4/12X1,5-NS15A OG	1046994	437	PTFIX 4/6X1,5-NS15A BN	1047493	437
PTFIX 18X2,5-G BN	3273448	440	PTFIX 18X4-NS35 YE	3273576	449	PTFIX 4/12X1,5-NS15A PK	1046995	437	PTFIX 4/6X1,5-NS15A BU	1047491	437
PTFIX 18X2,5-G BU	3273440	440	PTFIX 18X4-NS35-FE	3273590	449	PTFIX 4/12X1,5-NS15A RD	1046987	437	PTFIX 4/6X1,5-NS1		

Index

Alphabetical

Type	Order No.	Page	Type	Order No.	Page	Type	Order No.	Page	Type	Order No.	Page
PTFIX 4/6X1,5-NS15A VT	1047498	437	PTFIX 6/18X2,5 BUWH	1091673	443	PTFIX 6/6X2,5-G VT	3273476	444	PTFIX 6X2,5 GY	3273264	439
PTFIX 4/6X1,5-NS15A WH	1047497	437	PTFIX 6/18X2,5 GN	3273382	443	PTFIX 6/6X2,5-G WH	3273472	444	PTFIX 6X2,5 OG	3273282	439
PTFIX 4/6X1,5-NS15A YE	1047495	437	PTFIX 6/18X2,5 GY	3273374	443	PTFIX 6/6X2,5-G YE	3273466	444	PTFIX 6X2,5 PK	3273281	439
PTFIX 4/6X1,5-NS15A-FE	1047501	437	PTFIX 6/18X2,5 OG	3273392	443	PTFIX 6/6X2,5-NS15A BK	3274180	445	PTFIX 6X2,5 RD	3273268	439
PTFIX 4X1,5 BK	1046616	429	PTFIX 6/18X2,5 PK	3273391	443	PTFIX 6/6X2,5-NS15A BN	3274176	445	PTFIX 6X2,5 WH	3273280	439
PTFIX 4X1,5 BN	1046614	429	PTFIX 6/18X2,5 RD	3273378	443	PTFIX 6/6X2,5-NS15A BU	3274168	445	PTFIX 6X2,5 VT	3273276	439
PTFIX 4X1,5 BU	1046610	429	PTFIX 6/18X2,5 VT	3273390	443	PTFIX 6/6X2,5-NS15A GN	3274174	445	PTFIX 6X2,5 YE	3273270	439
PTFIX 4X1,5 GN	1046613	429	PTFIX 6/18X2,5 WH	3273386	443	PTFIX 6/6X2,5-NS15A GY	3274166	445	PTFIX 6X2,5-FE	3273284	439
PTFIX 4X1,5 GY	1046608	429	PTFIX 6/18X2,5 YE	3273380	443	PTFIX 6/6X2,5-NS15A OG	3274184	445	PTFIX 6X2,5-FE-G	3273414	440
PTFIX 4X1,5 OG	1046619	430	PTFIX 6/18X2,5-FE	3273394	443	PTFIX 6/6X2,5-NS15A PK	3274183	445	PTFIX 6X2,5-G BK	3273408	440
PTFIX 4X1,5 PK	1046618	429	PTFIX 6/18X2,5-FE-G	3273524	444	PTFIX 6/6X2,5-NS15A RD	3274170	445	PTFIX 6X2,5-G BN	3273404	440
PTFIX 4X1,5 RD	1046611	429	PTFIX 6/18X2,5-G BK	3273518	444	PTFIX 6/6X2,5-NS15A VT	3274182	445	PTFIX 6X2,5-G BU	3273396	440
PTFIX 4X1,5 VT	1046617	429	PTFIX 6/18X2,5-G BN	3273514	444	PTFIX 6/6X2,5-NS15A WH	3274178	445	PTFIX 6X2,5-G GN	3273402	440
PTFIX 4X1,5 WH	1046615	429	PTFIX 6/18X2,5-G BU	3273506	444	PTFIX 6/6X2,5-NS15A YE	3274172	445	PTFIX 6X2,5-G GY	3273395	440
PTFIX 4X1,5 YE	1046612	429	PTFIX 6/18X2,5-G GN	3273512	444	PTFIX 6/6X2,5-NS15A-FE	3274186	445	PTFIX 6X2,5-G OG	3273412	440
PTFIX 4X1,5-FE	1046620	430	PTFIX 6/18X2,5-G GY	3273504	444	PTFIX 6/6X2,5-NS35 BK	3273080	445	PTFIX 6X2,5-G PK	3273411	440
PTFIX 6/12X2,5 BK	3273366	443	PTFIX 6/18X2,5-G OG	3273522	444	PTFIX 6/6X2,5-NS35 BU	3273076	445	PTFIX 6X2,5-G RD	3273398	440
PTFIX 6/12X2,5 BN	3273362	443	PTFIX 6/18X2,5-G PK	3273521	444	PTFIX 6/6X2,5-NS35 BU	3273068	445	PTFIX 6X2,5-G VT	3273410	440
PTFIX 6/12X2,5 BU	3273354	443	PTFIX 6/18X2,5-G RD	3273508	444	PTFIX 6/6X2,5-NS35 GN	3273074	445	PTFIX 6X2,5-G WH	3273406	440
PTFIX 6/12X2,5 BUWH	1091672	443	PTFIX 6/18X2,5-G WH	3273520	444	PTFIX 6/6X2,5-NS35 GY	3273066	445	PTFIX 6X2,5-G YE	3273400	440
PTFIX 6/12X2,5 GN	3273360	443	PTFIX 6/18X2,5-G WH	3273516	444	PTFIX 6/6X2,5-NS35 OG	3273084	445	PTFIX 6X2,5-NS15A BK	3274114	441
PTFIX 6/12X2,5 GY	3273352	443	PTFIX 6/18X2,5-G YE	3273510	444	PTFIX 6/6X2,5-NS35 BU	3273083	445	PTFIX 6X2,5-NS15A BN	3274110	441
PTFIX 6/12X2,5 OG	3273370	443	PTFIX 6/18X2,5-NS15A BK	3274224	445	PTFIX 6/6X2,5-NS35 RD	3273070	445	PTFIX 6X2,5-NS15A BU	3274102	441
PTFIX 6/12X2,5 PK	3273369	443	PTFIX 6/18X2,5-NS15A BN	3274220	445	PTFIX 6/6X2,5-NS35 VT	3273082	445	PTFIX 6X2,5-NS15A GN	3274108	441
PTFIX 6/12X2,5 RD	3273356	443	PTFIX 6/18X2,5-NS15A PK	3274212	445	PTFIX 6/6X2,5-NS35 WH	3273078	445	PTFIX 6X2,5-NS15A GY	3274100	441
PTFIX 6/12X2,5 VT	3273368	443	PTFIX 6/18X2,5-NS15A GN	3274218	445	PTFIX 6/6X2,5-NS35 YE	3273072	445	PTFIX 6X2,5-NS15A OG	3274118	441
PTFIX 6/12X2,5 WH	3273364	443	PTFIX 6/18X2,5-NS15A GY	3274210	445	PTFIX 6/6X2,5-NS35-FE	3273086	445	PTFIX 6X2,5-NS15A PK	3274117	441
PTFIX 6/12X2,5 YE	3273358	443	PTFIX 6/18X2,5-NS15A OG	3274228	445	PTFIX 6/6X2,5-NS35A BK	3273212	445	PTFIX 6X2,5-NS15A RD	3274104	441
PTFIX 6/12X2,5-FE	3273372	443	PTFIX 6/18X2,5-NS15A PK	3274227	445	PTFIX 6/6X2,5-NS35A BN	3273208	445	PTFIX 6X2,5-NS15A VT	3274116	441
PTFIX 6/12X2,5-FE-G	3273302	444	PTFIX 6/18X2,5-NS15A RD	3274214	445	PTFIX 6/6X2,5-NS35A BU	3273200	445	PTFIX 6X2,5-NS15A WH	3274112	441
PTFIX 6/12X2,5-G BK	3273496	444	PTFIX 6/18X2,5-NS15A VT	3274226	445	PTFIX 6/6X2,5-NS35A GN	3273206	445	PTFIX 6X2,5-NS15A YE	3274106	441
PTFIX 6/12X2,5-G BN	3273492	444	PTFIX 6/18X2,5-NS15A WH	3274222	445	PTFIX 6/6X2,5-NS35A GY	3273198	445	PTFIX 6X2,5-NS15A-FE	3274120	441
PTFIX 6/12X2,5-G BU	3273484	444	PTFIX 6/18X2,5-NS15A YE	3274216	445	PTFIX 6/6X2,5-NS35A OG	3273216	445	PTFIX 6X2,5-NS35 BK	3273014	441
PTFIX 6/12X2,5-G GN	3273490	444	PTFIX 6/18X2,5-NS15A-FE	3274230	445	PTFIX 6/6X2,5-NS35A PK	3273215	445	PTFIX 6X2,5-NS35 BN	3273010	441
PTFIX 6/12X2,5-G GY	3273482	444	PTFIX 6/18X2,5-NS35 BK	3273124	445	PTFIX 6/6X2,5-NS35A RD	3273202	445	PTFIX 6X2,5-NS35 BU	3273002	441
PTFIX 6/12X2,5-G OG	3273500	444	PTFIX 6/18X2,5-NS35 BN	3273120	445	PTFIX 6/6X2,5-NS35A VT	3273214	445	PTFIX 6X2,5-NS35 GN	3273008	441
PTFIX 6/12X2,5-G PK	3273499	444	PTFIX 6/18X2,5-NS35 BU	3273112	445	PTFIX 6/6X2,5-NS35A WH	3273210	445	PTFIX 6X2,5-NS35 GY	3273000	441
PTFIX 6/12X2,5-G RD	3273486	444	PTFIX 6/18X2,5-NS35 GN	3273118	445	PTFIX 6/6X2,5-NS35A YE	3273204	445	PTFIX 6X2,5-NS35 OG	3273018	441
PTFIX 6/12X2,5-G VT	3273498	444	PTFIX 6/18X2,5-NS35 GY	3273110	445	PTFIX 6/6X2,5-NS35A-FE	3273218	445	PTFIX 6X2,5-NS35 PK	3273017	441
PTFIX 6/12X2,5-G WH	3273494	444	PTFIX 6/18X2,5-NS35 OG	3273128	445	PTFIX 6X1,5 BK	3002781	429	PTFIX 6X2,5-NS35 RD	3273004	441
PTFIX 6/12X2,5-G YE	3273488	444	PTFIX 6/18X2,5-NS35 PK	3273127	445	PTFIX 6X1,5 BN	3002774	429	PTFIX 6X2,5-NS35 VT	3273016	441
PTFIX 6/12X2,5-NS15A BK	3274202	445	PTFIX 6/18X2,5-NS35 RD	3273114	445	PTFIX 6X1,5 BU	3002761	429	PTFIX 6X2,5-NS35 WH	3273012	441
PTFIX 6/12X2,5-NS15A BN	3274198	445	PTFIX 6/18X2,5-NS35 VT	3273126	445	PTFIX 6X1,5 GN	3002771	429	PTFIX 6X2,5-NS35 YE	3273006	441
PTFIX 6/12X2,5-NS15A BU	3274190	445	PTFIX 6/18X2,5-NS35 WH	3273122	445	PTFIX 6X1,5 GY	3002757	429	PTFIX 6X2,5-NS35-FE	3273020	441
PTFIX 6/12X2,5-NS15A GN	3274196	445	PTFIX 6/18X2,5-NS35A BU	3273244	445	PTFIX 6X1,5 OG	3002792	430	PTFIX 6X2,5-NS35A BK	3273146	441
PTFIX 6/12X2,5-NS15A GY	3274188	445	PTFIX 6/18X2,5-NS35A RD	3273250	445	PTFIX 6X1,5 PK	3002787	429	PTFIX 6X2,5-NS35A BU	3273142	441
PTFIX 6/12X2,5-NS15A OG	3274206	445	PTFIX 6/18X2,5-NS35A GN	3273242	445	PTFIX 6X1,5 RD	3002765	429	PTFIX 6X2,5-NS35A BN	3273134	441
PTFIX 6/12X2,5-NS15A PK	3274205	445	PTFIX 6/18X2,5-NS35A BK	3273252	445	PTFIX 6X1,5 VT	3002784	429	PTFIX 6X2,5-NS35A GN	3273140	441
PTFIX 6/12X2,5-NS15A RD	3274192	445	PTFIX 6/18X2,5-NS35A BU	3273244	445	PTFIX 6X1,5 WH	3002778	429	PTFIX 6X2,5-NS35A GY	3273132	441
PTFIX 6/12X2,5-NS15A VT	3274204	445	PTFIX 6/18X2,5-NS35A GN	3273250	445	PTFIX 6X1,5 YE	3002768	429	PTFIX 6X2,5-NS35A OG	3273150	441
PTFIX 6/12X2,5-NS15A WH	3274200	445	PTFIX 6/18X2,5-NS35A GY	3273242	445	PTFIX 6X1,5-FE	3002795	430	PTFIX 6X2,5-NS35A PK	3273149	441
PTFIX 6/12X2,5-NS15A YE	3274194	445	PTFIX 6/18X2,5-NS35A OG	3273260	445	PTFIX 6X1,5-G BK	3002893	432	PTFIX 6X2,5-NS35A RD	3273136	441
PTFIX 6/12X2,5-NS15A-FE	3274208	445	PTFIX 6/18X2,5-NS35A PK	3273259	445	PTFIX 6X1,5-G BN	3002887	432	PTFIX 6X2,5-NS35A VT	3273148	441
PTFIX 6/12X2,5-NS35 BK	3273102	445	PTFIX 6/18X2,5-NS35A RD	3273246	445	PTFIX 6X1,5-G BU	3002864	432	PTFIX 6X2,5-NS35A WH	3273144	441
PTFIX 6/12X2,5-NS35 BN	3273098	445	PTFIX 6/18X2,5-NS35A VT	3273258	445	PTFIX 6X1,5-G GN	3002883	432	PTFIX 6X2,5-NS35A YE	3273138	441
PTFIX 6/12X2,5-NS35 BU	3273090	445	PTFIX 6/18X2,5-NS35A WH	3273254	445	PTFIX 6X1,5-G GY	3002798	432	PTFIX 6X2,5-NS35A-FE	3273152	441
PTFIX 6/12X2,5-NS35 GN	3273096	445	PTFIX 6/18X2,5-NS35A YE	3273248	445	PTFIX 6X1,5-G OG	3002903	432	PTFIX 6X4 BK	3273804	447
PTFIX 6/12X2,5-NS35 GY	3273088	445	PTFIX 6/18X2,5-NS35A-FE	3273262	445	PTFIX 6X1,5-G PK	3002900	432	PTFIX 6X4 BN	3273800	447
PTFIX 6/12X2,5-NS35 OG	3273106	445	PTFIX 6/6X2,5 BK	3273344	443	PTFIX 6X1,5-G RD	3002877	432	PTFIX 6X4 BU	3273792	447
PTFIX 6/12X2,5-NS35 PK	3273105	445	PTFIX 6/6X2,5 BN	3273340	443	PTFIX 6X1,5-G VT	3002896	432	PTFIX 6X4 GN	3273798	447
PTFIX 6/12X2,5-NS35 RD	3273092	445	PTFIX 6/6X2,5 BU	3273332	443	PTFIX 6X1,5-G WH	3002890	432	PTFIX 6X4 GY	3273790	447
PTFIX 6/12X2,5-NS35 VT	3273104	445	PTFIX 6/6X2,5 BUWH	1091674	443	PTFIX 6X1,5-G YE	3002880	432	PTFIX 6X4 OG	3273808	447
PTFIX 6/12X2,5-NS35 WH	3273100	445	PTFIX 6/6X2,5 GN	3273338	443	PTFIX 6X1,5-G-FE	3002906	432	PTFIX 6X4 PK	3273807	447
PTFIX 6/12X2,5-NS35 YE	3273094	445	PTFIX 6/6X2,5 GY	3273330	443	PTFIX 6X1,5-NS15A BK	3002967	433	PTFIX 6X4 RD	3273794	447
PTFIX 6/12X2,5-NS35-FE	3273108	445	PTFIX 6/6X2,5 OG	3273348	443	PTFIX 6X1,5-NS15A BN	3002970	433	PTFIX 6X4 VT	3273806	447
PTFIX 6/12X2,5-NS35A BK	3273234	445	PTFIX 6/6X2,5 PK	3273347	443	PTFIX 6X1,5-NS15A BU	3002919	433	PTFIX 6X4 WH	3273802	447
PTFIX 6/12X2,5-NS35A BN	3273230	445	PTFIX 6/6X2,5 RD	3273334	443	PTFIX 6X1,5-NS15A GN	3002963	433	PTFIX 6X4 YE	3273796	447
PTFIX 6/12X2,5-NS35A BU	3273222	445	PTFIX 6/6X2,5 VT	3273346	443	PTFIX 6X1,5-NS15A GY	3002910	433	PTFIX 6X4-FE	3273810	447
PTFIX 6/12X2,5-NS35A GN	3273228	445	PTFIX 6/6X2,5 WH	3273342	443	PTFIX 6X1,5-NS15A OG	3002946	433	PTFIX 6X4-FE-G	3273942	448
PTFIX 6/12X2,5-NS35A GY	3273220	445	PTFIX 6/6X2,5 YE	3273336	443	PTFIX 6X1,5-NS15A PK	3002976	433	PTFIX 6X4-G BK	3273936	448
PTFIX 6/12X2,5-NS35A OG	3273238	445	PTFIX 6/6X2,5-FE	3273350	443	PTFIX 6X1,5-NS15A RD	3002928	433	PTFIX 6X4-G BN	3273932	448
PTFIX 6/12X2,5-NS35A PK	3273237	445	PTFIX 6/6X2,5-FE-G	3273480	444	PTFIX 6X1,5-NS15A VT	3002973	433	PTFIX 6X4-G BU	3273924	448
PTFIX 6/12X2,5-NS35A RD	3273224	445	PTFIX 6/6X2,5-G BK	3273474	444	PTFIX 6X1,5-NS15A WH	3002936	433	PTFIX 6X4-G GN	3273930	448
PTFIX 6/12X2,5-NS35A VT	3273236	445	PTFIX 6/6X2,5-G BU	3273470	444	PTFIX 6X1,5-NS15A YE	3002955	433	PTFIX 6X4-G GY	3273922	448
PTFIX 6/12X2,5-NS35A WH	3273232	445	PTFIX 6/6X2,5-G GN	3273462	444	PTFIX 6X1,5-NS15A-FE	3002980	433	PTFIX 6X4-G OG	3273940	448
PTFIX 6/12X2,5-NS35A YE	3273226	445	PTFIX 6/6X2,5-G BU	3273468	444	PTFIX 6X2,5 BK	3273278	439	PTFIX 6X4-G PK	3273939	448
PTFIX 6/12X2,5-NS35A-FE	3273240	445	PTFIX 6/6X2,5-G GY	3273460	444	PTFIX 6X2,5 BN	3273274	439	PTFIX 6X4-G RD	3273926	448
PTFIX 6/18X2,5 BK	3273388	443	PTFIX 6/6X2,5-G OG	3273478	444	PTFIX 6X2,5 BU	3273266				

Alphabetical

Type	Order No.	Page	Type	Order No.	Page	Type	Order No.	Page	Type	Order No.	Page
PTFIX 6X4-NS35 BK	3273540	449	PTIO 1,5/S/5/U-BK/O-WH	3244472	42	PTMC 1,5/80-3 /BU	3270326	59	PTPOWER 95-3L/N/FE-F	3260130	139
PTFIX 6X4-NS35 BN	3273536	449	PTIO-IN 2,5/3 OG	3244559	41	PTMC 1,5/80-3 /BU 19Z	3270327	63	PTPOWER 95-F	3260133	139
PTFIX 6X4-NS35 BU	3273528	449	PTIO-IN 2,5/4-PE OG	3244481	41	PTMC 1,5/80-3 19Z	3270325	63	PTPOWER 95-F BU	3260136	139
PTFIX 6X4-NS35 GN	3273534	449	PTMC 1,5/1-2 -DF	3001937	68	PTME 4	3212139	105	PTPOWER 95-FE	3260139	139
PTFIX 6X4-NS35 GY	3273526	449	PTMC 1,5/1-2 -NS	3001915	68	PTME 6	3212170	116	PTPOWER 95-FE-F	3260142	139
PTFIX 6X4-NS35 OG	3273544	449	PTMC 1,5/1-3 -DF	3001929	68	PTME 6 HV	3035696	116	PTPOWER 95-PE	3260106	139
PTFIX 6X4-NS35 PK	3273543	449	PTMC 1,5/1-3 -NS	3001905	68	PTME 6 HV BU	3035695	116	PTRE 6-2/10	3069855	623
PTFIX 6X4-NS35 RD	3273530	449	PTMC 1,5/2-2 -DF	3001940	68	PTME 6-BE	3035687	115	PTRE 6-2/11	3069860	623
PTFIX 6X4-NS35 VT	3273542	449	PTMC 1,5/2-2 -NS	3001916	68	PTME 6-CT/1P	3212300	348	PTRE 6-2/12	3069861	623
PTFIX 6X4-NS35 WH	3273538	449	PTMC 1,5/2-3 -DF	3001930	68	PTME 6-DIO/L-R HV	3035697	115	PTRE 6-2/13	3069862	623
PTFIX 6X4-NS35 YE	3273532	449	PTMC 1,5/2-3 -NS	3001906	68	PTME 6-DIO/R-L HV	3035698	115	PTRE 6-2/14	3069863	623
PTFIX 6X4-NS35 FE	3273546	449	PTMC 1,5/2-2 -DF	3001942	68	PTME 6/1P	3212306	347	PTRE 6-2/15	3069864	623
PTFIX 6X4-NS35A BK	3273672	449	PTMC 1,5/3-2 -NS	3001917	68	PTMED 4	3212141	105	PTRE 6-2/16	3069865	623
PTFIX 6X4-NS35A BN	3273668	449	PTMC 1,5/3-3 -DF	3001931	68	PTMED 4-PE	3212154	105	PTRE 6-2/17	3069866	623
PTFIX 6X4-NS35A BU	3273660	449	PTMC 1,5/3-3 -NS	3001907	68	PTMED 6	3212183	116	PTRE 6-2/18	3069867	623
PTFIX 6X4-NS35A GN	3273666	449	PTMC 1,5/4-2 -DF	3001943	68	PTMED 6-CT/1P	3212301	348	PTRE 6-2/19	3069868	623
PTFIX 6X4-NS35A GY	3273658	449	PTMC 1,5/4-2 -NS	3001918	68	PTMED 6-CT/1P-PE	3212302	348	PTRE 6-2/20	3069869	623
PTFIX 6X4-NS35A OG	3273676	449	PTMC 1,5/4-3 -DF	3001932	68	PTMED 6-PE	3212196	116	PTRE 6-2/21	3069870	623
PTFIX 6X4-NS35A PK	3273675	449	PTMC 1,5/4-3 -NS	3001908	68	PTN 16/S	3214025	126	PTRE 6-2/22	3069871	623
PTFIX 6X4-NS35A RD	3273662	449	PTMC 1,5/5-2 -DF	3001944	68	PTN 2,5	3213963	90	PTRE 6-2/23	3069872	623
PTFIX 6X4-NS35A VT	3273674	449	PTMC 1,5/5-2 -NS	3001919	68	PTN 4	3213965	108	PTRE 6-2/24	3069873	623
PTFIX 6X4-NS35A WH	3273670	449	PTMC 1,5/5-3 -DF	3001933	68	PTN 6	3213967	118	PTRE 6-2/25	3069874	623
PTFIX 6X4-NS35A YE	3273664	449	PTMC 1,5/5-3 -NS	3001910	68	PTPOWER 185	1054722	141	PTRE 6-2/4	3069849	623
PTFIX 6X4-NS35A FE	3273678	449	PTMC 1,5/6-2 -DF	3001945	68	PTPOWER 185 3L-F	1054735	141	PTRE 6-2/5	3069850	623
PTFIX-F	3274060	438	PTMC 1,5/6-2 -NS	3001920	68	PTPOWER 185 3L/FE-F	1054737	141	PTRE 6-2/6	3069851	623
PTFIX-NS15A	3274058	438	PTMC 1,5/6-3 -DF	3001934	68	PTPOWER 185 3L/N-F	1054736	141	PTRE 6-2/7	3069852	623
PTFIX-NS15A-FIX	3274059	438	PTMC 1,5/6-3 -NS	3001911	68	PTPOWER 185 3L/N/FE-F	1054738	141	PTRE 6-2/8	3069853	623
PTFIX-NS35	3274054	438	PTMC 1,5/7-2 -DF	3001946	68	PTPOWER 185 P	1054723	141	PTRE 6-2/9	3069854	623
PTFIX-NS35A	3274056	438	PTMC 1,5/7-2 -NS	3001921	68	PTPOWER 185 F	1054732	141	PTRE 6-2/A14	3069452	630
PTFIX-NS35A-FIX	3274057	438	PTMC 1,5/7-3 -DF	3001935	68	PTPOWER 185 F BU	1054733	141	PTRE 6-2/A7	3069449	630
PTI 16-NLS-FI	1030130	127	PTMC 1,5/7-3 -NS	3001913	68	PTPOWER 185 FE-F	1054734	141	PTRE 6-2/B14	3069453	630
PTI 16-NLS-FI BU	1030131	127	PTMC 1,5/8-2 -DF	3001947	68	PTPOWER 185 P BU	1054725	141	PTRE 6-2/B19	3069455	630
PTI 16-NLS-FI RD	1030132	127	PTMC 1,5/8-2 -NS	3001922	68	PTPOWER 185 P-F	1054726	141	PTRE 6-2/B7	3069450	630
PTI 16-NLS-FI-FE	1030135	127	PTMC 1,5/8-3 -DF	3001936	68	PTPOWER 185 P-F	1054739	141	PTRE 6-2/C14	3069454	630
PTI 16/S	3214029	126	PTMC 1,5/8-3 -NS	3001914	68	PTPOWER 185-3L	1054728	141	PTRE 6-2/C19	3069456	630
PTI 16/S BU	3214023	126	PTMC 1,5-2 /BK	3270434	57	PTPOWER 185-3L/FE	1054730	141	PTRE 6-2/D19	3069457	630
PTI 16/S-PE	3214024	126	PTMC 1,5-2 /BN	3270433	57	PTPOWER 185-3L/N	1054729	141	PTRE 6-2/E7	3069451	630
PTI 2,5	3213968	90	PTMC 1,5-2 /BU	3270430	57	PTPOWER 185-3L/N/FE	1054731	141	PTRE 6-2/F19	3069458	630
PTI 2,5 BU	3213969	90	PTMC 1,5-2 /GN	3270432	57	PTPOWER 185-FE	1054724	141	PTRE 6-2/G19	3069459	630
PTI 2,5-L	3213951	92	PTMC 1,5-2 /GY	3270302	57	PTPOWER 95	3212064	135	PTRE 6-2/H19	3069460	630
PTI 2,5-L/L	3213953	92	PTMC 1,5-2 /OG	3270436	57	PTPOWER 35 BU	3212065	135	PTRE 6-2/I19	3069461	630
PTI 2,5-L/LB	3213945	94	PTMC 1,5-2 /PK	3270438	57	PTPOWER 35-3L	3212068	135	PTRV 4 /COL-COL	3001875	54
PTI 2,5-L/LT	3213948	91	PTMC 1,5-2 /RD	3270431	57	PTPOWER 35-3L-F	3212072	135	PTRV 4 /COL-RD	3001754	54
PTI 2,5-L/LTB	3213958	93	PTMC 1,5-2 /VT	3270435	57	PTPOWER 35-3L/FE	3212070	135	PTRV 4 /COL-WH	3001871	54
PTI 2,5-L/N	3213954	92	PTMC 1,5-2 /WH	3270303	57	PTPOWER 35-3L/FE-F	3212075	135	PTRV 4 /GN	3270122	46
PTI 2,5-L/NT	3213947	91	PTMC 1,5-2 /YE	3270437	57	PTPOWER 35-3L/N	3212069	135	PTRV 4 /GY	3270117	46
PTI 2,5-L/NTB	3213956	93	PTMC 1,5-3 /BK	3270424	57	PTPOWER 35-3L-N-F	3212073	135	PTRV 4 /RD	3270121	46
PTI 2,5-L/TG	3213961	77	PTMC 1,5-3 /BN	3270423	57	PTPOWER 35-3L/N/FE	3212071	135	PTRV 4 /RD-COL	3001872	54
PTI 2,5-N	3213952	92	PTMC 1,5-3 /BU	3270420	57	PTPOWER 35-3L/N/FE-F	3212076	135	PTRV 4 /WH	3270115	46
PTI 2,5-PE	3213962	90	PTMC 1,5-3 /GN	3270422	57	PTPOWER 35-F	3212078	135	PTRV 4 /WH-COL	3001874	54
PTI 2,5-PE/L	3213949	91	PTMC 1,5-3 /GY	3270300	57	PTPOWER 35-F BU	3212079	135	PTRV 4 /YE	3270123	46
PTI 2,5-PE/L/LB	3213959	93	PTMC 1,5-3 /OG	3270426	57	PTPOWER 35-FE	3212081	135	PTRV 4 BU/BU	3270118	46
PTI 2,5-PE/L/LTB	3213957	92	PTMC 1,5-3 /PK	3270428	57	PTPOWER 35-FE-F	3212082	135	PTRV 4 BU/RD	3270120	46
PTI 2,5-PE/L/N	3213950	91	PTMC 1,5-3 /RD	3270421	57	PTPOWER 35-PE	3212066	135	PTRV 4 BU/WH	3270119	46
PTI 2,5-PE/L/NT	3213946	91	PTMC 1,5-3 /VT	3270425	57	PTPOWER 50	3260050	137	PTRV 4-FE /BKYE	3270131	47
PTI 2,5-PE/L/NTB	3213955	92	PTMC 1,5-3 /WH	3270301	57	PTPOWER 50 BU	3260051	137	PTRV 4-FE /YEBK	3270130	47
PTI 2,5-PE/L/TG	3213960	77	PTMC 1,5-3 /YE	3270427	57	PTPOWER 50 P	3260065	137	PTRV 4-PV /BK	3270125	47
PTI 4	3213970	108	PTMC 1,5/18	3270390	66	PTPOWER 50-3L	3260053	137	PTRV 4-PV /BU	3270247	47
PTI 4 BU	3213971	108	PTMC 1,5/32-2	3270314	60	PTPOWER 50-3L-F	3260057	137	PTRV 4-PV /RD	3270246	47
PTI 4-L/L	3214052	109	PTMC 1,5/32-2 /BU	3270315	60	PTPOWER 50-3L/FE	3260055	137	PTRV 4-PV BU/BK	3270126	47
PTI 4-L/N	3214051	109	PTMC 1,5/32-2H /BU 19Z	3270317	64	PTPOWER 50-3L/FE-F	3260059	137	PTRV 8 /BU	3270233	50
PTI 4-PE	3213984	108	PTMC 1,5/32-2H 19Z	3270316	64	PTPOWER 50-3L/N	3260054	137	PTRV 8 /COL-COL	3001879	54
PTI 4-PE/L/L	3214050	109	PTMC 1,5/32-2H 19Z A-H	3270392	64	PTPOWER 50-3L/N-F	3260058	137	PTRV 8 /COL-RDWH	3001851	54
PTI 4-PE/L/LT	3214048	109	PTMC 1,5/32-2H VDE0815 19Z	3270395	65	PTPOWER 50-3L/N/FE	3260056	137	PTRV 8 /COL-WHRD	3001876	54
PTI 4-PE/L/N	3214049	109	PTMC 1,5/32-2H VDE0815 19Z A-H	3270393	65	PTPOWER 50-3L/N/FE-F	3260060	137	PTRV 8 /GN	3270232	50
PTI 4-PE/L/NT	3214047	109	PTMC 1,5/32-3	3270310	58	PTPOWER 50-F	3260061	137	PTRV 8 /RD	3270231	50
PTI 6	3213972	118	PTMC 1,5/32-3 /BU	3270312	58	PTPOWER 50-F BU	3260062	137	PTRV 8 /RDWH	3270137	50
PTI 6 BU	3213973	118	PTMC 1,5/32-3 /BU 19Z	3270313	62	PTPOWER 50-FE	3260063	137	PTRV 8 /RDWH-COL	3001877	54
PTI 6-PE	3213966	118	PTMC 1,5/32-3 19Z	3270311	62	PTPOWER 50-FE-F	3260064	137	PTRV 8 /WHRD	3270133	50
PTIO 1,5/S/3	3244410	41	PTMC 1,5/32-3 VDE0815 19Z	3270394	63	PTPOWER 50-PE	3260052	137	PTRV 8 /WHRD-COL	3001878	54
PTIO 1,5/S/3-LED 24 GN	3244436	41	PTMC 1,5/48-2	3270322	61	PTPOWER 95	3260100	139	PTRV 8 /VDE 0815	3270230	50
PTIO 1,5/S/3-LED 24 RD	3244423	41	PTMC 1,5/48-2 /BU	3270323	61	PTPOWER 95 BU	3260103	139	PTRV 8 BU/BU	3270136	50
PTIO 1,5/S/3-PE	3244449	41	PTMC 1,5/48-3	3270318	59	PTPOWER 95 P	3260163	139	PTRV 8 BU/RDWH	3270135	50
PTIO 1,5/S/4	3244452	41	PTMC 1,5/48-3 /BU	3270320	59	PTPOWER 95-3L	3260109	139	PTRV 8 BU/WHRD	3270134	50
PTIO 1,5/S/4-LED 24 GN	3244520	41	PTMC 1,5/48-3 /BU 19Z	3270321	63	PTPOWER 95-3L-F	3260121	139	PTRV 8-FE /BKYE	3270149	51
PTIO 1,5/S/4-LED 24 RD	3244517	41	PTMC 1,5/48-3 19Z	3270319	63	PTPOWER 95-3L/FE	3260115	139	PTRV 8-FE /YEBK	3270148	51
PTIO 1,5/S/4-PE	3244465	41	PTMC 1,5/54	3270391	67	PTPOWER 95-3L/FE-F	3260127	139	PTRV 8-PV /BK	3270142	51
PTIO 1,5/S/5	3244470	42	PTMC 1,5/80-2	3270329	61	PTPOWER 95-3L/N	3260112	139	PTRV 8-PV /BU	3270249	51
PTIO 1,5/S/5-PE	3244473	42	PTMC 1,5/80-2 /BU								

Index

Alphabetical

Type	Order No.	Page	Type	Order No.	Page	Type	Order No.	Page	Type	Order No.	Page
PTRVB 4-FI/BK	3270158	48	PTTB 1,5/S/4P-PE	3213881	278	PTU 2,5-PE	3209521	84	Q		
PTRVB 4-FI/BU	3270221	48	PTTB 1,5/S/4P-PV	3213852	278	PTU 2,5-TWIN	3209515	84			
PTRVB 4-FI/GY	3270138	48	PTTB 2,5	3210567	72	PTU 2,5-TWIN BU	3209516	84			
PTRVB 4-FI/RD	3270220	48	PTTB 2,5 BU	3210570	72	PTU 2,5-TWIN-PE	3209517	84			
PTRVB 4-PE	1070018	48	PTTB 2,5-2BE	3211480	83	PTU 35/4X10	3002371	130	QP 1,5/ 1	3051108	288
PTRVB 4-PV/BK	3270157	48	PTTB 2,5-2DIO/O-UL/O-UR	3211443	82	PTU 35/4X10 BU	3002370	131	QP 1,5/ 1 BU	3051250	288
PTRVB 4-PV/BU	3270223	48	PTTB 2,5-2DIO/O-UL/UR-UL	3211430	82	PTU 35/4X6/6X2,5	3214080	128	QP 1,5/ 1 GNYE	3051263	288
PTRVB 4-PV/RD	3270222	48	PTTB 2,5-2DIO/OL-U/OR-U	3211447	82	PTU 35/4X6/6X2,5 BU	3214081	129	QP 1,5/ 1-L	3051014	289
PTRVB 8-FI/BK	3270160	52	PTTB 2,5-2DIO/U-OL/U-OR	3211445	82	PTU 35/4X6/6X2,5-FE	3214082	129	QP 1,5/ 1-L BU	3051027	289
PTRVB 8-FI/BU	3270225	52	PTTB 2,5-2DIO/UR-O/UR-UL	3211433	82	PTU 4	3211855	106	QP 1,5/ 1-L GNYE	3051030	289
PTRVB 8-FI/RD	3270224	52	PTTB 2,5-DIO/O-U	3210923	81	PTU 4 BU	3211856	106	QP 1,5/ 1-M	3051043	289
PTRVB 8-PV/BK	3270159	52	PTTB 2,5-DIO/U-O	3210936	81	PTU 4-MT	3209538	106	QP 1,5/ 1-M BU	3051056	289
PTRVB 8-PV/BU	3270227	52	PTTB 2,5-DIO/UL-UR	3211427	81	PTU 4-MT-P	3209532	106	QP 1,5/ 1-M GNYE	3051069	289
PTRVB 8-PV/RD	3270226	52	PTTB 2,5-LA 100	3215042	83	PTU 4-MTD	3209539	106	QP 1,5/ 1-R	3051072	289
PTS 1,5/S	3214547	44	PTTB 2,5-L/N	3210994	72	PTU 4-MTD-P	3209540	106	QP 1,5/ 1-R BU	3051085	289
PTS 1,5/S BU	3214550	44	PTTB 2,5-LA 230	3211472	82	PTU 4-PE	3211857	106	QP 1,5/ 1-R GNYE	3051098	289
PTS 1,5/S-3L/3P	1027881	279	PTTB 2,5-LA 24 RD	3211456	82	PTU 4-TG	3209542	106	QP 1,5/ 2	3051111	288
PTS 1,5/S-3L/3P BU	1027882	279	PTTB 2,5-LA 60 RD	3211469	82	PTU 4-TG-P	3209541	106	QP 1,5/ 3	3051124	288
PTS 1,5/S-3PE/3P	1027884	280	PTTB 2,5-PE	3210596	72	PTU 4-TWIN	3211859	106	QP 1,5/ 4	3051137	288
PTS 1,5/S-3PV/3P	1027883	279	PTTB 2,5-PE/L	3210978	72	PTU 4-TWIN BU	3211860	106	QP 1,5/ 5	3051140	288
PTS 1,5/S-PE	3214563	44	PTTB 2,5-PE/N	3210981	72	PTU 4-TWIN-PE	3211862	106	QP 1,5/ 6	3051153	288
PTS 1,5/S-PE/LL/3P	1027885	280	PTTB 2,5-PV	3210583	72	PTU 6-T	3209535	117	QP 1,5/ 7	3051166	288
PTS 1,5/S-PE/LN/3P	1027886	280	PTTB 2,5-R499/O-U	3210925	82	PTU 6-T-P	3209530	117	QP 1,5/ 8	3051179	288
PTS 1,5/S-QUATTRO	3214615	45	PTTB 2,5/2P	3210871	292	PTUD 6	3209531	117	QP 1,5/ 9	3051182	288
PTS 1,5/S-QUATTRO BU	3214631	45	PTTB 2,5/2P BU	3210884	292	PTUD 6-P	3209537	117	QP 1,5/10	3051195	288
PTS 1,5/S-QUATTRO-PE	3214644	45	PTTB 2,5/2P-PE	3210897	292	PTV 2,5	1078960	88	QP 1,5/11	3051205	288
PTS 1,5/S-TWIN	3214589	44	PTTB 2,5/2P-PV	3210907	292	PTV 2,5 BU	1078962	88	QP 1,5/12	3051218	288
PTS 1,5/S-TWIN BU	3214592	44	PTTB 4	3211786	99	PTV 2,5-PE	1078963	88	QP 1,5/13	3051221	288
PTS 1,5/S-TWIN-PE	3214602	44	PTTB 4 BU	3211793	99	PTV 2,5-QUATTRO	1078999	88	QP 1,5/14	3051234	288
PTS 1,5/S-TWIN/1P	3214709	279	PTTB 4-HESI (5X20)	3211886	101	PTV 2,5-QUATTRO BU	1079006	88	QP 1,5/15	3051247	288
PTS 1,5/S-TWIN/1P BU	3214712	279	PTTB 4-HESI/LED 24 (5X20)	3211888	101	PTV 2,5-QUATTRO-PE	1079012	88	QTC 1,5	3205019	257
PTS 1,5/S-TWIN/1P-PE	3214725	279	PTTB 4-HESI/LED 250 (5X20)	3211892	101	PTV 2,5-TWIN	1078966	88	QTC 1,5 BU	3205022	257
PTS 1,5/S/1P	3214453	279	PTTB 4-HESI/LED 60 (5X20)	3211890	101	PTV 2,5-TWIN BU	1078971	88	QTC 1,5-MT	3205103	259
PTS 1,5/S/1P BU	3214466	279	PTTB 4-L 1000V	3062744	100	PTV 2,5-TWIN-PE	1078991	88	QTC 1,5-PE	3205035	257
PTS 1,5/S/1P-PE	3214479	279	PTTB 4-MT	3211913	103	PTVC 2,5-MT	1079059	89	QTC 1,5-QUATTRO	3205077	257
PTS 2,5	3211799	84	PTTB 4-MT BU	3211915	103	PTVC 2,5-MT BU	1079060	89	QTC 1,5-QUATTRO BU	3205080	257
PTS 2,5 BU	3211812	84	PTTB 4-PE	3211854	99	PTVC 2,5-TG	1079061	89	QTC 1,5-QUATTRO-PE	3205093	257
PTS 2,5-PE	3211867	84	PTTB 4-PV	3211825	99	PTWE 6-2/10	3069833	622	QTC 1,5-TG	3205145	258
PTS 2,5-QUATTRO	3211993	85	PTTB 4-TG	3211909	103	PTWE 6-2/11	3069834	622	QTC 1,5-TWIN	3205048	257
PTS 2,5-QUATTRO BU	3212002	85	PTTB 4-TG BU	3211911	103	PTWE 6-2/12	3069835	622	QTC 1,5-TWIN BU	3205051	257
PTS 2,5-QUATTRO-PE	3212011	85	PTTBS 1,5/S	3214657	45	PTWE 6-2/13	3069836	622	QTC 1,5-TWIN-MT	3050407	259
PTS 2,5-TWIN	3211896	84	PTTBS 1,5/S BU	3214660	45	PTWE 6-2/14	3069837	622	QTC 1,5-TWIN-PE	3205064	257
PTS 2,5-TWIN BU	3211906	84	PTTBS 1,5/S WH/U-BK/O-RD	3214662	40	PTWE 6-2/15	3069838	622	QTC 1,5-TWIN-TG	3050413	258
PTS 2,5-TWIN-PE	3211935	84	PTTBS 1,5/S WH/U-YE/O-WH	3214661	40	PTWE 6-2/16	3069839	622	QTC 1,5/ 1P	3050073	287
PTS 4	3213601	107	PTTBS 1,5/S-KNX	3214663	40	PTWE 6-2/17	3069840	622	QTC 1,5/ 1P BU	3050086	287
PTS 4 BU	3213602	107	PTTBS 1,5/S-PE	3214673	45	PTWE 6-2/18	3069841	622	QTC 1,5/ 1P-PE	3050099	287
PTS 4-PE	3213603	107	PTTBS 1,5/S-PV	3214686	45	PTWE 6-2/19	3069842	622	QTC 1,5/1P-F	3061211	373
PTS 4-QUATTRO	3213607	107	PTTBS 1,5/S/2P	3214495	281	PTWE 6-2/20	3069843	622	QTC 2,5	3206416	263
PTS 4-QUATTRO BU	3213608	107	PTTBS 1,5/S/2P BU	3214505	281	PTWE 6-2/21	3069844	622	QTC 2,5 BU	3206429	263
PTS 4-QUATTRO-PE	3213609	107	PTTBS 1,5/S/2P-PE	3214518	281	PTWE 6-2/22	3069845	622	QTC 2,5-HESI/LED 60 (5X20)	3050390	264
PTS 4-TWIN	3213604	107	PTTBS 1,5/S/2P-PV	3214521	281	PTWE 6-2/23	3069846	622	QTC 2,5-HEDI	3206678	264
PTS 4-TWIN BU	3213605	107	PTTBS 2,5	3209604	85	PTWE 6-2/24	3069847	622	QTC 2,5-HESI (5X20)	3050293	264
PTS 4-TWIN-PE	3213606	107	PTTBS 2,5 BU	3209617	85	PTWE 6-2/25	3069848	622	QTC 2,5-HESILA 250 (5X20)	3050387	264
PTT 1,5/S-2L	3210356	44	PTTBS 2,5-2MTB	3210400	80	PTWE 6-2/4	3069827	622	QTC 2,5-HESI/LED 24 (5X20)	3050374	264
PTT 1,5/S-2L BU	3210357	44	PTTBS 2,5-2MTB BU	3210401	80	PTWE 6-2/5	3069828	622	QTC 2,5-MT	3206487	263
PTT 1,5/S-2MT	3210351	43	PTTBS 2,5-2TGB	3210402	77	PTWE 6-2/6	3069829	622	QTC 2,5-PE	3206432	263
PTT 1,5/S-2MT BU	3210352	43	PTTBS 2,5-PE	3209620	85	PTWE 6-2/7	3069830	622	QTC 2,5-QUATTRO	3206446	263
PTT 1,5/S-LMT	3210341	43	PTTBS 2,5-PV	3210211	85	PTWE 6-2/8	3069831	622	QTC 2,5-QUATTRO BU	3206447	263
PTT 1,5/S-LMT BU	3210342	43	PTTBS 2,5-QUATTRO	3210609	72	PTWE 6-2/9	3069832	622	QTC 2,5-QUATTRO-PE	3206448	263
PTT 2,5-2L	3210267	77	PTTBS 2,5-QUATTRO BU	3210610	72	PTWE 6-2/A14	3069439	630	QTC 2,5-TG	3206490	263
PTT 2,5-2L BU	3210268	77	PTTBS 2,5-QUATTRO-PE	3210611	72	PTWE 6-2/A7	3069436	630	QTC 2,5-TWIN	3206445	263
PTT 2,5-2MT	3210258	80	PTTBS 2,5-QUATTRO-PV	3210612	72	PTWE 6-2/B14	3069440	630	QTC 2,5-TWIN BU	3206461	263
PTT 2,5-2MT BU	3210265	80	PTTBS 2,5-TWIN	3210600	72	PTWE 6-2/B19	3069442	630	QTC 2,5-TWIN-PE	3206474	263
PTT 2,5-LMT	3210251	80	PTTBS 2,5-TWIN BU	3210601	72	PTWE 6-2/B7	3069437	630	QTC 2,5-TWIN-PE	3206474	263
PTT 2,5-LMT BU	3210257	80	PTTBS 2,5-TWIN-PE	3210602	72	PTWE 6-2/C14	3069443	630	QTC 2,5-TWIN-PE	3050141	261
PTT 2,5-L/TG	3210230	77	PTTBS 2,5-TWIN-PV	3210603	72	PTWE 6-2/C19	3069443	630	QTC 2,5-TWIN-PE	3050154	261
PTT 2,5-L/TG BU	3210270	77	PTTBS 2,5-TWIN/2P	3210604	292	PTWE 6-2/D19	3069444	630	QTC 2,5-TWIN	3206348	261
PTTB 1,5/S	3208511	39	PTTBS 2,5-TWIN/2P BU	3210605	292	PTWE 6-2/E7	3069438	630	QTC 2,5-TWIN BU	3206351	261
PTTB 1,5/S BU	3208524	39	PTTBS 2,5-TWIN/2P-PE	3210606	292	PTWE 6-2/F19	3069445	630	QTC 2,5-TWIN-PE	3206364	261
PTTB 1,5/S-L/N	3208544	40	PTTBS 2,5-TWIN/2P-PV	3210607	292	PTWE 6-2/G19	3069446	630	QTC 2,5	3206500	265
PTTB 1,5/S-PE	3208537	39	PTTBS 2,5/2P	3211260	292	PTWE 6-2/H19	3069447	630	QTC 2,5 BU	3206513	265
PTTB 1,5/S-PE/L	3208553	40	PTTBS 2,5/2P BU	3211261	292	PTWE 6-2/I19	3069448	630	QTC 2,5-PE	3206526	265
PTTB 1,5/S-PE/N	3208566	40	PTTBS 2,5/2P-PE	3211263	292	PVB 3	0870036	536	QTC 2,5-TWIN	3050332	265
PTTB 1,5/S-PV	3208540	39	PTTBS 2,5/2P-PV	3211262	292	PZ 1,5/S/2	3212918	362	QTC 2,5-TWIN BU	3050345	265
PTTB 1,5/S/2P	3212439	277	PTTBS 4	3211832	107	PZ/2	3040627	362	QTC 2,5-TWIN-PE	3050358	265
PTTB 1,5/S/2P BU	3212442	277	PTTBS 4 BU	3211838	107	PZ/4	3040643	362	QTCU 1,5	3050015	260
PTTB 1,5/S/2P-PE	3212455	277	PTTBS 4-PE	3211841	107				QTCU 1,5 BU	3050028	260
PTTB 1,5/S/2P-PV	3212468	277	PTTBS 4-PV	3211848	107				QTCU 1,5-PE	3050031	260
PTTB 1,5/S/4P	3213865	278	PTU 2,5	3209519	84				QTCU 1,5-TWIN	3050044	260
PTTB 1,5/S/4P BU	3213878	278	PTU 2,5 BU	3209520	84				QTCU 1,5-TWIN BU		

Type	Order No.	Page	Type	Order No.	Page	Type	Order No.	Page	Type	Order No.	Page
QTCU 1,5-TWIN-PE	3050060	260	RSC 4-F/6	3059184	569	SB 6-T 2-8	3075842	176	SC 4/11	3042544	341
QTCU 2,5	3206539	264	RSC 4-F/8	3059197	569	SB 6-T 3-8	3075843	176	SC 4/12	3042557	341
QTCU 2,5 BU	3206542	264	RSC 5	3058143	570	SB 6-T 4-8	3075844	176	SC 4/13	3042560	341
QTCU 2,5-PE	3206555	264	RSC 5-F	3058156	571	SB-ME 2-6	3035755	105	SC 4/14	3042573	341
QTCU 2,5-TWIN	3050303	264	RSC 5-F/12	3059249	571	SB-ME 2-8	3034468	116	SC 4/15	3042586	341
QTCU 2,5-TWIN BU	3050316	264	RSC 5-F/4	3059210	571	SB-ME 3-6	3035756	105	SCBI 10-8,15	3245134	117
QTCU 2,5-TWIN-MT	3050304	265	RSC 5-F/6	3059223	571	SB-ME 3-8	3032800	116	SCBI 10-8,15 ISO	3000417	117
QTCU 2,5-TWIN-MT BU	3050317	265	RSC 5-F/8	3059236	571	SB-ME 4-6	3035757	105	SF-PZSL 1-80 S-VDE	1212699	580
QTCU 2,5-TWIN-PE	3050329	264	RSC 5-T	3058172	573	SB-ME 4-8	3034484	116	SF-PZSL 2-100 S-VDE	1212700	581
QTTCB 1,5	3205116	258	RSC 5-T-F	3058334	573	SB-MER 2-8	3000587	407	SF-SL 0,6X3,5-100 S-VDE	1212587	148
QTTCB 1,5 BU	3205129	258	RSC 6	3075870	572	SB-MER 3-8	3000588	407	SF-SL 0,8X4,0-100	1212551	383
QTTCB 1,5-DIO/O-U	3206241	259	RSC 6-F	3075919	573	SB-MER 4-8	3000589	407	SF-SL 0,8X4,0-100 S-VDE	1212588	520
QTTCB 1,5-PE	3205132	258	RSCWE 6-3/10	3969926	636	SBP 6-T 2-8	3070321	520	SF-THEX 6-200	1212642	190
QTTCB 1,5-PV	3205153	258	RSCWE 6-3/11	3969915	636	SBP 6-T 3-8	3070322	520	SF-THEX 8-200	1212643	196
QTTCB 1,5/2P	3050196	287	RSCWE 6-3/12	3969927	636	SBP 6-T 4-8	3070323	520	SGSK 6	3029965	240
QTTCB 1,5/2P BU	3050206	287	RSCWE 6-3/13	3969916	636	SC 2,5-NS/ 1-L	3042340	316	SHN 13	1209923	384
QTTCB 1,5/2P-F	3061185	373	RSCWE 6-3/14	3969928	636	SC 2,5-RZ/ 1-L	3042214	314	SHN 5.5	1209855	378
QTTCB 1,5/2P-PE	3050219	287	RSCWE 6-3/2	3969917	636	SC 2,5-RZ/ 1-L BU	3042227	314	SHN 8	1209868	380
QTTCB 1,5/2P-PV	3206377	287	RSCWE 6-3/3	3969918	636	SC 2,5-RZ/ 1-L GNYE	3042230	314	SK 5	3025338	596
QTTCS 1,5	3050222	261	RSCWE 6-3/3X10	3969929	636	SC 2,5-RZ/ 2	3041516	314	SK 5-D	3025406	596
QTTCS 1,5 BU	3050235	261	RSCWE 6-3/4	3969920	636	SC 2,5-RZ/ 3	3041529	314	SK 8	3025163	596
QTTCS 1,5-PE	3050248	261	RSCWE 6-3/4SL	1029994	644	SC 2,5-RZ/ 4	3041532	314	SK 8-D	3026861	596
QTTCS 1,5-PV	3206380	261	RSCWE 6-3/4SL GN	1029997	644	SC 2,5-RZ/ 5	3041545	314	SK 14	3025176	596
QTTCBU 1,5	3050264	260	RSCWE 6-3/5	3969921	636	SC 2,5-RZ/ 6	3041558	314	SK 14-D	3026874	596
QTTCBU 1,5 BU	3050280	260	RSCWE 6-3/6	3969922	636	SC 2,5-RZ/ 7	3041561	314	SK 20	3025189	596
QTTCBU 1,5-PE	3050277	260	RSCWE 6-3/6SL GN/BU	1090786	644	SC 2,5-RZ/ 8	3041574	314	SK 20-D	3026887	596
QTTCBU 1,5-PV	3050361	260	RSCWE 6-3/7	3969923	636	SC 2,5-RZ/ 9	3041590	314	SK 28	3026997	596
			RSCWE 6-3/8	3969924	636	SC 2,5-RZ/10	3041587	314	SK 28-D	3027006	596
			RSCWE 6-3/9	3969925	636	SC 2,5-RZ/11	3041600	314	SK 35	3026463	596
			RT 3	3049013	379	SC 2,5-RZ/12	3041613	314	SK 35-D	3026890	596
			RT 3 BU	3049110	379	SC 2,5-RZ/13	3041626	314	SKS 14	3240211	597
			RT 3-PE	3049411	379	SC 2,5-RZ/14	3041639	314	SKS 14-D	3240214	597
R											
RBO 10	3244614	391	RT 4-T-P/P	3000565	383	SC 2,5-RZ/15	3041642	314	SKS 14-NS35	3240217	597
RBO 10 BU	3244616	391	RT 5	3049026	381	SC 2,5/ 1-L	3042188	313	SKS 14-SNS35	3062799	597
RBO 10-FE	3244615	391	RT 5 BU	3049123	381	SC 2,5/ 1-L BU	3042191	313	SKS 20	3240212	597
RBO 10-FE-HC	3247978	393	RT 5-PE	3049424	381	SC 2,5/ 1-L GNYE	3042201	313	SKS 20-D	3240215	597
RBO 10-HC	3247976	393	RT 5-T	3049039	382	SC 2,5/ 2	3041312	313	SKS 20-NS35	3240218	597
RBO 10-HC BU	3247977	393	RT 8	3049042	385	SC 2,5/ 3	3042269	313	SKS 20-SNS35	3062809	597
RBO 10-VS 2	3244643	391	RT 8 BU	3049148	385	SC 2,5/ 4	3042272	313	SKS 8	3240210	597
RBO 10-VS 3	3244656	391	RTO 3	3049518	379	SC 2,5/ 5	3042285	313	SKS 8-D	3240213	597
RBO 12	3244627	391	RTO 3 BU	3049660	379	SC 2,5/ 6	3042298	313	SKS 8-NS35	3240216	597
RBO 12 BU	3244629	391	RTO 3-PE	3049615	379	SC 2,5/ 7	3041367	313	SKS 8-SNS35	3062786	597
RBO 12-FE	3244628	391	RTO 3-PE-TC	3049958	379	SC 2,5/ 8	3042308	313	SLKK 5	0461018	488
RBO 12-FE-HC	3247988	393	RTO 3-TC	3049945	379	SC 2,5/ 9	3041383	313	SLKK 5-LA 60 RDU-U	0461034	488
RBO 12-HC	3247986	393	RTO 3-TC BU	3049835	379	SC 2,5/10	3042311	313	SP 2,5/ 1	3040258	318
RBO 12-HC BU	3247987	393	RTO 4-T-TC	3000558	383	SC 2,5/11	3041406	313	SP 2,5/ 1 BU	3040698	318
RBO 12-VS 2	3244669	391	RTO 5	3049521	381	SC 2,5/12	3042324	313	SP 2,5/ 1-L GNYE	3040708	318
RBO 12-VS 3	3244672	391	RTO 5 BU	3049767	381	SC 2,5/13	3041422	313	SP 2,5/ 1-L	3043019	318
RBO 16	3244630	391	RTO 5-PE	3049628	381	SC 2,5/14	3041435	313	SP 2,5/ 1-L BU	3043022	318
RBO 16 BU	3244632	391	RTO 5-PE-TC	3049974	381	SC 2,5/15	3041448	313	SP 2,5/ 1-L GNYE	3043035	318
RBO 16-3L/N	3076277	391	RTO 5-T	3049233	382	SC 4-NS/ 1-L	3043404	343	SP 2,5/ 1-M	3043043	318
RBO 16-FE	3244631	391	RTO 5-T-TC	3049990	382	SC 4-RZ/ 1-L	3043378	342	SP 2,5/ 1-M BU	3043051	318
RBO 16-FE-HC	3247991	393	RTO 5-TC	3049961	381	SC 4-RZ/ 1-L BU	3043381	342	SP 2,5/ 1-M GNYE	3043064	318
RBO 16-HC	3247989	393	RTO 5-T-TC BU	3049851	381	SC 4-RZ/ 1-L GNYE	3043394	342	SP 2,5/ 1-R	3043077	318
RBO 16-HC BU	3247990	393	RTO 8	3049343	385	SC 4-RZ/ 2	3042625	342	SP 2,5/ 1-R BU	3043080	318
RBO 16-VS 2	3244685	391	RTO 8 BU	3049864	385	SC 4-RZ/ 3	3042638	342	SP 2,5/ 1-R GNYE	3043093	318
RBO 16-VS 3	3244698	391	RTO 8-TC	3050002	385	SC 4-RZ/ 4	3042641	342	SP 2,5/ 2	3040261	318
RBO 5	3058059	387	RTO 8-TC BU	3049929	385	SC 4-RZ/ 5	3042654	342	SP 2,5/ 3	3040274	318
RBO 5-F	3058062	387				SC 4-RZ/ 6	3042667	342	SP 2,5/ 4	3040287	318
RBO 5-F/12	3059252	387				SC 4-RZ/ 7	3042670	342	SP 2,5/ 5	3040290	318
RBO 5-F/4	3058237	387				SC 4-RZ/ 8	3042683	342	SP 2,5/ 6	3040300	318
RBO 5-F/6	3058240	387				SC 4-RZ/ 9	3042696	342	SP 2,5/ 7	3040313	318
RBO 5-F/8	3058253	387				SC 4-RZ/10	3042706	342	SP 2,5/ 8	3040326	318
RBO 5-T	3058114	388	S			SC 4-RZ/11	3043323	342	SP 2,5/ 9	3040339	318
RBO 5-T-F	3058169	388	S	0308359	519	SC 4-RZ/12	3043336	342	SP 2,5/10	3040342	318
RBO 6	3075896	389	S-ME 4	3035758	105	SC 4-RZ/13	3043349	342	SP 2,5/11	3040355	318
RBO 6-F	3075935	389	S-ME 6	3034439	116	SC 4-RZ/14	3043352	342	SP 2,5/12	3040368	318
RBO 8	3213137	390	S-MT	3247954	415	SC 4-RZ/15	3043365	342	SP 2,5/13	3040371	318
RBO 8 BU	3213136	390	S-OTTA 6-T	0311199	566	SC 4/ 1-L	3042599	341	SP 2,5/14	3040384	318
RBO 8-3L/NFE	3076280	390	S-URTK/SP	0311155	240	SC 4/ 1-L BU	3042609	341	SP 4/ 1-L GNYE	3040397	318
RBO 8-FE	3213139	390	SB 2-8-T	3026366	240	SC 4/ 1-L GNYE	3042612	341	SP 4/ 1	3042887	345
RBO 8-FE-HC	3247975	392	SB 3-8-T	3026492	240	SC 4/ 2	3042450	341	SP 4/ 1-L	3042751	345
RBO 8-HC	3247973	392	SB 4-8-T	3026379	240	SC 4/ 3	3042463	341	SP 4/ 1-L BU	3042764	345
RBO 8-HC BU	3247974	392	SB 10-8-T SO	3026395	240	SC 4/ 4	3042476	341	SP 4/ 1-L GNYE	3042777	345
RBO 8-VS 2	3213179	390	SB 2- 8/13	0202235	558	SC 4/ 5	3042489	341	SP 4/ 1-M	3042780	345
RBO 8-VS 3	3213182	390	SB 2- 8/13 N	0200062	460	SC 4/ 6	3042492	341	SP 4/ 1-M BU	3042793	345
RSC 4	3058127	569	SB 2-RTK/S	0311236	519	SC 4/ 7	3042502	341	SP 4/ 1-M GNYE	3042803	345
RSC 4-F	3058130	569	SB 2-URTK/SP	0360012	525	SC 4/ 8	3042515	341	SP 4/ 1-R	3042816	345
RSC 4-F/12	3059207	569	SB 4-RTK/S	0311265	519	SC 4/ 9	3042528	341	SP 4/ 1-R BU	3042829	345
RSC 4-F/4	3059171	569	SB 4-URTK/SP	0360025	525	SC 4/10	3042531	341	SP 4/ 1-R GNYE	3042832	345

Index

Alphabetical

Type	Order No.	Page	Type	Order No.	Page	Type	Order No.	Page	Type	Order No.	Page
SP 4/2	3042890	345	SPDB 2,5/2	3040410	322	ST 2,5-4L/1P	3041985	311	ST 2,5/2P-FS	3061415	371
SP 4/3	3042900	345	SPDB 2,5/3	3040423	322	ST 2,5-4L/2P	3042007	311	ST 2,5/2P-PE	3042146	293
SP 4/4	3042926	345	SPDB 2,5/4	3040436	322	ST 2,5-4L/2P-Z	3041998	311	ST 35	3036178	249
SP 4/5	3042939	345	SPDB 2,5/5	3040449	322	ST 2,5-DIO/L-R	3036262	218	ST 35 BU	3036181	249
SP 4/6	3042942	345	SPDB 2,5/6	3040452	322	ST 2,5-DIO/R-L	3036518	218	ST 35-PE	3036194	249
SP 4/7	3042955	345	SPDB 2,5/7	3040465	322	ST 2,5-MT	3036343	217	ST 4	3031364	229
SP 4/8	3042968	345	SPDB 2,5/8	3040478	322	ST 2,5-MT BU	3037818	217	ST 4 BU	3031377	229
SP 4/9	3042971	345	SPDB 2,5/9	3040481	322	ST 2,5-PCB/ 2-G-5,2	1980378	297	ST 4-FSI/C	3036372	231
SP 4/1 BU	3061033	345	SPDB 2,5/10	3040494	322	ST 2,5-PCB/ 3-G-5,2	1980381	297	ST 4-FSI/C-LED 12	3036495	231
SP 4/1 GNYE	3061046	345	SPDB 2,5/11	3040504	322	ST 2,5-PCB/ 4-G-5,2	1980394	297	ST 4-FSI/C-LED 24	3036505	231
SP 4/10	3042984	345	SPDB 2,5/12	3040517	322	ST 2,5-PCB/ 5-G-5,2	1980404	297	ST 4-HEDI	3035140	231
SP 4/11	3042997	345	SPDB 2,5/13	3040520	322	ST 2,5-PCB/ 6-G-5,2	1980417	297	ST 4-HESI (5X20)	3036369	231
SP 4/12	3043006	345	SPDB 2,5/14	3040533	322	ST 2,5-PCB/ 7-G-5,2	1980420	297	ST 4-HESI (6,3X32)	3036385	231
SP 4/13	3043718	345	SPDB 2,5/15	3040546	322	ST 2,5-PCB/ 8-G-5,2	1980433	297	ST 4-HESILA 250 (5X20)	3036563	231
SP 4/14	3043721	345	SPV 2,5/1	3041710	320	ST 2,5-PCB/ 9-G-5,2	1980446	297	ST 4-HESILA 250 (6,3X32)	3038778	231
SP 4/15	3043734	345	SPV 2,5/ 1 BU	3061017	320	ST 2,5-PCB/ 10-G-5,2	1980459	297	ST 4-HESILED 24 (5X20)	3036547	231
SP-H 2,5/ 1	3210619	319	SPV 2,5/ 1 GNYE	3061020	320	ST 2,5-PCB/ 11-G-5,2	1980462	297	ST 4-HESILED 24 (6,3X32)	3038765	231
SP-H 2,5/ 1 BU	3210761	319	SPV 2,5/ 1-L	3041024	320	ST 2,5-PCB/ 12-G-5,2	1980475	297	ST 4-FS/C-LED 60 (5X20)	3036550	231
SP-H 2,5/ 1 GNYE	3210774	319	SPV 2,5/ 1-L BU	3041037	320	ST 2,5-PCBV/ 2-G-5,2	1980488	297	ST 4-MT	3038875	232
SP-H 2,5/ 1-L	3210787	319	SPV 2,5/ 1-L GNYE	3041040	320	ST 2,5-PCBV/ 3-G-5,2	1980491	297	ST 4-PCB/ 2-G-6,2	1980598	326
SP-H 2,5/ 1-L BU	3210790	319	SPV 2,5/ 1-M	3041053	320	ST 2,5-PCBV/ 4-G-5,2	1980501	297	ST 4-PCB/ 3-G-6,2	1980608	326
SP-H 2,5/ 1-L GNYE	3210800	319	SPV 2,5/ 1-M BU	3041066	320	ST 2,5-PCBV/ 5-G-5,2	1980514	297	ST 4-PCB/ 4-G-6,2	1980611	326
SP-H 2,5/ 1-M	3210813	319	SPV 2,5/ 1-M GNYE	3041079	320	ST 2,5-PCBV/ 6-G-5,2	1980527	297	ST 4-PCB/ 5-G-6,2	1980624	326
SP-H 2,5/ 1-M BU	3210826	319	SPV 2,5/ 1-R	3041082	320	ST 2,5-PCBV/ 7-G-5,2	1980530	297	ST 4-PCB/ 6-G-6,2	1980637	326
SP-H 2,5/ 1-M GNYE	3210839	319	SPV 2,5/ 1-R BU	3041095	320	ST 2,5-PCBV/ 8-G-5,2	1980543	297	ST 4-PCB/ 7-G-6,2	1980640	326
SP-H 2,5/ 1-R	3210842	319	SPV 2,5/ 1-R GNYE	3041105	320	ST 2,5-PCBV/ 9-G-5,2	1980556	297	ST 4-PCB/ 8-G-6,2	1980653	326
SP-H 2,5/ 1-R BU	3210855	319	SPV 2,5/ 2	3041723	320	ST 2,5-PCBV/ 10-G-5,2	1980569	297	ST 4-PCB/ 9-G-6,2	1980666	326
SP-H 2,5/ 1-R GNYE	3210868	319	SPV 2,5/ 3	3041736	320	ST 2,5-PCBV/ 11-G-5,2	1980572	297	ST 4-PCB/ 10-G-6,2	1980679	326
SP-H 2,5/ 2	3210622	319	SPV 2,5/ 4	3041749	320	ST 2,5-PCBV/ 12-G-5,2	1980585	297	ST 4-PCB/ 11-G-6,2	1980682	326
SP-H 2,5/ 3	3210635	319	SPV 2,5/ 5	3041752	320	ST 2,5-PE	3031238	211	ST 4-PCB/ 12-G-6,2	1980695	326
SP-H 2,5/ 4	3210648	319	SPV 2,5/ 6	3041765	320	ST 2,5-PE/2PV	3038833	213	ST 4-PCBV/ 2-G-6,2	1980705	326
SP-H 2,5/ 5	3210651	319	SPV 2,5/ 7	3041778	320	ST 2,5-PE/3L	3036055	213	ST 4-PCBV/ 3-G-6,2	1980718	326
SP-H 2,5/ 6	3210664	319	SPV 2,5/ 8	3041781	320	ST 2,5-PE/3L/1P	3041969	311	ST 4-PCBV/ 4-G-6,2	1980721	326
SP-H 2,5/ 7	3210677	319	SPV 2,5/ 9	3041794	320	ST 2,5-PE/L/L	3036097	213	ST 4-PCBV/ 5-G-6,2	1980734	326
SP-H 2,5/ 8	3210680	319	SPV 2,5/ 10	3041804	320	ST 2,5-PE/L/N	3036084	213	ST 4-PCBV/ 6-G-6,2	1980747	326
SP-H 2,5/ 9	3210693	319	SPV 2,5/ 11	3041817	320	ST 2,5-QUATTRO	3031306	211	ST 4-PCBV/ 7-G-6,2	1980750	326
SP-H 2,5/ 10	3210703	319	SPV 2,5/ 12	3041820	320	ST 2,5-QUATTRO BU	3031319	211	ST 4-PCBV/ 8-G-6,2	1980763	326
SP-H 2,5/ 11	3210716	319	SPV 2,5/ 13	3041833	320	ST 2,5-QUATTRO-DIO 1N 5408K/L-R	3002216	218	ST 4-PCBV/ 9-G-6,2	1980776	326
SP-H 2,5/ 12	3210729	319	SPV 2,5/ 14	3041846	320	ST 2,5-QUATTRO-DIO 1N 5408K/R-L	3002214	218	ST 4-PCBV/ 10-G-6,2	1980789	326
SP-H 2,5/ 13	3210732	319	SPV 2,5/ 15	3041859	320	ST 2,5-QUATTRO-DIO/L-R	3036233	218	ST 4-PCBV/ 11-G-6,2	1980792	326
SP-H 2,5/ 14	3210745	319	SRDK 6	3029973	240	ST 2,5-QUATTRO-DIO/R-L	3036534	218	ST 4-PCBV/ 12-G-6,2	1980802	326
SP-H 2,5/ 15	3210758	319	SRTK 6	3029952	240	ST 2,5-QUATTRO-MT	3036576	217	ST 4-PE	3031380	229
SPB 2,5/ 1	3040106	321	SSK 0525 KER-EX	0501059	541	ST 2,5-QUATTRO-MT BU	3037834	217	ST 4-PE/3L	3038338	230
SPB 2,5/ 1 BU	3040724	321	SSK 110 KER-EX	0502058	542	ST 2,5-QUATTRO-PE	3031322	211	ST 4-QUATTRO	3031445	229
SPB 2,5/ 1 GNYE	3040711	321	SSK 116 KER-EX	0503057	543	ST 2,5-QUATTRO-TG	3038451	216	ST 4-QUATTRO BU	3031458	229
SPB 2,5/ 1-L	3043103	321	SSK 135 KER-EX	0505055	543	ST 2,5-QUATTRO-U	3031636	211	ST 4-QUATTRO-DIO 1N 5408/L-R	3037782	232
SPB 2,5/ 1-L BU	3043116	321	SSL 2,5	3043815	296	ST 2,5-QUATTRO/2P	3040038	309	ST 4-QUATTRO-DIO 1N 5408/R-L	3037795	232
SPB 2,5/ 1-L GNYE	3043129	321	ST 1,5	3031076	207	ST 2,5-QUATTRO/2P BU	3040669	309	ST 4-QUATTRO-PE	3031461	229
SPB 2,5/ 1-M	3043132	321	ST 1,5 BU	3031089	207	ST 2,5-QUATTRO/2P-F	3209853	373	ST 4-QUATTRO-U	3038639	229
SPB 2,5/ 1-M BU	3043145	321	ST 1,5-PE	3031513	207	ST 2,5-QUATTRO/2P-FS	3061392	371	ST 4-QUATTRO/2P	3042845	339
SPB 2,5/ 1-M GNYE	3043158	321	ST 1,5-QUATTRO	3031186	207	ST 2,5-QUATTRO/2P-PE	3040041	309	ST 4-QUATTRO/2P BU	3042861	339
SPB 2,5/ 1-R	3043161	321	ST 1,5-QUATTRO BU	3031199	207	ST 2,5-QUATTRO/4P	3042159	293	ST 4-QUATTRO/2P-PE	3042858	339
SPB 2,5/ 1-R BU	3043174	321	ST 1,5-QUATTRO-PE	3031209	207	ST 2,5-QUATTRO/4P BU	3042081	293	ST 4-QUATTRO/4CP	3042736	340
SPB 2,5/ 1-R GNYE	3043187	321	ST 1,5-QUATTRO-U	3038600	207	ST 2,5-QUATTRO/4P-F	3061208	373	ST 4-TG	3038367	232
SPB 2,5/ 2	3040119	321	ST 1,5-TWIN	3031128	207	ST 2,5-QUATTRO/4P-FS	3061402	371	ST 4-TWIN	3031393	229
SPB 2,5/ 3	3040122	321	ST 1,5-TWIN BU	3031131	207	ST 2,5-QUATTRO/4P-PE	3042162	293	ST 4-TWIN BU	3031403	229
SPB 2,5/ 4	3040135	321	ST 1,5-TWIN-PE	3031144	207	ST 2,5-TG	3038435	216	ST 4-TWIN-PE	3031416	229
SPB 2,5/ 5	3040143	321	ST 1,5/S-QUATTRO	3213124	208	ST 2,5-TWIN	3031241	211	ST 4/ 1P	3042719	339
SPB 2,5/ 6	3040151	321	ST 1-SI	0920326	498	ST 2,5-TWIN BU	3031254	211	ST 4/ 1P BU	3042874	339
SPB 2,5/ 7	3040164	321	ST 1-SILA 250	0920397	498	ST 2,5-TWIN-DIO/L-R	3036246	218	ST 4/ 1P-PE	3042722	339
SPB 2,5/ 8	3040177	321	ST 1-SILED 24	0920384	498	ST 2,5-TWIN-DIO/R-L	3036521	218	ST 4/ 2P	3042735	325
SPB 2,5/ 9	3040180	321	ST 10	3036110	243	ST 2,5-TWIN-MT	3036356	217	ST 4/ 2P BU	3043789	325
SPB 2,5/ 10	3040193	321	ST 10 BU	3036123	243	ST 2,5-TWIN-MT BU	3037821	217	ST 4/ 2P-PE	3042748	325
SPB 2,5/ 11	3040203	321	ST 10-PE	3036136	243	ST 2,5-TWIN-MT/1P	3040766	310	ST 6	3031487	237
SPB 2,5/ 12	3040216	321	ST 10-TWIN	3035288	243	ST 2,5-TWIN-PE	3031267	211	ST 6 BU	3031490	237
SPB 2,5/ 13	3040229	321	ST 10-TWIN BU	3035292	243	ST 2,5-TWIN-TG	3038448	216	ST 6-PE	3031500	237
SPB 2,5/ 14	3040232	321	ST 10-TWIN-PE	3035302	243	ST 2,5-TWIN-TG/1P	3040847	310	ST 6-TWIN	3036466	237
SPB 2,5/ 15	3040245	321	ST 16	3036149	247	ST 2,5-TWIN/ 1P	3042117	309	ST 6-TWIN BU	3036479	237
SPDB 2,5/ 1	3040407	322	ST 16 BU	3036152	247	ST 2,5-TWIN/ 1P BU	3042104	309	ST 6-TWIN-PE	3036482	237
SPDB 2,5/ 1 BU	3040737	322	ST 16-PE	3036165	247	ST 2,5-TWIN/ 1P-PE	3042120	309	ST-1N4007	2802329	508
SPDB 2,5/ 1 GNYE	3040740	322	ST 16-TWIN	3035328	247	ST 2,5-TWIN/ 1P-F	3209840	373	ST-B250C1500	2802345	508
SPDB 2,5/ 1-L	3043190	322	ST 16-TWIN BU	3035331	247	ST 2,5-TWIN/ 1P-FS	3061389	371	ST-BE	2802316	508
SPDB 2,5/ 1-L BU	3043200	322	ST 16-TWIN-PE	3035344	247	ST 2,5/ 1P	3040012	309	ST-BE-LA 24	2802374	508
SPDB 2,5/ 1-L GNYE	3043213	322	ST 2,5	3031212	211	ST 2,5/ 1P BU	3040656	309	ST-BE-LA230	2802387	508
SPDB 2,5/ 1-M	3043226	322	ST 2,5 BU	3031225	211	ST 2,5/ 1P-PE	3040025	309	ST-K 4	5025462	508
SPDB 2,5/ 1-M BU	3043239	322	ST 2,5-3L	3036042	213	ST 2,5/ 1P-F	3209837	373	ST-SI	0920229	498
SPDB 2,5/ 1-M GNYE	3043242	322	ST 2,5-3L BU	3038710	213	ST 2,5/ 1P-FS	3061376	371	ST-SI-UK 4	0921011	508
SPDB 2,5/ 1-R	3043255	322	ST 2,5-3L-LA 24R/DIO-M	3035580	213	ST 2,5/ 2P	3042133	293	ST-SILA250	0920287	498
SPDB 2,5/ 1-R BU	3043268	322	ST 2,5-3PE	3036071	213	ST 2,5/ 2P BU	3042094	293	ST-SILA250-UK 4	0921053	508
SPDB 2,5/ 1-R GNYE	3043271	322	ST 2,5-3PV	3036068	213	ST 2,5/ 2P-F	3061198	373	ST-SILED 12-UK 4	0921024	508

Type	Order No.	Page	Type	Order No.	Page	Type	Order No.	Page	Type	Order No.	Page
ST-SILED 24	0920452	498	STTB 2,5-LA 60 RD	3031610	219	TM-PTRV 8,QR:1-8	0803468	53	UHSK/S 2000	0704076	460
ST-SILED 24-UK 4	0921037	508	STTB 2,5-LA230	3031623	219	TM-PTRV 8,QR:8-1	0803470	53	UHV -E	2130428	574
ST-SILED 60-UK 4	0921040	508	STTB 2,5-PE	3036026	212	TM-PTRV 8,QR:A-H	0803471	53	UHV-TP1	2130402	574
STT	0920216	498	STTB 2,5-PE/L	3036314	212	TM-PTRV 8,QR:H-A	0803473	53	UHV-TP2	2130415	575
STG-MTN 0,5-1,0	3190438	294	STTB 2,5-PE/N	3036327	212	TPN-UK	3003062	504	UHV 25-AH	2130431	574
STG-MTN 1,5-2,5	3190506	294	STTB 2,5-PT100 MD	3035564	220	TPNS-UK	0706647	545	UHV 25-AS/AS	2130004	574
STIO 2,5/3-2B/L	3209015	214	STTB 2,5-PV	3031539	212	TPS 3/20/5	3246586	117	UHV 25-KH/AS	2130101	574
STIO 2,5/3-2B/L-LA24GN/O-M	3209031	214	STTB 2,5-PV BU	3035108	212	TS-GSK	0304214	517	UHV 25-KH/KH	2130156	574
STIO 2,5/3-2B/L-LA24RD/O-M	3209028	214	STTB 2,5-TWIN	3038516	212	TS-K	1302215	459	UHV 25-VS 2	2130541	574
STIO 2,5/3-PE/B/L	3209044	214	STTB 2,5-TWIN BU	3038529	212	TS-KK 3	2770215	387	UHV 25-VS 3	2130554	574
STIO 2,5/3-PE/B/L-LA24GN/O-M	3209141	214	STTB 2,5-TWIN-PE	3038532	212	TS-KK 3 SO	2778534	560	UHV 50-AH	2130444	574
STIO 2,5/3-PE/B/L-LA24RD/O-M	3209138	214	STTB 2,5-TWIN-PV	3038545	212	TS-RTK	0310211	519	UHV 50-AS/AS	2130017	574
STIO 2,5/4-3B/L	3209057	215	STTB 2,5/2P	3040054	309	TS-RTK-BEN	0308210	519	UHV 50-KH/AS	2130114	574
STIO 2,5/4-3B/L-LA24GN/O-M	3209167	215	STTB 2,5/2P BU	3040672	309	TS-UK 6-T	3072820	176	UHV 50-KH/KH	2130169	574
STIO 2,5/4-3B/L-LA24RD/O-M	3209154	215	STTB 2,5/2P BU SO	3040902	310	TS-URTK/SS	0321213	517	UHV 50-VS 2	5030897	574
STIO 2,5/4-PE/2B/L	3209060	215	STTB 2,5/2P SO	3040892	310	TS-USST 4/10	3070383	545	UHV 50-VS 3	2130622	574
STIO 2,5/4-PE/2B/L-LA24GN/O-M	3209183	215	STTB 2,5/2P-F	3061169	373	TZ	0306704	508	UHV 95-AH	2130457	575
STIO 2,5/4-PE/2B/L-LA24RD/O-M	3209170	215	STTB 2,5/2P-FS	3061428	371				UHV 95-AS/AS	2130020	575
STIO-IN 2,5/3 OG	3209196	214	STTB 2,5/2P-PE	3040067	309				UHV 95-KH/AS	2130127	575
STIO-IN 2,5/3-PE OG	3209086	214	STTB 2,5/2P-PE SO	3040915	310				UHV 95-KH/KH	2130172	575
STIO-IN 2,5/4 OG	3209206	215	STTB 2,5/2P-PV	3040070	309				UHV 95-VS 2	2130635	575
STIO-IN 2,5/4-PE OG	3209109	215	STTB 2,5/2P-PV BU	3040685	309				UHV 95-VS 3	2130648	575
STIME 6	3035700	238	STTB 2,5/2P-PV SO	3040928	310				UHV150-AH	2130460	575
STIME 6 HV	3035693	237	STTB 2,5/4P	3061486	293				UHV150-AS/AS	2130033	575
STIME 6 HV BU	3035694	237	STTB 2,5/4P BU	3061512	293	UBAL 150	1086498	585	UHV150-KH/AS	2130130	575
STIME 6-BE	3035688	239	STTB 2,5/4P-PE	3061499	293	UBAL 150 BK	1086502	585	UHV150-KH/KH	2130185	575
STIME 6-DIO/L-R HV	3035691	239	STTB 2,5/4P-PV	3061509	293	UBAL 150 BN	1086503	585	UHV150-VS 2	2130651	575
STIME 6-DIO/R-L HV	3035692	239	STTB 4	3031429	230	UBAL 150 BU	1086499	585	UHV150-VS 3	2130664	575
STMED 6	3035713	238	STTB 4 BU	3031432	230	UBAL 150 FE	1086504	585	UHV240-AH	2130473	575
STMED 6-PE	3035726	238	STTB 4-PE	3036039	230	UBAL 150 GN	1086501	585	UHV240-AS/AS	2130046	575
STP 3,5-2	0830131	418	STTB 4-PV	3031542	230	UBAL 240	1086505	585	UHV240-KH/AS	2130143	575
STP 3,5-3	0830132	418	STTBs 2,5	3038464	221	UBAL 240 BK	1086508	585	UHV240-KH/KH	2130198	575
STP 4-2	0810575	418	STTBs 2,5 BU	3038493	221	UBAL 240 BN	1086509	585	UHV240-VS 2	2130677	575
STP 4-2-ZB	3038613	418	STTBs 2,5-PE	3038480	221	UBAL 240 BU	1086506	585	UHV240-VS 3	2130680	575
STP 5-2	0800967	418	STTBs 2,5-PV	3038477	221	UBAL 240 FE	1086510	585	UK 1,5 N	3005837	458
STP 5-2-ZB	3037643	418	STTBs 2,5-PV BU	3035289	221	UBAL 240 GN	1086507	585	UK 1,5 N BU	3005840	458
STP 5-2/S	0800970	418	STTBs 4	3035056	234	UBAL 50	1086465	583	UK 2,5 N	3003347	459
STP 5-3	0810562	418	STTBs 4 BU	3035069	234	UBAL 50 BK	1086469	583	UK 2,5 N BU	3003350	459
STS 2,5	3036398	221	STTBs 4-MT	3035470	235	UBAL 50 BN	1086470	583	UK 3 N	3001501	459
STS 2,5 BU	3036408	221	STTBs 4-MT BU	3035522	235	UBAL 50 BU	1086466	583	UK 3 N BU	3001514	459
STS 2,5-MT	3036990	222	STTBs 4-PE	3035072	234	UBAL 50 FE	1086471	583	UK 3-TWIN	3002225	466
STS 2,5-MT BU	3035425	222	STTBs 4-PV	3035085	234	UBAL 50 GN	1086468	583	UK 3-TWIN BU	3002416	466
STS 2,5-PE	3036411	221	STTBs 4-TG	3035483	235	UBAL 95	1086475	584	UK 3-TWIN-PE	1923128	468
STS 2,5-QUATTRO	3031746	221	STTBu 4	3033155	233	UBAL 95 BK	1086478	584	UK 5 N	3004362	459
STS 2,5-QUATTRO BU	3036288	221	STTBu 4 BU	3033168	233	UBAL 95 BN	1086479	584	UK 5 N BU	3004388	459
STS 2,5-QUATTRO-PE	3031759	221	STTBu 4-PE	3033171	233	UBAL 95 BU	1086476	584	UK 5-HESI	3004100	492
STS 2,5-TG	3037009	222	STTBu 4-PV	3033184	233	UBAL 95 FE	1086480	584	UK 5-HESILA 250	3004142	492
STS 2,5-TWIN	3031720	221	STU 10/ 4X2,5	3033139	244	UBAL 95 GN	1086477	584	UK 5-HESILED 24	3004126	492
STS 2,5-TWIN BU	3036275	221	STU 10/ 4X2,5 BU	3033142	244	UDB 2X25/16 BK	3071356	580	UK 5-MTK	3004430	513
STS 2,5-TWIN-PE	3031733	221	STU 2,5-TWIN	3033016	220	UDB 2X25/16 BN	3071357	580	UK 5-MTK-P/P	3004032	513
STS 4	3036424	233	STU 2,5-TWIN BU	3033029	220	UDB 2X25/16 BU	3071358	580	UK 5-MTK-P/P BU	3004058	513
STS 4 BU	3036437	233	STU 2,5-TWIN-PE	3033032	220	UDB 2X25/16 GN	3071359	580	UK 5-TWIN	1923021	467
STS 4-PE	3036440	233	STU 35/ 4X10	3033126	249	UDB 2X25/16 GY	3071355	580	UK 5-TWIN BU	1923047	467
STS 4-QUATTRO	3031681	234	STU 35/ 4X10 BU	3033210	249	UDB 2X35/25 BK	3071351	581	UK 5-TWIN-PE	1923076	469
STS 4-QUATTRO BU	3036301	234	STU 4-TWIN	3033058	233	UDB 2X35/25 BN	3071352	581	UK 6 N	3004524	460
STS 4-QUATTRO-PE	3031694	234	STU 4-TWIN BU	3033061	233	UDB 2X35/25 BU	3071353	581	UK 6 N BU	3004977	460
STS 4-TWIN	3031665	233	STU 4-TWIN-PE	3033074	233	UDB 2X35/25 GN	3071354	581	UK 6,3-HESI	3004171	493
STS 4-TWIN BU	3036291	233	SZF 0-0,4X2,5	1204504	38	UDB 2X35/25 GY	3071350	581	UK 6,3-HESILA 250	3004249	493
STS 4-TWIN-PE	3031678	233	SZF 1-0,6X3,5	1204517	70	UDK 3	2775375	470	UK 6,3-HESILED 24	3004265	493
STS 4-TWIN/L	3036592	234	SZF 2-0,8X4,0	1204520	110	UDK 3 BU	2718277	470	UK 6-FSI/C	3118203	499
STS 4-TWIN/L BU	3036589	234	SZF 3-1,0X5,5	1206612	120	UDK 3-PE	2775456	471	UK 6-FSI/C-LED12	3001925	499
STS 6	3038121	239	SZG 0,6X3,5 VDE	1205121	507	UDK 4	2775016	471	UK 6-FSI/C-LED24	3001938	499
STS 6 BU	3038134	239	SZG 0,9X6,5 VDE	1205134	388	UDK 4 BU	2775090	471	UK 10 N	3005073	461
STS 6-PE	3038147	239	SZK PH2 VDE	1205163	569	UDK 4-DUR	2775207	530	UK 10 N BU	3005086	461
STS 6-TWIN	3038150	239	SZS 0,4X2,5 VDE	1205037	458	UDK 4-DUR 249	2775249	530	UK 10,3-CC HESI A	1045682	501
STS 6-TWIN BU	3038163	239	SZS 0,6X3,5	1205053	563	UDK 4-ILA 500	2775061	531	UK 10,3-CC HESI A 2POL	1045693	501
STS 6-TWIN-PE	3038176	239	SZS 1,0X4,0 VDE	1205066	172	UDK 4-MTK-P/P	2775210	514	UK 10,3-CC HESI A 3POL	1045698	501
STTB 1,5	3031157	208	SZS 1,0X6,5 VDE	1205079	184	UDK 4-MTK-P/P BU	2775223	514	UK 10,3-CC HESILED A 600V	1045716	501
STTB 1,5 BU	3031160	208	SZS 1,2X8,0 VDE	1205082	188	UDK 4-PE	2775184	471	UK 10,3-CC HESILED A 600V 2POL	1045718	501
STTB 1,5-PE	3036013	208				UDK 4-TG	2777014	507	UK 10,3-CC HESILED A 600V 3POL	1045719	501
STTB 1,5-PV	3031526	208				UDMTK 5-P/P	3101087	515	UK 10,3-HESI A 1500V	1069842	504
STTB 2,5	3031270	212				UDMTK 5-P/P BU	3101113	515	UK 10,3-HESI A	1045676	500
STTB 2,5 BU	3031283	212				UDMTK 5-TWIN-P/P	3101126	515	UK 10,3-HESI A 1000V	1045720	502
STTB 2,5-2DIO/O-UL/O-UR	3031597	219				UDMTK 5-TWIN-P/P BU	3101139	515	UK 10,3-HESILED A 600V 2POL	1045723	502
STTB 2,5-2DIO/O-UL/UR-UL	3031584	219				UDMTKB 5-P/P	3024478	515	UK 10,3-HESILED A 690V	1045690	500
STTB 2,5-DIO/O-U	3031555	219				UGSK 6	3026285	523	UK 10-DREHSI (5X20)	3005109	496
STTB 2,5-DIO/O	3031563	219	TM-PTRV 4,QR:1-4	0803464	49	UGSK/S	0305080	517	UK 10-DREHSI (6,3X32)	3005507	497
STTB 2,5-DIO/UL-UR	3031571	219	TM-PTRV 4,QR:4-1	0803465	49	UGSK/S + GS	0313085	517	UK 10-DREHSI/K (5X25)	3005688	497
STTB 2,5-L/N	3036330	212	TM-PTRV 4,QR:A-D	0803466	49	UHK 4-FS(8-2,8-0,8)	2017237	535	UK 10-DREHSILA 250 (5X20)	3005170	496
STTB 2,5-LA 24 RD	3031607	219	TM-PTRV 4,QR:D-A	0803467	49	UHK 4-FS/FS(12-2,8-0,8)	2017224	535	UK 10-DREHSILA 250 (6,3X32)	3005662	497

Index

Alphabetical

Type	Order No.	Page	Type	Order No.	Page	Type	Order No.	Page	Type	Order No.	Page
UK 10-DREHSILED 12 (5X20)	3005112	496	UKK 5-HESI (6,3X32)	3007217	495	UPBV 2,5/ 1-R GNYE	3045392	307	USST 4-TG	3070301	547
UK 10-DREHSILED 24 (5X20)	3005138	496	UKK 5-HESILED 24 (5X20)	3026654	494	UPBV 2,5/ 2	3045402	306	USST 4-TG P/P	3070303	547
UK 10-DREHSILED 24 (6,3X32)	3005646	497	UKK 5-HESILED 24 (6,3X32)	0711632	495	UPBV 2,5/ 3	3045415	306	USST 6	3070341	546
UK 10-DREHSILED 60 (5X20)	3005154	496	UKK 5-LA 230	2791359	529	UPBV 2,5/ 4	3045428	306	USST 6-T	3070312	548
UK 10-PLUS	3001381	467	UKK 5-LA 24 RD/U-O	2791320	529	UPBV 2,5/ 5	3045431	306	USST 6-T/SB	3070310	550
UK 10-PLUS BU	3001475	467	UKK 5-MTK-P/P	2800004	514	UPBV 2,5/ 6	3045444	306	USST 6-T/SP	3070330	551
UK 10-PLUS-PE	3001420	469	UKK 5-MTK-P/P-LA 24RD/O-U	2800020	514	UPBV 2,5/ 7	3045457	306	USST 6	3070325	549
UK 10-TWIN	3005196	467	UKK 5-MTKD-P/P	2800017	514	UPBV 2,5/ 8	3045460	306	USST 6/SP	3070331	551
UK 10-TWIN BU	3005235	467	UKK 5-PE	2774211	475	UPBV 2,5/ 9	3045473	306	UT 10	3044160	183
UK 10-TWIN-PE	3001433	469	UKK 5-PV	2791388	473	UPBV 2,5/10	3045499	306	UT 10 BU	3044188	183
UK 16 N	3006043	461	UKK 5-TG	3007042	507	UPBV 2,5/11	3045509	306	UT 10-PE	3044173	183
UK 16 N BU	3006056	461	UKKB 3	2771010	472	UPBV 2,5/12	3045512	306	UT 16	3044199	185
UK 35 N	3074130	461	UKKB 3 BU	2771094	472	UPBV 2,5/13	3045525	306	UT 16 BU	3044209	185
UK 35 N BU	3058350	461	UKKB 5	2771146	473	UPBV 2,5/14	3045538	306	UT 16-PE	3044212	185
UK 4-SD	3248681	526	UKKB 5 BU	3216053	473	UPBV 2,5/15	3045541	306	UT 16-PE/S	3215915	185
UK 5-N-MT	3000563	513	UKKB 5-PE	3007123	475	UPBV 4/ 1	3045800	335	UT 2,5	3044076	149
UK 5-N-TG	3000604	509	UKKB 10	2772077	474	UPBV 4/ 1 BU	3045266	335	UT 2,5 BU	3044089	149
UK 5-HEDI N	3000564	491	UKKB 10-PV	3003567	474	UPBV 4/ 1 GNYE	3045279	335	UT 2,5-3L	3214259	150
UK 5-HEDI N GY	3000752	491	UKKB 10/2,5	2771007	474	UPBV 4/ 1-L	3045716	335	UT 2,5-3L BU	3002389	150
UK 5-HESI N	3000539	490	UKKB 10/2,5-PV	2775485	474	UPBV 4/ 1-L BU	3045729	335	UT 2,5-3L-LA24RD/O-M	3214288	150
UK 5-HESILA 250 N	3000542	490	UP 4-4CT	3208720	334	UPBV 4/ 1-L GNYE	3045732	335	UT 2,5-3PE	3214275	150
UK 5-HESILED 24 N	3000540	490	UP 4-4VT	3208721	334	UPBV 4/ 1-M	3045745	335	UT 2,5-3PV	3214262	150
UK 5-HESILED 60 N	3000541	490	UP 4/ 1	3060115	336	UPBV 4/ 1-M BU	3045758	335	UT 2,5-MT	3046362	152
UK 5-MTD N	3000562	491	UP 4/ 1 BU	3045282	336	UPBV 4/ 1-M GNYE	3045761	335	UT 2,5-MT BU	3046553	152
UK 6-T	3072803	521	UP 4/ 1 GNYE	3045295	336	UPBV 4/ 1-R	3045774	335	UT 2,5-MT P/P BU	3046566	152
UK 6-T-P	3072800	520	UP 4/ 1-L	3060021	336	UPBV 4/ 1-R BU	3045787	335	UT 2,5-MT-P/P	3046375	152
UK 6-TK-P	3072804	521	UP 4/ 1-L BU	3060034	336	UPBV 4/ 1-R GNYE	3045790	335	UT 2,5-MTD	3064085	153
UK-SI	3118012	498	UP 4/ 1-L GNYE	3060047	336	UPBV 4/ 2	3045813	335	UT 2,5-MTD BU	3064108	153
UK-SI BU	3118096	498	UP 4/ 1-M	3060050	336	UPBV 4/ 3	3045826	335	UT 2,5-MTD P/P	3064098	153
UKD 6	3072801	521	UP 4/ 1-M BU	3060063	336	UPBV 4/ 4	3045839	335	UT 2,5-MTD-DIO/L-R	3064137	153
UKH 50	3009118	189	UP 4/ 1-M GNYE	3060076	336	UPBV 4/ 5	3045842	335	UT 2,5-MTD-DIO/R-L	3064140	153
UKH 50 BU	3009105	189	UP 4/ 1-R	3060089	336	UPBV 4/ 6	3045855	335	UT 2,5-MTD-PE	3064124	153
UKH 50 EP	3009228	188	UP 4/ 1-R BU	3060092	336	UPBV 4/ 7	3045868	335	UT 2,5-PE	3044092	149
UKH 50-F	3247019	189	UP 4/ 1-R GNYE	3060102	336	UPBV 4/ 8	3045871	335	UT 2,5-PE/L/L	3214301	150
UKH 95	3010013	195	UP 4/ 2	3060128	336	UPBV 4/ 9	3045884	335	UT 2,5-PE/L/N	3214291	150
UKH 95 BU	3010136	195	UP 4/ 3	3060131	336	UPBV 4/10	3045897	335	UT 2,5-QUATTRO	3044542	149
UKH 95 EP	3009231	194	UP 4/ 4	3060144	336	UPBV 4/11	3045907	335	UT 2,5-QUATTRO BU	3044555	149
UKH 95-F	3247022	195	UP 4/ 5	3060157	336	UPBV 4/12	3045910	335	UT 2,5-QUATTRO-PE	3044568	149
UKH 150	3010110	197	UP 4/ 6	3060160	336	UPBV 4/13	3045923	335	UT 2,5-TG	3046388	151
UKH 150 1500V	3247433	197	UP 4/ 7	3060173	336	UPBV 4/14	3045936	335	UT 2,5-TG BU	3046579	151
UKH 150 1500V BU	3247434	197	UP 4/ 8	3060186	336	UPBV 4/15	3045949	335	UT 2,5-TG-P/P	3046391	151
UKH 150 BU	3010123	197	UP 4/ 9	3060199	336	UPCT 4/2	3057461	332	UT 2,5-TG-P/P BU	3046582	151
UKH 150-F	3247035	197	UP 4/10	3060209	336	UPCT 4/3	3057458	332	UT 2,5-TWIN	3044513	149
UKH 150/240 EP	3009244	196	UP 4/11	3060212	336	UPR/ 2	3045567	363	UT 2,5-TWIN BU	3044526	149
UKH 240	3010217	199	UP 4/12	3060225	336	UPRZ	3045570	363	UT 2,5-TWIN-PE	3044539	149
UKH 240 BU	0711852	199	UP 4/13	3060238	336	UPZ/ 2	3045554	362	UT 2,5-TWIN/1P	3060490	303
UKH 240-F	3247048	199	UP 4/14	3060241	336	URDK 6	3026706	523	UT 2,5-TWIN/1P BU	3060500	303
UKH 50 1500V	3247400	189	UP 4/15	3060254	336	URTK 6	3026272	523	UT 2,5-TWIN/1P-F	3061172	373
UKH 50 1500V BU	3247402	189	UP 6/ 1	3060610	356	URTK/S	0311087	519	UT 2,5-TWIN/1P-PE	3060513	303
UKH 70	3213140	191	UP 6/ 1 BU	3060717	356	URTK/S-BEN 10	0309109	519	UT 2,5/1P	3045017	303
UKH 70 1500V	3247461	191	UP 6/ 1 GNYE	3060720	356	URTK/SP	0311126	525	UT 2,5/1P BU	3045020	303
UKH 70 BU	3244601	191	UP 6/ 1-L	3060733	357	URTK/SS	0321019	517	UT 2,5/1P-F	3060445	373
UKH 70-3L	3076329	191	UP 6/ 1-L BU	3060746	357	URTKD/SP	0311142	525	UT 2,5/1P-PE	3045033	303
UKH 70-3L-F	3076484	191	UP 6/ 1-L GNYE	3060759	357	USB 2-RTK/S	0311278	519	UT 35	3044225	187
UKH 70-3L/FE	3076400	191	UP 6/ 1-M	3060762	357	USBR 2-11	3001356	567	UT 35 BU	3044238	187
UKH 70-3L/FE-F	3076565	191	UP 6/ 1-M BU	3060775	357	USBR 2-7	2303239	459	UT 35-PE	3044241	187
UKH 70-3L/N	3076361	191	UP 6/ 1-M GNYE	3060788	357	USIG	0920083	498	UT 35-PE/S	3215928	187
UKH 70-3L/N-F	3076523	191	UP 6/ 1-R	3060791	357	USIG BU	0920122	498	UT 4	3044102	159
UKH 70-3L/N/FE	3076442	191	UP 6/ 1-R BU	3060801	357	USK 4-FS/FS(8-2,8-0,8)	0271017	537	UT 4 BU	3044115	159
UKH 70-3L/N/FE-F	3076604	191	UP 6/ 1-R GNYE	3060814	357	USK 4-FSR(4-2,8-0,8)	0270018	537	UT 4-HEDI	3046249	161
UKH 70-F	3247051	191	UP 6/ 2	3060623	356	USLKG 1,5 N	3005853	462	UT 4-HEDI-P/P	3046252	161
UKH 70-PE/S	3213141	191	UP 6/ 3	3060636	356	USLKG 10 N	3003923	464	UT 4-HESI (5X20)	3046032	161
UKH 70/4X10	3213142	192	UP 6/ 4	3060649	356	USLKG 10 N-1	0442082	464	UT 4-HESILA 250 (5X20)	3046100	161
UKH 70/4X10 BU	3213143	192	UP 6/ 5	3060652	356	USLKG 16 N	0443023	465	UT 4-HESILED 24 (5X20)	3046090	161
UKH 70/4X10-PE	3213144	193	UP 6/ 6	3060665	356	USLKG 16 N-1	0443036	465	UT 4-HESILED 24 (5X20) 120KOHM	3248005	161
UKH 95 1500V	3247419	195	UP 6/ 7	3060678	356	USLKG 2,5 N	0441119	462	UT 4-HESILED 60 (5X20)	3046126	161
UKH 95 1500V BU	3247420	195	UP 6/ 8	3060681	356	USLKG 2,5 N-1	0443081	462	UT 4-L	3214363	160
UKK 3	2770011	472	UP 6/ 9	3060694	356	USLKG 3	0441083	463	UT 4-L/HESI (5X20)	3214325	162
UKK 3 BU	2770095	472	UP 6/10	3060704	356	USLKG 3-1	0441106	463	UT 4-L/HESILA 250 (5X20)	3214368	162
UKK 4-FS	2770561	538	UPBV 2,5/ 1	3045145	306	USLKG 35 N	3074143	465	UT 4-L/HESILED 24 (5X20)	3214366	162
UKK 4-FS/FS	2771133	539	UPBV 2,5/ 1 BU	3045240	306	USLKG 5	0441504	463	UT 4-L/HESILED 60 (5X20)	3214367	162
UKK 5	2774017	473	UPBV 2,5/ 1 GNYE	3045253	306	USLKG 5-1	0441517	463	UT 4-L/L	3214362	160
UKK 5 BU	2774091	473	UPBV 2,5/ 1-L	3045318	307	USLKG 50	0443049	189	UT 4-MT	3046139	165
UKK 5-2 BE	3048030	528	UPBV 2,5/ 1-L BU	3045321	307	USLKG 6 N	0442079	463	UT 4-MT BU	3046278	165
UKK 5-2DIO/O-ULUR-UL	2791113	528	UPBV 2,5/ 1-L GNYE	3045334	307	USLKG 6 N-1	0444048	463	UT 4-MT-EX	3046141	165
UKK 5-BE	3048027	528	UPBV 2,5/ 1-M	3045347	307	USLKG 95	0441041	195	UT 4-MT-P/P	3046171	165
UKK 5-DIO/O-U	2791016	528	UPBV 2,5/ 1-M BU	3045350	307	USST 10	3070354	546	UT 4-MT-P/P BU	3046265	165
UKK 5-DIO/U-O	2791032	528	UPBV 2,5/ 1-M GNYE	3045363	307	USST 4	3070338	545	UT 4-MT-P-P-EX	3046173	165
UKK 5-DIO/UL-UR	2791029	528	UPBV 2,5/ 1-R	3045376	307	USST 4-MT	3070300	547	UT 4-MTD	3046184	168
UKK 5-HESI (5X20)	3007204	494	UPBV 2,5/ 1-R BU	3045389	307	USST 4-MT P/P	3070302	547	UT 4-MTD BU	3046197	168

Type	Order No.	Page	Type	Order No.	Page	Type	Order No.	Page	Type	Order No.	Page
UT 4-MTD-DIO/L-R	3046210	168	UT 6-HESILA 250 (6,3X32)	3046430	173	UTRE 6-2/23	3069824	623	UTWE 6-2/7	3069654	623
UT 4-MTD-DIO/R-L	3046236	168	UT 6-HESILED 24 (6,3X32)	3046414	173	UTRE 6-2/24	3069825	623	UTWE 6-2/8	3069655	623
UT 4-MTD-PE	3046223	168	UT 6-HESILED 60 (6,3X32)	3046427	173	UTRE 6-2/25	3069826	623	UTWE 6-2/9	3069656	623
UT 4-MTD-PE/S	3046207	168	UT 6-MT	3064069	175	UTRE 6-2/4	3069805	623	UTWE 6-2/A14	3069413	630
UT 4-MTL	3046144	166	UT 6-MT BU	3073267	175	UTRE 6-2/5	3069806	623	UTWE 6-2/A7	3069410	630
UT 4-MTL KNIFE-RD	3046152	166	UT 6-MT P/P	3064072	175	UTRE 6-2/6	3069807	623	UTWE 6-2/B14	3069414	630
UT 4-MTL KNIFE-WH	3046148	166	UT 6-MT P/P BU	3073270	175	UTRE 6-2/7	3069808	623	UTWE 6-2/B19	3069416	630
UT 4-MTL-P/P	3046146	166	UT 6-MTL	3046145	175	UTRE 6-2/8	3069809	623	UTWE 6-2/B7	3069411	630
UT 4-MTL-P/P KNIFE-RD	3046154	166	UT 6-MTL KNIFE-RD	3046153	175	UTRE 6-2/9	3069810	623	UTWE 6-2/C14	3069415	630
UT 4-MTL-P/P KNIFE-WH	3046150	166	UT 6-MTL KNIFE-WH	3046149	175	UTRE 6-2/A14	3069424	630	UTWE 6-2/C19	3069417	630
UT 4-PE	3044128	159	UT 6-MTL P/P	3046147	175	UTRE 6-2/A7	3069423	630	UTWE 6-2/D19	3069418	630
UT 4-PE/HEDI	3074004	161	UT 6-MTL P/P KNIFE-WH	3046151	175	UTRE 6-2/B14	3069427	630	UTWE 6-2/E7	3069412	630
UT 4-PE/HESI (5X20)	3073995	161	UT 6-MTL-P/P KNIFE-RD	3046155	175	UTRE 6-2/B19	3069429	630	UTWE 6-2/F19	3069419	630
UT 4-PE/HESI LA 250 (5X20)	3070079	161	UT 6-PE	3044157	173	UTRE 6-2/B7	3069424	630	UTWE 6-2/G19	3069420	630
UT 4-PE/HESI LED 24 (5X20)	3070053	161	UT 6-QUATTRO/2P	3060568	355	UTRE 6-2/C14	3069428	630	UTWE 6-2/H19	3069421	630
UT 4-PE/HESILED 60 (5X20)	3070066	161	UT 6-QUATTRO/2P BU	3060571	355	UTRE 6-2/C19	3069430	630	UTWE 6-2/I19	3069422	630
UT 4-PE/L-DIO/L-R P/P	3046834	168	UT 6-QUATTRO/2P-F	3060843	373	UTRE 6-2/D19	3069431	630	UTWE 6/10+1	1029712	614
UT 4-PE/L-DIO/R-L P/P	3046235	168	UT 6-QUATTRO/2P-PE	3060584	355	UTRE 6-2/E7	3069425	630	UTWE 6/11+1	1029713	614
UT 4-PE/L/HEDI	3214324	162	UT 6-T-HV	3070134	176	UTRE 6-2/F19	3069432	630	UTWE 6/12+1	3069077	614
UT 4-PE/L/HESI (5X20)	3214320	162	UT 6-T-HV P/P	3070121	176	UTRE 6-2/G19	3069433	630	UTWE 6/3+1	3069047	614
UT 4-PE/L/HESILED 24 (5X20)	3214321	162	UT 6-T/SP	3072815	176	UTRE 6-2/H19	3069434	630	UTWE 6/4+1	3069048	614
UT 4-PE/L/HESILED 250 (5X20)	3214323	162	UT 6-TG	3064885	174	UTRE 6-2/I19	3069435	630	UTWE 6/4+1 BI	3070008	614
UT 4-PE/L/HESILED 60 (5X20)	3214322	162	UT 6-TG BU	3073856	174	UTT 2,5-2MT	3044679	152	UTWE 6/5+1	3069049	614
UT 4-PE/L/L	3214360	160	UT 6-TG P/P	3073869	174	UTT 2,5-2MT BU	3044680	152	UTWE 6/6+1	3069051	614
UT 4-PE/L/MT	3214364	162	UT 6-TG P/P BU	3073872	174	UTT 2,5-2MT-P/P	3044670	152	UTWE 6/6+1 BI	3069996	614
UT 4-PE/L/N	3214361	160	UT 6-TG P/P-EX	3073870	174	UTT 2,5-2MT-P/P BU	3044671	152	UTWE 6/7+1	3069065	614
UT 4-PE/L/TG	3214365	162	UT 6-TG-EX	3046486	174	UTT 2,5-2TG-P/P	3044674	151	UTWE 6/8+1	3069064	614
UT 4-PE/MT	3070011	167	UT 6/1P	3060539	355	UTTB 4	3044814	160	UTWE 6/9+1	1029711	614
UT 4-PE/MT P/P	3046140	167	UT 6/1P BU	3060542	355	UTTB 4 BU	3044791	160	UVKB 4-FS(6-2,8-0,8)	1954016	534
UT 4-PE/TG	3070024	164	UT 6/1P-PE	3060555	355	UTTB 4-MT	3044775	167	UVKB 4-FS/FS(8-2,8-0,8)	1953017	535
UT 4-PE/TG P/P	3070037	164	UTD 6/SP	3072817	176	UTTB 4-MT P/P	3044762	167	UXKK 4	2780014	473
UT 4-QUATTRO	3044571	159	UTI 16	3073827	185	UTTB 4-PE	3044759	160			
UT 4-QUATTRO BU	3044584	159	UTI 16 BU	3075728	185	UTTB 4-PV	3044733	160			
UT 4-QUATTRO HV	3048823	160	UTI 16-PE	3073830	185	UTTB 4-TG	3044720	164			
UT 4-QUATTRO HV BU	3048836	160	UTI 2,5-L	3076034	155	UTTB 2,5	3044636	149			
UT 4-QUATTRO-MT	3064043	166	UTI 2,5-L/L	3076031	155	UTTB 2,5 BU	3044649	149			
UT 4-QUATTRO-MT BU	3073050	166	UTI 2,5-L/LB	3076033	156	UTTB 2,5-2DIO/O-U/O-UR	3046689	153	VBST 4-FS(6-2,8-0,8)	0852012	536
UT 4-QUATTRO-MT P/P	3064056	166	UTI 2,5-L/N	3076035	155	UTTB 2,5-2DIO/O-UL/UR-UL	3046676	153	VBSTB 4-FS(6-2,8-0,8)	3070435	536
UT 4-QUATTRO-MT P/P BU	3073063	166	UTI 2,5-PE/L/L	3076029	155	UTTB 2,5-BE	3046744	154	VIOK 1,5	2718015	486
UT 4-QUATTRO-PE	3044597	159	UTI 2,5-PE/L/N	3076030	155	UTTB 2,5-DIO/O-U	3046650	153	VIOK 1,5-2D	2718196	487
UT 4-QUATTRO-TG	3064027	164	UTI 2,5-PE/L/NT	3076028	154	UTTB 2,5-DIO/U-O	3046663	153	VIOK 1,5-3D/PE	2718206	487
UT 4-QUATTRO-TG BU	3073076	164	UTI 2,5-PE/L/NTB	3076032	156	UTTB 2,5-DIO/UL-UR	3046728	153	VIOK 1,5-D/TG/D/PE	3011067	487
UT 4-QUATTRO-TG P/P	3064030	164	UTI 35	3074088	187	UTTB 2,5-L/N	3044681	150	VIOK 1,5-LA 24RD/O-MO	2718028	486
UT 4-QUATTRO-TG P/P BU	3073089	164	UTI 35 BU	3075731	187	UTTB 2,5-LA 230	3046715	154	VS-UK 10,3-HESI A 2POL	1045725	500
UT 4-QUATTRO/2P	3060296	329	UTI 35-PE	3074091	187	UTTB 2,5-LA 24 RD	3046692	154	VS-UK 10,3-HESI A 3POL	1045726	500
UT 4-QUATTRO/2P BU	3060306	329	UTI 6-L/L	3076042	178	UTTB 2,5-LA 60 RD	3046702	154			
UT 4-QUATTRO/2P-F	3060335	373	UTI 6-L/N	3076045	178	UTTB 2,5-MT-P/P	3044640	152			
UT 4-QUATTRO/2P-PE	3060319	329	UTI 6-PE/L/L	3076040	179	UTTB 2,5-MT-P/P BU	3044641	152			
UT 4-TG	3046142	163	UTI 6-PE/L/LT	3076043	180	UTTB 2,5-PE	3044665	149			
UT 4-TG BU	3073283	163	UTI 6-PE/L/N	3076041	179	UTTB 2,5-PE/L	3044678	150			
UT 4-TG-EX	3046143	163	UTI 6-PE/L/NT	3076039	180	UTTB 2,5-PE/N	3046731	150			
UT 4-TG-P/P	3046168	163	UTME 4	3047452	169	UTTB 2,5-PV	3044652	149			
UT 4-TG-P/P BU	3073296	163	UTME 4-CT/1P	3057432	332	UTTB 2,5-TG-P/P	3044644	151	WS 3-5	0805357	593
UT 4-TG-P/P-EX	3046169	163	UTME 4-P/P	3047453	169	UTTB 2,5/2P	3060351	303	WS 3-6	1004115	593
UT 4-TWIN	3044364	159	UTME 4-P/P BU	3047454	169	UTTB 2,5/2P BU	3060364	303	WS 3-8	1004128	593
UT 4-TWIN BU	3044500	159	UTME 4/1P	3057416	331	UTTB 2,5/2P-F	3060474	373	WS 4-5	0805344	593
UT 4-TWIN HV	3000608	159	UTME 6	3047400	177	UTTB 2,5/2P-PE	3060380	303	WS 4-6	1004209	593
UT 4-TWIN-MT	3046003	166	UTMED 4	3047465	169	UTTB 2,5/2P-PV	3060377	303	WS 4-8	1004212	593
UT 4-TWIN-MT BU	3073018	166	UTMED 4-PE	3047478	169	UTTB 2,5/2P-PV BU	3060487	303	WS 4-10	1004225	593
UT 4-TWIN-MT P/P	3064014	166	UTMED 6	3047413	177	UTTB 4 HV	3000610	160	WS 4-12	0805328	593
UT 4-TWIN-MT P/P BU	3073021	166	UTMED 6-PE	3047442	177	UTTB 4-MT P/P LA 24 RD/O-U	3046773	167	WS 4-15	1004241	593
UT 4-TWIN-PE	3044380	159	UTN 2,5	3245011	154	UTWE 6-2/10	3069658	623	WS 5-5	0805331	593
UT 4-TWIN-TG	3046595	164	UTN 4	3245024	170	UTWE 6-2/11	3069659	623	WS 5-6	1004403	593
UT 4-TWIN-TG BU	3073034	164	UTN 6	3245037	181	UTWE 6-2/12	3069660	623	WS 5-8	1004416	593
UT 4-TWIN-TG P/P	3046605	164	UTN 10	3245040	183	UTWE 6-2/13	3069662	623	WS 5-10	1004429	593
UT 4-TWIN-TG P/P BU	3073047	164	UTN 16	3245053	185	UTWE 6-2/14	3069663	623	WS 5-12	0805315	593
UT 4-TWIN/ 1P	3060267	329	UTN 35	3245066	187	UTWE 6-2/15	3069664	623	WS 5-15	1004445	593
UT 4-TWIN/ 1P BU	3060270	329	UTRE 6-2/10	3069811	623	UTWE 6-2/16	3069666	623	WS PT 10	1029030	420
UT 4-TWIN/ 1P-F	3060322	373	UTRE 6-2/11	3069812	623	UTWE 6-2/17	3069667	623	WS PT 16	1029033	420
UT 4-TWIN/ 1P-PE	3060283	329	UTRE 6-2/12	3069813	623	UTWE 6-2/18	3069668	623	WS PT 2,5	1029026	420
UT 4/ 1P	3045583	329	UTRE 6-2/13	3069814	623	UTWE 6-2/19	3069672	623	WS PT 4	1029563	420
UT 4/ 1P BU	3045596	329	UTRE 6-2/14	3069815	623	UTWE 6-2/20	3069673	623	WS PT 6	1029029	420
UT 4/ 1P-F	3060458	373	UTRE 6-2/15	3069816	623	UTWE 6-2/21	3069800	623	WS UT 10	3047361	420
UT 4/ 1P-H	3001369	329	UTRE 6-2/16	3069817	623	UTWE 6-2/22	3069801	623	WS UT 16	3047374	420
UT 4/ 1P-H-PE	3001372	329	UTRE 6-2/17	3069818	623	UTWE 6-2/23	3069802	623	WS UT 2,5	3047923	420
UT 4/ 1P-PE	3045606	329	UTRE 6-2/18	3069819	623	UTWE 6-2/24	3069803	623	WS UT 35	3047387	420
UT 6	3044131	173	UTRE 6-2/19	3069820	623	UTWE 6-2/25	3069804	623	WS UT 4	3047332	420
UT 6 BU	3044144	173	UTRE 6-2/20	3069821	623	UTWE 6-2/4	3069650	623	WS UT 6	3047345	420
UT 6-3L	3046703	173	UTRE 6-2/21	3069822	623	UTWE 6-2/5	3069651	623	WS-2K	1004513	395
UT 6-HESI (6,3X32)	3046401	173	UTRE 6-2/22	3069823	623	UTWE 6-2/6	3069652	623	WS-4K	1004584	395

V

W

Index

Alphabetical

Type	Order No.	Page	Type	Order No.	Page	Type	Order No.	Page
WS-DIO PT 2,5	1029037	421						
WS-G5/3	2720032	577						
WS-G5/4	2716499	577						
WST 1,5	3030958	420						
WST 10/35	3030006	420						
WST 2,5	3030941	420						
WST 4	3030954	420						
WST 6	3030967	420						
WT-BASE HF 9	3240704	617						
WT-D HF 7,5X200	3240712	617						

Z

ZB 8,3,LGS:FORTL.ZAHLEN	0803480	46
ZB 8,3,QR:FORTL.ZAHLEN	0803479	46
ZB 8,3:UNBEDRUCKT	0803444	46
ZBF 6/9,2 S8 CUS	8191575	46
ZBF 6/9,2 S8,LGS:1-8	0803450	46
ZBF 6/9,2 S8,LGS:A-H	0803451	46
ZBF 6/9,2 S8,QR:1-8	0803448	46
ZBF 6/9,2 S8,QR:A-H	0803449	46
ZBF 6/9,2 S8:UNBEDRUCKT	0803447	46

For up-to-date modifications or supplements
to the catalog contents, please visit:
phoenixcontact.net/webcode/#0132

