

Easy series

EasyPact™ EZC

Catalog 2021

Molded-case circuit breakers
from 15 to 630A



<https://www.se.com>

Life Is On

Schneider
Electric



Green Premium™

An industry leading portfolio of offers delivering sustainable value



More than 75% of our product sales offer superior transparency on the material content, regulatory information and environmental impact of our products:

- RoHS compliance
- REACH substance information
- Industry leading # of PEP's*
- Circularity instructions



Discover what we mean by green

[Check your products!](#)

The Green Premium program stands for our commitment to deliver customer valued sustainable performance. It has been upgraded with recognized environmental claims and extended to cover all offers including Products, Services and Solutions.

CO₂ and P&L impact through... Resource Performance

Green Premium brings improved resource efficiency throughout an asset's lifecycle. This includes efficient use of energy and natural resources, along with the minimization of CO₂ emissions.

Cost of ownership optimization through... Circular Performance

We're helping our customers optimize the total cost of ownership of their assets. To do this, we provide IoT-enabled solutions, as well as upgrade, repair, retrofit, and remanufacture services.

Peace of mind through... Well-being Performance

Green Premium products are RoHS and REACH compliant. We're going beyond regulatory compliance with step-by-step substitution of certain materials and substances from our products.

Improved sales through... Differentiation

Green Premium delivers strong value propositions through third-party labels and services. By collaborating with third-party organizations we can support our customers in meeting their sustainability goals such as green building certifications.

*PEP: Product Environmental Profile (i.e. Environmental Product Declaration)

So easy, so simple

With just three sizes of circuit breakers, Schneider Electric's EasyPact™ Ezc system is the simple, universal solution to fit all low-voltage protection needs.

- > The fixed version is particularly adapted to the OEM and Building markets, offering optimum performance at a competitive price.
- > The plug-in version offers an additional function dedicated to the Marine market.



Buildings



Marine



OEM

CPB100607-001



EasyPact™ Ezc range complies with worldwide standards :

- IEC 60947-2
- EN 60947-2
- JISC8201-2-1/C8201-2-2 (annex 1 and 2)
- GB 14048.2
- UL508 ⁽¹⁾
- CSA22-2 ⁽¹⁾

• IACS for Merchant Marine

(International Association of Classification Societies: ABS, BV, CCS, DNV, GL, KRS, LR, NK, RINA)**

⁽¹⁾ Only for the 100A model

With international certifications and approvals by independent laboratories:

ASEFA, KEMA, TILVA, TÜV, UL

And compliance with RoHS Directive

(Restriction of Hazardous Substances)

So easy, so simple

Easy to choose

EasyPact™ EZC brings you easy solutions

- > From 15 A to 630 A
- > Up to 50 kA at 415 V
- > Up to 4 poles
- > In only three frame sizes
- > With a complete range of auxiliaries: rotary commands, auxiliaries, shunt trip, phase barrier, terminal cover, undervoltage trip

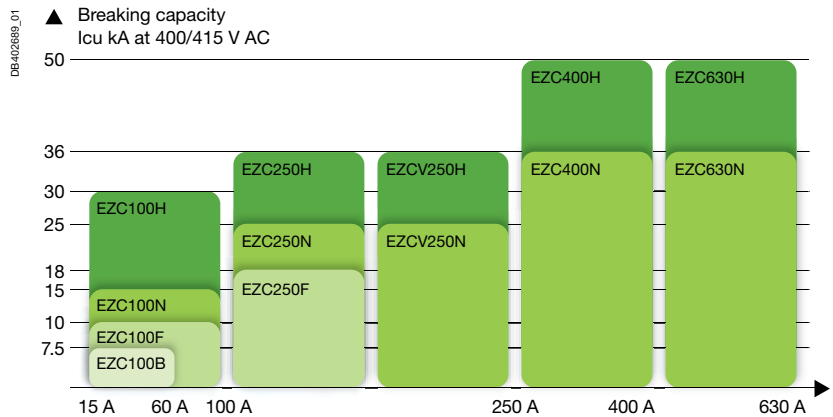

Easy to install

- > Fixed front mounting
- > Plug-in mounting
- > Front connections
- > Bare cables connected through cable lugs, screwed inside the breaker
- > Field-installable auxiliaries and accessories
- > Built-in earth-leakage protection
- > Interchangeable MCCB and ELCB



Easy to use

- > A thermal calibration suitable for MCCB use at 50 °C without derating (up to 250A)
- > Positive contact indication for safety and reliability
- > A smaller case optimized for tight spaces



EasyPact™ EZC:
Build your complete solution with Schneider Electric



Timely delivery, wherever you are

Schneider Electric offers a world-renowned logistics network capable of getting EasyPact™ EZC products to you fast, wherever you are.

Accessories

PB 104903

The new **plug-in accessory** reduces installation and maintenance time.

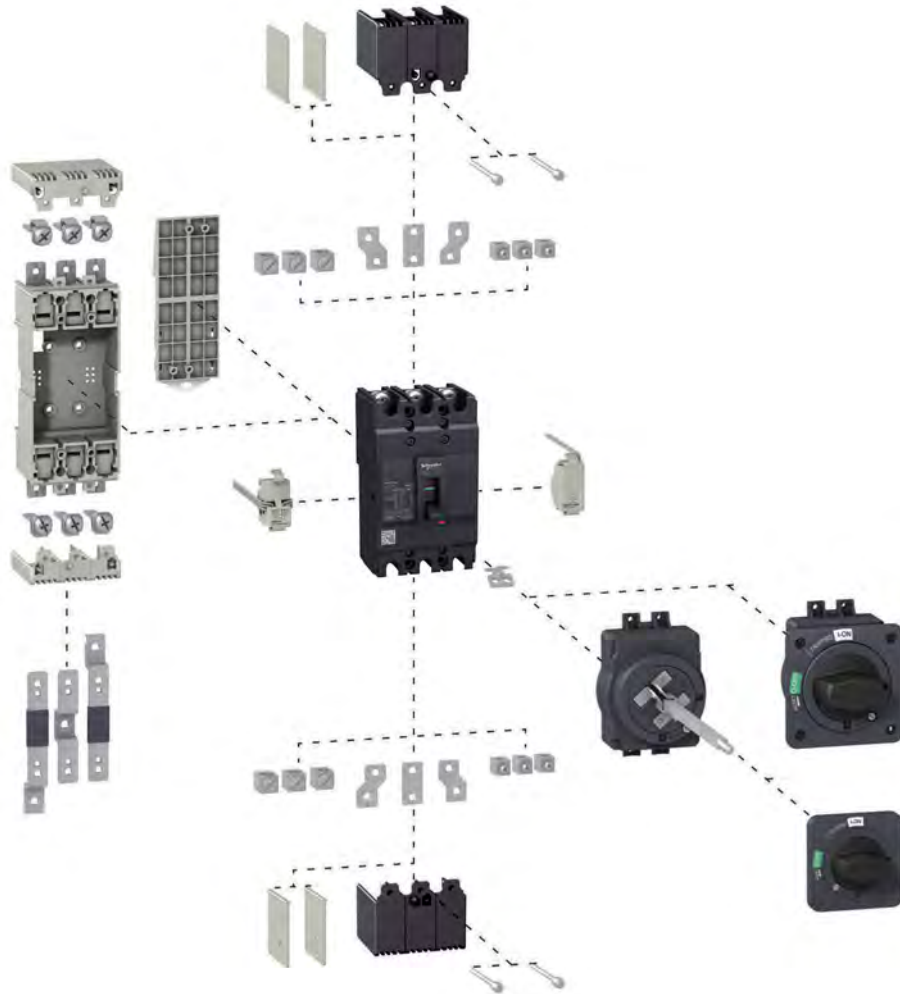

CPB 100609



The **fishbone**, designed for vertical installation, saves space and reduces cabling time.

CPB 100610



General contents

EasyPact™ EZC

Functions
and characteristics A-1

Installation guide B-1

Catalogue numbers C-1

Functions and characteristics



Functions and characteristics

<i>Presentation</i>	//
General characteristics	A-2
Selection table	A-6
Electrical and mechanical accessories overview	A-10
EasyPact EZC100	A-10
EasyPact EZC250	A-11
EasyPact EZCV250	A-12
EasyPact EZC400-630	A-13
Electrical auxiliaries 100-250AF	A-14
AX - AL - AXAL - ALV	A-14
SHT - UVR - UVRN	A-16
Direct rotary handle 100-250AF	A-18
Extended rotary handle 100-250AF	A-19
Plug-in	
100 A	A-20
Insulation of live parts	A-21
250 A	A-22
Insulation of live parts	A-23
Power connections and cable lugs 100-250AF	A-24
Power connections and insulation of live parts 100-250AF	A-25
DIN rail adaptor, padlocking, sealing screws 100-250AF	A-26
Accessories and auxiliaries of EZC400-630	A-27
Connection of devices	A-27
Selection of auxiliaries	A-29
Indication contacts	A-30
Remote tripping	A-31
Rotary handles escutcheons and protection collars	A-32
Locks and sealing accessories	A-33
<i>Installation guide</i>	<i>B-1</i>
<i>Catalogue numbers</i>	<i>C-1</i>

CDB500811



CDB500812

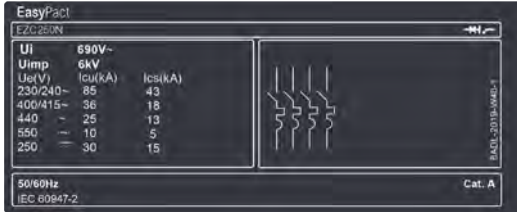

Standardised characteristics indicated on the rating plate:

- Ui: rated insulation voltage
- Uimp: rated impulse withstand voltage
- Ue: rated operational voltage
- Icu: ultimate breaking capacity, for various values of the rated operational voltage Ue
- Ics: service breaking capacity
- In: rated current
- suitability for isolation

EasyPact E2C circuit breakers and auxiliaries comply with the following international standards:

- IEC 60947-1 - general rules
- IEC 60947-2 - low-voltage switchgear and controlgear, part 2 (circuit breakers)
- European (EN 60947-1 and EN 60947-2) and the corresponding national standards
- GB 14048.2
- JIS C8201-2-1 Annex 1 and Annex 2, for moulded case circuit breakers
- JIS C8201-2-2 Annex 1 and Annex 2, for earth-leakage circuit breakers
- UL 60947-4-1(old UL508)/CSA 22-2 no. 14.

Approvals and Certifications

- IEC certification by independent laboratories (ASEFA, KEMA, TÜV)
- marking
- certified by third-party Tilva
- UL 60947-4-1(old UL508) certified by third party Underwriter Laboratories as a "Manual Motor Controller" (E2C100/E2C250/E2CV250).

Vibration and shock withstand test

EasyPact E2C circuit breakers resist mechanical vibrations and shocks. Tests are carried out in compliance with standard IEC 60068-2-6 for the levels required by merchant-marine inspection organisation IACS: International Association of Classification Societies up to 250 A (ABS, BV, DNV, LR, KRS, RINA, NK):

- 2 to 13.2 Hz: amplitude ± 1 mm
- 13.2 to 100 Hz: acceleration 0.7 g.

Pollution degree

EasyPact E2C circuit breakers are certified for operation in pollution-degree III environments as defined by IEC standard 60947 (industrial environments).

Tropicalization

EasyPact E2C circuit breakers have successfully passed the tests prescribed by the following standards for extreme atmospheric conditions:

- IEC 60068-2-1 - dry cold (-55 °C)
- IEC 60068-2-2 - dry heat (+85 °C)
- IEC 60068-2-30 - damp heat (95 % relative humidity at 55 °C)
- IEC 60068-2-52 - salt mist (severity level 2).

Positive contact indication

All EasyPact E2C circuit breakers are suitable for isolation as defined in IEC standard 60947-2:

- the isolation position corresponds to the O (OFF) position
- the operating handle cannot indicate the O (OFF) position ("green colour" visible) unless the contacts are effectively open
- padlocks may not be installed unless the contacts are open
- installation of a rotary handle does not alter the reliability of the position-indication system.

The isolation function is certified by tests guaranteeing:

- the mechanical reliability of the position indication system
- the absence of leakage currents
- overvoltage withstand capacity between upstream and downstream connections.

EasyPact E2C circuit breakers take into account important concerns for environmental protection. Most components are recyclable and the parts are marked as specified in applicable standards.

CPB100602



Ambient temperature

- EasyPact EZC circuit breakers have been particularly designed to hold 100 % In at 50 °C without tripping in normal condition (up to 250A, except earth leakage circuit breakers).
- EasyPact EZC circuit breakers may be used between -25 °C and +70 °C.
- The permissible storage-temperature range for EasyPact EZC circuit breakers in the original packing is -35 °C to +85 °C.

Installation

EasyPact EZC circuit breakers are designed for easy installation in the various types of switchboards. They may be mounted vertically, horizontally or flat on their back without any derating of characteristics.

Power supply

EasyPact EZC circuit breaker can be supplied from either the top or the bottom (reverse feeding) without any reduction in performance. For earth-leakage circuit breakers, reverse feeding is possible only up to 240 V AC. This capability facilitates connection when installed in a switchboard.

Degree of protection

As per standards IEC 60529 (IP degree of protection) and EN 50102 (IK degree of protection against external mechanical impacts).

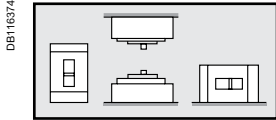

Installation positions.

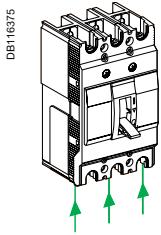

Reverse feeding.

Bare circuit breaker with terminal shields		
	With toggle	IP20 IK07
	With direct rotary handle standard	IP40 IK07
Circuit breaker installed in a switchboard		
	With toggle	IP40 IK07
	With direct rotary handle standard/VDE MCC	IP54 IK07
	With extended rotary handle	IP54 IK08

CPB100611



Earth-leakage protection

EasyPact EZC circuit breakers have a specific version including earth-leakage protection.

This protection is fully integrated inside the breaker and does not require any additional space.

EasyPact EZC circuit breakers and earth leakage circuit breakers are fully interchangeable.

Compliance with standards

EasyPact EZC earth leakage circuit breakers comply with all the international standards listed [page A-2](#):

- IEC 60947-1
- IEC 60947-2
- EN 60947-1
- EN 60947-2
- GB 14048.2
- JIS C8201-2-2 Annex 1 and Annex 2
- UL 60947-4-1(old UL508)/CSA 22-2 no. 14.

They also comply with:

- VDE 664, operation down to -25 °C
- IEC 60255-4 and IEC 60801-2 to 60801-5 covering protection against nuisance tripping due to transient overvoltages, lightning strikes, switching of devices on the distribution system, electrostatic discharges, radiofrequency interference.

DB125603

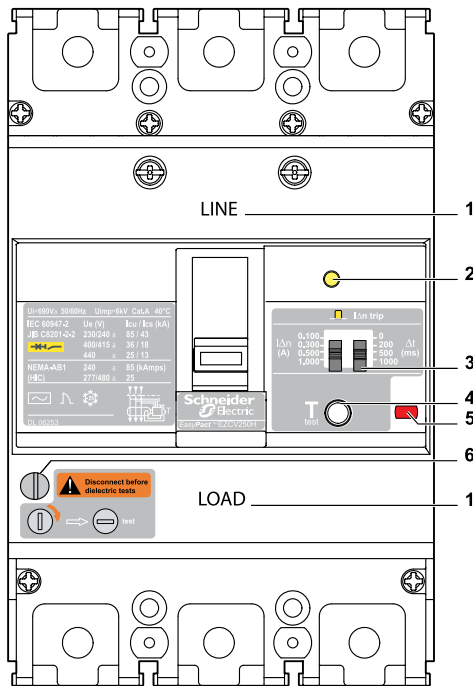

- 1 Line-Load ($U_e > 300$ V AC)
- 2 Mechanical indicator (ELCB)
- 3 Adjustable settings I_{Dn} and time delay
- 4 ELCB test button
- 5 Push to trip button (MCCB)
- 6 Dielectric tests: disconnecting switch

Power supply

Reverse feeding

EasyPact EZC earth-leakage circuit breakers can be supplied from either the top or the bottom for voltages up to 240 V AC. For voltages over 240 V AC, only supply from the top is possible (Line-Load indication on the cover of the breaker).

Power supply of the electronics

EasyPact EZC earth-leakage circuit breakers are self-supplied by the distribution-system voltage and therefore do not require any external source. They fully comply with new IEC requirements (Annex B): they are powered from the three phases and continue to function even if one phase is missing.

Dielectric tests

EasyPact EZC earth-leakage circuit breakers are equipped with a disconnecting switch in order to protect the electronics during dielectric tests.

When the disconnecting switch is activated, the circuit breaker is automatically tripped. It is mechanically impossible to switch on the circuit breaker, until the earth-leakage function is re-energised.

Tripping features

Tripping indications:

- EasyPact EZC earth-leakage circuit breakers have a yellow mechanical indicator to locally signal tripping due to an earth fault.
- EasyPact EZC earth-leakage circuit breakers may be equipped with an earth-leakage alarm switch (ALV) to remotely signal tripping due to an earth fault.

Resetting

EasyPact EZC earth-leakage circuit breakers are fully reset by the operating handle.

After resetting, tripping indicators (mechanical and ALV) come to normal position.

ELCB protection characteristics

Sensitivity I_{Dn} (A)		adjustable	0.1 - 0.3 - 0.5 - 1
Time delay	Intentional delay (ms)	adjustable	0 - 200 - 500 - 1000
	Max. breaking time (s)		0.15 - 0.4 - 1 - 2
Rated voltage	AC 50/60 Hz (V)		100...440

Earth-leakage circuit breakers

With three built-in protections:

- overload
- short-circuit
- earth-leakage.

From 63 A to 250 A

With adjustable sensibility and time delay

Up to 36 kA at 415 V

In 3 poles and 4 poles

DB125805

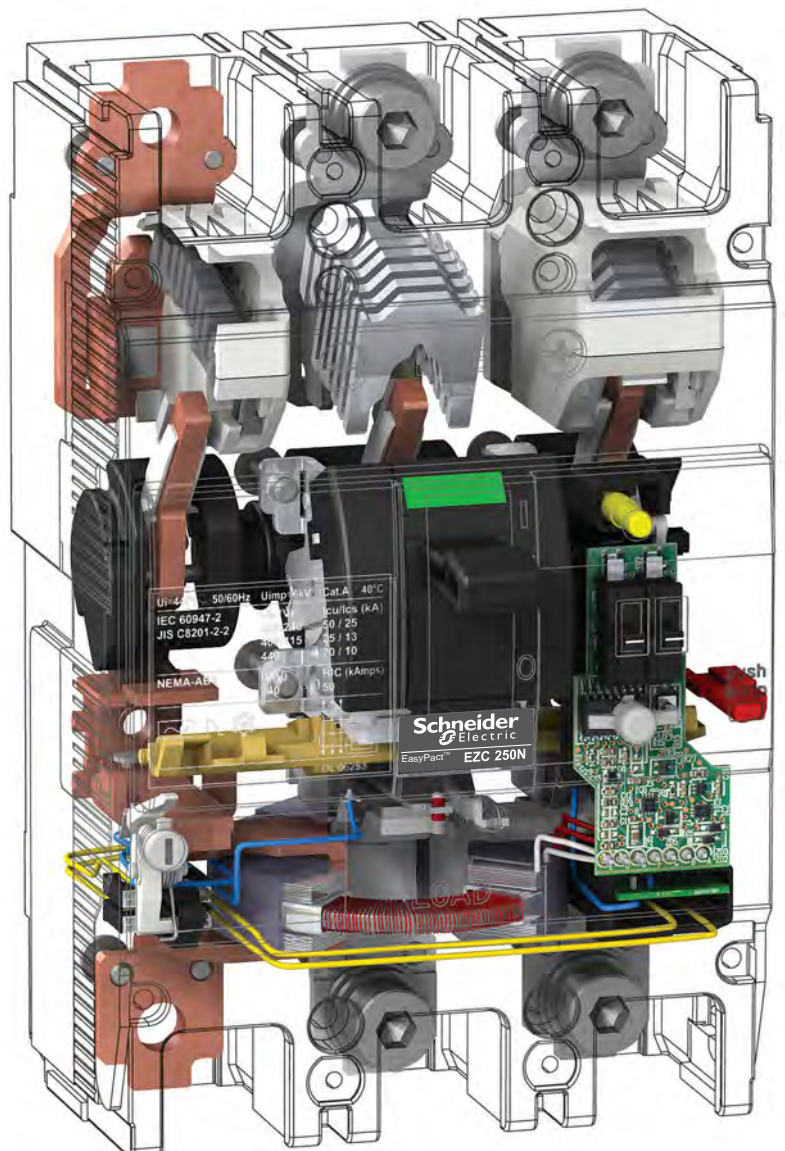

CPB100600



EZC100-1P.

CPB100601



EZC100-2P.

CPB100602



CPB100603



CPB100604



EasyPact EZC circuit breakers

Fixed version

Plug-in version

Number of poles

Rated current (A)	In	at 40 °C
Rated insulation voltage (V)	Ui	
Rated impulse withstand voltage (kV)	Uimp	
Rated operational voltage (V)	Ue	AC 50/60 Hz DC

Electrical characteristics as per IEC 60947-2, EN 60947-2, JIS C8201-2-1

Ultimate breaking capacity (kA rms)	Icu	AC 50/60 Hz	110/130 V
			220/230/240 V 380 V 400/415 V 440 V 550 V
Rated service breaking capacity (kA rms)	Ics	% Icu	DC 125 V (1P) 250 V (2P in series)
			110-400 V 415-550 V

Suitability for isolation

Utilisation category

Pollution degree

Endurance (C-O cycles)

Mechanical
Electrical In/415 V

Protection

Overload protection

Bimetal

Instantaneous protection

Magnetic

Fixed (±20 %)

Auxiliaries

Indication contacts

Auxiliary switch AX
Alarm switch AL
Combined AX + AL AXAL

Voltage releases

Shunt trip release SHT
Undervoltage release UVR

Installation

Connection

Crimp lugs/bars

Accessories

Box lugs for bare cables
Rotary handles Direct
Extended
Terminal extensions
Spreaders
Phase barriers
Terminal shields
Padlocking system
DIN rail adaptor

Dimension and weight

Dimensions (mm) D x H
W

Weight (kg)

	EZC100B	EZC100F	EZC100N	EZC100H		EZC250F	EZC250N	EZC250H
	■	■	■	■	■	■	■	■
	■	■	-	■ ⁽⁴⁾	-	■ ⁽⁴⁾	■	■
	3	3	1	3-4	1	2-3-4	3	3
	15, 16, 20, 25, 30, 32, 40, 45, 50, 60	15, 16, 20, 25, 30, 32, 40, 45, 50, 60, 63, 75, 80, 100	15, 16, 20, 25, 30, 32, 40, 45, 50, 60, 63, 75, 80, 100	15, 16, 20, 25, 30, 32, 40, 45, 50, 60, 63, 75, 80, 100	15, 16, 20, 25, 30, 32, 40, 45, 50, 60, 63, 75, 80, 100	15, 16, 20, 25, 30, 32, 40, 45, 50, 60, 63, 75, 80, 100	100, 125, 150, 160, 175, 200, 225, 250	100, 125, 150, 160, 175, 200, 225, 250
	690	690	690	690	690	690	690	690
	6	6	6	6	6	6	6	6
	550	550	415	550	415	550	550	550
	-	250	125	250	125	250	250	250
	10	25	25	25	50	100	25	50
	10	25	18	25	25	100 ⁽¹⁾	25	50
	7.5	10	2.5	18	5	30	18	25
	7.5	10	2.5	15	5	30	18	25
	5	7.5	-	10	-	20	15	20
	2.5	5	-	5	-	10	5	8
	-	5	5	5	10	10	5	20
	-	5	-	5	-	10	5	20
	25%	50%	50%	50%	50%	50%	50%	50%
	25%	50%	50%	50%	50%	25%	50%	50%
	■	■	■	■	■	■	■	■
	A	A	A	A	A	A	A	A
	3	3	3	3	3	3	3	3
	13 000	13 000	13 000	13 000	13 000	13 000	10 000	10 000
	4 000	4 000	4 000	4 000	4 000	4 000	5 000	5 000
	fixed	fixed	fixed	fixed	fixed	fixed	fixed	fixed
	fixed	fixed	fixed	fixed	fixed	fixed	10 In	10 In
	■	■	-	■	-	■	■	■
	■	■	-	■	-	■	■	■
	■	■	-	■	-	■	■	■
	■	■	-	■	-	■	■	■
	■	■	-	■	-	■	■	■
	■	■	■	■	■	■	■	■
	■	■	-	■	-	■ ⁽³⁾	■	■
	■	■	-	■	-	■ ⁽³⁾	■	■
	-	-	-	-	-	-	■	■
	■	■	■	■	■	■	■	■
	■	■	-	■	-	■ ⁽³⁾	■	■
	■	■	■	■	■	■	■	■
	■	■	■	■	■	■	■	■
	■	■	■	■	■	■	■	■
	60 x 130	60 x 130	60 x 130	60 x 130	60 x 130	60 x 130	60 x 165	60 x 165
	75	75	25	75 (3P) 100 (4P)	25	50 (2P) 75 (3P) 100 (4P)	105	105
	0.78	0.78	0.28	0.78 (3P) 1.0 (4P)	0.28	0.6 (2P) 0.78 (3P) 1.0 (4P)	1.3	1.3
								1.1 (2P) 1.3 (3P)

(1) 50 kA for 2 poles.
 (2) For 277 V only.
 (3) For 3 and 4 poles only.
 (4) For 3P only.

CPB100605



EZC250-4P.

CPB100606



EZCV250-4P.

CPB100607



EZC400-3P.

EasyPact EZC circuit breakers

Fixed version		
Plug-in version		
Number of poles		
Rated current (A)	In	at 40 °C

Rated insulation voltage (V)	Ui	
Rated impulse withstand voltage (kV)	Uimp	
Rated operational voltage (V)	Ue	AC 50/60 Hz DC

Electrical characteristics as per IEC 60947-2, EN 60947-2 and JIS C8201-2-1/C8201-2-2

Ultimate breaking capacity (kA rms)	Icu	AC 50/60 Hz	220/230 V
			380 V
			400/415 V
			440 V
DC			125 V (1P)
			250 V
			(2P in series)

Rated service breaking capacity (kA rms)	Ics	% Icu
Suitability for isolation		
Utilisation category		
Pollution degree		
Endurance (C-O cycles)	Mechanical	
	Electrical	In/415 V

Protection

Overload protection	Bimetal	
Instantaneous protection	Magnetic	fixed (± 20 %)

Earth-leakage protection

Sensitivity (A)	IΔn	adjustable
Time-delay (ms)	Δt	adjustable
Max. breaking time (s)	at 2 IΔn	

Auxiliaries

Indication contacts	Auxiliary switch	OF/AX
	Alarm switch	SD/AL
	Combined AX + AL	AXAL
	Earth-alarm switch	ALV
	Shunt trip release	MX/SHT
Voltage releases	Undervoltage release	MN/UVR

Installation

Connection	Crimp lugs / bars	
Accessories	Box lugs for bare cables	
	Rotary handles	Direct Extended
	Terminal extensions	
	Spreaders	
	Phase barriers	
	Terminal shields	
	Padlocking system	

Dimension and weight

Dimensions (mm)	D x H W
Weight (kg)	

EZC250N	EZC250H	EZCV250N	EZCV250H	EZC400N	EZC400H	EZC630N	EZC630H
■	■	■	■	■	■	■	■
■	■	■	■	-	-	-	-
4	4	3-4	3-4	3-4	3-4	3-4	3-4
63, 80, 100, 125, 150, 160, 175, 200, 225, 250	63, 80, 100, 125, 150, 160, 175, 200, 225, 250	63, 80, 100, 125, 150, 160, 175, 200, 225, 250	63, 80, 100, 125, 150, 160, 175, 200, 225, 250	320, 350, 400	320, 350, 400	400, 500, 600	400, 500, 600
690	690	440	440	690	690	690	690
6	6	6	6	6	6	6	6
550	550	440	440	440	440	440	440
250	250	-	-	-	-	-	-
50	85	50	85	40	70	40	70
25	36	25	36	36	50	36	50
25	36	25	36	36	50	36	50
20	25	20	25	36	50	36	50
8	10	-	-	-	-	-	-
20	30	-	-	-	-	-	-
20	30	-	-	-	-	-	-
50%	50%	50%	50%	100% (220-415V) 50% (440V)	100% (220-415V) 50% (440V)	100% (220-415V) 50% (440V)	100% (220-415V) 50% (440V)
■	■	■	■	■	■	■	■
A	A	A	A	A	A	A	A
3	3	3	3	3	3	3	3
10 000	10 000	10 000	10 000	10 000	10 000	10 000	10 000
5 000	5 000	5 000	5 000	4 000	4 000	3 000	3 000
fixed	fixed	fixed	fixed	fixed	fixed	fixed	fixed
10 In	10 In	10 In	10 In	10 In	10 In	10 In (400/500A) 5000A (600A)	10 In (400/500A) 5000A (600A)
-	-	0.1/0.3/0.5/1	0.1/0.3/0.5/1	-	-	-	-
-	-	0/200/500/1000	0/200/500/1000	-	-	-	-
-	-	0.15/0.4/1/2	0.15/0.4/1/2	-	-	-	-
■	■	■	■	■	■	■	■
■	■	■	■	■	■	■	■
■	■	■	■	■	■	■	■
-	-	■	■	-	-	-	-
■	■	■	■	■	■	■	■
■	■	■	■	■	■	■	■
■	■	■	■	■	■	■	■
■	■	■	■	■	■	■	■
■	■	■	■	■	■	■	■
■	■	■	■	■	■	■	■
■	■	■	■	■	■	■	■
■	■	■	■	■	■	■	■
68 x 165	68 x 165	68 x 165	68 x 165	110 x 255	110 x 255	110 x 255	110 x 255
140	140	105 (3P) 140 (4P)	105 (3P) 140 (4P)	140 (3P) 185 (4P)	140 (3P) 185 (4P)	140 (3P) 185 (4P)	140 (3P) 185 (4P)
1.8	1.8	1.6 (3P) 2.1 (4P)	1.6 (3P) 2.1 (4P)	4.8 (3P) 6.4 (4P)	4.8 (3P) 6.4 (4P)	4.8 (3P) 6.4 (4P)	4.8 (3P) 6.4 (4P)

Electrical and mechanical accessories overview EasyPact Ezc100

EasyPact Ezc circuit breaker Ezc100 comes with a full range of accessories to fulfil different application requirements and make it easy for the end-user.

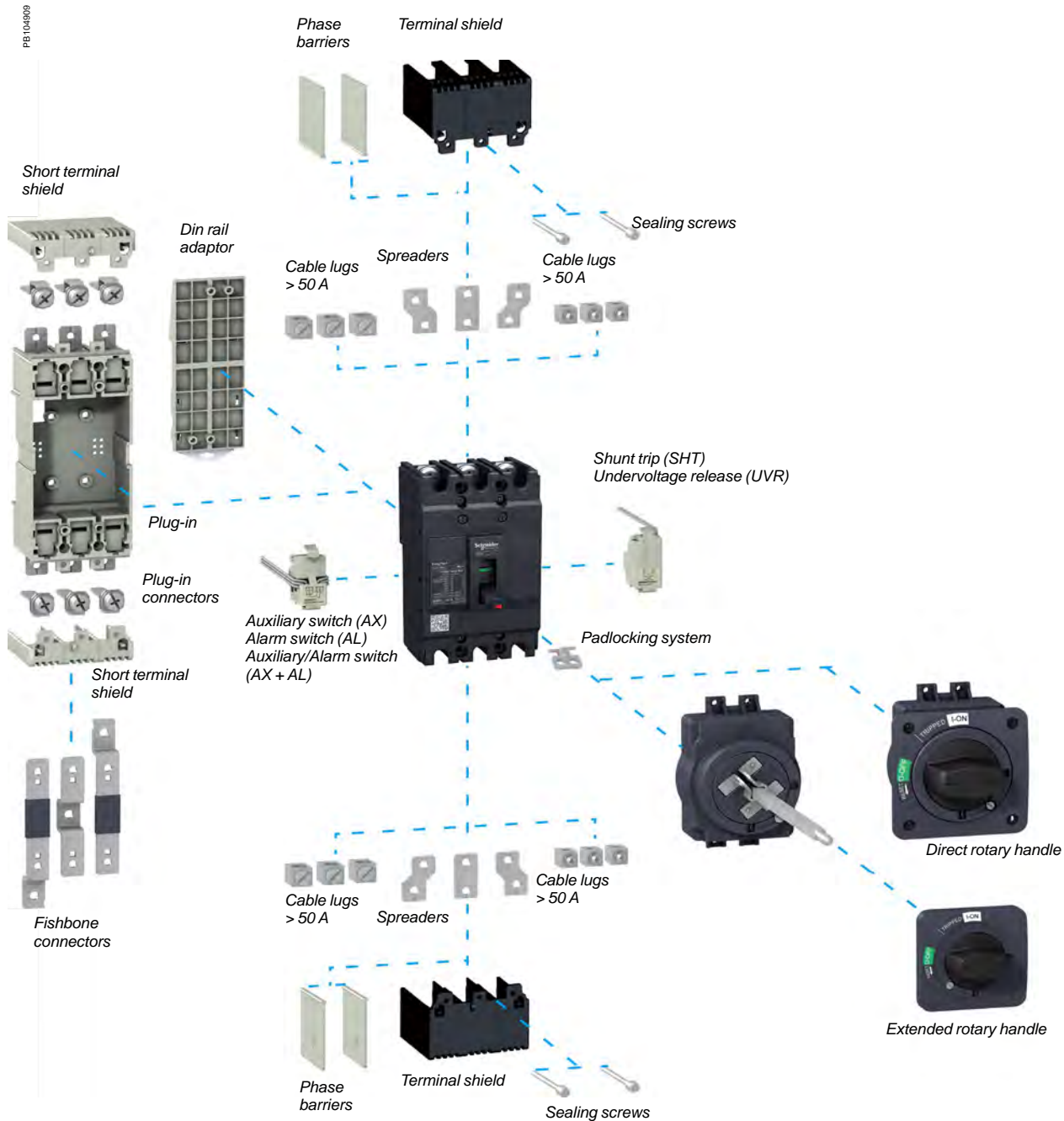

Electrical and mechanical accessories overview EasyPact EZC250

EasyPact EZC circuit breaker EZC250 comes with a full range of accessories to fulfil different application requirements and make it easy for the end-user.

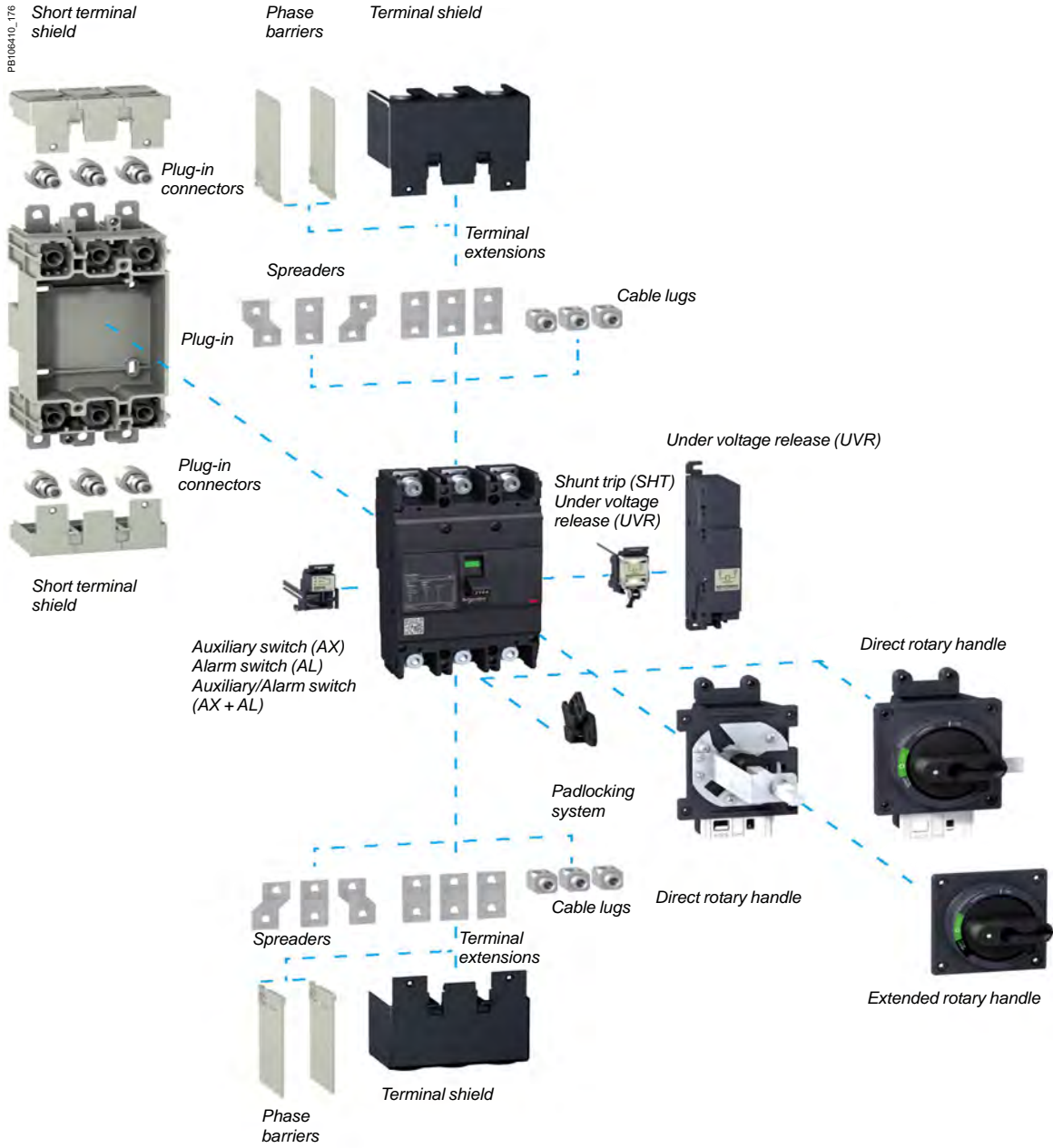

PB106410_176

Electrical and mechanical accessories overview

EasyPact EZCV250

EasyPact EZC circuit breaker EZCV250 comes with a full range of accessories to fulfil different application requirements and make it easy for the end-user.

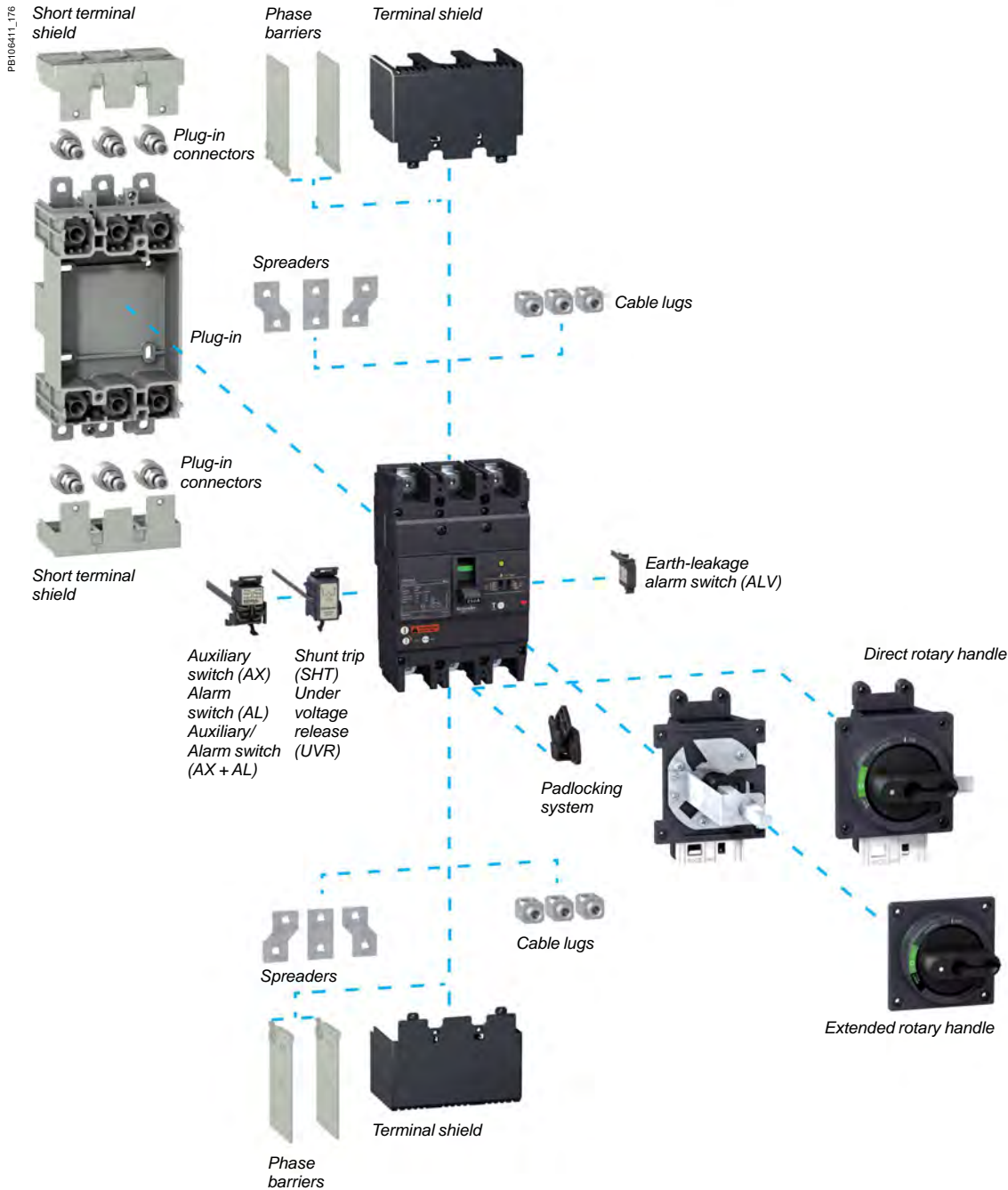

Electrical and mechanical accessories overview

EasyPact EZC400/630

EasyPact EZC circuit breaker EZC400-630 comes with a full range of accessories to fulfil different application requirements and make it easy for the end-user.

DB400001_1 **Insulation accessories**

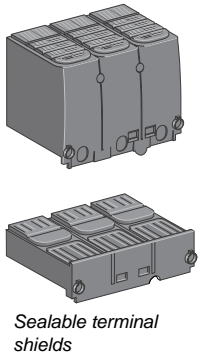

Connection

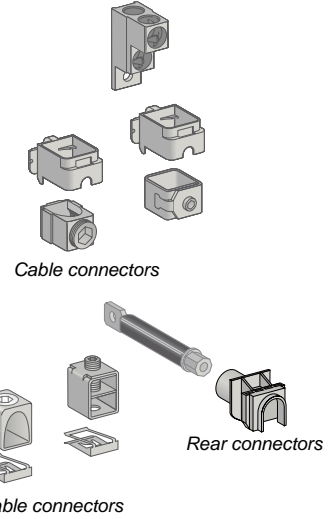
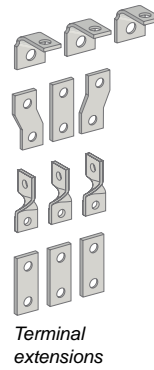

Electrical auxiliaries

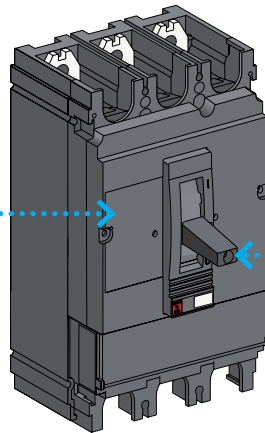
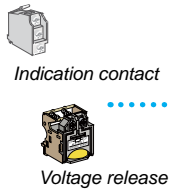

Control accessories

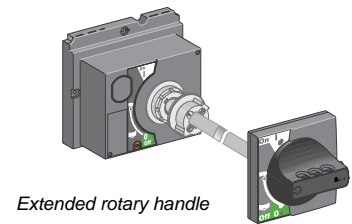
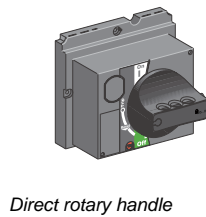

Electrical auxiliaries

100-250AF

AX - AL - AXAL - ALV

CPB100612



EZC100.

CDB500603

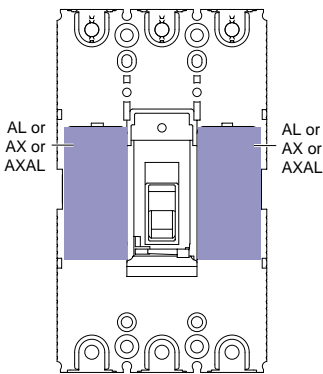

AXAL and AX electrical auxiliaries on EZC100.

CDB500604

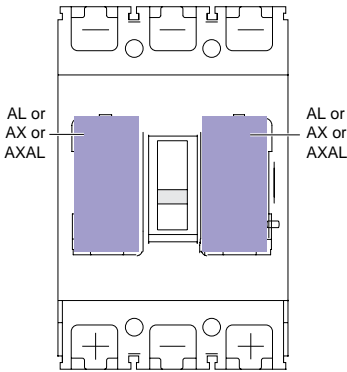

AXAL electrical auxiliaries on EZC250.

CDB500605

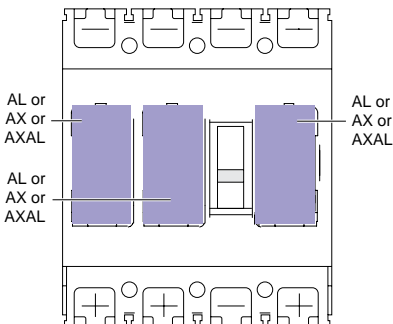

AXAL, AX and ALV electrical auxiliaries on EZCV250.

Plug-in location: AX - AL - AXAL - ALV

EZC100

DB116832

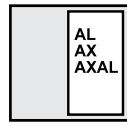

EZC100-2P.

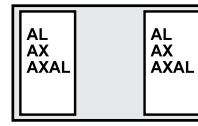

EZC100-3P.

DB116833

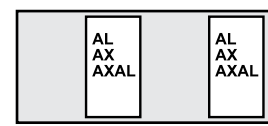

EZC100-4P.

EZC250

DB116834

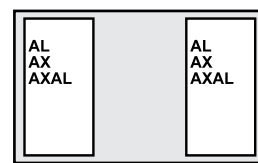

EZC250-3P.

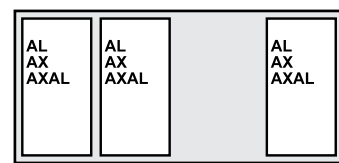

EZC250-4P.

EZCV250

DB116835

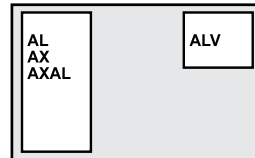

EZCV250-3P.

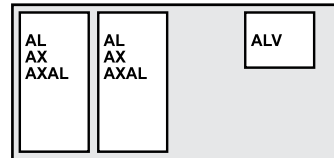

EZCV250-4P.

Indication contacts

Provide remote circuit breaker status information. They can be used for indications, electrical locking, relaying, etc. Common-point changeover contacts.

Auxiliary switch (ON/OFF)

AX indicates the position of the circuit breaker contacts.

Alarm switch (trip indication)

■ AL indicates that the circuit breaker has tripped due to:

- an overload
- a short-circuit
- operation of a voltage release.

■ ALV indicates that the circuit breaker has tripped due to an of earth-leakage fault.

They return to de-energised state when the circuit breaker is reset.

Characteristics

Contacts

Rated thermal current (A)	5				
Minimum load	10 mA at 24 V				
Utilisation category (IEC 60947-5-1)	AC12	AC15	DC12	DC14	
Operational current (A)	24 V	5	5	4	3
	48 V	5	5	2.5	1
	125 V	5	3	0.4	0.4
	250 V	3	2	0.2	0.2

Connections

Connection wire length	450 mm
Cross-section	EZC100: 1 mm ² ,
	EZC250/EZCV250: 1.5 mm ²

PB101862-21



Auxiliary switch (AX)
EZAUX10.

PB101876-21



Auxiliary switch (AX)
EZEAX.

PB101893-28



Earth-leakage alarm switch
(ALV).

DB116386

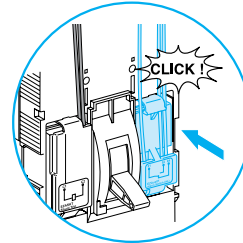
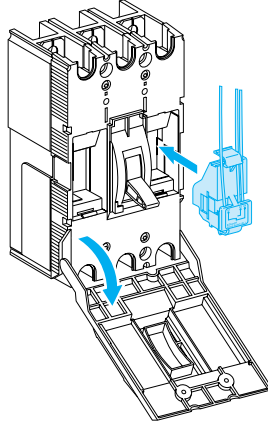

All EasyPact EZC
electrical auxiliaries
are "snapped in
place"

Electrical auxiliaries

100-250AF

SHT - UVR - UVRN



EZC250.

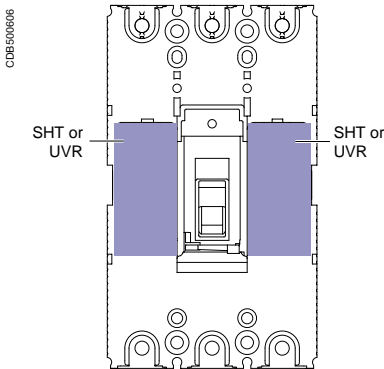

SHT and UVR releases on EZC100.

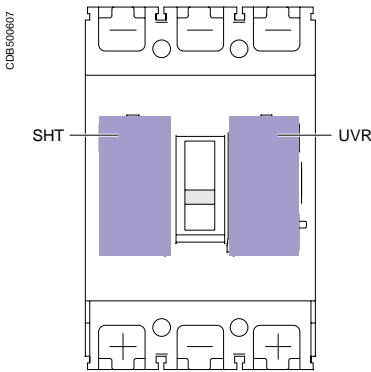

SHT and UVR releases on EZC250.

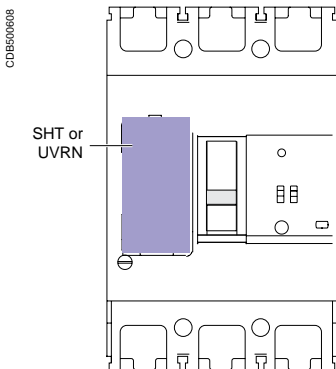

UVRN release on EZCV250.

Plug-in location : SHT - UVR - UVRN

EZC100

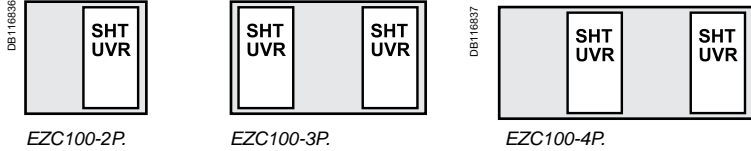

EZC250

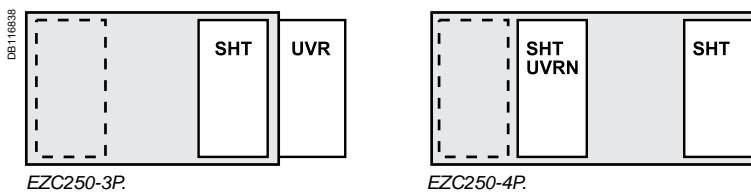

EZCV250

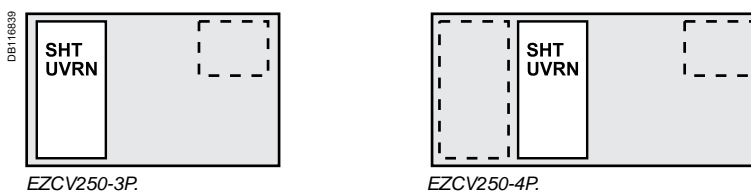

Remote tripping

Shunt Trip (SHT) or Under Voltage Release (UVR/UVRN).

Shunt Trip (SHT)

- This release trips the circuit breaker when the control voltage rises above $0.7 \times U_n$
- Control signals can be of the impulse type (≥ 20 ms) or maintained.

Under Voltage Release (UVR/UVRN)

- This release trips the circuit breaker when the control voltage drops below a tripping threshold
- Tripping threshold between 0.35 and 0.7 times the rated voltage
- Circuit breaker closing is possible only if the voltage exceeds 0.85 times the rated voltage.

Operation

When the circuit breaker has been tripped by an SHT or UVR/UVRN release, it must be reset locally:

- SHT or UVR/UVRN tripping takes priority over manual closing
- in the presence of a standing trip order, closing of the contacts, even temporary, is not possible.

Circuit breaker tripping by an SHT/UVR/UVRN release meets the requirements of standard IEC 60947-2.

Characteristics

Mechanical			
Mechanical endurance	10 % of MCCB mechanical endurance		
Electrical		EZC100	EZC250/EZCV250
		AC/DC	AC DC
SHT	pick-up consumption	< 30 VA	< 35 W
	response time	< 50 ms	< 100 ms
UVR	seal-in consumption	< 5 VA	< 10 W
	response time	< 50 ms	< 100 ms
UVRN	seal-in consumption	< 5 VA	< 10 W
	response time	< 50 ms	< 100 ms
Connections		EZC100	EZC250/EZCV250
SHT		pre-wired (1 mm ²)	pre-wired (0.5 mm ²)
UVR		pre-wired (1 mm ²)	screws (< 2 mm ²)
UVRN		pre-wired (1 mm ²)	pre-wired (0.5 mm ²)

PE101865-16



Shunt Trip EZASHT.

PE101879-18



Shunt Trip EZESHT.

Installation

- Ezc100 SHT and UVR: internal mounting
- Ezc250/EzcV250:
 - SHT: internal mounting
 - UVR: external mounting
 - UVRN: internal mounting

PE101866-18



Under Voltage Release
EZAUVR.

PE101884-27



Under Voltage Release
EZEUVRN.

PE101880-15



Under Voltage Release
EZEUVR.

Direct rotary handle 100-250AF

PE101867-31



Direct rotary handle (black) for EZC100.

Direct rotary handle

Suitable for Motor Control Centre (MCC) switchboards.

- Degree of protection IP40 or IP54, IK07 (IP54 with gasket supplied).
- The direct rotary handle maintains:
 - suitability for isolation
 - indication of the three positions O (OFF), I (ON) and tripped
 - circuit breaker locking capability in the OFF position by one to three padlocks, (padlock not supplied) shackle diameter Ø 5 for EZC100, Ø 8 for EZC250/EZCV250
 - door opening disabled when the circuit breaker is ON
 - circuit breaker closing is disabled if the door is open.

IP40 or IP54

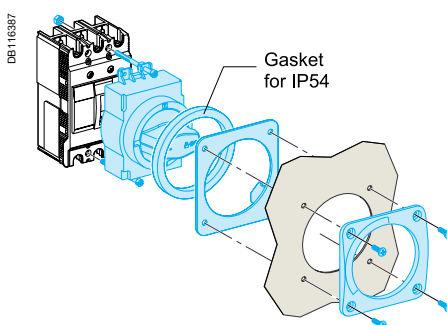

EZC100.

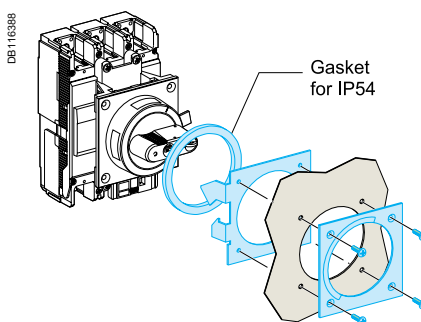

EZC250/EZCV250.

PE101881-33



Direct rotary handle (black) for EZC250/EZCV250.

Padlocking

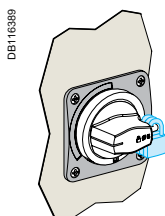

EZC100.

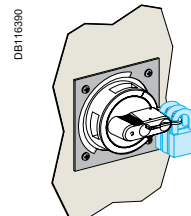

EZC250/EZCV250.

Designation	Cat. no.	
Direct rotary handle (black)	EZC100	EZC250/EZCV250
	EZAROTDS	EZEROTDS

Extended rotary handle 100-250AF

PE101868-46



Extended rotary handle (black) for Ezc100.

Extended rotary handle

The extended rotary handle is used to control, from the front face of the switchboard, a device installed at the back of the switchboard.

- Degree of protection IP40 or IP54, IK08 (IP54 with gasket supplied).
- The extended rotary handle maintains:
 - suitability for isolation
 - indication of the three positions O (OFF), I (ON) and tripped
 - circuit breaker locking capability in the OFF position by one to three padlocks, (padlock not supplied) shackle diameter: Ø 5 for Ezc100, Ø 8 for Ezc250/ EzcV250
 - door opening disabled when the circuit breaker is ON.
- The extended rotary handle is made up of:
 - a unit on the front cover of the circuit breaker (secured by screws)
 - an assembly (handle and front plate) on the door that is always secured in the same position, whether the circuit breaker is installed vertically or horizontally
 - an extension shaft that must be adjusted to the distance between back of circuit breaker and door.

IP40 or IP54

DB116391

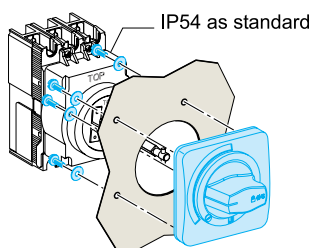

Ezc100.

DB116392

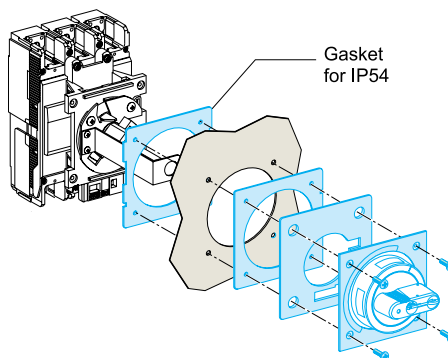

Ezc250/EzcV250.

PE101862-42



Extended rotary handle (black) for Ezc250/EzcV250.

Padlocking

DB116389

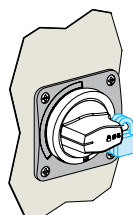

Ezc100.

DB116390

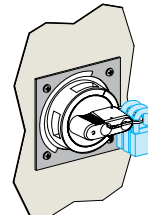

Ezc250/EzcV250.

Designation	Cat. no.	
Extended rotary handle (black)	Ezc100	Ezc250/EzcV250
	EZAROTE	EZEROTE

The plug-in allows you to connect, disconnect from the circuit breaker rapidly.



CPB100620

Plug-in

The plug-in base is equipped with terminals which, depending on their orientation, serve for front and rear connection. Degree of protection IP20.

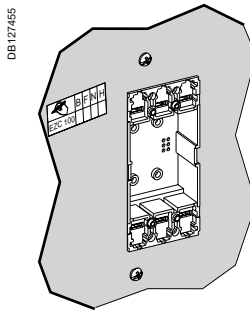

DB127465

Front connection.

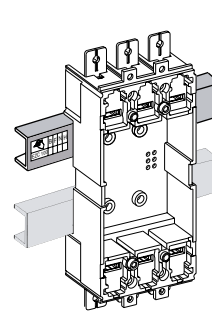

DB127466

Fixation on rail DIN.

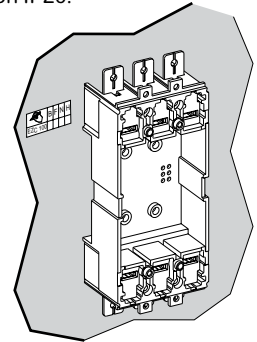

DB127467

Fixation on rear plate.

Connection accessories

All accessories for fixed devices (bars, lugs) may be used with the plug-in base.

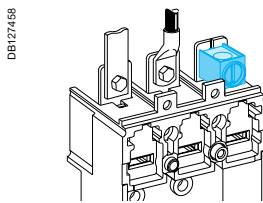

DB127458

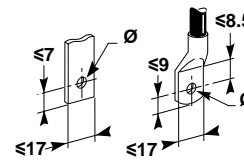

Tightening torque



PB106398-30

EZAPCON1L



PB106399-33

EZAPCON1H



PB106397-27

EZAFSHB3

References Plug-in	100 A
EZAPLUG3L	Kit, plug-in base 3P 15 A-50 A
EZAPLUG3H	Kit, plug-in base 3P 60 A-100 A
EZAFSHB3 - set of 3	Fishbone connectors
EZAPCON1L - set of 2	Plug-in connectors 15 A-50 A
EZAPCON1H	Plug-in connectors 60 A-100 A



CPB100609

Fishbone.

Fishbone

The fishbone, designed for vertical installation, saves space and reduces cabling time.

Short terminal shield only.

CFB 100621



DB127460

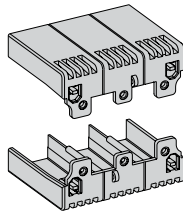

Terminal shields

Insulating accessories used for protection against direct contact with power circuits.

They provide IP40 degree of protection and IK07 mechanical impact protection.

Terminal-shield types

Easypact EZC 100 to 250:

- short terminal shields

Short terminal shields

They are used with:

- plug-in in all connection configurations
- fixed versions with the rear connection.

Terminal shields and pitch

Combination possibilities are shown below.

Circuit breaker Easypact EZC	100/250
Pitch (mm)	35

DB11356

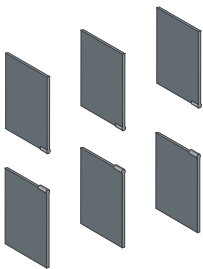

Interphase barriers

Safety accessories for maximum insulation at the power-connection points:

- they clip easily onto the circuit breaker
- single version for fixed devices and adapters on plug-in bases
- not compatible with terminal shields
- the adapter for the plug-in base is required for mounting on the plug-in and withdrawable versions.

The plug-in allows you to connect, disconnect from the circuit breaker rapidly.

Plug-in

The plug-in base is equipped with terminals which, depending on their orientation, serve for front and rear connection. Degree of protection IP20.

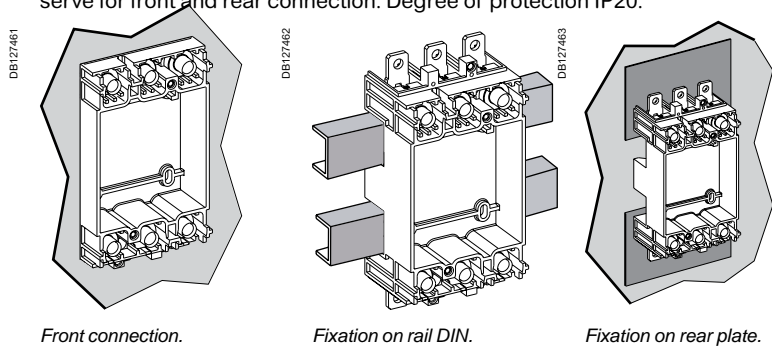

Connection accessories

All accessories for fixed devices (bars, lugs).

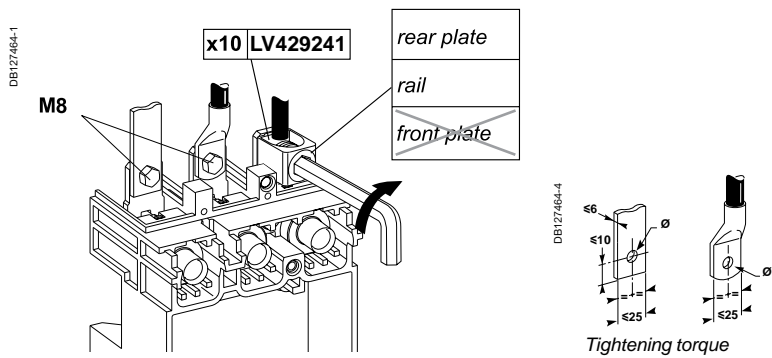

PB106402-43



EZEPCON1

References Plug-in	250 A
EZEPLUG3L - 60 mm breaker	Kit, plug-in base 3P 100 A - 250 A
EZEPCON1 - set of 2	Kit, plug-in connectors 100 A - 250 A

Short terminal shield only

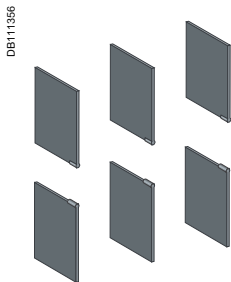

Interphase barriers.

Terminal shields

Insulating accessories used for protection against direct contact with power circuits.

They provide IP40 degree of protection and IK07 mechanical impact protection.

Terminal-shield types

Easypact EZC 100 to 250:

- short terminal shields.

Short terminal shields

They are used with:

- plug-in in all connection configurations
- fixed versions with the rear connection.

Terminal shields and pitch

Combination possibilities are shown below.

Circuit breaker Easypact	100/250
Short terminal shields	
Pitch (mm)	35

Interphase barriers

Safety accessories for maximum insulation at the power-connection points:

- they clip easily onto the circuit breaker
- single version for fixed devices and adapters on plug-in bases
- not compatible with terminal shields
- the adapter for the plug-in base is required for mounting on the plug-in and withdrawable versions.

Power connections and cable lugs

100-250AF

Standard circuit breaker terminals

All EasyPact EZC circuit breakers are supplied with terminal screws

EZC100 15 to 50 A Screw M5

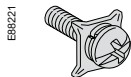

EZC100 60 to 100 A Screw M8



EZC250/EZCV250 63 to 250 A Screw M8

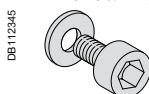

Connection of insulated bars or cables with lugs

	EZC100	EZC250/ EZCV250
Bars		
L (mm)	≤ 17	≤ 25
h (mm)	d + 10	d + 10
d (mm)	≤ 7	≤ 8
e (mm)	≤ 6	≤ 6
∅ (mm)	≤ 50 A	5.5
	> 50 A	8.5
		9

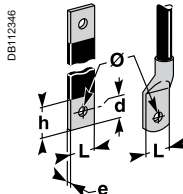

Crimp lugs	L (mm)	≤ 17	≤ 25
	d (mm)	≤ 9	≤ 8
	∅ (mm)	≤ 50 A	5.5
		> 50 A	8.5
Tightening torque	≤ 50 A	2 N.m	-
	> 50 A	5.5 N.m	13 N.m

Cable lugs

Cable lugs directly screwed on standard circuit breaker terminals.

≤ 50 A (EZC100) > 50 A (EZC100) ≥ 100 A (EZC250/EZCV250)

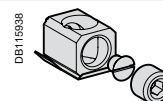
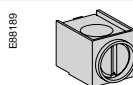

Cables from 2.5 to 16 mm².

Cables from 10 to 50 mm².

Cables from 42.2 to 150 mm².

Designation	Cat. no.	
	EZC100	EZC250/EZCV250
Cable lug up to 50 A (set of 2)	EZALUG0502 ⁽¹⁾	-
Cable lug up to 50 A (set of 3)	EZALUG0503 ⁽¹⁾	-
Cable lug from 60 A up to 100 A (set of 2)	EZALUG1002 ⁽²⁾	-
Cable lug from 60 A up to 100 A (set of 3)	EZALUG1003 ⁽²⁾	-
Cable lug from 100 A up to 250 A (set of 3)	-	EZELUG2503
Cable lug from 100 A up to 250 A (set of 4)	-	EZELUG2504

Important:

- (1) EZALUG0502 and EZALUG0503 can be used with maximum rating of 50 A.
(2) EZALUG1002 and EZALUG1003 can be used with maximum rating of 100 A.

Power connections and insulation of live parts 100-250AF



Spreader.

Spreaders

Increase the pitch of the circuit breaker terminals:

- EZC100 from 25 mm to 35 mm
- EZC250/EZCV250 from 35 mm to 45 mm.

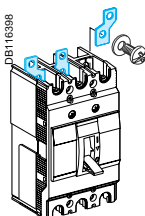

Designation	Cat. no.	
		EZC100
Spreaders for 3-pole breaker (set of 3)	EZASPDR3P	EZESPDR3P
Spreaders for 4-pole breaker (set of 4)	EZASPDR4P	EZESPDR4P

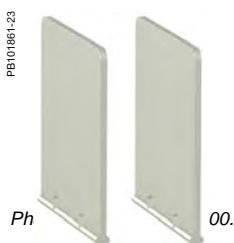

Ph 00.

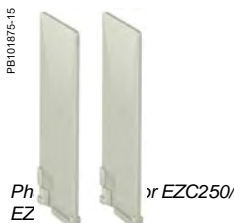

Ph or EZC250/
EZ

Phase barriers

- Safety accessories for maximum insulation at the power connection points.
- Usable with all other connection accessories, except terminal shields.
- Each breaker is delivered with a set of phase barriers (1 for 2 poles, 2 for 3 poles and 3 for 4 poles breaker).
- Additional set of phase barriers available for insulation between outgoing or between 2 side by side-mounted breakers.

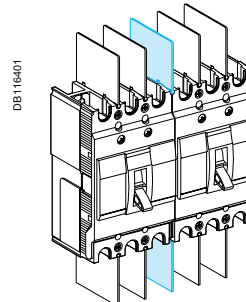
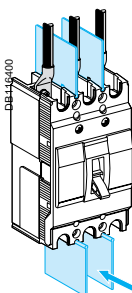

Designation	Cat. no.	
Phase barriers for 60 mm depth (set of 2)	EZC100	EZC250/EZCV250
Phase barriers for 68 mm depth (set of 3)	EZAFASB2	EZEFASB2
	-	EZEFASB3N

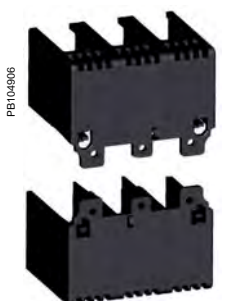

Terminal shield for EZC100.



Terminal shield
for EZC250/EZCV250.

Terminal shields

- Insulating accessory used for protection against direct contacts with power circuit connections. It provides a degree of protection of IP20 and mechanical resistance of IK07.
- The long terminal shield is used with front cable or isolated busbar connections.
- Designed for 3-pole EZC100, 3, 4-pole EZC250/EZCV250.

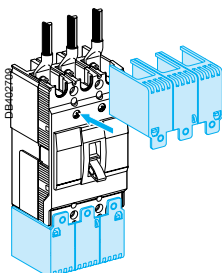

Designation	Cat. no.	
Terminal shield 3P, 60 mm depth (set of 2)	EZC100	EZC250/EZCV250
Terminal shield 3P, 68 mm depth (set of 2)	EZATSHD3P	EZETSHD3P
Terminal shield 3P, 68 mm depth (set of 2)	-	EZETSHD3PN
Terminal shield 4P, 60 mm depth (set of 2)	EZATSHD4P	-
Terminal shield 4P, 68 mm depth (set of 2)	-	EZETSHD4PN

DIN rail adaptor, padlocking, sealing screws

100-250AF



Padlocking device for EZC100.



Padlocking device for EZC250/EZCV250.

DIN rail adaptor

Breaker mounting on a DIN rail is possible by using special adaptor (EZC100 only).

Number of adaptors:

- one for two 1P, or one 2P or one 3P
- two for one 4P.

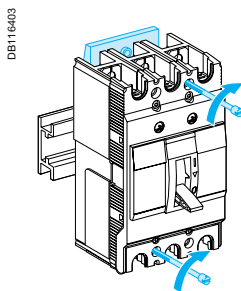

Mounting on DIN rail (optional).

Designation	Cat. no.	
	EZC100	EZC250/EZCV250
Din rail adaptor	EZADINR	-

Padlocking system

Locking in the OFF position guarantees isolation as per IEC 60947-2.

Padlocking system can receive:

- up to 2 padlocks Ø 5 mm (padlocks not supplied) for EZC100
- up to 3 padlocks Ø 8 mm for EZC250/EZCV250 (padlocks not supplied).

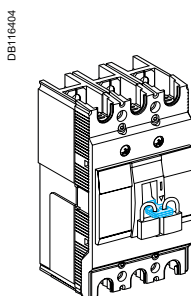

Toggle locking using a removable device:
for EZC100

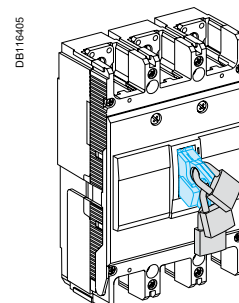

for EZC250/EZCV250

Designation	Cat. no.	
	EZC100	EZC250/EZCV250
Padlocking system	EZALOCK	-
Padlocking system for EZC250-3P	-	EZELOCK

Fixed circuit breakers are designed for standard front connection using bars or cables with lugs. Cable connectors are available for bare cables. Rear connection is also possible.

Front connection

Bars or cables with lugs

Standard terminals

EasyPact EZC400 to 630 come with terminals comprising snap-in nuts with screws:

- EasyPact EZC400/630: M10 nuts and screws.

These terminals may be used for:

- direct connection of insulated bars or cables with lugs
- terminal extensions.

Interphase barriers or terminal shields are recommended. They are mandatory for certain connection accessories (in which case the interphase barriers are provided).

Bars

When the switchboard configuration has not been tested, insulated bars are mandatory.

Maximum size of bars

EasyPact EZC circuit breaker	400/630	
Without spreaders	pitch (mm)	45
	maximum bar size (mm)	32 x 8
With spreaders	pitch (mm)	52.5
	maximum bar size (mm)	40 x 6

Crimp lugs

There are two modules of lugs, for aluminium and copper cables.

Interphase barriers or long terminal shields must be used with narrow lugs. The lugs are supplied with interphase barriers.

EasyPact EZC circuit breaker	400/630	
Copper cables	size (mm ²)	240, 300
	crimping	hexagonal barrels or punching
Aluminium cables	size (mm ²)	240, 300
	crimping	hexagonal barrels

Spreaders

Spreaders may be used to increase the pitch:

- EZC400/630: the 45 mm pitch can be increased to 52 or 70 mm. Bars, cable lugs or cable connectors can be attached to the ends.

Pitch (mm) depending on the type of spreader

EasyPact EZC circuit breaker	EZC400 to 630
Without spreaders	45
With spreaders	52.5 or 70

CDB500620

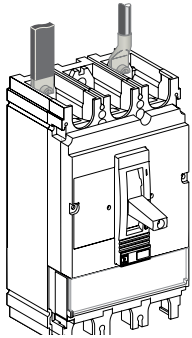

DB112169



Insulated bar.

DB112170



Small lug for copper cables.

DB112171



Small lug for Al cables.

DB112177

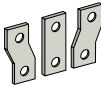

Spreaders.

Accessories and auxiliaries of EZC400-630

Connection of devices

CB5500621

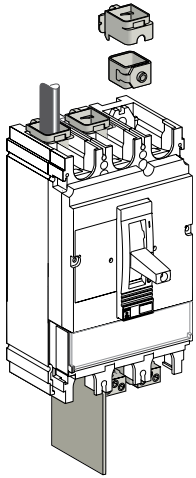

DB112314



Bare cable.

Bare cables

Bare-cable connectors may be used for both copper and aluminium cables.

1-cable connectors for EasyPact EZC400 to 630

The connectors are screwed directly to the device terminals.

Maximum size of cables depending on the type of connector

EasyPact EZC circuit breaker	400	630
Aluminium connectors	2 cables 35 to 240 mm ² ■	■
	35 to 300 mm ² ■	■

DB112316



1-cable
connector for
EZC400/630.

DB111226

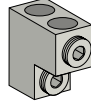

2-cable
connector for
EZC400/630.

CB5500622

Four positions.

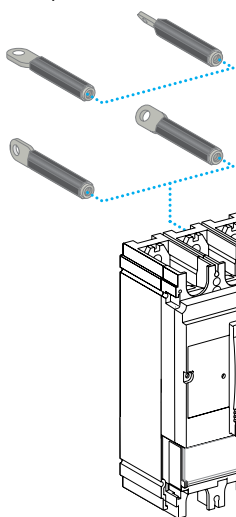

Two lengths.

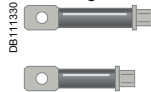

Rear connection

Device mounting on a backplate with suitable holes enables rear connection.

Bars or cables with lugs

Rear connections for bars or cables with lugs are available in two lengths. Bars may be positioned flat, on edge or at 45° angles depending on how the rear connections are positioned.

The rear connections are simply fitted to the device connection terminals. All combinations of rear connection lengths and positions are possible on a given device.

DB4400184-00

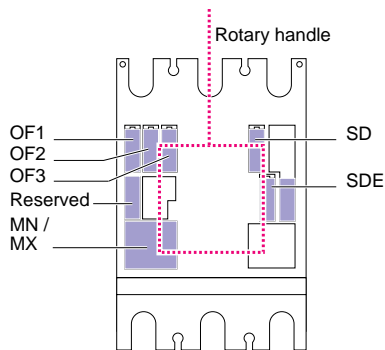

EasyPact EZC400/630

Standard

All EasyPact EZC400/630 circuit breakers and switch-disconnectors have slots for the electrical auxiliaries listed below.

5 indication contacts

- 3 ON/OFF (OF3)
- 1 trip indication (SD)
- 1 fault-trip indication (SDE)

1 remote-tripping release

- either 1 MN undervoltage release
- or 1 MX shunt release.

All these auxiliaries can be installed with a rotary handle.

Accessories and auxiliaries of EZC400-630 Indication contacts

One contact model provides circuit-breaker status indications (OF - SD - SDE).



Indication contacts.

These common-point changeover contacts provide remote circuit-breaker status information.

They can be used for indications, electrical locking, relaying, etc.

They comply with the IEC 60947-5 international recommendation.

Functions

Breaker-status indications, during normal operation or after a fault

A single type of contact provides all the different indication functions:

- OF (ON/OFF) indicates the position of the circuit breaker contacts
- SD (trip indication) indicates that the circuit breaker has tripped due to:
 - an overload
 - a short-circuit
 - an earth fault (Vigi)
 - operation of a voltage release
 - operation of the "push to trip" button
 - disconnection when the device is ON.

The SD contact returns to de-energised state when the circuit breaker is reset.

- SDE (fault-trip indication) indicates that the circuit breaker has tripped due to:
 - an overload
 - a short-circuit

Installation

■ OF, SD, SDE functions: a single type of contact provides all these different indication functions, depending on where it is inserted in the device. The contacts clip into slots behind the front cover of the circuit breaker.

Electrical characteristics of auxiliary contacts

Contacts		Standard				Low level			
Types of contacts		All				OF, SD, SDE			
Rated thermal current (A)		6				5			
Minimum load		100 mA at 24 V DC				1 mA at 4 V DC			
Utilisation cat. (IEC 60947-5-1)		AC12	AC15	DC12	DC14	AC12	AC15	DC12	DC14
Operational current (A)	24 V AC/DC	6	6	6	1	5	3	5	1
	48 V AC/DC	6	6	2.5	0.2	5	3	2.5	0.2
	110 V AC/DC	6	5	0.6	0.05	5	2.5	0.6	0.05
	220/240 V AC	6	4	-	-	5	2	-	-
	250 V DC	-	-	0.3	0.03	5	-	0.3	0.03
380/440 V AC	6	2	-	-	5	1.5	-	-	



MX or MN voltage release.

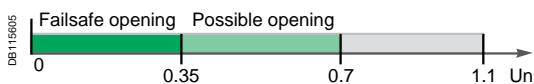

Opening conditions of the MN release.



Closing conditions of the MN release.

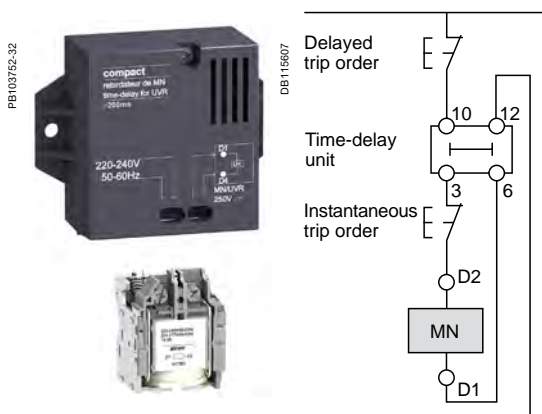

MN release with a time-delay unit.

Wiring diagram for emergency-off function with MN + time-delay unit.

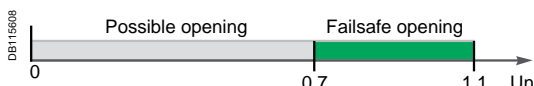

Opening conditions of the MX release.

MN undervoltage release

- This release trips the circuit breaker when the control voltage drops below a tripping threshold
- The tripping threshold is between 0.35 and 0.7 times the rated voltage
- Circuit breaker closing is possible only if the voltage exceeds 0.85 times the rated voltage.

Characteristics

Power supply	V AC	50/60 Hz: 24 - 48 - 100/130 - 200/240
		50 Hz: 380/415 60 Hz: 208/277
Operating threshold	V DC	12 - 24 - 30 - 48 - 60 - 125 - 250
	Opening	0.35 to 0.7 Un
	Closing	0.85 Un
Operating range		0.85 to 1.1 Un
Consumption (VA or W)		Pick-up: 10 - Hold: 5
Response time (ms)		50

Time-delay unit for an MN release

A time delay unit for the MN release eliminates the risk of nuisance tripping due to a transient voltage dip lasting ≤ 200 ms. For shorter micro-outages, a system of capacitors provides temporary supply to the MN at $U > 0.7$ to ensure no tripping. The correspondence between MN releases and time-delay units is shown below.

Power supply	Corresponding MN release
Unit with fixed delay 200 ms	
48 V AC	48 V DC
220 / 240 V AC	250 V DC
Unit with adjustable delay (0.5s, 0.9s, 1.5s, 3s)	
48 - 60 V AC/DC	48 V DC
100 - 130 V AC/DC	125 V DC
220 - 250 V AC/DC	250 V DC

MX shunt release

The MX release opens the circuit breaker via an impulse-type (≥ 20 ms) or maintained order.

Opening conditions

When the MX release is supplied, it automatically opens the circuit breaker. Opening is ensured for a voltage $U \geq 0.7 \times U_n$.

Characteristics

Power supply	V AC	50/60 Hz: 24 - 48 - 100/130 - 200/240
		50 Hz: 380/415 60 Hz: 208/277
	V DC	12 - 24 - 30 - 48 - 60 - 125 - 250
Operating range		0.7 to 1.1 Un
Consumption (VA or W)		Pick-up: 10
Response time (ms)		50

Circuit breaker control by MN or MX

When the circuit breaker has been tripped by an MN or MX release, it must be reset before it can be reclosed.

MN or MX tripping takes priority over manual closing.

In the presence of a standing trip order, closing of the contacts, even temporary, is not possible.

Connection using wires up to 1.5mm² to integrated terminal blocks.

Note: circuit breaker opening using an MN or MX release must be reserved for safety functions. This type of tripping increases wear on the opening mechanism. Repeated use reduces the mechanical endurance of the circuit breaker by 50 %.

Accessories and auxiliaries of EZC400-630

Rotary handles escutcheons and protection collars

There are two types of rotary handle:

- direct rotary handle
- extended rotary handle.

CPB100628



EasyPact EZC400 with a rotary handle.

CPB100629



EasyPact EZC400 with an extended rotary handle installed at the back of a switchboard, with the keylock option and key.

CPB100630



Escutcheons are an optional feature mounted on the switchboard door. They increase the degree of protection to IP40, IK07. Protection collars maintain the degree of protection, whatever the position of the device (connected, disconnected).

Direct rotary handle

Standard handle

Degree of protection IP40, IK07.

The direct rotary handle maintains:

- visibility of and access to trip-unit settings
- suitability for isolation
- indication of the three positions O (OFF), I (ON) and tripped
- access to the "push to trip" button.

Device locking

The rotary handle facilitates circuit-breaker locking.

- Padlocking:
 - standard situation, in the OFF position, using 1 to 3 padlocks, shackle diameter 5 to 8 mm, not supplied

Extended rotary handle

Degree of protection IP54, IK08.

The extended rotary handle makes it possible to operate circuit breakers installed at the back of switchboards, from the switchboard front.

It maintains:

- visibility of and access to trip-unit settings
- suitability for isolation
- indication of the three positions O (OFF), I (ON) and tripped.

Device and door padlocking

Padlocking locks the circuit-breaker handle and disables door opening:

- standard situation, in the OFF position, using 1 to 3 padlocks, shackle diameter 5 to 8 mm, not supplied

Parts of the extended rotary handle

- A unit that replaces the front cover of the circuit breaker (secured by screws).
- An assembly (handle and front plate) on the door that is always secured in the same position, whether the circuit breaker is installed vertically or horizontally.
- An extension shaft that must be adjusted to the distance. The min/max distance between the back of the circuit breaker and door is:
 - 209...600 mm for EasyPact EZC 400/630.

Manual source-changeover systems

Additional accessory interlocks two devices with rotary handle to create a source-changeover system. Closing of one device is possible only if the second is open. This function is compatible with direct or extended rotary handles.

Up to three padlocks can be used to lock in the OFF or ON position.

IP40 escutcheons for fixed devices

There are three types of escutcheon with a gasket which are screwed to the door cut-out:

- three escutcheons for all control types (toggle, handle or motor mechanism)
- a wide model for Vigi modules that can be combined with the above.

DB400025

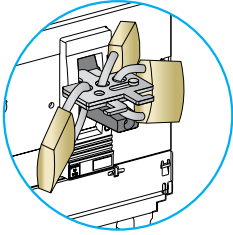

Toggle locking using padlocks and an accessory:
Removable device

DB400026

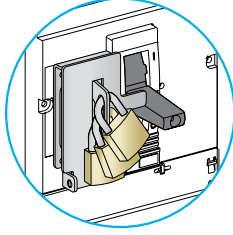

Toggle locking using padlocks and an accessory:
Fixed device attached to the case.

DB400027

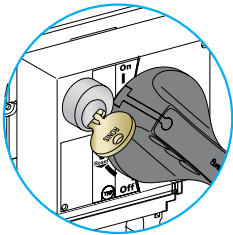

Rotary-handle locking using a keylock.

CDB500623

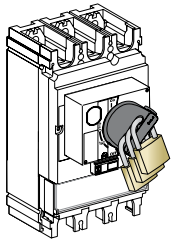

CDB500624

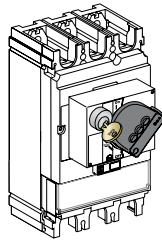

Rotary-handle locking using a padlock or a keylock.

DB115033

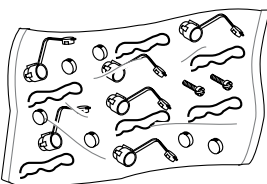

Sealing accessories.

Locks

Locking in the OFF position guarantees isolation as per IEC 60947-2. Padlocking systems can receive up to three padlocks with shackle diameters ranging from 5 to 8 mm (padlocks not supplied). Certain locking systems require an additional accessory.

Control device	Function	Means	Required accessories
Toggle	Lock in OFF position	Padlock	Removable device
	Lock in OFF or ON position	Padlock	Fixed device
Direct rotary handle	Standard Lock in OFF position OFF or ON position ⁽¹⁾	Padlock	-
		Keylock	Locking device + keylock
Extended rotary handle	Lock in OFF position OFF or ON position ⁽¹⁾ with door opening prevented ⁽²⁾	Padlock	-
		Padlock	UL508 control accessory
	OFF or ON position ⁽¹⁾ inside the switchboard	Keylock	Locking device + keylock

⁽¹⁾ Following a simple modification of the mechanism.

⁽²⁾ Unless door locking has been voluntarily disabled.

Sealing accessories

Toggle control

CDB500625

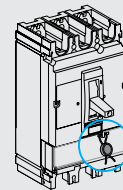

Rotary handle

CDB500626

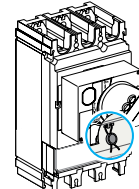

Installation guide



Installation guide

<i>Presentation</i>	<i>//</i>
<i>Functions and characteristics</i>	<i>A-1</i>
Dimensions	
EasyPact EZC 100	B-2
EasyPact EZC 100 A with plug-in	B-4
EasyPact EZC 250 - EZC 250/EZCV 250	B-6
EasyPact EZC 250 A with plug-in	B-8
EasyPact EZC 400/630	B-10
EasyPact EZC 100 accessories	B-12
EasyPact EZC 250 accessories	B-13
EasyPact EZC 400/630 accessories	B-14
Safety clearances and minimum distances	B-15
Temperature derating	B-17
Tripping curves	B-18
Current-limiting curves	B-20
Cascading	B-21
Cascading tables	B-22
Motor protection	B-24
Capacitor protection	B-26
<i>Catalogue numbers</i>	<i>C-1</i>

Dimensions

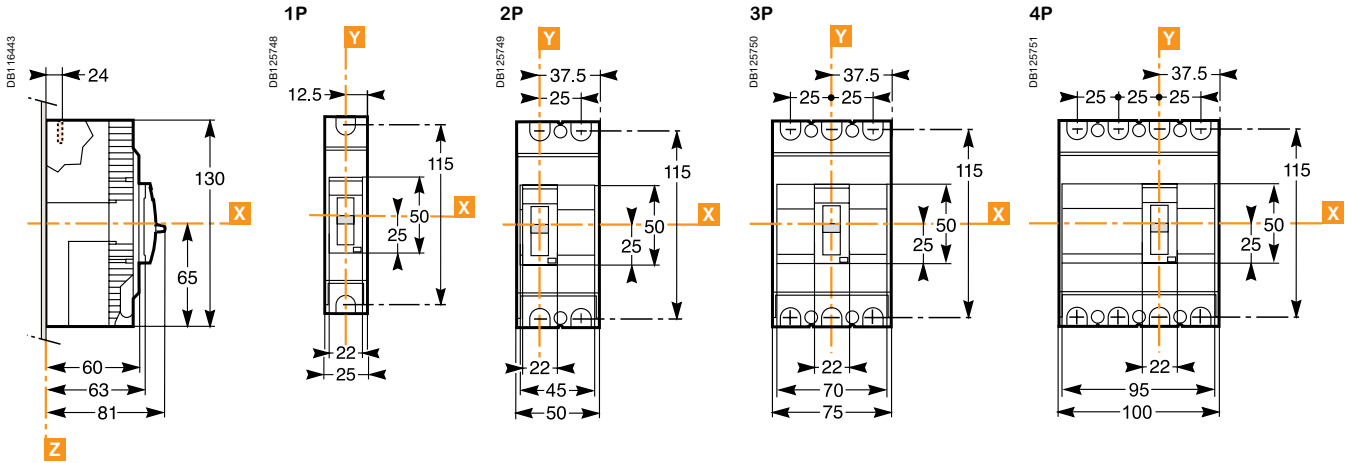

Mounting on plate

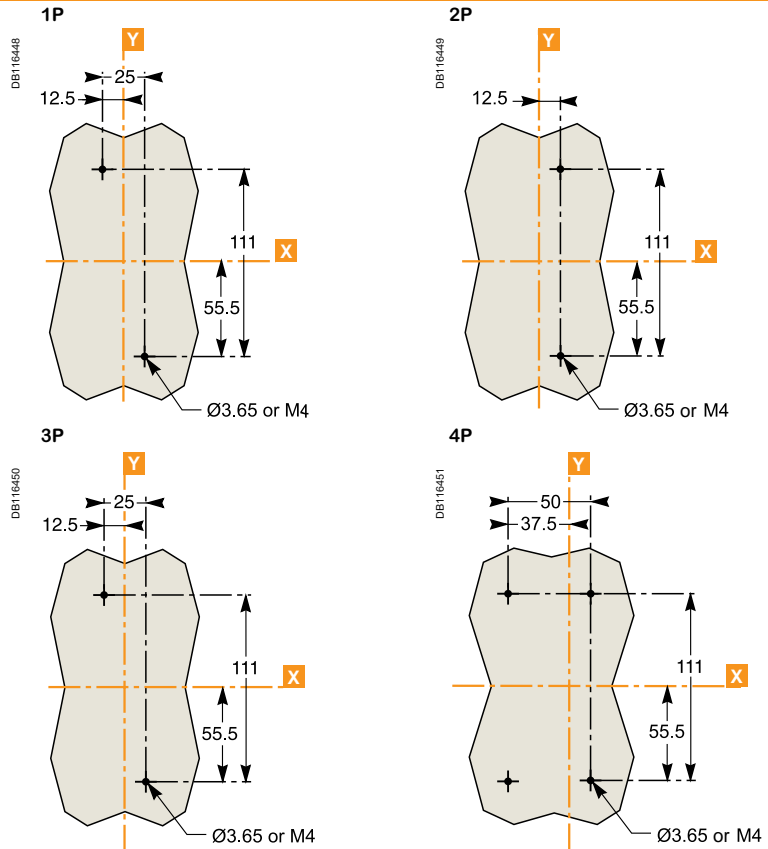

Mounting on DIN rail

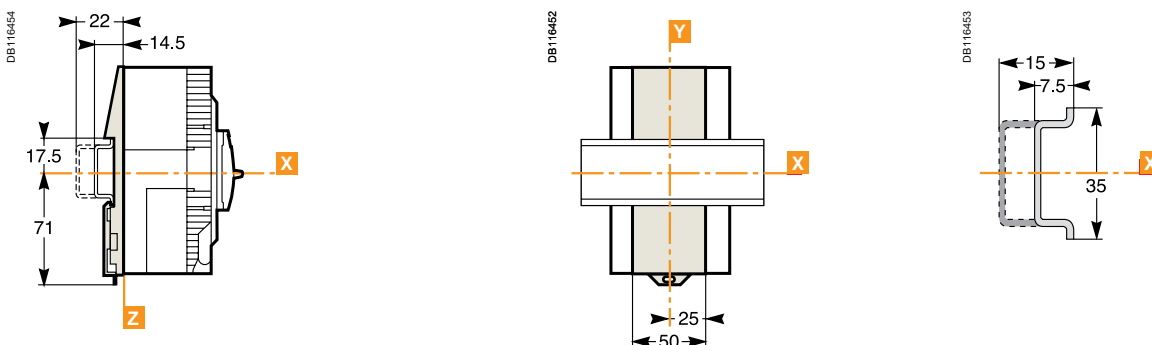

Door cut-out (small)

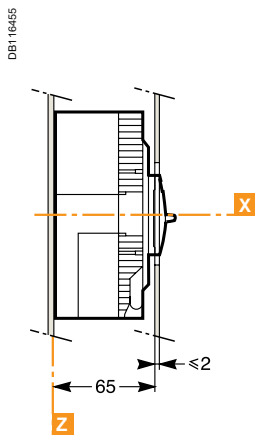

1P, 3P

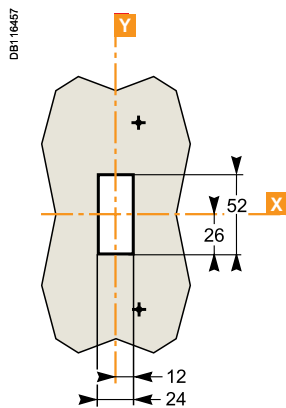

2P

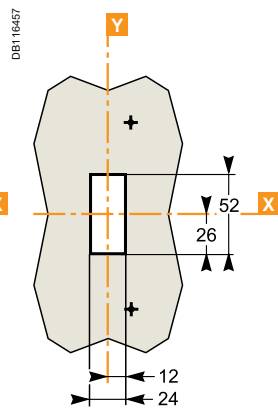

4P

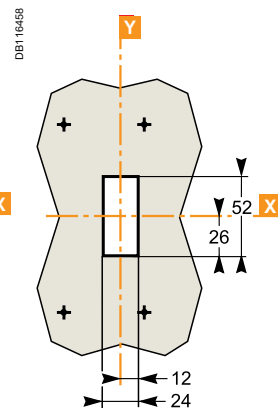

Door cut-out (large)

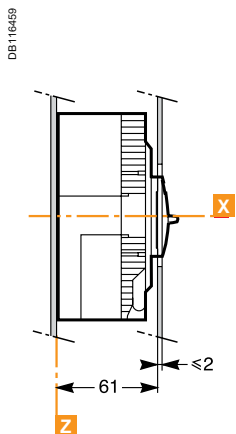

1P

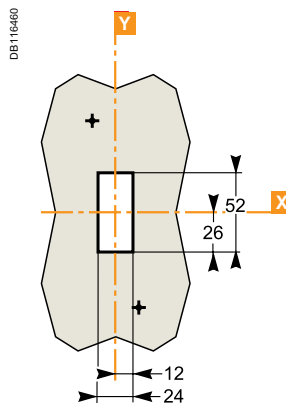

2P

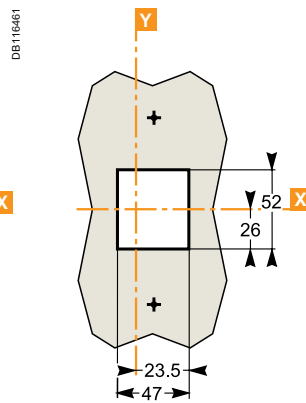

3P

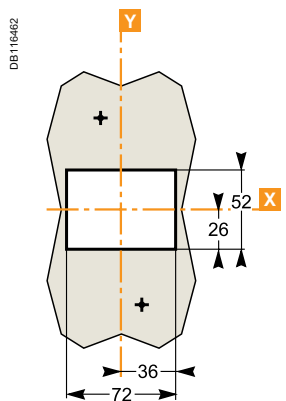

4P

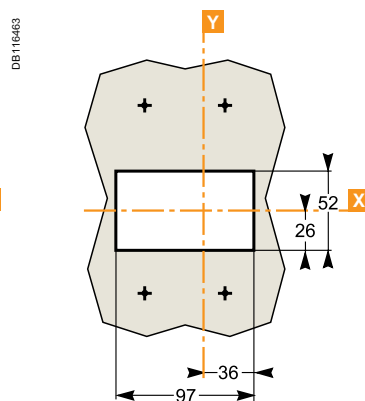

Dimensions

DB127536

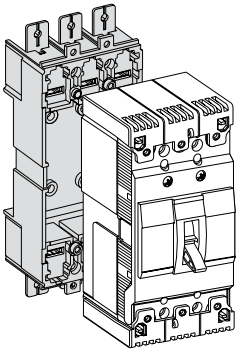

DB127538

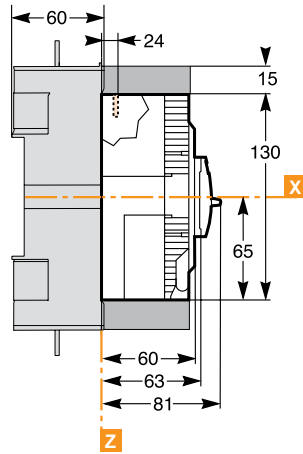

DB127539

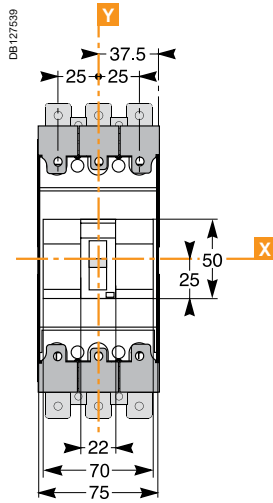

Mounting

Through front panel

DB127541

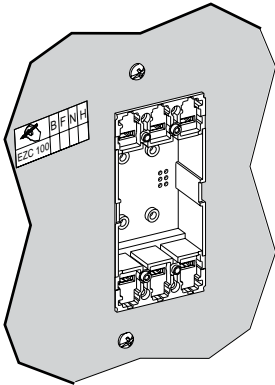

DB127537

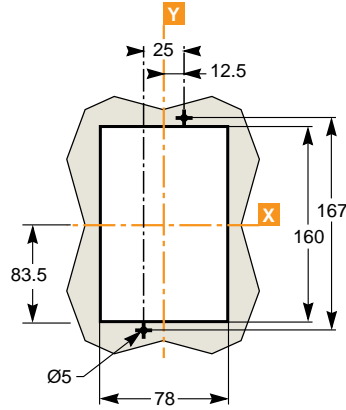

On rail

DB127542

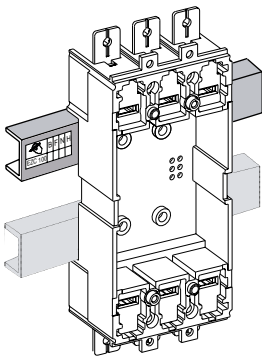

DB127540

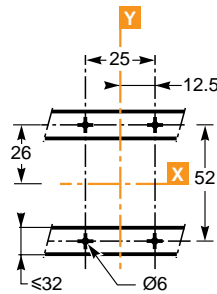

On backplate

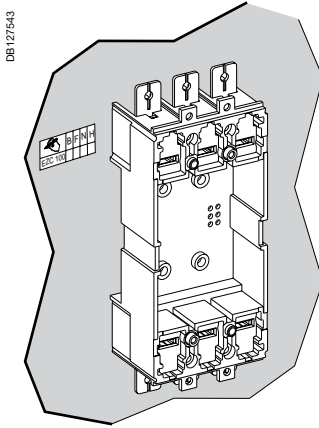

DB127543

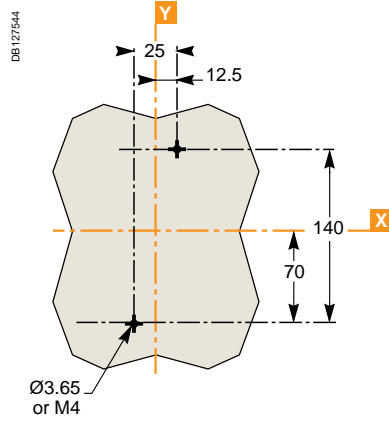

DB127544

Dimensions - combination

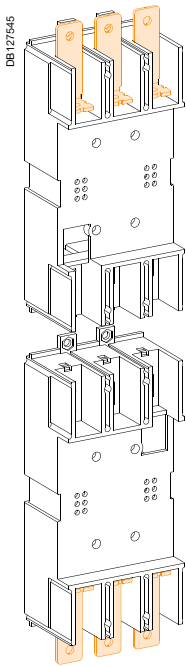

DB127545

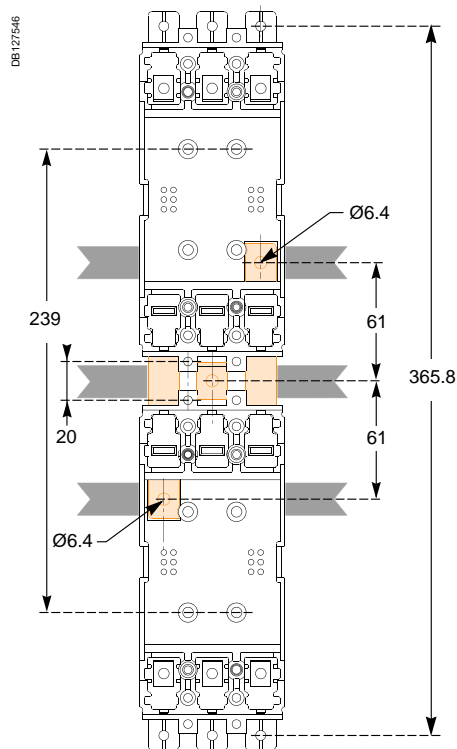

DB127546

Dimensions

EasyPact Ezc 250

Ezc 250/EZCV 250

Dimensions (Ezc250)

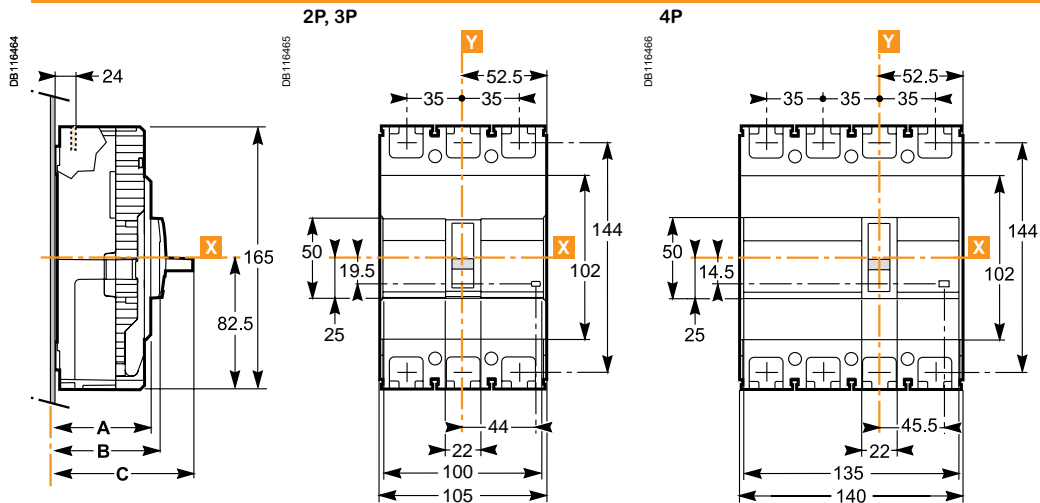

Dimensions (EZCV250)

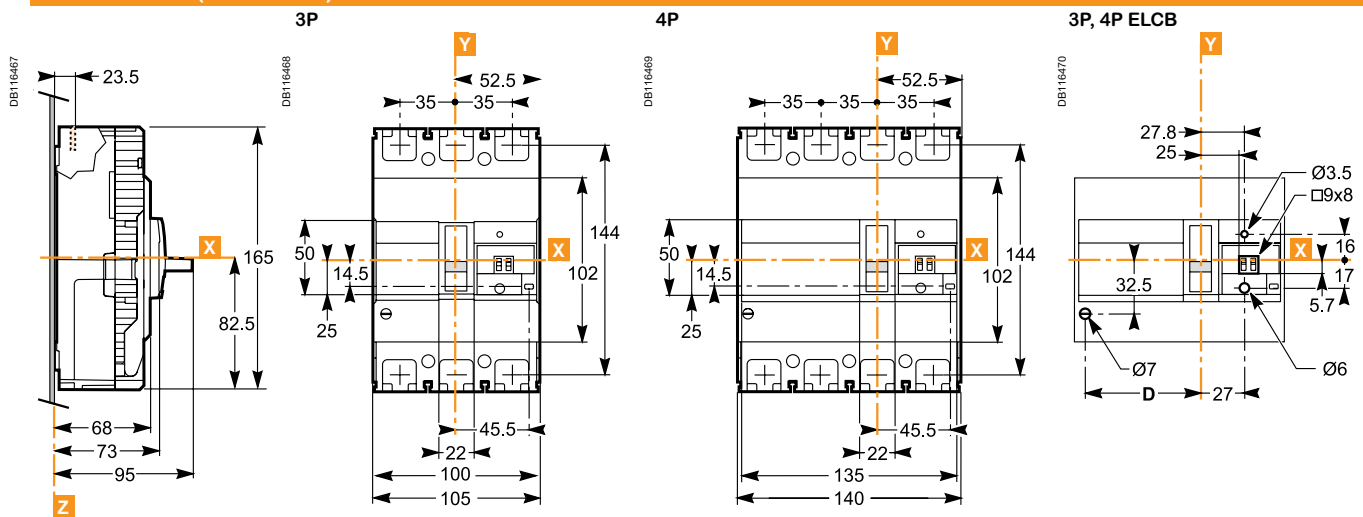

Mounting on plate

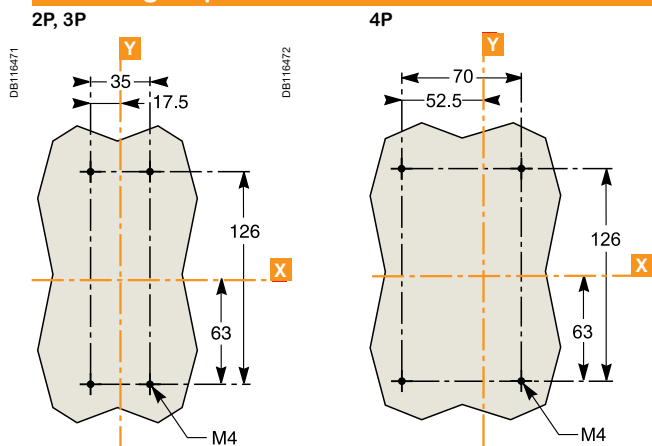

Dimensions

EasyPact EZC 250

EZC 250/EZCV 250

Door cut-out (small)

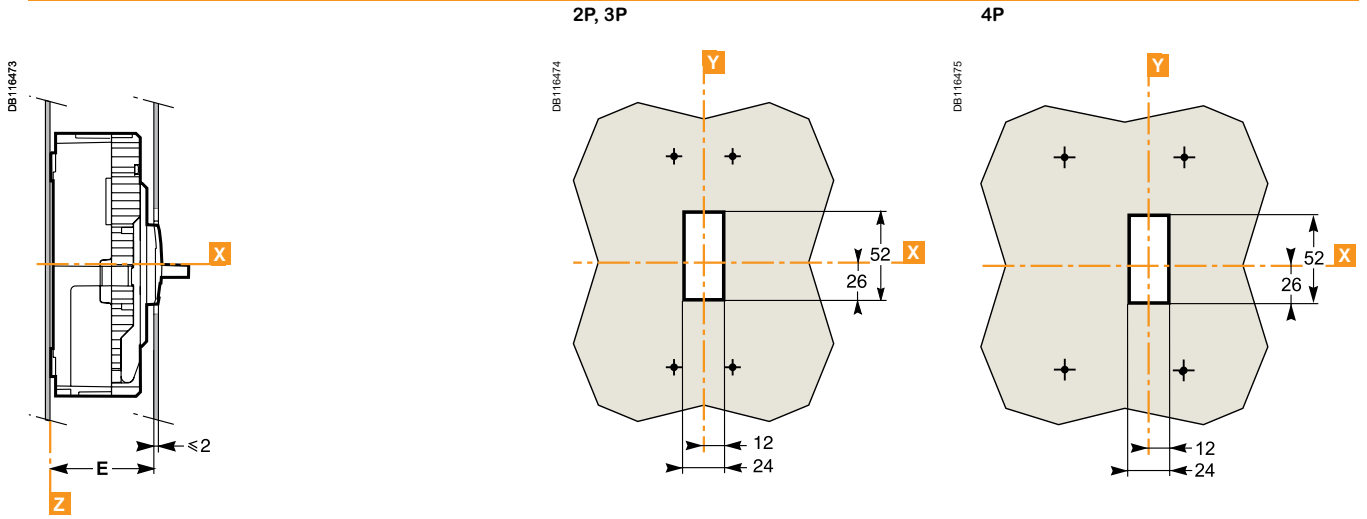

Door cut-out (large)

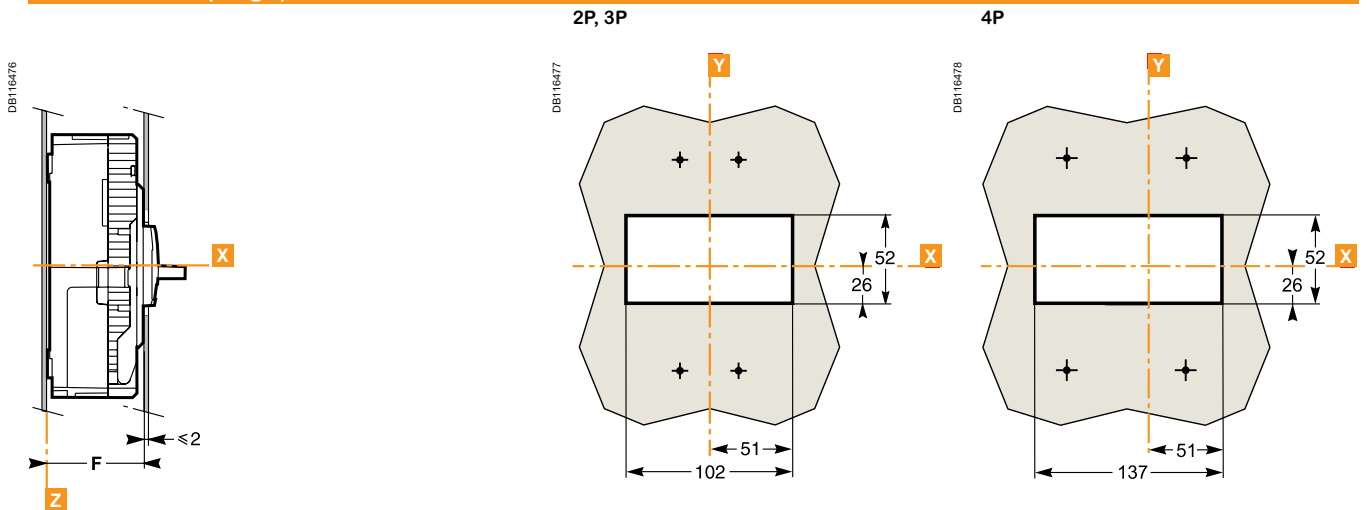

Dimensions (mm)

	A	B	C	D	E	F
EZC 2/3P	60	65	85.5	-	67	61
EZC 4P	68	73	95	-	75	69
EZCV 3P				45.5		
EZCV 4P				80.5		

Dimensions

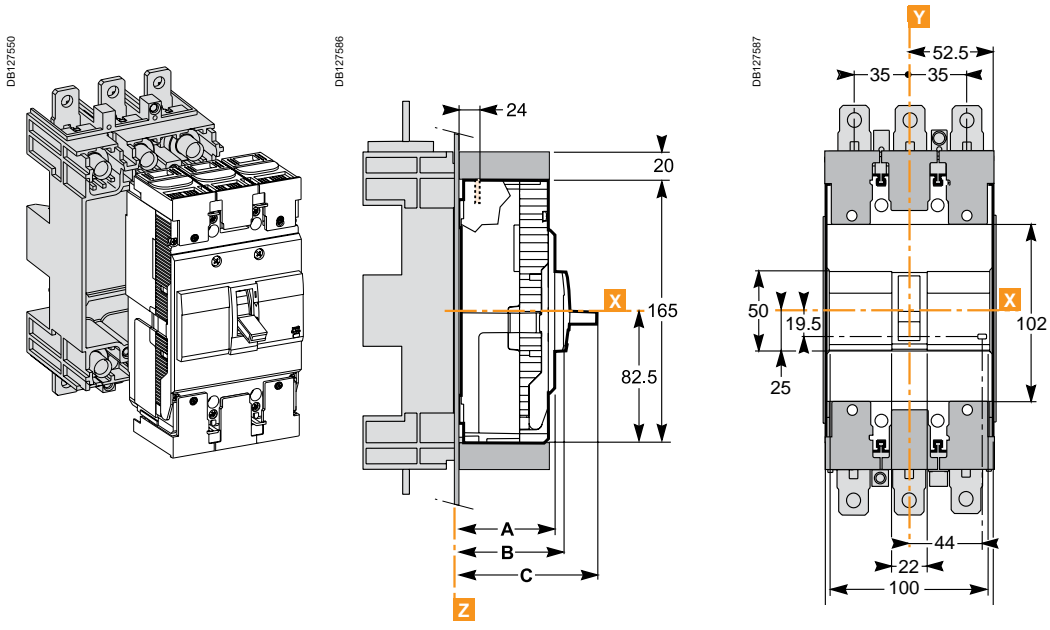

Mounting

Through front panel

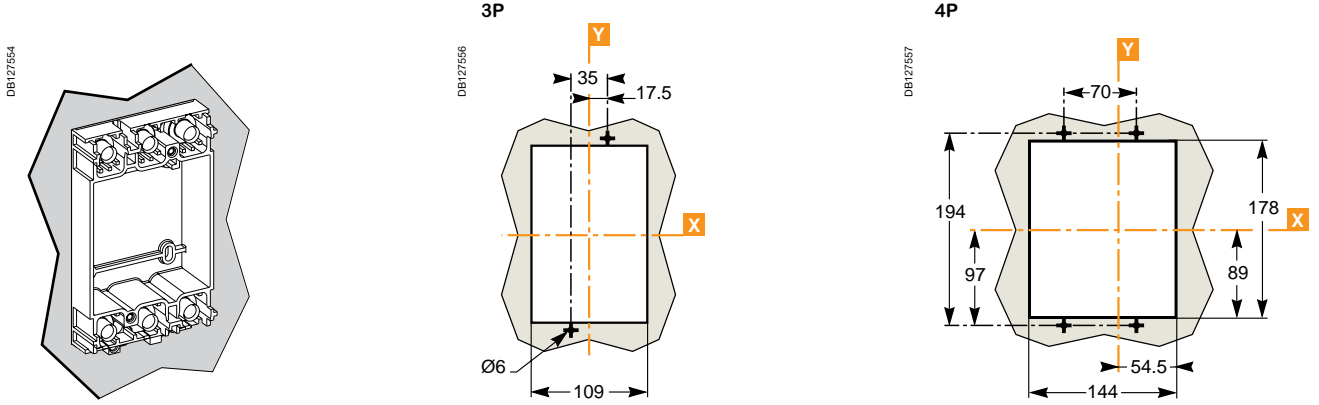

On rail

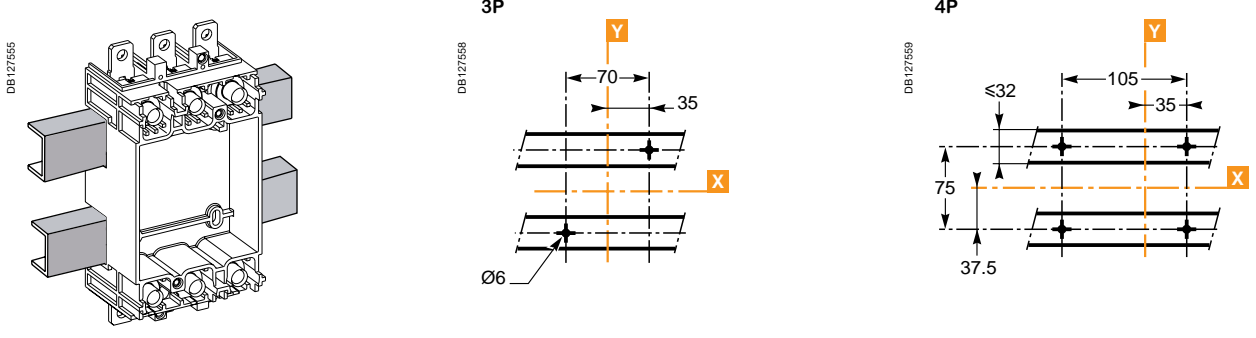

Dimensions

EasyPact EZC 250 A with plug-in

On backplate

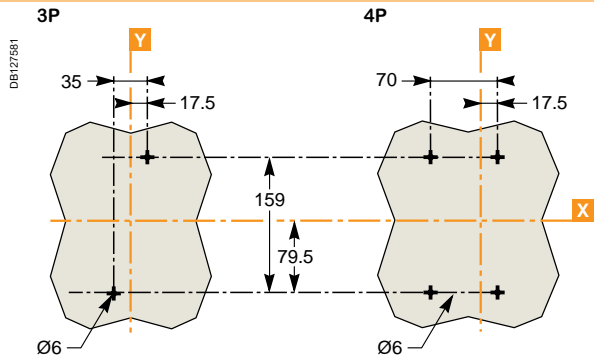
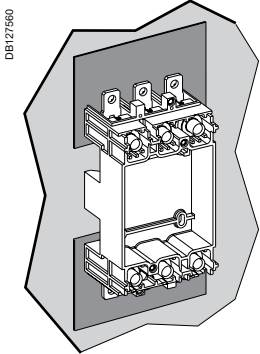

Dimensions

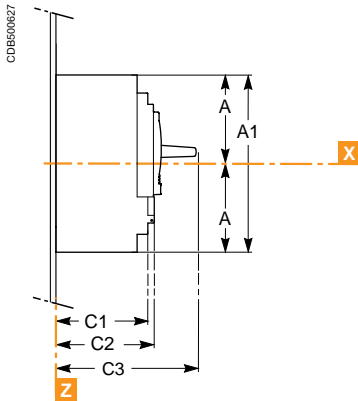

3P

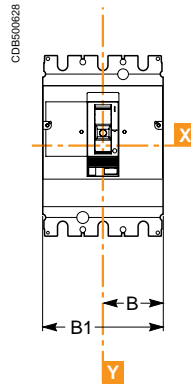

4P

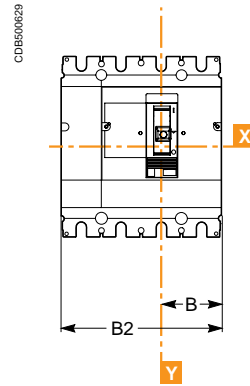

Mounting on plate

On backplate

3P

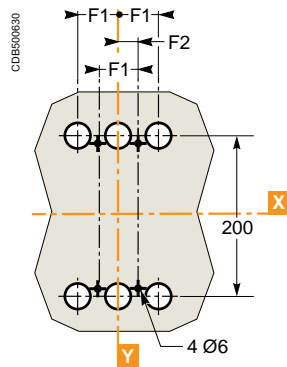

4P

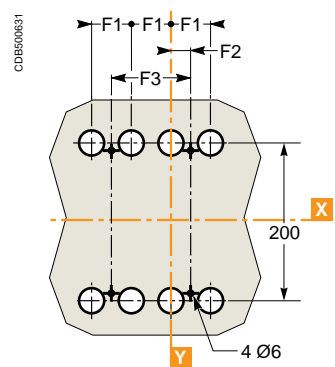

(1) The ØT holes are required for rear connection only.

A	A1	B	B1	B2	F1	F2	F3
127.5	255	70	140	185	45	22.5	90

Bare sheet metal

For toggle

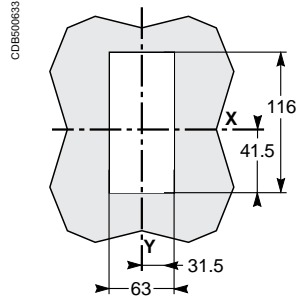
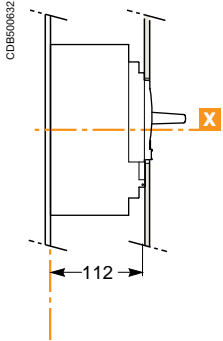

For toggle with access to trip unit

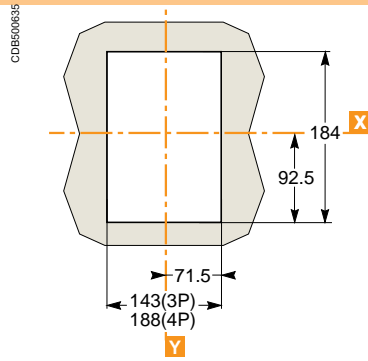
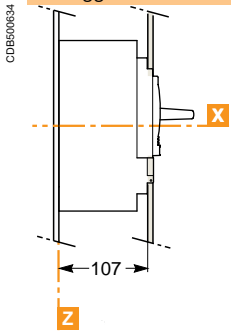

Terminal shields

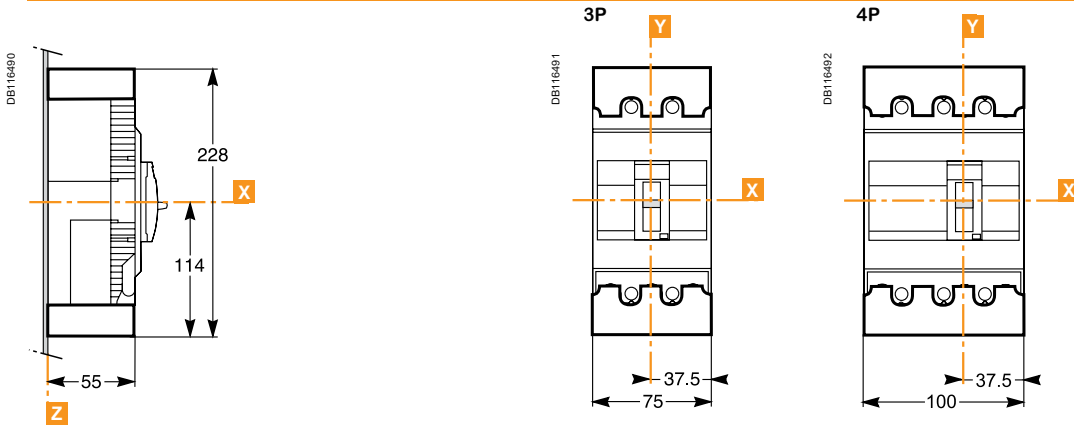

Phase barriers

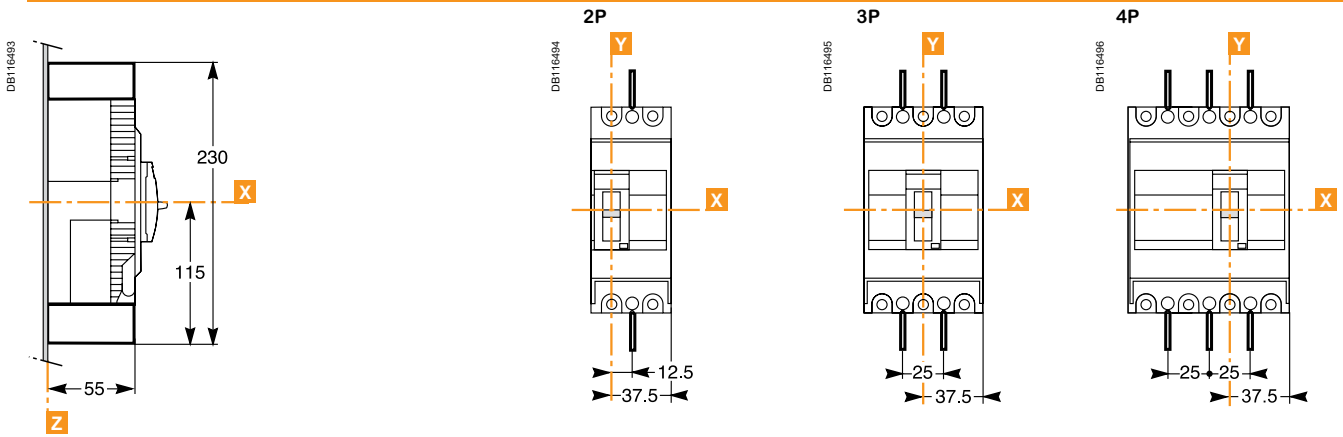

Direct rotary handle

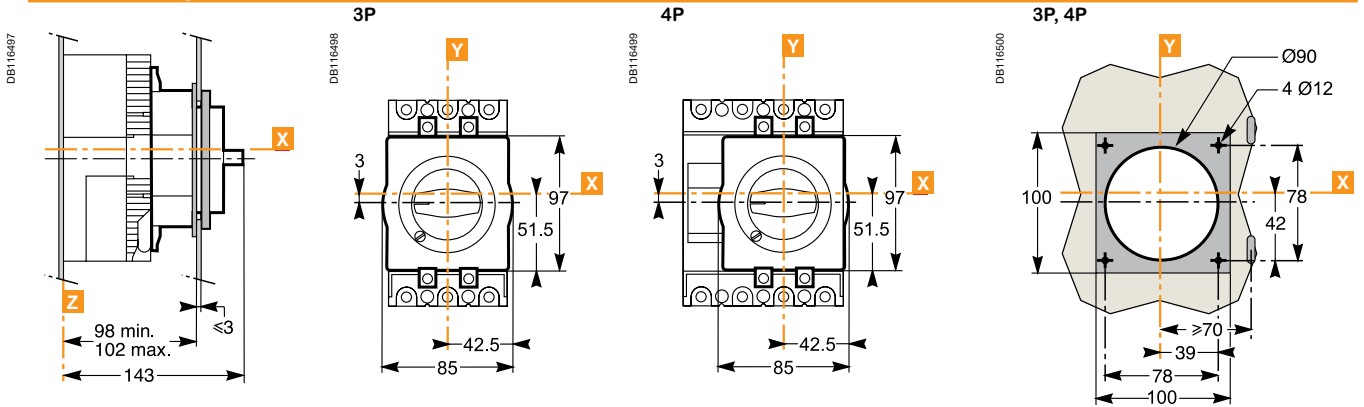

Extended rotary handle

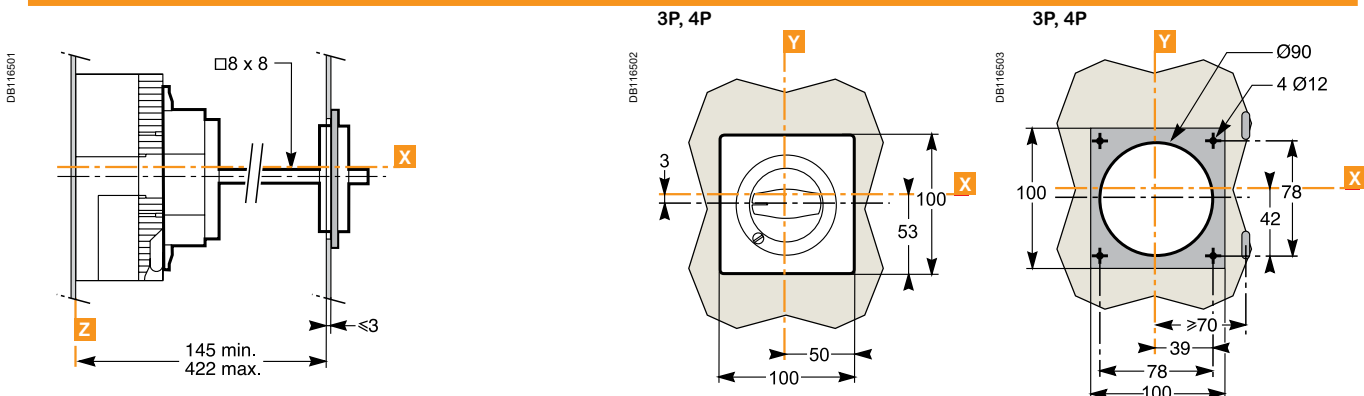

Terminal shields

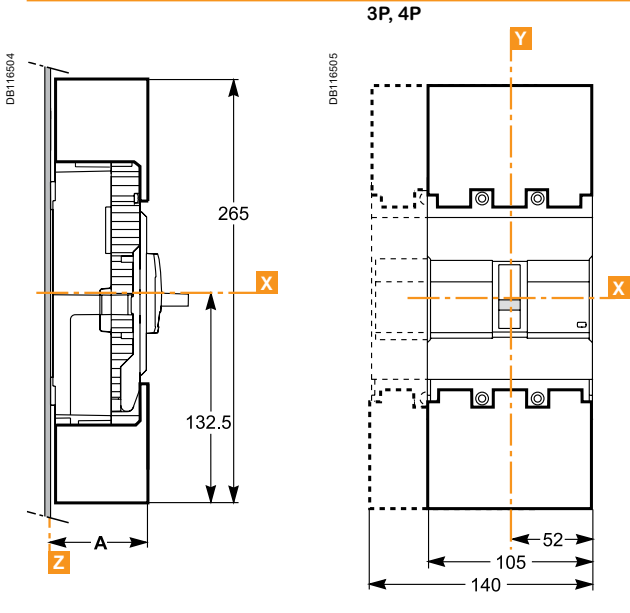

Phase barriers

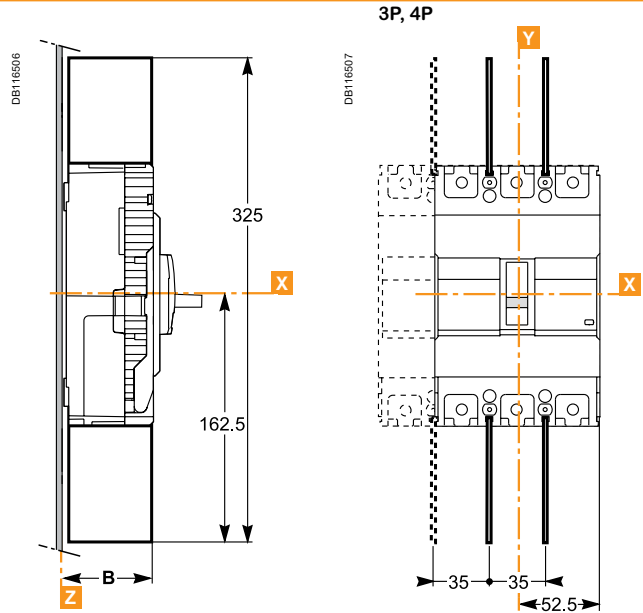

Direct rotary handle

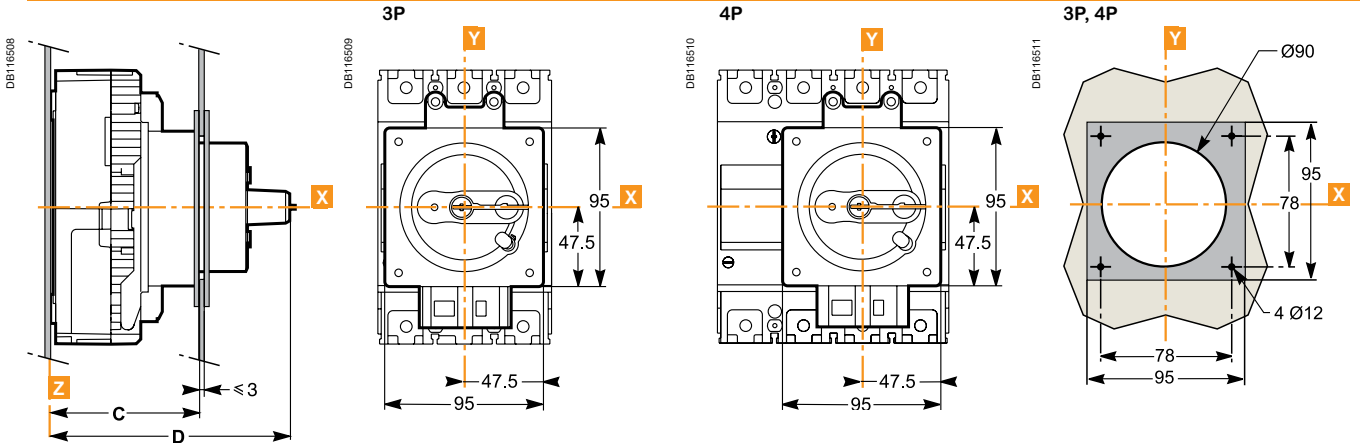

Extended rotary handle

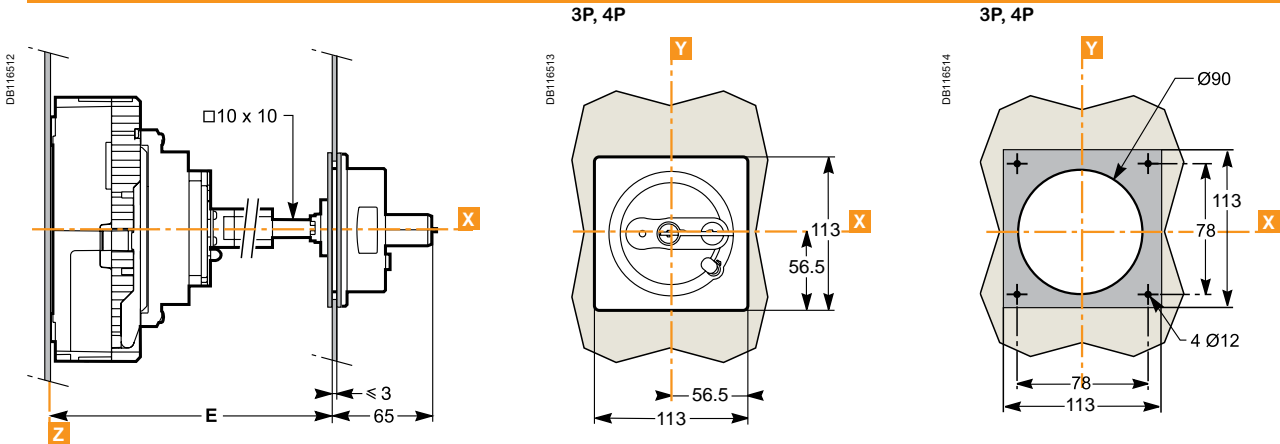

Dimensions (mm)

	A	B	C	D	E
EZC 2/3P	58.5	55	93 to 97	145	137 to 414
EZC 4P	66.5	63	101 to 105	153	145 to 422
EZCV 3P/4P					

Terminal shields and Interphase barriers

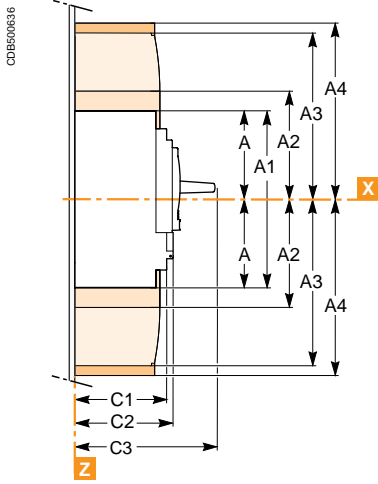

Interphase barriers.
Short terminal shields.

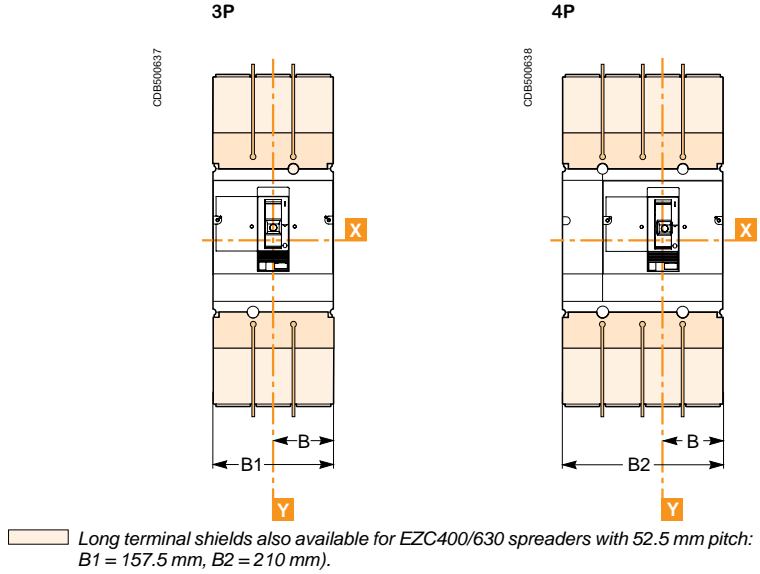

Direct rotary handle

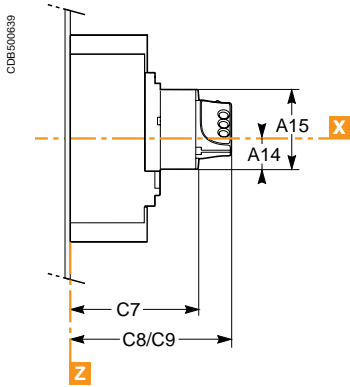

C8: without keylock
C9: with keylock

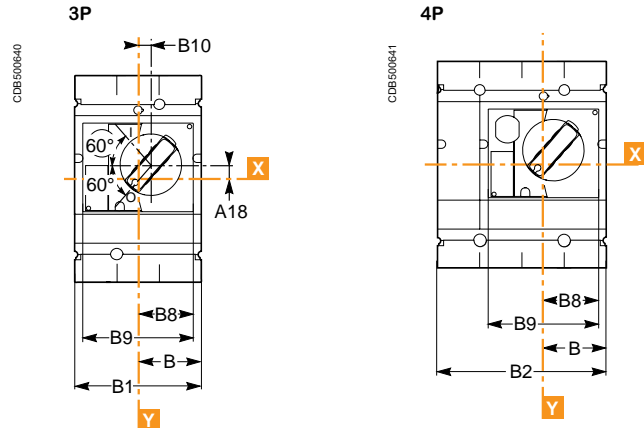

Extended rotary handle

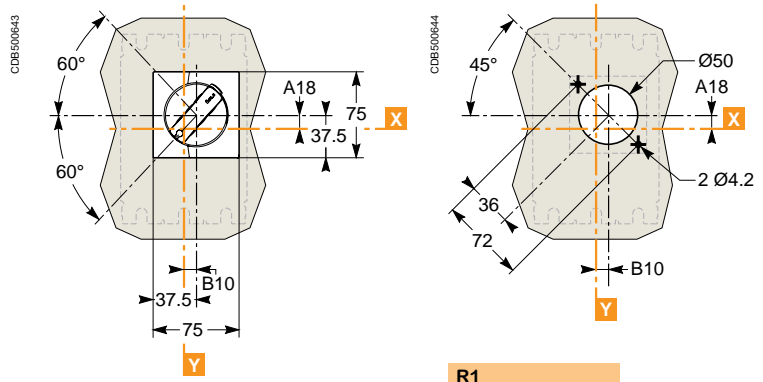
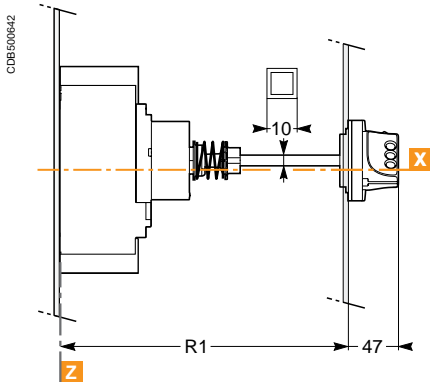

R1
min. 195
max. 600

A	A1	A2	A3	A4	B	B1	B2	C1	C2	C3	F1	F2	F3
127.5	255	142.5	200	237	70	140	185	95.5	110	168	45	22.5	90

A14	A15	A18	B8	B9	B10	C7	C8	C9	A18	B10
40	123	24.6	61.5	123	5	145	179	188	24.6	5

Safety clearances and minimum distances

When installing a circuit breaker, minimum distances (safety clearances) must be maintained between the device and panels, bars and other protection devices installed nearby. These distances, which depend on the ultimate breaking capacity, are defined by tests carried out in accordance with standard IEC 60947-2.

- If installation conformity is not checked by type tests, it is also necessary to:
- use insulated bars for circuit-breaker connections
 - block off the busbars using insulating screens.

For EasyPact EZC breaker, terminal shields, inter-phase barriers or an insulation isolator are recommended and may be mandatory depending on the utilisation voltage and the type of installation.

Minimal distance between two adjacent circuit breakers

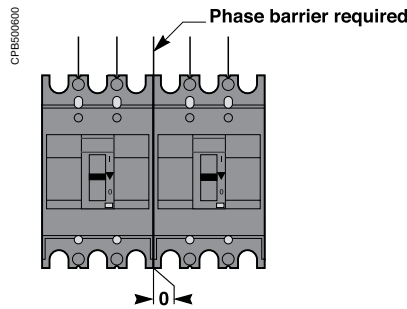

Minimal distance between the circuit breaker and top, bottom or side panels

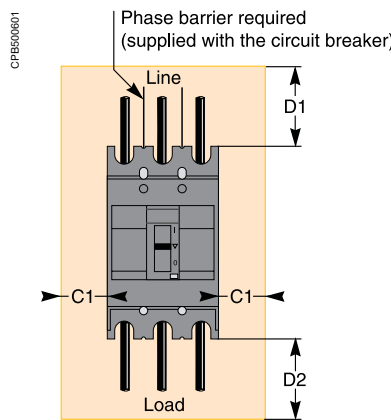

Minimal distance between the circuit breaker and front or rear panels

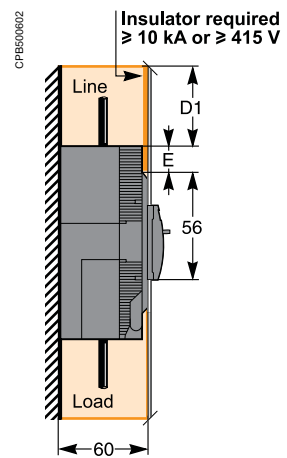

Dimensions (mm)	Bare or painted sheet metal:					
	insulated bars			bare busbar under voltage		
EasyPact EZC circuit breaker	C1	D1	D2	D1	D2	E
EZC100B/F/N	40	45	45	75	45	40
EZC100H	40	60	45	75	45	40
EZC250F/N-EZCV250N	50	60	45	140	45	42.5
EZC250H-EZCV250H	50	80	45	140	45	42.5
EZC400N	50	120	100	250	100	40
EZC400H	80	140	100	250	100	40
EZC630N	50	120	100	250	100	40
EZC630H	80	140	100	250	100	40

The mandatory distances when installing EasyPact EZC circuit breakers are calculated from the device case, not taking into account the terminal shields or the phase barriers.

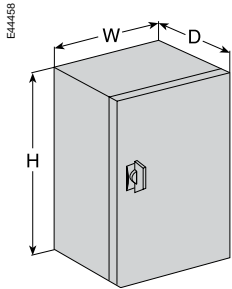

Installation in an enclosure.

Installation in an enclosure

EasyPact EZC circuit breakers can be installed in a metal enclosure together with other devices (contactors, motor-protection circuit breakers, LEDs, etc.).

Minimum enclosure dimensions (3P)

Circuit breakers	Height (mm)	Depth (mm) ⁽¹⁾	Width (mm)
EZC100B/F/N	200	90	155
EZC100H	215	90	155
EZC250F/N-EZCV250N	270	90	205
EZC250H-EZCV250H	290	90	205
EZC400N	480	160	240
EZC400H	500	160	300
EZC630N	480	160	240
EZC630H	500	160	300

⁽¹⁾ With front door.

Ambient temperature

EasyPact EZC devices are equipped with fixed thermal-magnetic trip units.

- EasyPact EZC has been particularly designed to hold 100 % In at 50 °C without tripping in normal condition (except for earth-leakage circuit breakers).
- EasyPact EZC circuit breakers may be used between -25 °C and +70 °C.
- EasyPact EZC circuit breakers should be put into service under normal ambient operating temperature conditions. Exceptionally, the circuit breaker may be put into service when the ambient temperature is between -35 °C and -25 °C.
- the permissible storage-temperature range for EasyPact EZC circuit breakers in the original packing is -35 °C to +85 °C.

To determine tripping times using time/current curves, use Ir values corresponding to the thermal setting on the device, corrected as indicated in the tables below.

Rated current (A)	25 °C	40 °C	45 °C	50 °C	55 °C	60 °C	65 °C	70 °C
EZC100								
15	17.0	15.7	15.3	15.0	14.7	14.6	14.2	13.8
16	18.1	16.7	16.3	16.0	15.7	15.6	15.1	14.7
20	21.8	20.4	20.2	20.0	19.7	19.2	18.9	18.5
25	26.9	25.7	25.3	25.0	24.7	24.5	24.3	24.0
30	34.5	31.4	30.7	30.0	29.4	29.1	28.5	28.0
32	36.8	33.5	32.7	32.0	31.4	31.0	30.4	29.9
40	42.8	40.9	40.4	40.0	39.5	38.0	37.6	37.1
45	48.8	46.9	45.9	45.0	44.4	43.3	42.6	41.9
50	54.2	52.1	51.0	50.0	49.3	48.1	47.3	46.6
60	64.4	61.8	60.9	60.0	59.0	57.5	56.6	55.7
63	67.6	64.9	63.9	63.0	62.0	60.4	59.4	58.5
75	78.6	76.8	75.9	75.0	73.5	70.4	69.8	69.1
80	84.4	82.2	81.1	80.0	78.6	77.3	76.7	76.1
100	109	103	101	100	99	94	94	93
EZC250								
63	77	69	66	63	60	56	53	49
80	93	86	83	80	77	74	71	68
100	115	106	103	100	96	93	89	85
125	148	135	130	125	120	114	109	103
150	174	160	155	150	145	139	134	128
160	186	171	166	160	154	148	142	136
175	207	188	182	175	168	161	153	145
200	236	215	208	200	192	184	175	166
225	268	244	235	225	215	205	194	182
250	297	270	260	250	239	228	215	203
EZCV250								
63	72	63	60	56	53	49	44	39
80	89	80	77	73	70	66	62	58
100	113	100	95	91	86	80	74	68
125	140	125	120	114	108	102	95	88
150	163	150	145	141	136	131	125	120
160	177	160	154	148	141	135	127	120
175	194	175	168	161	154	146	138	126
200	223	200	192	183	175	165	155	144
225	245	225	218	211	203	196	180	162
250	277	250	240	230	220	209	198	180
EZC400/630								
250	269	250	244	238	231	225	219	213
320	343	320	312	303.6	295	286	277	267.7
400	429	400	390	379.3	368.5	357.3	345.8	334
500	530	500	489.6	479	468	457	445.4	433.6
600	637	600	587	574	560.6	547	532.7	518

EasyPact EZC100 TM trip units

15-16 A

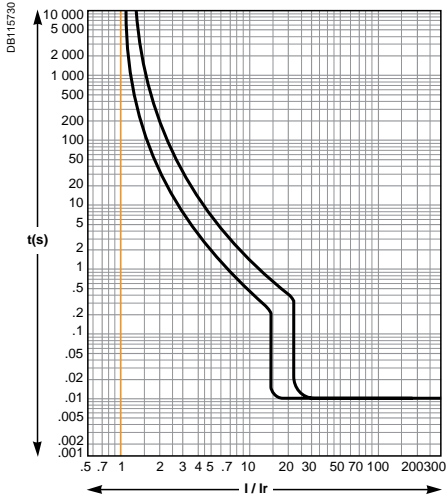

20 A

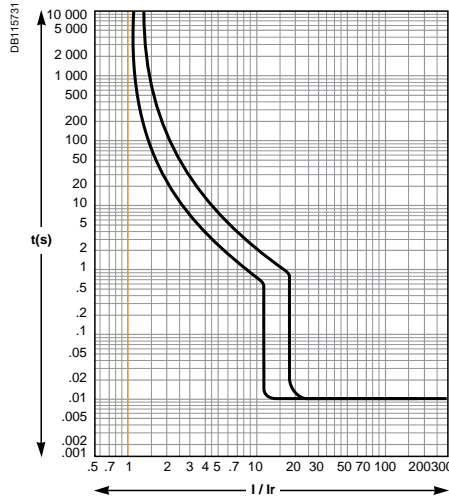

25 A

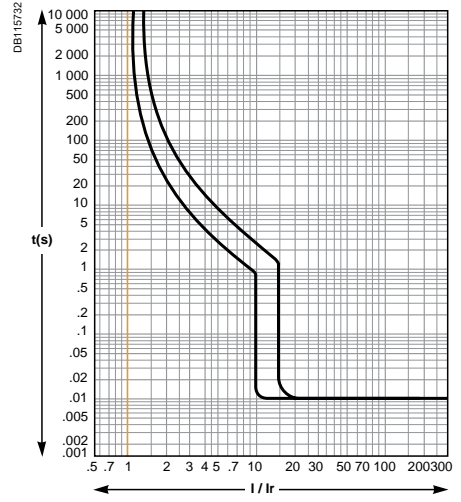

30-32 A

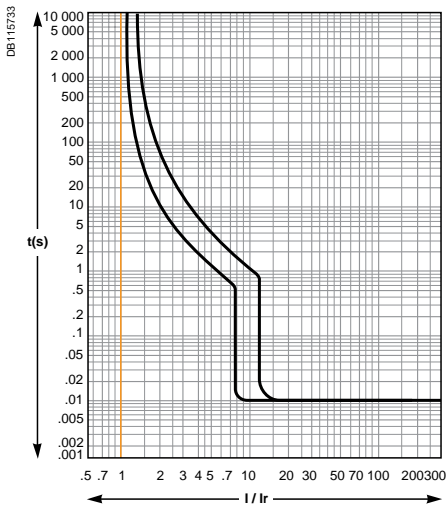

40 A

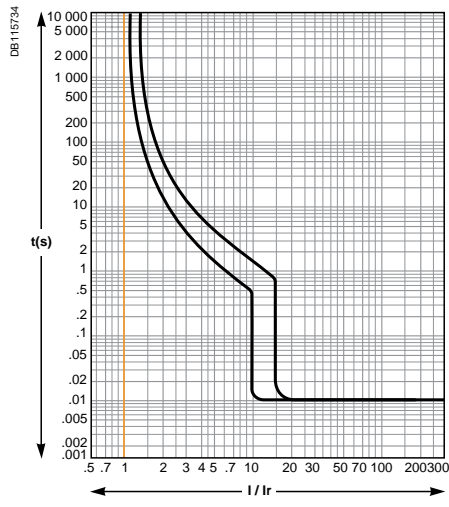

45-50 A

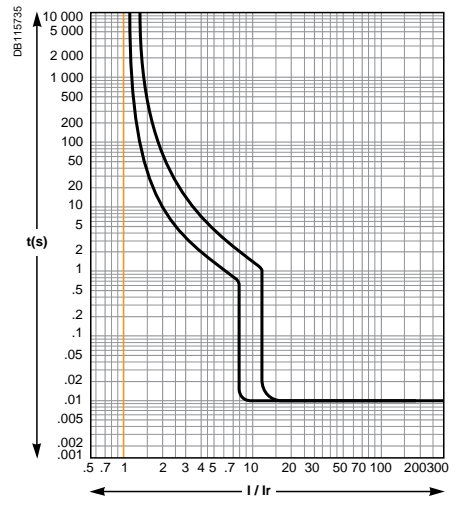

60-63 A

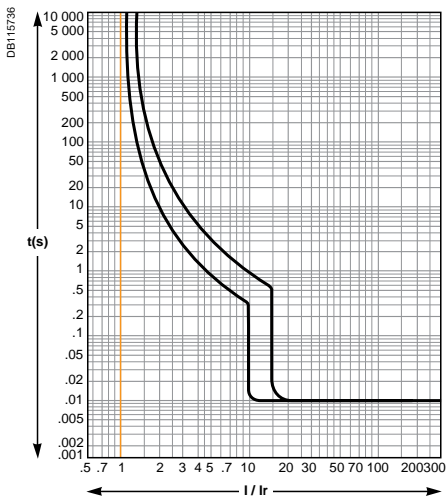

75 A

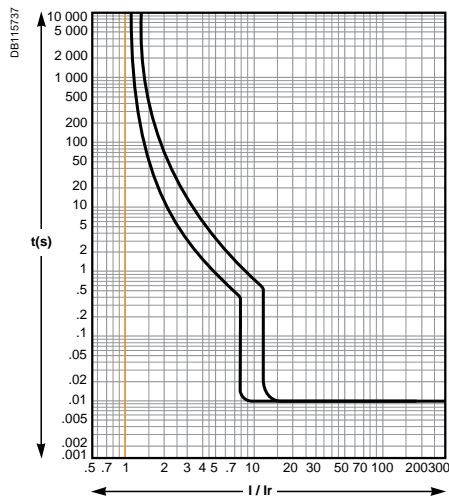

80 A

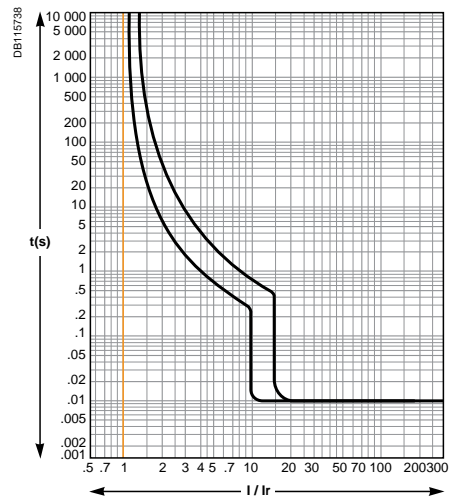

EasyPact EZC100 TM trip units (cont.)

100 A

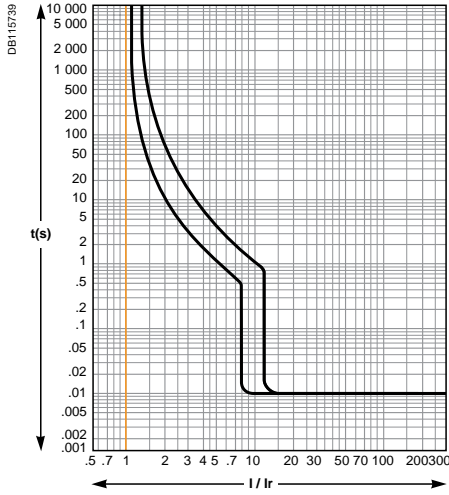

EasyPact EZC250 TM trip units

63-80-100-125 A

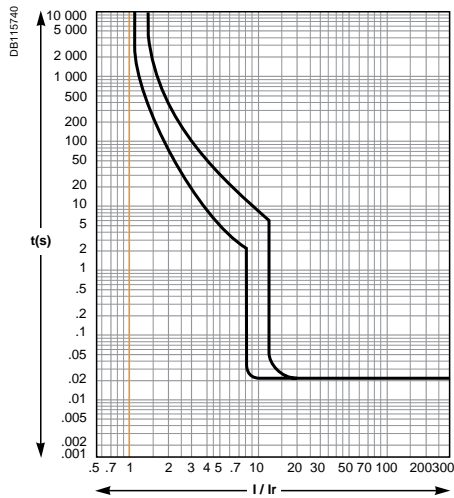

150-160-175-200 A

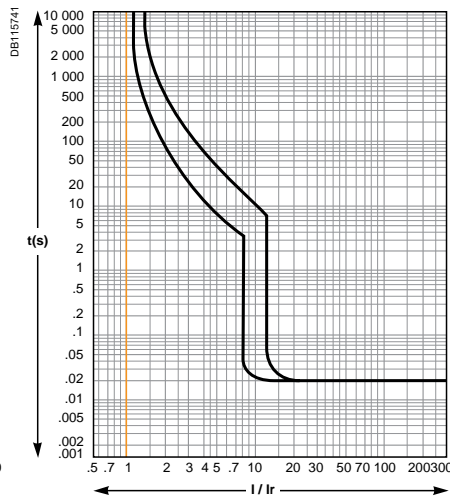

225-250 A

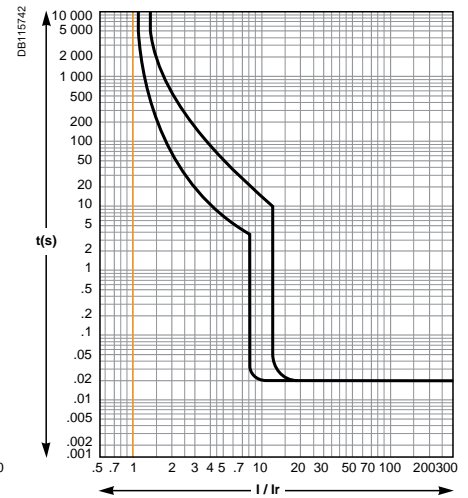

EasyPact EZC400 TM trip units

320-350-400 A

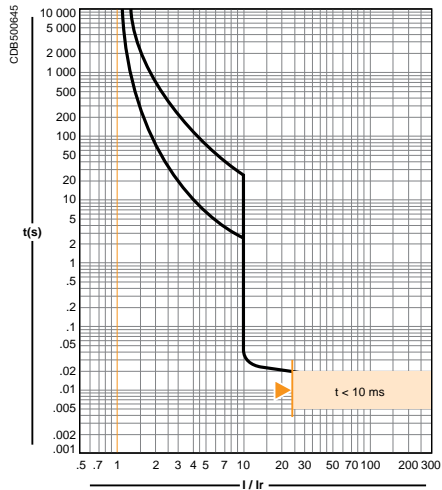

EasyPact EZC630 TM trip units

TM500D

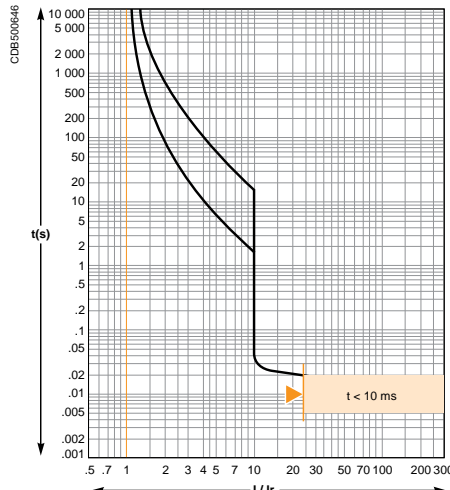

TM600D

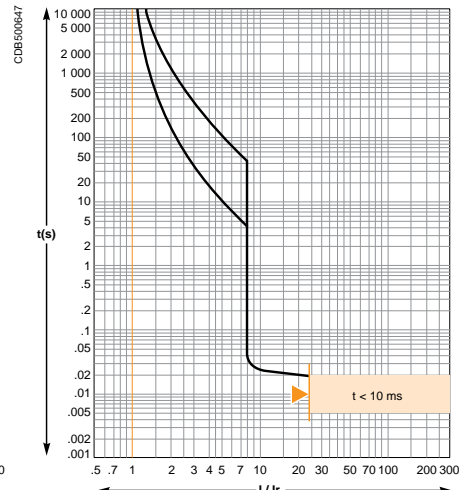

Reflex tripping.

The limiting capacity of a circuit breaker is its aptitude to limit short-circuit currents.

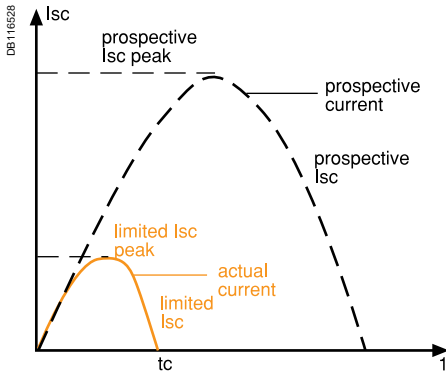

The exceptional limiting capacity of the EasyPact EZC range greatly reduces the forces created by fault currents in devices. The result is a major increase in breaking performance.

The Ics value, defined by IEC standard 60947-2, is guaranteed by tests comprising the following operations:

- break three times consecutively a fault current equal from 25% to 100% of Icu
- check that the device continues to function normally:
 - it conducts the rated current without abnormal temperature rises
 - protection functions perform within the limits specified by the standard
 - suitability for isolation is not impaired.

Longer service life of electrical installations

Current-limiting circuit breakers greatly reduce the negative effects of short-circuits on installations.

Thermal effects

Less temperature rise in conductors, therefore longer service life for cables.

Mechanical effects

Reduced electrodynamic forces, therefore less risk of electrical contacts or busbars being deformed or broken.

Electromagnetic effects

Fewer disturbances for measuring devices located near electrical circuits.

Economy by means of cascading

Cascading is a technique directly derived from current limiting. Circuit breakers with breaking capacities less than the prospective short-circuit current may be installed downstream of a limiting circuit breaker. The breaking capacity is reinforced by the limiting capacity of the upstream device.

It follows that substantial savings can be made on downstream equipment and enclosures.

Current-limiting curves

The current-limiting capacity of a circuit breaker is expressed by two curves which are a function of the prospective short-circuit current (the current which would flow if no protection devices were installed):

- the actual peak current (limited current),
- thermal stress (A^2s), i.e. the energy dissipated by the short-circuit in a conductor with a resistance of 1Ω .

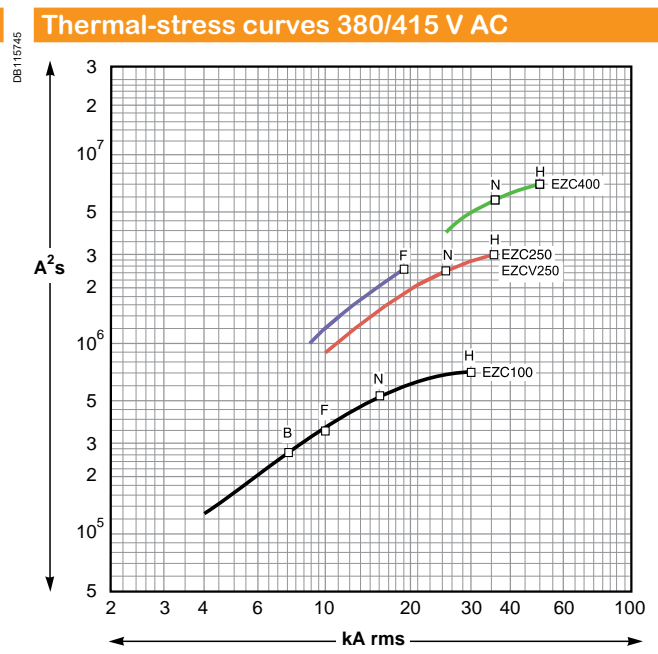
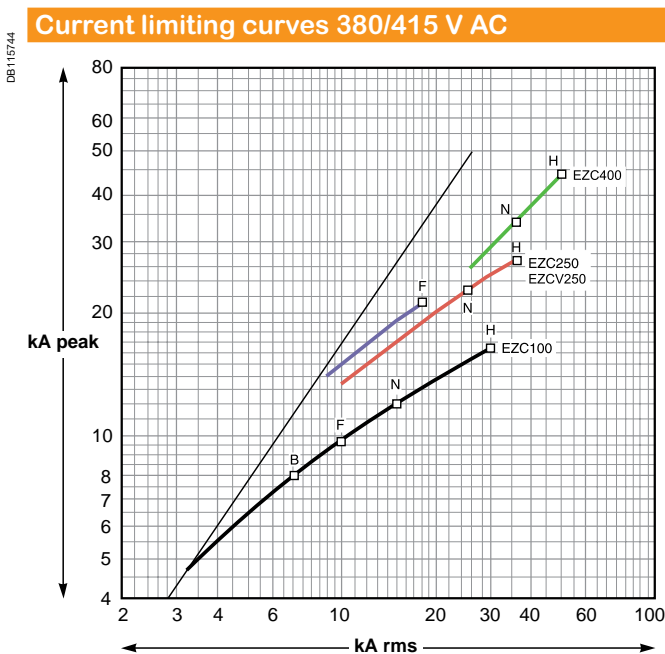

What is cascading?

Cascading is the use of the current limiting capacity of circuit breakers at a given point to permit installation of lower-rated and therefore lower-cost circuit breakers downstream.

The upstream compact circuit breakers act as a barrier against short-circuit currents. In this way, downstream circuit breakers with lower breaking capacities than the prospective short-circuit (at their point of installation) operate under their normal breaking conditions.

Since the current is limited throughout the circuit controlled by the limiting circuit breaker, cascading applies to all switchgear downstream. It is not restricted to two consecutive devices.

General use of cascading

With cascading, the devices can be installed in different switchboards. Thus, in general, cascading refers to any combination of circuit breakers where a circuit breaker with a breaking capacity less than the prospective I_{sc} at its point of installation can be used. Of course, the breaking capacity of the upstream circuit breaker must be greater than or equal to the prospective short-circuit current at its point of installation.

The combination of two circuit breakers in cascading configuration is covered by the IEC 60947-2.

Coordination between circuit breakers

The use of a protective device possessing a breaking capacity less than the prospective short-circuit current at its installation point is permitted as long as another device is installed upstream with at least the necessary breaking capacity.

In this case, the characteristics of the two devices must be coordinated in such a way that the energy let through by the upstream device is not more than that which can be withstood by the downstream device and the cables protected by these devices without damage.

Cascading can only be checked by laboratory tests and the possible combinations can be specified only by the circuit breaker manufacturer.

220/240 V network downstream from a 380/415 V network

For 1P + N or 2P circuit breakers connected between the phase and neutral on a 380/415 V network, with a TT or TNS neutral system, consult the 220/240 V cascading table to determine cascading possibilities between upstream and downstream circuit breakers.

Economy by means of cascading

Thanks to cascading, circuit breakers with breaking capacities less than the prospective short-circuit current may be installed downstream from a current limiting circuit breaker.

It follows that substantial savings can be made on downstream switchgear and enclosures.

Cascading tables

Schneider Electric cascading tables are:

- drawn up on the basis of calculations (comparison between the energy limited by the upstream device and the maximum permissible thermal stress for the downstream device)
- verified experimentally in accordance with IEC standard 60947-2.

For distribution systems with 220/240 V, 380/415 V and 440 V between phases, the tables of the following pages indicate cascading possibilities between upstream Compact/EasyPact EZC and downstream Multi 9 and EasyPact EZC circuit breakers.

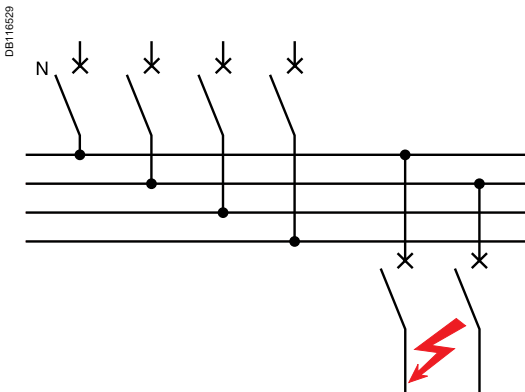

DB127584

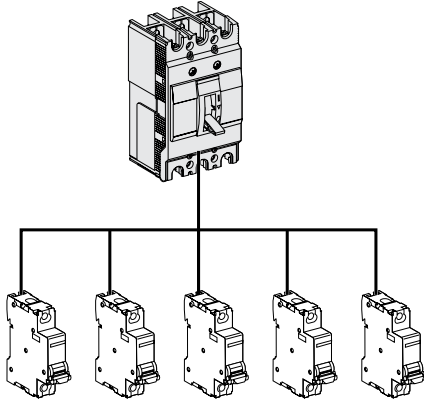

Network 220/240 V

Upstream		EZC100F	EZC100N	EZC100H
Breaking capacity kA rms		25	25	100
Downstream		Enhanced breaking capacity		
iC60a	10	25	25	50
iC60N	20	25	25	65
iC60H	30	-	-	65

Upstream		EZC250F	EZC250N EZCV250N	EZC250H EZCV250H
Breaking capacity kA rms		25	50	85
Downstream		Enhanced breaking capacity		
EZC100B	10	-	-	15
EZC100F	25	-	30	30
EZC100N	25	-	30	36
EZC100H	100	-	-	-

Upstream		EZC400N	EZC400H
Breaking capacity kA rms		40	70
Downstream		Enhanced breaking capacity	
EZC100B	10	20	20
EZC100F	25	40	40
EZC100N	25	40	40
EZC100H	100	-	-
EZC250F	25	40	40
EZC/EZCV250N	50	-	70
EZC/EZCV250H	85	-	100

Network 380/415 V

Upstream		EZC100F	EZC100N	EZC100H
Breaking capacity kA rms		10	15	30
Downstream		Enhanced breaking capacity		
iC60a	6	10	15	15
iC60N	10	-	15	15
iC60H	15	-	-	15

Upstream		EZC250F	EZC250N EZCV250N	EZC250H EZCV250H
Breaking capacity kA rms		18	25	36
Downstream		Enhanced breaking capacity		
EZC100B	7.5	-	-	-
EZC100F	10	-	15	15
EZC100N	15	-	20	25
EZC100H	30	-	-	36

Upstream		EZC400N	EZC400H
Breaking capacity kA rms		36	50
Downstream		Enhanced breaking capacity	
EZC100B	7.5	-	-
EZC100F	10	-	-
EZC100N	15	20	20
EZC100H	30	36	36
EZC250F	18	20	20
EZC/EZCV250N	25	36	36
EZC/EZCV250H	36	-	-

DB127585

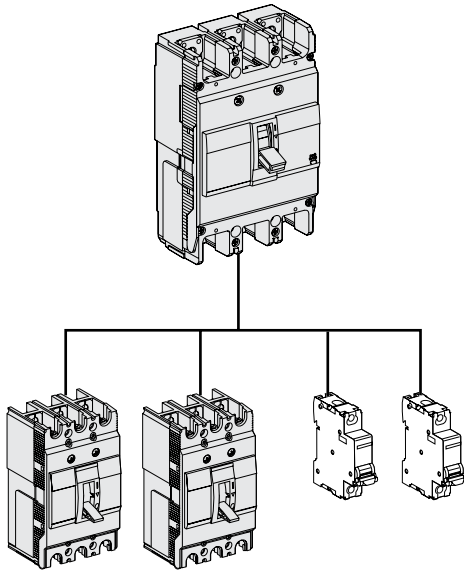

Network 440 V

Upstream		EZC250F	EZC250N EZCV250N	EZC250H EZCV250H
Breaking capacity kA rms		15	20	25
Downstream		Enhanced breaking capacity		
EZC100B	5	-	-	-
EZC100F	7.5	-	-	-
EZC100N	10	-	15	15
EZC100H	20	-	-	-

Upstream		EZC400N	EZC400H
Breaking capacity kA rms		36	50
Downstream		Enhanced breaking capacity	
EZC100B	5	-	-
EZC100F	7.5	-	-
EZC100N	10	15	15
EZC100H	25	-	30
EZC250F	15	20	20
EZC/EZCV250N	20	-	25
EZC/EZCV250H	25	-	30

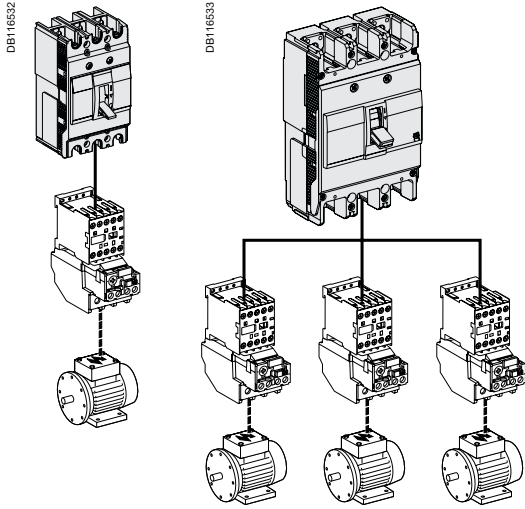

A circuit supplying a motor may include one, two, three or four switchgear or controlgear devices fulfilling one or more functions.

When a number of devices are used, they must be coordinated to ensure optimum operation of the motor.

Protection of a motor circuit involves a number of parameters that depend on:

- the application (type of machine driven, operating safety, starting frequency, etc.)
 - the level of service continuity imposed by the load or the application
 - the applicable standards to ensure the protection of life and property.
- The necessary electrical functions are of very different natures:
- short circuit protection
 - overload protection dedicated to motor
 - control (generally with high endurance levels)
 - isolation.

Protection functions

Disconnection functions:

Isolate a motor circuit prior to maintenance operations.

Short-circuit protection:

Protect the starter and the cables against major overcurrents ($> 10 I_n$).

This type of protection is provided by a circuit breaker.

Control:

Start and stop the motor and, if applicable:

- gradual acceleration
- speed control.

Overload protection:

Protect the starter and the cables against minor overcurrents ($< 10 I_n$).

Thermal relays provide protection against this type of fault. They may be:

- integrated with the short-circuit protective device
- separate.

Additional specific protection:

- limit fault protection (while the motor is running)
- preventive fault protection (monitoring of motor insulation with motor off).

Overloads ($I < 10 I_n$)

An overload may be caused by:

- an electrical problem, for instance on the mains (loss of a phase, voltage outside tolerances, etc.)
- a mechanical problem, for instance excessive torque due to abnormally high demands by the process or motor damage (bearing vibrations, etc.).

A further consequence of these two origins is excessively long starting.

A further consequence of these two origins is excessively long starting.

Impedance short-circuit ($10 < I < 50 I_n$)

Deterioration of motor-winding insulation is the primary cause.

Short-circuit ($I > 50 I_n$)

This type of fault is relatively rare. A possible cause may be a connection error during maintenance.

Protection against insulation faults

This type of protection may be provided by:

- a residual current device (RCD)
- an insulation monitoring device (IMD).

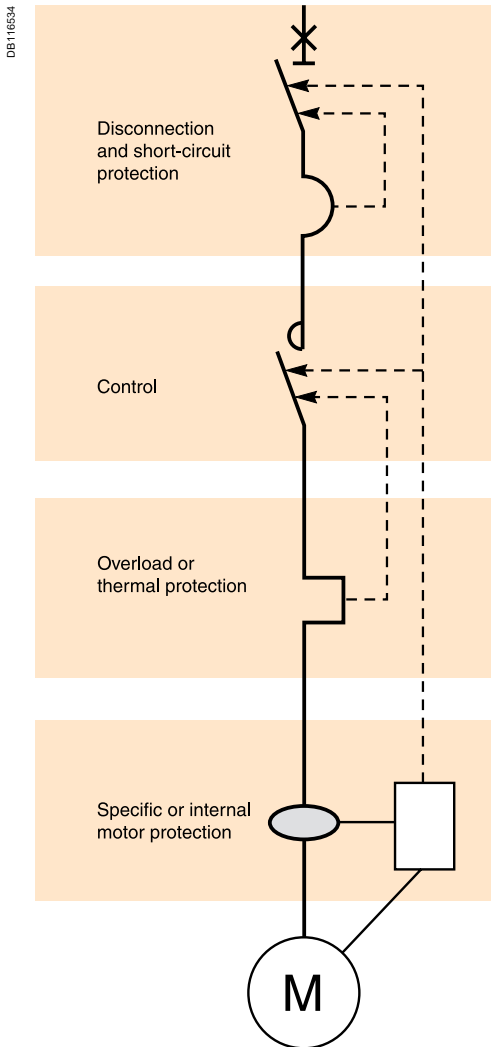

Motors P (kW)	220/230 V		240 V		380/400 V		415 V		440 V		
	I (A)	I (A)	Type	Rating In (A)	I (A)	I (A)	Type	Rating In (A)	Type	Rating In (A)	
0.37	2	1.8	EZC100	20	1.2	1.1	EZC100	20	1	EZC100	20
0.55	2.8	2.6		20	1.6	1.5		20	1.4		20
0.75	3.5	3.2		20	2	1.8		20	1.7		20
1.1	5	4.5		20	2.8	2.6		20	2.4		20
1.5	6.5	6		20	3.7	3.4		20	3.1		20
2.2	9	8		20	5.3	4.8		20	4.5		20
3	12	11		20	7	6.5		20	5.8		20
4	15	14		20	9	8.2		20	8		20
5.5	21	19		40	12	11		20	10.5		20
7.5	28	25		60	16	14		20	13.7		20
10	36	33		60	21	19		40	19		40
11	39	36		80	23	21		40	20		40
15	52	48		80	30	28		60	26.5		60
18.5	63	59		80	37	34		60	33		60
22	75	70	EZC250	125	43	40		80	39		60
30	100	95		160	59	55	EZC250	125	52		80
37	125	115		250	72	66		150	63	EZC250	125
45	150	140		250	85	80		160	76		150

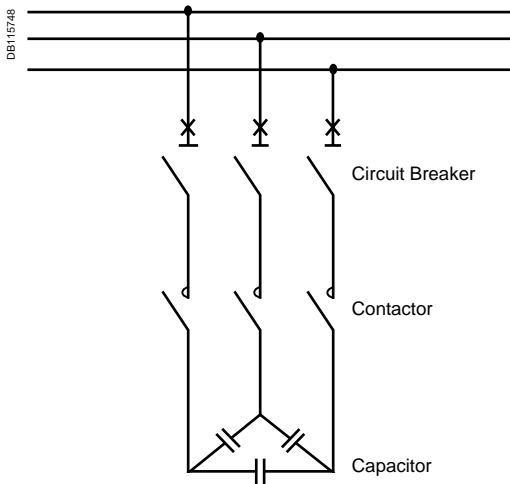

EasyPact Ezc circuit breaker is suitable for capacitor protection following the rules below:

■ **I_{nc}** = Nominal current of the capacitor

$$I_{nc} = \frac{Q_c}{U \sqrt{3}}$$

I_{nc} = Nominal Current Capacitor (A)
 Q_c = Reactive power (kVAR)
 U = Nominal Voltage (V)

■ **I_{nb}** = Nominal current of the circuit breaker (Ezc)

- I_{nb} = 1.36 x I_{nc} for standard equipment
- I_{nb} = 1.5 x I_{nc} for overrated type equipment
- I_{nb} = 1.12 x I_{nc} for detuned type equipment: 2.7 tuning
- I_{nb} = 1.19 x I_{nc} for detuned type equipment: 3.8 tuning
- I_{nb} = 1.31 x I_{nc} for detuned type equipment: 4.3 tuning
- the short-circuit (magnetic) protection-setting thresholds must enable passage of the energising transients: 10 x I_{nc} for standard, overrated and detuned type equipment.

■ **I_{cu}** = Ultimate breaking capacity of the circuit breaker (Ezc)

I_{cu} short-circuit level is given by the installation.

Example:

Table at 400 V AC - 3 phases 50 Hz for standard equipment.

Reactive power (kVAR)	I _{nc} (A)	I _{nb} (A)	Breaking capacity to Circuit Breaker	
			15 kA	30 kA
7.5	11	15	EZC100N3015	EZC100H3015
10	14	20	EZC100N3020	EZC100H3020
15	22	30	EZC100N3030	EZC100H3030
20	29	40	EZC100N3040	EZC100H3040
30	43	60	EZC100N3060	EZC100H3060
40	58	80	EZC100N3080	EZC100H3080
50	72	100	EZC100N3100	EZC100H3100
60	87	118	EZC250F3125	EZC250H3125
75	108	147	EZC250F3150	EZC250H3150
100	144	196	EZC250F3200	EZC250H3200



Catalogue numbers



Catalogue numbers

<i>Presentation</i>	<i>//</i>
<i>Functions and characteristics</i>	<i>A-1</i>
<i>Installation guide</i>	<i>B-1</i>
EZC100N/H 1P/2P	
Circuit breaker	C-2
EZC100B/F/N/H 3P	
Circuit breaker	C-3
EZC100N/H 4P	
Circuit breaker	C-4
EZC100N/H/B/F	
Accessories	C-5
EZC250F/N/H 2P/3P	
Circuit breaker	C-7
EZC250N/H 4P	
Circuit breaker	C-8
EZCV250N/H 3P/4P	
Earth-leakage circuit breaker	C-9
EZC250F/N/H, EZCV250N/H	
Accessories	C-10
EZC400N/H 3P/4P	
Circuit breaker	C-12
EZC630N/H 3P/4P	
Circuit breaker	C-13
EZC400/630N/H	
Accessories	C-14

EZC100N/H 1P/2P

Circuit breaker

EasyPact EZC100N 1P 18 kA 220/240 V

With thermal magnetic trip unit

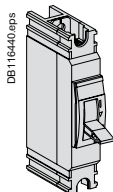

1P

Rating	1P 1t
15 A	EZC100N1015
16 A	EZC100N1016
20 A	EZC100N1020
25 A	EZC100N1025
30 A	EZC100N1030
40 A	EZC100N1040
50 A	EZC100N1050
60 A	EZC100N1060
75 A	EZC100N1075
80 A	EZC100N1080
100 A	EZC100N1100

EasyPact EZC100H 1P 25 kA - 2P 50 kA 220/240 V

With thermal magnetic trip unit

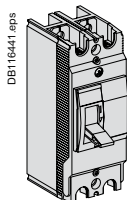

2P

Rating	1P 1t	2P 2t
15 A	EZC100H1015	EZC100H2015
16 A	EZC100H1016	EZC100H2016
20 A	EZC100H1020	EZC100H2020
25 A	EZC100H1025	EZC100H2025
30 A	EZC100H1030	EZC100H2030
32 A	EZC100H1032	EZC100H2032
40 A	EZC100H1040	EZC100H2040
50 A	EZC100H1050	EZC100H2050
60 A	EZC100H1060	EZC100H2060
63 A	EZC100H1063	EZC100H2063
75 A	EZC100H1075	EZC100H2075
80 A	EZC100H1080	EZC100H2080
100 A	EZC100H1100	EZC100H2100

EZC100B/F/N/H 3P

Circuit breaker

EasyPact EZC100B 3P 7.5 kA 400/415 V

With thermal magnetic trip unit

DB16442

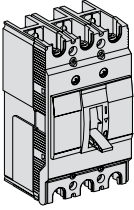

Rating	3P 3t
15 A	EZC100B3015
20 A	EZC100B3020
25 A	EZC100B3025
30 A	EZC100B3030
40 A	EZC100B3040
50 A	EZC100B3050
60 A	EZC100B3060

EasyPact EZC100F 3P 10 kA 400/415 V

With thermal magnetic trip unit

DB16442

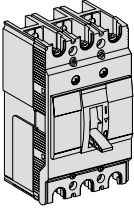

Rating	3P 3t
15 A	EZC100F3015
16 A	EZC100F3016
20 A	EZC100F3020
25 A	EZC100F3025
30 A	EZC100F3030
32 A	EZC100F3032
40 A	EZC100F3040
50 A	EZC100F3050
60 A	EZC100F3060
63 A	EZC100F3063
75 A	EZC100F3075
80 A	EZC100F3080
100 A	EZC100F3100

EasyPact EZC100N 3P 15 kA 400/415 V

With thermal magnetic trip unit

DB16442

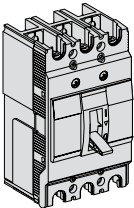

Rating	3P 3t
15 A	EZC100N3015
16 A	EZC100N3016
20 A	EZC100N3020
25 A	EZC100N3025
30 A	EZC100N3030
32 A	EZC100N3032
40 A	EZC100N3040
50 A	EZC100N3050
60 A	EZC100N3060
63 A	EZC100N3063
75 A	EZC100N3075
80 A	EZC100N3080
100 A	EZC100N3100

EasyPact EZC100H 3P 30 kA 400/415 V

With thermal magnetic trip unit

DB16442

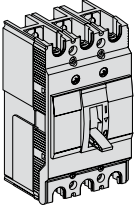

Rating	3P 3t
15 A	EZC100H3015
16 A	EZC100H3016
20 A	EZC100H3020
25 A	EZC100H3025
30 A	EZC100H3030
32 A	EZC100H3032
40 A	EZC100H3040
50 A	EZC100H3050
60 A	EZC100H3060
63 A	EZC100H3063
75 A	EZC100H3075
80 A	EZC100H3080
100 A	EZC100H3100

EZC100N/H 4P

Circuit breaker

EasyPact EZC100N 4P 15 kA 400/415 V

With thermal magnetic trip unit

DB114620.eps

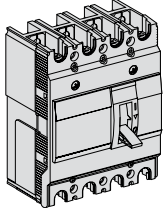

Rating	4P 3t
20 A	EZC100N4020
25 A	EZC100N4025
30 A	EZC100N4030
32 A	EZC100N4032
40 A	EZC100N4040
50 A	EZC100N4050
60 A	EZC100N4060
63 A	EZC100N4063
75 A	EZC100N4075
80 A	EZC100N4080
100 A	EZC100N4100

EasyPact EZC100H 4P 30 kA 400/415 V

With thermal magnetic trip unit

DB114620.eps

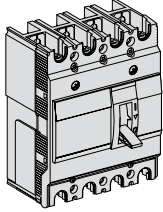

Rating	4P 3t
20 A	EZC100H4020
25 A	EZC100H4025
30 A	EZC100H4030
32 A	EZC100H4032
40 A	EZC100H4040
50 A	EZC100H4050
60 A	EZC100H4060
63 A	EZC100H4063
75 A	EZC100H4075
80 A	EZC100H4080
100 A	EZC100H4100

EZC100N/H/B/F

Accessories

Connection accessories



Cable lugs

 DB100821.eps	≤ 50 A	Cables from 2.5 to 16 mm ²	Set of 2	EZALUG0502
			Set of 3	EZALUG0503
 DB100822.eps	> 50 A	Cables from 10 to 50 mm ²	Set of 2	EZALUG1002
			Set of 3	EZALUG1003

Spreaders

 DB111674.eps	Spreaders for 3P breaker		Set of 3	EZASPDR3P
	Spreaders for 4P breaker		Set of 4	EZASPDR4P

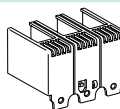
Terminal shields

 DB100824.eps	Terminal shields for 3P breaker		Set of 2	EZATSHD3P
	Terminal shields for 4P breaker		Set of 2	EZATSHD4P
				

Phase barriers

 DB100826.eps	Phase barriers		Set of 2	EZAFASB2
--	----------------	--	----------	----------

Electrical auxiliaries

Indication contacts

 DB111662.eps	Auxiliary switch (AX)			EZAUX10
 DB111663.eps	Alarm switch (AL)			EZAUX01
 DB111669.eps	Auxiliary switch + alarm switch (AX + AL)			EZAUX11

Electrical auxiliaries (cont.)

Voltage releases

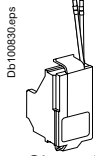

Shunt trip (SHT)

	Voltage	MX/SHT
AC	100-130 V	EZASHT100AC
	200-277 V	EZASHT200AC
	380-480 V	EZASHT380AC
DC	24 V	EZASHT024DC

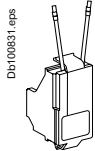

Under voltage release (UVR)

	Voltage	MN/UVR
AC	200-240 V	EZAUVR200AC

Rotary handles

Direct rotary handle (for 3/4P breaker)



Direct rotary handle (black)	EZAROTDS
------------------------------	----------

Extended rotary handle (for 3/4P breaker)

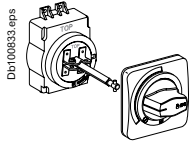

Extended rotary handle (black)	EZAROTE
--------------------------------	---------

Locks

Padlocking system

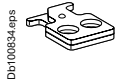

Padlocking system	EZALOCK
-------------------	---------

DIN rail adaptor

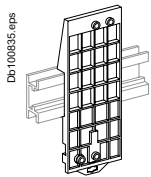

For 2 x 1P or 1 x 2P or 1 x 3P breaker Note: for 4P breaker, use 2 adaptors	EZADINR
--	---------

Plug-in 100 A

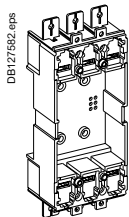

Kit, plug-in base 3P 15 A-50 A	EZAPLUG3L
Kit, plug-in base 3P 60 A-100 A	EZAPLUG3H
Fishbone connectors set of 3	EZAFSHB3

EZC250F/N/H 2P/3P

Circuit breaker

EasyPact EZC250F 3P 18 kA 400/415 V

With thermal magnetic trip unit

DB111751.eps

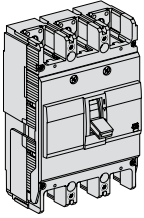

Rating	3P 3t
100 A	EZC250F3100
125 A	EZC250F3125
150 A	EZC250F3150
160 A	EZC250F3160
175 A	EZC250F3175
200 A	EZC250F3200
225 A	EZC250F3225
250 A	EZC250F3250

EasyPact EZC250N 3P 25 kA 400/415 V

With thermal magnetic trip unit

DB111751.eps

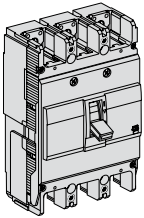

Rating	3P 3t
100 A	EZC250N3100
125 A	EZC250N3125
150 A	EZC250N3150
160 A	EZC250N3160
175 A	EZC250N3175
200 A	EZC250N3200
225 A	EZC250N3225
250 A	EZC250N3250

EasyPact EZC250H 2/3P 36 kA 400/415 V

With thermal magnetic trip unit

DB111751.eps

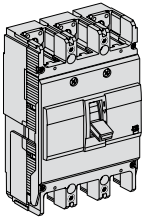

Rating	2P 2t	3P 3t
100 A	EZC250H2100	EZC250H3100
125 A	EZC250H2125	EZC250H3125
150 A	EZC250H2150	EZC250H3150
160 A	EZC250H2160	EZC250H3160
175 A	EZC250H2175	EZC250H3175
200 A	EZC250H2200	EZC250H3200
225 A	EZC250H2225	EZC250H3225
250 A	EZC250H2250	EZC250H3250

EZC250N/H 4P

Circuit breaker

EasyPact EZC250N 4P 25 kA 400/415 V

With thermal magnetic trip unit

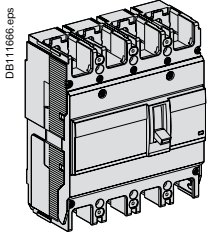

Rating	4P 3t
100 A	EZC250N4100
125 A	EZC250N4125
150 A	EZC250N4150
160 A	EZC250N4160
200 A	EZC250N4200
250 A	EZC250N4250

EasyPact EZC250H 4P 36 kA 400/415 V

With thermal magnetic trip unit

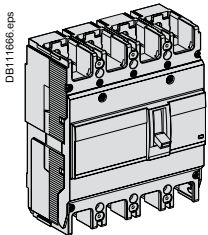

Rating	4P 3t
100 A	EZC250H4100
125 A	EZC250H4125
160 A	EZC250H4160
200 A	EZC250H4200
250 A	EZC250H4250

EZCV250N/H 3P/4P

Earth-leakage circuit breaker

EasyPact EZCV250N 3P 25 kA 400/415 V

With thermal magnetic trip unit and earth leakage protection

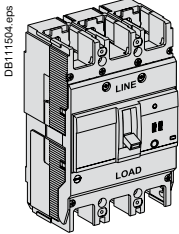

Rating	3P 3t
63 A	EZCV250N3063
80 A	EZCV250N3080
100 A	EZCV250N3100
125 A	EZCV250N3125
175 A	EZCV250N3175
250 A	EZCV250N3250

EasyPact EZCV250N 4P 25 kA 400/415 V

With thermal magnetic trip unit and earth leakage protection

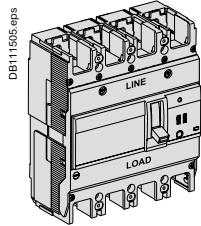

Rating	4P 3t
63 A	EZCV250N4063
80 A	EZCV250N4080
100 A	EZCV250N4100
125 A	EZCV250N4125
160 A	EZCV250N4160
200 A	EZCV250N4200
250 A	EZCV250N4250

EasyPact EZCV250H 4P 36 kA 400/415 V

With thermal magnetic trip unit and earth leakage protection

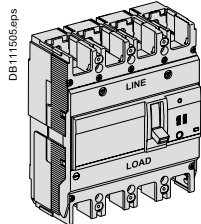

Rating	4P 3t
63 A	EZCV250H4063
80 A	EZCV250H4080
100 A	EZCV250H4100
125 A	EZCV250H4125
160 A	EZCV250H4160
200 A	EZCV250H4200
250 A	EZCV250H4250

Connection accessories

Cable lugs

 DB105209.eps	250 A	Cables from 42 to 152 mm ²	Set of 3	EZELUG2503
			Set of 4	EZELUG2504

Spreaders

 DB111674.eps	Spreaders for 3P breaker		Set of 3	EZESPDR3P
	Spreaders for 4P breaker		Set of 4	EZESPDR4P

Terminal shields

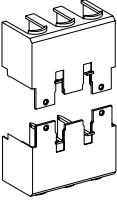

 DB105210.eps	Terminal shields for 3P breaker (60 mm depth)		Set of 2	EZETSHD3P
	Terminal shields for 3P breaker (68 mm depth)		Set of 2	EZETSHD3PN
	Terminal shields for 4P breaker (68 mm depth)		Set of 2	EZETSHD4PN

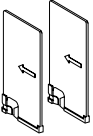
Phase barriers

 DB105211.eps	Phase barriers for 60 mm depth		Set of 2	EZEFASB2
--	--------------------------------	--	----------	----------

Electrical auxiliaries

Indication contacts

 DB105212.eps	Auxiliary switch (AX)			EZEAX
 DB105213.eps	Alarm switch (AL)			EZEAL
 DB105214.eps	Auxiliary switch + alarm switch (AX + AL)			EZEAXAL

Electrical auxiliaries (cont.)

Voltage releases

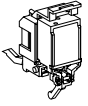
 <p>DB105215.eps</p> <p>Shunt trip (SHT)</p>	AC	Voltage	MX/SHT
		100-120 V	EZESHT100AC
		200-240 V	EZESHT200AC
	440-480 V	EZESHT440AC	

DC	24 V	EZESHT024DC
----	------	-------------

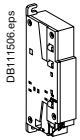
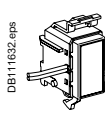
 <p>DB111536.eps</p> <p>(UVR)</p>	 <p>DB111632.eps</p> <p>(UVRN)</p>	Voltage	MN/UVR	MN/UVR ⁽¹⁾
		AC	200-240 V	EZEUVR200AC

(1) Only EZC250-4P and EZCV250-3/4P

Rotary handles

Direct rotary handle

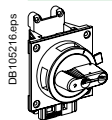
 <p>DB105216.eps</p>	Direct rotary handle (black)	EZEROTDS
--	------------------------------	----------

Extended rotary handle

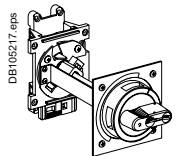
 <p>DB105217.eps</p>	Extended rotary handle (black)	EZEROTE
---	--------------------------------	---------

Locks

Padlocking system

 <p>DB105218.eps</p>	Padlocking system for EZC250-3P	EZELOCK
---	---------------------------------	---------

Plug-in

Plug-in 250 A

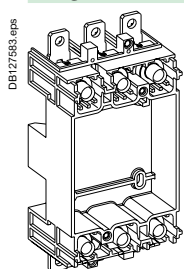
 <p>DB127583.eps</p>	Kit, plug-in base 3P 100 A-250 A 60 mm breaker	EZEPLUG3L
	Kit, plug-in connectors 100 A-250 A set of 2	EZEPCON1

EZC400N/H 3P/4P

Circuit breaker

EasyPact EZC400N 3P 36 kA 400/415 V

With thermal magnetic trip unit

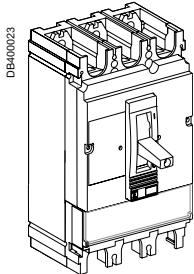

Rating	3P 3t
320 A	EZC400N3320N
350 A	EZC400N3350N
400 A	EZC400N3400N

EasyPact EZC400H 3P 50 kA 400/415 V

With thermal magnetic trip unit

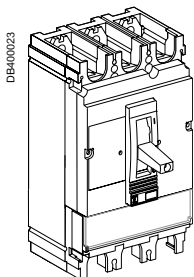

Rating	3P 3t
320 A	EZC400H3320N
350 A	EZC400H3350N
400 A	EZC400H3400N

EasyPact EZC400N 4P 36 kA 400/415 V

With thermal magnetic trip unit

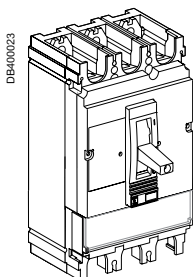

Rating	4P 3t
320 A	EZC400N4320N
400 A	EZC400N4400N

EasyPact EZC400H 4P 50 kA 400/415 V

With thermal magnetic trip unit

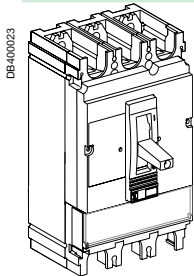

Rating	4P 3t
320 A	EZC400H4320N
400 A	EZC400H4400N

EZC630N/H 3P/4P

Circuit breaker

EasyPact EZC630N 3P 36 kA 400/415 V

With thermal magnetic trip unit

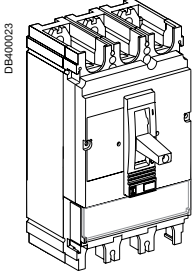

Rating	3P 3t
400 A	EZC630N3400N
500 A	EZC630N3500N
600 A	EZC630N3600N

EasyPact EZC630H 3P 50 kA 400/415 V

With thermal magnetic trip unit

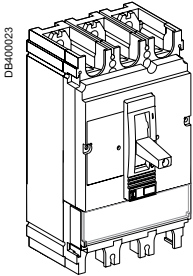

Rating	3P 3t
400 A	EZC630H3400N
500 A	EZC630H3500N
600 A	EZC630H3600N

EasyPact EZC630N 4P 36 kA 400/415 V

With thermal magnetic trip unit

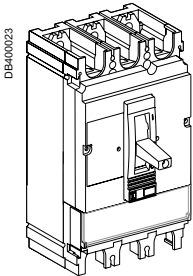

Rating	4P 3t
500 A	EZC630N4500N
600 A	EZC630N4600N

EasyPact EZC630H 4P 50 kA 400/415 V

With thermal magnetic trip unit

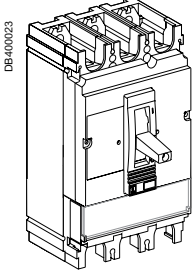

Rating	4P 3t
500 A	EZC630H4500N
600 A	EZC630H4600N

Connection accessories (Cu or Al)

Rear connections

DB112225



2 short	LV432475
2 long	LV432476

Cable connectors ⁽¹⁾

EZ2040



Aluminium connector 1x (35 to 300 mm ²)	Set of 3	LV432479
	Set of 4	LV432480

EZ2041



Aluminium connector 2x (35 to 240 mm ²)	Set of 3	LV432481
	Set of 4	LV432482

Voltage plug for aluminium connector 1 or 2 cables	Set of 10	LV429348
--	-----------	----------

Terminal extension ⁽¹⁾

EZ1012



Spreaders	52.5 mm	3P	LV432490
		4P	LV432491
	70 mm	3P	LV432492
		4P	LV432493

Insulation accessories

E18618



Short terminal shield, 45 mm (1 piece)	3P	LV432591
	4P	LV432592

E18606



Long terminal shield, 45 mm (1 piece)	3P	LV432593
	4P	LV432594



Interphase barriers	Set of 6	LV432570
---------------------	----------	----------



Long terminal shield for spreaders, 52,5mm (1 piece) (supplied with insulating plate)	3P	LV432595
---	----	----------



2 insulating screens (70 mm pitch)	4P	LV432596
	3P	LV432578
	4P	LV432579

⁽¹⁾ supplied with 2 or 3 interphase barriers

Electrical auxiliaries

Auxiliary contacts (changeover)

E18608



OF or SD or SDE or SDV	29450
OF or SD or SDE or SDV low level	29452
SDE adaptor mandatory for trip unit TM	LV540050

Voltage releases



	Voltage	MX	MN
AC	110-130 V 50/60 Hz	LV429386	LV429406
	220-240 V 50/60 Hz and 208-277 V 60 Hz	LV429387	LV429407
	380-415 V 50 Hz and 440-480 V 60 Hz	LV429388	LV429408
DC	Voltage		
	24 V	LV429390	LV429410

Rotary handle

Direct rotary handle

Standard black handle

LV432597

E18611



Extended rotary handle

Standard extended rotary handle

LV432598

E18612

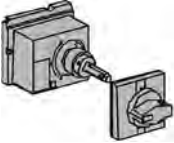

Locks

Toggle locking device for 1 to 3 padlocks

By removable device

29370

E18621



By fixed device

32631

E18613



Locking of the rotary handle

Keylock adaptor (keylock not included)

LV432604

Keylock (keylock adaptor not included)

Ronis 1351B.500

41940

Profalux KS5 B24 D4Z

42888

E18620



Life Is On



Schneider Electric Industries SAS

35, rue Joseph Monier
CS 30323
92506 Rueil Malmaison Cedex
France

RCS Nanterre 954 503 439
Capital social 928 298 512 €
www.se.com

Jun-2020

© 2019 - Schneider Electric. All Rights Reserved.
All trademarks are owned by Schneider Electric Industries SAS or its affiliated companies.
Document reference LVED212091EN

This document has been
printed on recycled paper

