

Rittal – The System.

Faster – better – worldwide.

▶ Micro Data Centre



ENCLOSURES

POWER DISTRIBUTION

CLIMATE CONTROL

IT INFRASTRUCTURE

SOFTWARE & SERVICES

FRIEDHELM LOH GROUP



Rittal – The System.

Faster – better – worldwide.



ENCLOSURES

POWER DISTRIBUTION

CLIMATE CONTROL

FRIEDHELM LOH GROUP

The whole is more than the sum of its parts.

The same is true of “Rittal – The System.” With this in mind, we have bundled our innovative enclosure, power distribution, climate control and IT infrastructure products together into a single system platform. Complemented by our extensive range of software tools and global service, we create unique added value for all industrial applications: Production plant, test equipment, facility management and data centres. In accordance with our simple principle, “Faster – better – worldwide”, we are able to combine innovative products and efficient service to optimum effect.

Faster – with our “Rittal – The System.” range of modular solutions, which guarantees fast planning, assembly, conversion and commissioning with its system compatibility.

Better – by being quick to translate market trends into products. In this way, our innovative strength helps you to secure competitive advantages.

Worldwide – thanks to global networking across 150 locations. Rittal has over 60 subsidiaries, more than 250 service partners and over 1,000 service engineers worldwide. For more than 50 years, we have been on hand to offer advice, assistance and product solutions.

IT INFRASTRUCTURE

SOFTWARE & SERVICES



Rittal – The System.

Faster – better – worldwide.



Security safe as Micro Data Centre

In addition to the physical cover in the form of an IT security safe, the configuration components listed below complement the Rittal safe and transform it into a fully fitted Micro Data Centre.

- Robust, flexible racks especially for server and network technology
- Efficient climate control solutions in a range of designs and outputs
- IT-specific power distribution
- Networkable monitoring and security solutions with the CMC III system
- Early fire detection and automatic rack fire extinguishing



Benefits of Micro Data Centres



Level E	
<ul style="list-style-type: none"> ■ Complete solution in the smallest possible space and in next to no time ■ No need for expensive upgrades to existing premises ■ Efficient cooling and extinguishing solution 	<p>High level of protection for your IT</p> <ul style="list-style-type: none"> ■ Maximum security in the Rittal range of Micro Data Centres ■ Optimum protection concept for one or more server rack solutions for small and medium-sized enterprises ■ Modular layout for installation in hard-to-access locations and for retrospective enclosure of existing IT structures ■ Future-proof investment thanks to the options of extendibility, dismantling and re-assembly ■ System-tested security and a high level of protection; testing has been carried out by accredited institutes and confirmed with test reports ■ Modified air baffle plates for optimum air routing, for efficient cooling of the Micro Data Centre

Benefits of Micro Data Centres



Level B

Solid protection for your IT

- Optimum protection concept for a server rack
- Modular layout for installation in hard-to-access locations
- Form-fit connection with the stable TS 8 framework structure
- Front and rear 482.6 mm (19") level of the TS IT rack already included with the supply
- Lower weight than the Micro Data Center Level E
- Tested security – testing has been carried out by accredited institutes and confirmed with test reports

Level A

Solid protection for small IT applications

- Ready-installed safe as a complete system
- Integral cooling
- Integral TS 8 frame structure with front and rear pairs of 482.6 mm (19") mounting angles
- Base/plinth with ground clearance
- Tested safety – The tests were carried out as system tests and confirmed via test reports

Overview of Micro Data Centres



Requirement-based security	Level E	
Usable U	42/47	
Usable interior depth mm	1000/1200	
Colour of enclosure/service door	RAL 7035	
Colour of operator door	RAL 9005	
Fire protection	Fire resistance class F 90 to DIN 4102 Part 2, compliance with limits $\Delta T < 50$ K, rel. humidity $< 85\%$ over 30 minutes ¹⁾	
Burglar resistance	WK II tool attack analogous to DIN V ENV 1630/1999-04/WK II ⁴⁾ WK III tool attack analogous to DIN V ENV 1630/1999-04/WK II ³⁾ WK IV tool attack analogous to DIN V ENV 1630/1999-04/WK II ³⁾	
Protection category	IP 56 to IEC 60 529 ⁴⁾	
Smoke protection	Based on DIN 18 095-2: 1991-03 ⁴⁾	
Modularity	■	
May be enclosed with the system operational	■	
Extendibility	■	

¹⁾ The Micro Data Centre was tested as a system.

²⁾ The critical connection points were tested as a system.

³⁾ The single safe was tested as a system with single-leaf doors and mechanical lock.

⁴⁾ The single safe was tested as a system with one single-leaf door and one bifold door and mechanical lock.

Overview of Micro Data Centres



	Level B	Level A
	42/47	15
	1000/1200	1000
	RAL 7035	RAL 7035
	RAL 9005	RAL 9005
	Fire resistance class EI 90/F 90 to DIN EN 1363-1: 1999 / based on DIN 4102-2:1997 ²⁾	Fire resistance class F 90 to DIN 4102 Part 2, compliance with limits $\Delta T < 50$ K, rel. humidity $< 85\%$ over 10 minutes ¹⁾
	RC 2 tool attack analogous to DIN EN 1630/2011-09/RC 2 ³⁾	WK II tool attack analogous to DIN V ENV 1630/1999-04/WK II ¹⁾
	IP 56 to IEC 60 529: 2000 ³⁾	IP 55 to IEC 60 529 ¹⁾
	Based on DIN EN 1634-3: 2005-01 ³⁾	–
	■	Safe is supplied assembled including cooling unit
	–	–
	–	–

Micro Data Centre Level E



Applications:

- A high level of protection against potential physical threats for IT
- Targeted configuration components transform into a complete Micro Data Centre

Benefits:

- As well as facilitating installation in poorly accessible sites, the modular design also makes it possible to retrospectively enclose existing IT structures.
- Extendibility, dismantling and re-assembly mean targeted, future-safe investments.
- Tested security – testing has been carried out by accredited institutes and confirmed with test reports

Protection standards:

- Fire protection – fire resistance class F 90 to DIN 4102 Part 2
- Compliance with limit values $\Delta T < 50$ K, relative humidity 85% for 30 minutes
- Burglar resistance WK II, III and IV, tool attack analogous to DIN V ENV 1630/1999-04/ WK II
- Smoke protection based on DIN 18 095-2: 1991-03

Material:

- Sheet steel, coated

Colour:

- Enclosure and service door: RAL 7035
- Operator door: RAL 9005

Protection category IP to IEC 60 529:

- IP 56

Supply includes:

- Micro Data Centre with operator door and service door
- Cable entry in both side elements
- Both doors with key lock

Optional:

- Choice of door hinges
- Bifold doors
- Different cable entry systems
- Cable entry additionally in the top or base unit
- Different lock variants
- Supporting structure

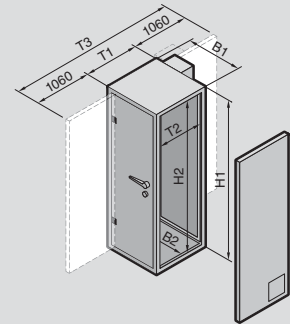

Note:

The Micro Data Centre is configured on a project-specific basis

Technical details:

Available on the Internet.

U		42	47	42	47
External dimensions mm	Width (B1)	1100	1100	1100	1100
	Height (H1)	2210	2410	2210	2410
	Depth (T1)	1200	1200	1400	1400
	Depth (T3)	3320	3320	3520	3520
Internal dimensions mm	Width (B2)	920	920	920	920
	Height (H2)	2030	2230	2030	2230
	Depth (T2)	1000	1000	1200	1200
Model no. (Safe is configured on a project-specific basis)		7999.009	7999.009	7999.009	7999.009
Empty weight excluding cooling unit and excluding rack approx. kg		660	700	730	800
Accessories					
Fire alarm and extinguisher system DET-AC/EFD Plus		see page 18	see page 18	see page 18	see page 18
CMC monitoring system		see page 19	see page 19	see page 19	see page 19
PSM – Power System Module busbar		see Internet			
PDU – Power Distribution Unit		see Internet			
Split cooling solutions		from page 15	from page 15	from page 15	from page 15
LCP – Liquid Cooling Package, rack depth 1000 mm		see Catalogue 33, page 461			

Standard protection from:



Fire



Extinguishing water



Corrosive gases



Vandalism



Unauthorised access



Dust



Theft/burglary

Options for Micro Data Centre Level E

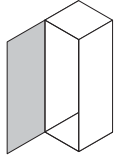
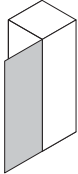
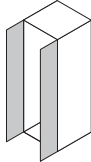
Operator door	L/h DIN door hinge	R/h DIN door hinge	Bifold door
			
	■	□	□

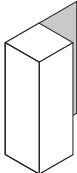
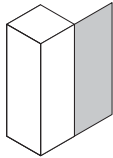
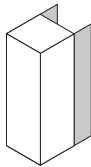

Service door	L/h DIN door hinge	R/h DIN door hinge	Bifold door
			
	■	□	□

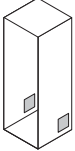
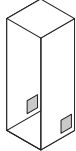
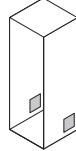
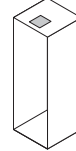
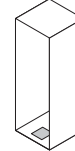
Cable entry	Soft duct ¹⁾ in both side elements	Hard duct ²⁾ in both side elements	Cable box ³⁾ in both side elements	Hard duct ²⁾ in top element	Hard duct ²⁾ in base element
					
	■	□	□	□	□



¹⁾ Size of soft duct: approx. 267 x 165 mm
For fire protection reasons, the duct may be configured up to a max. of 60% with cable up to a diameter of 15 mm and conduits up to a diameter of 18 mm.



²⁾ Size of hard duct: 2 panels each 120 x 120 mm

³⁾ Size of cable box: Cables up to a diameter of 15 mm and hoses up to a diameter of 44 mm may be routed through the cable box. No conduits may be routed through the cable box.

Locks	Key lock with 2 keys	Electronic combination lock ¹⁾	Electronic combination lock for activation via an access control system supplied by the customer
	■	□	□

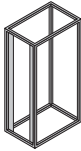

¹⁾ First code, second code and double code allocation possible. Key-based opening for inspection purposes supported.

TS-IT rack with air baffle plates								
	600				800			
Width mm								
Height mm	2000	2200	2000	2200	2000	2200	2000	2200
Depth mm	1000	1000	1200	1200	1000	1000	1200	1200
	□	□	□	□	□	□	□	□

■ Included with the supply □ Optional



Supporting structure	Steel supporting structure to compensate for the raised floor height when siting the modular safe on the bare floor. The height of the supporting structure is selectable between 100 mm and 1000 mm.	Steel supporting structure to compensate for the raised floor height when siting the modular safe on the bare floor. The supporting structure has a fire-proof covering. The height of the supporting structure is selectable between 100 mm and 1000 mm.
	□	□

■ Included with the supply □ Optional

Micro Data Centre Level B



Applications:

- Basic protection against potential physical threats for IT components. Targeted configuration components transform the safe into a complete Micro Data Centre

Benefits:

- Modular layout for installation in hard-to-access locations
- Lower weight than the Micro Data Centre Level E
- Tested security – testing has been carried out by accredited institutes and confirmed with test reports.

Protection standards:

- Fire protection – fire resistance class EI 90/F 90 to DIN EN 1363-1: 1999 based on DIN EN 4102-2: 1997
- Burglar resistance RC 2, tool attack analogous to DIN EN 1630/2011-09/RC 2
- Smoke protection based on DIN EN 18 1634-3: 2005-01

Material:

- Sheet steel, coated

Colour:

- Enclosure and rear door: RAL 7035
- Operator door: RAL 9005

Protection category IP to IEC 60 529:

- IP 56

Supply includes:

- Security safe with integral TS 8 frame
- Front and rear 482.6 mm (19") level
- Adjusted air baffle plates
- Every side element is prepared for one cable entry at the bottom and one cable entry at the top
- Operator and service door with swing-lever handle and semi-cylinder

Optional:

- Choice of door hinges
- Bifold doors
- Different cable entry systems
- Cable entry additionally in the top and base element
- Different lock variants
- Supporting structure with fire protection

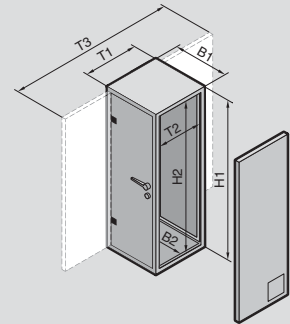

Note:

The Micro Data Centre is configured on a project-specific basis

Technical details:

Available on the Internet.

U		42	47	42	47
External dimensions mm	Width (B1)	1115	1115	1115	1115
	Height (H1)	2205	2405	2205	2405
	Depth (T1)	1377	1377	1577	1577
	Depth (T3)	3274	3274	3474	3474
Internal dimensions mm	Width (B2)	905	905	905	905
	Height (H2)	2000	2200	2000	2200
	Depth (T2)	1060	1060	1260	1260
Model no. (Safe is configured on a project-specific basis)		7999.709	7999.709	7999.709	7999.709
Empty weight excluding cooling unit approx. kg		595	630	660	700
Accessories					
Fire alarm and extinguisher system DET-AC/EFD Plus		see page 18	see page 18	see page 18	see page 18
CMC monitoring system		see page 19	see page 19	see page 19	see page 19
PSM – Power System Module busbar		see Internet			
PDU – Power Distribution Unit		see Internet			
Split cooling solutions		from page 15	from page 15	from page 15	from page 15
LCP – Liquid Cooling Package, rack depth 1000 mm		see Catalogue 33, page 461			

Standard protection from:



Fire



Extinguishing water



Corrosive gases



Vandalism



Unauthorised access



Dust



Theft/burglary

Options for Micro Data Centre Level B

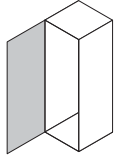
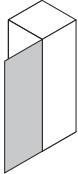
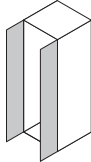
Operator door	L/h DIN door hinge	R/h DIN door hinge	Bifold door
			
	■	□	□

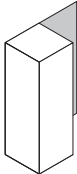
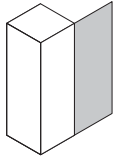
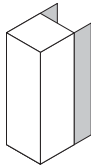

Service door	L/h DIN door hinge	R/h DIN door hinge	Bifold door
			
	■	□	□

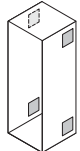
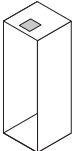
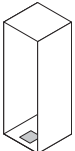
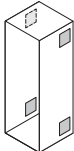

Cable entry	Soft duct ¹⁾ in both side elements	Cable box ²⁾ in top element	Cable box ²⁾ in base element	Cable box ²⁾ in both side elements
				
	■	□	□	□

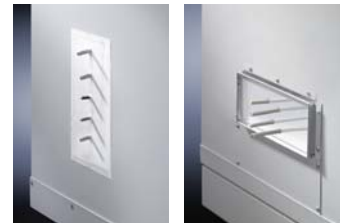

¹⁾ Size of soft duct: approx. 267 x 165 mm
For fire protection reasons, the duct may be configured up to a max. of 60% with cable up to a diameter of 15 mm and conduits up to a diameter of 18 mm.

²⁾ Size of cable box: Cables up to a diameter of 15 mm and hoses up to a diameter of 44 mm may be routed through the cable box. No conduits may be routed through the cable box.

Locks	Swing lever handle with interchangeable semi-cylinder	Swing lever handle with electronic lock for external activation	Swing lever handle with electronic lock with combination code
	■	□	□



Supporting structure	Steel supporting structure to compensate for the raised floor height when siting the modular safe on the bare floor. The supporting structure has a fire-proof covering. The height of the supporting structure is selectable between 100 mm and 1000 mm.		
	□	□	□

■ Included with the supply □ Optional

Micro Data Centre Level A



Applications:

- Protection for servers and storage applications
- Protection for business-critical data
- Storage of personal data, e.g. doctors' surgeries or tax advisors

Benefits:

- Complete system with built-in cooling and 482.6 mm (19") rack
- High level of operational and service-friendliness thanks to the two-door system
- Compatibility with other infrastructure elements
- Tested security – testing has been carried out by accredited institutes and confirmed with test reports

Protection standards:

- Fire resistance class F 90 to DIN 4102 Part 2, compliance with limits $\Delta T < 50$ K, rel. humidity $< 85\%$ over 10 minutes
- Burglar resistance WK II, tool attack analogous to DIN V ENV 1630/1999-04/WK II

Material:

- Sheet steel, coated

Colour:

- Enclosure and service door: RAL 7035
- Operator door: RAL 9005

Protection category IP to IEC 60 529:

- IP 55

Supply includes:

- Security enclosure with operating and service doors (three-point locking)
- Cable entry in both side elements
- Cooling 2.4 kW designed as a split unit

Technical details:

- Available on the Internet.

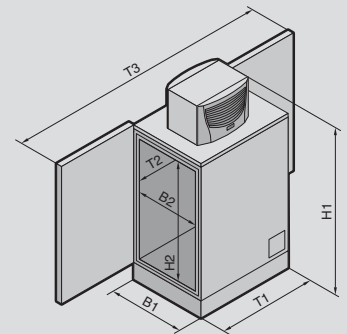

U		15
Cooling capacity kW		2.4
External dimensions mm	Width (B1)	806
	Height (H1)	1699
	Depth (T1)	1270
	Depth (T3)	2746
Internal dimensions mm	Width (B2)	620
	Height (H2)	827
	Depth (T2)	1024
Weight excluding internal fittings, including climate control unit approx. kg		360
Model No. Micro Data Centre with built-in 482.6 mm (19") rack		7999.999
Model No. Micro Data Centre without built-in 482.6 mm (19") rack		7999.898
Accessories		
482.6 mm (19") rack, 15 U, depth 1000 mm		7995.992
Fire alarm and extinguisher system DET-AC/EFD Plus		see page 18
CMC monitoring system		see page 19
PDU – Power Distribution Unit with busbar		see Internet

Standard protection from:



Fire



Extinguishing water



Vandalism



Unauthorised access



Dust



Theft/burglary

Compact split cooling solution for Micro Data Centres



- Separate, hermetically sealed internal and external circuits
- No ingress of dust or smoke gases
- The internal and external unit are connected to one another via coolant lines and control cables and shielded for fire protection.
- Air routing inside the Micro Data Centre is horizontal. Modified air baffle plates ensure targeted air routing. By separating the “cold side” from the “hot side”, air short-circuits are avoided, and the efficiency of cooling is enhanced.

- Used in rooms with climate control in the building or adequate ventilation, and low or no noise level requirements. The evaporator coil is fastened to the side panel on the inside of the Micro Data Centre, and the external unit on the service door.

Colour:

- RAL 7035

Protection category IP to IEC 60 529:

- External circuit IP 24
- Internal circuit IP 54

Supply includes:

- Internal unit
- External unit
- Coolant lines
- Data and power supply cables

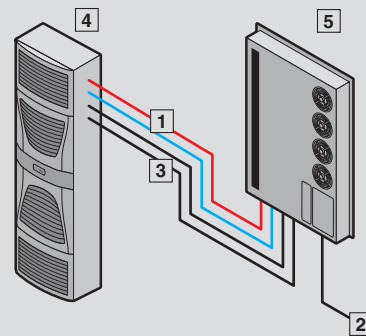

- 1 Flexible coolant lines inlet/return
- 2 Power supply
- 3 Data cable
- 4 External unit
- 5 Internal unit

Model No.		3126.230	3126.240
Rated operating voltage V, Hz		400/460, 3~, 50/60	
Dimensions mm	W x H x D external unit	500 x 1580 x 231	
	W x H x D internal unit	804 x 1544 x 100	
Useful cooling output \dot{Q}_k to DIN 3168	L 35 L 35	2500 W/3090 W	4000 W/4010 W
	L 35 L 50	2070 W/2300 W	3020 W/3250 W
Rated current max.		3.3 A/3.5 A	4.1 A/4.8 A
Start-up current		14.2 A/14.7 A	15.2 A/15.8 A
Pre-fuse T		6.3 – 10.0 A	
Motor circuit-breaker		■	■
Power consumption P_{el} to DIN 3168	L 35 L 35	1275 W/1615 W	1620 W/2125 W
	L 35 L 50	1525 W/1920 W	1825 W/2835 W
Refrigeration factor $e = \dot{Q}_k/P_{el}$	L 35 L 35	2.0	2.5
Refrigerant		R134a, 1500 g	R134a, 2900 g
Permissible operating pressure p. max.		28 bar	25 bar
Temperature and setting range		+20 °C to +55 °C	+20 °C to +55 °C
Noise level dB (A)		< 70	< 72
Weight	External unit	65 kg	65 kg
	Internal unit	70 kg	70 kg
Colour		RAL 7035	RAL 7035
Temperature control		Comfort controller (factory setting +25 °C)	

Split outdoor cooling solution for Micro Data Centres



- The internal circuit of the cooling unit is attached to the side panel inside the Micro Data Centre
- The external unit is positioned outside of the building. Internal and external units are connected to one another via coolant lines and control cables
- The hot air from the servers is drawn in at the rear, and the cooled air is expelled in front of the 482.6 mm (19") level
- The waste heat is routed directly to the outside. As a result, room ventilation or air-conditioning is not necessary

Colour:
– RAL 7035

Supply includes:

- Internal unit
- External unit
- Coolant lines
- Data and power supply cables

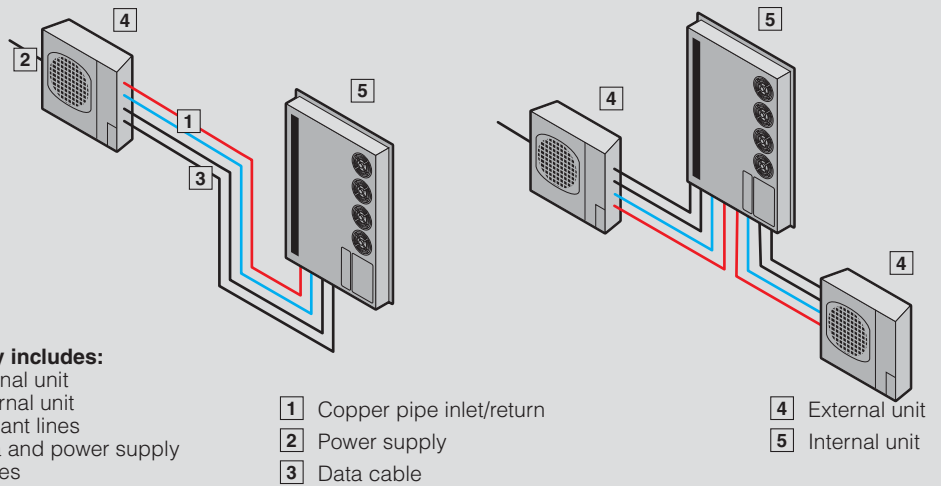

Model No.	7999.963	7999.965	7999.964	7999.966	
Redundancy	–	–	■	■	
Rated operating voltage V, Hz	230 V, 50 Hz, 1~	400 V, 50 Hz, 3~	230 V, 50 Hz, 1~ (2 x)	400 V, 50 Hz, 3~ (2 x)	
Dimensions of external unit, mm	W x H x D	795 x 610 x 290	900 x 680 x 340 (2 x)	795 x 610 x 290	900 x 680 x 340 (2 x)
Useful cooling output \dot{Q}_k to DIN 3168	L 35 L 35	2400 W	5000 W	2400 W	5000 W
Rated current max.	3.8 A	4.1 A	3.8 A	4.1 A	
Start-up current per unit	19.5 A	35 A	19.5 A	35 A	
Pre-fuse T	16 A	3 x 16 A	16 A (2 x)	3 x 16 A (2 x)	
Refrigerant	R410 a				
Temperature and setting range	–15 °C to +35 °C				
Weight	External unit	38 kg	74 kg	2 x 38 kg	2 x 74 kg
	Internal unit	59 kg	59 kg	63 kg	66 kg
Colour	RAL 7035				
Accessories					
Coolant line incl. electric control cable for 2400 W, length 20 m	7999.961	–	7999.961	–	
Coolant line incl. electric control cable for 5000 W, length 20 m	–	7999.962	–	7999.962	

Split outdoor cooling solution with inverter technology



- Targeted speed control of the compressor. The volume of refrigerant is regulated via the electronic expansion valve
- Up to 40% energy saved. The cold air is expelled in front of the 482.6 mm (19") level by the internal unit (evaporator coil), while the hot air is drawn in at the rear

Colour:
– RAL 7035

- Supply includes:**
- Internal unit
 - External unit
 - Coolant lines
 - Data and power supply cables

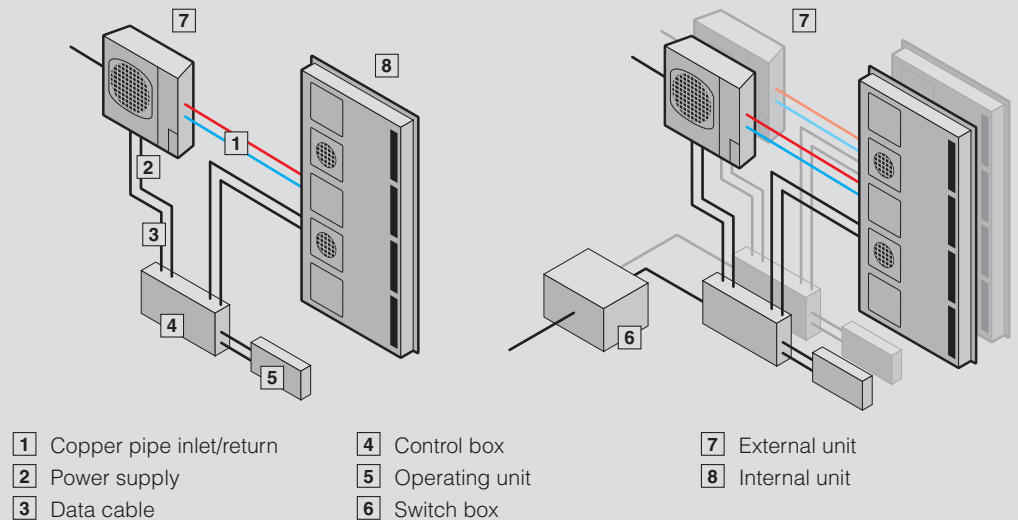

Model No.	7999.991	7999.992
Redundancy	–	■
Rated operating voltage V, Hz	230 V, 50 Hz, 1~	230 V, 50 Hz, 1~ (2 x)
Dimensions of external unit, mm	W x H x D 900 x 795 x 320	900 x 795 x 320 (2 x)
Useful cooling output \dot{Q}_k to DIN 3168	L 18¹⁾/L 35 L 18/L 43 7850 W 7030 W	7850 W 7030 W
Rated current max.	13.9 A	13.9 A
Start-up current	36 A	36 A
Pre-fuse T	25 A	25 A (2 x)
Refrigerant	R 410a	R 410a
Temperature and setting range	–15 °C to +43 °C	–15 °C to +43 °C
Noise level	48 – 49 dB (A)	48 – 49 dB (A)
Weight	External unit Internal unit	63 kg 70 kg
Colour	RAL 7035	
Also required		
Heat exchanger (evaporator coil)	3126.270	3126.270²⁾

¹⁾ Server inlet temperature

²⁾ 2 heat exchangers are required.

Fire alarm and extinguisher system DET-AC/EFD Plus



Benefits:

- Early fire detection
- Automatic extinguishing
 - Innovative extinguisher gas NOVEC 1230
 - Eco-friendly
 - Uncritical for IT components
- 482.6 mm (19") rack mount with just 1 U

Colour:

- RAL 7035

DET-AC Plus

Compact fire alarm and active extinguisher system with smoke extraction system, built into one height unit. The detection system is identical to that used in the EFD Plus system. Fire extinguishing with the extinguisher gas NOVEC 1230 is automatically activated when a main alarm is triggered. With the extinguisher gas supply provided, a volume of up to 3 m³ can be extinguished. The collective fault signal and the alarms may be forwarded to the CMC.

DET-AC Plus slave

In conjunction with the DET-AC Plus slave system, up to five bayed enclosures may be extinguished. In addition to the DET-AC Plus unit, a DET-AC Plus slave unit is used for each additional enclosure and contains the extinguisher gas for one enclosure. The pipework from the DET-AC Plus system is laid in all enclosures to facilitate detection.

EFD Plus

Compact early fire detection system with active smoke extraction system. The integral fan continuously extracts the air from the enclosure, and passes it over two smoke detectors. The first smoke detector is extremely sensitive and triggers a pre-alarm. The second smoke detector triggers the main alarm.

Photo shows a configuration example with equipment not included in the scope of supply.

	Fire alarm and extinguisher system DET-AC Plus	Add-on unit DET-AC Plus slave	Early fire detection system EFD Plus
Width (B) mm	482.6 (19" rack mount)	482.6 (19" rack mount)	482.6 (19" rack mount)
Height (H) mm	44 (1 U)	44 (1 U)	44 (1 U)
Depth (T) mm	640	570	500
Weight kg	approx. 15	approx. 12	approx. 8
Model No.	7338.120	7338.320	7338.220

Protection category	IP 20	IP 20	IP 20
Ambient temperature (operation)	+10 °C to +35 °C	+10 °C to +35 °C	+10 °C to +35 °C
Battery storage	–10 °C to +50 °C	–10 °C to +50 °C	–10 °C to +50 °C
Operating voltage	100/240 V AC 50/60 Hz	24 V DC	100/240 V AC 50/60 Hz
Uninterruptible mains electricity operation	2 x 12 V; 2.2 A/approx. 4 h	2 x 12 V; 2.2 A/approx. 4 h	2 x 12 V; 2.2 A/approx. 4 h
Connections	3 RJ 12 connectors for connecting to the CMC, alternatively 3 relay outputs, max. contact load 24 V DC/0.5 A		
Sensors	2 different scattered-light sensors	–	2 different scattered-light sensors
Display	LCD display with plain text information	–	LCD display with plain text information
No. of slave modules	max. 4	–	max. 5
No. of monitored enclosures	max. 5	–	max. 5
Extinguisher gas	NOVEC 1230	NOVEC 1230	–
Fill volume of extinguisher gas	3.2 kg	3.2 kg	–
Admissible max. protection volume	3 m ³	3 m ³	–

Also required

	7338.130	7338.130	7338.130	Cat. 33, page
Pipe kit	7338.130	7338.130	7338.130	
RJ 12 cable for alarm relaying to CMC, packs of 2	7320.814 ¹⁾	7320.814 ¹⁾	7320.814 ¹⁾	775
Access sensors	7320.530	7320.530	–	773
Depth-variable slide rails	–	–	5501.480	749

¹⁾ 2 packs are required.

CMC III monitoring system

CMC III monitoring system

The CMC III monitoring system controls physical parameters such as the temperature inside the Micro Data Centre.

The user defines limits for the various parameters. These are fully automatically monitored by the CMC. If the limits are exceeded or undercut, the CMC emits an alarm which may optionally be notified via e-mail or SMS.

The system may also be connected to the customer network (via OPC/SNMP) to represent messages or values directly in the control room system (SCADA/BMS/NMS).

The CMC III system is plug & play-ready, sensors are detected automatically, and the Web user interface is easy to use even with no prior knowledge.

The CMC Compact basic unit is available for small monitoring units, and supports the connection of up to four sensors. The CMC III Processing Unit for larger monitoring units supports the connection of up to 32 sensors.

There is a 24 V DC power supply with a redundant design, but power can also be supplied via the integral Power over Ethernet (PoE).

In addition to temperature monitoring, both the alarms and collective fault signal from the fire alarm and extinguishing system, as well as the fault signalling from the climate control system, may be switched to the CMC.

	Packs of	Model No.
CMC III Processing Unit Compact	1	7030.010
Power pack 100 – 240 V AC to 24 V DC	1	7030.060
Mounting unit, 1 U	1	7030.070
USB programming cable	1	7030.080
CAN-bus cable 0.5 m	5	7030.090
CAN-bus cable 1.0 m	1	7030.091
CAN-bus unit for CMC-TC sensors	3	7030.100
Temperature sensor	1	7030.110
Connection cable	1	7200.210

Note:

For more CMC III sensors, see Catalogue 33, page 773.



Application example for monitoring a Micro Data Centre with fire alarm and extinguisher system

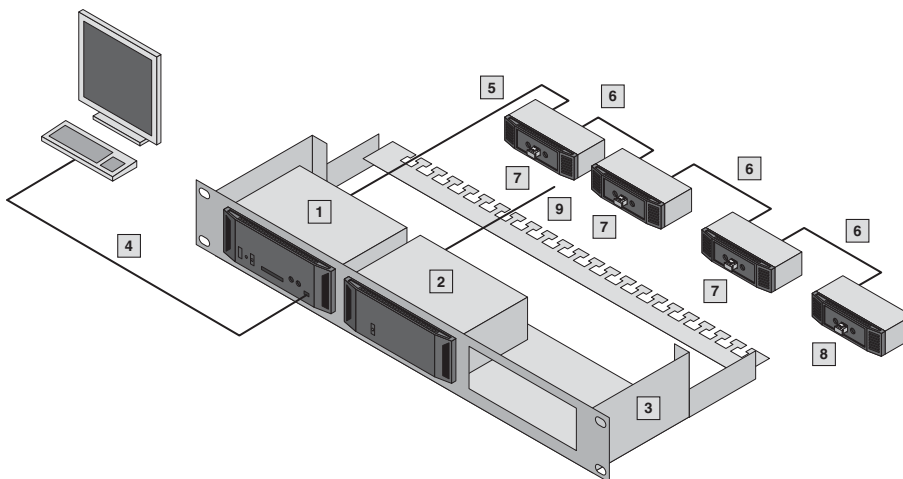

- 1 CMC III Processing Unit Compact (with front infrared access sensor, temperature sensor, 2/1 inputs/outputs)
- 2 Power pack 100 – 240 V AC to 24 V DC
- 3 Mounting unit, 1 U
- 4 Programming cable USB
- 5 CAN-bus connection cable 1 m
- 6 CAN-bus connection cable 0.5 m
- 7 CAN-bus sensor
- 8 Temperature sensor
- 9 Connection cable

Rittal – The System.

Faster – better – worldwide.

- Enclosures
- Power Distribution
- Climate Control
- IT Infrastructure
- Software & Services

RITTAL GmbH & Co. KG
Postfach 1662 · D-35726 Herborn
Phone +49(0)2772 505-0 · Fax +49(0)2772 505-2319
E-Mail: info@rittal.de www.rittal.com

ENCLOSURES

POWER DISTRIBUTION

CLIMATE CONTROL

IT INFRASTRUCTURE

SOFTWARE & SERVICES



FRIEDHELM LOH GROUP