

Experience matters

High mast LED lighting engineered to tackle your precise aviation needs.

 **MIDSTREAM**

AVIATION | SPORTS
MARITIME | HORTICULTURE

Contents

About us and you	2
Unrivalled expertise	3 - 4
Experience really does matter	5 - 8
Retrofit or new build – we're here for you	9 - 10
Getting you to a solution that works – for you	11- 14
Our products and solutions – a winning package	15 - 18
The Titan Series	19 - 22
The Atlas R Series	23 - 26
The Atlas Series	27 - 30
The Modus Series	31 - 34
Mobile Tower Series	35 - 38
High Mast Series	39 - 40
Case studies	41 - 50
Our clients	51 - 52

About us and you

We're dedicated to designing and delivering the most highly advanced, efficient and innovative LED lighting solutions for the world's aviation industry.

These solutions are manufactured to the highest quality standards to provide long-lasting, best-in-class airport apron lighting. And our technology is specifically engineered for applications that solve the challenging and complex needs of our aviation clients.

Needs like:

- Reducing energy consumption.
- Cutting maintenance costs.
- Minimising environmental impact.
- Achieving compliance to national and international standards.
- Providing smart control functionality.
- Lowering capex costs.
- All whilst vastly improving the quality of their lighting.

That's not all. We're an innovation and knowledge hub that works with design engineers and architects on lighting design. Our hub is also there to educate and guide you through this technically challenging space.

What we'll bring to you

- Our **vast global knowledge, expertise, proven record of success and understanding of compliance needs** across all sectors, locations and climates.
- A **solution and design-driven approach** from retrofit projects to complex and critical greenfield solutions.
- We **own our Product Design and R&D teams and make continued investment in product development** – to ensure we've got the experience and flexibility to meet your demands.
- A team you can trust. Why? We've designed and **delivered 1,000s of global lighting solutions**. Who else can say that?
- **Exceptional customer support 24/7** for you, your consultants, contractors, and end-users whenever and wherever you need it. Just as you'd expect from the industry leader.
- **A network of qualified installers around the world**, to deliver projects turn-key, on time and on budget, with the highest level of workmanship.
- **Unrivalled quality control and traceability, certification and fast delivery times** thanks to our European manufacturing operation.

Unrivalled expertise

Our experienced in-house Lighting Design and Engineering teams design and deliver fully compliant, custom-made airport LED lighting solutions. And we do it on-time, within budget and with a superior level of energy efficiency – anywhere in the world.

For over the last decade, we've transformed the design and manufacture of airport lighting systems. This has helped us to become the industry's key global player.



From major hubs like London Gatwick, Frankfurt, and Doha International airports to regional airports such as London City and Queen Alia to highly sensitive military sites – we've delivered time after time.

We specialise in the design, engineering, and supply of proprietary and innovative LED lighting solutions for:

- Contact Stands and Remote Aprons.
- Large-area landside applications.
- Areas with OLS restrictions.
- De-icing facilities.
- MARS stands.
- Cargo Ramps.
- VIP Aprons.
- Military Aircraft Aprons.

All designed with easy integration and longevity in mind.



Quality and reliability – always at the heart of what we do.

Our products are manufactured to the highest quality at sites in both the UK and Europe. All metal parts are laser cut, bent and painted on-site. All finished products undergo end-of-line testing before being packed and shipped.

We also have full component traceability across all our sites. We operate an audited ISO 9001, 14001 and 45001 Integrated Management System and continually monitor and improve our processes.

We're also certified to ENEC (Europe) and UL (USA) requirements. Plus, we've always passed any facility audits by independent certification bodies.

Midstream aviation lighting – at a glance:

- 100+ global airport projects completed – from major international hubs to small regional airports.
- We're the leading supplier of LED lighting systems for airport aprons.
- Our lighting designs are always fully compliant to required standards and regulations – including ICAO, EASA, FAA, MOS139, IES RP-37, CAP168, and more.
- We offer easy retrofit solutions.
- Our luminaires are heavy-duty, highly efficient, and durable.
- We offer plug and play, including control systems and functionality.
- We use our proprietary technology.
- And our solutions are low glare.

This means you can trust us to:

- Reduce your energy consumption.
- Cut maintenance costs.
- Minimise any environmental impact.
- Meet local or international requirements.
- Reduce pilot glare
- Optimize apron layouts
- Provide smart controls for dimming or zoning
- And of course, vastly improve the quality of your lighting to help your operations run safely and smoothly.

Experience really does matter

With over 100 LED airport installations globally, our experience is unbeatable.

That's why more and more customers are turning to us to help improve their operational, safety, and energy reduction needs.

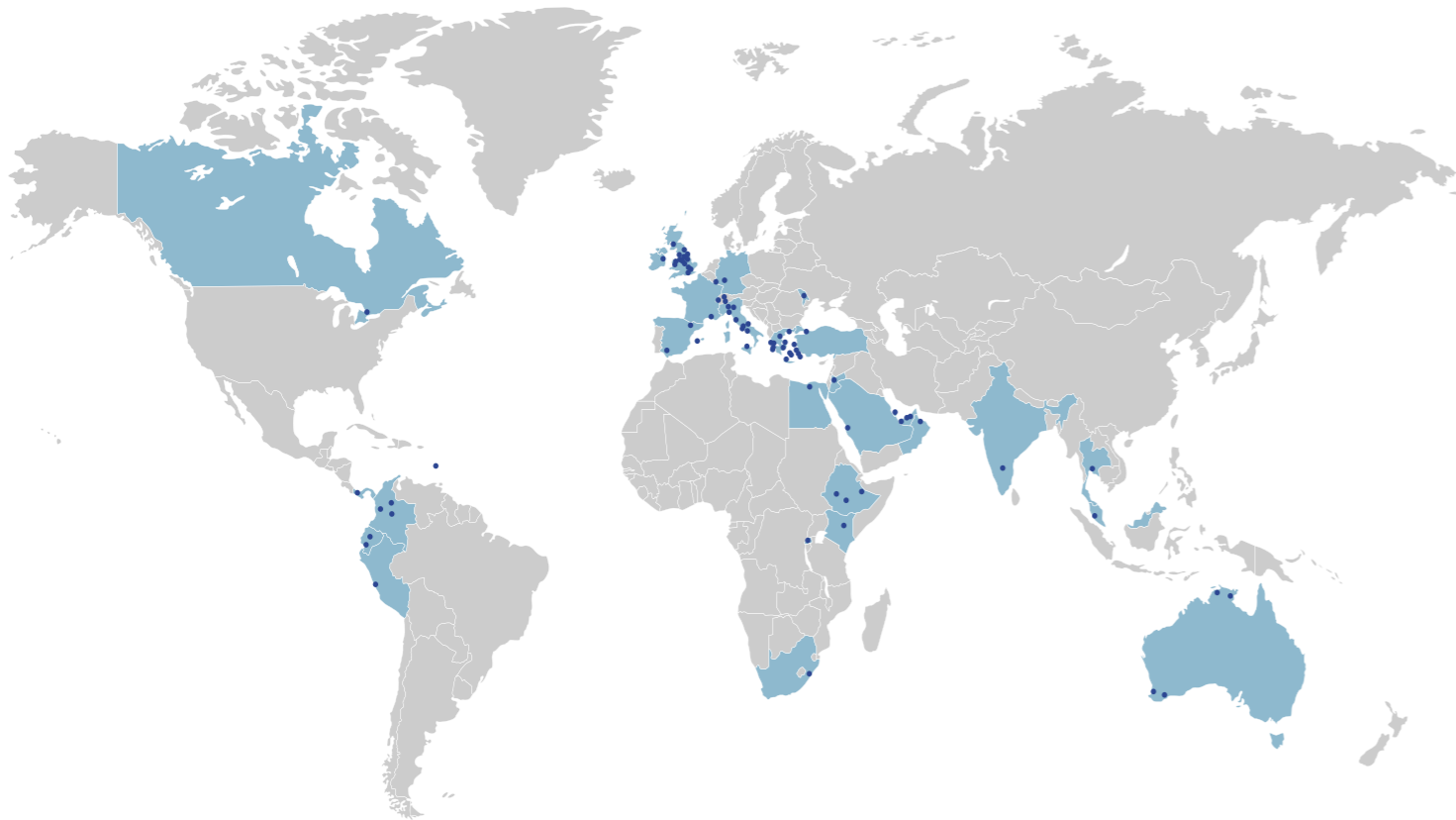

ITA	Abruzzo Airport	UK	Doncaster Airport	UK	London Gatwick Airport	HKJ	Queen Alia Int'l Airport
UAE	Abu Dhabi Royal Flight	UAE	Dubai Airport	UK	London Gatwick Fuel Farm	COL	Quibdo Airport
ETH	Aéroport de Hawassa	IRE	Dublin Airport	UK	London Luton Airport	ECU	Quito International
ETH	Aéroport de Jijiga	ZAF	Durban Airport	CHE	Lugano Airport	UK	RAF Base
ETH	Aéroport de Jimma	DEU	Frankfurt Airport	LUX	Luxembourg Airport	GRC	Rhodes Airport
QAT	Airforce Base, Qatar	CHE	Geneva Airport	UK	Manchester Airport	ITA	Rome Ciampino Airport
GRC	Aktion National Airport	ITA	Genova Airport	FRA	Marseille Provence Airport	ITA	Rome Fiumicino Airport
AUS	Albany Airport	UK	Glasgow Airport	ITA	Milan Linate	THA	Royal Thai Airways
GRC	Athens Airport	AUS	Gove Airport	UK	MOD Airforce Base	TUR	Sabiha Gokcen Istanbul
UK	BAE Warton Aerodrome	ECU	Guayaquil Airport	OMN	Muscat Airpot	GRC	Samos Airport
IND	Bangalore Airport	ESP	Ibiza Airport	GRC	Mykonos Airport	GRC	Santorini Airport
UK	Birmingham Int'l Airport	CRI	Juan Santamaría Airport	VCT	Mystique Airport	ESP	Seville Airport
COL	Bogota El Dorado Airport	RWA	Kambebe Airport	GRC	Mytilene Airport	UAE	Shaja International Airport
EGY	Borg El Airport	GRC	Kavala Airport	KEN	Nairobi Airport	GRC	Skiathos Airport
COL	Bucaramanga Airport	SAU	King Abdulaziz Airport	ITA	Napoli Airport	GRC	Thessaloniki Airport
AUS	Busselton Airport	GRC	Kos Island Airport	UK	Newcastle Airport	CAN	Toronto Airport
GRC	Cephalonia Airport	MYS	Kuala Lumpur Int'l Airport	ITA	Orio al Serio Airport	GRC	Zakynthos Airport
GRC	Chania Airport	UK	Leeds Bradford Airport	ITA	Palermo Airport	ESP	Zaragoza Airport
GRC	Chisinau Airport	PER	Lima Airport Partners	ITA	Pescara Airport	CHE	Zurich Airport
GRC	Corfu Airport	UK	Liverpool John Lennon Airport	ITA	Pisa Airport		
AUS	Darwin Airport	UK	London City Airport	ITA	Porto Airport		



London Gatwick, UK

The busiest single runway airport in the world, LGW needed to improve its number of aircraft movements. So, it's been pursuing a programme of stand reconfiguration and pier extensions.

This has involved upgrading the stand lighting to LEDs to achieve energy efficiencies and improved lighting uniformity values.

As the preferred supplier to LGW for LED apron floodlighting since 2013, they asked us to help. Our solution:

- Reduced lighting fixtures from 861 sodium lights to 564 LED fixtures.
- Helped cut their annual energy consumption from 1,885,590 kWh to 1,123,996 kWh – a 40% energy saving.
- Improved the colour rendering index from 25 to 75.
- Delivered an increase in average light levels and uniformity by 50%.



Rome Fiumicino, Italy

FCO, also known as Rome Leonardo da Vinci Airport, had several problems it needed solving.

Firstly, it needed to make sure its lighting complied with EASA regulations and guarantee zero light spill in line with local laws. Secondly, they had to reduce energy use and maintenance costs. And finally, they wanted their lighting system to be a smart network.

Our solution met all those requirements:

- We designed and supplied a new floodlighting solution using the whole range of our Titan Series – from 170W to 700W. This:
- Complied with both EASA and local laws.
- Cut maintenance costs and cut energy use by 61%
- And to provide the smart punctuality needed help keep costs to a minimum, the floodlights were supplied with DALI protocol to plug and play with the existing controls system.



King Shaka Int'l Airport, South Africa

The third busiest airport in South Africa, DUR asked us to help make sure its lighting complied with International Civil Aviation Organisation (ICAO) regulations. They also needed to replace its current metal halide lights to keep the apron areas compliant. And they wanted to have full lighting control without the need to pull any existing wiring.

To help then achieve these goals we:

- Used our Titan 720 Series as it was the only lightweight floodlight in the market that could match the output of a 2kW metal halide for the apron areas and meet ICAO regulations too.
- Worked with our partner ZQLabs to install a full wireless control system – one of the first to be used in an airport environment.

When the project was completed the light levels had almost trebled, maintenance costs were reduced dramatically, and energy costs were reduced by a massive 77%.



Quito Int'l Airport, Ecuador

The main airport in Ecuador, UIO was tasked by the local civil aviation authority to increase uniformity levels to double the ICAO Annex 14 requirements. After winning their international tender we designed, supplied and worked with a local contractor to install a new LED lighting system for all apron areas.

This made UIO the first airport in South America to convert all their apron lighting to superior LED technology. This technology:

- Doubled the uniformity level – more than meeting the task it was set.
- Plus, it increased the airport's lighting levels by 50%.

To avoid heavy civil and infrastructure costs, we designed specialist brackets which were installed on the hangar roof to provide the additional illumination. This bespoke solution allowed the customer to deliver the project ahead of schedule and below budget, something we are always proud to offer to our customers.



14 Regional Airports, Fraport, Greece

A leading player in the global airport business, amongst its portfolio it has 14 Greek airports it manages. All these airports had outdated lighting systems that weren't compliant with EASA regulations. And this needed fixing – fast.

Working with Intrakat, Fraport's main contractor, we designed and delivered a completely new, compliant lighting system for each airport that:

- Redesigned the apron lighting to improve airports' throughput capacity
- Reduced shadow areas between planes, guaranteeing a better working environment for ground staff.
- Cut energy use – by 55% on average, and lowered maintenance costs.



Queen Alia Int'l Airport, Jordan

Jordan's main and largest airport, Queen Alia needed to make sure its lighting complied with ICAO rules. Plus, cut its high energy use. And replace its HPS system which required a lot of maintenance to keep the aprons compliant with regulations. So, we:

- Designed and supplied a new floodlighting solution, using our Titan 560 floodlights. This new system complied with ICAO regulations and kept the aprons fully compliant.
- This solution also doubled light levels, reduced maintenance costs considerably compared to the old sodium system, and cut energy use by 66%.

Working with the military

We don't just deliver results in the commercial arena. We've also completed many projects for air force bases around the world, including projects in the UK, Spain, Italy, Qatar, Germany, Greece, and the USA.

Our specialist knowledge of air force base design means we understand the complexities of working on these sites. This has helped us design specific solutions tailored for their precise needs – such as high power, narrow beam, low glare and more.

Retrofit or new build – we're here for you

Retrofit

For some projects, a retrofit approach is the perfect solution. If that's the case for you, our in-house Lighting Design and Manufacturing teams can work closely with your consultants, engineers, contractors, and AGL suppliers to deliver it.

- Our retrofit solutions have been designed for fast, efficient installation to existing structures.
- Plug and play features provide for safe mounting, demounting and maintenance.
- The adjustable brackets allows for multiple arrangements on all types of heads and crowns.
- And our luminaires are supplied with an IP68 quick plug, avoiding the need for rewiring the lighting system.

For new build projects, we:

- Work with our extended global team of certified partners, design consultants, engineers, and asset owners to design and execute lighting schemes. This can be for new sites and expansion projects.
- Give advice at the early stages of master planning and detailed design or roll out the entire project on a turnkey basis.
- Deliver outstanding projects with the highest level of efficiency and affordability in mind, thanks to our 1st class technology.

We also continue to work with:

- Multinational contractors, including leading names in engineering and construction, on the delivery of LED replacement programmes.
- Airports and architects directly on the design of ICAO compliant stands and terminals.
- Almost all leading AGL solution providers to assist in delivering a truly scalable, fully integrated, CAT IIIC compliant systems.



Getting you to a solution that works – for you

Unlike other ‘specialist’ lighting companies, we truly deliver full turnkey solutions. From day one to the final sign-off of your aviation project and beyond, we can and do take care of everything.

- Airport lighting with LED technology needs the right products and level of expertise to deliver results that meet design specifications and regulations. We have that expertise.
- Our high-power LED aviation lighting products allow us to deliver projects to the most exacting specifications. Whether working to industry regulations, or local governmental requirements, we know and meet what’s needed.
- And our experienced teams have a deep level of knowledge and combined expertise across all manner of high power, full turnkey airport lighting solutions. They’re always developing innovative, aviation-specific, high power LED lighting products too.

So, where high standards and efficiency are needed, we deliver a quality solution that gives you more, for less – making us the right choice for your next project.

Lighting design & documentation – we get it right first time, every time

We provide expert lighting design & documentation services right from the start of a project – free of charge. Even if your requirements change as the project develops, we won’t abandon you.

Our design services include everything from the initial design consultations – including specifications, rendering, layout planning, photometrics, energy efficiency calculations and much more.

We’re happy to work with your consultants, partners, operational managers, engineers and whoever else has to input to the project. After all, creating the perfect airport lighting is a team effort.

And, if local authority planning permission is needed, we’ll work with you to write and submit the planning applications.

Our in-house Lighting Design and Engineering teams have designed hundreds of layouts and installed apron solutions in over 100 airports, globally. They work with the world’s top consultants on projects from small island aerodromes to the largest international transport hubs. Our Design Team is also represented on the global IES RP37-15 Design Committee – along with members from prestigious design firms.

We offer a full lighting design package from start to finish. This includes a fully compliant design to local and international standards, a detailed BOM, photometric layouts, lux value charts, IES files, installation instructions, plus oversight and maintenance support.

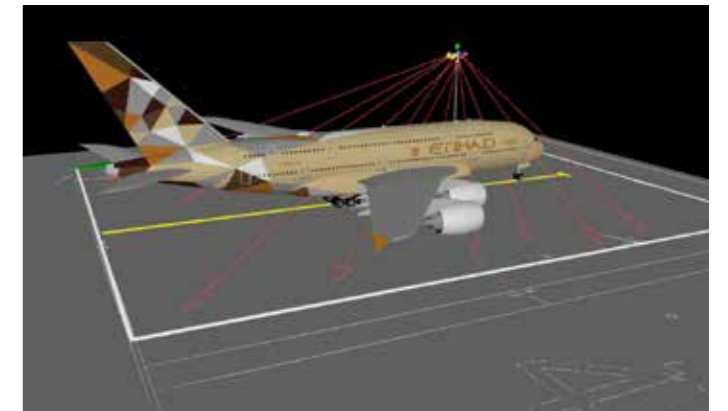

Our experience extends to; Multiple Aircraft Receiving Stands (MARS), access roads and equipment areas, PIPO / PIPB configuration stands, remote stands, fuel farms, OLS restriction areas, and landside and parking areas.

Because our in-house Lighting Design Team was involved in the development of our proprietary refraction lens, they have a unique knowledge of how to create designs for the most challenging environments. So, we can offer a full lighting package to our clients. This includes a fully compliant design to ICAO or EASA/FAA standards with a report of the luminaire numbers, complete installation, handling and maintenance guidance, as well as detailed mounting instructions to support the installation teams. As-built drawings can also be provided if needed.

In our designs, photometric calculations are carried out based on the criteria listed in your bid specification and the ‘Outdoor Lighting for Airport Environments IES RP-37-15’. As specified in IES RP-37-15 / ICAO ANNEX 14 regulations our calculations are on each aircraft stand, and over the whole apron area.

And during the design phase, we’ll work with you and your prime contractors to validate and revise the lighting design. This includes the fixture selection to make sure all your needs are met.

Installation – no hassle and no wasted time

To make sure your installation goes smoothly, our expert engineers and supervisors can be with you from start to finish.

Our installation teams have years of experience across all our sectors – especially aviation. So, whatever the installation needs, they'll be able to support you at every stage. This includes everything from; mast installation, fitting and assembling the lighting, lux surveys, compliance checks and beyond – wherever the project is located and whatever the environment.

We are one of the few manufacturers which provides both integrated driver and remote driver solutions. During the design phase, we'll work with you and your consultants to develop designs showing the photometrics and analysis of both solutions. From there, we can decide which meets your operational, safety and energy reduction objectives.

Our mounting instructions provide installation teams with precise aiming guidance as well as detailed arrangements of luminaires on the masts. This helps make sure any errors are avoided and guarantees compliance with the initial lighting design.

Maintenance and warranty – protecting your investment

The great thing about airport LED lighting is it requires far less maintenance. It's important though that you protect your investment to maximize the life span and return on investment. This is especially in true sectors like aviation where compliance and regulations come into play. So, our Airport Lighting Warranty lasts for 10 years!

Training and Education – getting your team up to speed

Many of the sectors we work in have very strict safety regulations – not just for the installation stage but for the final solution too. So, our experienced team is on hand to support you. Whether a partner, client, consultant or engineer, we've got your back.

We offer a range of training and educational courses to support both our product and sector partners. From technical training on our product range to installation guidance or photometric testing guides and beyond, we'll be there for you

Advising and consulting – let us help you make the right choice

We've got many years of in-depth experience across the aviation sector, and a very experienced management and advisory team. So, we can support, advise and consult at any time. Whether for a completely new project or to look at existing solutions, just let us know.

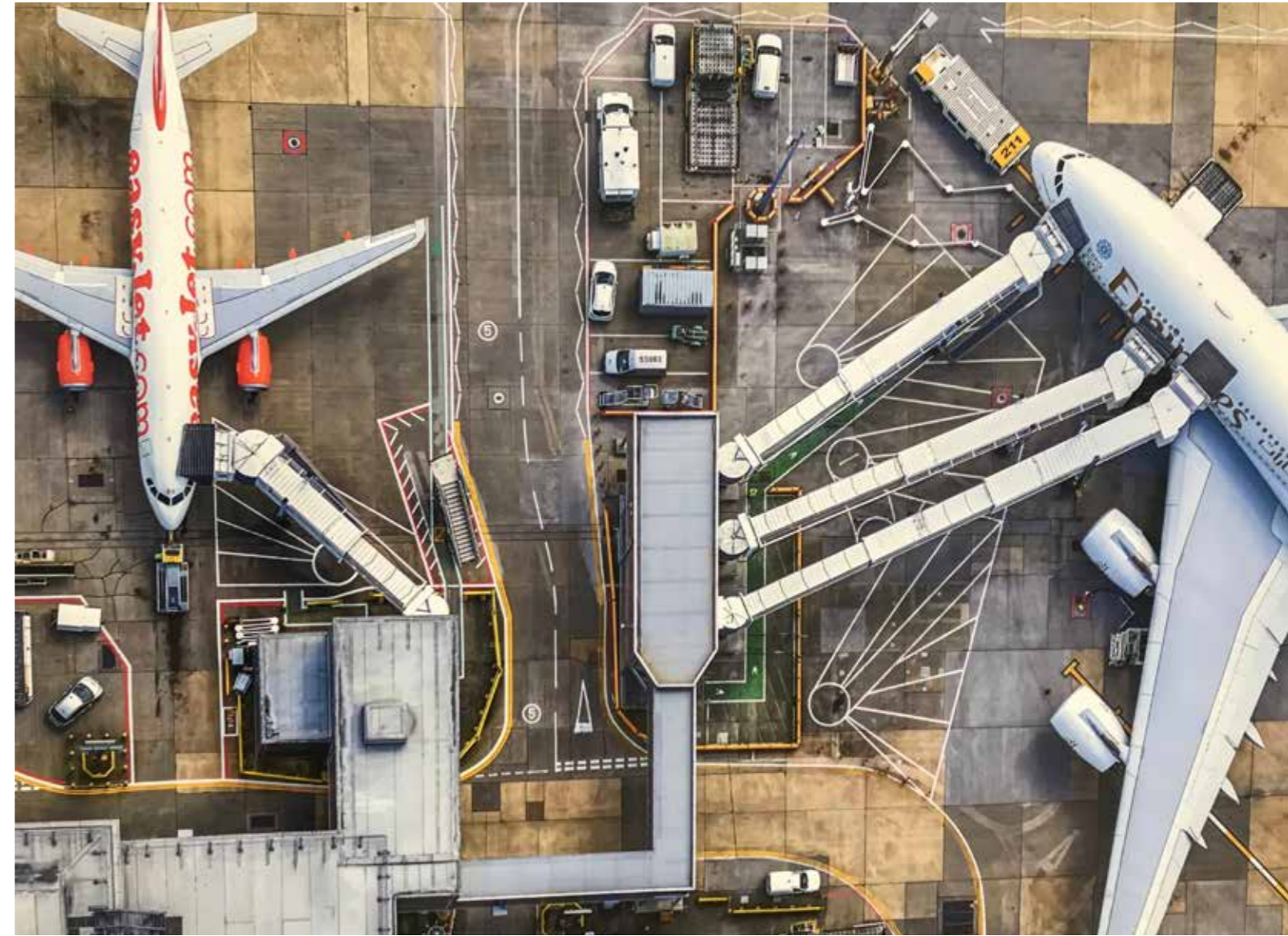

Rebate and incentive applications – we'll do it all for you

Applying for rebates and incentives for your airport project can be a complex and challenging process. Not with us. Thanks to our experience of securing additional financing where it's available, we'll manage and take full responsibility for the entire process.

Financing – from take-off to landing

We can provide you with project financing solutions for your airport lighting projects. Through our approved financing plans we can help you to manage budgetary concerns and hurdles.

Our products and solutions – a winning package

We have a range of 1st class products that can be tailored to your specific needs. These include:

The Titan Series

Designed to offer the maximum level of lighting performance possible, the Titan Series:

- Offers highly asymmetric floodlighting that provides an excellent solution for low glare applications.
- Features our proprietary optics that deliver maximum light levels on designated areas.
- Was designed for maximum heat management.
- Is manufactured to survive the harshest of environments, whilst delivering high performance and long life.
- Has been the go-to product for many of our aviation clients for years.



The Modus Series

A modular design with high levels of overall performance, the Modus Series is:

- A cost-effective solution for high power applications.
- Available in symmetric and asymmetric distributions.
- Suitable for versatile applications and solutions thanks to its modular design.
- Highly reliable and easy to fit because it features integrated drivers.
- Perfect for high colour rendering and comes with full control capability as standard.



The Atlas R Series

(available in the US only)

A military aviation solution, the Atlas R Series:

- Has been UL certified and DLC listed.
- Remote drivers provide a high light to weight ratio.
- Provides plug and play wireless or wired controls.
- Offers a great retrofit solution for 2kW metal halide floodlights.
- Is constructed from stainless steel, critical for use in challenging environments to improve structural integrity and life of the product.



The Atlas Series

(available in the US only)

The Atlas Series is:

- UL certified and DLC listed.
- A proprietary high asymmetry optics system that provides a low glare solution.
- Able to fit any existing mast infrastructure for easy installation and quick retrofit applications because it has versatile brackets and adapters.
- Modular designed to allow for versatile applications and solutions.
- Very easy to fit and highly reliable because of its integrated drivers.



Mobile Tower Series

Our unique solution for mobile lighting, the Mobile Tower Series is:

- Built to deliver instant compliance to ICAO for airport operators.
- A multi-directionally adjustable mobile floodlight tower with four highly efficient, asymmetric 326W LED floodlights.
- Designed specifically for large area lighting with low-glare conditions. It can be used for heavy-duty mission-critical applications, where quality and reliability are paramount.
- Compact and easy to transport and handle.



High Mast Series

Our extensive range of high masts and columns are expertly designed and manufactured to suit your needs, no matter what location or climate you're in.

And the benefits of purchasing the mast and lights at the same time are huge from reducing risk, increasing speed and getting the perfect lighting solution guaranteed.

With mast heights reaching 50 meters and beyond, we've got the right high mast products to meet your precise requirements.

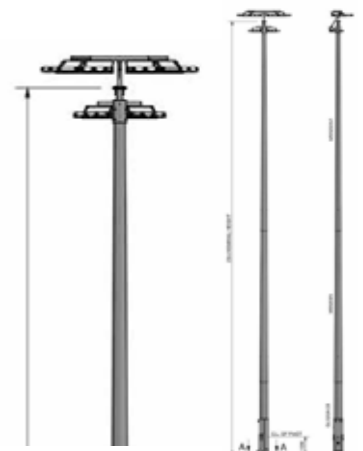

The winning difference: Our proprietary optic lenses

All our products are engineered with proprietary optic lenses designed and manufactured by us – to meet your exacting needs.

From all the environmental and lighting simulations to the data analysis, we own the whole process. This is why our aviation solutions are perfectly designed for the demanding needs of airport aprons.

Thanks to our years of experience, we know what your challenges are. We know industry regulations. We know how our solutions work – thanks to feedback and input from our huge aviation customer base. We know on-site experience and performance in the field are vital too. So, we know how to build the perfect solution for you.

All our optic lenses go through the following development and refinement stages here at Midstream:

- 1 Parameter setting.
- 2 Software evaluation.
- 3 Prototype development.
- 4 Testing.
- 5 Verification.
- 6 Mould creation.
- 7 Production.
- 8 Certification.



Why this so important

Large area lighting, especially airport apron lighting, needs specific technology and know-how to deliver what's needed. The optic system of choice will play a big part in the suitability of a luminaire for this application. Some of the key problems are:

Glare

In the aviation industry, glare is a real problem. Highly concentrating optics, with symmetrical light emissions, can cause glare problems for pilots taxiing to stands. Lamps with this outdated system can show satisfactory GR ratings on a lighting simulation. But that's due to a flaw in the calculation formula. When installed in a real airport environment, these lamps produce a high level of glare coming from multiple angles.

Our refraction optics create very asymmetric light emissions instead. This means glare is kept extremely low and the light produced is much more comfortable.

Uniformity

Highly concentrating optics illuminate areas with a technique known as 'Multi-spot'. This works by creating a pattern of lighting spots across the target area.

Some companies still use this technique due to the challenge they face in developing highly asymmetric refraction lenses. It's a dangerous technique to use for live apron applications, however. This is because if a single lamp fails, a part of the apron will remain dark.

Our refraction optics use a technique known as 'Multilayer' instead. This allows the light to spread over a large surface, resulting in a much higher uniformity. And it ensures a safer environment in case of the failure of a single unit.

Efficiency

Total internal reflection (TIR) lenses can redirect light efficiently – up to 75-85% depending on the angle. But they're difficult to set up in arrays. So, they're usually installed individually and need protecting by a glass screen. This screen can absorb 7-8% of the light they emit.

Cone reflector have the advantage of being one of the cheapest options. They aren't efficient however and have a fast light depreciation. They also need a screen. And they're slowly being abandoned for outdoor luminaires. So, highly concentrating optics like TIR lenses or cone reflectors aren't suitable for large area lighting applications like apron lighting.

The most efficient systems today use refraction lenses. These lenses allow for easy arrangement in an IP rated matrix and don't need a glass screen. The optical efficiency of a lens matrix can vary from 89 to 96% depending on the photometric.

The Titan Series

Overview

Midstream's flagship line was developed as a high power solution to provide the performance and reliability required in mission-critical applications.

A highly efficient LED floodlight designed specifically for high mast and large area lighting, the Titan Series delivers the maximum level of lighting performance possible to a range of environments.

Easily configured and optimised for very specific applications, Titan has been designed by our experienced engineers to survive the harshest of conditions. Extremely reliable, it continues to be the go-to product for many of our aviation and maritime clients year on year.



The go-to product for many of our aviation and maritime clients for years.



Features and benefits of the Titan Series:

- Manufactured with a stainless steel construction that improves structural integrity and life of product, a critical need when used in challenging environments.
- An in-house designed extruded heat sink allows for highly efficient heat dissipation due to its large surface area, when compared with a die-cast product. This keeps lumen degradation to a minimum, extending life and performance.
- Proprietary optic lenses designed and developed in house provide the highest level of asymmetric distribution in the market allowing clients to achieve required light levels with less power, fewer luminaires and all with lower glare.
- Designed as standard with an integrated 2 step surge protection up to 15kA / 20kV which protects the luminaire against power surges meaning more reliability and longer performance.
- Manufactured in the UK to provide the highest level of quality control.
- Comes as standard with DALI controls for plug and play capability.
- A uniquely designed bracket and cable retractor allow for ease of install for both retrofit and new build projects.
- All components are individually IP66 certified.
- Product is certified to ENEC and CB requirements.
- Tried and tested in some of the world biggest and busiest airports and seaports.

The Titan Series

In detail

Products



Photometrics

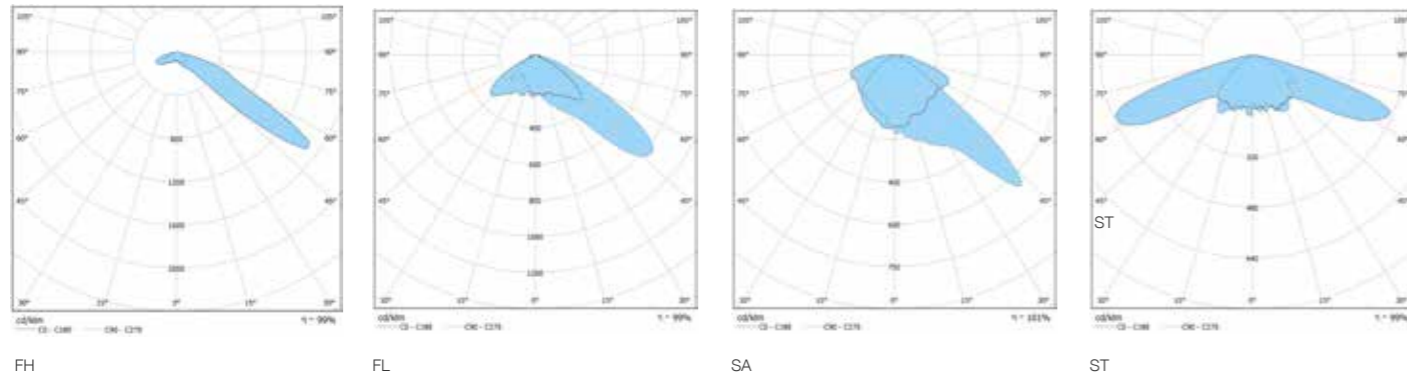

Technical specs

	T160	T220	T320	T420	T560	T720
PERFORMANCE						
Luminaire Output	Up to 20.000lm	Up to 26.000lm	Up to 38.000lm	Up to 54.000lm	Up to 67.000lm	Up to 84.000lm
Power Absorption	161w	220w	321w	450w	565w	700w
Lumen Maintenance [L80 B10]	119.000h	119.000h	119.000h	119.000h	77.000h	150.000h
Lumen Maintenance [L70 B50]	190.000h	190.000h	190.000h	190.000h	122.000h	241.000h
OPTOELECTRONICS						
CRI	70 - 80 - 90					
Colour Temperature	3000K Warm White / 4000K Neutral White / 5000K Pure White / 5700K Cool White					
Secondary Optics	Weather proof, Anti-yellowing PMMA refraction matrix					
No of LEDs	36	48	72	96	96	96
LUMINAIRE BODY						
Chassis and Bracket	Stainless Steel					
Metal Finish	Powder Coating					
Heatsinks	Anodized Extruded Aluminium (Copper Content <0.1%)					
Bracket	Angled Reversible bracket, M20 or 2 x M14 Fixing points					
Weight	12.5 kg	13.5 kg	20 kg	24 kg	25 kg	32 kg
Dimensions (L-W-H)	389 - 340 - 145 mm	445 - 340 - 145 mm	446 - 515 - 145 mm	502 - 515 - 145 mm	502 - 515 - 145 mm	727 - 515 - 155 mm
Protection Level	IP66	IP66	IP66	IP66	IP66	IP66
Impact Resistance	IK09	IK09	IK09	IK09	IK09	IK09
Windage EPA	0.059 m ²	0.065 m ²	0.088 m ²	0.088 m ²	0.088 m ²	0.102 m ²
ELECTRONICS						
Voltage input	90-305 VAC 50-60Hz					
Active Power F.C.	0.95					
Surge Protection	15kA, IEEE C62.41.2 Location Category C High					
Insulation Class	IEC Class I					
Short Circuit Protection	Auto-recovery					
Over Heat Protection	Drops output current					
OPERATING CONDITIONS						
Working Temperature	-40°C / +50°C					
Humidity Range	0% - 94%					

Ordering codes

PRODUCT FAMILY	POWER	OPTIC	CCT	BODY MATERIAL	CONTROL SYSTEM	BODY COLOUR	OPTIONAL
T (Titan)	16	FH	A (5000k)	T (AISI 3CR12 Stainless Steel)	10 (0-10v)	T (Black and White)	00
	22	FL	B (4000k)	M (AISI 316 Stainless Steel)	DA (DALI)	H (High Heat White)	02 (Integrated SPD)
	32	SA	C (3000K)				
	42	ST	D (5700k)				
	56						
	72						

The product family can be tailored to the specifications outlined above. Example ordering code: T-72-FH-A-T-10-T-02

The Atlas R Series

Overview

The Atlas R series is a highly efficient LED floodlight designed specifically for military airfield lighting. It offers a very high lumen packages with limited weight and is built with remote driver capability, a mounted single IP67 electronic control gear for ease of installation and can be used for both retrofit projects and new builds.

The body is made from recyclable, extruded aluminium and powder-coated stainless steel and the optic enclosure has PMMA weather-proof lenses and anti-reflective tempered glass screen.

The Atlas R Series is also a perfect solution for the North American market; complying with the requirements of UL1598.



Perfect retrofit solution for
1.5kW & 2kW metal halide floodlights.



Features and benefits of the Atlas R Series:

- UL certified and DLC listed.
- Manufactured with a stainless steel construction that improves structural integrity and life of product a critical need when used across sporting environments.
- Modular design allowing for versatile and tailored applications and solutions.
- High lumen package delivering up to 144,000 lumens to meet the requirement of world class aviation facilities.
- Integrates with wired or wireless controls including DMX, DALI and 1-10v solutions to provide the ultimate in lighting control for scheduling, zoning or dimming.
- Highly versatile asymmetric or symmetric distribution for use in a wide range of airfield applications.
- A heavy duty, extruded aluminum proprietary designed heat sink allows for highly efficient heat dissipation due to it's large surface area compared to a dye cast design. LED formation is improved providing a low level of lumen degradation extending life and quality in a whole range of environments, from high heat to extreme cold.
- The integrated 10kV surge protection coupled with a panel mounted Type 2 surge suppressor guarantees high protection against power surges and a longer product lifetime.
- Certified IP 67 for highest level of ingress protection.
- Easy 1 vs 1 replacement / retrofit solution for 2kW metal halide floodlights.
- Single remote driver that is outdoor rated for ease of installation and maintenance.
- Manufactured as standard with specialist light shields to control light spill, reduce glare and increase uniformity.
- Ceramic plated metal-core PCB with latest generation Cree (USA) 90 CRI chips for enhanced performance.
- Manufactured in Europe, stocked in the USA for fast deliveries

The Atlas R Series

In detail

Products



Atlas R 800



Atlas R 1200

Photometrics

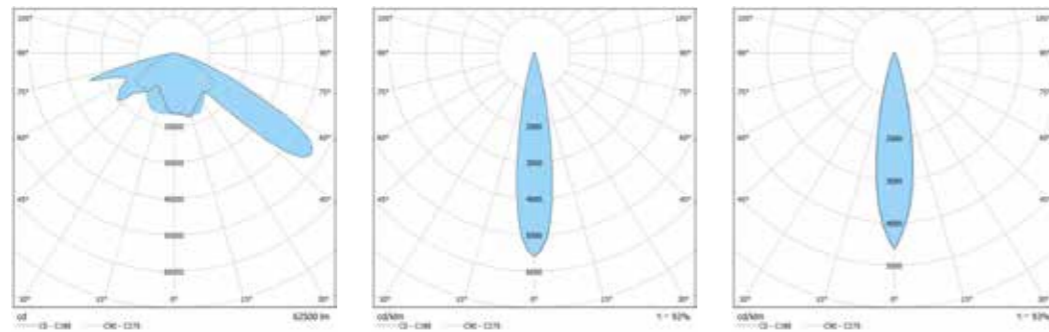

FH (Type IV)

S1 (NEMA 1)

S2 (NEMA 2)

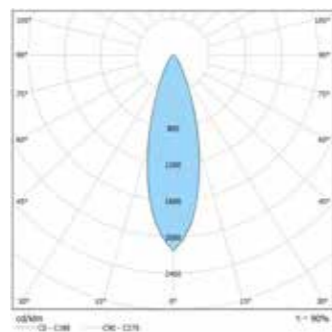

S3 (NEMA 3)

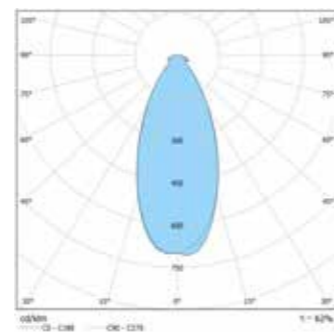

S4 (NEMA 4)

Technical specs

	R800	R1200
PERFORMANCE		
Luminaire Output	Up to 96.000 lm	Up to 144.000 lm
Power Absorption	800w	1200w
Lumen Maintenance [L80 B10]	77.000h	77.000h
Lumen Maintenance [L70 B50]	122.000h	122.000h
OPTOELECTRONICS		
CRI	70 - 80 - 90	
Colour Temperature	3000K Warm White / 4000K Neutral White / 5000K Pure White / 5700K Cool White	
Secondary Optics	Weather proof, Anti-yellowing PMMA refraction matrix	
Protective Screen	4mm Tempered Glass	
No of LEDs	144	216
LUMINAIRE BODY		
Chassis and Bracket	Stainless Steel	
Metal Finish	Powder Coating	
Heatsinks	Anodized Extruded Aluminium (Copper Content <0.1%)	
Bracket	Yoke Bracket (Central Bolt 3/4")	
Weight	46 lb	66 lb
Dimensions (L-W-H)	16.4 - 15.3 - 9.3 in	24.9 - 15.3 - 9.6 in
Protection Level	IP67 - UL1598 Suitable for Wet Locations	IP67 - UL1598 Suitable for Wet Locations
Impact Resistance	IK09	IK09
Windage EPA	1.93 ft ²	2.91 ft ²
DRIVER UNIT		
Dimensions (L-W-H)	15 - 9 - 6 in	
Weight	19 lbs	
Protection Level	IP67 - UL1598 Suitable for Wet Locations	
ELECTRONICS		
Voltage input	277-480 VAC 50-60Hz	
Active Power F.C.	0.97	
Surge Protection	10kV line-earth, 6kV line-line	
Insulation Class	IEC Class I	
Short Circuit Protection	Auto-recovery	
Over Heat Protection	Drops output current	
OPERATING CONDITIONS		
Working Temperature	-40°C / +130°F	
Humidity Range	0% - 94%	

Ordering codes

FAMILY	POWER	OPTIC	CCT	CRI	VOLTAGE INPUT	CONTROL SYSTEM	VISOR
AR (Atlas R)	08	FH (Type IV)	A (5000k)	70	US (200-480 VAC)	10 (0-10v)	Sx (Visor for S Optics)
	12	S1 (NEMA 1)	B (4000k)	80		DA (DALI)	Fx (Visor for F Optics)
		S2 (NEMA 2)	C (3000K)	90		DX (DMX)	00 (No Visor)
		S3 (NEMA 3)	D (5700k)			CW (Synapse Wireless)	
		S4 (NEMA 4)					
		S5 (NEMA 6)					

The product family can be tailored to the specifications outlined above. Example ordering code: AR-08-S1-A-70-US-10-Sx

Find out more: midstreamlighting.com or call +44 (0) 207 584 8310

The Atlas Series

Overview

The Atlas Series is constructed with an extruded aluminium heatsink and stainless-steel housing, providing protection in the harshest conditions including high temperatures and salinity environments.

The series is available with symmetric optics for multi-spot environments (e.g. remote aprons) and highly asymmetric for low-glare environments (e.g. MARS contact stands).



UL certified and DLC listed.



Key features

- UL certified and DLC listed.
- Proprietary optic lenses designed and developed in house provide the highest level of asymmetric distribution in the market allowing clients to achieve required light levels with less power, fewer luminaires / fixtures and all with low glare for pilots and ground staff.
- Designed to have either asymmetric or symmetric distribution allowing for a flexible solution that can be used in a wide range of applications.
- Manufactured with a stainless steel construction that improves structural integrity and life of product a critical need when used in challenging environments.
- Modular design allowing for versatile and tailored applications and solutions.
- High lumen package delivering over 112,000 lumens to meet the highest requirements and standards.
- An in-house designed extruded heat sink allows for highly efficient heat dissipation due to its large surface area, when compared with a die-cast product. This keeps lumen degradation to a minimum, extending life and performance.
- Designed as standard with an integrated 2 step surge protection up to 15kA / 20kV which protects the luminaire against power surges meaning more reliability and longer performance.
- Versatile bracket and adapters to fit any existing mast infrastructure for ease of install and quick retrofit applications
- DALI controls for plug and play capability.
- Certified IP 67 for highest level of ingress protection.
- Easy 1 vs 1 replacement / retrofit solution for HID floodlights.
- Integrated drivers for high reliability and ease of installation.
- Manufactured in Europe, stocked in the USA for fast deliveries

The Atlas Series

In detail

Products



Atlas 300



Atlas 600



Atlas 900

Photometrics

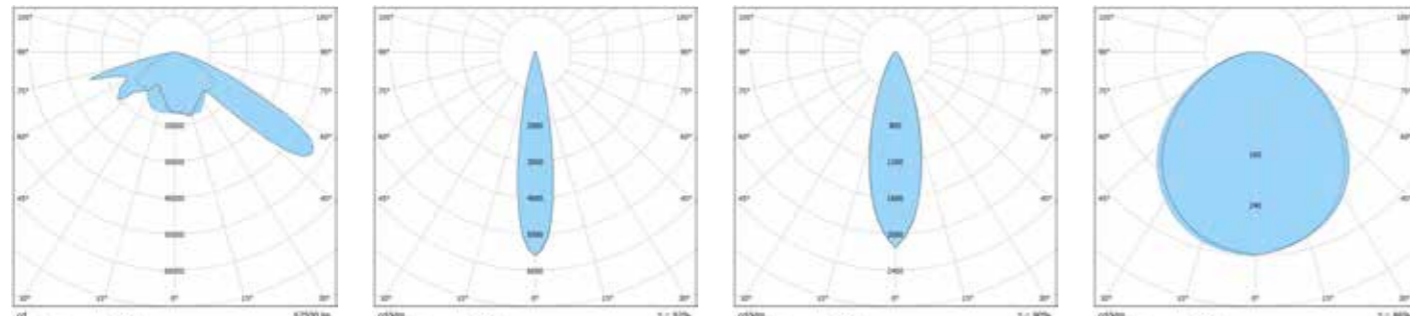

FH S1 S3 S5

Technical specs

	A300	A600	A900
PERFORMANCE			
Luminaire Output	Up to 40.000lm	Up to 80.000lm	Up to 120.000lm
Power Absorption	330w	660w	990w
Lumen Maintenance [L80 B10]	119.000h	119.000h	119.000h
Lumen Maintenance [L70 B50]	190.000h	190.000h	190.000h
OPTOELECTRONICS			
CRI	70 - 80 - 90		
Colour Temperature	3000K Warm White / 4000K Neutral White / 5000K Pure White / 5700K Cool White		
Secondary Optic	Weather proof, Anti-yellowing PMMA refraction matrix		
Protective Screen	4mm Tempered Glass		
No of LEDs	72	144	216
LUMINAIRE BODY			
Chassis and Bracket	Stainless Steel		
Metal Finish	Powder Coating		
Heatsinks	Anodized Extruded Aluminium (Copper Content <0.1%)		
Bracket	Yoke Bracket (Central Bolt 1-3/4) / Tenon Bracket (Clamping 2in Pipe) Mount		
Weight	25.5 lb	61.5lb	93 lb
Dimensions (L-W-H)	7.9 - 14.7 - 9.3 in	16.4 - 15.5 - 11 in	24.9 - 15.5 - 11.4 in
Protection Level	IP67 - UL1598 Suitable for Wet Locations	IP67 - UL1598 Suitable for Wet Locations	IP67 - UL1598 Suitable for Wet Locations
Impact Resistance	IK10	IK10	IK10
Windage EPA	1.02 ft²	2.02 ft²	3.02 ft²
ELECTRONICS			
Voltage input	277-480 VAC 50-60Hz		
Active Power F.C.	0.95		
Surge Protection	20kA, ANSI C136.2-2015 : Extreme Level		
Insulation Class	IEC Class I		
Short Circuit Protection	Auto-recovery		
Over Heat Protection	Drops output current		
OPERATING CONDITIONS			
Working Temperature	-40°F up to +130°F		
Humidity Range	0% - 98%		

Ordering codes

FAMILY	POWER	OPTIC	CCT	CRI	VOLTAGE INPUT	CONTROL SYSTEM	BODY MATERIAL	BRACKET	OPTIONAL	VISOR
A (Atlas)	03	FH (Type IV)	A (5000k)	70	US (277-480 VAC)	10 (0-10v)	T (AISI 3CR12 Stainless Steel)	C (Angled Bracket)	00	Sx (Visor for S Optics)
	06	S1 (NEMA 1)	B (4000k)	80		DA (DALI)	M (AISI 316 Stainless Steel)	T (Straight Bracket)		Fx (Visor for F Optics)
	09	S2 (NEMA 2)	C (3000K)	90		CW (Synapse Wireless)		P (Pole Clamping)		00 (No Visor)
		S3 (NEMA 3)	D (5700k)							
		S4 (NEMA 4)								
		S5 (NEMA 6)								

The product family can be tailored to the specifications outlined above. Example ordering code: A-03-S1-A-70-US-10-T-C-00-00

The Modus Series

Overview

The Midstream Modus Series was developed to provide a solution for environments that need to replace 2 kW Metal Halide projectors.

These environments can range from military airfields to open-air repair bays requiring a high lumen package but long-life and low maintenance products. The modular design of the Modus Series allows for a versatile approach to lighting design, enabling new ways to combine different power products in the same location.

Meanwhile, an extruded aluminium heatsink and stainless steel construction allow this range to be used in harsh environmental conditions.

The single 150w module with either asymmetric or symmetric optic can be used as an adaptable floodlight solution for wide-ranging simple and complex applications, whereas the Modus 900 with 990w LED power and narrow optics can provide an excellent solution for high-lux application.

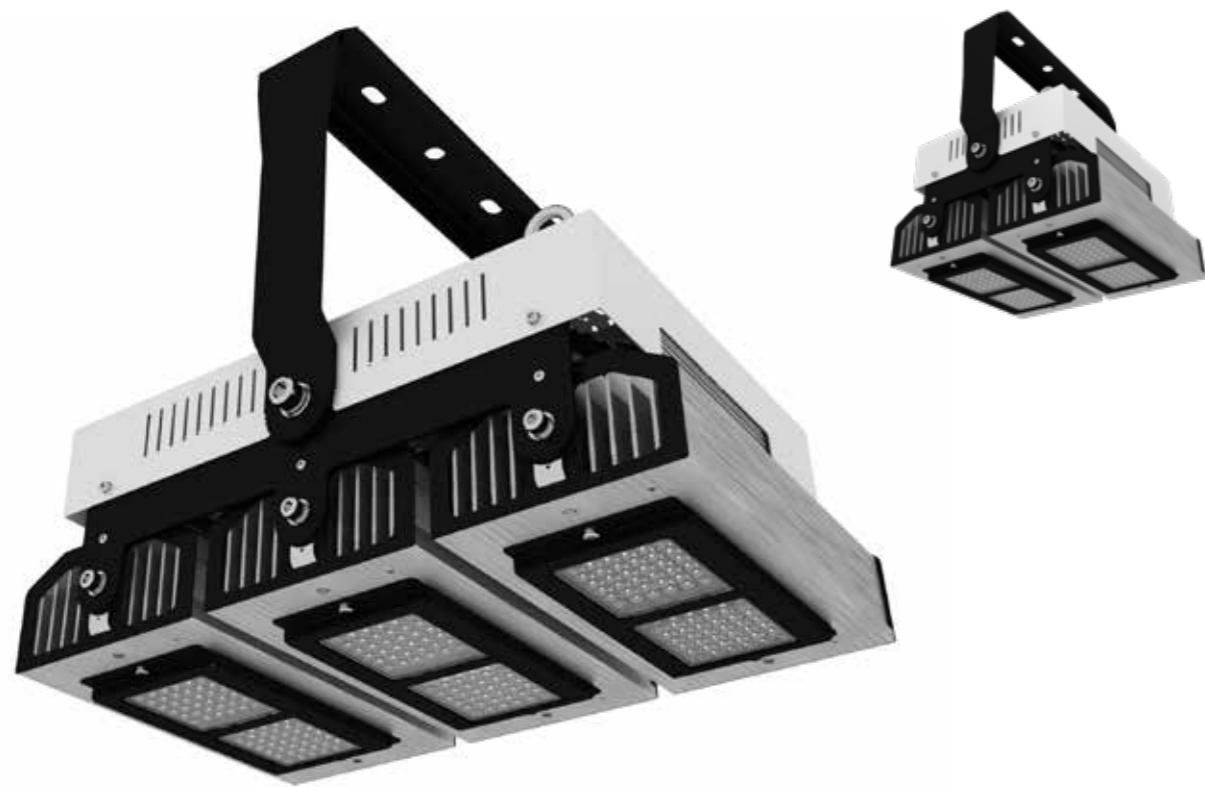

Modular design allowing for versatile and tailored applications and solutions.



Features and benefits of the Modus Series:

- Manufactured with a stainless steel construction that improves structural integrity and life of product a critical need when used in challenging environments.
- Modular design allowing for versatile and tailored applications and solutions.
- High lumen package delivering over 117,000 lumens to meet the highest requirements and standards.
- Designed to have either asymmetric or symmetric distribution allowing for a flexible solution that can be used in a wide range of applications.
- An in-house designed extruded heat sink allows for highly efficient heat dissipation due to its large surface area, when compared with a die-cast product. This keeps lumen degradation to a minimum, extending life and performance.
- Designed as standard with an integrated 2 step surge protection up to 15kA / 20kV which protects the luminaire against power surges meaning more reliability and longer performance.
- DALI controls for plug and play capability.

The Modus Series

In detail

Products



Modus 150



Modus 300

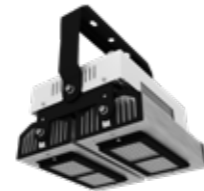

Modus 600



Modus 900

Photometrics

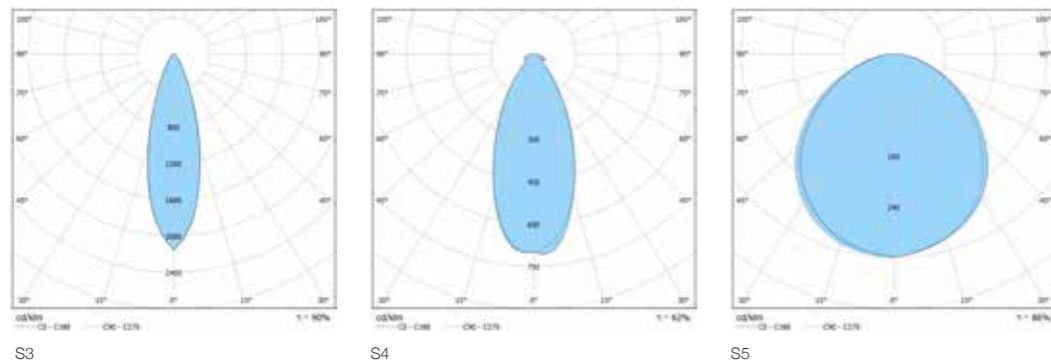
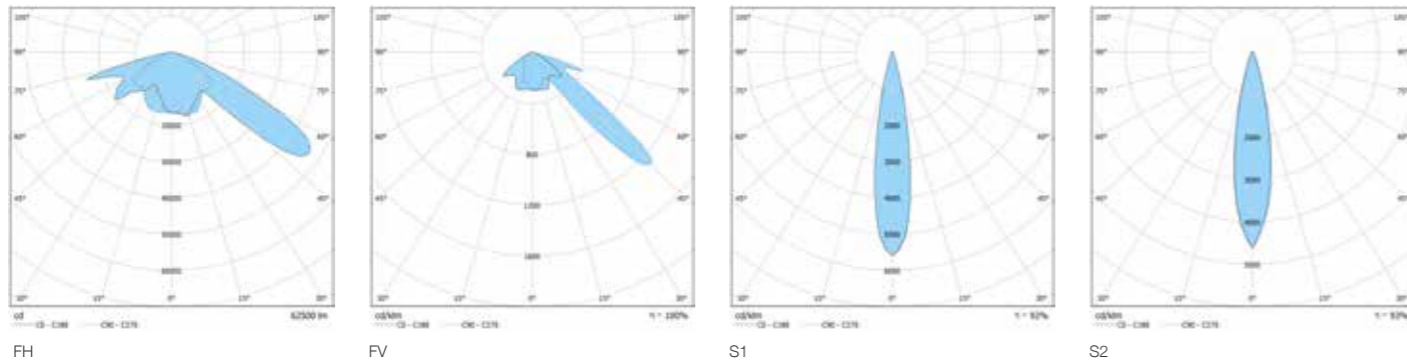

Technical specs

	M150	M300	M600	M900
PERFORMANCE				
Luminaire Output	Up to 16.000lm	Up to 39.000lm	Up to 78.000lm	Up to 117.000lm
Power Absorption	145w	330w	660w	990w
Lumen Maintenance [L80 B10]	119.000h	119.000h	119.000h	119.000h
Lumen Maintenance [L70 B50]	190.000h	190.000h	190.000h	190.000h
OPTOELECTRONICS				
CRI	70 - 80 - 90			
Colour Temperature	3000K Warm White / 4000K Neutral White / 5000K Pure White / 5700K Cool White			
Secondary Optics	Weather proof, Anti-yellowing PMMA refraction matrix			
No of LEDs	32	72	144	216
LUMINAIRE BODY				
Chassis and Bracket	Stainless Steel			
Metal Finish	Powder Coating			
Heatsinks	Anodized Extruded Aluminium (Copper Content <0.1%)			
Bracket	Angled Reversible bracket, M20 or 2 x M14 Fixing points			
Weight	6.5 kg	10.5 kg	23 kg	36 kg
Dimensions (L-W-H)	201 - 255 - 170 mm	201 - 373 - 224 mm	416 - 393 - 269 mm	631 - 393 - 278 mm
Protection Level	IP67	IP67	IP67	IP67
Impact Resistance	IK09	IK09	IK09	IK09
Windage EPA	0.05 m ²	0.094 m ²	0.187 m ²	0.280 m ²
ELECTRONICS				
Voltage input	90-305 VAC 50-60Hz			
Active Power F.C.	0.95			
Surge Protection	15kA, IEEE C62.41.2 Location Category C High			
Insulation Class	IEC Class I			
Short Circuit Protection	Auto-recovery			
Over Heat Protection	Drops output current			
OPERATING CONDITIONS				
Working Temperature	-40°C / +55°C			
Humidity Range	0% - 94%			

Ordering codes

FAMILY	POWER	OPTIC	CCT	CRI	VOLTAGE INPUT	CONTROL SYSTEM	BODY MATERIAL	BRACKET	OPTIONAL	VISOR
M (Modus)	01	FH	A (5000k)	70	EU (100-277 VAC)	10 (0-10v)	T (AISI 3CR12 Stainless Steel)	C (Angled Bracket)	00	Sx (Visor for S Optics)
	03	FV	B (4000k)	80		DA (DALI)	M (AISI 316 Stainless Steel)	T (Straight Bracket)		Fx (Visor for F Optics)
	06	S1	C (3000K)	90				P (Pole Clamping)		00 (No Visor)
	09	S2	D (5700k)							
		S3								
		S4								
		S5								

The product family can be tailored to the specifications outlined above. Example ordering code: M-01-S3-A-70-EU-DA-T-C-02-Sx

The Mobile Tower

Overview

A resilient solution for our global aviation clients, the Mobile Tower features an adjustable 9-metre vertical, hydraulic mast delivering an impressive average 20 Lux coverage over 3600m² via four highly efficient, asymmetric 326W LED Titan floodlights.

Midstream's Mobile Tower continues to be a steadfast solution for many global clients, with its primary use being to fulfil the precise requirements of apron applications allowing for the commissioning of Code F and Code E aircraft stands in full compliance with ICAO and EASA requirements.

The unique features of the Midstream Mobile Tower are based around our sophisticated proprietary optics, and deliver a highly asymmetric beam to reach the minimum lux requirements, even at the back of the aircraft stand, without tilting the luminaires.

By using our specially developed optics, we can provide the ICAO compliance without the high levels of glare typically found with traditional generator lights. Beneficially, the Midstream Mobile Tower also comes complete with official ICAO compliant lighting design. This can be submitted as a part of the certification documentation.



- A multi-directionally adjustable, mobile floodlight tower with 4 highly efficient, asymmetric 326W LED floodlights, designed specifically for large area lighting with low glare conditions.
- 7-section hydraulic vertical tower, up to 9m height, 340° rotatable. Galvanized metalwork with 80 µm powder coating. Guided main coiled cable to avoid damage during tower operation. Certified wind stability up to 110 km/h.

Products

The Midstream Mobile Tower is available in a number of other versions and configurations and can be customised according to the end-user's requirements.

- **Plug-in power:** M-Mast unit is operated through a 230V power line for locations where electricity is readily available but infrastructure works or liquid fuels are inappropriate or prohibited. Zero noise emissions. Low maintenance.
- **Hybrid Power:** M-Hybrid unit is operated with a series of rechargeable batteries together with a diesel engine to reduce fuel usage, CO² emissions and noise levels. Also available as M-Hybrid Mobile version.
- **Military Power:** Military application may require some bespoke features and colours. Our products are customisable and can be tailored to individual use. Robust design to survive harsh conditions.



Technical specs

DIMENSIONS MIN.	2320 x 1380 x 2420 mm
DIMENSIONS MAX.	2320 x 1550 x 9000 mm
TOTAL WEIGHT WITHOUT FUEL	960 kg
ROTATION	340°
ILLUMINATED AREA	4800 m ²
FLOODLIGHTS	4 x 326W LED
ENGINE MODEL	Kubota Z482
FUEL	Diesel
RPM	1500
CONSUMPTION (L/H)	0.55
TANK CAPACITY (L)	110
RUNTIME BEFORE REFUELLING (H)	200
NOISE LEVEL AT 7M (DB)	65
ALTERNATOR MODEL	Synchronous
FREQUENCY (HZ)	50
INSULATION CLASS	H
DEGREE OF PROTECTION	IP67
SINGLE PHASE VOLTAGE	3.5 kVA - 48V
AUXILIARY OUTLETS	1kVA

ICAO Compliance

The Midstream Mobile Tower allows airside operators to commission an aircraft stand in full compliance with ICAO requirements (see images). Proprietary high-asymmetry optics throw the light to the back of stand without tilting and emitting light into the sky. Low tilt operation significantly reduces glare to pilots and ground staff. Remote control, timer or photo-cell operation allows for autonomy even on remote aprons. Two masts used in tandem can commission up to a Code F stand to Annex 14 requirements.

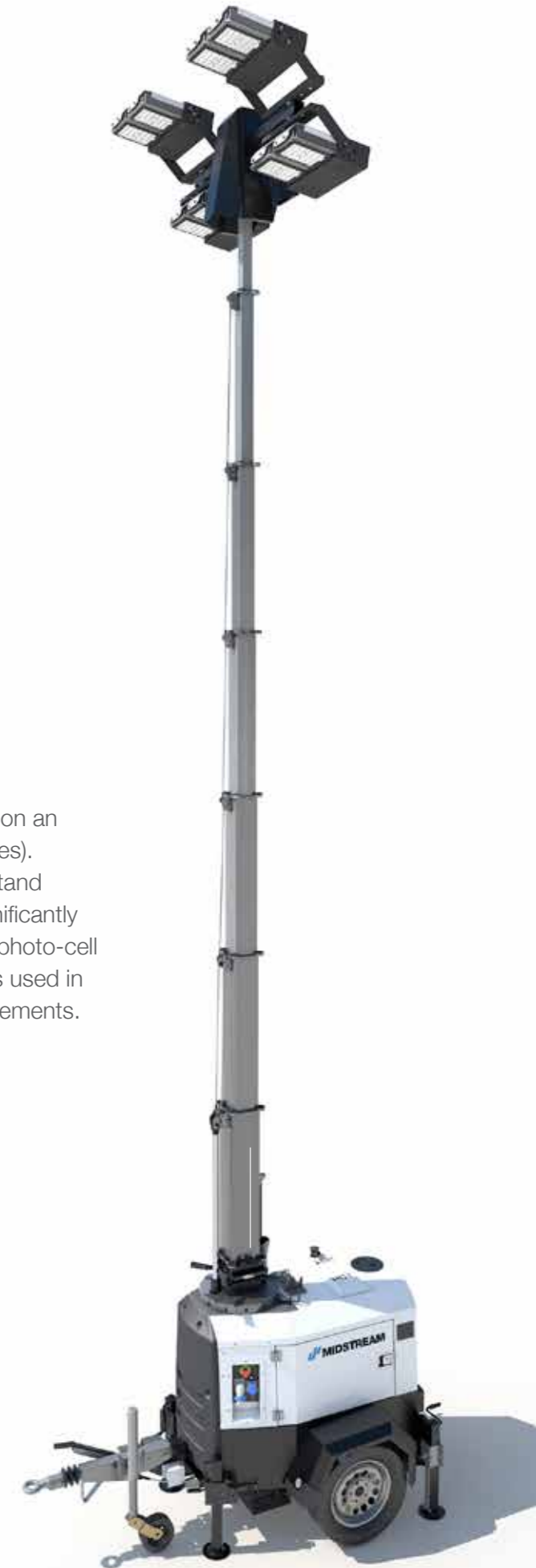
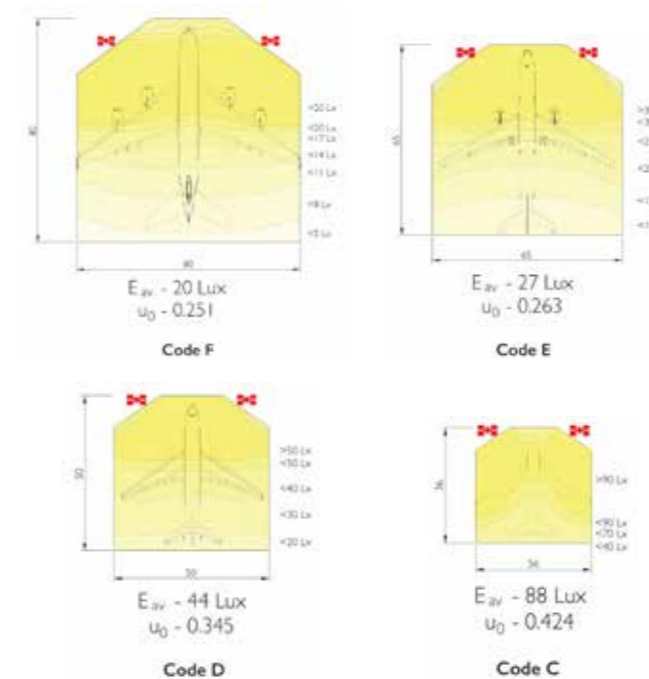

Applications

- Remote aprons
- VIP Aprons
- Runway resurfacing
- Airport road network
- Parking areas
- Special events
- Temporary Aprons
- Emergency response
- Law enforcement use
- Construction projects
- Fuel farms
- Military applications
- Security checkpoints
- OLS Restricted aprons
- Supplementary illumination

Key Features

- Automatic Mast Operating Safety System
- Light sensor for automatic start
- Longitudinal and transversal forklift pockets
- Optional socket to power lights from mains supply
- IP67 certified
- European manufacturing
- Up to 200 hours running time
- Tower 340° rotatable
- Certified wind stability up to 110 km/h
- Stabilizers adjustable in height
- Central lifting hook
- Remote operation available
- Complies with ICAO Annex 14 requirements
- Asymmetric floodlights for low glare operation

High Mast Series

Minimum maintenance guaranteed Base hinged masts

If you're looking to keep maintenance to an absolute minimum, our base hinged masts help you achieve exactly that – thanks to their sturdy design and durable engineering. They're available with hinges, either at the bottom or middle. And, as long as there's sufficient ground clearance, they allow easy ground access to the lighting whenever you need.

Features and benefits of base hinged masts:

- They're super-simple to install and set up and are virtually maintenance-free.
- Compared to some other mast solutions, fitting them takes far less time – up to three times less in some cases.
- Mast heights available up to 50m.
- If any maintenance is needed it can be done safely, quickly, and easily on the ground – reducing a lot of health and safety requirements.
- The platform free design gives them a sleek, modern look.
- Also, because no platform is needed wind load pressures and the foundations needed can be kept to a minimum.
- Their operating systems and protective equipment can be housed in the mast or its cabinet.
- They're incredibly stable and can also be quickly lowered to cope with high winds and stormy weather.

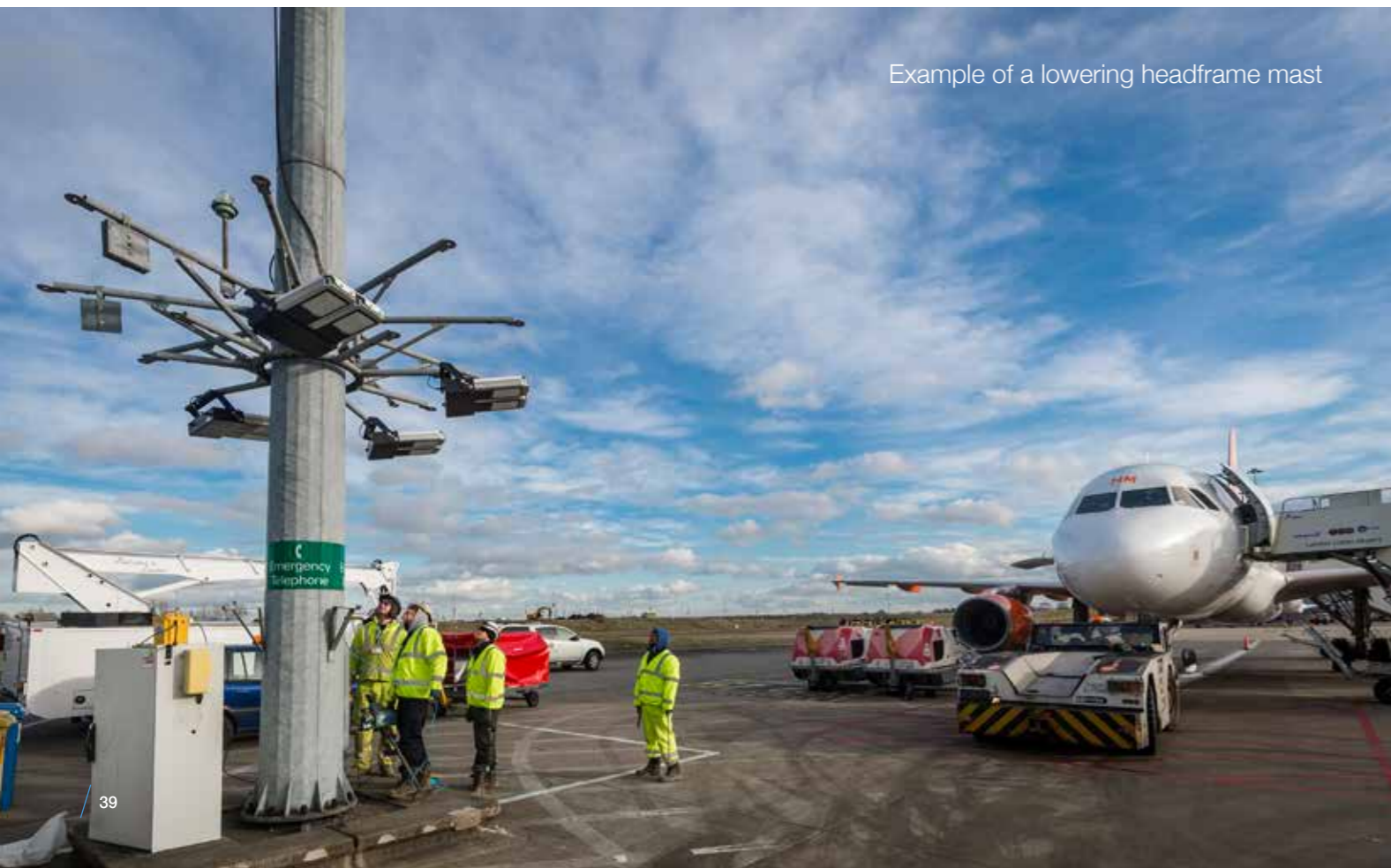

Example of a lowering headframe mast

Tried, tested and low maintenance Fixed masts

Where large area lighting is needed, our fixed masts are perfect for housing the significant number of LED lights required. As they're fixed, they offer maximum stability. And if any maintenance is needed standard high-level equipment is available to make access to the lights trouble-free. They can be supplied with a ladder and safety cage too, so if you will need regular access, this is a winning choice.

Features and benefits of fixed masts:

- With thousands of fixed masts already installed worldwide, the process of fitting them has been tried, tested, and is trouble-free.
- As with base hinged masts, wind load pressures and the foundations needed can be kept to a minimum.
- Because they have no moving parts, the masts hardly need any maintenance at all.
- Maintaining the masts luminaires themselves is made simple thanks to easy to operate high access equipment.

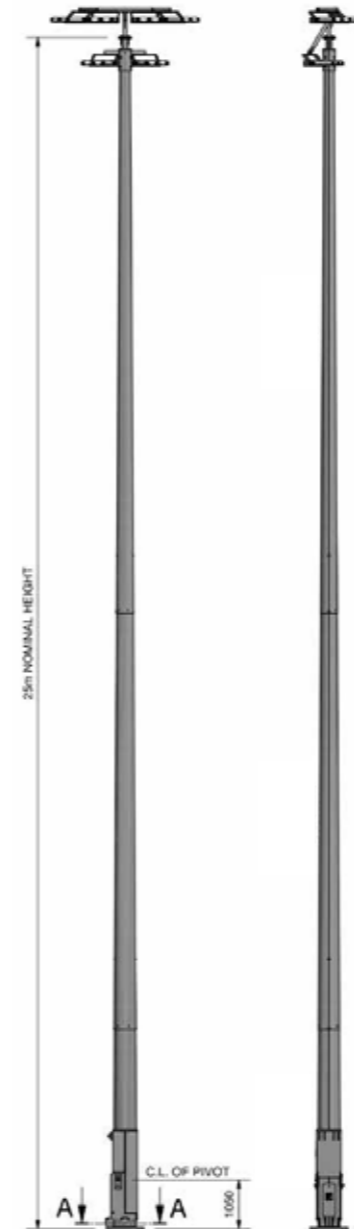

For when space counts Lowering headframe masts

If space is at a premium, lowering headframe masts mean the headframe can be easily winch-lowered to the ground if any maintenance is needed.

Features and benefits of lowering headframe masts:

- As there's no need for ground clearance, lowering headframe masts are perfect for where space is limited.
- Maintenance is made easy as the headframe can be simply lowered to the ground. So, there's no need to use any equipment to access the lighting.
- To provide additional strength and more security headframe latching is available if required.
- Unlike multi-cable solutions, lowering headframe masts operate with a single multi-core electrical cable management system for all the floodlights.
- This can be with a winch and cable system or an external guide rail system
- All masts can be in-built with individual lowering motors, for fast action.

Specific solutions designed for you Bespoke masts

In some rare cases, an 'off-the-shelf' product can't rise to meet all the precise needs for a project. That's where the expertise and experience of our Design and Engineering teams comes into play. They can work with you to develop a bespoke mast solution that meets your project needs – exactly.

‘The change was likened to coming out of the Victorian age into the modern world.’

LES MITCHELL, AIRSIDE PROJECT DELIVERY LEAD – LGW



AVIATION PROJECT CASE STUDY

London Gatwick Airport, UK (LGW)

Opened as an aerodrome in the late 1920s, LGW started taking commercial flights in 1933. Now, with over 46,000,000 passengers travelling through it every year, it's the second busiest single-runway in the world.

The challenge

There were two main reasons LGW decided to move from HPS to LED lighting:

- A number of their stands weren't meeting EASA requirements.
- They wanted to reduce their energy use by 20% compared to 1990s levels.

So, they came straight to Midstream Lighting to help them meet these challenges.

Sector: Aviation

Customer: LGW

Number of passengers: 43,000,000

Runways: 1

Stands: 119

Aircraft movements: 275,000

Project date: 2017

LED floodlights installed: 564

Type: Titan Series

Increase in light levels: 50%

Lux average values: 30 Lux

Energy savings:

- 256kW vs 430kW
- 40%
- Payback £50,000 pa.

Our solution

After a complete review of LGW's current lighting facilities, we put our Lighting Design Team on the case. The solution they came up with was to upgrade all sodium apron lighting to our flagship Titan Series – with over 560 LED floodlights being installed. This made LGW the first major European airport to have a fully LED-lit and EASA-compliant apron.

More importantly, the airport is now safer for staff and passengers, it's more secure, and with less downtime runs more smoothly.

Before and after technical comparison

	SODIUM	LED
Number of projectors	861	564
Nominal power for single appliance	400 kW	455 kW
Absorbed power (measured data)	500	455
Total power absorbed	430.5	256.62
Energy consumption per year	1,885,590 kWh	1,123,996 kWh
Colour Temperature	2,300K	5,700K
Colour Rendering Index	30	70
Average Light Level	20 Lux	30 Lux
Uniformity	0.2	0.3
Energy Saving	/	40%



‘From a technical perspective we are very happy with the support, service and solution provided by Midstream Lighting. The lighting solution has been a real upgrade for each of the airports Fraport–Greece has completed so far and we are excited see the final upgrades done later this year.’
BILL FULLERTON, CHIEF TECHNICAL OFFICER, FRAPORT GREECE

AVIATION PROJECT CASE STUDY

14 Greek Regional Airports

A leading player in the global airport business, more than 176 million passengers use airports where Fraport owns more than a 50% stake. This includes 14 regional airports in Greece, from the Aktion National Airport to Zakynthos, that Fraport manages. As part of a major project to modernise these airports, Fraport asked for our help.

The challenge

All the Greek airports Fraport manages had outdated lighting systems that weren't compliant with the European Aviation Safety Agency (EASA) regulations. And this needed fixing – fast. This meant new mast positions and heights for all 14 airports needed to be planned, taking into account:

- OLS (Obstacle Limitation Surfaces) restrictions.
- Wingtip clearance for various types of aircraft.
- Keeping civil works needed for new cabling as low as possible.
- New apron configuration for increased aircraft movements.

Customer: Fraport AG

Number of airports: 14

Installation height: 12m to 40m

Project date: 2018

LED floodlights installed: 1,000

Type: Titan Series

Lux average values: 30 Lux

Energy Savings: 55% on average

Our solution

Working with Intrakat, Fraport's main contractor, we designed and delivered a completely new, compliant lighting system for each airport. Using our Titan 560 lighting, which was the perfect match between power and weight, meant:

- Increased high colour rendering that led to improved safety.
- Shadow areas between planes were reduced through the new tower positioning. This guaranteed a better working environment for ground staff.
- Energy use could be cut – by 55% on average.
- Lower maintenance costs thanks to the Titan 560's stainless steel construction – especially important where an airport is near the sea which can cause issues with salinity.

The 14 airports

Aktion National Airport, Cephalonia Airport, Chania Airport, Corfu Airport, Kavala Airport, Kos Island Airport, Mykonos Airport, Mytilene Airport, Rhodes Airport, Samos Airport, Santorini Airport, Skiathos Airport, Thessaloniki Airport, Zakynthos Airport.



AVIATION PROJECT CASE STUDY

Queen Alia International Airport, Amman, Jordan (QAIA)

Initially established in 1983, QAIA is Jordan's main and largest airport. After an international tender, Airport International Group was invited to operate, rehabilitate and manage QAIA.

And in 2013 a new airport was opened, with its second phase being completed in 2016.

The challenge

QAIA needed to:

- Make sure its lighting complied with ICAO – International Civil Aviation Organisation – rules.
- Cut its high energy use.
- Replace its metal halide system which suffered from major light depreciation and required a lot of maintenance to keep the aprons compliant with regulations.

As the airports existing towers had to be used, a retrofit approach was needed. And the number of floodlights used couldn't exceed those already in place because existing connection points had to be used.

Customer: AMM

Number of passengers: 12,000,000

Runways: 2

Average aircraft movements: 74,000

Project date: 2019

LED floodlights installed: 193

Type: Titan Series

Lux average values: 20 Lux

Energy Savings: 61%

Our solution

We designed and supplied a new floodlighting solution, using our Titan 560 floodlights, that complied with ICAO regulations. These floodlights were the perfect match for the weight and power needed too. They also meant that the airports' aprons were always fully compliant with regulations.

Once in place, the new system tripled light levels, reduced maintenance costs considerably compared to the old halide system, and cut energy use by 66%.

Product used for Queen Alia International Airport

- A highly asymmetric floodlight providing an excellent solution for low glare applications.
- Our propriety optics deliver maximum light levels on designated areas.
- It's designed for maximum heat management.
- And it's manufactured to survive the harshest of environments, whilst delivering high performance and long life.
- Which in total makes it the go-to product for many of our aviation and maritime clients for years.



AVIATION PROJECT CASE STUDY

Rome Fiumicino Airport, Italy (FCO)

FCO, also known as Rome Leonardo da Vinci Airport, is Italy's biggest airport. It serves as the main hub for the country's largest airline – Alitalia. It's also the main hub for Vueling, a low-cost Spanish carrier. FCO is the eight-busiest airport in Europe and the world's 47th busiest.

The challenge

FCO needed to:

- Make sure its lighting complied with new EASA – the European Union Aviation Safety Agency – regulations.
- Guarantee zero light spill to comply with Lazio regional law.
- Cut energy use whilst in full compliance with ICAO Annex 14 regulations. And reduce their lighting maintenance costs at the same time.

As we were already the preferred supplier of LED apron lighting for FCO since 2017, they came to us to make these things happen.

Customer: FCO

Number of passengers: 425,119,99

Runways: 4 – including a temporary

Stands: 125

Aircraft movements: 307,736

Project date: Ongoing

LED floodlights installed: 600+

Type: Titan Series

Lux average values: 30 Lux

Energy savings:

- 317W vs 812kW
- 61%

Our solution

This large project – 97 new high masts needed building with heights ranging from 10m to 40m– has been ongoing for the last few years. It's involved a 25% retrofit and the rest new-build, with the new masts being installed next to the current ones. The old masts are now being removed, so the sodium lights can be turned off and the LED lights switched on.

By using the whole range of our Titan Series – from 165W to 705W – the new floodlighting complies with EASA regulations and Lazio regional law. Plus, to help keep costs to a minimum, they've been supplied with DALI, Digital Address Lighting Interface, protocol. This means they can connect with the existing control system in a simple plug and play way. Also, as with any of our LED lighting, the maintenance costs will be a fraction of what it costs to maintain a High-Pressure Sodium system.

	SODIUM	LED
Number of projectors	850+	600+
Nominal power for single appliance	400 kW / 1000W	457W / 455W / 705w
Total power absorbed	812 kW	317kW
Energy consumption per year	3491600 kWh	72,670 kWh
Colour Temperature	2000k	5,700K
Colour Rendering Index	25	70
Average Light Level	20lx	36 Lux
Uniformity	0.25	0.53
Energy savings		61%



AVIATION PROJECT CASE STUDY

King Shaka Airport, South Africa (DUR)

Named after a 19th-century Zulu nation leader, DUR started construction in 1973. But, the first flight from the airport didn't take place until 2010, this was due to an economic slowdown in the 1980s and a delay in the project's Environmental Impact Assessment approval. Since 2013 DUR has consistently won the best airport in the world awards for airports handling under five million, or five to ten, million passengers a year. DUR is now the third busiest airport in South Africa.

The challenge

DUR needed to:

- Make sure its lighting complied with ICAO – the International Civil Aviation Organisations – regulations.
- Replace its current metal halide fixtures. These already had a very high lumen output. However, the halide system suffered from major light depreciation, the bulbs were losing lumen output quickly and had to be replaced constantly to keep the airport's aprons compliant.
- It also wanted to have full control of its lighting without the need to pull any existing wiring.
- Complete the whole project as a retrofit using existing towers.

When asked why DUR chose us the reply was simple – 'Your superior quality'.

Our solution

As we had to use the existing lighting towers, which had only a few mounting points each, a complete retrofit was needed. We also needed to keep the number of floodlights as low as possible. We used our Titan 720 and 420 flood lights because it was the only lightweight floodlight in the market that could match the light output of a 2kW metal halide fixture. The Titan's advanced optics also meant we were able to give uniform lighting with just two floodlights per mast.

We also worked with our partner ZetaQlab, to install a full wireless control system – one of the first to be used in an airport environment.

The results speak for themselves – light levels have almost trebled, maintenance costs have dramatically fallen, and energy savings are a massive 77%.

Customer: DUR
Number of passengers: 5,990,000
Runways: 1
Stands: 119
Aircraft movements: 51,131
Project date: 2018

LED floodlights installed: 78
Installation Height: 25m and 35m
Type: Titan Series
Lux average values: 25
Lux Energy savings: 77%

The company we keep

Our global clients

As the saying goes, 'You can trust a person based on the friends they keep'. That's very true, and it applies to companies too. Here are just some of the companies that have and continue to trust us.



Midstream is the first choice for customers who cannot compromise on quality and reliability.

For more information:

European HQ

Midstream Ltd. Wessex House, 1 Chesham Street,
London SW1X 8ND, United Kingdom

Telephone +44 207 584 8310
Email info@midstreamlighting.com

US HQ

Midstream Lighting Ltd.
66 West Flagler Street,
Miami, FL 33130, USA

Telephone: (888) 549-6775
Email info@midstreamlighting.com

midstreamlighting.com

